

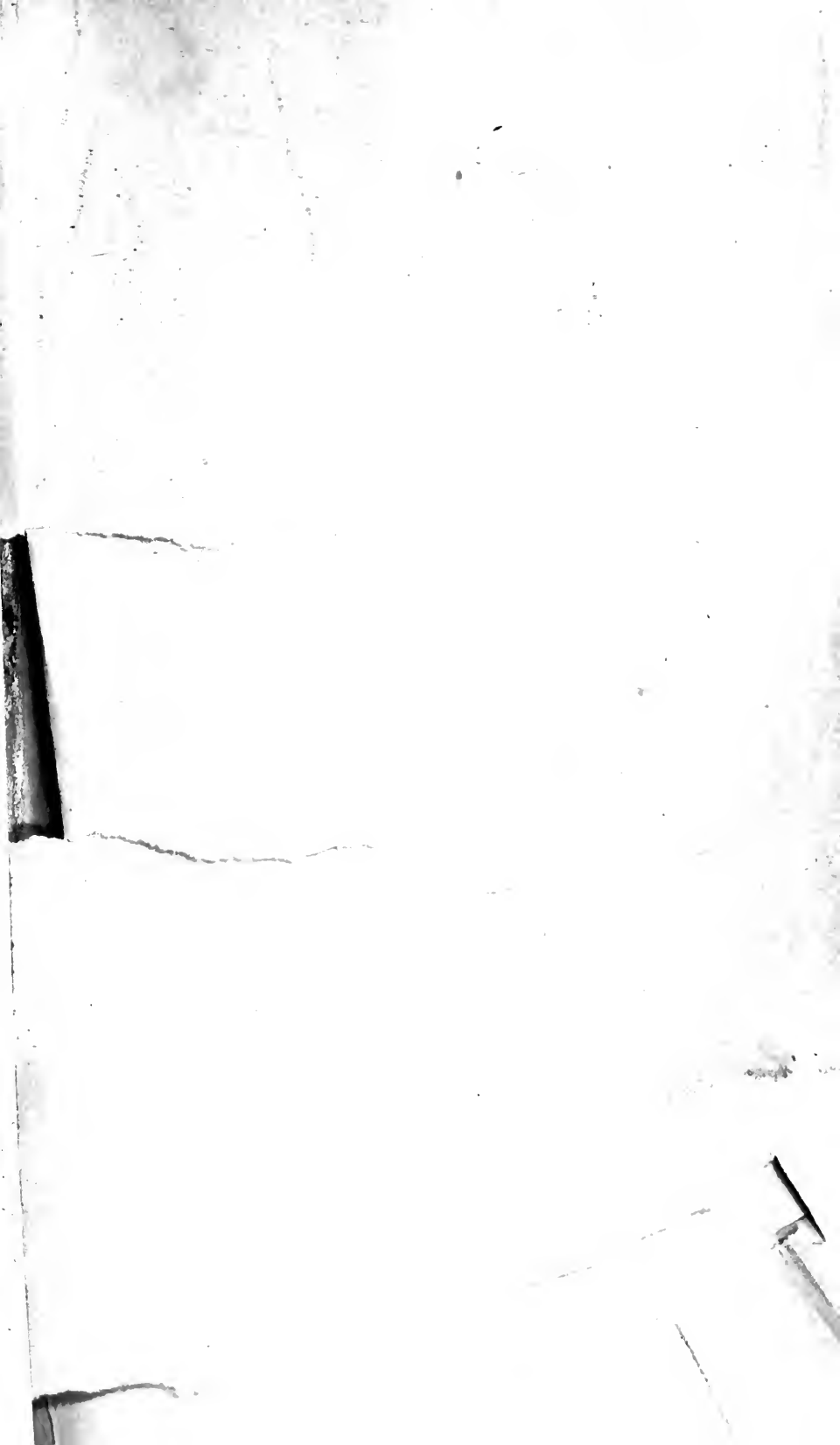

3 1761 04023 1078

MARCY'S  
RECEPTION  
MANUAL

Book







Digitized by the Internet Archive  
in 2007 with funding from  
Microsoft Corporation

THE  
SCIOPTICON MANUAL,

EXPLAINING

LANTERN PROJECTIONS IN GENERAL,

AND THE

SCIOPTICON APPARATUS IN PARTICULAR.

INCLUDING

MAGIC LANTERN ATTACHMENTS,

EXPERIMENTS, NOVELTIES, COLORED AND PHOTO-TRANSPARENCIES,  
MECHANICAL MOVEMENTS, ETC.

BY

L. J. MARCY, OPTICIAN,  
No. 1340 CHESTNUT STREET, PHILADELPHIA.

---

SIXTH EDITION.

---

PHILADELPHIA:

JAMES A. MOORE, PRINTER, 1222 AND 1224 SANSOM STREET.

1877.



---

Entered, according to Act of Congress, in the year 1877,

By L. J. MARCY,

In the Office of the Librarian of Congress, at Washington, D. C.

---

TR  
730  
K



## P R E F A C E.

---

VISIBLE illustrations are so highly esteemed among educationalists of the present day, that the announcement that *a greatly improved form of Magic Lantern has made its appearance* is very favorably received.

Between a desire for such an instrument, and the lack of definite information concerning it, many very naturally manifest both their interest and their caution by searching letters of inquiry. The inventor has endeavored, in hasty epistles, to state all the possibilities and impossibilities of the Sciopticon, and of lights, lenses, lantern slides, and tanks; but he finds it increasingly difficult to give each correspondent, individually, a full philosophical exposition. For such, therefore as desire a more detailed account than can be given in a hasty letter, or than is contained in the circular, which it is always a pleasure to forward on application, a Sciopticon Manual has been prepared, to serve as a guide-book to

the various interesting portions of the Magic Lantern field in general, as well as to the Sciopticon in particular.

It treats of the Optical Image—without a lens, with a lens, in the camera obscura, in the eye, in the photographic camera, and on the screen; of the peculiarities of lenses, and the corrections required by lenses; of the peculiarities of the Sciopticon, and its construction and management; of dissolving views, phantasmagoria, and the ghost; of lantern slides in all their variety; of photographing slides by the wet-plate process, by the dry-plate process, by Marcy's Photographic Printing Apparatus, by the Sciopticon, and other processes; of how to paint slides, and of how to perform chemical experiments, &c.; to which is appended a catalogue, arranged to assist purchasers in making satisfactory selections.

Thus this Manual may take the place of private correspondence to a considerable extent, allowing in letters more space for business, and for an interchange of new ideas, with a view of making the Manual in subsequent editions more interesting, and the Sciopticon more useful.

It was at first my intention to give space to the subject of chemical lights, but reflecting that in this direction there is no lack of printed matter, and that the interest felt in the Sciopticon is owing mainly to its giving

good results with little trouble, I have concluded to *omit the gas*, which would increase the bulk of the Manual, without a corresponding addition to its usefulness.

---

## P R E F A C E T O F I F T H E D I T I O N .

THE lime light, in an improved form, having been introduced into the Sciopticon, it has become expedient to append to the Sciopticon Manual, a description of the apparatus and directions for its use.

The demand for Lantern projections is steadily on the increase. A fine photograph (and what can be finer?) projected upon a large screen, before a thousand spectators, gives, it is safe to say, ten thousand times the satisfaction that one alone with his stereoscope receives from it. The appreciation is cumulative. "The more the merrier," is the philosophy of it.

The Sciopticon with its oil lamp, rather than with its lime light, continues to be the choice of the many, because its use is convenient and inexpensive. There are purposes and occasions however for which the lime light is a necessity. The *gas* therefore has now received its full share of attention. Much of the added matter is intended to assist those who have a Sciopticon, to provide themselves with interesting objects for exhibition, without resort to a large assortment of expensive slides.

## P R E F A C E T O S I X T H E D I T I O N .

MARCY'S SCIOPTICON is now no new thing. It has taken its place as a standard projecting Lantern, and is accepted as a great advance in this direction. As it becomes better known, and less in need of explanations, the Sciopticon Manual might be contracted rather than enlarged, only that something more may be said to advantage of its new attachments and new uses. It will be seen that the Triple Jet, the Gas Sciopticon, the Gas Microscope, etc., have been improved since the illustrations prepared for the Fifth Edition were drawn.

The Automatic Cut-off is yet new to many, who will stand in need of a fuller explanation in print.

The description and illustrations of the Franklin Institute Gas Holders will interest Managers of Educational Institutions.

It is believed that all who are alive to the advantages of photographic projections will find the Sciopticon Manual a valuable Hand-book.

# CONTENTS OF MANUAL.

	PAGE
Introduction,.....	xi
<b>CHAPTER I.</b>	
The Camera Obscura,.....	9
The Inverted Image,.....	10
Color and Shading,.....	10
Motion,.....	10
Size,.....	10
Size on the Retina,.....	11
Size in the Photographic Camera,	11
Magnified Image,.....	12
Inferences,.....	12
Experimental Verification,.....	13
Indistinctness,.....	13
Convex Lens,.....	13
Stops,.....	14

<b>CHAPTER II.</b>	
The Corrections required by	
Lenses,.....	14
The Form of Lenses,.....	15
Pencils of Rays,.....	15
Spherical Aberration,.....	16
Distortion,.....	17
Curved Field,.....	18
Chromatic Aberration,.....	19
Unequal illumination,.....	20
Corrections in the Eye,.....	20
The Landscape Lens,.....	21
The Portrait Objective,.....	22

<b>CHAPTER III.</b>	
	PAGE
The Construction of the Sciop- ticon,.....	24
No Loss of Light from using an Objective of Low Power with a Concentrated Light,.....	24
Advantages of Concentrated Light	25
The Condenser,.....	26
The Reflector,.....	26
Various Modes of Lantern Illu- mination,.....	27
The Size proper for the Illumin- ated Disc,.....	28
Analysis of the Sciop- ticon,.....	29
Packing,.....	32
Rules for Operating the Sciop- ticon.....	33
Recapitulation,.....	36
The Screen,.....	37
Dissolving Views,.....	39
Directions for Producing the Dis- solving Effect,.....	41
The Phantasmagoria,.....	44
Ancient Magicians,.....	45

<b>CHAPTER IV.</b>	
Picture Slides,.....	50
The Standard Size for Lantern Slides,.....	51
The Sealed Picture,.....	52
Statuary,.....	53

	PAGE		PAGE
The Slip Slide.....	54	Sunday-school Pictures.....	97
The Lever Slide.....	55	Extracts.....	98
Revolving Figures.....	55	Bible Lands.....	103
The Chromatrope.....	56	Egypt.....	110
Eidrotrope.....	57	Views of interest in all parts of the World.....	119
Moving Waters.....	57	Nursery Tales.....	119
Long Slides.....	58	Composition Pictures.....	121
Dioramic Painting, with Mov- ing Figures.....	58	Statuary.....	122
The Ghost.....	58	Movable Slides.....	123
The Tank.....	59	Scientific Slides.....	123
Precautions about Slides.....	60		
<b>CHAPTER V.</b>		<b>CHAPTER IX.</b>	
<b>PHOTOGRAPHY.</b>		<b>THE SCIOPTICON AND ITS USES.</b>	
Glass Positives for the Magic Lantern.....	61	Description of the Sciopticon, 125 Magic Lantern, from 1650 to 1870.....	126
The Camera.....	62	Traveling by Magic.....	128
Solutions.....	63	Sciopticon for Sunday-schools,	130
The Negative.....	64	Science at Home.....	130
The Lens.....	65	Various Experiments.....	132
Dry Plate Process.....	67		
Collodio-Chloride Process.....	71	<b>CHAPTER X.</b>	
Marcy's Photographic Print- ing Apparatus.....	72	<b>THE TEACHER HIS OWN ARTIST.</b>	
Sciopticon Process.....	74	A Process of Drawing and Painting Magic Lantern Slides.....	135
Woodbury Photo-Relief Slides.	76	List of Apparatus and Mate- rials.....	135
<b>CHAPTER VI.</b>		A New Copying Camera.....	139
<b>COLORING SLIDES.</b>		Diaphanie.....	141
Water Colors, etc.....	78	Enamel Slides.....	142
Easel Brushes, etc.....	79	Prepared Glass.....	142
Statuary.....	82	Sample of Size and Shape.....	143
Silhouettes, Natural Objects, etc.....	82	<b>CHAPTER XI.</b>	
<b>CHAPTER VII.</b>		<b>NOVELTIES.</b>	
<b>CHEMICAL EXPERIMENTS.</b>		Chimney Cap.....	144
Tank and Pipette.....	84	Sciopticon Curtain.....	144
Chemical Reactions.....	85	Tinters.....	145
Crystallizations.....	86	New Slide Stop.....	145
Miscellaneous Experiments...	87	A New Departure.....	146
<b>CHAPTER VIII.</b>		Eidrotrope.....	146
<b>DESCRIPTIVE LECTURES.</b>		Wheel of Life.....	147
Bible Pictures.....	95	Dancing Skeleton.....	147
		Dance of the Witches....	148
		Effect Slides.....	149

CHAPTER XI.—THE LIME LIGHT.

	PAGE		PAGE
Flame Illuminati on.....	151	Dissolving Cock.....	171
Varieties in Lime Light.....	151	Preparation of Oxygen Gas....	172
No. 1, Alcohol Burner....	152	Preparation of Hydrogen Gas.	174
No. 2, House Gas Concentric Burner.....	153	Pressure Boards.....	177
Drummond Light.....	154	Self-Condensing Cylinders....	178
No. 3, Mixed Jet.....	155	Multum in Parvo.....	181
Dangers Peculiar to Mixed Jet,	155	An Economical Form of Gas Holder for the Lime Light... 182	
Annoyances Peculiar to the Mixed Jet.....	156	Other Gas Contrivances.....	186
Marcy's Triple Jet.....	158	Lantern Attachments.....	188
Oil Sciopticon with Triple Jet.	160	Microscope Experiments.....	189
Lime-light Sciopticon.....	161	Holman's Siphon Slide.....	190
Triple Jet Adjustments.....	161	Gas Microscope, by Henry Mor- ton, PH. D.....	191
Lime-light Adjustments.....	163	Sciopticon Microscope Attach- ment.....	194
Ratio of Spaces.....	164	The Megascopce.....	195
Changing the Scene.....	166	Sciopticon Kaleidoscope.....	197
The Automatic Cut-off.....	167	Reflecting Polariscope.....	199
Patent Slide Carrier.....	169	Refracting Polariscope.....	200
Both Sciopticons with an in- terchangeable Set of Lenses..	170		

CONTENTS OF SCIOPTICON CATALOGUE.

INTRODUCTION.

	PAGE		PAGE
Notice, Sixth Edition.....	ii	Comparison of the Different Sources of Illumination..	xviii
Where to find Explanations, Peculiar Advantages of the Oil Sciopticon.....	iv	The Slide Question— Plain or Colored?.....	xxi
Peculiar Advantages of the Gas Sciopticon.....	x	Nature or Art?.....	xxiii
How to Secure the Fullest Advantages of Both.....	xiii	Strong or Faint?.....	xxiii
Late Improvements.....	xiv	The Bad and the Good.....	xxiv
Lantern Projections as an Educational Appliance...  xv		What's in a Name?.....	xxiv
		Descriptive Lectures.....	xxv
		Sciopticon Catalogue Ar- rangement.....	xxvi

PRICE LIST OF SCIOPTICON APPARATUS.

	PAGE		PAGE
Oil Sciopticon, etc.....	1	Separate Parts of Apparatus....	3
Gas Sciopticon.....	2	Lantern Attachments.....	4
Gas Bags, Generators, etc.....	2	Combinations and Estimates... 5	
Chemicals, Chemical Apparatus, 3		Dissolving Views.....	6

PRICE LIST OF COLORED MAGIC LANTERN SLIDES.

CLASS	PAGE	CLASS	PAGE
I.—Choice Selected Slides.....	7	XIII.—Original Leaf Designs..	32
II.—Sacred History.....	9	XIV.—Statuary and Bas Reliefs,	32
III.—Holy Land and Egypt....	9	XV.—Select Painted Comic Slip	
IV.—Ancient Greece and Rome,	11	Slides .....	33
V.—Complete Illustrations to		XVI.—Paintings with Levers,	
the Text of the Holy Bible....	12	Comic.....	34
VI.—Views of Interest in Dif-		XVII.—Dioramic Paintings,	
ferent Parts of the World....	17	with Moving Figures.....	35
VII.—American History.....	20	XVIII.—Paintings Illustrating	
VIII.—Franco German War...	21	Nursery Tales.....	35
IX.—Views in Sets, Conveying		XIX.—Fine Engravings.....	36
Moral Lessons .....	22		
1. The Pilgrim's Progress.....	22	<b>SCIENTIFIC DEPARTMENT</b>	
2. Christiana and her Child-		XX.—Mammalia .....	37
ren .....	22	XXI.—Birds.....	38
3. The Drunkard's Progress..	22	XXII.—Reptiles and Fishes...	38
4. The Bottle (Cruikshank)...	23	XXIII.—Insects.....	39
5. The Bottle (Comic).....	23	XXIV.—Arachnida, Crustacea..	39
6. Stomach of the Drunkard in		XXV.—Botany.....	40
Different Stages of Disease..	23	XXVI.—Flowers and Plants...	41
7. The Gambler's Career.....	23	XXVII.—Physical Geography.	42
8. The Ten Commandments..	23	XXVIII.—Astronomy.....	42
9. The Lord's Prayer.....	24	XXIX.—Geology .....	44
10. Four Scenes from the Life		XXX.—Natural Phenomenon..	45
of a Country Boy.....	24	XXXI.—Anatomy and Physi-	
11. Shakspeare's Seven Ages..	24	ology.....	45
12. Masonic, and other Lodge		XXXII.—Microscopic Anat-	
Pictures.....	24	omy.....	45
13. Tam O'Shanter.....	24	XXXIII.—Optics .....	46
14. New Tale of a Tub.....	24	XXXIV.—The Microscope and	
15. Renard, the Sly Fox.....	25	its Revelations.....	46
16. Fables of Lafontaine.....	25	XXXV.—Crystallography .....	47
17. The Crusaders.....	25	XXXVI.—Spectrum Analysis..	47
18. The Ill-Fated Ship.....	25	XXXVII.—Geological Land-	
19. Schiller's Song of the Bell..	25	scapes, etc.....	48
20. Rip Van Winkle.....	26	XXXVIII.—Society Emblems.	48
X.—Miscellaneous Pictures....	26	XXXIX.—Dissolving Effects,	
XI.—Dissolving Views.....	28	etc.....	50
XII.—Chromatropes, etc.....	30		

PRICE LIST OF PLAIN GLASS SLIDES.

CLASS	PAGE	CLASS	PAGE
XI.—American Views.....	55	XLIII.—Scientific Sciopticon	
XLI.—Foreign Views.....	61	Slides.....	68
XLII.—Centennial Slides.....	66		



## INTRODUCTION.

---

THE SCIOPTICON (pronounced Si-op-ti-con), is by far the most convenient and easily managed of any form of Magic Lantern. Its ridge of wide, intensified double flame, lying lengthwise in the axis of the condensing lenses, gives it much greater efficiency than any other lamp-illuminated lantern.

All who have become acquainted with this new instrument, see in it the accomplishment of what has long been greatly desired by those who appreciate the value of visible illustrations as a means of imparting instruction and of affording rational amusement.

Confessedly, the medieval magicians with their *lanterne magique* effected little good by their incantations and ghostly spectres. But modern educators have higher aims and better means at hand. Their lenses are greatly improved in form and quality. The photographer secures images of all that is interesting or

beautiful in nature and art. Literature and the sciences teem with pictorial illustrations, from which choice selections can be easily copied for lantern slides. And now the Sciopticon, with its own peculiar light for all ordinary occasions, and with the oxy-hydrogen light for occasions extraordinary, comes in to show up what is thus made ready.

In form and construction the Sciopticon is very unlike that relic of the middle ages, the old magic lantern. Those who are interested in the philosophy involved in it, in the peculiarities pertaining to it, in the practical management of it, in making and selecting slides for it, in performing scientific experiments with it, and in promoting the interest of education by it—will do well to inquire within.

# SCIOPTICON MANUAL.

## CHAPTER I.

### THE CAMERA OBSCURA.

A picture formed by rays of light from the several parts of an object as seen at *A* (Fig. 1), is called an *image*; and the *chamber* in which it is formed, and from which all light is excluded, except what enters a small hole as at *S*, is called a *camera obscura*.

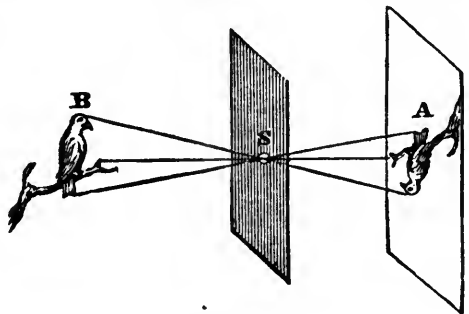

Fig. 1.

This dark chamber claims attention here because its properties, which are common to the eye, the Sciopticon, and all forms of the camera, are seen on a broad scale, and may be readily verified by inexpensive experiments. To avoid confusion the pencils of light are represented in Fig. 1 without marginal rays needing to be focused by a convex lens. Explaining the following properties in connection with a diagram without

a lens, may help to correct the common impression that these properties and a convex lens are inseparable.

#### **THE INVERTED IMAGE.**

Of the rays of light proceeding in all directions from every point in the object *B*, as from all illuminated objects, just an assortment, that is to say a pencil from each point will enter the hole at *S*, just in line to fall in reverse order upon the screen *A*, forming an inverted image.

The picture results from admitting just an assortment and excluding all the rest.

#### **COLOR AND SHADING.**

Light from each of the several parts of the object *B* illuminates with its peculiar color and relative intensity each corresponding part of the image, so that it is seen in natural light and shade, and in natural colors. The photographer can fix the relative shading, but he cannot, as yet, fix the colors.

#### **MOTION.**

If, for example, the bird moves to a higher perch, the pencils of light will fall to a lower place on the screen, and so any movement of the object which alters the direction of the pencils of light, will give a reverse movement to the image.

#### **SIZE.**

By inspecting the angle of extreme rays it will be seen that the image in this case is smaller than the object, because it is nearer the aperture; so in all cases, the relative size of the image depends on its relative distance from the aperture.

**SIZE ON THE RETINA.**

*A A* (Fig. 2) represents the visible portion of the sclerotica of the human eye, which is a camera obscura in perfection. *I I* represents the *iris* (or window shutter), in the middle of which is the pupil (or aperture). As the retina is only about half an inch behind the optical centre, it follows that the images of distant objects upon it must be very minute.

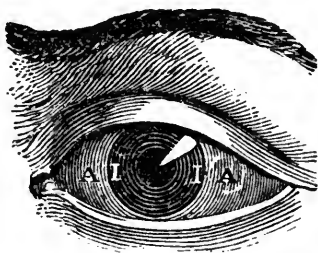

Fig. 2.

For example, the figure of a man 6 feet high, seen at a distance of 40 feet, produces an image upon the retina the height of which is about  $\frac{1}{4}$ th part of an inch. The face of such an image is included in a circle whose diameter is about  $\frac{1}{12}$ th of the height, and therefore occupies on the retina a circle whose diameter is about the  $\frac{1}{70}$ th part of an inch; nevertheless within this circle, the eyes, nose, and lineaments are distinctly seen. The diameter of the eye is about  $\frac{1}{2}$ th of that of the face, and therefore, though distinctly seen, does not occupy upon the retina a space exceeding  $\frac{1}{4000000}$ th of a square inch. How infinitely delicate must be the structure of the retina or canvas on which this exquisite miniature is delineated to receive and transmit details so minute with such marvellous precision!

**SIZE IN THE PHOTOGRAPHIC CAMERA.**

A man 6 feet high, standing for his picture 10 feet from a camera tube whose lenses require the screen of ground-glass adjusted to 5 inches, gives a 3 inch picture. For we have (in inches)

$$120 : 5 :: 72 : x \text{ hence } x = \frac{5 \times 72}{120} = 3.$$

**MAGNIFIED IMAGE.**

This rule works both ways; for suppose a screen to be suspended in place of the man, the space being darkened, and suppose the three-inch inverted image to be "fixed" and highly illuminated, then a secondary image will be projected upon the screen ten feet from the lens, corresponding to the original object in size and position:

**INFERENCE 1.**

A good portrait objective for the camera is also suitable for a lantern objective; for the lines of light and the angles are in both cases the same.

**INFERENCE 2.**

The light, if reflected from the three-inch picture, radiates so as to cover 100 times as much surface on the magnified image. Now, as a very small fraction of this reflected light is re-reflected to the eye of the observer, it seems a hopeless undertaking, to make the opaque lantern practically useful in showing the images of small paper photographs, on a large scale, with any ordinary flames, however well arranged.

**INFERENCE 3.**

With an intense light at a point behind the three-inch transparency, converged by a condenser, so as to enter the objective through all points of the picture, the magnified image is illuminated with incident rays concentrated, and its exhibition becomes a success.

**INFERENCE 4.**

Additional light outside this point (as some recommend), would not fall in line with the objective so as to improve the illumination; while the additional heat and diffused light would be very objectionable.

**EXPERIMENTAL VERIFICATION.**

These properties of the camera obscura, thus far considered, may receive more lively illustrations by actually darkening a room and admitting light through, say an inch hole. A room with but one window, and that looking from the sun, and towards objects illuminated by sunlight, is to be preferred. A lens, if one is used, of long focal distance (nearly flat) gives more room for spectators before the screen. The images, if the lens has short focus, may be better seen on the back of a semi-transparent screen by transmitted light, as they are seen on the ground-glass in a photographic camera. These moving pictures of busy life and wavy trees, of curling smoke and floating clouds, are peculiarly pleasing and beautiful, as well as suggestive of important principles in optics.

**INDISTINCTNESS.**

Fig. 1 fails of showing the divergence of each pencil of light to the size of the aperture as seen at *c* (Fig. 3);

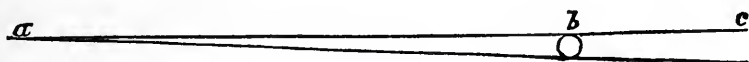
*Fig. 3.*

a property which renders the image indistinct, from the consequent overlapping of the blunt ends, so to speak, of innumerable pencils.

**CONVEX LENS.**

In accordance with the law of refraction, rays as from *d* (Fig. 4) are bent towards a perpendicular in entering the convex lens *l*, and from a perpendicular in

emerging from it. As the result of these refractions they meet at  $f$ . The converging power of lenses, of uniform substance and density, is in proportion to their



Fig. 4.

degree of convexity. For a lens to sharpen the image, the screen must be *adjusted* to the focal distance.

### STOPS.

To get on the same plate something like distinct images of objects at various distances, a "stop" is used by the photographer, which, though it necessitates long exposure, secures "depth of focus." This expedient of having a small aperture is also resorted to for lessening the defects or aberrations of lenses, just as the aperture  $b$  (Fig. 3) is made small to lessen the greater defect of having no lens.

Stops are not used in the Sciopticon objective, because all portions of the picture-slide are in the same plane, and because sharpness produced by stops is always at the expense of light.

---

## CHAPTER II.

### THE CORRECTIONS REQUIRED BY LENSES.

The corrections required by lenses (as well as everything photographic), is well set forth in Dr. Vogel's Handbook of Photography. The use of such diagrams, as are here appropriated, is kindly allowed by the Ameri-



can publishers, Benerman & Wilson. Of course one may successfully operate the Sciopticon, or even excel in photography, without a critical knowledge of lenses; but a very short, connected showing of their properties, with diagrams, will doubtless prove acceptable to many who use the Sciopticon, or who are interested in photography.

### THE FORM OF LENSES.

The convex, or converging lenses, 1, 2, and 3 (Fig. 5), called biconvex, plano-convex, and meniscus, are thicker

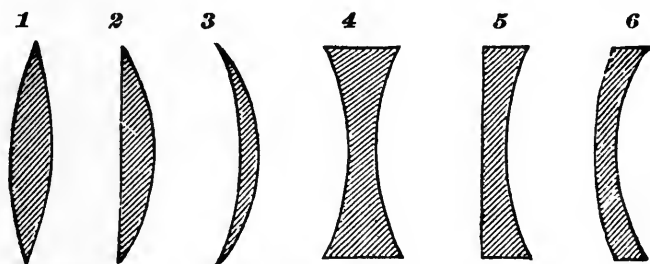

Fig. 5.

in the centre than on the margin. The concave, or dispersing lenses, 4, 5, and 6, called biconcave, plano-concave, and concavo-convex, are thinner in the centre than on the margin. A line through the centre of these lenses, from side to side, would show the axis of each lens.

### PENCILS OF RAYS AND THEIR ILLUSTRATIONS.

A pencil of rays considered in reference to its direction and the points in the image which it illuminates, may be represented by a simple straight line, as in Fig. 1; but in most cases, when the action of lenses on its rays is considered, it must be shown as a bundle of rays, as in Fig. 4. The pencil in Fig. 6 differs from  $df$  in Fig. 4, in having middle rays represented as well as marginal, and

in having them proceed from a point too distant to be shown. The rays of a pencil from a point 100 times further from the lens than is the image, are about parallel, and their focus is called the focus of parallel rays, or principal focus. A real pencil is composed of innumerable rays, and such pencils from innumerable points in the object meet and cross at the lens on their way to corresponding points in the image, and wonderful to tell, no one is switched from the track for another, and there are no collisions. An explanation of one answers for countless millions.

### SPHERICAL ABERRATION.

It is seen (Fig. 6) that the marginal rays  $d d$  must be more refracted, or bent, than the more central rays  $f f$ ,

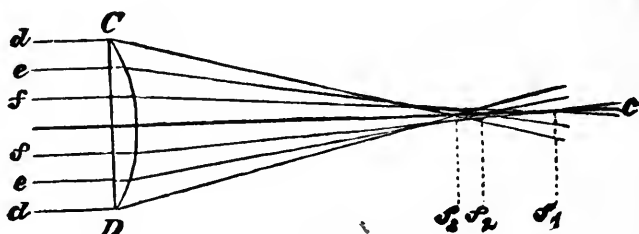

Fig. 6.

in order to meet the axial rays at  $f_1$ , and so it is seen that the margin of the lens  $C D$  has a greater refracting angle than the more central portions. But the trouble is, the refracting at the margin is overdone, so that the rays  $d d$  meet the axial ray at  $f_3$  instead of at  $f_1$ . Hence if a ground-glass has been placed at  $f_1$ , the marginal rays which have intersected the axis at  $f_3$  will form a circle of dispersion about  $f_1$ . The diameter of this circle is called the lateral aberration, and the distance between  $f_3$  and  $f_1$  is called the longitudinal aberration. As a con-

sequence of this want of coincidence between the foci of the central and marginal rays the picture on the screen, or ground-glass, will appear blurred and ill defined.

We can conceive of a lens with a gradually lessening degree of convexity towards the margin, causing the foci to coincide, but lenses cannot well be ground in this form. The crystalline lens in the eye is supposed to cause the foci to coincide by an increase of density towards its centre, but such an arrangement of matter would be impracticable in art. Much is gained by reversing the lens, for spherical aberration is four times as great when the parallel rays enter its plane surface, as when they enter its convex surface.

Much is gained by a combination of lenses so that the refracting angle may be less in each. Were the marginal rays  $d d$  cut off by a stop, the aberration would be less, as we can see by tracing them in the diagram, but the illumination would also be less by so much.

#### DISTORTION.

When we focus with a single lens with a front stop

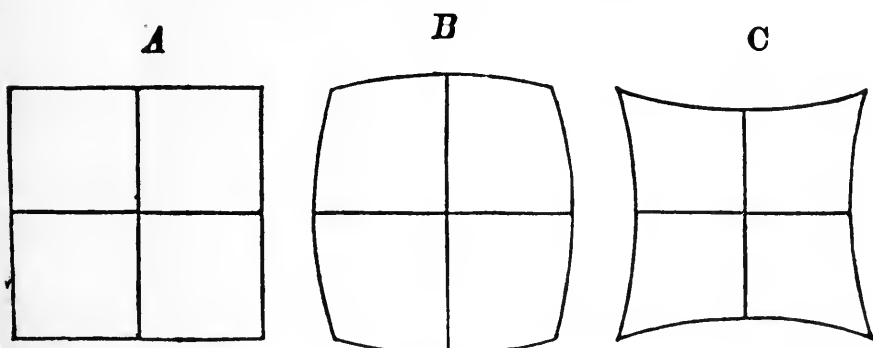

Fig. 7.

sharply on a square, *A* (Fig. 7) the resulting picture will not appear square, but barrel-shaped, as at *B*. When we

substitute a lens with the stop in the rear, the curves will be reversed, as at *C*. This property is based on the fact that the marginal rays of the field of view strike the lens under a larger angle than the central rays, and consequently suffer a greater refraction.

Of the simple form of lenses, the meniscus, with its concave side to the object, shows it the least. But it is best overcome by a combination of lenses with central stops.

### CURVED FIELD.

This error is not caused by spherical aberration, for it occurs with all perfectly aplanatic lenses, but by the curve of the image, as is shown by the arrow, Fig. 8.

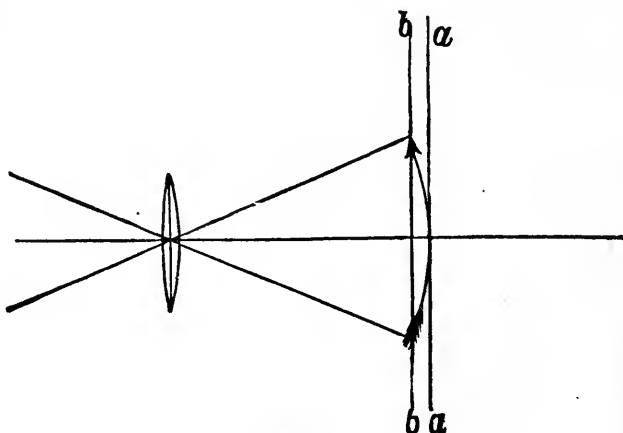

Fig. 8.

When the ground-glass is placed at *a a*, only the central part will appear sharp; when at *b b*, only the points of the arrow will appear well defined. This error is avoided by combination of lenses with suitable curves, and by stops.

**CHROMATIC ABERRATION, OR DISPERSION OF COLOR.**

White light is separated by a prism into the seven primary colors; violet, indigo, blue, green, yellow, orange, red.

As a lens is analogous to a system of prisms, and as violet is more refrangible than red, the violet rays  $v v$  (Fig. 9) will intersect the axis closer to the lens than the red rays  $r r$ . This error is corrected by combining a concave lens of flint-glass with a convex lens of crown-glass, so as to neutralize their contrary dispersions.

The concave flint-glass lens  $f$  (Fig. 12), which has great dispersive power in proportion to its curves, diverges the violet more than the red, while the convex crown-glass lens converges the violet more than the red, so we have in both combined an achromatic convex lens. As the chemical rays are in the violet end of the spectrum, the photographer may succeed with an im-

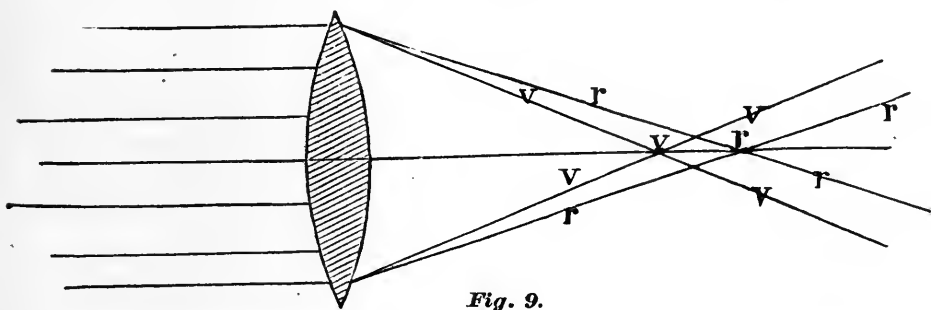

*Fig. 9.*

perfectly corrected lens by having the sensitive plate a little nearer the lens than the focus of luminous rays on the ground-glass would indicate. Lenses without chromatic aberration are called achromatic. The term aplanatic means without wandering, and may apply to lenses corrected of both spherical and chromatic aberration.

**UNEQUAL ILLUMINATION.**

We can see that the brightness of an image decreases from the centre towards the margin. The diameter of the pencil  $g g$  passing through the lens parallel to its axis, is of the same size as the opening of the stop  $B$ , and exceeds the diameter of the oblique bundle of rays. Besides, the oblique rays lose considerable light by reflection, which may in part be re-reflected upon the image,

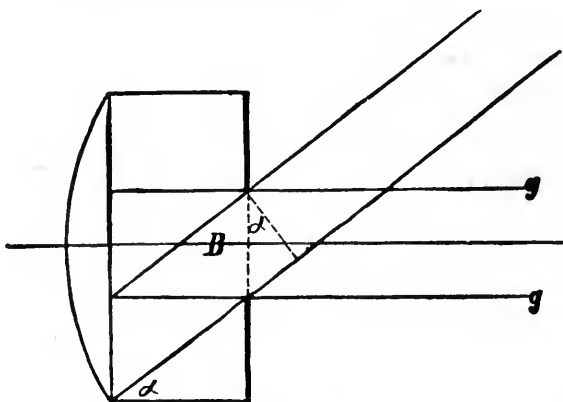

Fig. 10.

detracting from its distinctness. With a short exposure in the camera, this unequal illumination causes an under-exposure at the margin. In the Sciopticon it is even exaggerated by the reflector, but we generally wish the objects occupying the central portion of the "*field of view*" to stand out more clearly in the illuminated disk.

**CORRECTIONS IN THE EYE.**

Spherical aberration and distortion in the eye are corrected (it is believed) by the greater density of the crystalline lens about its centre than towards the margin, where the refracting angle would otherwise be too great.

Chromatic aberration is corrected by the combined

action of the crystalline lens and the vitreous and aqueous humors. As the retina,  $R R R$  (Fig. 11), is concave, the centre of concavity being the optical centre, there is no need of adjusting the focus to a flat field.

The eye is readily, for the most part unconsciously, adjusted, so that an object upon which we fix our attention is at once in the centre of the field of view, and is focused according to its distance.

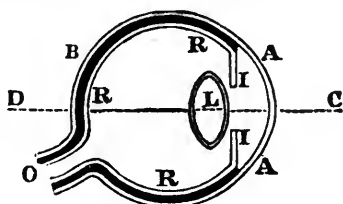

Fig. 11.

These five troublesome properties enumerated in this chapter, are thus, in the eye, harmoniously reconciled. In art we lack the peculiar crystalline lens, and the concavity of field. Making amends for this lack interferes with other corrections. Efforts of various makers to effect the best compromise for particular kinds of work has given rise to lenses, in variety too numerous here to particularize.

#### THE LANDSCAPE LENS.

This simple achromatic lens (Fig. 12) is the oldest photographic lens in existence. It is composed of the

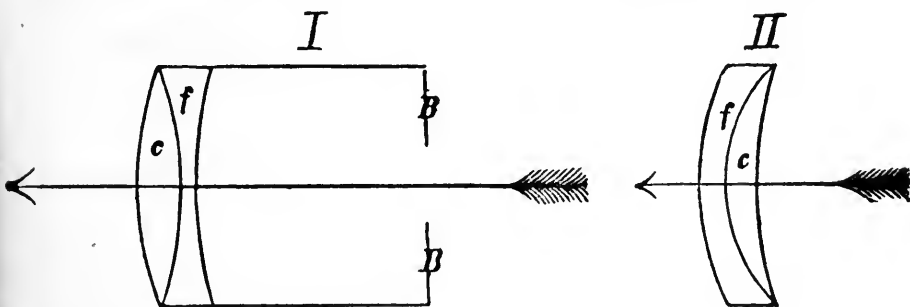

Fig. 12.

concave lens of flint-glass  $f$ , and the convex lens of crown-glass  $c$ .

Among the modified forms, the Dallmeyer Landscape Lens, which consists of three lenses cemented together, a central one of flint-glass and two outer ones of different kinds of crown-glass, gives better results. The stop *BB* is generally one-fifth of the focal length distant from the lens, and consequently cuts off much of the light. In the earlier days of photography a person had to sit in front of such a lens, in a strong light, for several minutes. That in this way no artistically perfect pictures could be made is self-evident, and so it became necessary for portrait photographers to have a lens that would work satisfactorily with a larger opening.

#### THE PORTRAIT OBJECTIVE.

This invention is no accident, but the result of a thorough theoretical calculation. It is a double objective with two unequal lenses, with or without central stops between.

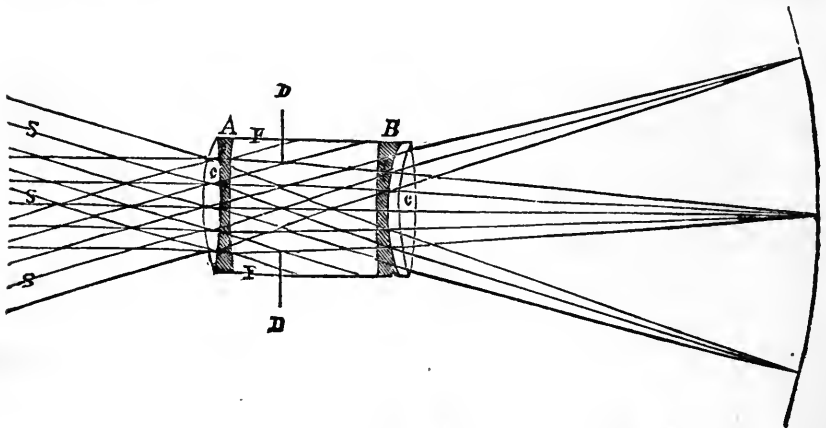

*Fig. 13.*

The front lens *A* consists of a biconvex crown, and an almost plano-concave flint-glass lens, cemented together with Canada balsam. The back lens *B* consists



of an almost plano-concave flint, and a biconvex crown-glass lens, separated by a ring. It is seen that some marginal rays entering the lens *A* do not reach the lens *B*, because of the length of the tube *FF*, which effects about the same result as the slight stop *DD*.

The curvature of the field is somewhat exaggerated in the diagram, to remind us that an aplanatic lens cannot give a perfectly flat field without a stop. In this general form all portrait lenses mostly coincide, differing in regard to the focal length of the separate objectives *A* and *B*, the distance and size of the same, the position of the stops, &c.

Considering Fig. 13 as representing a portrait objective, the pencils *SSS* proceed from an object comparatively large and distant, forming a small image in the camera. Considering the diagram as representing a lantern objective, the order is reversed. A small transparency is in place of the curved line, which in its turn becomes the focus of incident rays, projecting upon a screen a comparatively large and distant image where the pencils *SSS*, if extended, meet in a focus of refraction. *B* is called the back lens in either case, as it is back next to the instrument to which the tube is attached.

## CHAPTER III.

**THE CONSTRUCTION OF THE SCIOPTICON.**

**THE PORTRAIT OBJECTIVE.**—This objective (Fig. 13 or 15) is made for the camera, and is known mostly in its relations to photography. An objective, however, that with large opening, will give proper direction to rays from a large object to a small image in the camera, will answer equally well in giving direction to rays from the small picture in the Sciopticon back to life-size on a screen; both object and image being in the conjugate foci in either case.

**THE PLAIN LANTERN OBJECTIVE.**—This objective, like the achromatic portrait objective (Fig. 13 or 15), has the advantage of a front and a back lens, *A B* (Fig. 14), so far apart that the tube serves as a stop for marginal rays with comparatively small loss of light. The front lens *A* is a meniscus of crown-glass, whose tube slides into a larger tube which holds the plano-convex crown-glass lens *B*. Arranged as in the diagram, the effect is scarcely inferior, so far as common observation goes, to that of the most expensive combinations. With the front tube reversed, so as to bring *A* near to *B*, the image is larger but less distinct. With only one lens the image is smaller. These different arrangements give the three powers commonly attributed to lenses mounted in this form.

**NO LOSS OF LIGHT FROM USING AN OBJECTIVE OF LOW POWER WITH A CONCENTRATED LIGHT.**

Were the picture *p* (Fig. 14) made luminous by light shining upon it, as in an opaque lantern, the light would radiate in all directions, and in accordance with the law

of radiation would lose intensity with distance, and so a lens of short focus, being nearer, would bring more light

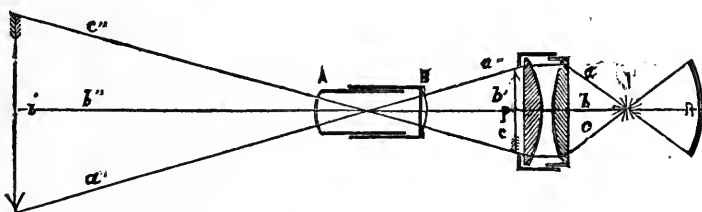

Fig. 14.

to bear on the image. But the light in fact proceeds from  $l$ , and what passes through the condenser and picture becomes a cone of light, with its apex in the objective.

This cone of light must be regulated by the position or power of the condenser so as to fall within the compass of the objective. Except for some reflections from the surfaces of the glasses, the light would not illuminate the room at all in its passage, and there would not be even the small need there is of the hood  $i$  (Fig. 15).

#### ADVANTAGES OF A CONCENTRATED LIGHT.

Could the light proceed from a mathematical point behind a faultless condenser, the pencils  $a' b' c'$  (Fig. 14) would be without marginal rays, and there would be nothing for the objective to do, for its office is to bring the marginal rays of each pencil to coincide with the axial ray. Were we to adjust the aperture of our window shutter (Fig. 1), to the apex of the cone, there would be no rays for the shutter to cut off. The image would be formed anywhere within reach of the light, either with or without lens or stop. But in reality even the most concentrated light occupies some space with countless radiant points, so near together however that

their radiations cross at a very small angle. The rays which meet and cross at each point in the picture  $p$ , become a pencil of diverging rays to be focused on the screen by the objective.

We conclude, therefore, that the more concentrated the light, the nearer in each pencil will the marginal rays coincide with the axial ray, and the less will the imperfections of lenses become manifest.

### THE CONDENSER.

The condenser is formed of combined lenses, because the refracting angles would be too great in a single lens of sufficient diameter and short focal distance.

The simplest arrangement is where two plano-convex lenses are combined, with their curved surfaces inwards, as in Fig. 14, or at  $p q$  in Fig. 15. The shorter the focus of the condenser, the shorter, with a given objective, must be its distance from the light; it will collect more light, but it will be in more danger of breakage from the heat. In the Sciopticon the space between the lens  $q$  (Fig. 15) and the front of the flame is only about two and a half inches, but the glass  $G$ , and the air between it and  $q$  rising up and out at  $A$ , makes it perfectly secure. The condensing lenses in the Sciopticon are usually each 4 inches in diameter; but a  $4\frac{1}{2}$  inch front condensing lens,  $p$ , is used to advantage for slides larger than the standard size, and to show fully the corners of some of the ordinary square transparencies.

### THE REFLECTOR.

The reflector  $r$  (Fig. 14) is so adjusted that the light is in the centre of concavity. Each ray is reflected back to its starting-point, and continues in line with

the incident rays  $a b c$ . Some advocate a larger reflector, a parabolic reflector, or reflectors at the sides; but unless the reflected light coincides with  $a b c$ , or nearly so, it is not transmitted by the objective lens.

With proper adjustments, the light  $l$ , with that from the reflector, is focused at the objective tube, of a comparative size proportionate to its relative distance from the condenser; and the picture  $p$  is focused upon the screen at  $i$  of a comparative size proportionate to its relative distance from the objective. As represented in Fig. 14, the smallest diameter of the cone of light in the objective  $A B$  would be twice that of the point of light  $l$ , and the height of the image  $i$  would be twice that of the picture  $p$ .

To project a picture to a great distance without too much enlargement, the objective must be of low power and carried forward; and the light should be from a point (as in the calcium light) to avoid loss, and should be carefully adjusted to secure even illumination.

The longitudinal ridge of light  $E$  (Fig. 15), with a medium objective gives uniformly good results without perplexing experimental adjustments.

#### **VARIOUS MODES OF LANTERN ILLUMINATION.**

The Hydro-Oxy-Calcium light, or lime made incandescent by a jet of hydrogen and oxygen in flame upon it, is the most brilliant available light. Its concentrated form adds greatly to its value for the lantern. The Oxy-Calcium light produced by a jet of oxygen on to lime, through an alcohol flame, is much inferior to what is produced by the mixed gases. It is much used, because one gas is easier to manage than two, and it is counted

safer. A lantern with a calcium light of either kind is commonly called a *Stereopticon*.

The Magnesium light is excellent in photography, but it gives off troublesome fumes, and for a continued lantern exhibition is too liable, even with well-regulated clockwork, to leave the lookers-on in sudden darkness.

The Electric light is intense and concentrated, but it requires too much apparatus to be available.

The above so-called chemical lights, are, if *well* managed, much brighter than flame, even at its best. The Sciopticon has a double flame, which is not only very bright, but gives much more distinctness to the image, by its standing edgewise to the condenser instead of broadside, as a single flame must, to prevent its casting a dark shadow on the disk. No lantern of any sort can compare with the Sciopticon in point of convenience. We may conclude that the Hydro-Oxy-Calcium light is best for exhibitions on a large scale, and as for the rest, the Sciopticon is desirable as combining efficiency and great convenience.

#### **THE SIZE PROPER FOR THE ILLUMINATED DISK.**

The image enlarges in area, and diminishes proportionately in brightness, as the distance of the lantern from the screen increases. A disk of six or seven feet is about right for figures, statuary, &c., to give brightness and not an unnatural size; while landscapes, &c., appear better on a disk of eight or ten feet, or more. With an objective of about four inches back focus, as is most used on the Sciopticon, a distance of about sixteen feet from the screen gives a disk of about eight feet. The arrangement can be varied to suit circumstances.

## ANALYSIS OF THE SCIOPTICON.

The lenses, mountings, &c., Fig. 15, are shown in section. What is left of the frame and cylinder, the lamp, chimney, reflector, &c., are shown in perspective. The parts are as follows :

*a b*—Front combination of the objective cemented together.

*c d*—Back combination separated by a ring. If the cells holding these combinations are unscrewed and the lenses removed, they must be returned in the same order and position as seen in the diagram. There is no need of removing them. Even the outer surfaces of *a* and *d* will seldom need dusting if kept in a clean place with the caps closed. They should not be fingered, and the brush or fabric used for dusting them should be clean and soft.

*e*—Milled head for adjusting the focus.

*f f*—Flange attached to the projecting wooden ring *g g*.

The tube here represented is a quarter-size portrait camera tube of  $4\frac{1}{4}$  inches back focus, requiring an aperture in *g h* of  $2\frac{3}{8}$  inches in diameter. If a larger tube is used, the aperture in *g h* has to be enlarged. If the back focus is more than 5 inches, the extension front *h k* must be drawn out more or less from the main body, as is shown in the diagram. If the focus is shorter than  $3\frac{1}{2}$  inches, the ring *g g* is removed, letting the flange *f* back to *h*.

*h h h'*—Wooden frame of the extension front; *h'* sliding in a groove within the body-frame *l l*.

*i*—Top of the hood covering light dispersed by reflection. The near side is cut away to show the screen *k*; the edge of the remaining side is seen beyond *k*.

*k*—Is now modified into a horizontal lid, which shuts up over the lens *d*, darkening the picture on the screen like a falling curtain.

*l l*—Portion of the wooden frame, the rest being mostly cut away to show the lamp, and how the extension front slides in its groove.

*m*—Claw attached to the front foot.

*n*—Flange under the back foot. On the top of the Sciopticon case, or box in which it is carried, and which can be placed upon a stand or table to elevate the instrument to proper height while in use, are two round-headed screws, slightly raised, and at the distance apart of *m n*; *m* clings to one, and *n* slips under the other,

thus holding the instrument firmly in place. When a pair is used for dissolving views, the fronts are thus held in a fixed position, while the rear ends may be spread apart till the disks on the screen coincide.

*o o'*—Stage and spring for wooden-mounted pictures. The operator standing behind, slides a picture horizontally in at *o*, letting it bear against the condenser mounting, and letting it project equally

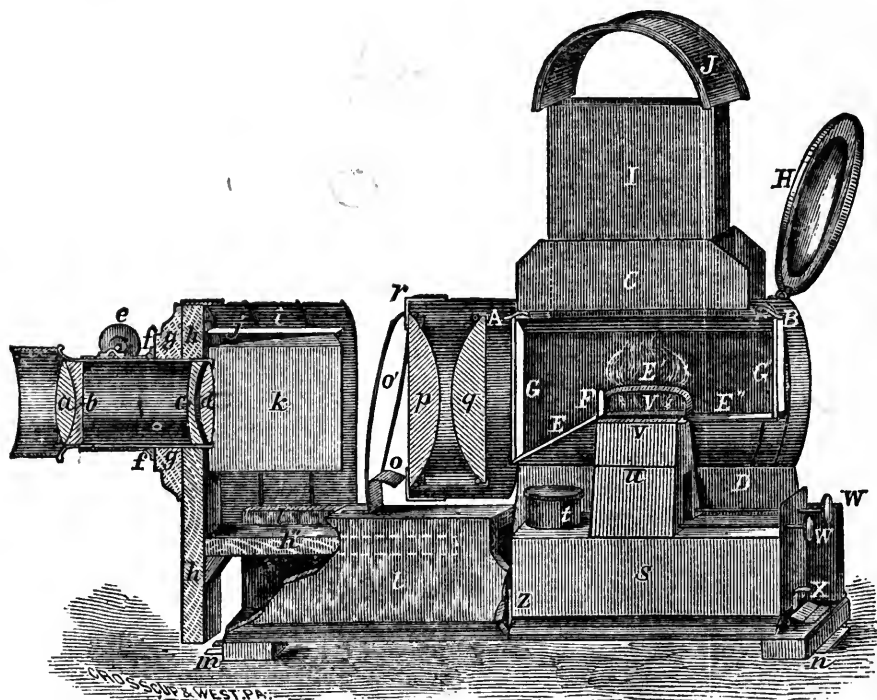

Fig. 15.

both sides of the cylinder. The picture is drawn out with the left hand, while with the right hand another is made to follow in its place, so as not to show the white disk on the screen.

*p q*—Condensing lenses. Lenses when taken from a damp or cold place are apt to become covered with moisture, which shades the pictures. It is better when this is likely to be the case, to let the instrument stand in a warm room awhile, or else to draw the lenses apart and dry them before beginning an exhibition.

*r*—Brass ring, holding the condenser cells suspended in the cylin-



der, so as not to be anywhere in contact with it. The ring shuts over the end of the cylinder like the cover of a tin pail. To remove the condenser, the extension front is drawn off, and the stage *o* is lifted out of its place.

*s*—Lamp cup for kerosene oil. It holds three gills, or enough to last about 4 hours. When it has to be moved about much, it is better not to fill it more than two-thirds full, for if any oil gets outside, it gives off its offensive smell; while if there is no oil outside there is no smell from it in the least. When packed for transportation, the oil should be thoroughly drained off.

*t*—Nozzle to admit the oil. It is large, so that if a wick is carelessly turned down into the cup, it can be fished out with a bent wire.

*u*—Side of one of the two tubes, showing how the conduction of heat downwards is counteracted by breaking the connection in the metal. It is made of tin, for the reason that it is a slower conductor than brass.

*v v*—Tops of the two tubes. They carry No. 3 wicks, which are an inch and a half wide. The lamp being taken out, the wicks are pushed down the tubes till they are caught by the ratchet-wheels and drawn down. Should a loose thread of the wick get clogged in the wheels it must be drawn out and cut off. The ratchet-wheels could be made to bear tighter on the wicks by pounding gently along the bottom of the tubes, but such a necessity is not likely to happen.

*w w*—Buttons for adjusting the wicks; both are turned *inward* to raise the wicks, and *outward* to draw them down.

*x*—Spring for holding the lamp.

*z*—Stop, preventing the lamp from sliding in too far.

*A B*—Portions of the cylinder not cut away, seen beyond the condenser and flame-chamber.

*C*—Portion of the cylinder turned up, to give free ventilation all about the flame-chamber.

*D*—Portion of the cylinder turned down and supported by the wooden frame.

*E E' E''*—Bottom of the flame-chamber. It is not supported by contact with the lamp, thus avoiding the conduction of heat downwards. The slot through which the flame ascends is two inches long by half an inch wide. *E'* answers to the deflecting cap of a

common lamp.  $E''$  is level, to allow the lamp (*the wicks being turned down*) to slide in and out.  $E$  slopes so as not to shade the light from the condenser.

$F$ —Narrow strip of glass, quarter of an inch wide, held in a socket before the flame, to give upward direction to heated air. It will not crack from heat because it is so narrow, and without obstructing light it takes from the glass  $G$  its liability to crack.

$G$ —Front of flame-chamber glass. It is now held in a tin frame by a wire ring, so that should it crack, it is still kept in place without harming the effect on the screen.

$G'$ —Back flame-chamber glass. The lamp is lighted by removing this glass, and reaching the wicks with a lighted match.  $G$   $G'$  must be in place to secure the draft.  $F$ , especially since the introduction of the tin frame for  $G$ , is scarcely necessary.

$H$ —Reflector, used also to close the rear of the cylinder. The centre of concavity is at  $E'$ , so that reflected rays are thus made to coincide with incident rays from  $E'$  to the condenser.

$I$ —Chimney, giving large outlet to heated air.

$J$ —Chimney cap, for darkening the outlet. It may be raised to increase the draft, when the lamp gets to burning freely enough to bear it.

### PACKING.

No instrument is forwarded without being first proved by careful trial. The oil is then poured off, and the lamp burned awhile afterwards, to prevent any further drainage should it be shipped wrong side up. Let this precaution be taken by all who pack the instrument for transportation, that there may be none of the offensive smell of oil when the instrument is unpacked and used.

The wicks are left in the tubes, ready for use. Four extra wicks, with the narrow glass,  $F$ , are tied together, which with a dozen flame-chamber glasses,  $G$   $G'$ , are sent with each instrument.  $F$  is removed, as it is liable to fall out if inverted. For the most part  $G$   $G'$  are left in place. Packing is placed between  $G$  and  $g$ , to pre-

vent their getting out of place and scratching against each other; also between  $G'$  and  $H$ , and between the condensing lenses.

The cap  $J$  is removed and placed behind the chimney. The whole is snugly packed in a box with stuffing, and the cover fastened on with screws. These particulars may be advantageously referred to in case of repacking by the purchaser or borrower.

### **RULES FOR OPERATING THE SCIOPTICON.**

In unpacking a new instrument the parts must be separated, to remove the packing papers.

Dust them if necessary.

For the lenses and reflector use a duster that is soft and clean.

Warm and dry the condensing lenses if inclined to fog.

Adjust  $F$ ,  $G$ ,  $G'$ ,  $J$ , and the lenses, as seen in Fig. 15.

Shut the extension front back to its place.

Fill the lamp about two-thirds full with standard kerosene oil. The fire test should be  $110^\circ$  at least; that of Pratt's astral oil is  $145^\circ$ .

Avoid carelessly tilting the lamp when it is very full, and so avoid the smell of oil evaporating from the outside surface.

Turn down the wicks, so they will not rub against the deflecting plate while withdrawing or inserting the lamp.

It is convenient to stand the instrument so as to be about breast high.

The image enlarges as the distance of the instrument from the screen increases. With a medium objective, a distance of sixteen feet gives a disk of eight feet, &c.

Exhibitions of this sort appear to the best advantage

in the evening; shutting out daylight is not only troublesome, but the eye is not prepared for the contrast. Lights should be turned down near the screen, but may be left dimly burning in the distance, or out of range of the screen.

Light the lamp in the instrument, as it stands in the diagram, by removing the back glass,  $G'$ , turning up the wicks by a turn inward of the buttons  $w w$ , and reaching the wicks  $V V$  through  $E'$  with a lighted match. To avoid smoke, turn the wicks almost down again till the glass is replaced.

Turn up the flames evenly about half an inch at first; they will rise a little after the wicks are warm, when they may need looking to again, after which they will stand steady without requiring further attention.

Put out the light by drawing the wicks down with a turn of the buttons outward, and then blowing under the reflector.

The wicks may be trimmed when the lamp is taken out to be filled; cut them level; it may be done more evenly by only removing the black part.

If kept in a dry place the reflector will keep its polish for a long time; it is protected by a film which should not be rubbed.

While exhibiting, the operator should stand behind the instrument, having the slides arranged at his right, in the proper order and inverted position required for exhibition. If the instrument is in front of the screen, the wire ring fastening the double glass into the wooden mounts should be towards the condenser, in order to show the views in a right-handed position. Some operators mark what should be the upper right hand corner of each picture, with a piece of white paper, or a notch.

Pass the slides in with the right hand, level and true,

without jumping them about. The stage  $o$  slants down to the condenser, to keep the slides down close to it.

Take the slides out with the left hand as others are pushed into place, so as to leave none of the white disk visible, and put them in their box as before. A slide standing endwise between those which have been used and those which have not, will keep them apart.

As photographers are giving increasing attention to preparing slides, there is an increasing proportion in the market of the size of half a stereoscopic view, or  $3\frac{1}{4}$  inches square, bound with narrow binding. For these a wooden stage 9 inches long is attached to  $o o'$ , so that, without crowding a picture out at the end, its successor may be pushed into its place, by the finger following to where the cylinder and stage intersect; with the left hand at the button attached to the back stop we may: 1. Close stop. 2. Slide in the picture. 3. Uncover—so that in the time of counting three we have changed the scene without any visible movement. This, well managed, is better than dissolving views poorly managed.

Tanks for insects, fish, chemical experiments, &c., &c., slide into the stage as easily as pictures. The stage being open at the top, with no bulky lantern case to obstruct it, is peculiarly suited to all such operations.

A slender wire in the direction  $r o'$ , answers the purpose of a long rod pointing upward on the screen to explain the representations.

The simplicity and completeness of the Sciopticon are more evident in practice than may seem while considering so wide a range of details and contingencies. The advantage of having an instrument so completely under one's hand is not only felt by the operator, but the smoothness it gives to the exhibition is appreciated by spectators.

Beginners who wish to understand and operate the Sciopticon by explanations and directions which can be seen at a glance, may examine in connection with Fig. 15, the following

#### RECAPITULATION.

The front,  $h h h'$ , with its attachments, draws apart from the body of the instrument.

The stage  $o o'$  lifts out.

The condenser,  $p q$ , is drawn out by laying hold of the ring  $r$ .

The cells holding  $p$  and  $q$  draw apart.

The front flame-chamber glass  $G$  is held in place by the spring  $A$ , which can be reached through the opening over  $A$ .

With  $h o p q G$  removed, the narrow glass  $F$  (found packed with the extra wicks) is reached to position, and needs no further attention.

The portion of chimney attached to the cap  $J$ , telescopes into  $I$ .

The lamp  $S$  slides out horizontally, by raising the spring  $X$ .

With packing removed, glasses clean, lamp filled two-thirds full of standard kerosene oil, and all parts in place as seen in the cut, remove the back glass  $G'$ , and reach the wicks  $v v$  with a lighted match. Replace  $G'$ , and let the flames stand about one inch high.

See, specially, that an oil so inflammable as to light at the safety slit  $u$  is not used—that no oil is left outside the lamp-cup, to give off an offensive smell—that the wicks at  $v v$  are not raised to rub against the plate  $E''$  when the lamp slides in and out—that the flame-chamber glasses  $G G'$  are in place to secure draft, and that the

oil is thoroughly drained out of the lamp-cup should the instrument have to be repacked for transportation by public conveyance.

Standing behind the instrument, placed about breast high—as upon its box on a stand or table—close down the reflector  $H$ , pass in the slides at  $o o'$  with the right hand, taking them out with the left as other slides take their places. Focus the picture by the milled head  $e$ , upon the screen, which may be distant sixteen feet, more or less, as it is desired to have the scenes on a larger or smaller scale.

$k$  (unlike the cut) is horizontal, and turns up to give the appearance of a falling curtain on the screen.

#### THE SCREEN.

There can be nothing better for the projected pictures than the white-finished, whitewashed, or white-papered walls of many a lecture-room or dwelling. An appropriate space specially set apart and papered with white wall paper, having an outline, say of a wide recess or niche for statuary, is an inexpensive and not inelegant fixture, on which to display before the assembled household, without waste of room or trouble in arranging, the richest treasures of all the art galleries in Christendom. The time is coming, when for purposes of demonstration and illustration in the lecture-room, this *whiteboard* will rival the *blackboard*.

The best material in the market for a movable screen of good size, seems to be bleached sheeting of close texture, but not very fine, twelve-quarters wide. This gives us the material, nine feet square, for about two dollars. It has the advantage of being available whether the instrument is placed before or behind it. As, however, every pencil of light falling between the

open threads of the texture is lost, it is better, when the instrument is invariably to be placed in front, to cover the surface with whiting or paper, keeping it smooth by mounting it on a roller. When illuminated from behind, the screen should be wet, to tighten its texture and to make it translucent, and consequently luminous on the side towards the spectators. It can be wet and then stretched upon a frame, or first mounted and then sprinkled to saturation. For home use, a sheet may be stretched across the frame upon which the folding doors of most modern houses are hung, the doors being thrown open at the commencement of the exhibition. A waxed screen is often recommended, but it is little used on account of the difficulty of keeping it smooth and clean. An unmounted screen can be quickly put up in any room by procuring two strips of wood about two inches square, and long enough to reach from the floor to the ceiling; a side of the screen is tacked to each one of these strips, which are then stretched apart, and wedged up tightly between the floor and the ceiling.

To widen the screen to more than nine feet, join the added width to each side, rather than bring a seam into the centre of the views.

A fine picture from within, upon oiled muslin, stretched upon a frame, made to fit a show window, is always greatly admired by all the passers-by. Such a framed oiled screen, on a small scale, can also be conveniently used in parlors, or in the doorway leading out from the company.

Working behind the screen has in many cases decided advantages, but the images can hardly be as bright by transmitted light, and other things being equal, it is better for the instrument to be in front.



**DISSOLVING VIEWS.**

**THE STAND.**—The peculiar stand represented in Fig. 16, is mostly the one used with Sciopticon dissolving apparatus, and so can better be described with it, but it is not necessarily a part of it.

It consists of a well-made walnut box, mounted on two pairs of adjustable legs, attached by fixed thumb-screws and nuts. The back legs are an inch or so shorter than those attached to the front at *A*, to elevate the range of the lanterns. The back of the stand may be known by the match-lighter *G*, and by its being necessary for the operator from behind to have the opening and the box of slides *B* at his right hand. The slide *D* stands on end, to separate the used from the unused slides.

When the apparatus is taken down, the legs swing together on their hinges, and are tied in a bundle; the open side of the box becomes the top; the instruments occupy the stalls *E* and *F*; the dissolver is drawn apart and placed alongside; the caps are removed from the chimney, and placed in the rear; the box of slides occupies the space in front; the swing shelf *C* becomes the lid and is locked down; the strap *S* and its mate, now hidden under the instruments, meet over the top for one carrier, or serve like the ears of a basket, for two.

But as a stand, as seen in the diagram, the front of the box becomes the baseboard, and like any other 13 by 17 inch board, affords suitable standing-room for the apparatus; it is more likely to keep it level than a separate board, as it is dovetailed and firmly fastened in place.

**DISSOLVING APPARATUS ARRANGED.**—The fronts of the sciopticons *R* and *L*, hold firmly by claws to two

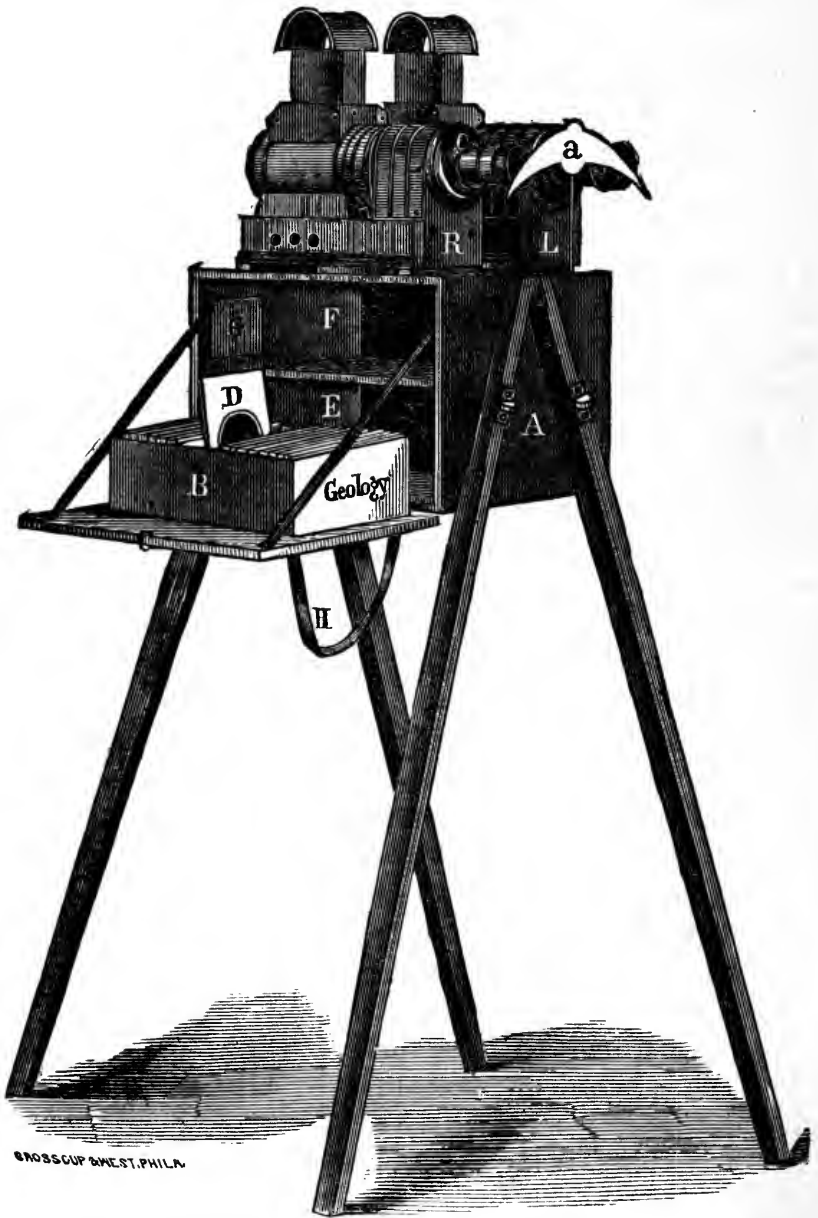

Fig. 16.

screw-heads  $7\frac{1}{4}$  inches apart; the flanges in the rear slide, under two similar screw-heads, holding the instruments down, but allowing them to spread till their disks coincide on the screen.

The construction of the dissolver is shown in Fig. 17, in its three parts. The crescent-shaped dissolver *a* is mounted on the arm *b*, as seen in Fig. 16, so as to cover alternately the tubes on *R* and *L*, as it swings from side to side. The horizontal part of *b* slips into *c* till the length of the united axle just allows the dissolver to swing clear of the tubes, and the whole is held in place by a socket-spring at each end of the baseboard.

The dissolver is operated by the handles at *c*, which are adjusted at the proper angle to limit the lateral movement of *a* to the distance between the tubes.

Light the lamps in their place by reaching the wicks with a lighted match, and attend to them at first to see that they burn steadily and evenly. Focus a picture in *R*, for example, while *L* is covered by the dissolver, and

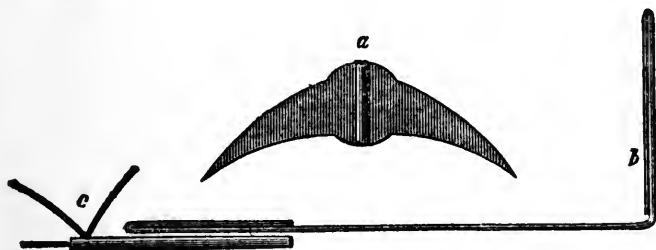

Fig. 17.

in *L* while *R* is covered; this reduces the disks to equal size on the screen. With the slides removed, and the dissolver in the position as shown in Fig. 16, spread the lanterns till the disks coincide.

#### DIRECTIONS FOR PRODUCING THE DISSOLVING EFFECTS.

—With the lanterns lighted, and arranged as shown in Fig. 16, and a slide placed in each, then the gradual

moving of the dissolver will very mysteriously dissolve one view into another.

This effect is commonly produced with slides not specially arranged for the purpose, but it is desirable that they should be of similar size and shape, and that they should be put in evenly, so as to cover the same space on the screen.

Many slides are, however, selected and executed with special reference to their producing charming effects in dissolving.

They are mostly arranged in pairs, as some view in summer and the same in winter, by day and by night, interior and exterior, in sunshine and in storm, or humanity in opposite moods. Sometimes the series are more extended, as the Seasons, the Voyage of Life, &c., and sometimes they are in connection with chromatropes to represent volcanic action, conflagrations, fireworks, turning mills, &c. Suppose, for example, Saint Peter's, at Rome, is thrown upon the screen from *R*, and a night view of the same is placed in *L*; then as the dissolver is changed, Saint Peter's with its surroundings continues on the screen, but an appearance of night comes over it; the windows glitter with a thousand lights, and the moon makes its appearance in the heavens. Now, suppose a chromatrope, suited to the purpose, is placed in *R*, then as the change proceeds fireworks will rise from the darkness, and illumine the sky.

The snow effect is produced by a strip, usually of silk, with pin-holes all over its surface, mounted on rollers within a slide, so that when the silk is rolling up, snowflakes appear on the screen to be falling. Let, for example, a farm-house scene be projected from *R* upon the screen, amid all the glory of summer vegetation; place the snow slide in *L*, and let an assistant slowly

roll it up while the dissolver passes over; the snow shows plainer and plainer, till nothing but the falling snow appears. Now place in *R* the same view in winter and turn back the dissolver; the storm subsides, and the farm-house scene again appears in the morning light, covered with the newly fallen snow of the winter's night.

To bring out statuary on a blue ground, a slide of blue glass, and usually one of red glass also is used. Change any scene, first into a red disk, then the red into blue, and then let a piece of statuary slowly come out into the blue ground, while the blue becomes darker and darker, till it ends in a blackness which seems to add vigor to the representation.

A beautiful effect is produced by a wheel chromatrope, used continuously in one of the lanterns, while a series is shown in the other, turning it inward and outward alternately, as the dissolving proceeds. It thus seems to suck up the vanishing scene as in a maelstrom, and to bring out its successor with scintillations of colored lights.

A pleasing effect is produced by showing a series of views in one lantern, and a veranda, or some appropriate design with opaque centre, with the other. If in adopting this suggestion, the veranda be focused for the edges of the field, and the view focused for the centre, a flat field is obtained over the entire disk. In this case, and in all cases when light from both lanterns is to appear, the dissolver is slipped up an inch higher, and kept in position as in Fig. 16.

The slow or dissolving process may become monotonous, and it is not always appropriate. We hardly like to see "Pilgrim" in his "Progress" fading away, while his *double* by his side is slowly growing in strength and

vigor. It is better to allow the axle of the dissolver to turn at once, flashing the change upon the disk.

Much use can be made of this expedient, as it is so easily effected in the apparatus represented. A duplicate picture placed in *R* and *L* in reverse order, the dissolver being changed back and forth with a sudden movement, will show an "about face" as of a person bowing to the company, a lion uneasy in his cage, &c.

Lightnings may thus be made to flash upon scenery, especially when the view is darkened somewhat by turning down its light a little, giving the appearance of a rising tempest.

Discretion and good taste should be observed in arranging the slides for an exhibition, so as not to mar beauty with caricature, or sacred scenes with what is ridiculous; yet it is well to avoid monotony, for "variety is the spice of life."

Dissolving views, it must be confessed, are usually treated in a somewhat florid style by opticians, so it may be safe to make some abatement in anticipating the effects, especially of high-priced mechanical slides, lest when they chance to fall below the "Royal Polytechnic Institute in London," there should be a feeling of disappointment.

In the Sciopticon enterprise, it has been kept steadily in mind, to produce beautiful and useful results by the simplest means; and the desire is felt, not to make as large sales as possible, but to have every purchaser realize his highest expectations.

#### **THE PHANTASMAGORIA.**

To produce this effect, the operator should be on one side of the wet screen, and the spectators on the other.

Taking the instrument under his left arm, he should go up pretty close to the screen, and adjust the focus with his right hand; the image of course will be very small; he must then walk slowly backwards, at the same time adjusting the focus. As the image increases in size, it will appear to the spectators to be coming towards them; and then again let him walk up towards the screen, thus diminishing the image, and it will appear to them as if receding. The screen not being seen, the image appears to be suspended in the air, and the deception is complete, even to those accustomed to the exhibition. The focusing is most evenly and easily effected by prying the extension front out and in with the thumb and fingers of the right hand.

Slides producing the best phantasmagorial effect are those containing but one or two figures with a black background. In ancient times, the images from the phantasmagoria were thrown on the smoke arising from a chafing dish in which odors and drugs were burning, and by means of which many surprising and apparently supernatural effects were produced. As a relief from so closely following practical details, let us advert to the probable use made by ancient magicians, necromancers, and sorcerers, of these optical contrivances for producing supernatural illusions. In this we cannot do better than to quote from that eminent authority on optical science, Sir David Brewster :

“In the imperfect accounts which have reached us of these representations, we can trace all the elements of optical illusion. In the ancient temple of Hercules, at Tyre, Pliny mentions that there was a seat made of consecrated stone, ‘from which the gods easily arose.’ Esculapius often exhibited himself to his worshipers in the temple at Tarsus; and the Temple at Enguinum, in Sicily, was

celebrated as the place where the goddesses exhibited themselves to mortals. Jambliches actually informs us that the ancient magicians caused the gods to appear among the vapors disengaged from fire.

“The character of these exhibitions in the ancient temple is so admirably depicted in the following passage of Damascius, quoted by M. Salverte, that we recognize all the optical effects which have been already described. ‘In a manifestation,’ says he, ‘which ought not to be revealed, . . . there appeared on the wall of the temple a mass of light, which at first seemed to be very remote; it transformed itself in coming nearer, into a face evidently divine and supernatural, of a severe aspect, but mixed with gentleness, and extremely beautiful. According to the institutions of a mysterious religion the Alexandrians honored it as Osiris and Adonis.’

“These and other allusions to the operations of the ancient magic, though sufficiently indicative of the methods which were employed, are too meagre to convey any idea of the splendid and imposing exhibitions which must have been displayed. A national system of deception, intended as an instrument of government, must have brought into requisition not merely the scientific skill of the age, but a variety of subsidiary contrivances, calculated to astonish the beholder, to confound his judgment, to dazzle his senses, and to give a predominant influence to the peculiar imposture which it was thought desirable to establish. The grandeur of the means may be inferred from their efficacy, and from the extent of their influence.

“This defect, however, is to a certain degree supplied by an account of a modern necromancy, which has been left us by the celebrated Benvenuto Cellini, and in which he himself performed an active part.

“‘It happened,’ says he, ‘through a variety of odd accidents, that I made acquaintance with a Sicilian priest, who was a man of genius, and well versed in the Latin and Greek authors. Happening one day to have some conversation with him when the subject turned upon the art of necromancy, I, who had a great desire to know something of the matter, told him, that I had all my life felt a curiosity to be acquainted with the mysteries of this art.

“‘The priest made answer, “that the man must be of a resolute and steady temper who enters upon that study.” I replied, “that I had fortitude and resolution enough, if I could but find an oppor-



tunity." The priest subjoined, "If you think you have the heart to venture, I will give you all the satisfaction you can desire." Thus we agreed to enter upon a plan of necromancy. The priest one evening prepared to satisfy me, and desired me to look out for a companion or two. I invited one Vincenzo Romoli, who was my intimate acquaintance; he brought with him a native of Pistoia, who cultivated the black art himself. We repaired to the Collosseo, and the priest, according to the custom of necromancers, began to draw circles upon the ground, with the most impressive ceremonies imaginable; he likewise brought hither asafœtida, several precious perfumes, and fire, with some compositions also, which diffused noisome odors. As soon as he was in readiness, he made an opening to the circle, and having taken us by the hand, ordered the other necromancer, his partner, to throw the perfumes into the fire at a proper time, intrusting the care of the fire and perfumes to the rest, and thus he began his incantations. This ceremony lasted above an hour and a half, when there appeared several legions of devils, insomuch that the amphitheatre was quite filled with them. I was busy about the perfumes, when the priest, perceiving there was a considerable number of infernal spirits, turned to me and said, "Benvenuto, ask them something." I answered, "Let them bring me into the company of my Sicilian mistress, Angelica." That night he obtained no answer of any sort; but I had received great satisfaction in having my curiosity so far indulged. The necromancer told me it was requisite we should go a second time, assuring me that I should be satisfied in whatever I asked; but that I must bring with me a pure immaculate boy.

"I took with me a youth who was in my service, of about twelve years of age, together with the same Vincenzo Romoli, who had been my companion the first time, and one Agnolino Gaddi, an intimate acquaintance, whom I likewise prevailed on to assist at the ceremony. When we came to the place appointed, the priest having made his preparations as before, with the same and even more striking ceremonies, placed us within the circle, which he had likewise drawn with a more wonderful art, and in a more solemn manner than at our former meeting. Thus, having committed the care of the perfumes and the fire to my friend Vincenzo, who was assisted by Agnolino Gaddi, he put into my hand a pintaculo or magical chart, and bid me turn it towards the places that he should

direct me; and under the pintaculo I held the boy. The necromancer, having begun to make his tremendous invocations, called by their names a multitude of demons who were the leaders of the several legions, and questioned them, by the power of the eternal uncreated God who lives forever, in the Hebrew language, as likewise in Latin and Greek; insomuch that the amphitheatre was almost in an instant filled with demons more numerous than at the former conjuration. Vincenzio Romoli was busied in making a fire, with the assistance of Agnolino, and burning a great quantity of precious perfumes. I, by the directions of the necromancer, again desired to be in the company of my Angelica. The former thereupon turning to me, said: "Know, they have declared, that in the space of a month you shall be in her company."

"He then requested me to stand resolutely by him, because the legions were now above a thousand more in number than he had designed; and besides, these were the most dangerous; so that, after they had answered my question, it behooved him to be civil to them and dismiss them quietly. At the same time the boy under the pintaculo was in a terrible fright, saying that there were in that place a million of fierce men, who threatened to destroy us; and that, moreover, four armed giants of enormous stature were endeavoring to break into the circle. During this time, whilst the necromancer, trembling with fear, endeavored by mild and gentle methods to dismiss them in the best way he could, Vincenzio Romoli, who quivered like an aspen leaf, took care of the perfumes. Though I was as much terrified as any of them, I did my utmost to conceal the terror I felt, so that I greatly contributed to inspire the rest with resolution; but the truth is, I gave myself over for a dead man, seeing the horrid fright the necromancer was in. The boy placed his head between his knees and said, "In this posture will I die, for we shall all surely perish." I told him that all these demons were under us, and what he saw was smoke and shadow; so bid him hold up his head and take courage. No sooner did he look up than he cried out, "The whole amphitheatre is burning, and the fire is just falling upon us." So covering his face with his hands, he exclaimed, "that destruction was inevitable, and desired to see no more." The necromancer entreated me to have a good heart, and take care to burn proper perfumes; upon which I turned to Romoli, and bid him burn all the most precious perfumes he had.

At the same time I cast my eye upon Agnolino Gaddi, who was terrified to such a degree that he could scarce distinguish objects, and seemed to be half dead. Seeing him in this condition I said, "Agnolino, upon these occasions a man should not yield to fear, but should stir about and give his assistance, so come directly and put on some more of these." The effects of poor Agnolino's fear were overpowering. The boy hearing a crepitation, ventured once more to raise his head, when, seeing me laugh, he began to take courage, and said "that the devils were flying away with a vengeance."

"In this condition we stayed till the bell rung for morning prayers. The boy again told us that there remained but few devils, and these were at a great distance. When the magician had performed the rest of his ceremonies, he stripped off his gown and took up a wallet full of books which he had brought with him.

"We all went out of the circle together, keeping as close to each other as we possibly could, especially the boy, who had placed himself in the middle, holding the necromancer by the coat, and me by the cloak. As we were going to our houses in the quarter of Banchi, the boy told us that two of the demons whom we had seen at the amphitheatre went on before us leaping and skipping, sometimes running upon the roofs of the houses, and sometimes upon the ground. The priest declared, that though he had often entered magic circles, nothing so extraordinary had ever happened to them.

"Whilst we were engaged in this conversation, we arrived at our respective houses, and all that night dreamed of nothing but devils.'

"Although Cellini declares that he was trembling with fear, yet it is quite evident that he was not entirely ignorant of the machinery which was at work, for in order to encourage the boy, who was almost dead with fear, he assured them that the devils were under their power, and that 'what he saw was smoke and shadow.'

"Mr. Roscoe, from whose life of Cellini the preceding description is taken, draws a similar conclusion from the consolatory words addressed to the boy, and states that they 'confirm him in the belief that the whole of these appearances, like a phantasmagoria, were merely the effects of a magic lantern produced on volumes of smoke from various kinds of burning wood.' If we suppose that the necromancer either had a regular magic lantern, or that he had

fitted up his concave mirror in a box containing the figures of his devils, and that this box with its lights was carried home with the party, we can easily account for the declaration of the boy, 'that as they were going home to their houses in the quarter of Banchi, two of the demons whom we had seen at the amphitheatre went on before us leaping and skipping, and sometimes running upon the roofs of the houses, and sometimes upon the ground.'"

We could hardly, in this enlightened age, attain to the brilliant success of frightening a "pure immaculate boy" out of his senses with "smoke and shadow," even were it a laudable undertaking. The delirium tremens, in a somewhat similar way, will doubtless continue to be hard on older and wayward boys who take to their cups, but be it ours to please and instruct, and that, in a more excellent way. A jet of steam could be conveniently arranged for the "ghost" experiment, but for the most part, a wet screen is better than smoke, and effects, not only startling, but truly beautiful, can be produced in the way described.

---

## CHAPTER IV.

### PICTURE SLIDES.

A LARGE number of movable slides, and some others of value, are still painted entirely by hand, but the great part of simple slides now in market are produced by photography.

There are two classes of photographic transparencies for the lantern, viz.: instantaneous and other views direct from nature, and reproductions of ancient and modern engravings, or paintings. A great part, especially of the latter, are beautifully colored by skilful artists, and mounted in a round form in wooden frames.

Some idea of the value of photography, associated with the magic lantern, as an educational instrument, may be gathered from the fact that as the camera has now penetrated to almost every habitable part of the globe, the physical peculiarities of every country, together with lifelike portraits of their inhabitants, and the form and arrangement of their dwellings, may be obtained in miniature, and reproduced as large as life.

Photographs of the sun and moon in various phases, and partially and totally eclipsed, also the fixed stars and nebulae, have been obtained and employed for lecture illustrations. Enlarged photographs of microscopic objects have also been obtained, and these again still further enlarged to 8 or 10 feet in diameter, so that, in fact, a diatom no larger than a grain of sand may be shown of such a size in the lecture-room that a large audience may together examine its details with perfect comfort. The productions of the most celebrated painters and sculptors may be shown with equal facility, as well as maps, hymns, music, &c., so that an entire school may learn or sing together.

#### **THE STANDARD SIZE FOR LANTERN SLIDES.**

The ordinary wooden frame for the lantern picture is 7 inches long, 4 inches wide, and  $\frac{3}{8}$  of an inch thick, with a circular opening of  $3\frac{1}{4}$  inches to admit the picture-glass and its protecting glass cover, and 3 inches in the clear. Pictures  $3\frac{1}{4}$  inches square are also mounted in frames of the same size, leaving 3 inches square in the clear. Pictures  $3\frac{1}{4}$  inches square, with their protecting glass covers, are also bound with narrow binding, and may be slid along into place in the grooves of a stationary frame, so as to show 3 inches square.

The new Woodbury slides are exactly quarter plate size ( $3\frac{1}{4} \times 4\frac{1}{4}$ ), which gives room at the sides for naming and for handling, and which in turn gives assurance of their being inserted in proper position.

Fortunately each half of a stereoscopic view is 3 inches square, so that lantern slides, of standard size, can be printed by contact from stereoscopic negatives. Although the demand for lantern slides has never warranted extensive travel for desirable negatives, yet the stereoscope has sent photographers "viewing" high and low, and everywhere; on the Alps, in the Yosemite, in the valley of the Nile, on open Polar Seas, and often (as intimated by one of their own number) into distressingly *narrow straits*.

Glass transparencies made for the stereoscope, when cut in two, with clear glass covers instead of ground-glass, are extensively used for lantern slides. Many of these, especially of the imported views, are very fine, and leave nothing to be desired when used in the Sciop-ticon. But as a heavy deposit of silver is not particularly objectionable in the stereoscope, many of these pictures can only be satisfactorily shown upon the screen, with an intense chemical light, if with that even. When the demand for these fine views for the lantern is sufficient to turn the attention of photographers to their production, we may look for more good pictures, and we hope at a cheaper rate.

#### **THE SEALED PICTURE.**

A drop of Canada balsam between two disks of plate-glass, on one of which is a beautifully colored photograph, is skilfully managed so as to allow the plates to come almost in contact, with a film of the balsam filling all the space between; this makes the picture beautifully

clear, and protects it from dust, and especially from any fluid that might accidentally reach the edges of the glass. All the circular pictures, except the movables, at a price of over two dollars, are sealed.

### STATUARY.

This class of pictures should be photographed directly from the statuary, or bas-relief, by a skilful artist, who



*Fig. 18.*

understands lighting and how to secure the proper degree and gradations of shading. It appears to the

best advantage when the rest of the slide is made opaque, so that we may seem to lose sight of the screen, and see the figure standing out in open space.

The circle, including Thorwaldsen's Night (Fig. 18), shows the size of the round glass, and also the appearance of one of the most popular slides of this class. A female figure is seen floating down to earth; around her forehead is a wreath of poppy, indicating sleep; in her arms are two sleeping children (Sleep and Death); and in their company is the symbolic owl.

#### THE SLIP SLIDE.

Fig. 19 represents a class of movable slides most in use for amusement; being cheap, easily operated, and in shape to pack with ordinary slides.

In the slide represented, a peacock without a tail is painted on the immovable glass, and two tails are painted

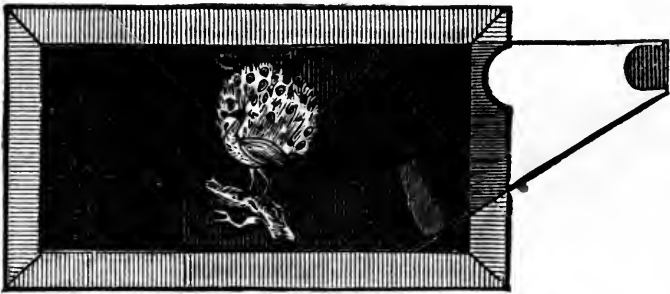

*Fig. 19.*

on the slip. Both glasses are blackened except where the picture is to show; when the slip is pushed in, the bird appears with a drooping tail; when the slip is drawn out, then you will see him spread.

In some of these there is a slip each side of the fixed glass. In the popular slide called the rat-eater, a man



reclining on a bed is painted on the fixed glass, a lower jaw on one slip, which works up and down, and a rat on the other, which, as the slip is drawn, has the appearance of running down the man's throat. With the Sciopticon, the operator has hold of a slip with each hand, so he can jerk the rat back with a sudden movement of the forefinger, when he is all ready to make his appearance again as a new individual. In politics he might be called a "repeater."

### THE LEVER SLIDE.

Fig. 20 represents another popular, but a more expensive, mechanical effect. The horse having approached the water with his head up, the lever to the right is raised, and the horse is "*made to drink*" (the old adage to the contrary notwithstanding). The head and neck

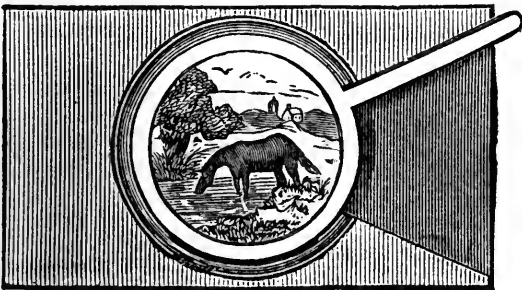

Fig. 20.

being painted on the glass moved by the lever, works up and down as on a pivot at the shoulders.

### REVOLVING FIGURES.

A movable disk corresponding to the one moved by the lever in Fig. 20, may be revolved by means of a rack and pinion; of this class is a variety of chromatropes,

mill-wheels, the movable astronomical diagrams, &c. Suppose a mill and the surrounding landscape painted on the fixed disk, and the sails on the disk revolved by rack and pinion, then on turning the handle, the mill appears in operation.

### THE CHROMATROPE.

Fig. 21 represents the pulley form of the chromatrope, but can give no idea of the dazzling brilliancy of the effects it produces on the screen. There is nothing it resembles so much as the kaleidoscope, with the addition of constant motion and rapid change. It consists of two disks of glass, painted with an almost endless variety of geometrical and other designs in brilliant colors. By turning the handle shown in the figure, the multiplying band causes the rapid revolution of one disk over the other, producing two apparent motions; and with good designs the result "beggars all description."

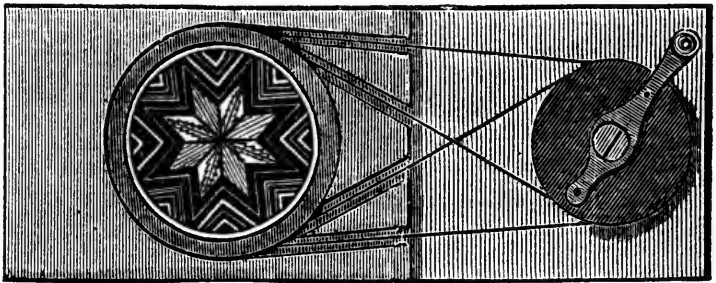

Fig. 21.

In another form the motion is accomplished by means of a double rack and pinion, instead of a band. As there are two disks, revolving one over the other, each is necessarily furnished with a toothed rack, and the one pinion works both.

### THE EIDOTROPE.

This valuable accessory to the magic lantern consists of two perforated metal disks, which, by an arrangement precisely similar to the chromatrope, are made to revolve one over the other. The effects are so beautiful as to excite surprise that they should be obtained by a mechanical contrivance of such extreme simplicity. By slow revolution, hexagonal, octagonal, and other geometrical figures are obtained, with delicate gradations of shadow; while a more accelerated motion produces the effect of stellate flashings, or scintillations of light. Color may be imparted by the use of tinted films of gelatine. Larger disks can be pivoted to a frame above the condenser so as to give an upward and outward movement to the scintillations as from a lower fountain. Stiff paper disks turned contrary ways by the hands at their edges will answer for practical experiments.

### MOVING WATERS.

Under this title two forms of slides are sold; by means of which, in a single or double lantern, very pleasing effects may be produced. In the simplest form a moonlight scene is painted on a fixed disk, and the "rippling waters" on a piece of glass attached by one corner only to the framework of the slide, which being moved up and down causes the appearance of a ripple on the water.

Another more expensive, but more truthful effect, is produced by a slide having two movable and one fixed disk of glass, and known as the "moving water with eccentric motion." In this slide, not only is the ripple produced, but the heaving of a boat upon the waves, the "rolling" of the sea, and the "hovering" motion of birds is imitated with surprising closeness to nature.

**LONG SLIDES.**

A very large class of paintings, on strips of glass 12 or 14 inches long, have come down to us from a former generation. Many of them hardly deserve attention, but some Nursery Tales, Natural History, &c., are fair, and the Astronomical set, in particular, is excellent.

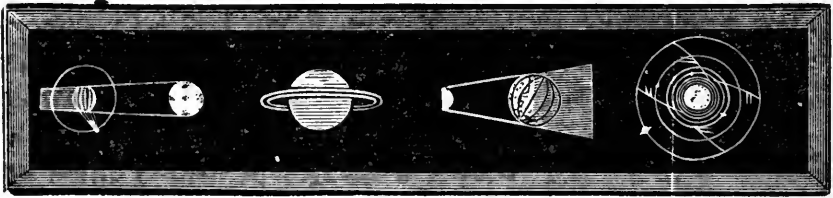
*Fig. 22.*

This set of ten astronomical slides, with forty-one illustrations, together with a set of astronomical diagrams with rack-work motion, makes a very complete outfit for a series of astronomical lectures.

**DIORAMIC PAINTINGS WITH MOVING FIGURES.**

In the middle of a glass strip (shaped and framed as in Fig. 22), a scene is painted, the rest being made opaque. Another glass strip, of similar size and shape, on which is painted along its whole length whatever is befitting, as figures, boats, &c., is made to pass in front in grooves, so as to represent a long procession; of this class, the children of Israel passing through the Red Sea is an example; or, the enterprising smugglers secreting contraband goods in the smugglers' cave.

**THE GHOST.**

A description of the modern "ghost" may be looked for here, but it is not strictly a magic lantern production.

A large plate of glass leans forward on the front of the stage, but its edges are so hidden by the curtains that its presence is not suspected. A "woman in white" stands down in front, concealed from the spectators by the usual board near the orchestra, and is highly illuminated by the light from a magic lantern. The spectators, in the darkness and distance, see the actors upon the stage *through* the glass, and also the *ghost* reflected *from* the glass so as to appear on the stage with the rest. The actors do not see the spectre, but they put on the appearance of fright for the *benefit* of the spectators.

The apparition vanishes as the light is withdrawn from "the woman in white." The lantern is used because it illuminates an object without diffusing light in other directions.

On this principle we may see people in a room through a window, with the reflected images of parties outside standing among them. It seems not a little surprising to see one person cutting through the space occupied by another.

#### THE TANK.

An excellent and cheap tank (similar to the one shown in Fig. 26), but with permanent clamps without screws, is now shaped so as to slide into the Sciopticon stage without drawing forward the extension front. As the space at the top is unobstructed, all sorts of experiments with it are easily managed. Living creatures encaged in it, in air or water, figure upon the screen in huge proportions, and with wonderful activity. Some fish and parts of many insects are so transparent as to show internal structure. Even opaque objects, when their outlines are sharply focused, appear in relief unlike a mere shadow. With almost every object thus shown, except

fish, up and down is a matter of indifference; so that inversion is no disadvantage. With this tank for the exhibition of living objects, chemical reactions, &c., a large assortment of slides is less of a necessity.

#### **PRECAUTIONS ABOUT SLIDES.**

The lantern exhibition has to be conducted in so obscure a light that the operator has to depend more on the sense of feeling than sight; it is therefore important that the slides should be in good condition and properly arranged beforehand, and that their titles and descriptions should be well fixed in memory.

A convenient box for carrying the slides, for arranging them in, and for showing them from, is constructed as follows: Two boxes of any desirable length,  $7\frac{1}{4}$  inches wide and  $4\frac{1}{4}$  inches deep, are hinged together, so that each serves as a cover to the other. This double box will hold the ordinary wooden mounted slides without waste of room, and when open will show their labelled edges in proper position and order.

In social gatherings, the exhibitor is often urged to bring out certain favorite pictures on call, which, in the hurry and darkness, is apt to disarrange the slides, so as to perplex the operator, and mar the beauty of the entertainment.

With careful management the box may close on properly arranged slides, at the close of the exhibition.

## CHAPTER V.

## P h o t o g r a p h y.

**GLASS POSITIVES FOR THE MAGIC LANTERN.**

BY JOHN C. BROWNE.

FEW entertainments for the amusement of children, as well as persons of mature years, give more real pleasure than exhibitions of the magic lantern. It is a never-ending source of pleasure, and doubly valuable to the disciple of photography, who by the aid of a few chemicals and very simple apparatus, can prepare interesting slides of local interest that will delight the home circle, and fully repay the small expenditure of time required for their manufacture. Every photographer has among his negatives many subjects, both portrait and landscape, that when printed upon glass will prove effective pictures for exhibition.

The object of this paper is to give in as few words as possible, plain directions for making positives on glass, suitable for the magic lantern.

Either the wet or dry process can be used. The former is more applicable in cases where it is necessary to reduce a negative to the proper sized positive required for the lantern. The dry method is used to advantage when the negative is of small size, and can be printed in contact. As all photographers are familiar with wet manipulations, we will consider that process first.

The only apparatus actually required, is an ordinary camera and lens, placed upon a board six feet long, in front of which a negative is fastened. This negative is simply copied upon a sensitive collodion plate, that is

exposed in the camera, carried into the dark-room, and developed, fixed, and toned.

If many positives are to be made from negatives of different sizes, it will be found convenient to arrange two cameras front to front (as will be seen in Fig. 23),

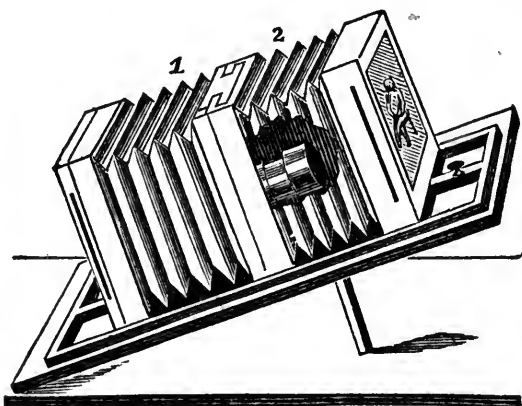

*Fig. 23.*

one camera having a lens in position with ground-glass No. 1; the other having the lens and ground-glass removed, and the negative that is to be copied placed in the position of ground-glass No. 3. The cameras, for convenience, can be closely joined together by screwing strips of wood upon each, which prevents any change of position when focused. By turning the rack-work upon each box, the picture upon the ground-glass can be made of any size.

This plan of using two boxes will be found to give perfect satisfaction; the negative and sensitive plates are always on the same plane, and the adjustment for difference of size made in a moment. It is only for convenience of manipulation, that the writer advocates this arrangement, for excellent positives can be obtained by using one camera, and placing the negative to be



copied in proper position in front of the lens, with nothing to shut off the diffused light between the lens and negative.

In selecting a position for operations, a north light will be found the best suited for the purpose. The upper window sash should be lowered, and the board upon which the cameras are arranged rested one end upon a table, the other upon the lowered sash, so that the negative will have the sky for a background. This is easily determined by focusing upon the ground-glass. It is advisable not to allow the direct rays of the sun to illuminate the negative. Should a north light not be obtainable, cover a frame with white tissue-paper, and let that be the background for the negative. The tissue-paper can be illuminated with the sun's rays, or by any artificial light.

It may seem to the reading photographer, unnecessary to burden this article with a complete chemical formula for making glass positives, but as it is prepared expressly for the uninitiated, it would be unintelligible without a formula.

*To make 8-oz. Sensitive Collodion.*—Alcohol 5 oz., ether 3 oz., iodide of ammonium 44 grs., bromide of magnesium 20 grs., cotton (Parys') 35 grs. Before using, filter several times through cotton soaked in alcohol. It is a good plan to keep a supply of plain, unexcited collodion on hand, as a stock-bottle; also, a bottle of exciting solution, made in the proportion of iodide of ammonium 5 grains, bromide of ammonium  $2\frac{1}{2}$  grains, to the drachm of alcohol. By adding 1 drachm of the solution to 1 ounce of plain collodion, it will be excited to the proper condition.

*Nitrate Solution.*—Water 1 ounce, nitrate of silver 40 grains; make slightly acid with nitric acid, C. P. Iodize

the solution by allowing a plate coated with excited collodion to remain in it over night. Filter.

*Developing Solution.*—Make a saturated solution of ammonia, sulphate of iron (in water); filter. To every ounce of this solution add glacial acetic acid, 1 drachm. This can be used as a stock solution, and will keep an indefinite length of time in good condition. Crystals will form in the stock-bottle, after standing some hours, but that is of no consequence, as the strength of the solution is correct.

In developing a plate, use 5 drachms of water to 2 drachms of ammonio-sulphate of iron from the stock-bottle. During hot weather use ice-water to retard the action of the developer.

*Fixing Solution.*—Cyanide of potassium or hyposulphite of soda; either will answer, but the action of cyanide appears to make a somewhat brighter picture.

These solutions being carefully prepared, the picture accurately focused, the negative (collodion side towards the lens) covered with a dark cloth, prepare the plate in the dark-room in the usual manner, place it in the dark-holder, in the position of the ground-glass, draw the slide (the lens is always uncovered), remove the cloth from the negative for a few seconds. The exposure will then be made. Cover the negative, shut the slide, and remove to the dark-room for development. The picture should appear slowly; not flash out upon the first application of the iron solution. Over-exposure, as well as over-development, are both fatal to transparencies. No trace of fog should be visible. From five to fifteen seconds will be found sufficient, on a bright day, with a negative of ordinary strength, and the chemicals in good order.

*The Negative*—Must be *sharp*, of good printing densi-

ty, and as free as possible from all defects. As the magic lantern slide is generally  $3\frac{1}{4} \times 3\frac{1}{4}$ , it is not desirable to employ a very large negative.  $6\frac{1}{2} \times 8\frac{1}{2}$  will answer the purpose better than a larger size. But negatives upon smaller glass will be found to give even finer results. On the other hand, it is very bad policy to attempt to enlarge a positive to double or treble the size of the original negative. The negative should not be smaller than the positive.

*The Lens.*—Any good portrait combination, of six to eight inches focus, quarter-inch stop, will work to advantage. Lenses of very short focus and very small opening, are not recommended.

*The Development*—Should be conducted with great care and judgment, as it is the most important part of the whole process. Rather underexpose and underdevelop, and as soon as the detail is visible, flood the plate with water, and check further action. Avoid an excess of light during development, and dread the appearance of the slightest fogging as the worst enemy to be encountered.

*Fixing Solution.*—Cyanide of potassium, after which wash well in running water.

*Toning.*—It is frequently of benefit to the positive that it should be toned, and at the same time slightly strengthened, to give contrast to the picture when projected upon the screen by a powerful light. Many chemical solutions may be used to accomplish this purpose. A weak solution of gold gives good results; also, a dilute solution of bichloride of palladium can be recommended. In either case the solution is flowed over the plate, after fixing. The positive is then dried and varnished.

*The Finished Picture*—Should be free from the slightest appearance of fog; the high-lights, the sky in land-

scapes (except when clouds are present), perfectly clear glass. The particular tone requisite to suit the positive, is a matter of taste. A warm sepia will be found suitable for most transparencies; but each operator must exercise his own peculiar feeling in this matter.

In making positives to be exhibited by the magic lantern, it is well to consider the variety of light to be used in projecting the picture upon the screen. Where powerful illumination, such as the oxy-hydrogen or magnesium lights are used, positives may be made slightly stronger, showing more contrast than where a weaker form of illumination is employed.

The slides should be protected from scratches and dust, by a piece of clear glass of the same size, neatly pasted on the edges with muslin.

Positives on glass can also be made by the wet process, from negatives of the proper size, by pasting a thin strip of cardboard upon two edges of the negative (collodion side). The sensitive plate is prepared as usual, and is placed, while in the dark-room, in close contact with the negative, separated only by the cardboard. It is then exposed behind the negative, to diffused sunlight or artificial light, for a few seconds, returned to the dark-room, and developed. This plan admits of no change in the size of the negative. Mr. L. J. Marcy's apparatus for printing wet plates by lamp-light, has given satisfaction to many who have not an opportunity of making experiments by daylight.

The proper size for glass pictures to be used in lanterns of convenient proportions, is a debatable subject. Glasses of  $3\frac{1}{4} \times 3\frac{1}{4}$  being generally used, but advantages are claimed for a slide  $3\frac{1}{4} \times 4\frac{1}{4}$ , that have some weight. In placing this slide in the lantern, the additional length of the glass allows the corners to be held by the thumb

and forefinger, without being visible upon the screen, as is sometimes the case with the square slide. Then again, it is easier to place in its proper position (right side up), having only one chance of error instead of three.

### A DRY PLATE PROCESS FOR LANTERN SLIDES.

#### TANNO-GALLIC PRESERVATIVE.\*

In considering the dry process, it is but proper to say that a large number of different formulæ have been published; in fact, scarcely half a dozen photographers think alike on this subject. It is, therefore, impossible to give a formula that will give universal satisfaction. In preparing this paper for publication, it must be distinctly understood that nothing new in the way of preservative or development is claimed; it is simply one of the many methods for preparing dry plates that has given reliable results.

The dry-plate photographer must be prepared for many and great failures, and be possessed of the greatest amount of patience and nicety of manipulation, for otherwise time is wasted, and the best process voted a failure. Commence with reliable chemicals, and follow up the process with a lavish expenditure of water when washing is mentioned, not only on the collodion plate, but thoroughly rinse the various glasses and dishes, and particularly the *fingers*, between each operation. Use as little light as possible when making or developing dry plates, and be careful that the light is yellow.

Probably more dry plates are ruined, and the particular process used condemned as worthless, by the use

---

\* I am greatly indebted to my friend, Mr. E. Wallace, Jr., for his kindness in furnishing me with the formula, and showing, by his own experiments, the valuable results to be obtained from this process. J. C. BROWNE.

of white light than from any other cause. A square-sided lantern, having the white glass removed, and yellow substituted, will be found very convenient; either gas, a candle, or kerosene can be used for illumination.

To prevent the collodion film slipping from the plate during the process, it is absolutely necessary that the glass plate should be albumenized. Wash the glass (having previously roughened the edges), drain, and while wet flow over it the following solution :

Albumen (the white of an egg), . . . . .	1 egg.
Water, . . . . .	1 pint.
Concentrated Ammonia, . . . . .	10 drops.

Put the albumen in a clean bottle, then add the water. Shake a little, and add the ammonia; filter through a sponge; dry in a rack.

#### COLLODION.

Any reliable collodion will answer; it is best to have it quite thick. No backing is necessary.

#### NEGATIVE BATH.

Nitrate of Silver, . . . . .	45 grains.
Water, . . . . .	1 ounce.

Made slightly acid with nitric acid, C.P. Dip the collodionized plate in the bath, and when properly excited, remove the plate, and dip in a bath of pure water; then wash under a tap with running water. While wet apply the

#### PRESERVATIVE SOLUTION.

Tannin, . . . . .	10 grains.
Gum Arabic, . . . . .	6 "
Sugar, . . . . .	4 "
Water, . . . . .	1 ounce.

Filter, and add one drachm per ounce of

Gallic Acid, . . . . .	24 grains.
Alcohol, . . . . .	1 ounce.

The preservative must be fresh. Three ounces of this mixture will prepare half a dozen  $6\frac{1}{2} \times 8\frac{1}{2}$  plates.

If the preservative is poured over the plate, apply twice, working it well into the film; throw the first *dose* away, and use the second flowing for the first application to the next plate.

The plates must be carefully dried, either by natural or by artificial heat; a hot-water bottle will be found useful for that purpose should artificial heat be thought best.

THE EXPOSURE

Will depend upon the strength of the negative, and the nature of the light; a few seconds will generally be enough. *Close contact* is absolutely required to produce sharp positives. An ordinary printing-frame can be used.

TO DEVELOP

In a dark-room, remove the dry plate from the frame, place it in a dish, and flow over it

Alcohol, . . . . .	} equal parts.
Water, . . . . .	

Then wash in running water.

DEVELOPING SOLUTIONS.

Pyrogallic Acid, . . . . .	2 grains.
Water, . . . . .	1 ounce.

Made from a stock-bottle of

Alcohol, . . . . .	1 ounce.
Pyrogallic Acid, . . . . .	96 grains.

Five minims of this solutions contains one grain of pyro.

## ALKALINE SOLUTIONS.

Carbonate of Ammonia, . . . . .	64 grains.
Water, . . . . .	1 ounce.
Bromide of Potassium, . . . . .	4 grains.
Water, . . . . .	1 ounce.

Mix together.

After the plate is well washed, flow over it a solution of

Pyrogallic Acid, . . . . .	2 grains.
Water, . . . . .	1 ounce.

Then pour back again into the measure. Should the image be developed by this solution, proceed very cautiously, and add a few drops of the alkaline solution of carbonate of ammonia and bromide of potassium. If the picture comes out slowly, add more of the alkaline solution up to thirty drops, if necessary, and also a sufficient amount of stronger pyro to bring out all the detail. When the image is out, wash with water, and intensify with

Pyrogallic Acid, . . . . .	2 grains.
Water, . . . . .	1 ounce.

To which is added ten drops of citric acid and nitrate of silver solution.

Citric Acid, . . . . .	30 grains.
Nitrate of Silver, . . . . .	20 "
Water, . . . . .	1 ounce.

This is a stock-bottle. Mix in separate glasses; add together and filter; wash.

## FIXING SOLUTION.

Hyposulphite of soda.

## TONING SOLUTION.

The same remarks applied to wet positives will answer for toning dry plates.



**THE COLLODIO-CHLORIDE PROCESS.**

(From Humphrey's Journal.)

The following formula is not only used for opal pictures, but to some extent for transparencies also.

1. Take the whites of two eggs and two ounces of water, beat well to a froth, and let it settle for two hours and pour off the clear solution.

2. Coat your white plate with this solution (as you would with collodion), and set away to dry. When dry take in your dark-room and coat the plate with the "opal solution," which is made thus:

Plain collodion 8 oz. (thinner than you would use for iodizing), then dissolve in as little water as possible 60 grains nitrate of silver, and add this to the collodion and shake well. Then dissolve 16 grains of strontium in as little water as possible, and add this to the collodion and shake well. Then dissolve 10 grains citric acid in as little water as possible, and add to the collodion. Shake well, and you have the opal solution.

When dry, put your negative in the printing-frame, lay the opal-prepared plate on the negative, and print from 10 to 15 minutes in the sun, and print much darker than you would a photograph.

Tone and fix as you would a photograph, only you need not wash before toning—and wash but little before fixing. The "opals" tone in one-tenth the time of a photograph.

Keep the opal preparation in a dark-room. Have your toning bath a little alkaline, and not as strong as for toning photographs.

**MARCY'S PHOTOGRAPHIC PRINTING APPARATUS FOR  
PRINTING WET PLATES BY LAMPLIGHT.**

This apparatus is intended to simplify the process of printing lantern transparencies. Its rationale will be seen at a glance.

Sharp photographic printing without a camera, can be effected, either *by having the negative in actual contact with the sensitive plate*, however widespread the light, or else *by having an intense light proceeding from a single point*, though the plates may be wide apart. In the latter case the point of light should be distant compared with the space between the plates, to avoid enlargement. A sharpness above criticism is produced by this printing apparatus, not by an absolute compliance with either condition, but by an approximate observance of both.

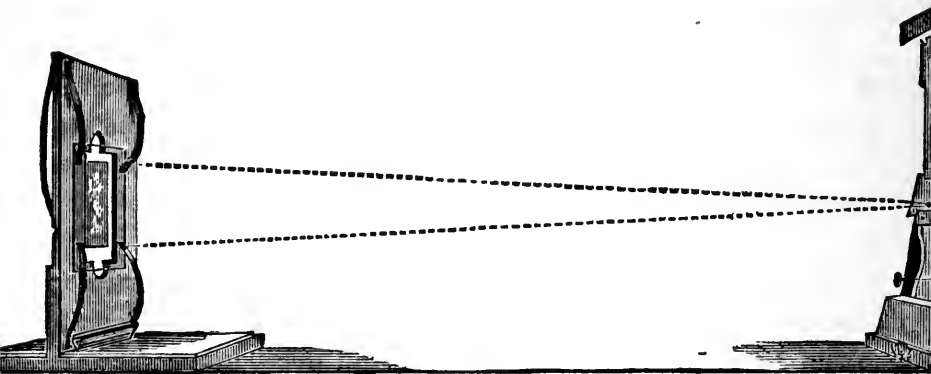

*Fig. 24.*

It consists of an upright frame in which the sensitive plate is held slightly separate from the negative, and a coal oil lamp, from which the light of a wide flat flame is emitted through a narrow horizontal slit—small and at considerable distance from the frame to produce a sharp print, and in range with the long diameter of the

flame to get intensity from a single point. A narrow strip of glass sets into this slit as between two lips. The thickness of the flame gives the horizontal diameter of the point of light. Only the front of the lamp is shown at the right of Fig. 24, but it can be seen how the light from the whole width of the flame reaches the printing-frame through the narrow aperture.

At the left, we see how the negative is held over the opening in the frame by four springs; the long spring on the opposite side holds the sensitive plate in the frame.

The operator, standing on the opposite side, with the upper corners of a quarter plate, just from the bath, between his thumb and finger, and shading off direct rays with his left hand, places it in its silver bearings; this brings the two films almost in contact.

The lamp and frame stand from 16 to 26 inches apart, or so far as to require about two minutes for the printing, or the time it takes for a round of the other manipulations and changes; so a picture is finished and dropped into grooves in a trough of water as often as one has had time to print.

All that is said in the previous article on the wet-plate process, in regard to development, &c., applies here. Any drops of silver bath that may have come in contact with the negative must be washed off before it is put away.

Like dry-plate printing, the negative must be of the exact size required for the lantern slide.

Some of the advantages of this method are :

1. It can be practiced evenings or in cloudy weather.
2. The light is inexpensive.
3. Plate glass is not a necessity.

4. The apparatus may stand within reach of the operator.

5. It requires no previous preparation more than having clean glass, and chemicals in good working order.

6. The albumen coating is not required to make the film adhere.

7. The amount of exposure can be definitely gauged.

8. The illumination is confined to a narrow cone, so as not to fog the picture by diffused light.

9. The exposure is so immediate and uniform as to escape many accidents.

10. It is so easily done, that many causes of failure involved in a long process are not encountered.

11. The negative is not marred by use as in contact-printing.

12. This apparatus complete costs but seven dollars.

Thus we have in it advantages by the dozen.

#### **THE SCIOPTICON PROCESS.**

By placing the Sciopticon near a wall, in a dark room, and drawing forward its extension front, an image of a negative may be projected into a three-inch circle. First focus sharply on a paper-covered glass, and then expose a wet plate in the same place a minute, more or less, developing and fixing as usual, and we have a glass positive photographed by the Sciopticon for the Sciopticon.

The objective is always used with full opening, because all the light is needed, and because it will not give an evenly illuminated disk with a small stop; so we cannot secure perfect sharpness to the very edges. It answers well, however, for central figures, and the photographer can easily produce unexceptionable positives from his

portrait negatives. There seems no reason why enlargements made in this way, for *ornamental transparencies*, to be hung in the window, or set in a frame, should not become a profitable branch of photography.

The toning of glass positives, to be used for ornamental purposes, involves some thought as to the particular color, or shade of color, that will suit the picture best; and it is impossible to give one process that will suit all tastes alike; some having a preference for black tones, others for blue-black, brown, or the various shades of gray. A detailed description of the manner of producing these various tones would require too much space, and is so simple that no one can go astray.

The principal chemicals required are: Chloride of gold, bichloride of platinum, bichloride of palladium, sulphide of potassium, and permanganate of potassium; in all cases use singly and very dilute. I am disposed to consider chloride of palladium as the most reliable chemical that has come under my notice. Its action is perfectly manageable, easy to prepare, will not stain, and gives uniformly good results. The toning solution that I use is made as follows: Add six drops from the stock-bottle of chloride of palladium to each ounce of water; this solution should be of a delicate straw color. No other manipulation is required. After the plate has been developed and fixed, wash as usual, then apply the toning solution by flowing it over the plate similarly to the developer. Its action will be quick, giving a black tone to the positive. Wash well, dry, and varnish if desirable.

These transparencies are covered and bound with an opal or ground-glass, or they may be flowed with a varnish containing a little fine zinc paint, ground in varnish. It may be mentioned in this connection, that artists

find the Sciopticon very useful in *sketching their pictures*. Having first obtained a glass positive or negative of the subject to be painted, it can be thrown upon the canvas of the size desired, and expeditiously and accurately traced. It saves valuable time to the good artist, and it prevents the poor artist from producing distortions.

### **WOODBURY PHOTO-RELIEF EXCELSIOR LANTERN SLIDES.**

By JOHN C. BROWNE.

While it is a comparatively easy matter to produce fine positives by either the wet or dry process of photography, yet the results are liable to vary somewhat even in the hands of the most careful manipulator. The Woodbury photo-relief process, as now worked in Philadelphia, has the merit of distancing all competition in the uniform excellence of its lantern slides. It would be a pleasure to give in detail a description of this wonderful process, did space permit, commencing with the sensitive gelatine tissue, resembling in appearance a piece of patent leather, and following it in its exposure to light under a negative, the light's action rendering insoluble those parts reached through the negative; its subsequent immersion in hot water dissolves out those parts not rendered insoluble, producing a relief as thin as writing paper, which when dry is pressed into a piece of soft metal by a hydraulic press of fabulous power, forcing this delicate substance into the smooth metal, and leaving upon its surface a counterpart or mould of all its finest lines and half tones. Strange to say this flimsy gelatine relief is not crushed to atoms by this

treatment. It is not damaged in the least, but ready to make its mark again as often as it is necessary.

This leaden mould is the type that prints the picture, a solution of gelatine and India-ink being poured over it before the glass is placed in position.

A slight pressure is given in a press of peculiar construction, squeezing out the surplus ink; a few minutes is allowed the ink to set, when the glass, being removed, brings with it the delicate gelatine picture, which is well named "Excelsior."

---

## CHAPTER VI.

### COLORING SLIDES.

WRITTEN FOR THE SCIOPTICON MANUAL.

THE magic lantern has caused much astonishment and delight from its origin to the present time. The pictures or slides for it were formerly drawn or painted on glass, and when magnified by the lantern lens, even the most minute lines looked coarse, and every imperfection was brought out. Much time and care, therefore, were requisite to make fine pictures, so that they were comparatively rare and expensive, while the coarser ones abounded; thus the lantern came to be regarded as a toy, fit only for the amusement of children. An instrument, however, so well calculated to aid in the advancement of science and education, on account of the size of the diagram that may be represented on the disk, and the fact that the attention of an audience is better secured when the only object visible is the dia-

gram under explanation, was not to be thrown aside as a toy.

Photography, by its wonderful sun paintings on glass, reproduces the works of the old masters, furnishes views of every land and clime, of customs, manners, works of art, and pictures, or diagrams, to illustrate every science, the beauty of which, when colored and thrown upon the screen, however great the magnifying power used, is not diminished, as was the case with the paintings formerly used. With beautiful and desirable pictures, and with improved lights and instruments, the lantern now takes a front place in Sunday-school work, in the school, the lecture-room, and the home, and is gladly welcomed wherever visible illustrations are used, or beautiful pictures prized. While the stereoscope presents the life-like photographs to the individual observer, the lantern enlarges the same views, so that many may see and enjoy at the same time the same beautiful scenes together, making it well suited to the social gathering and entertainment of friends. Families may have slides prepared containing pictures of family residences, of members of the family, of favorite dogs, horses, &c., thus increasing the pleasures of home, and social intercourse.

The coloring or painting of slides for the magic lantern has been confined to comparatively few artists, the great care and nicety of execution required, making it a difficult art to attain, while the old preparation of varnish colors placed difficulties in the way of even the most practiced artists.

Water colors are now prepared expressly for painting on glass, so that any one possessing a moderate knowledge of drawing, with some skill in the use of colors, may succeed. None but transparent colors, or those through which light is transmitted, can be used, making



the number of colors available for painting on glass necessarily limited. The most valuable for this purpose are the moist water colors procurable in metallic collapsible tubes: for yellow, Indian yellow, Italian pink, and yellow lake; for blue, Prussian blue and indigo; for red, madder lake, crimson lake, and scarlet lake; for orange, burnt sienna; for brown, madder brown, Vandyke brown, sepia, and burnt umber; for black, India-ink and lamp-black; for purple, purple lake, or red and blue mixed; for green, mix yellow and blue; for scarlet, red and yellow. A white porcelain palette, free from specks and grit, is the best upon which to mix and arrange the colors. Use soft water for mixing the tints. For cake colors, use a weak gum water, taking care to have it quite dilute to prevent the colors cracking or peeling off; place each tint on a separate slab or saucer.

A suitable easel for holding the glass to be painted, is shown in the diagram (Fig. 25); this is a sloping frame, holding a sheet of glass, so arranged that it can be placed at any angle, and any convenient height for the artist.

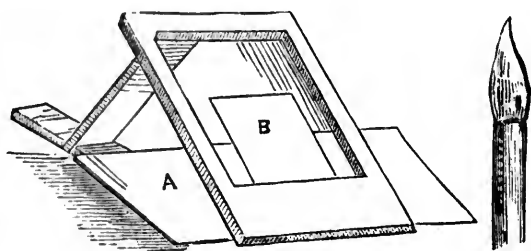

*Fig. 25.*

The glass or photograph to be painted, should be placed upon the clear glass in the frame (as shown at *B*). Upon the base board (*A*) is spread a sheet of pure white paper to reflect up the light through the painting; the light should fall on it from the left hand, and is best obtained

from a window facing the north sky. Glass has a smooth and a rough side; the smooth side is that on which the drawing is to be made; it may readily be determined by drawing the finger-nail over the surface. The glass should be carefully cleaned with water, to which a solution of ammonia has been added. A fine brush, or cheap gold pen, may be used for drawing outlines, which should be made with colors suited to the part of the painting for which they are to be used; the foreground being drawn with bolder lines than those more remote.

One of the most difficult things to accomplish in transparent painting on glass, perhaps, is to lay on a uniform tint, free from lines or specks; as a clear blue sky without clouds. The brush should be well charged with the blue tint, and the color spread or floated upon the glass as evenly as possible, and afterwards equalized by a careful application of the brush dabber: that is a camel-hair brush cut down (as shown in Fig. 25), the edge of which being afterwards passed through a flame so as to remove any straggling hairs. The finger, also, may be used as a dabber, and when used with dexterity, is very effective. To take out the necessary lights, as those of clouds, and to soften the edges, a stump made of leather or paper may be used. In coloring photographs the outline and shading are provided; so that flat washes of color are to be laid on, and then retouched and improved; avoid covering the deepest shadows, thus destroying their transparency. Breathe on it sufficiently to moisten the colors, and carefully blend and harmonize the tints; commence with the sky, then the middle distance should be worked out, lastly the foreground. As the pictures are necessarily small, a magnifying hand lens, such as is used by artists for fine work, is desirable to assist one in coming close to the lines with washes of color.

The brushes should be sable, of moderate size, and soft to the touch, and when charged with water, come to a good point without straggling hairs; some prefer a flat brush instead of a round one. It is well to have a sufficient number of brushes, and to use a different one for each tint. A piece of cloth should be used for cleaning brushes and dabbers, as neatness is very essential to success. An ordinary round-pointed pocket knife will be found useful for removing color. Etching-needles may be used for making minute touches of light, as on spears of grass; winter, snow, spring, and moonlight effects are produced chiefly by the skilful use of the knife and needle-points, to remove the color and produce strong white light in the picture. As pictures vary much in style, it would be difficult to give directions which would apply to all. Beginners should copy well-painted lantern slides at first, as this would guide in the colors to be used. Practice on waste pieces of glass and noting the effect in the lantern, would also prove beneficial and accustom the artist to regulate the tones of the picture in the best manner. When the picture is finished, it should be protected by a thin transparent varnish, such as photographers use, or a thin coat of Canada balsam. To prevent scratching, a glass, the same size as the picture, should be laid over it; and to prevent injuring from contact, a narrow rim of paper should be interposed between the glasses; they can then be bound or framed.

“Aniline colors have been used for photographic views with some success. They are brilliant and transparent, but require careful use to prevent the tints running one into the other.”

Comic slides are often painted in a coarser manner, and oil paints are used. The method is very similar to

that given for water colors: the same kinds of brushes, dabbers, and the same list of colors are used. The paints employed are sold in tubes; mastic varnish diluted with turpentine is used as a vehicle, sugar of lead as a drier. Comic or slip slides are generally painted on two pieces of glass, one of which is firmly fixed in the frame, the other movable; these glasses are so adjusted, that when the sliding glass is pulled out, an effect is produced which differs entirely from that shown when the glass is pushed in; as, for example, "The Windy Day;" the lady is seen passing along, fashionably dressed and equipped; the slip being drawn, she is shown in sad plight by the turned parasol, loss of false hair, bonnet, &c.; or a beautiful lily or tulip is seen; the slip is drawn, and a lovely fairy seems to float up from the flower. Chromatropes are constructed of two circular pieces of glass painted from the centre to the circumference of the circle with variously tinted rays and patterns, these are framed in brass frames, having grooves around them turned face to face, and when made to revolve reversely throw out beautiful and brilliant hues; according to the way in which they are made to turn, they expand or contract.

Statuary gives a much better effect, if the glass around it is covered with some opaque paint. Lampblack ground very fine with mastic varnish, a few drops of oil of cloves, and then brought to the right consistency with turpentine, is perhaps the best, as it does not rub off. "Opaque," an article manufactured by Mr. Gihon, of Philadelphia, is more easily applied, being used with water, and answers every purpose.

Figures which appear on the screen as black shadows, may be painted on the glass with these materials; or, to produce the same effect, designs may be cut from paper

and pasted on the glass. Glass may be smoked or covered with opaque paint, and diagrams scratched upon it with a needle-point or sharp knife; the light passing through these lines appearing on the screen as a white chalk diagram on a blackboard. Still another way of preparing diagrams is to dissolve gelatine, such as is used in cooking; strain, and pour it over the glass, forming a thin film on its surface. When this is dry, the diagram is scratched on as before, and soft lead rubbed over the lines. Mottoes may be photographed on glass, and then colored, or the designs drawn with the pen or brush, and colored.

The Sciopticon is extremely well adapted for experiments and amusements, as its front lens can be drawn out, giving ample space for the introduction of figures and such like. Small china and wooden dolls, with but slight tissue-paper dress, may be made to twirl or move about in many curious ways; those with perfect faces are the best. They of course must be suspended by a silk or wire attached to the feet; but a hint is sufficient. Lizards, fish, and insects in the tank are always pleasing because they move. When one has but few slides, the entertainment may be varied by introducing some of the home-made objects, thus affording much amusement, with but slight expense and trouble.

---

## CHAPTER VII.

### CHEMICAL EXPERIMENTS.

CONTRIBUTED BY PROF. HENRY MORTON, Ph. D.

*President of the Stevens Institute of Technology, Hoboken, N. J.*

IN addition to the use of the magic lantern in its original office of exhibiting pictures, it will admit of a great variety of applications which enable the operator

to produce countless variations in the effects developed, by which an endless variety and constant novelty can be secured.

For this purpose there is needed in the first place the

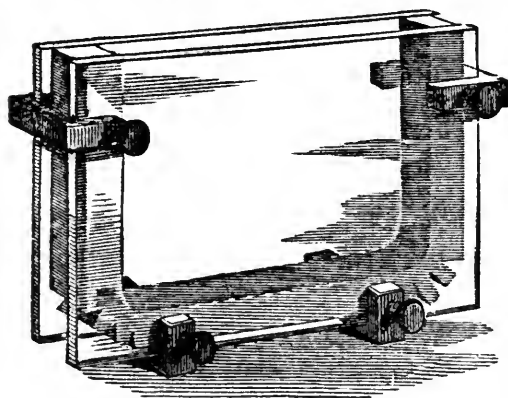

*Fig. 26.*

simple apparatus shown in our wood cut, consisting of a small tank, made by securing two plates of glass, about 4 x 5 inches, with four clamps, against a strip of rubber about  $\frac{1}{2}$  inch thick, bent into the three sides of a rectangle

and notched at the corners to facilitate its bending.

We then require one or more glass pipettes provided with elastic balls, such as are made by the rubber manufacturers. This little apparatus is shown in Fig. 27, where A is the rubber ball, B the glass globe of the pipette, and C its point drawn to a moderately fine orifice.



*Fig. 27.*

A few small pipettes made by simply drawing short pieces of glass tube to a fine point, are also useful.

In addition, a few bottles with such ordinary chemicals as will be mentioned further on, will complete the outfit.

Having placed the tank, three-quarters full of water, as an object in the lantern, a number of chemical reactions can be shown, as follows:

**Experiment 1st.** Pour in a little solution of sulphate

of copper, and mix it well with the water of the tank, then with the pipette run in, with more or less force, some diluted ammonia, pausing from time to time to observe the progress of the effect. On the screen will be observed the gathering of a tempest of black storm-clouds, which twirl around in violent commotion, as if urged by a tornado of wind, but as the action continues, these clouds will melt away, and leave the entire field of a serene and beautiful sky-blue.

By now throwing in some diluted sulphuric acid, the same changes can be reproduced, and so on alternately for a number of times. Then when the tank is clear, with an excess of acid, let fall a few drops of a solution of ferrocyanide of potassium from a small pipette, and rich red curdled clouds of ferrocyanide of copper will form with a beautiful appearance.

Experiment 2d. Having rinsed the tank, or taken a fresh one with water in it as before, add to this some solution of litmus, until the whole acquires a purplish-blue tint. Now throw in very gently a little very dilute acid, and allow it to diffuse. On the screen will appear the image of a beautiful sunset sky, with its changing tints of drifting clouds.

When all has changed to red, add ammonia, and so reverse the change, which may then be repeated.

Experiment 3d. Proceed exactly as in the last case, but with a solution of cochineal in place of litmus. The red color will then be changed by the acid to a brilliant yellow, and by ammonia to a rich purple.

Experiment 4th. Into a tank of water drop slowly a strong solution of the acid perchloride of tin. This on the screen will resemble the eruption of a submarine volcano.

When a pretty strong solution has thus been made in

the tank, put in it a strip of sheet zinc, and long leaf-like blades of metallic tin will at once be seen to shoot out in all directions.

Experiment 5th. Make a concentrated solution of crystals of urea in alcohol of about 95 per cent. (The common 85 per cent. alcohol will not answer.) Let a few drops of this fall on a glass plate, and with the finger spread it rapidly over the surface, and then at once place it as an object in the lantern. After about a minute, blow gently on the plate with a bellows (not with the breath), and at once on the screen will be seen the growth as of frost crystals shooting over the field in all directions.

Experiment 6th. If sulphate of copper in solution is mixed with enough gum-arabic water to make the solution form a continuous film, when flowed like collodion on a clean glass, and such plates are allowed to dry slowly in a nearly horizontal position, a very beautiful crystalline vegetation will set in, which varies in its character with the proportion of gum used, and will make objects well fitted for exhibition with the lantern.

In place of sulphate of copper, we may use nitre, or ferrocyanide of potassium, with the production of an entirely new class of forms.

By placing the plates so covered with crystals over a leaden dish, in which is a little fluor-spar, moistened with sulphuric acid, and warmed slightly (giving off fumes of hydrofluoric acid), permanent etchings may be prepared, which are also very beautiful objects for the lantern.

These are only a few of the experiments of this character which can be performed with the lantern, but they will indicate the direction in which each one can be a discoverer and inventor for himself.



**MISCELLANEOUS EXPERIMENTS.**

THE SCIOPTICON TANK (Fig. 28) is free from projecting clamps and so passes freely upon the stage in front of the condenser. It serves as a dry cage for insects, &c., a cell to show liquids and life in water, a tank for the exhibition of chemical reactions, and with wires protected and bent over the ends it can be used in connection with a galvanic battery. It is the most convenient for the preceding experiments, as well as for these which follow.

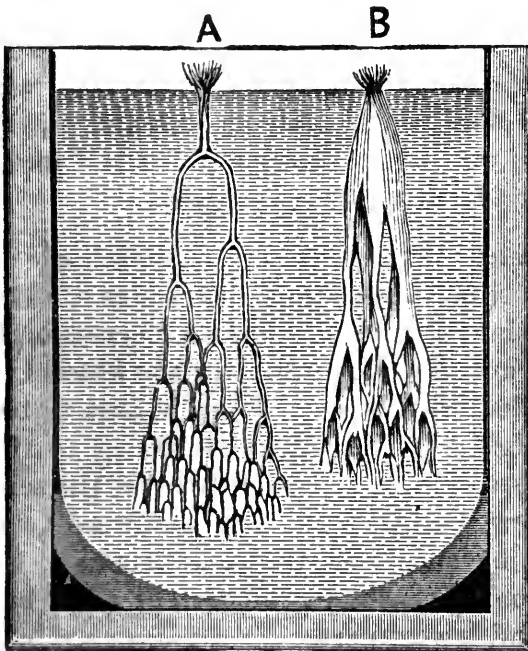

*Fig. 28.*

**COHESION FIGURES.**—The cohesion figures known as Tomlinson's are both interesting and beautiful, and can be shown as follows: Fill the tank to within half an inch of the top with alcohol and slide it into place upon

the stage; now with a glass rod, or small brush, dipped in any of Judson's aniline dyes, touch the side of the tank gently, so as to leave a drop on it. This drop, directly as it touches the alcohol, will go straight down for half an inch or so, and then break out into two branches; these again will break in four, and so on, until by the time the dye gets to the bottom of the tank it will have formed some hundreds of delicate branches. As this action is reversed on the screen, the branches appearing to shoot upwards, the effect is much heightened. *A* (Fig. 28), shows the form assumed. By placing at intervals of half an inch drops of different colors, as their branches commingle, the effect reminds one of a shower of different colored rockets. If we now take another tank, and fill it with coal oil, and put a drop of fusel oil into it, we get an entirely different figure, as shown at *B*. The fusel oil is best colored.

**CAPILLARY ATTRACTION** can be strikingly shown to a large audience. A series of glass tubes of different sizes are fitted into a piece of wood which rests on the top of the tank, and dips down to near the bottom; when the tank is filled with water, which is best tinted, the different heights of the water, according to the fineness of the tubes, will be shown clearly on the screen. The curve shown by the liquid rising between two pieces of glass can be shown in the same manner, the colored water forming a pretty gradation of color between the highest and lowest part.

**CRYSTALLIZATION.**—By filling the tank with a saturated solution of Glauber's salts, and allowing it to cool, it will appear transparent on the screen, but by dropping one small crystal into it the whole mass will be seen to shoot out into beautiful crystals.

The crystallization of many other substances, such as bichromate of potash, alum, &c., and the precipitation of iodides of silver, mercury, and other salts, all form beautiful objects on the screen.

**THE DEVELOPMENT OF A PHOTOGRAPH ON THE SCREEN.**—For this we require a tank with one of its faces of yellow glass, which side should be next the condenser. Place a small statuette in the rays of the lantern, and having prepared a small plate with collodion and sensitized it, expose in the camera for about a minute; then, having filled the trough with developing solution, place in it the slide, and as the development proceeds the image will gradually appear on the screen. A transparency might then be made from this, and, after drying, shown on the screen, thus illustrating the formation of a photographic lantern slide.

**CHANGING COLORS.**—A glass coated with a mixture of gelatine and chloride of cobalt, when placed in front of a slide, will give a rosy effect to the picture, which, however, from the effect of the warmth of the lantern, will gradually change to purple and then to blue. On becoming damp again it will resume its red color, and can be used over and over again.

**COMPLEMENTARY COLORS.**—A number of beautiful effects, showing complementary colors, may be obtained with the Sciopticon. If we insert a piece of green glass, having any design cut out of black paper and pasted on it, we shall see on the screen a black design on a green ground; but by bringing another light into the room or turning up the gas, the black design will at once appear to the eye as a brilliant pink.

By making apertures in a card slide, as circles, squares,

or diamonds, say a fourth of an inch in diameter, and covering them with bits of colored gelatine, or by simply using the tinters of the Sciopticon, many curious effects in complementary colors may be obtained.

**FAIRY FOUNTAIN.**—The effect of what is known as the “Fairy Fountain” can be prettily illustrated in the following manner: A small table fountain is placed at a distance of about four feet in front of the lantern; by curtains or otherwise the lantern is then hidden from the spectators, so that they see only the fountain illuminated by the rays coming from the lantern. When the fountain is made to play, every drop seems transformed into a diamond, and by passing colored glass in front of the lantern the effect is striking and beautiful; but when the rays from a bisulphide of carbon prism are allowed to fall on it, then is the best effect produced.

**THE RAINBOW.**—A card with a curved slit, one-sixteenth of an inch (Fig. 29), will throw on the screen a

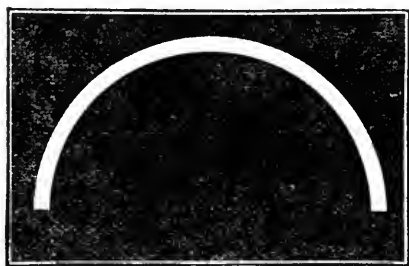

*Fig. 29.*

simple semicircle of white light; but when a prism is held in front of the objective, the bow at once assumes all the natural colors of the rainbow. As the direction of the rays is changed, the range of the instrument has to be

elevated, to bring the bow upon the screen. By using two lanterns, projecting a view with one and the bow with the other, a very natural effect may be produced.

**A MAGNET AND IRON FILINGS.**—Fix a small magnet to a glass slide, and carefully arrange a funnel opening

above the poles in the lantern; then allow iron filings to fall gently down the funnel, which will appear like large blocks attracted upward by a huge magnet.

**ASTRONOMICAL CARDS.**—The cards may be cut to the size of the crystal slide, that is  $3\frac{1}{4}$  by  $4\frac{1}{4}$  inches, so as to be used in the grooved frame, like an ordinary glass slide. After correctly dotting a constellation of stars (which may be done by the use of theorem paper and a good map of the heavens), pierce the card at the several points, say with a darning needle, which may be made to show stars of different magnitudes by gauging the depth of the insertion.

To illustrate the Solar System, punches of different sizes might be used and bits of colored gelatine, covering the aperture, might indicate the tints attributed to each member.

**PINHOLE OUTLINES.**—Cards in shape of glass slides and just thick enough to be sufficiently stiff, may be pricked to show maps, mottoes, figures, diagrams, or any simple illustration. They require but little skill and show very distinctly.

**PERFORATIONS.**—Two pieces of perforated paper or tin made to slide little by little over each other, in front of the condenser, and modified more or less by the tinters, produce beautiful symmetrical forms in great variety.

**PERSISTENCE OF VISION.**—Apertures, as in a paper card, when moved rapidly in all directions in the plane of the slide, appear as lines of light on the same principle that a lighted stick waved about produces lines of light. A new slide, called the kaleidotrope, is constructed and hung to exhibit this curious effect.

**THE PHOTODROME.**—The photodrome, as shown at the Polytechnic, may be made at a very small expense. To produce this effect we require a rapidly moving disk (having one or more slits cut in it) revolving in the place where the slide is placed, and also a larger one placed at some distance—the latter representing a wheel, the spokes of which are painted in black on a sheet of white cardboard. When this is made to revolve rapidly in the rays coming from the lantern, all trace of the spokes will be completely lost; but on causing the small disk to revolve at nearly the same speed as the larger, the latter will appear to be moving slowly, although moving rapidly, and by increasing the speed of the smaller wheel, the larger will gradually appear to slacken in speed until it appears to be motionless, and then apparently begin to move in an opposite direction to which it is really revolving.

**SILHOUETTES, &c.**—Paper patterns, silhouettes, &c., suspended by a thread attached to the feet, and twirled before the condenser, give a very amusing and curious effect.

**GALVANIC ACTION.**—Fill the tank with a solution of nitrate of silver, and introduce at each end two wires from a small battery; from one of the wires a beautiful silver tree will immediately begin to grow. The experiment may be varied by substituting acetate of lead for a lead tree.

Litmus solution, neutralized, will gradually redden around one point, while around the other it will assume a blue tint.

With a solution of cochineal, the red color will be changed by the acid to a brilliant yellow, and by the ammonia to a rich purple.

NATURAL OBJECTS, as leaves, plants, fibres, texture of cloth, thin sections of wood, bone, &c., appear in distinct outline upon a white ground. Live animals in the tank, as insects, larvæ of gnats, shrimps, worms, lizards, &c., appear as huge monsters upon the screen, and excite a lively interest by their eccentric movements.

VERTICAL LANTERN.—Some very interesting experiments require the slides to lie in a horizontal position. This is commonly effected by reflecting the light up through the glass plate and the objective lens, and then by another mirror reflecting the image horizontally to the screen. A lantern appendage of this sort is now in the trade, at \$20.

But this is equivalent to placing the slide at least four inches from the face of the condenser, which, at best, puts it at great disadvantage, and then there is the loss of light by two reflections.

The oil light cannot well bear these drawbacks, the lime light is better; but with the lime light the Sciopticon may be placed on end, as shown at Fig. 30.

When attached to its carrying box, in the ordinary way, it may be held in this position over the edge of a table, so as to be conveniently operated. The front flame-chamber glass will protect the condenser from its greater liability to become heated.

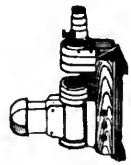

Fig. 30.

A glass disk, clean cut, and slightly larger than the condenser, answers for the slide plate; and if a rubber band be stretched about its periphery, like the tire of a wagon wheel, it will become a tank for fluids.

With this arrangement, a mirror at an angle of  $45^{\circ}$  above the objective will throw the effect upon the screen without appreciable loss of light.

**RIPPLE WAVES.**—Fill the tank, as it rests on the vertical lantern, with clear water, when taps on the edge of the glass will start ripple waves, which will be seen on the screen in varied harmonious arrangements of form.

Touching the surface with the point of a fine wire will start the waves in circles. Vibrations effected by drawing a fiddle bow across the edge are seen to vary according to the different tones produced.

**ADHESION FIGURES.**—Drops of various oils upon the surface of the water, essential oils for instance, will exhibit various interesting adhesion figures, each oil assuming some peculiar form of outline.

**MAGNETIC CURVES.**—A thin bit of magnetic steel, say three-fourths of an inch long by one-eighth wide, cemented on the under side of a glass plate, will attract fine iron filings scattered upon the plate into curves, illustrating the deviation of the magnetic attraction at either pole and the neutral axis in the centre of the magnet. A few taps on the glass will assist the arrangement.

---

## CHAPTER VIII.

### *Descriptive Lectures.*

#### **CONCERT EXERCISES.**

THE value of visible illustrations as a means of imparting instruction, and of affording rational entertainment, depends much on the accompanying oral explanations.



Except to a very limited extent, it is not practicable (as many seem to suppose it is), to forward with a miscellaneous selection of magic lantern slides a printed lecture.

In the absence of special provisions for supplying this demand, some general hints in this direction may here prove acceptable.

In some assemblages (possibly in some Sunday-schools), very little can be said to advantage on account of the prevailing noise and confusion. The exhibitor having (for love or money) accepted the situation, the question arises as to how to make the best of it.

In such cases in particular it is politic, as well as proper, to select slides unexceptionable in their influence. Grotesque and ridiculous representations gratify a depraved taste, and render a demoralized company still more unruly. It is better to please by what is strikingly excellent and beautiful.

Without assuming the attitude of a reformer, one may take advantage of the lull of expectancy preceding a change of scene to give in a natural voice some interesting particulars of the forthcoming picture.

"Your mystical lore,  
As coming events cast their shadows before,"

will be respected, and you may be able, by judicious management, to strengthen your position on vantage ground. Even in a civilized assembly (and we may well hope to find ourselves in no other), some tact is needful, as well as agreeable speech and faultless manipulation.

#### BIBLE PICTURES.

Among standard colored lantern slides, Bible pictures properly take the lead. They embody the genius of the

most gifted artists, in connection with subjects of the most thrilling interest to mankind.

We may name the picture, particularizing when necessary its several parts, and then repeat the Scripture which is illustrated.

Take, for example, Adam and Eve in Paradise; the luxuriant foliage, the lion, the ox, the horse, the birds, and alas! the subtle serpent.

“In the beginning God created the heaven and the earth.

“And God said, Let us make man in our image, after our likeness; and let them have dominion over the fish of the sea, and over the fowls of the air, and over the cattle, and over all the earth, and over every creeping thing that creepeth upon the earth.

“So God created man in his own image; in the image of God created he him; male and female created he them.

“And the Lord God planted a garden eastward in Eden; and there he put the man whom he had formed.”—Gen. 1: 1, 26, 27; 2: 8.

Or take the scene where Joseph presents his father to Pharaoh. Mark the postures of each, and consider the manners of the times.

“And Joseph brought in Jacob his father, and set him before Pharaoh; and Jacob blessed Pharaoh. And Pharaoh said unto Jacob, How old art thou? And Jacob said unto Pharaoh, The days of the years of my pilgrimage are a hundred and thirty years: few and evil have the days of the years of my life been, and have not attained unto the days of the years of the life of my fathers in the days of their pilgrimage. And Jacob blessed Pharaoh, and went out from before Pharaoh.”—Gen. 47: 7, 8, 9, 10.

Thus Scripture, to any desired extent, may be readily selected appropriate to any Bible picture, from Adam and Eve in Eden to St. John's vision of the Celestial City. So the exhibitor has ample material at hand for shaping an effective and charming discourse, suited to any series of Bible pictures which he may have to show.

The Bible is, par excellence, the storehouse of un-failing supplies for the

## SUNDAY-SCHOOL.

In this modern institution, as elsewhere, there are many duties to be performed, and more ways than one of doing each of them. We will indicate, in this connection, one way of using the Sciopticon. Each member of the school takes a small moneyed interest in the concern at the outset, which insures his taking a more lively interest in the success of the enterprise afterwards.

The apparatus is strictly in the hands of an authorized keeper, because lax regulations suppress all genuine enthusiasm.

The operator arranges his slides in proper order and position, and so is able to avoid ridiculous blunders. His characters are introduced on time, steady and upright, and his scenery glides into place as if seen from the deck of a moving steamer.

It is good policy to enlist as many pupils as possible into active service, thus incidentally enlisting the sympathies of as many circles of relatives and friends.

Suppose repentance is the theme, and the "Prodigal's Return" is illustrated upon the screen. A pupil, fully prepared, stands in his place and recites the whole parable as found in Luke 15.

Another pupil, rising in his class, recites:

"Therefore also now saith the Lord, Turn ye even to me with all your heart, and with fasting, and with weeping, and with mourning. And rend your heart, and not your garments, and turn unto the Lord your God; for he is gracious and merciful, slow to anger, and of great kindness, and repenteth him of the evil."—Joel 2: 12, 13.

A third voice rings out clearly:

"Let the wicked forsake his way, and the unrighteous man his

thoughts; and let him return unto the Lord, and he will have mercy upon him; and to our God, for he will abundantly pardon."—Is. 55: 7.

Passages bearing on repentance and forgiveness are very numerous, from which selections can be made to any extent desired. Illustrations with fewer relations to parallel passages may be coupled with others to extend the exercise to proper length.

Selections also from modern writers, well rendered, give pleasing variety and artistic effect to the performance. The sacred poems of N. P. Willis, for example, are very appropriate. The following extracts may serve as specimens:

#### ABRAHAM'S SACRIFICE.

. . . . He rose up, and laid  
 The wood upon the altar. All was done.  
 He stood a moment, and a deep, quick flush  
 Passed o'er his countenance; and then he nerved  
 His spirit with a bitter strength, and spoke—  
 "Isaac! my only son!" The boy looked up:  
 "Where is the lamb, my father?" Oh, the tones,  
 The sweet, familiar voice of a loved child!  
 What would its music seem at such an hour?  
 It was the last deep struggle. Abraham held  
 His loved, his beautiful, his only son,  
 And lifted up his arm, and called on God,  
 And lo! God's angel stayed him—and he fell  
 Upon his face, and wept.

#### HEALING OF THE DAUGHTER OF JAIRUS.

. . . . The Saviour raised  
 Her hand from off her bosom, and spread out  
 The snowy fingers in his palm, and said—  
 "*Maiden! arise!*"—and suddenly a flush  
 Shot o'er her forehead, and along her lips,

And through her cheek the rallied color ran ;  
 And the still outline of her graceful form  
 Stirred in the linen vesture ; and she clasped  
 The Saviour's hand, and fixing her dark eyes  
 Full on his beaming countenance, AROSE !

## CHRIST WEEPING OVER JERUSALEM.

. . . How oft, Jerusalem ! would I  
 Have gathered you, as gathereth a hen  
 Her brood beneath her wings, but ye would not !  
 He thought not of the death that he would die—  
 He thought not of the thorns he knew must pierce  
 His forehead—of the buffet on the cheek—  
 The scourge, the mocking homage, the foul scorn !  
 Gethsemane stood out beneath his eye  
 Clear in the morning sun, and there he knew  
 While they who “ could not watch with him one hour ”  
 Were sleeping, he should sweat great drops of blood,  
 Praying the “ cup might pass.” And Golgotha  
 Stood bare and desert by the city wall,  
 And in its midst, to his prophetic eye,  
 Rose the rough cross, and its keen agonies  
 Were numbered all—the nails were in his feet—  
 The insulting sponge was pressing on his lips—  
 The blood and water gushing from his side—  
 The dizzy faintness swimming in his brain—  
 And, while his own disciples fled in fear,  
 A world's death-agonies all mixed in his !  
 Ay—he forgot all this. He only saw  
 Jerusalem—the chosen—the loved—the lost !  
 He only felt that for her sake his life  
 Was vainly given, and, in his pitying love,  
 The sufferings that would clothe the heavens in black  
 Were quite forgotten. Was there ever love,  
 In earth or heaven, equal unto this ?

Longer or shorter extracts may be used as occasion  
 requires. The following are titles of others, equally

beautiful, and descriptive of subjects illustrated by lantern slides: "Hagar in the Wilderness," "The Shunamite," "Jepthah's Daughter," "Hannah and Samuel," "Absalom," "Rispah with her Sons," "Baptism of Christ," "The Widow of Nain," "The Raising of Lazarus," "Christ's Entrance into Jerusalem," and "Scene in Gethsemane."

The following poem, by an author unknown to us, will be inserted entire, as it so vividly portrays the mind of the parent and the love of the Saviour for children, and so graphically describes the picture of "Christ Blessing Little Children:"

"The Master has come over Jordan,"  
Said Hannah, the mother, one day;  
"Is healing the people who throng Him,  
With a touch of his finger, they say.

"And now I shall carry the children,  
Little Rachel, and Samuel, and John;  
I shall carry the baby Esther,  
For the Lord to look upon."

The father looked at her kindly,  
But he shook his head, and smiled;—  
"Now, who but a doting mother  
Would think of a thing so wild?

"If the children were tortured by demons,  
Or dying of fever, 'twere well;  
Or had they the taint of the leper,  
Like many in Israel."

"Nay, do not hinder me, Nathan,  
I feel such a burden of care,  
If I carry it to the Master,  
Perhaps I shall leave it there.

“If He lay His hand on the children,  
 My heart will be lighter, I know,  
 For a blessing forever and ever  
 Will follow them as they go.”

So over the hills of Judah,  
 Along by the vine-rows green,  
 With Esther asleep on her bosom,  
 And Rachel her brothers between;

'Mong the people who hung on His teaching,  
 Or waited His touch and His word,  
 Through the rows of proud Pharisees listening,  
 She pressed to the feet of the Lord.

“Now why shouldst thou hinder the Master,”  
 Said Peter, “with children like these?  
 Seest not how from morning till evening  
 He teacheth, and healeth disease?”

Then Christ said, “Forbid not the children:  
 Permit them to come unto Me,”  
 And He took in His arms little Esther,  
 And Rachel He set on His knee.

And the heavy heart of the mother  
 Was lifted all earth-care above,  
 As he laid His hand on the brothers,  
 And blessed them with tenderest love.

And He said of the babe in His bosom,  
 “Of such is the kingdom of heaven,”—  
 And strength for all duty and trial,  
 That hour to her spirit was given.

A little poem published by the American Tract Society, called the “Old, Old Story,” could be used in connection with a series of six slides.

The “Song of the Pilgrimage,” and “Christiana and

her Children," are much used in connection with the corresponding slides. These published exercises afford practical hints, applicable also to Bible slides.

Singing should be introduced at every convenient opportunity, not only for its general good effect, but that each individual may participate directly in the exercises.

Texts of Scripture, and other selections, recited in this way at the rehearsals, and at the concert, become fixed in the memory of all. Who cannot remember such recitations heard in childhood, even to the tones and inflections of the voice—of voices, maybe—not now heard among the living?

These modest recitations require no parade upon an illuminated rostrum; an occasional omission is not very noticeable. The exercises can be arranged by the superintendent, divided among the teachers, assigned to the pupils, and committed to memory by them without severe labor on the part of any.

One or two slides for the concert exercise, with, say a dozen or so for subsequent recreation, answers the purpose. Such a concert exercise, well gotten up, may be several times repeated with growing interest.

It often occurs in schools, where the burdens and duties are monopolized by the few, that the many become impatient of control and hard to please. A hundred pictures in such cases hardly suffices, and a repetition of the same is scarcely tolerated.

An earnest worker in the Sunday-school, therefore, can accomplish more good, not by trying to do everything himself, but by skilfully assigning work for others, and seeing that it is properly done. After all, there will be enough left for pastor and superintendent to do and say, especially when it comes to slides selected from



Class III or V of the appended catalogue, which will require a lecturer well informed in relation to

### BIBLE LANDS.

The following descriptions are selected from the "Bible Dictionary," "Bible Lands," "The Land and the Book," "Bayard Taylor's Travels," &c., to suit the slides in Class III.

As works on Egypt are less common than the Bible Dictionary, a description of each of the twenty Egyptian views is given.

### JERUSALEM.

(For description of the City, and view from Mount of Olives, see Catalogue, Class III.)

**THE TEMPLE AREA.**—The Temple Area, the precincts known to Christians as the Mosque of Omar, but called by the Moslems the "Dome of the Rock," the harem more sacred to Moslems than any spot on earth, except Mecca, is jealously guarded by the Turks. It contains about thirty-five acres, a large portion of which is sprinkled with pomegranates and cypresses, with here and there a shrine. Above this space rises the platform of the great mosque, paved with marble, and ascended by a flight of white marble steps, surmounted by a beautifully carved screen or open gateway, also of white marble. The edifice is an octagon of about one hundred and seventy feet diameter. There are four doors at the opposite cardinal points. The dome is sustained by four great piers, and has twelve arches, which rest on columns. The mosque is very beautiful with a kind of Moorish beauty. The octagonal walls below the dome are covered with porcelain mosaic; the roof inside is of the richest woods, inlaid and carved; the floors of marble

mosaic; the windows like jewelry, of small pieces of Venetian stained glass. Beautiful columns, and an elaborately worked balustrade, surround the holy stone (Es Sakrah, the rock), which Moslems believe to be the centre of the world, suspended from heaven by an invisible golden chain. It is a mass of the native rock of Moriah, the sloping summit or peak of the hill; all the rest of the ridge was cut away when levelling the platform for the temple and its courts.

**THE TOWER OF HIPPICUS.**—The only castle of any particular importance is that at the Jaffa Gate, commonly called the "Tower of David." The lower part is built of huge stones, roughly cut, and with a deep bevel around the edges. It is believed by many to be the Hippicus of Josephus, and to this idea owes its chief importance, for the historian makes that the point of departure in laying down the line of the ancient walls of Jerusalem.

**THE CHURCH OF THE HOLY SEPULCHRE.**—The Church of the Holy Sepulchre is now in the joint possession of all the Eastern Christian sects. Greeks, Latins, Armenians, and Copts have each a chapel within its inclosures, which embrace the alleged sites of the place of the crucifixion and the tomb of the Redeemer. It has been built at many different periods, and under various circumstances.

"The front is a fine specimen," says Lord Nugent, "of what is called the later Byzantine style of architecture." As lately as 1808, the whole of the principal cupola, and a great part of the church, were destroyed by fire. But some parts, and especially the Greek chapel, occupying the whole of the eastern end of the nave, have been restored with good taste and judgment, and

are magnificent in their proportions and decorations. The sepulchre looks very much like a small marble house. It stands quite alone, directly under the aperture in the centre of the dome.

**THE JEWS' PLACE OF WAILING.**—No sight meets the eye in Jerusalem more sadly suggestive than the wailing-place of the Jews, in the Tyropean, at the base of the wall which supports the west side of the Temple Area, where some ancient stones still mark the old walls of the temple. In past ages the Jews have paid immense sums to their oppressors for the miserable satisfaction of kissing these stones, and pouring out lamentations at the foot of their ancient sanctuary. With trembling lips and tearful eyes they sing: "Be not wroth very sore, O Lord, neither remember iniquity forever; behold, see, we beseech thee, we are all thy people. Thy holy cities are a wilderness; Jerusalem is a desolation. Our holy and beautiful house, where our fathers praised thee, is burned up with fire, and all our pleasant things are laid waste."

**THE GOLDEN GATE AT JERUSALEM.**—In former days the gates of towns were of the utmost importance; they were the means of ingress and egress, and usually had rooms over them, and, above these, watch-towers, so that the approach of an enemy might be seen beforehand. The Golden Gate, in the east wall of the Temple Area, is ancient, and the interior of it ornamented with rich and elaborate carving in good Grecian style. It is now walled up.

**GARDEN OF GETHSEMANE.**—"Then cometh Jesus to a place called Gethsemane, and saith unto the disciples, Sit ye here, while I go and pray yonder."—Matt. 26: 36.

Across the brook Kedron, probably at the foot of Mount Olivet, was the "place" or "farm" of Gethsemane. There seems to have been a garden, or rather orchard, attached to it, and to its grateful shade we read that our Lord often resorted with His disciples. At present a modern garden marks the site of the ancient one with eight venerable olive trees, which some claim grew there in the Saviour's time. It has been argued that Titus cut down all the trees about Jerusalem. The probability would seem to be that they were planted by Christian hands to mark the spot; unless, like the sacred olive of the Acropolis, they may have reproduced themselves.

**BETHLEHEM.**—Bethlehem was in existence when Jacob returned from his long sojourn in Padan Aram. Here Rachel died. It was in the neighboring fields, in later times, that Ruth, the Moabite, went gleaning when she came with her mother-in-law, Naomi, to dwell in the land of Israel. It was the birthplace of David, but is best known to us as the birthplace of the Redeemer, great David's greater son and Lord. "On the plains near were the shepherds abiding in the fields, and keeping watch over their flocks by night, when lo! the angel of the Lord came upon them, and the glory of the Lord shone round about them, and they were sore afraid. And the angel said unto them, Fear not, for behold, I bring you good tidings of great joy, which shall be to all people; for unto you is born this day, in the city of David, a Saviour which is Christ the Lord."—Luke 2: 8-14.

**HEBRON.**—Hebron is one of the most ancient cities in the world still existing. "It was built," says a sacred writer, "seven years before Zoan in Egypt."—Num. 13: 22, and was a well-known town when Abraham entered

Canaan 3780 years ago. Sarah died at Hebron, and Abraham then bought from Ephron, the Hittite, the cave of Machpelah, to serve as a family tomb. Jacob gave commandment to his sons, "Bury me with my fathers in the cave that is in the field of Ephron, the Hittite. There they buried Abraham and Sarah his wife. There they buried Isaac and Rebekah his wife, and there I buried Leah." And his sons did unto him according as he commanded them, and buried him in the cave of Machpelah. The massive walls of the harem or mosque, within which the cave lies, forms the most remarkable object in the whole city. Hebron now contains about 5000 inhabitants, of whom some fifty families are Jews. It is picturesquely situated in a narrow valley, surrounded by rocky hills.

"THE POOL OF SILOAM" is one of the few undisputed localities in Jerusalem, still retaining its old name. It is of no considerable size, being eighteen feet broad and nineteen deep. It is, however, never full, having in it usually about four feet of water. It is a complete ruin. It was to this pool that our Lord sent the blind man, after he had anointed his eyes with clay. It was to Siloam that the Levite was sent with the golden pitcher on the last day of the feast of Tabernacles, and from it he brought the water which was then poured over the sacrifice, in remembrance of the water that flowed from the rock Rephidim.

GENESARET, OR SEA OF GALILEE.—This view exhibits a portion of that large inland sea through which the Jordan flows from north to south. It is some thirteen miles long and six broad, and is remarkable for the lowness of the basin in which it lies, being about seven hundred feet below the level of the ocean. No less than

nine cities stood on the very shores of the lake. A great part of our Lord's life was spent near it. Here he taught the people out of Peter's ship, and wondrously filled the nets, so that they brake; walked on the waves, rebuked the winds, and calmed the sea. From the castle Saphet a vast panorama, embracing a thousand points of historic and sacred interest, is presented to the eye. Saphet is truly a high tower. Here are beveled stones, as heavy and as ancient in appearance as any ruins in the country, and they prove that this has been a place of importance from a remote age.

**BATHS AND CITY OF TIBERIAS.**—The sea of Galilee is also called the sea of Tiberias, from the celebrated city of that name. About a mile south from the original site of the city, along the shores, are the celebrated warm baths, which the Roman naturalists reckoned as among the greatest known curiosities of the world. The water of these springs has a sulphurous and most disagreeable smell, and is so nauseous that it cannot be drank, and is not used internally. The baths, however, have a great medicinal reputation. There is but one common bathing cistern, where the water is hot enough to cook an egg—from 130° to 140° Fahrenheit—yet it is always crowded with the lame, the halt, the withered, and the leprous.

**NAZARETH.**—Nazareth is situated among the hills which constitute the south ridges of Lebanon, just before they sink into the Plain of Esdrælon. It derives its celebrity from its connection with the history of Christ. The "Fountain of the Virgin" is situated at the northeastern extremity of the town. The brow of the hill is still called the Mount of the Precipitation (Luke 14: 29), and is half a league southward of Nazareth.

**THE VALLEY OF JEHOSEPHAT.**—The Valley of Jehoshaphat was the favorite burying-place of the Jews from the earliest times; accordingly we find in it a number of remarkable tombs. The monolith of Zachariah is a cubical block of about twenty feet every way, and surmounted by a flattened pyramid of at least ten feet elevation. It is one solid mass hewn out of the mountain, the adjacent rock being cut away, so that it stands entirely detached; there is no known entrance. The tomb of St. James shows a fine front to the west. The cave extends forty or fifty feet back into the mountain. Some two hundred feet north of this is the tomb of Absalom. The entire height of this very striking "pillar" cannot be less than forty feet. Believing it to be Absalom's tomb, the natives throw stones against it, and spit at it as they pass by. Close to this monument, on the northeast, is the reputed tomb of Jehoshaphat.

"THE DEAD SEA," says Dr. Thomson, "without any reference to what others have said, I can testify to the following facts: The water is perfectly clear and transparent. The taste is bitter and salt, far beyond that of the ocean. It acts upon the tongue and mouth like alum, smarts in the eyes like camphor, produces a burning, pricking sensation, and it stiffens the hair of the head much like pomatum. The water has a much greater specific gravity than the human body, and hence I did not sink lower than to the arms when standing perpendicularly in it. We saw no fish nor living animals in the water, though birds were flying over it unharmed. All of us noticed an unnatural gloom, not upon the sea only, but also over the whole plain below Jericho. It had the appearance of Indian summer in America, and like a vast funeral pall let

down from heaven, it hung heavily over the lifeless bosom of this mysterious lake." Its area is about two hundred and fifty square geographical miles. At its northern end it receives the stream of the Jordan. The depression of its surface, and the depth which it attains below that surface, combined with the absence of any outlet, render it one of the most remarkable spots on the globe.

**THE FORDS OF THE JORDAN.**—The reach of the Jordan here shown is the place to which pilgrims of the Greek Church resort every year, in Holy Week, to renew their baptism by bathing in the Jordan, and it is the spot which tradition points out as the place where our Saviour was baptized. The Jordan is a rapid and tortuous stream, interrupted by many rapids, and annually "overflows his banks all the time of harvest." So far as this overflow extends there is a belt of luxurious vegetation, but beyond it the ground is barren.

#### EGYPT.

From time immemorial Egypt has been an object of interest to the rest of the world. Almost the dawn of Scripture light breaks upon the rocks and sands of this wonderful valley, whose vast river diffuses fertility wherever it flows. Here the children of Israel served the Pharaohs four hundred and thirty years and grew into a great nation. From the banks of the Nile they set out on that marvelous pilgrimage to Sinai and Zion, those two rocky pinnacles whence the splendors of the Law, and the mild and beneficent radiance of the Gospel, beamed forth upon mankind.



A TRAVELER'S NILE BOAT, OR "DAHABEEK."—The traveler who visits Egypt can avail himself of public conveyance as far as Cairo, but if he desire to visit the remains of ancient grandeur that lie to the south, he must engage a Nile boat, which becomes, for the time being, both the means of locomotion and his home; and as all the points of interest are near the river, a more commodious plan for visiting them could hardly be devised. As there are no towns above Cairo everything in the shape of comforts and luxuries must be provided before setting out.

STREET IN CAIRO.—The streets in Cairo, like those of most Oriental towns, are narrow, being some eight or ten feet wide. The houses are mostly three stories in height, each story projecting over the other, and the plain stone walls are either whitewashed or striped with horizontal red bars, as seen in the picture.

The beautiful latticed windows, "masharobeahs," are the chief ornament of the old Mameluke houses in Cairo. The wood seems rather woven in the loom than cut with the saw and chisel. Through these lattices of fine network, with borders worked in lace-like patterns, and sometimes tipped with slender turrets, the Cairo ladies sit and watch the crowd passing to and fro, themselves unseen. "The mother of Sisera looked out at a window and cried through the lattice, Why is his chariot so long in coming?"—Jud. 5:28. Donkey-riding in the streets, and bazars, is almost universal. The animals are small but strong. The driver runs behind, gives the donkey a punch, cries "O man, take care! O boy, get out of the way!" and the rider is hurried into a confusion of other donkeys, loaded camels, water-carriers, and footmen. To one unaccustomed to donkey-riding it seems

as hazardous as going on foot. The streets of Cairo are watered several times a day, and are nearly always cool and free from dust.

**FERRY AT OLD CAIRO.**—Old Cairo is situated about two miles from modern Cairo. The wonderful clearness and brilliancy of the Eastern atmosphere; the absence of smoke, charcoal alone being burned; the picturesque effect of the ruin into which many of its great monuments are falling; the rich, green valley of the Nile; the river; the Pyramids in the distance; and the fading of the landscape into the boundless haze of the Lybian desert, constitutes a scene which, for splendor and interest, is perhaps unequaled in the world. The taste for gaudy and fantastic coloring has been for ages a distinguishing feature of Eastern embellishment. The alternate red and white stripe is conspicuous on the sails of the ferry boats, which are constantly passing back and forth between Cairo and the island of Rhoda opposite. Here we have a group of Arabs from the desert, with their camels, dealers in oranges, vegetables, sugar-cane, &c. For picturesqueness of costume, there is nothing like the East; the flow of the drapery so simple and natural, the coloring so deep and brilliant.

**TOMBS OF THE MEMLOOK KINGS AT CAIRO.**—These tombs are fine specimens of Saracenic architecture, and were erected in the thirteenth and fourteenth centuries.

**PYRAMIDS.**—The Pyramids of Gizeh, three in number, are situated about eight miles from Cairo, and should be visited by the tourist before entering on his river cruise. They stand on a ridge of stone, which has been so cut as to form part of the basement. The great Pyramid is mainly composed of blocks of limestone brought from the

quarries on the other side of the Nile, about sixteen miles off. It covers about  $13\frac{1}{2}$  acres; its present height is 456 feet; it must formerly have been about 480 feet high. Its

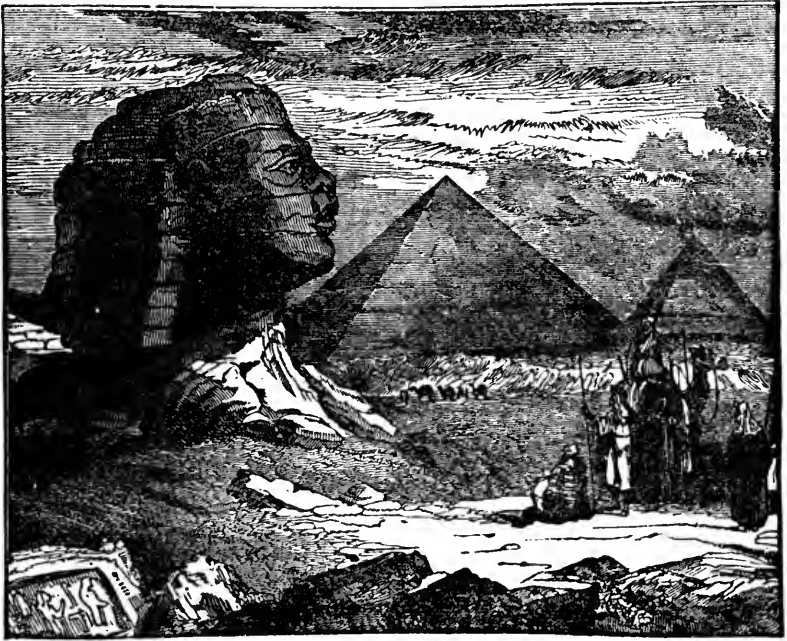

sides now present the appearance of irregular steps, varying from four feet eight inches to one foot eight inches; but it appears to have been covered originally with a casing of polished granite; a portion of the covering still remains on the second Pyramid. Herodotus tells us that 100,000 men were employed twenty years in building this Pyramid, which appears to have been chiefly intended as a mausoleum of its founder. The granite covering on the second Pyramid makes its ascent more dangerous than the first, which presents no other difficulty than the ascent of a rugged staircase, about four hundred feet in height, in which the steps vary from two feet to a little more than four.

Near the Pyramids, more wondrous and more awful than all else in the land of Egypt, there sits the lonely Sphinx. This monument, so imposing in its aspect, even in the mutilated state to which it has been reduced, has always excited the admiration of those who possessed sufficient knowledge of art to appreciate its merits at a first glance. The contemplative turn of the eye, the mild expression of the mouth, and the beautiful disposition of the drapery at the angle of the forehead sufficiently attest the admirable skill of the artist by whom it was executed.

**HELIOPOLIS.**—Heliopolis, the sacred city, the On, where Joseph's wife, Asenath, lived. A few scattered blocks, a solitary obelisk covered with hieroglyphics, these, with some mounds of sand and rubbish, are all that is left to mark the site of the once priestly city.

**THE SIMOOM.**—In crossing the desert travelers are frequently exposed to the Simoom or sand storm. Its approach is indicated by a redness in the air, the sky is suddenly overcast, clouds of hot sand obscure everything, and often render further progress for the time impossible. The whole caravan, camels and men, then lie prostrate on the ground till it passes over.

**COLOSSAL STATUES OF THEBES.**—The Colossi of the plain. These immense sitting figures, fifty-three feet above the plain, which has buried their pedestals, were erected by Amunoph III, and were originally in front of a large temple, of which only the ground-plan remains. The more distant statue is the vocal Memnon of history. An inscription made by one of the Roman emperors records the hearing of musical sounds.

**OBELISK AND PROPYLON LUXOR.**—Part of the ruins of Thebes shows the arrangements that the Egyptians adopted in their temples. The entrance by a doorway between two immense moles of stonework, termed pylæ. The victories of Rameses are sculptured on the face of the pylon; but his colossi, solid figures of granite, which sit on either side of the entrance, have been much defaced. The lonely obelisk, seen a little in advance to the left, is more perfect than its mate, which now stands in the Place de la Concorde, at Paris.

**COLOSSAL STATUE REMESSES.**—The mutilated statue in this view was the largest monolithic figure transported by the Egyptians from the place where it was quarried. Its weight when entire was nearly nine hundred tons, and this statue now lies in enormous fragments around its pedestal. The statue in its sitting position must have been nearly sixty feet in height, and is the largest in the world; one of its toes is a yard in length. The Turks and Arabs have cut several mill-stones out of its head without any apparent diminution of its size.

**APPROACH TO THE TEMPLE AT KARNAK.**—From the entrance of the temple at Luxor to the pylon at Karnak, a distance of a mile and a half, an avenue of colossal sphinxes once existed. The sphinxes have disappeared and an Arab road leads over the site. On reaching the vicinity of Karnak the camel path drops into a broad excavated avenue, lined with fragments of sphinxes. As you advance the sphinxes are better preserved and remain seated on their pedestals, but they have all been decapitated. Though of colossal proportions, they are seated so close to each other that it must have required nearly two thousand to form the double row to Luxor. The avenue finally reaches a single pylon, of majestic

proportions, built by one of the Ptolemys and covered with profuse hieroglyphics. Passing through this, another pylon, followed by a pillared court, and a temple built by the later Remisides.

**HALL OF COLUMNS AT KARNAK.**—Three thousand years ago and this forest of columns was standing. Here Cambyses stayed his chariot-wheels to gaze in wonder at the triumphs of architecture. Here Sesostris was welcomed back with the loud acclaim of millions from his conquests. The Cæsars were awed into humility when they trod these aisles, and even the Arab hosts, as they swept by on the tide to victory, paused to admire; and the armies of France, as they rushed in pursuit of the flying Memlooks, were so struck with amazement at the ruins that they fell upon their knees in homage and rent the air with their shouts of applause.

The main aisle is composed of an avenue of twelve pillars, six on each side, each thirty-six feet in circumference and nearly eighty in height. Ponderous masses of sculptured stone. The spreading bell of the lotus blossoms crown them with an atmosphere of lightness and grace. On each side of the main aisle are seven other rows of columns, one hundred and twenty-two in all, of immense size, and so close as sometimes not to allow a column that has lost its erect position to fall to the ground. They date from the time of Rameses III, the Sesostris of Greek writers. These columns are a good illustration of the way in which the Egyptians covered all parts of their buildings with inscriptions.

**THE OBELISKS AT KARNAK.**—These obelisks, the most ancient now standing in Egypt, date about 1800 B. C. They are granite, and retain the sharpness of their angles in a wonderful manner. This view shows in a

striking manner the desolation that prevails over all these Egyptian ruins. The total circumference of Karnak, including its numerous pylæ or gateways, is a mile and a half. The row of columns seen in the picture are part of the Hall of Columns.

**THE APPROACH TO PHILÆ.**—Philæ, the “Jewel of the Nile,” is situated a short distance from those rapids of the Nile, known as the first cataracts. These cataracts are formed by the bed of the river being crossed by a formation of granite, through which it has cut its way, producing a series of rapids. Opposite to these cataracts stood the ancient city of Syene. It was from the quarries at Syene that the Egyptians obtained their monoliths, whether obelisks or statues. These were sculptured on the spot, and then transported by the labor of men to the places where they were to be erected. The island of Philæ contains about fifty acres, and is covered with ruins of temples and palaces, all of which belong to the Ptolemaic period. The basin of black jagged mountains folding it in on all sides, yet half disclosing the avenues to Nubia and Egypt; the clusters of palms, with here and there a pillar or wall of a temple, the ring of the bright river, no longer turbid, as in lower Egypt; of these it is the centre, as it was once the focus of their beauty.

**VIEW ON THE ISLAND OF PHILÆ.**—The temple which belongs to the era of the Ptolemys, and is little more than two thousand years old, was built by various monarchs, and is very irregular in its plan. The columns of the temple are very different from those of Luxor and Karnak, indicating the result of the contact of Greek and Egyptian systems of architecture. Above the true capital is a square block that bears on its four sides the head

of Osiris, under the form of a bull. It was into this form of idolatry that the Israelites were so constantly lapsing, termed in Scripture, the Worship of the Golden Calf.

PHARAOH'S BED, PHILÆ.—This temple is almost perfect; it never had and never was intended to have a roof. It is one of that class termed Hypæthral temples, from their being open to the sky. Its name, Pharaoh's Bed, is derived from a tradition that Osiris was buried at Philæ, and from this it was that the Egyptians were in the habit of swearing by him who lies at Philæ.

SCULPTURED GATEWAY.—This is a good illustration of the way in which almost all parts of the buildings were covered with inscriptions. The large figures on this doorway were originally painted in bright colors, and on some of these, patches of the original paint still remain.

TEMPLE EDFOU.—This is perhaps the best specimen extant of the pylon of the Egyptian temples; it is upwards of one hundred feet in height, but a considerable part of the base is covered up with sand, which has also almost filled up the area of the temple. In this part the valley of the Nile is wider than in many places; it varies from about ten miles in width to only enough to allow of the passage of the river. Many of the temples are built close to the waters of the sacred river.

TEMPLE OF KALABSHE, NUBIA.—The space inclosed within the ruins of this temple is covered with sculptured figures, among which the most remarkable is the representation of a human sacrifice, where the victim, whose whole clothing consists of a scanty waist-cloth, is on his knees with his hands tied behind his back.



Behind him stands a priest with lofty mitre, who with one hand holds him by his long hair, while in the other he brandishes a small axe, ready to strike off his head. This horrid scene takes place in the presence of Osiris Hierax, who is seated on his throne enjoying the spectacle.

**THE SHADOOF.**—This view presents a scene on the Nile. A group of stately palm trees, tall and slender, with feathery plumes on their proud heads, and large clusters of golden fruit. The shadoof is a simple contrivance for raising water; a method very common both in ancient and modern Egypt. It consists of a lever moving on a pivot, which is loaded at one end with a lump of clay, or some other weight, and has at the other a bowl or basket, as seen in the picture. Wells have usually troughs of wood or stone, into which the water is emptied for the use of persons or animals coming to the well.

#### **VIEWS OF INTEREST IN DIFFERENT PARTS OF THE WORLD.**

These are described in gazetteers, and to some extent in school geographies. Some lecturers appear as very accomplished travellers by using well-written guide-books.

For an acquaintance with historical pictures, we may consult the histories of the times.

With regard to "views conveying moral lessons," the name of each slide affords a text upon which the lecturer may base what remarks he may have to offer.

#### **NURSERY TALES.**

English catalogues contain many familiar poems and stories, particularly the nursery tales, which are illustrated by lantern slides. Not having room to reprint

these here, we would refer to the toy books everywhere sold for these wonderful specimens of English literature. At the risk, however, of making the rest of our matter seem prosy by contrast, we will copy just the closing part of the description of a long slide of animals, to indicate how much is made to depend on words and music, and how little on the merits of the slide.

[*Sound of Horn. Music. Last tune of the "LANCERS."*]

Yes, here we are in full cry! The real thing, too!!

“Old Mother Slipper Slopper jumped out of bed,  
And out of the window she poked her head;  
Husband! O husband! the gray goose is dead,  
And the fox is gone out of the town, O!”

Yes, there he goes, and the old lady after him, and she has called up John, the servant, and he joins in the chase, and old Mr. Slipper Slopper comes next; but he's rather behind, as he's been to call “Bumble,” the parish constable, who has come out with his staff to catch the thief. Tally ho!

And now, my children, recollect I told you that the lion was the king of the beasts, and so, as a conclusion to this entertainment, I shall show you how he kept his court. (*Music.*)

There he is, sitting in full state; and now, if our kind friend at the piano will play a “March,” you shall see a grand procession, and all the animals passing in order before him.

[“GRAND MARCH,” *during which the slide is moved slowly.*]

GOOD NIGHT.

*Tune and Motto, “GOD SAVE THE QUEEN.”*

**COMPOSITION PICTURES.**

The miscellaneous views in Class X are mostly composition pictures, suggesting their own descriptions. Take, for example, this picture of the milkmaid.



The cow, so gently submitting to the maiden's manipulations, evidently feels quite at home. Appearances indicate that she is capable of giving a pailful of milk. She has taken the position convenient for the milkmaid, who, for the time, has suspended operations for a social chat with the young farmer who is resting upon the barnyard gate. We may not hear what they say, but little sister, doubtless, is verifying the old adage, that "little pitchers have large ears."

The two reclining animals may have borne the yoke seen at the left, during working hours, and are now wooing

"Tired nature's sweet restorer, balmy sleep."

The animal at the right is too young for active service, and has not yet experienced the ills of a laborious life, of which the harrow near by is a suggestive emblem.

The old hen in front cannot boast a very numerous brood, but the fewer mouths the better cheer.

“Throw some crumbs and scatter seed,  
And let the hungry chickens feed.”

The farmhouse on the rising ground, nestled among the trees, has an imposing appearance, but it is nothing to be compared to the elegant castles built in the air by that admiring young farmer and the loving maiden. May the course of their true love ever run smooth.

### STATUARY.

Statuary and many other pictures may also be announced, and then described by what the picture itself shows, as in the example following :

**THE COUNCIL OF WAR**, by John Rodgers.—President Lincoln is seated and holding before him a map of the campaign. Secretary Stanton stands behind his chair, wiping his glasses and listening to General Grant, who is explaining his plan, which he is pointing out on the map.

**THE SEASONS**, by Thorwaldsen.—Four circular bas-reliefs, viz. :

*Spring*.—A female figure, attended by two genii bearing baskets of flowers.

*Summer*.—A harvest scene, with a group of reapers.

*Autumn*.—A hunter returns to his home bearing game; a woman and child (seated beneath a grape vine) receive him.

*Winter*.—An old man warming his hands over a brazier, while an old woman lights her lamp.

“Behold, fond man!

See here thy pictured life; pass some few years,  
Thy flowering spring, thy summer’s ardent strength,

Thy sober autumn fading into age,  
 And pale concluding winter comes at last  
 And shuts the scene."

### MOVABLE SLIDES.

These of course tell their own story. Now and then, an appropriate recitation can be found for them.

The swan floating upon the moving waters, for instance, may be assumed as illustrating the legend that her first and only song is sung as she floats down the river on her dying day.

" 'Tis the swan, my love,  
 She is floating down from her native grove,  
 No loved one now—no nestling nigh—  
 She is floating down by herself to die.  
 Death darkens her eye and unplumes her wings,  
 Yet the sweetest song is the last she sings.  
 Live so, my love, that when Death shall come,  
 Swan-like and sweet, it may waft thee home."

Spectators, in the limited time given them, can hardly be expected to take in all the details of a complex view, without more or less of this particularizing, which can be resorted to as occasion requires, therefore, in connection with a wide range of subjects.

### SCIENTIFIC SLIDES, &c.

The illustrations enumerated in the Scientific Department, of the appended catalogue, are suited to the textbooks in common use. Works on natural history afford descriptions of beasts, birds, fishes, reptiles, and insects. Botany describes plants and flowers.

The explanations in Wells's Geology, Cutter's Physiology, &c., are just as well suited to the corresponding

classes of lantern slides, because they are mostly after the same designs.

The set of long astronomical slides has from time immemorial been accompanied by a printed lecture, which, though somewhat antiquated, still answers a pretty good purpose.

Could a suitable lecture of similar shape accompany each of the forty sets of scientific illustrations, it would prove advantageous to many, and it would do no harm to any; so we are looking for something of the sort in the near future. But these sets of scientific slides themselves leave scarcely anything to be desired in the way of fitness and excellence; and we have, moreover, in the Sciopticon an instrument unrivaled for convenience combined with efficiency.

As before intimated, little has been attempted in this chapter but to indicate some of the ways of finding descriptions.

When the use of the magic lantern was very limited, its slides could be described in small compass; but now, a work that should describe all the slides in use, would hardly be less voluminous than the *Encyclopedia Britannica*.

## CHAPTER IX.

**The Sciopticon and its Uses.****DESCRIPTION OF THE SCIOPTICON.**

*[From the Journal of the Franklin Institute.]*

“Our attention was drawn some time since to this very decided improvement in lanterns illuminated by ordinary flames, by which their efficiency is so greatly increased that many results can be reached which were heretofore only attainable by aid of the lime or magnesium lights.

“The most important feature in this apparatus is the lamp, or, as it might, in this case, be called, from its appearance, the furnace. This source of action to the entire machine is placed in a cylindrical chamber, provided with a chimney, and has two flat wicks, one and a half inches long, parallel to each other and to the axis of the chamber, and in fact the optical axis of the instrument. The flames, or rather sheets of flame, that rise from these wicks are drawn together by the arrangement of the draft, and so form a pointed ridge or edge of intense light in the axis of the condensers. We have, on various occasions, alluded to the fact long ago pointed out by Rumfort, that flame was practically transparent. Here this property is utilized, and by reason of it we can get through the condenser all the accumulated brightness of the long line of light, one and a half inches deep.

“We have witnessed a number of experiments with this lantern, and can fully indorse it as a great advance upon any thing before used in the shape of a lamp-illuminated magic lantern.

“For a parlor or school exhibition, it may well take the place of the far more troublesome oxy-calcium lantern, which it rivals in efficiency.

“There are many details of construction which are of very ingenious and efficient character, among which we would specially notice the slide for pictures, by which, one picture being in use, another may be removed and exchanged, and then, by a single movement, brought into the field, while the other is in like manner ready for substitution.”

### **THE MAGIC LANTERN FROM 1650 TO 1870.**

[*From the Scientific American.*]

“The invention of the Magic Lantern dates back to 1650, and is attributed to Professor Kircher, a German philosopher of rare talents and extensive reputation. The instrument is simple and familiar. It is a form of the microscope. The shadows cast by the object are, by means of lenses, focused upon something capable of reflection, such as a wall or screen. No essential changes in the principles of construction have been made since the time of Kircher; but the modern improvements in lenses, lights, and pictures have raised the character of the instrument from that of a mere toy to an apparatus of the highest utility. By its employment the most wonderful forms of creation, invisible, perhaps, to the eye, are not only revealed, but reproduced in gigantic proportions, with all the marvelous truth of nature itself. The success of some of the most celebrated demonstrations of Faraday, Tyndall, Doremus, Morton, and others, was due to the skilful use of the Magic Lantern. As an educator, the employment of this instrument is rapidly extending. No school apparatus is complete without it;



and now that transparencies are so readily multiplied by photography upon glass, upon mica, or gelatin, by the printing press or the pen, it is destined to find a place in every household; for in it are combined the attractive qualities of beauty, amusement, and instruction.

“The electric light affords probably the strongest and best illumination for the Magic Lantern; then comes the magnesium light; but their use is a little troublesome and rather expensive; next to these in illuminating power is the oxy-hydrogen or Drummond light. The preparation of the gases and the use of the calcium points involve considerable skill.

“Need has long been felt for some form of the Magic Lantern having a strong light, but more easily produced than any of those just mentioned; and this has at last been accomplished, after several years' study and experiment, by Professor L. J. Marcy.

“The Sciopticon is the name of his new instrument, and from actual trial we find that it possesses many superior qualities. Its lenses are excellent, and in illuminating power its light ranks next to the oxy-hydrogen. The Sciopticon light is produced from ordinary coal oil, by an ingenious arrangement of double flames, intensifying the heat and resulting in a pencil of strong white light. Professor Marcy's instrument is the perfection of convenience, simplicity, and safety. Any one may successfully work it, and produce the most brilliant pictures upon the screen. It is peculiarly adapted for school purposes and home entertainment. Those who wish to do a good thing for young people should provide one of these instruments. Photographic transparencies of remarkable places, persons, and objects, may now be purchased at small cost, while there is no end to the variety of pictures which may be drawn by hand at

home, upon mica, glass, or gelatin, and then reproduced upon the screen by the Sciopticon."

### TRAVELLING BY MAGIC.

BY EDWARD L. WILSON.

*Editor of the Philadelphia Photographer, and Photographic World.*

Marcy's Sciopticon is what we want to give us a view of the world at large, while seated in our own drawing-room, enjoying all the comforts of home, and the pleasures of social intercourse.

Give us the Sciopticon, with the necessary slides, before a screen or a white wall, and we will carry you as fast or as slow as you wish, wherever the foot of man has trod, in excellent and comfortable style.

First we look upon the screen and, in imagination, we go driving along over the Union Pacific Railroad. We visit the large cities on our way, and get as good ideas of their grain elevators and their churches as if we stood by their side. We see the Mormon tabernacle, and capture Brigham in person for our screen. On we go, over the prairies, amid the buffaloes, dodging under the great snow-sheds, climbing up the inclines of the jagged Sierras, and lo! (not "the poor Indian") we stand watching the gambols of the seals in San Francisco Bay, straining our eyes to reach the summit of El Capitan in the Yosemite Valley, listening to the rustlings of the Bridal Veil, or clambering up the sides of "General Grant" in the Mariposa Grove.

Or, we may glide up the Hudson, capturing the Palisades, storming the Highlands, wander amid the seductive music of Trenton Falls, cross Lake George, "do" Saratoga, "flee to the mountains," squeeze through the Crawford Notch, clamber up Mount Willard, ascend

Mount Washington on the wonderful railway, descend to the Glen, glide around to the Profile House, face Eagle Cliff, kiss our hands to the "Old Man of the Mountain," shake up the echoes on the lake, and dare the boulder in the flume, all in one half hour.

Then, after we have seen Niagara from a hundred standpoints, views made in winter and summer, and travelled up the Mississippi, through Watkin's Glen, inhaled the freshness of White Sulphur Springs, wandered among the wildernesses of North Carolina, and seen Florida and Cuba, not to forget the Mammoth Cave, we may go over to Europe. There we ascend the Alps with Prof. Tyndall, go down into the caverns, and clamber among the icicles, or traverse the awful glaciers with their yawning, ever-hungry crevices.

Or we may see in the same way the ruins of India, the mysteries of Pompeii, the tombs and pyramids of Egypt, or Rome's seven hills covered with glories, to say nothing of humiliated Paris or exultant Germany.

Everything that photography can produce may be served up in excellent style, and with little trouble through the instrumentality of Marcy's Improved Magic Lantern. Last evening I had the pleasure of entertaining and delighting a whole company of men, women, and children for an hour or two in this way, at the extreme cost of five cents for coal oil!

The great efficiency of the Sciopticon, as compared with any other lamp-illuminated lantern, together with its simplicity, symmetry, and compactness, its safety, convenience, and fitness for slides of every variety and for various philosophical experiments, makes it unrivalled for home and school purposes.

No doubt Mr. Marcy's explanation of it will be appreciated, and I need only add that I would not want

to be without a Sciopticon in my house. It gives one such enlarged views of everything.

### **SCIOPTICON FOR SUNDAY-SCHOOLS.**

BY E. D. JONES, ESQ.,

*President Missouri State Sunday-School Association.*

“While the great aim of all Sunday-school effort is to teach the word of God, seek the conversion of scholars, and train such in the ways of holy living, yet there are appliances and helps that may be used to attract and interest young minds where they do not in any way conflict with the grand object of the school.

“It is a religious institution, and its interests should be well guarded from all that would in any way lower the dignity of its mission. Some time since I introduced the Sciopticon, a recent improvement in the line of the Magic Lanterns, of which Prof. L. J. Marcy, of Philadelphia, is the patentee.

“I found the instrument wonderfully simple in construction and management. Its lamp burns simple coal oil and gives a most intense light, and in the production of pictures on the wall or on the screen equals any of the most expensive Magic Lanterns, with calcium lights, that cost so much labor and expense.”

### **SCIENCE AT HOME.**

*(Communication from the President of Franklin Institute.)*

MR. L. J. MARCY.

DEAR SIR: During the winter of 1872-73 I was interested in lantern experiments, using the lime light as the source of illumination. At the same time I made frequent use of your very admirable Sciopticon, with oil lamps. The readiness with which it can be adjusted and made ready for use impressed me. For parlor use,

as a magic lantern, I very much preferred it on this account, to the more troublesome lime light. Its convenience recommends it as an adjunct to the school-room and I found that very many of the most interesting experiments in physics, usually shown in a lantern, can be readily performed with the Sciopticon. My good friend, Prof. Henry Morton, of the Stevens Institute of Technology, in Hoboken, has already described many of these experiments in your manual. I have told you how I have repeated many of them with very little expense in the way of apparatus, and I would now suggest to the would-be purchasers of your lanterns, that should they desire to use it as an adjunct to the lecture table, they need not be alarmed at the expenditure needed to procure all the fixtures required to perfect it. One of the chief pleasures in its use is in the improvising of what is needed. Those who have long purses may prefer to purchase all needed pieces of apparatus, ready-made to their hand, but a few hints may serve to show how they can, with very little skill, prepare what will answer their purpose. As an illustration, let me recall the very pretty experiment usually called the broken arrow, which is shown to illustrate refraction. As an object in the lantern, a brass plate having an arrow-shaped opening in it (procurable at the instrument makers) is put in place, this throws upon the screen a white arrow on a dark ground; now, if in front of the brass plate a strip of thick glass, narrower than the length of the arrow, be held parallel with its surface, no distortion of the arrow image will be seen; but if the glass be inclined so that the rays of light pass through it obliquely, a piece of the arrow will seem to be cut out and be moved to one side. This is a striking illustration and can be improvised quite readily, as follows: Procure some slips of

good window glass, of the size used for magic lantern slides (I prefer 3 x 4), some tin-foil, such as paper-hangers paste on damp walls before papering, and some paste made of gum tragacanth; with a sharp knife, laying the foil on a plate of glass, the arrow-shaped opening can be readily cut, and its edges will be as smooth as the most skilful mechanic can make a brass plate. This foil, so prepared, should be mounted between two slips of glass, and the edges bound with paper. Gum tragacanth will cause paper to adhere to glass very firmly and is a nice, clean paste to use. The slide thus prepared will be found to be quite as good as the most costly one procurable in the stores. In my own experiments, when I require slits or openings of any required shape, in opaque plates, I have invariably made them in this manner, with a feeling of satisfaction at their cheapness.

A very convenient device to show wave motion can be made with this tin foil. One slide is made with plates of glass, 3 x 4 inches, having tin foil inclosed, in which slits are cut crossways, say  $\frac{1}{16}$  inch wide, 2 inches long, and the slits placed  $\frac{1}{2}$  of an inch apart. I have sometimes pasted slips of tin foil  $\frac{1}{2}$  of an inch across the plate, at equal distances, say  $\frac{1}{16}$  of an inch, in preference to cutting them in a solid piece of foil. This slide will show vertical bars of light on the screen. If now another slide be made of two glasses, 3 x 6 inches, with foil between them, in which foil a wave-like opening be cut, say  $\frac{1}{2}$  of an inch wide, this slide of itself would show in the lantern a wave line of white on a dark ground on the screen. The two slides put together in the lantern will show a wave line of dots, and if the wave-line slide, which is twice as long as the one with bars, be moved back and forth in front of the bars, the dots will seem to rise and fall in wave motions, and the fact will be demonstrated, that in wave

motions there is an advancement of the wave, while the individual particles only rise and fall without advancing.

The slips of glass, mentioned above, can be conveniently prepared for drawing diagrams, by coating one side with plain collodion (gun cotton dissolved in equal parts of alcohol and ether); when dry this surface takes India-ink admirably, and diagrams can be traced, or pictures copied in a rough way, by laying the glass plate so prepared over the picture to be copied and tracing its outline with a pen filled with good India-ink.

I would strongly advise any one using your lantern to procure some of the comic slides, such as you illustrate in Class XV of your catalogue of slides, and they can see how to make similar ones to be used in illustrations of scientific subjects. Thus with the wreck of one of these three glass slides, picked up at some opticians and purchased for a few cents, I improvised a slide which answered better to illustrate the process of carbon printing in photography than the process itself would have done in a lecture-room. One figure changed with another by means of sliding glass plates is very useful in many kinds of experiments or illustrations of facts and processes.

The tank figured in your manual, in Chapter VII, on Chemical Experiments, contributed by Prof. Morton, can be made to do service in a long line of experiments with electricity, by a very simple device. Thus, to illustrate the decomposition of water, cut a slip of segar-box wood, of a size that will lay on the bottom of the tank loosely, attach to this bit of wood copper wires, which will extend up to the end of the tank and will not quite meet at the centre of the bit of wood; to upturned ends at this place, solder little slips of platina foil,  $\frac{3}{4}$  inch long by  $\frac{1}{4}$  inch wide, they must stand vertically face to face,

about  $\frac{1}{2}$  inch apart. Now coat the copper wires and the wood with melted paraffine, but take care that none gets on the platina; this will insulate the copper wires and prevent the wood from absorbing any moisture. This little frame placed in the tank, immersed in acidulated water (water with a few drops of sulphuric acid), and the terminal wires attached to say two cells of Groves' battery, will show the decomposition of water admirably. A similar piece of apparatus with the terminal wires at the centre of the board, united by a vertical coil of very fine platina wire, will be found useful in illustrations of circulation by heat. Such a frame immersed in clear water will be seen on the screen as a black coil, seemingly hanging down from a black bar on the top of the screen; if now, by means of a pipette, some colored fluid, say a solution of permanganate of potash in water, be carried to the bottom of the tank, it will on the screen seem to spread itself out as a red stripe under the black one and enveloping the little coil; a current of electricity passed through the wire will heat the little platina coil and thus heat the water in contact with it, so that currents will be established in the fluid, carrying with them the colored fluid in a very beautiful curling cloud of color.

I mention to you these few examples, of how readily the needful appliances for illustrations can be improvised; now I have frequently heard persons say that they "feared the expense entailed in the use of a lantern" that "the lantern is so useless without a great many accessories, which are so expensive in themselves." Feeling a lively interest in your very meritorious invention, I have volunteered these hints, which I beg you will, if you see fit, use to your benefit.

Very truly yours,

COLEMAN SELLERS.



## CHAPTER X.

**The Teacher his own Artist.****A PROCESS FOR DRAWING AND PAINTING MAGIC LANTERN SLIDES.**

The following process is given to assist persons who own a Sciopticon, to prepare for themselves a portion, at least, of the necessary transparencies, especially educational illustrations. It has been our aim to simplify the whole matter as much as possible consistently with giving such directions as are safe and practicable. It is true that there are some other colors and materials which can be used, but the list given below contains *all* that are *necessary* for the production of hand-made pictures, or for coloring photographs on glass in this style.

## LIST OF APPARATUS AND MATERIALS.

Easel,	Siccatif,
Glass slab,	Tube of blue-black in oil,
Palette-knife,	Tube of crimson lake in oil,
Sable pencils,	Tube of Italian pink in oil,
Duster,	Tube of Prussian blue in oil,
Point for erasing,	Tube of burnt sienna in oil,
Hard black-lead pencil,	Ol. Turpentine,
Fine pen,	Glass,
Varnish, Nos. 1 and 2,	Mats,
Liq. India ink,	Binding-paper,
Canada balsam,	Box for the above articles.

For amateur work we very decidedly recommend that the pictures should be made on the 1-4 size of glass known to photographic stockdealers as "B. P. C."

After the painting is finished and dry, it is only necessary to cover with a mat and another piece of the same glass, binding the edges with narrow strips of paper, to give us the form of the "Woodbury," or of the new "Crystal" slide.

If the glass which we recommend is used, simply

breathing on and thoroughly rubbing it with tissue-paper is sufficient for the cleaning. Of course the fingers must not touch the surface of the glass after it is cleaned.

The next step is to prepare the surface of the glass for the drawing. If the glass (as is usual with this kind) is slightly curved, the *concave* side should invariably be the surface to receive the preparation. This preparation is as follows: "The plate to be dusted and gently warmed; then flow the surface with No. 1 varnish, and drain into the bottle from the corner of the glass. When this is dry, flow with No. 2 in the same manner, and afterwards dry with gentle heat. Of course until the varnish is dry the corner from which the varnish was drained should be kept down. Should dust find its way into the varnish, it can be filtered." Having prepared the surface, it should not be soiled by handling (always take the glass by the edge between the fingers). A sketch can now be made on the surface with a good hard *black-lead* pencil, either as an original drawing, with the glass on the easel, or by placing the glass on an engraving or other picture, and tracing the outline.

When this sketch or outline is finished, strong and black lines and marks can be made with the "liquid India-ink" in a fine pen, gently used so as not to make the lines too coarse and heavy. With the pen, too, lines can be ruled or letters or figures added. After the drawing is finished and dry, any little corrections or scratches can be made with the pointed eraser.

The easel should be so placed that the light falling on the white tablet will be reflected to the eye of the artist through the inclined glass on which the picture rests, and consequently the picture will be illuminated by *transmitted* light.

The easel may stand on a table placed against a win-

dow into which the sun does not directly shine. The little screen which fits the easel is to guard the eyes of the artist from extra light which comes from above the easel.

Although the pigments in our list are so few in number, yet with these, by proper admixture, *all* the colors can be made.

To mix these colors for painting we will suppose we take from one of the tubes a quantity of color of the size of a small pea, to which we add about half as much Canada balsam, and one or two drops of siccatif. The use of the balsam is to make the colors *transparent*; the siccatif is simply a *drier*, and of this last we should always use as little as is consistent with the colors drying in a reasonable time.

If a picture involving a variety of colors is to be painted, it is best before commencing the work to prepare not only the simple colors in the tubes, but also some of the most important mixtures, as follows:

*Greens.*—Prussian blue and Italian pink. (To make a dull green, use some burnt sienna with the above.)

*Orange and Flesh-tints.*—Italian pink and crimson lake. For some shades add burnt sienna.

*Browns.*—Italian pink, Prussian blue, crimson lake, and burnt sienna.

Any shade of brown or neutral tint can be made by the use of these pigments in various proportions, which can only be learned by experiment.

Having prepared the colors on the glass slab (mixing well with the palette-knife), and the drawing being all ready, after dusting we proceed to apply the first coloring.

If the subject is a landscape, the first thing to paint is the sky. A little color, slightly thinned with ol. turpentine, can be applied with two or three strokes of a wide brush. It does not answer very well to torture

the color with the brush after it is once applied, so we must be able to do what we wish with a *very* few bold strokes. We don't mind about trees, spires, &c., we can take the sky tint off from them where we wish to do so afterwards (before the color is dry) with a sable brush, *slightly* moistened with ol. turpentine, but the brush must not contain enough to *spread at all* on the surface, otherwise the color will flow away from the line we wish to establish, and form a ridge on the sky.

A better way to apply sky tints is to stipple or daub the surface with a little paint on the end of the finger. In this way all the finest skies are painted by the best artists who make pictures for the magic lantern, but the process is one that can only be learned by many trials and much practice.

After the sky is painted and removed from places where it is not wanted, distant hills next receive our attention, successively working upon objects nearer and nearer, until the whole picture has received its first painting. Except for skies the colors will not need thinning with ol. turpentine.

The picture should now be put out of the way of dust and sunshine, and where it will dry. The next day such parts as need can be repainted, and, if necessary, any successive number of coats can be applied, allowing a day between each for the paint to dry. When completed, it only remains to put on a mat and cover and fasten the edges with paper strips. *Flour paste* (too stiff to allow moisture to be drawn up between the plates) is the best.

When in use, that is when changing from one color to another, the brushes can be cleaned with ol. turpentine. But when the brushes are to be put away, they should be washed with warm water and soap, rinsed with *clean* water, and then brought to a point to dry.

The preceding article on drawing and painting magic lantern slides has been contributed by an expert pre-eminently qualified to assist us in overcoming its apparently insuperable difficulties.

It may be proper here to state that we now furnish a varnish to take the place of No. 1 and No. 2, which answers equally well with but once flowing. Like No. 2 it must be dried by heat to prevent what is called "chilling." The operation can be best performed in a dry atmosphere which is free from dust.

**A COPYING CAMERA.**—A private letter from Prof. W. A. Boles, of Shelbyville, Ind., Superintendent of Schools, contains further valuable information in this direction, and a description of a new instrument of his own invention. By permission the following extracts are given in the interest of home production.

"With this mail I send you a specimen of my drawing on gelatine-coated glass, for use in the Sciopticon. After the coating of gelatine is perfectly dry, I sand-paper it with the finest article I can get, and after the picture is drawn, float it with your No. 1 varnish. . . .

"I made an upright camera-obscura, using the lens from the Sciopticon. The picture to be copied is placed beneath, in the sunlight if possible, and the image is thrown upward so that I can trace the outlines quite at my ease. On the roughened gelatine a fine steel pen and the ordinary black ink I am now using mark beautifully, and the shading is done with a lead pencil. By tracing the image of the picture, in the little darkened chamber, I avoid the trouble from the slipping of the glass and the different angles of observation consequent upon superposition. This plan has also the additional advantage of enabling me to reduce or enlarge a drawing to any desirable size.

“The accompanying rude drawing will give you some idea of the plan.

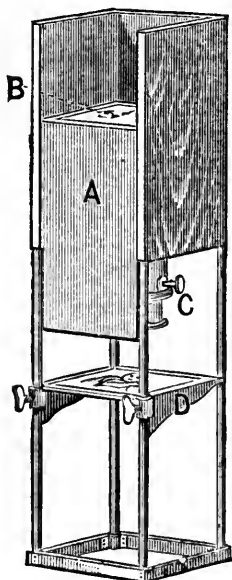

Fig. 31.

“The front *A* and the rest *B* are connected by two iron braces and slide up and down, for the desired focal distance, above the lens *C*. The adjustable shelf *D* supports the object to be copied. The glass plate is laid upon the rest *B* over the opening, and a black cloth thrown over the top. The instrument is six feet in height, and eighteen inches square, and cost me about two days' labor. It is highly satisfactory.”

It will be understood that the object of roughing the gelatine, as indicated in the above letter, is that it may present an opaque surface to render the image visible, like the focusing ground-glass in a photographer's camera; this roughing also gives it a “tooth” to hold the markings.

Ground-glass itself is sometimes used for obtaining drawings by superposition, which is rendered transparent by a coat of varnish, and it might be used in this case; it is, however, somewhat expensive. A surface is now produced on glass quite similar by what is called the ground-glass varnish. This surface after receiving the drawing may also be rendered transparent by a coat of common varnish, if dried in sufficient heat to prevent its again becoming opaque.

**ASPHALTUM VARNISH.**—This common black varnish, flowed upon quarter-plate glass and allowed to dry, gives a surface which can easily be drawn upon with a

sharp instrument so as to show upon the screen in smooth white lines upon a dark ground. The varnish must be thinned with turpentine, to allow of tracing by superposition.

This process, obtained by purchase, is given for the benefit of teachers, who will find it admirably suited for maps, diagrams, and any so-called blackboard exercises.

ORDINARY TRANSFERS UPON GLASS.—Coat, by preference, quarter-plate B. P. C. glass on the hollow side with transfer varnish, and let it partially dry. Take any cut of proper size, place it upon water right side up until it becomes wet to saturation, adjust it to the varnished surface face down, rub up the paper in rolls until it is mostly removed, and then lay it aside until the varnish becomes hard. Much of the remaining paper can now be removed without damaging the picture, by carefully wetting and rubbing.

Grecian varnish will render the picture transparent; but unfortunately innumerable pimples make their appearance, which show badly on the screen, caused by the loosened fibres of the remaining paper film. Several coats of varnish will finally leave a smooth surface, but so thick a coating will before long crack and eventually peel off.

This process is here referred to because it is so often inquired about, rather than because it is thought to be of much value.

DIAPHANIE.—A picture on thin, smooth paper, treated as above, but without rubbing off any of the back surface or even roughing it up, will make a tolerable lantern slide, with one coat of the varnish. It will appear dark on the screen like a silver print that is very much "fogged." If the picture is pasted to a frame

without glass, and varnished, it appears rather better with less cost.

**DECALCOMANIA, OR ENAMEL SLIDES.**—Impressions made on starched paper and fixed to glass, as above described, will adhere to the varnish when the paper is afterwards wet and pulled off entire. After soaking off the starch, by flowing water and a soft brush, the picture is dried and flowed with ordinary slide varnish. These so-called Enamel Slides are inferior to silver prints, and are sold, both plain and colored, at a cheaper rate.

Should the paper prints, in good variety, eventually be sold to the public, full directions for transferring them would doubtless also be supplied. On this supposition only, would this truly interesting process promise to become available for amateurs.

**TYPE PRINTING** upon glass, except in a poor way with elastic type, is impracticable. Hymns, mottoes, &c., may, however, be printed to advantage upon sheet gelatine, in the small amateur printing-presses now so much in vogue. Plain collodion films, dried upon oiled glass, upon a levelling stand, and peeled off, will take impressions perfectly. These films may be mounted between glass plates, in the form of a crystal slide.

**WITH QUARTER-PLATE GLASS** prepared as described to receive, like paper, not only colors but pen and pencil drawings, we may copy engravings for the lantern by superposition, or in a camera similar to the one illustrated by Fig. 31, may show up, as by magic, all that class of illustrations now in vogue as "blackboard exercises;" may suit original designs to the various circumstances of time and place; may transcribe hymns, mottoes, &c., appropriate to each occasion; and so, with small expense and ordinary skill, the Sciopticon becomes



readily available, without the purchase of a large assortment of slides.

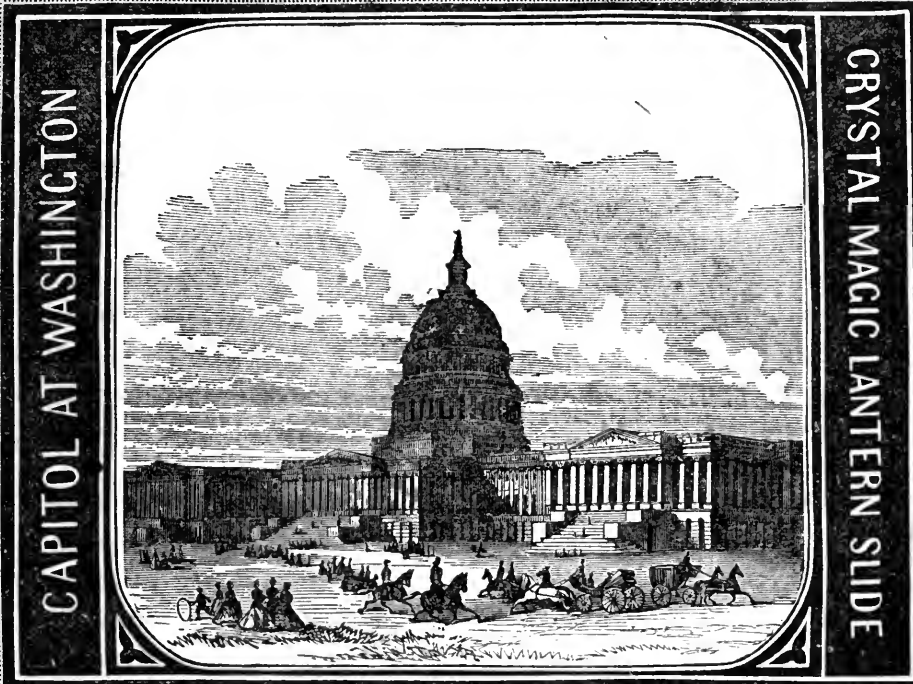

*Fig. 32.*

The cut (Fig. 32) shows the exact size and shape of the transparency, mat, glass, and the binding of the Woodbury (photo-relief) magic lantern slide, of the colored crystal slide, and of such as are made according to the directions given in this chapter.

Pen and pencil drawings would require only Nos. 7, 8, 9, 10, 19, 20, and 21, of the materials enumerated on page 138; or, simpler still, the glass may be obtained, ready prepared, for 75 cents a dozen, the drawings made with any quite black ink and a fine pen, and shown without glass cover, mat, or binding.

## CHAPTER XI.

**NOVELTIES.**

**THE CHIMNEY CAP** of the Sciopticon now telescopes into its base, so as to give added length and greater draft when drawn up. It should not be elongated, however, when the instrument is first lighted—especially if the wicks are not well saturated with oil—but when well under way, the added length, with a corresponding turning up of the wicks, gives greater brightness, and more effectually draws off the heat.

**THE SCIOPTICON CURTAIN.**—Turning the milled head at either side, gives the appearance upon the screen of a curtain rising, or falling, thus handsomely opening or closing an exhibition. It may also be temporarily closed at any time, to allow the attention to be directed to other exercises.

The process of changing the pictures may be hidden from view by shutting off the light with the left hand; then pushing the out-going picture into the left hand by sliding another into its place with the right; and then flashing on the light with the right hand; all of which may be sooner done than said. In any change of programme the awkwardness of showing the “full moon,” or the disk without a picture, may always be avoided by using the opaque curtain.

This curtain also serves as a back cap for the objective, protecting the back lens from dust and light when not in use, as the front cap protects the front lens.

**THE SCIOPTICON TINTERS.**—The tinting-glasses are drawn up close behind the objective lens by means of rods terminating in knobs above. This lets the color down upon the screen—not with a sharp outline like the curtain, but with a gradual shading. With the blue tint partially drawn, this property gives to plain photographs of scenery, a blue sky, shading off without abruptness down to the horizon. Slightly drawing up the blue, then the red, and then turning the button attached to the opaque curtain a little, fades away gradually the upper portion of the disk, as is desirable in such slides as the Ascension. The reverse movements bring into view gradually the “Soldier’s Dream,” “Angel of Peace,” &c., nearly as well as with two slides in the dissolving lanterns. All the appearances formerly produced by colored glass slides are better effected by these tinters. If at any time the rods become too loose, the *stop* screws may be tightened.

**THE NEW SLIDE STOP.**—The catch drawn out from the underside of the stage, and turned back almost out of the way, is intended to stop the slide in its proper position, but not to interfere with its being moved smoothly along and out by the incoming slide when slipped forward from the catch by the left hand.

The catch pushed back into its sheath, leaves the stage entirely unobstructed for those who prefer to adjust the slides by hand only, and for other than wooden slides.

The use of stops is the more necessary with a pair of instruments, as it is essential to a proper effect that the dissolving views should occupy exactly the same place on the screen without any readjustment after the dissolving becomes visible.

**LARGE SLIDES—A NEW DEPARTURE.**—To improve the size and brilliancy of a Sciopticon exhibition, the expedient, next to perfecting the instrument itself, is to bring into use larger and clearer views.

A magic lantern picture of the standard size is 3 inches in diameter, mounted in a frame 7 inches long by 4 inches wide. The new picture is  $3\frac{1}{2}$  inches in the clear, in a frame 7 inches by  $4\frac{1}{4}$  inches.

The new picture having a third more surface, the illuminated disk shows larger in proportion and to very much better advantage. No one seeing an exhibition of the new slides, would willingly select from the old.

No inconvenience arises from using both kinds in the same exhibition. The larger frame, reaching a little higher than where the spring meets the condenser, slides more smoothly into place.

Great pains has been taken to get the best subjects with which to inaugurate this new departure, and to have them worked up in the most artistic style.

**MARCY'S EIDOTROPE.**—Two disks of perforated tin are mounted so that one extends beyond the frame to the right, and the other to the left; and so, not having a common centre, an eccentric revolution is given to each, little by little, when moved by the fingers at either side of the lantern, producing upon the screen a great variety of strikingly beautiful patterns, which may be pleasingly modified by a varying use of the tinters. Its simplicity, however, may be against it, for *effects* are quite apt to be valued in proportion to their cost and trouble.

**WHEEL OF LIFE.**—In the English Wheel of Life, in its best form, the opaque disk with the open section, as seen in Fig. 33, is revolved rapidly, while the transpar-

ent disk, covered with figures in varied positions, is revolved with less rapidity in the opposite direction.

Our improvement consists in having the distance of the crank wheel adjustable, and in having only one band doubled back to run both wheels, so that the tension of the band can be regulated, while both effect wheels are subject to a band of like tension.

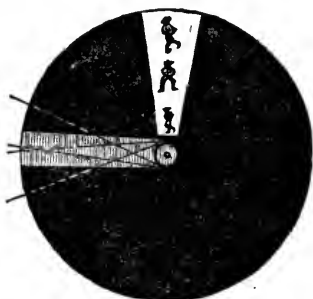

Fig. 33.

Four adjustable disks of figures, viz.: the Fishers, the Skaters, the Giant's Ladder, and the Bottle Imp, are now included in this new apparatus; each, when used, being held in place by a wire ring sprung into a surrounding groove.

**THE DANCING SKELETON.**—This effect is produced by having, say six transparencies of a skeleton, in as many different postures, set in a large disk, as shown in Fig. 34. Giving this wheel  $\frac{1}{6}$  of a revolution at a time, brings the figures one by one into position to be projected upon the screen, while a revolving opaque disk hides the passing off of one, and the coming on of another, making it appear as if the same figure were keeping time to the accompanying music, by striking grotesque attitudes.



Fig. 34.

The thousands who witnessed this *striking* feature of Prof. Pepper's late American lecture tour, seemed fully to enjoy the worth of their money.

It is but fair, however, to observe that the machine is complicated and cumbersome, and that it doubtless fascinates more for its novelty than for its intrinsic value

Having the only dancing skeleton in America, and that well enveloped in mystery, is quite different from having the apparatus explained in print, and offered for sale at \$30.

**THE DANCE OF THE WITCHES.**—Paper witches are put into the cell (Fig. 35) and the picture of a cauldron is drawn upon its outer face. This cell is filled with water, which, with the floating witches, is made to circulate about the pot by means of pipettes with rubber bulbs, reminding us of the scene in *Macbeth* :—

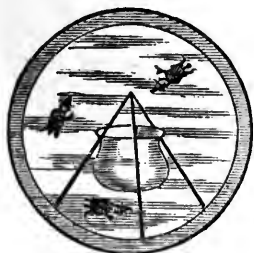

*Fig. 35.*

“Roundabout the cauldron go ;  
In the poisoned entrails throw,—  
Double, double, toil and trouble,  
Fire burn, and cauldron bubble.”

**THE BEEHIVE.**—Upon the fixed glass, a beehive and shrubbery are artistically drawn and colored. Two disks of glass covered thickly with figures of bees on the wing are revolved in opposite directions, presenting upon the screen a very lively appearance.

**THE AQUARIUM.**—Upon the fixed glass, an aquarium with dark background is drawn, while fish are made to appear as swimming back and forth, passing and repassing each other, by revolving in opposite directions, the disks upon which they are painted.

**THE FOUNTAIN.**—The appearance of a fountain in full play is produced by revolving over the face of the picture disks of glass covered with crinkles.

**THE ROCK OF AGES.**—A dark and stormy sky, and the waves dashing against a stone cross (the Rock of Ages),

are here represented. A wreck is seen in the distance. The wreck disappears, and the figure of a woman appears clinging to the cross.

The following four pairs of effect slides for the double lantern, with sliding movements (price \$6 a pair), are quite popular at present, but they are difficult to operate satisfactorily.

**THE NAIAD QUEEN.**—View of a lake by moonlight. The moon glistens on the water; a castle is seen in the distance. The Naiad Queen appears sailing across the lake in a pearl shell boat and playing on a harp. (Music can be used very effectively with this view.) Two slides, with movement.

**TRAIN OF CARS.**—A railroad bridge in a dark forest is seen by moonlight. A train of cars dashes by, the headlight, and sparks flying from the engine, making a very brilliant appearance. Two slides, with movement.

**OCEAN STEAMER.**—A view of a harbor is represented, with a city in the distance, from which an ocean steamship, bound for Europe, sails away. Two slides, with movement.

**THE SERENADE.**—A beautiful view by moonlight of a lake, on the borders of which is seen a castle brilliantly illuminated. The serenader appears sailing in a gondola and playing a guitar. A lady steps out upon the balcony of the castle and listens to the serenade. (Music can be used in connection with this effect.) Two slides, with movement.

Each of the following effects is shown either with one slide in a single lantern, by means of tinters and curtains, or with two slides in a pair of dissolving lanterns.

WASHINGTON'S DREAM.—Washington, tired by the duties of the day, in his room seated by the table, has fallen asleep. The camp is seen through the open door. The vision of Columbia, attended by Justice and Plenty, appears in the sky.

THE SOLDIER'S DREAM.—This is best told in Campbell's Poem, beginning:

“ Our bugles sang truce, for the night cloud had lowered,  
 And the sentinel stars set their watch in the sky ;  
 And thousands had sunk on the ground overpowered,  
 The weary to sleep and the wounded to die.  
 When reposing that night on my pallet of straw,  
 By the wolf-scaring faggot that guarded the slain,  
 At the dead of the night a sweet vision I saw,  
 And thrice ere the morning I dreamt it again.”

MERCY'S DREAM.—Mercy is represented in a reclining position beneath a spreading tree. An angel from Heaven appears and places a crown of glory on her head.

ANGEL OF PEACE.—A beautiful landscape showing a city at night, with the new moon in the sky reflected in the water. The figure of an angel bearing a child appears like a vision in the sky, and then fades away.

THE FAIRY GROTTO.—A view looking out from a grotto into a lake, upon the surface of which are interspersed rocks and trees in a picturesque manner. A fairy with wand is seen in the foreground. The moon appears from behind the clouds and its reflection is seen on the rippling waters.

THE WIZARD'S GLEN.—The wizard and his attendant fairy are seen in the foreground of a picturesque glen in the mountains. The moon glistens on the crest of a cascade, which falls from the summit of the rocks.



## CHAPTER XII.

**The Lime Light.****INTRODUCTION.**

THE Lime Light in an improved form having been introduced into the Sciopticon, it becomes expedient to append to the Sciopticon Manual a description of the apparatus and directions for its use.

**FLAME ILLUMINATION.**

We have in the Sciopticon oil lamp arrangement the largest amount of ordinary flame illumination that can, to advantage, be brought to bear upon the screen through the objective lens, and as bright as air with its twenty per cent. of oxygen will make it.

Brightening the two flames by an inner supply of oxygen gas, after the manner of the Bude light, heats the wick tubes to an unsafe degree, and consumes too much oxygen as compared with the efficiency of the illumination.

Some solid matter, of which quick-lime seems to be the best and cheapest for the purpose, is more luminous in an intense heat, than simply the particles of burning carbon floating off in flame.

**VARIETIES IN LIME LIGHT.**

Every lime light alike has lime and a jet of oxygen gas; but a variety arises from the different conditions of the hydrogen employed. With alcohol vapor, it is commonly called the oxy-calcium; with house gas led

directly from the bracket, it is sometimes called oxy-hydro-calcium. To produce the light more generally known as the oxy-hydrogen, both gases are forced upon the lime from reservoirs under equal pressure, and through a common jet.

In absence of well established and distinctive terms, we seem obliged to fall back upon the only elementary distinctions, as alcohol, house gas, and mixed jet; or simply Nos. 1, 2, and 3.

### THE ALCOHOL BURNER.

The lime light produced by a jet of oxygen gas through an alcohol flame, as now used with improved effect in the Sciopticon, is suited, next to the Sciopticon oil lamp, to the widest range of circumstances.

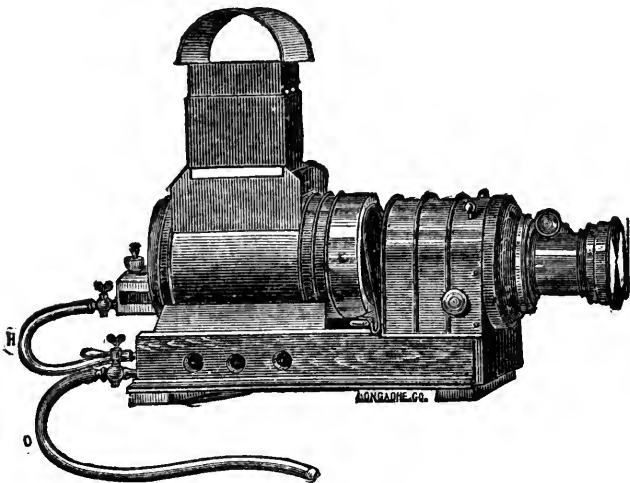

*Fig. 36.*

The alcohol fountain at the side of the Sciopticon is shown in the above cut as drawn back, so as to be partly seen. It is connected with the triple blow-pipe at the

hydrogen stop-cock by a piece of rubber tubing, *II*. The tubing, in connection with the oxygen stop-cock, extends downward towards its connection with the oxygen bag, or cylinder, which is not here shown.

The alcohol passes through a side aperture, *h*, up the nozzle *n* (Fig. 37), to its level in the cylindrical wick-tube *a*, filling it about two-thirds full, and saturating the wick *w*, which loosely fills the space between the concentric tubes.

If on lighting the wick (which is done by reaching it in the lantern with a lighted match) it burns feebly, for want of being fully saturated, we may give the flexible alcohol tubing, *II* (Fig. 36), a sliding pressure towards the jet, being careful not to overflow the wick tube. The alcohol should be of the best quality, and high enough in the fountain to feed a vigorous flame.

The atmosphere, while supplying oxygen to the outside of the flame, compresses the inner hydrogen vapor into combination with the jet of oxygen as it strikes upon the lime above.

When the exhibition is over, we may let the fountain hang down by its tubing till the alcohol drains back into it, before closing the stop-cock.

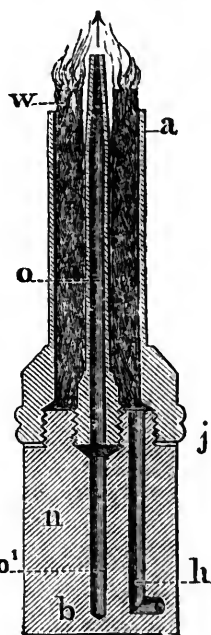

No. 1, Fig. 37.

### THE HOUSE GAS BURNER.

In towns and wherever illuminating gas is in supply, it may be led by flexible tubing from the bracket to the blow-pipe, and so through the same side aperture, *h*, in the nozzle into the conical tube *g* (Fig. 38), burning above the oxygen jet *o* like the alcohol flame in No. 1.

While the amount of the alcohol flame depends on the height of the fountain, *this flame* is easily regulated by the hydrogen key to the exact amount required by the oxygen.

The oxygen, shooting up like the middle arrow from the *flat-mouthed jet*, *o* (see its shape, front view, Fig. 39), combines with the hydrogen instantaneously as it strikes the lime, with little tendency to cool and blacken a central spot.

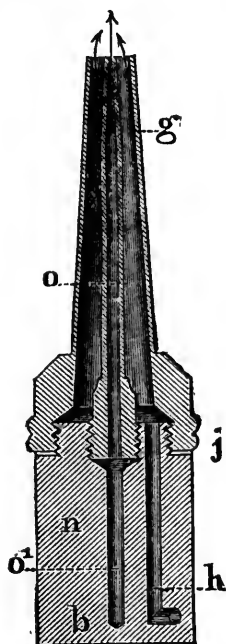

No. 2, Fig. 38.

#### THE DRUMMOND LIGHT.

Lime rendered incandescent by the ignited jet of an oxy-hydrogen blow-pipe, invented by Dr. Hare, of Philadelphia, and used with marked success in the British Signal Service, by Lieut. Drummond, has been called the Drummond Light.

This term applies distinctively when a collected supply of hydrogen gas, as well as of oxygen, is required, and when both are alike under heavy pressure and forced through the tubes of the blow-pipe.

Oxygen and hydrogen, mixed in a common reservoir, cannot be safely used in connection with an ignited jet.

The separate gases, however, may be forced upon the lime through entirely separate jets, in accordance with the primitive arrangement; or, which amounts to about the same in effect, the two currents may terminate in tubes one within the other, called the concentric jet, mingling as before only when projected upon the lime; or, which is counted the most effective and is now in general use, the oxygen and hydrogen may be mixed in

a small chamber, as at *c* (Fig. 39), at the foot of a single jet through which the mingled gas is projected upon the lime.

### THE MIXED JET.

The mixed jet is the only one of the Drummond variety superior in effect to Nos. 1 and 2, and this we adopt as the No. 3 of the triple blow-pipe.

The mixed jet tube, *m* (Fig. 39), takes the place of both the tubes of No. 2, covering both apertures at the junction, *j*.

The oxygen gas forced up through the central aperture *o'*, in the nozzle, instead of being taken direct to the lime by the jet tube, as in Nos. 1 and 2, is allowed first to mingle with the hydrogen forced in with equal pressure at the side aperture.

The relative quantity of each gas is regulated by the stop-cocks till the best effect is produced, which, in theory, is when there are two volumes of pure hydrogen to one of oxygen, or about equal volumes if coal gas is used.

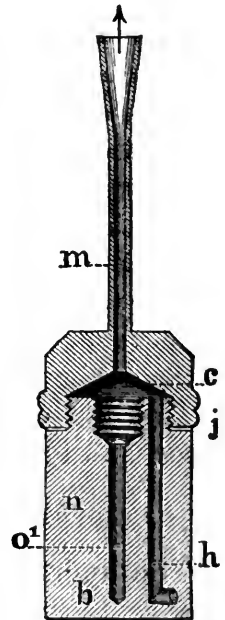

No. 3, Fig. 39.

### DANGERS PECULIAR TO No. 3.

Serious accidents in operating the mixed jet are mostly occasioned by carelessly collecting or transferring one kind of gas into a bag partly filled with another kind, and then attempting to use it in connection with an ignited jet. It is common to distinguish the bags by the letters *H* and *O*, and it is further recommended to

use a characteristic stop-cock on each, so that there can be no mistaking them, even in the dark.

By very unequal pressure, gas from one bag may be forced through the cavity, at the foot of a clogged jet, into the other bag, from which it meets no counter current. To get up an explosion in this way would require patience, and either a surprising degree of carelessness, or else considerable skill directed to this end.

It should become habitual to turn off the oxygen at least, when the light goes out, and to turn it on only after the hydrogen is lighted.

Stuffing the cavity of a mixed jet with wire gauze is now discarded as not only useless but as often interfering with its successful working.

Passing the gas through a small wash bottle is designed to prevent the back flow of gas or flame. The same advantage is claimed for a valve in the tubing, open towards the jet but closing against any back current.

The best expedient, however, is to use good apparatus, and to exercise common care.

#### **ANNOYANCES PECULIAR TO THE MIXED JET.**

The hydrogen flame is somewhat liable to be blown out by too abruptly turning on the oxygen. In this case we have but to turn off the gas and proceed again with more care.

The mixed gas in the cavity *c* sometimes explodes and the ignition may continue within the cavity. Whether the flame is extinguished by the explosion or not, the oxygen should be at once shut off; the jet, if hot, should be cooled, by waiting or by wetting it, and the adjustments should be revised and regulated. This accident may result from irregular pressure, from turning on the oxygen before lighting, or from neglecting to turn it off before re-adjusting the pressure boards.

None of the accidents or annoyances above enumerated have ever happened with the jet herein described. Its characteristic flat mouth, small cavity, and ready adjustments are in its favor, but may not be relied on in spite of bad conditions. It will be observed that this possibility of evil in the mixed jet, as distinguished from Nos. 1 and 2, arises from the necessity of having two gases in bulk, and from mixing them before coming to the outlet.

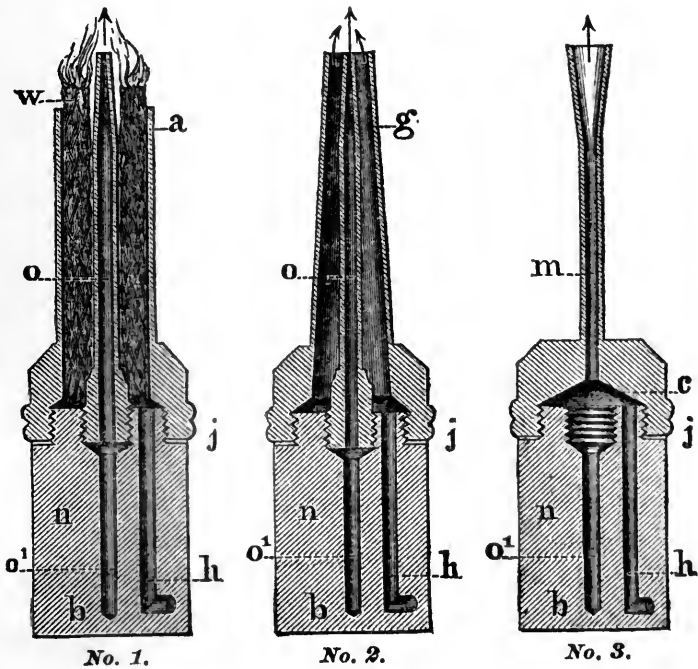

THE THREE JETS presented above, side by side, show what is peculiar to each. The oxygen tube of each is screwed down upon its lead washer, so as to present its flat mouth to the lime, as shown in No. 3.

When a very strong current meets with roughness at the mouth of a jet, or strikes some impediment, or an

unsound place in the lime, it sometimes produces a hissing sound. Moving the lime or varying the pressure will, in most cases, abate the annoyance.

### MARCY'S TRIPLE JET.

In this apparatus, the three burners already described are interchangeable.

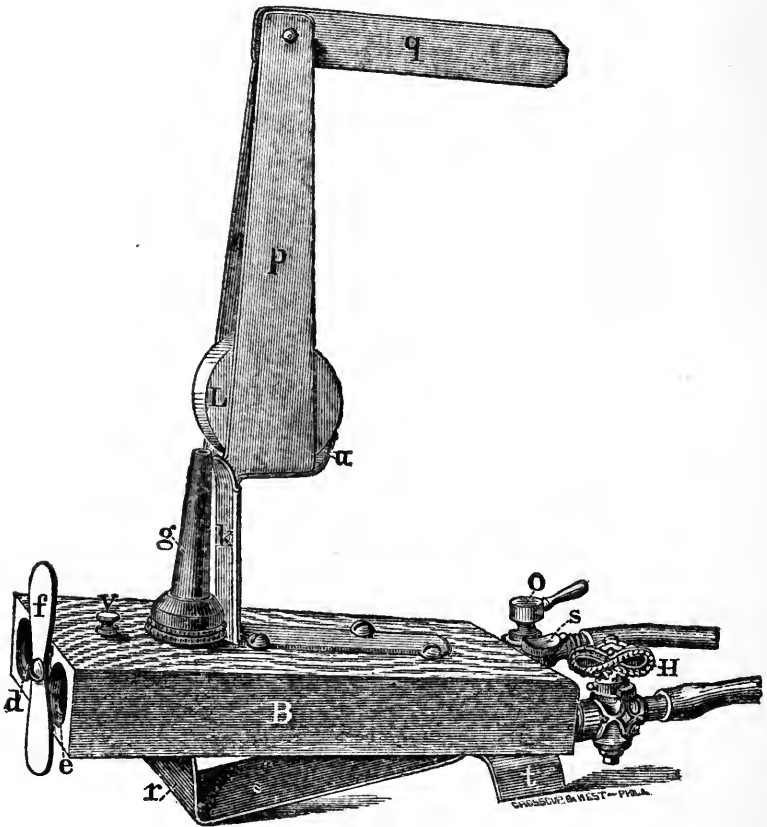

*Fig. 40.*

Fig. 40 represents the house gas-burner in position, while Nos. 1 and 3 are in the cells *d* and *e*, to be shut in by the cover *f*. The broach in the cell *v* is in proper



shape for entering and clearing the flat mouth of the jet. The wooden base-plate *B*, the bottom of which is shown at Fig. 41, holds the nozzle *n*, which receives into its middle aperture the current of oxygen gas from *O*, and into its side aperture either alcohol or hydrogen gas from *H*. The lime *L*, in its holder *P*, is let down the open chimney of the Sciopticon and held in place by the socket *k*, the elongated top of which serves as a guide to the stem, a rest for the lime cradle *u*, and a shield from the alcohol wick. The base-plate of the socket is pushed under the screw-heads, into contact with the nozzle *n*, and its angle and its height are such as to bring the lime disk into proper position.

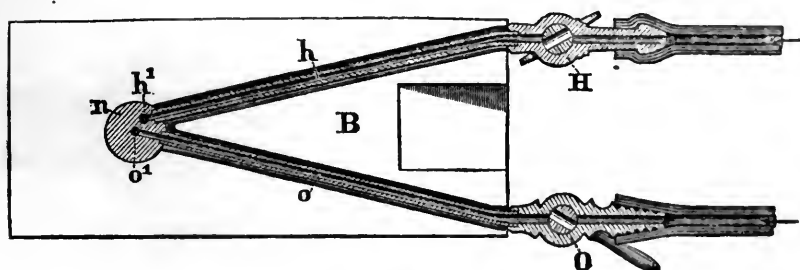
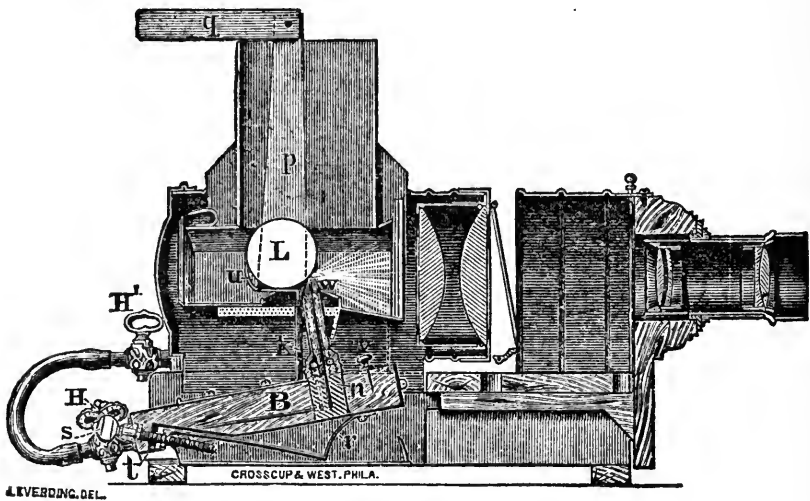

Fig. 41.

The lime disk is  $\frac{1}{8}$  of an inch thick, and 2 inches in diameter. It lies loosely in its cradle *u*, so that lifting the back with the thumb and finger half an inch or so, brings down to the jet a new but hot place in the lime. This operation is not hard on the fingers, because the move is so easily and quickly made, and at a place in the non-conducting lime most distant from the jet. The handle *q*, turned back from the heated current, gives us control of the lime holder, so it can be let down the Sciopticon chimney into its socket *k*, Fig. 42. This height is convenient, but not essential in the Lime-light Sciopticon, Fig. 43. For other lanterns the handle is hinged lower, as at *p*.

**THE OIL-LIGHT SCIOPTICON, WITH THE TRIPLE JET.**

The jet may take the place of the oil lamp, Fig. 42, without changing the construction of the Sciopticon. It is not so convenient for the jet as the form shown in Fig. 43, but its original peculiar advantages are not sacrificed. With the Sciopticon complete, as illustrated and described at page 30, we remove the back flame-chamber glass  $G'$ , the narrow strip  $F$ , the chimney cap  $J$ , and the oil lamp  $S$ .

*Fig. 42.*

With the lime light the front glass  $G$  is only useful to protect the condenser; if retained, it should be glass without the cut as commonly used, or else clear mica. With a concentrated light every blemish shows upon the screen.

Removing the lime holder from its socket we insert the blow-pipe by dipping the jet under and into the flame-chamber, and letting the lime with its holder down the open chimney into its place again, as shown (Fig. 42).

The lime, spaces, and lenses, and the adjustments peculiar to the alcohol, the concentric, and the mixed jet, will

receive attention in the following pages, in connection with the Lime-light Sciopticon.

### **THE LIME-LIGHT SCIOPTICON.**

The unrivaled excellence of the Oil-light Sciopticon consists in its serving us, not with a lime-light equivalent, but with flame at its brightest, arranged at its best, and in its being always available with but trifling expense and trouble.

Without interfering with this special arrangement, an intense light may be used in it, as explained on the preceding page; but the distinctive Lime-light Sciopticon, Fig. 43, drops the flame-chamber, and takes on parts peculiar to itself. To have the full advantages of both arrangements, therefore, requires two instruments; but if the lenses and draw-front are not duplicated, the two involve but little extra cost. (See appended catalogue.)

Fig. 43, page 168, shows the exterior of the Lime-light Sciopticon, the internal arrangement being indicated by dotted lines. Comparing it with the preceding, or with Fig. 15, page 30, it is seen that the wooden base, the lower and front part of the cylindrical body, the condensing lenses with their peculiar mounting and attachment, the draw-front with hood, opaque curtain, tinters and objective, are precisely the same, and so call for no further description here. An obvious difference is the absence of the lamp, flame-chamber and chimney, leaving a vacant chamber for the triple jet and the automatic winker. The peculiar cut-off called the winker, and the slide frame, which is an appendage of it, will receive attention further on, in closer connection with Figs. 43 and 44.

### **TRIPLE JET ADJUSTMENTS.**

The Triple Jet described page 158, Fig. 40, enters its chamber freely, Fig. 43, and is kept in place with sufficient

firmness by the feet *tt*, fitting closely into the side grooves when nearing its proper position, and resting flush with the entrance when about in place, leaving about half an inch of the wooden base projecting behind.

Oxygen gas in a bag between pressure boards weighted by from fifty to one hundred and fifty pounds, or else compressed in a condensing cylinder, is put in connection with the oxygen jet at the stop-cock *O*, known by its lever-shaped key. The oxygen should be habitually the last to be let on, and the first to be shut off. The mouth of the jet should be kept clear by the broach *v*, and the tubing should be kept free from kinks. The oxygen arrangement is the same for each of the three burners.

*For the alcohol-burner* the wick tube, No. 1, Fig. 37, loosely filled with wicking reaching to the height of the jet, is put in connection, by a piece of rubber tubing, with the adjustable fountain at the side of the lantern. When the fountain is full the wick tube is about two-thirds full. The alcohol is kept to this level by screwing the base with one hand, while the fountain is kept from turning by the other; taking care not to lift it so as to overrun the wick tube.

The lime-holder may be supported as in the Oil-light Sciopticon, Fig. 42, but a special holder for No. 1 burner is now preferred, with a half cylindrical stem, which, instead of setting into the socket *k*, fits over the wick-tube and about the wick, to vaporize the alcohol more freely by its heat.

*For the gas-burner* the conical tube *g*, Fig. 40, is substituted for the wick tube, and connection is made with the house gas fixtures by sufficient length of flexible tubing. This arrangement is to be preferred where house gas is at hand; it is safe, easily controlled, and scarcely inferior to the mixed jet in efficiency.

*For the mixed jet*, connection is made with hydrogen, in

bag or cylinder, subject to the same amount of pressure as the oxygen. House gas collected from the burner is mostly used, when obtainable, to save the trouble and expense of generating pure hydrogen, which is but little if any better.

#### LIME-LIGHT ADJUSTMENTS.

The lime wheel is two inches in diameter and five-eighths of an inch thick, so that the available surface at its circumference is six inches long by five-eighths of an inch wide. These wheels, lying one upon another, are kept dry in an air-tight box shaped to a dozen of them. Lime is less liable to crack if thoroughly dried before using, as upon a hot stove or upon live coals, or, as is usual, in the hydrogen flame.

After lighting the hydrogen (vapor or gas) in moderate force, and allowing it time to heat and dry the lime, the oxygen is turned on till it nearly cuts down the flame, producing an incandescent spot on the lime wheel, which is struck obliquely on the rim just below the middle of the front, about a third of an inch from the mouth of the jet; it may be brought somewhat nearer if the mixed jet is used. The direct light cannot be seen from behind, but its comparative intensity and its distance from the jet are distinctly seen, without harm to the eyes, as reflected from the surface of the condenser. The upper part of the lime wheel and the inclined cap and door, front and back of *C'*, Fig. 43, intercept the light in the direction of the open top, while the upward draft, the range of the jet, and the side screen plates (not shown in the cut) all favor the ready escape of heat.

To adjust the light precisely, focus a picture upon the screen and remove it, push forward the light till a bluish ring appears upon the disk, which is made even about the centre by regulating the height by the screw *S*, then draw back till the blue disappears, which, if the lenses are pro-

perly matched and in line, will be just before the margin would become tinged with yellow.

When ready to project the views, intensify the light, if necessary, by letting on more hydrogen followed by more oxygen, till exactly the best effect is produced. During the exhibition, when the lime begins to fail at the point exposed, lifting up the back of the wheel about half an inch will bring down a fresh but hot surface into place, which may be done to advantage once in five or ten minutes, more or less, according to the quality of the lime and the force of the jet. The wheel lies loosely in its holder, and being a non-conductor, is not very hot at the back, so it can be conveniently turned by the thumb and finger.

#### RATIO OF SPACES.

In the ordinary Sciopticon arrangement, the spaces in inches are about 3 from the focus of illumination to the first face of the condenser, 2 through the condenser, 5 between the condenser and objective, and 3 through the objective tube. The focus of the condenser is 3, or the back focus, 2; that of the objective is  $5\frac{1}{2}$ , or from the back glass,  $4\frac{1}{4}$ . The conjugate foci of the condenser, measuring from the light to about 3 inches front of the objective, are 4 and 12. The conjugate foci of the objective, measuring from the picture slide to the screen, 20 feet away, are about 6 and 240. Multiplying the diameter of the slide picture 3 by the ratio  $\frac{240}{6}$ , gives 120, or 10 feet; so, in general, the diameter of the disk on the screen is about half the measure of its distance. For example: if the screen is 9 feet wide, the instrument may be 18 feet away. If the slide pictures vary in size, the images, of course, will vary in proportion.

With the long focus arrangement, for long distances, a condenser is used of  $2\frac{1}{2}$  inches back focus, and an objective of 10 inches back focus. With these lenses the diameter

of the disk on the screen is about one-quarter of the distance away; so that, to get a 20-foot disk, the instrument must be 80 feet away, a 15-foot disk 60 feet away, etc. The back cell of the objective in more common use may be removed, which gives nearly the same result as to spaces, but the margin of the image will lack distinctness, and will be tinged with yellow.

There is some call for an objective of shorter focus, to be used behind the screen, where there is but little room. A corrected lens can be supplied, giving an image about the measure of the distance, but with less perfect definition. Non-achromatic objectives are easily made with short focus, because they are not combined with the flint-glass dispersing lenses to correct the aberrations.

Some more of the light may be rendered available by placing it, say two inches from the face of the condenser; but much of the gain is lost by its falling on the face of the lens at so near the angle of total reflection. A practical objection to placing the light so near, is the danger of cracking the glass by heat.

Spacing, and other details herein given, are for the Sciop-ticon operator, and may not apply in all respects to other apparatus. As to oil-light lanterns, it seems enough to have described the Oil-light Sciop-ticon. Lime light, however, being more concentrated, and being controlled by more artificial conditions, allows a greater variety of arrangements, and of rival forms of apparatus to compete with each other for public favor. So the Oil-light Sciop-ticon monopolizes a lion's share of our space, for lack of a worthy rival, and the Lime-light Sciop-ticon is exclusive, because the forms of like apparatus are too numerous here to particularize.

**CHANGING THE SCENE.**

The visual image of a pictorial representation, seen under favorable conditions, scarcely differs from that produced by the object itself. It is said that an artist once painted a cherry tree so true to nature that the birds swooped down for the cherries. "See," said he to his rival, "even the birds unwittingly testify to my skill. Now draw that beautiful curtain and exhibit thy production." "That beautiful curtain is my picture," replied the rival. "I am fairly entitled to the premium, for even a competing artist unwittingly testifies to my skill."

The surpassing excellence of projected pictures consists in their presenting, on a large scale, the appearance of reality in a marvelous degree, and in their thus presenting, with the least possible expense and trouble, the objects worth seeing in all the known world, and the scenes worth remembering ever since the world began.

In practice we should avoid, as far as possible, all unnatural appearances and movements inconsistent with this pleasing and profitable realization. A serious drawback, in an ordinary exhibition, is seeing the views shoved in and out, especially if the movement is not smooth and steady. Alas, for seeming reality, when the scenery that is spread out before us in distant and stately grandeur suddenly contracts into dancing shadows on a white sheet. Even dissolving views, by which the change is effected so charmingly, present many incongruities not to be rationally anticipated in the natural order of things. The Lime-light Sciopticon, however, with its automatic cut-off, called the winker, shows no commotion nor commingling, to weaken the stereoscopic effect, nor any blank of appreciable duration, for suspense. It is more in consonance with nature, and is less hurtful to the sight. It seems like closing the eyes on one scene and instantly opening them on another. While



it lacks some of the peculiar mystification of dissolving, so pleasing to the uninitiated, and, indeed, so essential to certain effect slides—showing the change of seasons, the vicissitudes of day and night, etc.—yet its operation is natural and agreeable, and regarded with growing favor; and we have its advantages in a single instrument, simple and convenient, compact and tidy, efficient and comparatively inexpensive.

#### DESCRIPTION OF THE AUTOMATIC WINKER.

It will be seen that the flap or opaque plate *a*, Fig. 43, when raised close to the light *K*, will cut off all the rays from the lenses, and darken the screen as completely as a larger flap at a distance, and that its small size and its position enable it to be operated by a very slight movement. This flap is held by arms *b b*, which, at *c c*, are bent so as to pass out through holes in the lantern body, and prolonged downward, forming on the left (not shown) a long lever by which the flap may be raised by hand, limited by a button and moderated by friction, and forming on the right a short lever *s*, automatically worked by the movement of the slides themselves, as they are changed.

The short lever-arm *s*, of the stop *a*, is freely attached to a light framework, consisting of a thin strip of brass *f*, fastened to wires *r* and *g g*, the latter bent at *t* into a right angle. This frame, attached to the lever *s*, is held by the staple *e* and the rest *o*, whose spring allows its ready insertion or removal. It slides horizontally, in a direction parallel to the lantern body, and so operates the lever *s*, which lifts the flap *a*. The brass strip *f* is bent at its free end into a V-shaped latch *h*, the point of which is outward, and which extends in breadth almost across the opening for the insertion of slides into the slide-frame. The slide-frame consists of two parallel strips *H H'*, Fig. 44, connected

together by uprights *R R*, and having longitudinal grooves, *i i'*, in which the slides will fit. A holding spring *e* crowds in the same direction as the latch, so the slide continues to be pressed against the front side of the grooves. When the slide-frame is in position, held in place by pins *I I*, inserted in the base *A*, Fig. 43, the glass slide is slipped along the

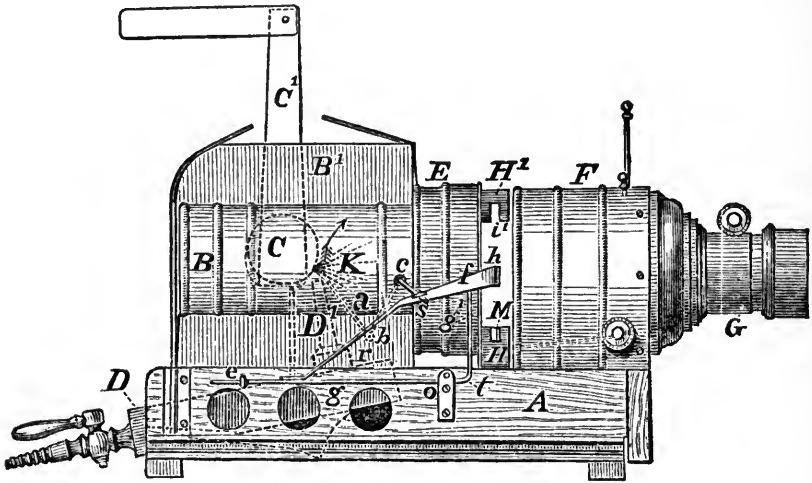

*Fig. 43.*

grooves *i i* from right to left, until it occupies the field of the lenses. To change the picture, a second slide is inserted in the grooves, and pushed after the first by the forefinger, following in the lower groove. As soon as it reaches the V-shaped latch *p*, it pushes the latch and framework *fr g g'* backward, and thus depresses the lever *s*. This motion raises the stop *a*, and cuts off the light until the second slide has pushed away the first and occupied the field. At this moment it releases the latch *p*, when the stop *a* falls by its own weight, sliding back the framework to its first position, and permitting the light to pass through the picture. These movements can be made instantaneously, and the picture changed during what appears to be a wink of

darkness, but it is quite as agreeable when done without special haste.

When American slides,  $4\frac{1}{2}$  inches long, are used, the outgoing slide is stopped by the catch *n*, Fig. 44, at the end

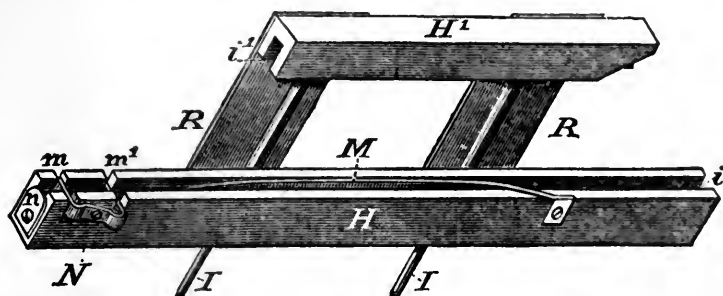

Fig. 44.

of the groove, just when the one driving it is exactly in the field of the lenses. It is then lifted out to make room for the next move. French slides, 4 inches long, are stopped by the end *m* of the turn-buckle pivoted at *N*, which is turned up above the bottom of the groove for that purpose. For English, or square slides, 3 inches long, the end *m*<sup>1</sup> is raised. If the slides are irregular or mixed, the turn-buckle may be kept level, out of the way, gauging the slides by the finger at the condenser. By these appliances the apparatus can be worked with ease and precision in the dark.

The automatic cut-off is not suited to wooden-mounted slides; they can rest on two screws projecting from the front side of the slide-frame by starting the draw-front just a little forward. If the assortment consists mostly of wooden-mounted slides, however, it is better to remove the latch-frame (starting at the spring *e*), and insert the ordinary Sciopticon stage. The front opaque curtain may be used as a cut-off, as shown page 35, or the slides may follow one another in panorama style, smooth and steady, as usual.

The portion of the Lime-light Sciopticon Fig. 45, including the triple jet, is all that is necessary for one having the Oil-light Sciopticon complete, to have the Lime-light Sciopticon also complete, for the condenser, objective, and draw front are perfectly suited to either.

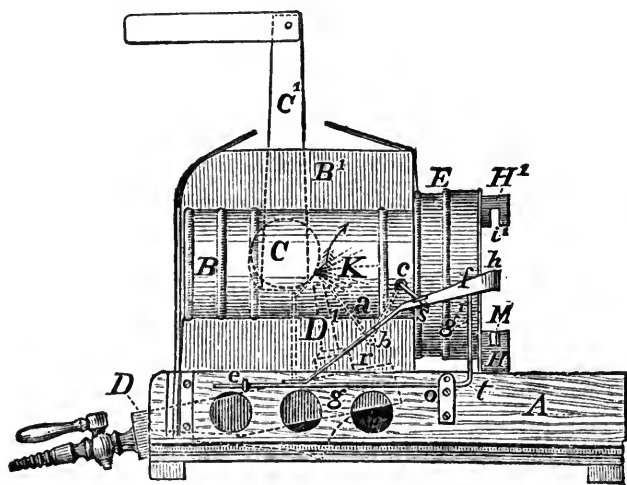

Fig. 45.

The following suggestions in relation to the automatic cut off may here be added in connection with the above cut.

The flap *a* is held in place by tightly biting about the wire *b*, upon which, however, if wrong at any time, it can be forced to turn so as to completely hide the moving slides, but not to shade in the least the one in view. The tension at the thumb-screw, now placed at the lower bearing, *t*, should just allow the flap to fall without jar. There is now a roller attached to the latch at *h*, bearing against the condenser ring, to lessen the friction when the slides enter, and to moderate its fall when let go. The forefinger should follow in the groove in which the slide runs, and it is well to let the outgoing slide strike the thumb of the left hand placed at the stop, then to lift it up level, and so out, without joggling the one on the screen, and then to place the next view to the latch, in readiness for another change at the right moment.

An exhibition of a mixed lot of slides may be made continuous and uniform by holding the wood-mounted slides upon the ledge in front of *H*, by pressing the draw-front back against them, which does not interfere with alternating them with glass slides in the grooves *ii*.

#### THE DISSOLVING COCK.

The oil lamps in a pair of dissolving lanterns are kept steadily burning, while the light of each is cut off from the screen alternately by the crescent-shaped dissolver, as shown Fig. 16, p. 40.

With the blow-pipe the lights themselves are made bright alternately. The expense of keeping two under full head when only one shines upon the screen at a time, becomes worth considering; besides the external cut-off does not produce so soft and pleasing an effect with a concentrated light.

With alcohol burners the oxygen is switched off, so to speak, from one to the other alternately; the deserted lime becoming dim at the same rate its alternate becomes incandescent. The dissolving cock, held to the stand by screw-heads, has a nipple to connect with the oxygen reservoir, and one for each blow-pipe.

With the mixed jet, the flame, when deserted by oxygen, spurts far out, making it necessary to cut off a portion of the hydrogen also.

The mixed jet stop-cock, therefore, has three additional nipples (the three next to the lever) with the stopper so filed out as to only partially cut off the hydrogen by the same turn of the lever which completely cuts off the oxygen.

The play of the lever in the Marcy dissolver is lessened by side screws when the concentric jet (No. 2) is used, or when the gas cylinders are used, because a fuller flow of hydrogen is less liable to be extinguished by an overbalancing and sudden admission of oxygen. There is considerable difficulty, at best, in dissolving with the cylinders.

**PREPARATION OF OXYGEN GAS.**

**MATERIALS.**—Theoretically, one pound of chlorate of potash should yield 37 gallons, or 5 cubic feet of oxygen gas; or enough to fill the ordinary 30 by 40 inch rubber bag. In common practice, however, it takes 20 ounces to get 5 feet, or a quarter of a pound to a cubic foot.

To facilitate the decomposition at a lower temperature, and to moderate the flow of gas, we mix with the 20 ounces of chlorate of potash about 5 ounces of black oxide of manganese.

To be assured that this black powder is no part charcoal, black lead, sulphide of antimony, or any thing else that will make with the chlorate of potash an explosive mixture, we may mix and heat a sample of a new supply on a scrap of sheet-iron, or in an iron spoon, over a lamp. If it simply melts and dries away, leaving a dark gray residuum it is safe; if it flashes up, leaving a whitish residuum it is unsafe.

For habitual use, it is convenient to keep this oxygen mixture in stock. Put into a box, say 20 pounds of pure chlorate of potash, broken, so as to pass readily into the retort. Add to these white, broken crystals, 5 pounds of black oxide of manganese, and stir the two well together into a dark gray mass. A pint cup is convenient as the measure of a "charge," as it holds besides the manganese about a pound of the chlorate.

**THE APPARATUS.**—A gas stove, *a* (Fig. 46), where we may have it, is, perhaps, the most convenient heating apparatus. An alcohol lamp, as commonly recommended, is too slow, or else with larger wicks it is in danger of explosion. A kitchen stove is better, either in the kettle's place with a brisk fire, or else upon the live coals.

A conical sheet-iron retort, *b*, about a foot high, with joints "up set" and hammered close, is cheaper than the copper retort in common use; is handier, stands firmer, lasts longer, and can be new-bottomed by any tin-smith when burnt out. When new, the seams should be luted with moistened clay or plaster of Paris, and whenever used the cap *c* must be luted on.

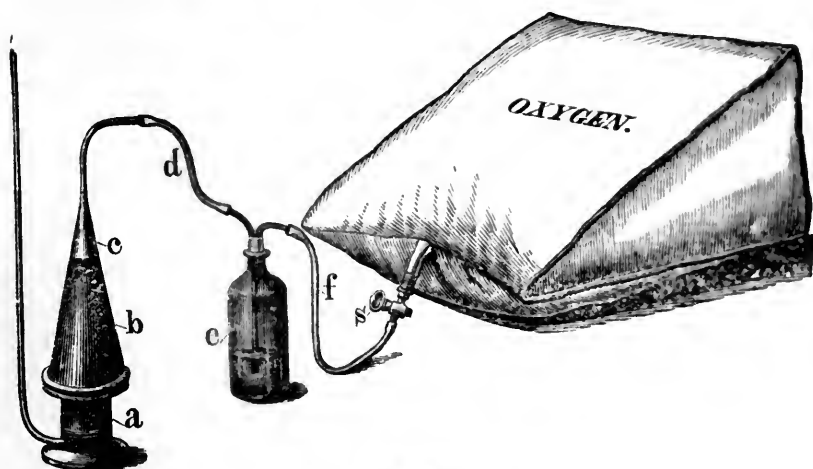

*Fig. 46.*

The cap has the same bevel as the retort, tapering into a bent tube, the end of which is covered by the flexible tubing *d*. The gas when liberated by heat passes through this tubing, first down the long pipe into the water, near the bottom of the wash bottle *e*, then bubbling up, washed and cooled, it passes over and into the gas bag *O*. It will be noticed that connections are made in all our apparatus, by slipping the flexible tubing over the ends of the brass pipes, which either have tapering nipples, or are cut with a slant on the under side.

**THE OPERATION OF COLLECTING OXYGEN GAS.**—Pour the charge into the retort, seeing that no chips or other materials enter with it. Let the wash bottle be less

than half full of water. Lute on the cap with moistened plaster of Paris, and make the connections as shown in the diagram, except that the outlet pipe, *f*, of the wash-bottle may be left open for a moment or so, until the flow of gas expels the air; see that the stop-cock is open and that the tubing is unobstructed.

Apply sufficient heat to almost immediately melt that portion of the charge in contact with the bottom of the retort, then as the rest melts in turn the operation will be gradual. A slow fire is to be avoided; for it, after a tedious waiting, raises the whole charge to about the melting point, when the decomposition suddenly proceeds with frightful rapidity, perhaps choking the passages and parting the connections. The connections, however, are so easily parted that there will be at the worst only annoyance and loss of gas, but no danger. It is a common recommendation to abate the heat if the flow is too rapid, but with a good heat from the start, the operation is expeditious and safe.

When the bubbling ceases and we conclude from the quantity of gas that the charge is spent, we disconnect the retort and remove it from the fire, and close the stop-cock at the bag.

It rusts the retort less to break up the residuum with a rod, getting it out dry; but it is easier and perhaps better to pour in water and rinse it out, drying the retort directly afterwards.

#### **PREPARATION OF HYDROGEN GAS.**

Hydrogen, one of the constituents of water, is produced by decomposing that fluid with zinc and sulphuric acid. A few hours before generating the gas, a mixture of, say four pounds of strong sulphuric acid (oil of vitrol) and four quarts of water is made. Consider-



able heat is produced in making the mixture, and for this reason it should be made beforehand in an earthenware, not a glass vessel, so as to allow sufficient time for it to become cool before being added to the granulated zinc contained in the generator *a* (Fig. 47).

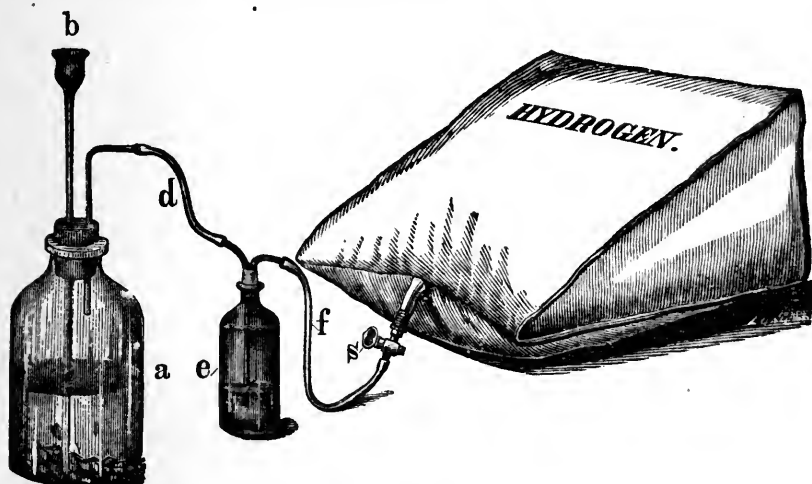

*Fig. 47.*

About two pounds of zinc is introduced into the generator (a glass bottle to hold five gallons or more, or a vessel made of lead), the top of which, bearing the tube funnel and bent exit tube, is then replaced, and the joint being made airtight (in the case of a leaden generator by means of a screw, and in the case of a glass bottle, by a metallic stopper coated with rubber), the diluted acid is poured down the long tube funnel *b*, the end of which descends far enough into the liquid to prevent the return of gas in that direction. A brisk action ensues, the gas effervescing like so much soda-water. The first portions should, however, be allowed to escape for some minutes at the outlet of the wash bottle *c*, to expel the air. To ascertain when hydrogen begins to flow, we might apply a light to soap-bubbles

blown from it into a saucer, or to the aperture itself if protected by a fine wire gauze thimble; but such troublesome precautions rather tend to incur a risk, where there would be none without them. We can judge near enough from appearances when to complete the connection.

Where the precaution of diluting the sulphuric acid and allowing the mixture to cool has been neglected, and sufficient time cannot be allowed for the purpose, the zinc and water may be placed in the generator, and the concentrated acid slowly poured down the tube funnel as it is required.

It is equally important that, before collecting the gas, the bag in which it is to be received should be pressed quite flat, or rolled with the stop-cock open, so as to exclude all trace of atmospheric air. The time when pure hydrogen is coming off may be known by the rapid rise of the bubbles to the top of the water, and by the accompanying sound, which the ear will recognize, after a little practice, as being unlike that of other gases. The purifier *e* should be about half filled with water; and connection being made between the exit tube *f* and the gas bag by means of india-rubber tubing, as shown in the cut, be careful to turn on the stop-cock *s*, in order that the gas may have free entrance into the bag.

The process here given is the simplest of the several in common use, and the best for collecting hydrogen gas in a not very large quantity. The self-condensing gas cylinder, to be next described, promises to supersede the more complicated methods, so that their insertion here would be useless.

It may be proper here to suggest, that after an exhibition the bags, particularly the one marked "H," if not to be soon used again, should be completely emptied, not only to preserve them, but to insure having fresh gas next time.

**PRESSURE BOARDS.**

Instead of the ordinary iron hinges, which only allow the pressure boards to open from the line of contact, two long leather straps, pierced with holes, may be permanently attached to the lower board and hitched to screw-heads on the upper board, allowing it to be in a plane nearly parallel with the lower board, while the bag of gas is between them and the weight bears on the side opposite. These straps may be hitched up, from time to time, as the gas is expended. By giving sufficient length to these strap-hinges, the two bags for the mixed jet may be placed one upon the other and subjected to the same pressure.

The three boards hinged together in the shape of the letter **Z**, to receive a bag in each angle, as commonly recommended, are not only heavy and expensive, but a measure could hardly be devised more likely to give unequal pressure. A long board extending from one bag to the other, with the weight upon the middle, would be better.

The necessity of exactly equal pressure to be given to the two gases used with the mixed jet, is not so absolute as might be inferred from the way it is usually spoken of. It is surely well to see that the bags are about equally weighted. When two gas cylinders are used, one nearly spent need not be mated with one fully charged. If, however, the pressure in each is in excess of what is needed, the stop-cocks are made to regulate the flow.

As it is inconvenient to transport heavy weights from place to place, traveling exhibitors may fill a box or bag with brick or stone at each place of exhibition. This expedient affords a steadier weight than to seat boys upon the pressure-boards, and more continuous than can be effected by clamping screws.

**EDGERTON'S SELF-CONDENSING GAS CYLINDERS.**

“Special attention is asked to these cylinders, affording as they do a more easy and safe means of producing and condensing the gases for stereopticon purposes and general illumination. To the traveling exhibitor they fur-



*Fig. 48.*

nish a compact means of transporting his gases, and save the labor and vexation of carrying weights, pressure-boards, etc.; while to the teacher they are invaluable, placing at his command, at all times, a powerful light as readily started and as easily managed as that of a coal-oil lamp.

“They are made of wrought iron, with a cast-iron cap, and are capable of sustaining a pressure twenty times as great as the strain they are subject to. Referring

to the cut, *A* is the wrought-iron cylinder, *B* the cast-iron cap, *C* the valve, *D* the nipple for hose, and *E* the pressure-gauge. The hydrogen cylinder is coated with vulcanized rubber and is proof against the action of the sulphuric acid. It is usually a size larger than the oxygen cylinder.

*“To operate the cylinder for oxygen, unscrew and remove the cap; then set the cylinder over the fire (a range or stove preferred) until quite warm and entirely dry; then pour in the chlorate of potash (one pound) and the black oxide of manganese (four ounces). See that none of the mixture falls upon the cylinder head, so as to prevent the cap fitting closely down. Now rub a little tallow on the cap to make a smooth joint, replace it so that the marks on the cylinder and on the cap will coincide, and screw the nuts down tight; then screw on the gauge and open the valve. Allow the cylinder to remain on the fire until the gas has come off, which will be indicated by the rise of the colored fluid in the gauge. The gas from one pound of chlorate of potash will raise the fluid to within three-fourths of an inch to an inch of the top of the tube. The cylinder ought not to be made red hot in any part. When the gas has come off, set the cylinder away to cool; and after it has become cold, shut the valve, remove the gauge, and screw on the nipple. It is now ready for use at any time, but can remain in the cylinder for months, if not required sooner.*

*“When the gas is all used up, shut the valve, and let it stay closed until you wish to make a new lot. This will keep the cylinder dry and obviate the necessity of drying over the fire before recharging. Then, when you wish to make fresh gas, unscrew and remove the cap, tapping the end of the wrench with a hammer if the*

nuts are hard to start; take a piece of wood, sharpened at one end, insert it in the cylinder, and break up the residuum by a few vigorous blows; pour it out and recharge without either washing or drying.

*“To operate the cylinder for hydrogen, unscrew the cap as before, put in two pounds of scrap zinc, and add a mixture of sulphuric acid and water (four pounds of acid and four quarts of water). This mixture should be cold when poured into the cylinder. As soon as the liquid is poured in, screw down the cap as before, slip a gum tube on the nipple, and begin to use as soon as there is sufficient pressure, if it is desirable. There is no practical use for the meter in this case; if used, the red liquid will stand within about a quarter of an inch of the top of the tube when the operation is completed.*

*“As there is an excess of zinc introduced all the acid will be neutralized. There will be no deterioration of the gas or injury to the cylinder from long standing. When the hydrogen is burned up, pour in water to dissolve the sulphate of zinc. This is easily done, and the cylinder is then rinsed out, and is ready for another charge.”*

We believe with the inventor, as above expressed, that the self-condensing gas cylinders will prove a very great convenience in the production of the lime light.

It is obvious that the directions as to fitting the cap upon the cylinder-head must be strictly observed. Any particles between the meeting surfaces prevents perfect contact and so will allow the gas to escape.

The oxygen cylinder, owing to its thickness, requires a longer heating to disengage the gas than the retort before described. There is, in this case, no outward current of gas, dust, or foam, to make former directions applicable only so far as repeated above.

# MULTUM IN PARVO.

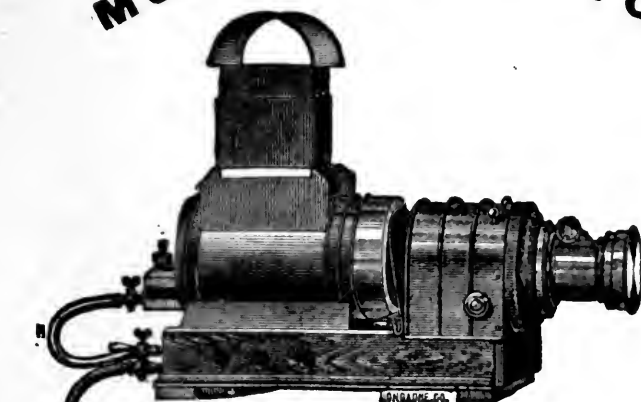

## MARCY'S SCIOPTICON AND TRIPLE JET.



Fig. 49.

The condensing gas cylinder occupies but a small portion of the space required by a gas bag with its pressure boards and weights. Considering, moreover, that the apparatus here illustrated gives the best results with comparatively little trouble, the significant heading of "Much in Little," is well-deserved.

With oxygen in the cylinder, or in a bag, we may have the lime light either with alcohol or with gas from house gas fixtures. For the mixed jet, the hydrogen must be forced from a second cylinder or bag.

## AN ECONOMICAL FORM OF GAS HOLDER FOR THE LIME LIGHT.

BY J. B. KNIGHT, SECRETARY FRANKLIN INSTITUTE.

“In the summer of 1875 the Franklin Institute determined to put in a pair of holders of considerable capacity, for oxygen and hydrogen, so as to avoid the necessity of preparing the gases on each occasion that they were to be used, and other inconveniences in the use of bags and press-boards in connection with the lime-light. As it was desirable to use as great economy as was consistent with effectiveness and durability, the design shown in the accompanying illustration was adopted, as covering these points.

“Fig. 50 is a sectional and Fig. 51 a perspective view. *a* represents a wooden tank or tub,  $4\frac{1}{2}$  feet in diameter, and 5 feet high, made of cedar wood, and hooped with iron in the usual manner; *b* represents the holder, made of No. 10 galvanized iron, and is 4 feet diameter by 5 feet high. The roof or top, *c*, is conical in shape, rising on each side at an angle of about  $30^\circ$ , and is attached to the sides of the holder 18 inches below the top edge, thus forming a receptacle for water, to act as a weight to produce the required pressure when the gas is being used.

“In the centre of the holder, and extending its extreme height, is placed the tube *d*, passing through and fastened by a water- and gas-tight joint to the roof *c*, and being held firmly in the centre, at its lower end, by the four braces *n*. The holder is given additional stiffness by the diagonal braces *m*, which, however, may be dispensed with in holders of this size or smaller. From the centre of the bottom of the wooden tank rises a bar or post of 1-inch round iron, passing through the tube *d*, and reaching to the ceiling of the room, thus forming a simple and almost frictionless guide for the holder in its vertical movements.



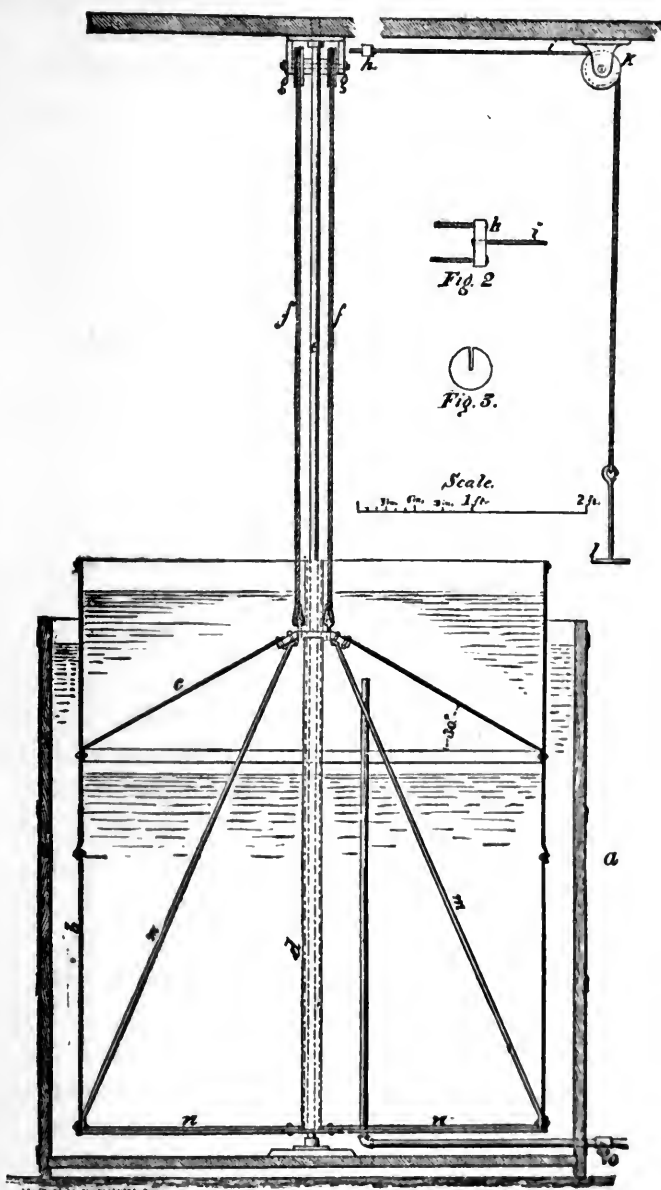
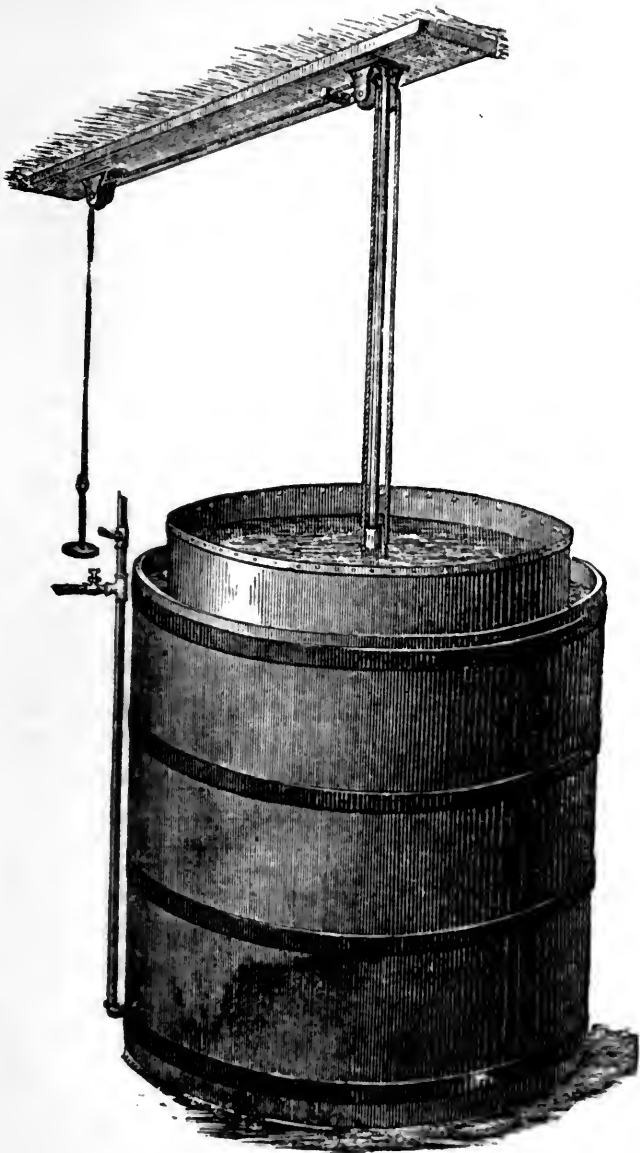

Fig. 50.

“On either side of the tube *d*, and as near as convenient, are placed two eye-bolts, from which are carried wire cords *ff*, up to and over the pulleys *gg*. After passing these pulleys or shrives a few inches (the holder being at its lowest point), the ends of the cords are inserted and fastened in holes in the crossbar *h*, as shown in Fig. 2, p. 183. Midway between these cords is inserted, from the opposite side of the crossbar, a single cord, as is also shown in Fig. 2, p. 183, as well as in Fig. 51, which represents this portion broken off and swinging around at a right angle to its proper position. This cord *i* passes over the shrive *k*, and extends down to within a convenient distance of the floor, and has attached to its extremity the pan *l*, for holding the weight shown in Fig. 3, p. 183. Care must be taken that the distance of the shrive *k* from the crossbar *h*, and also from the bottom of the scale pan to the floor, is as great as the proposed rise and fall of the holder. The arrangement of cords, shrives, etc., will be readily seen in the perspective view, Fig. 51.

“The pipe for the admission and exit of the gas is shown as passing through the side of the wooden tank, and rising near the centre, to within a few inches of the top of the holder.

“The manner of using is as follows: The cock *o*, in the inlet pipe, being open to the atmosphere, water is admitted to the tank until it rises a little above the lower edge of the top of the holder, when the cock should be closed. Weights (Fig. 3, p. 183) are placed on scale pan *l*, in sufficient amount to overbalance the weight of the holder, and to overcome the friction of the cords and pulleys. Communication being opened between the inlet pipe and the source of gas supply, the gas enters, and the holder rises until filled. The supply of gas should then be cut off, the weights removed from the pan *l*, the space at the top of the holder filled with water, and the gas is ready for use, under the necessary pressure. When the holder is exhausted, the



*Fig. 51.*

water on top is run off by means of an india-rubber tube, acting as a siphon, the weights replaced on the pan, and the holder is ready for refilling.

“Where the oxy-hydrogen light is much used, holders are almost indispensable, and in all cases effect a large saving of time and material in the preparation and use of the gases.”

The above illustrated article has been prepared for the purpose of affording a practical guide in constructing similar gas-holders, wherever the plan is approved. If the tubs are made at any distance away, they can be brought in parts to the place they are to occupy and there set up. The joints of the galvanized iron holders are made gas-tight with solder.

Wherever illuminating gas is in use, the hydrogen gas holder can be filled with it, as is done at the Franklin Institute. If either the alcohol burner, or the concentric jet with house gas direct from the main is used, only an oxygen gas holder is required.

So far as we now know, it seems best to generate the gases by repeated use of the apparatus described on pages 165 and 167. With two retorts, one accustomed to the operation can roast a double oxygen charge in each alternately till eight pounds are used, which about fills a gas holder of the dimensions described.

The use of gas holders renders projecting apparatus much more available in educational institutions, because the gases can be made in large quantities at once, stored for an indefinite time without deterioration, and used whenever occasion requires, without delay, with only such darkening as can be readily effected, either at evening or in the daytime.

#### **OTHER GAS CONTRIVANCES.**

A desire to render the lime-light apparatus more convenient, inexpensive, safe and portable, gives rise to various

contrivances to lessen its drawbacks. Gas holders, as described in the last article, cannot, of course, be carried from place to place. In bags, there is considerable bulk, and a necessity for weights and pressure boards. Cylinders are heavy, and the pressure which has a thousand times the force needed has to be risked, retained and regulated. These disadvantages might be obviated, it is thought by some, by the simultaneous production and consumption of the gases.

A copper hydrogen generator, about thirty inches high, similar in shape to Fig. 51, but with the zinc suspended so as to sink into the acidulated water, to keep up the supply of the disengaged hydrogen as it becomes expended, has been in market for many years; but its being abandoned by those who have used it is not very assuring.

A good light is produced by vapor from heated gasoline, or other hydrocarbons, pressing into the mixed blowpipe, but it can hardly be as safe as a jet of oxygen through an ordinary alcohol flame.

At this very time there is much said in favor of generating oxygen at just the rate required by the jet, by gradually feeding the oxygen material to the melting apparatus. We are now waiting to see this process develop into complete success, but the question arises as to whether the additional care of generating the gases while running the light will not prove too much for ordinary faculties, and result in the proverbial experience occasioned by having too many irons in the fire at once.

The gases, with the use of cylinders, into which they are compressed by pumping, are furnished by dealers at about 20 cents a foot for oxygen, and 3 cents a foot for city gas. Many exhibitors in the vicinity of large towns are thus supplied.

**ATTACHMENTS FOR USE WITH THE LIME LIGHT.**

**THE LANTERN MICROSCOPE.**—This instrument is intended to show natural objects, suitably prepared and mounted with Canada balsam, between two discs of glass. They consist of details in the anatomy of a bee, wasp, flea, spider, larvæ of insects found in stagnant water, as

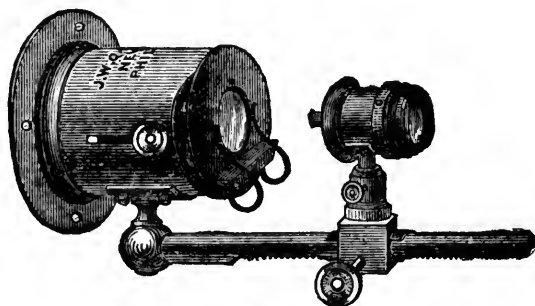
*Fig. 52.*

gnats, dragon-flies, parasitic and other insects; parts of insects, sections of woods, teeth, bones, fossil bones, shells, lace, silk, muslin, etc.; and as such objects are smaller than paintings for the lantern, and contain more delicate details, a proportionately higher magnifying power is required, which may be adapted to the front of the Sciopticon.

The ordinary lantern microscope objective, sold at about \$10.00, has a high and low-power combination. There is, however, all the need of achromatic objectives for projections that there is for the common microscope; in which case the cost cannot be less. The apparatus shown at Fig. 52, with an inch objective, costs about \$60.00. The objectives of a table microscope might doubtless be adapted to lantern use. Of course there can be no satisfactory results without proper adaptations, and perfect alignment and adjustment of distances.

**EXPERIMENTS WITH THE LANTERN MICROSCOPE.**—By filling a glass trough with diluted sulphuric acid, and dropping into it a few pieces of granulated zinc, the decomposition of water may be shown to an entire audience. Aided by a six-cell Smee's, or Grove's, battery, and a small thin tank, the power which palladium possesses of absorbing nine hundred times its volume of hydrogen may also be shown; the snake-like contortions of the strip of metal, and the bubbles of gas escaping on the reversing of the current, proving very interesting.

The crystallization of salts may also be shown by placing a drop of a strong solution of Epsom salts, or sulphate of copper (blue vitriol), on a piece of glass of suitable size.

Another effective result is obtained by placing in the glass tank a small horse-shoe magnet, and dropping around it some iron filings, which will be found to arrange themselves, or rather be attracted by the magnet, in a most extraordinary manner.

Exhibitions of microscopic objects by the aid of the magic lantern in the drawing-room sometimes fail to give that complete satisfaction which is desirable, owing to attempts being made to show them on too large a scale in proportion to the light employed. We have given very satisfactory exhibitions on a sheet of Imperial (22 x 30) white card-board, fastened by drawing-pins to a board, and fixed against some books or on a chair. In this way the proboscis of a blow-fly may be enlarged to two feet in length, and this is found to be quite large enough for most private assemblies.

It is desirable to have two or three sets of lenses, of different powers, with the microscope, which are varied to suit the object to be exhibited; and it is important to observe that when minute objects are being exhibited,

and a high power consequently in use, the source of light should be drawn farther from the condensing lenses. A very interesting addition to the microscope consists of a diagonal mirror, whereby the image of the objects, instead of being projected directly on an opaque screen, may be thrown down at right angles on a sheet of paper placed on a table, and a drawing very conveniently made.

HOLMAN'S SIPHON SLIDE (Fig. 53) allows the passage of a continuous current of water for the purpose of keeping it cool in the focus of light. It is designed

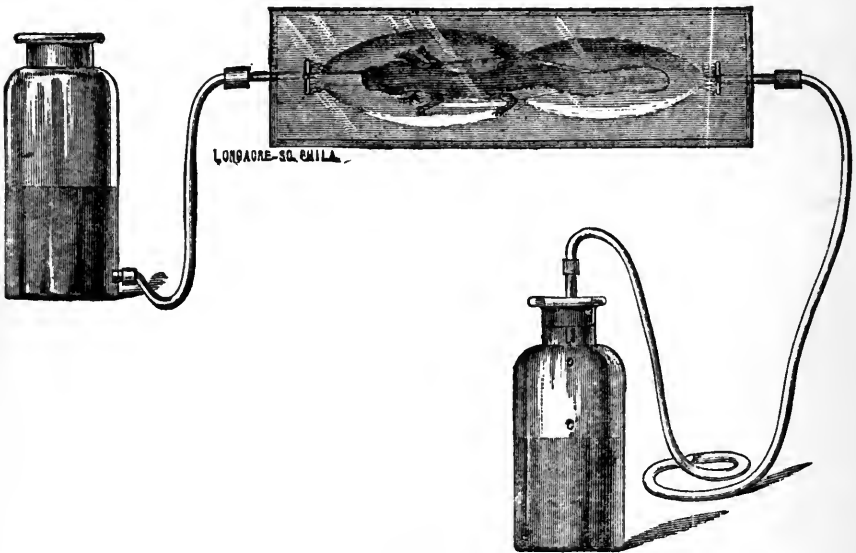

*Fig. 53.*

for showing the circulation of the blood in a tadpole's tail, of the sap in plants, &c. Its price, without the bottles, is \$5.00.

A tank filled with a solution of alum is sometimes used to absorb much of the heat of a beam of light before it falls upon a delicate microscopic object.



**THE GAS MICROSCOPE.**

BY HENRY MORTON, PH. D.

The projection of images from microscopic objects directly upon the screen, with the gas microscope, has always been a thing much desired by all those who have made use of the magic lantern as a means of demonstration, but the difficulties attending this experiment have been found much more serious than was anticipated beforehand.

This is especially the case to one who has been accustomed to use the solar microscope, in which the advantage offered by the parallelism of the solar rays is of so great value.

On account of the smallness of the object illuminated, as compared with errors of focalizing or concentration in the cone of rays coming from the condenser, all the advantages in the use of a lens in a magic lantern, as compared with its use in a camera, or the like, disappear, and the lens of the microscopic attachment is left to its own resources (on the subject here referred to, see *Journal of Franklin Institute*, vol. 62, page 208; *Scientific American*, 1863, vol. 29, page 163), without any of that aid from the condensers which they afford so effectively to the objective of the magic lantern in its best form of construction.

Among the errors which thus become conspicuous, the most manifest and vitally important is the want of "flatness of field."

By reason of this, while the centre of the image is well-defined, the edges are indistinct and unsatisfactory. To obtain lenses free from this defect has been the continuous effort of some of our ablest opticians for the last ten years, but the success so far has been very limited, and, indeed, it would seem as if the problem was one for whose solution we could hardly hope, for it must be remembered that lenses

whose flatness of field in the table microscope leaves nothing to be desired in that direction, are entirely unsatisfactory when used in the gas microscope.

One of the most influential causes of this we shall notice presently, but we will here only remark that, as the result of a large experience, we have become convinced that one must be contented with a moderate amount of success in this direction, and not expect what is, at present, at all events, impossible.

The second great defect that we encounter in the use of the microscopic lens for projection, is the irregularity of distribution of light upon the screen.

By reason of this we may have a field of light with a small bright area at the centre, rapidly fading off into darkness, with no well-defined margin.

The causes of this are, among others, the confusion or want of accurate concentration of the cone of rays from the condensers, and the smallness of the objective, causing it to cut off oblique or marginal rays more or less, according to their obliquity. To remedy this difficulty we can work in two directions.

In the first place, we may improve the spherical correction of the condensers, or the concentrated character of the source of light. The first of these improvements has already been carried to its practical limit in the best sort of condensers, and the second involves the use of the electric light or of sunlight.

In the second place, any increase in the diameter of the microscopic lenses, without a corresponding increase in their actual length, insures a great gain as regards the equal illumination of the field.

With this view alone, therefore, a simple uncorrected or single corrected microscopic lens, such as accompanies the regular gas or solar microscopic attachment made for the

last fifty years, and still made by Duboscq, and other French manufacturers, would be the best form; and, as regards the equal distribution of light on the screen this is true, but when such lenses are thus used and of sufficient size to secure this result, their errors of spherical aberration and want of flatness become unendurable.

We are then fenced in on either side by the necessity of a large and short lens to secure an equal illumination, and the difficulty in securing flatness or correction under these conditions.

The most successful compromise which we have yet found in this connection is the gas microscope objective, of 1½-inch focus, made by Mr. J. Zentmayer, the well known manufacturer of microscopic stands and lenses.

With one of these, a well defined object, such as a lady-bug, mosquito, or the like, may be thrown on the screen with a clear image, pretty well defined up to the margin, and a field of light so brilliant and regular that it is hardly distinguishable from that of an ordinary magic lantern projecting a colored glass slide of the same object. Of course, with such a power, very minute objects must be rejected, but by a judicious selection a large series of interesting ones can be secured, such as the lady bug or mosquito already mentioned, the ant lion, field spider, and various water insects or larvæ of mosquitoes, and the different sorts of flies; also wood sections, and even objects so small as the eye of a dragon fly, but, above all, with this power may be most successfully shown what are by far the most popular illustrations with the gas microscope, such living specimens as the various larvæ above mentioned, and such other things as are to be found in stagnant water. For these the very simple and effective form of life slide, devised by Mr. S. Holman, Actuary of the Franklin Institute, Philadelphia, is invaluable.

It consists of an ordinary microscopic glass slip, of greater thickness and size than usual, with a spherical cavity about three quarters of an inch across, and one-sixteenth of an inch deep, ground and polished in the middle of one face. This, when in use, is closed by a thin glass cover, which is kept in place by adhesion and atmospheric pressure, the cavity beneath it being filled with water containing the insect or other object.

If it is desired to use high powers, we must be contented with a limited selection of objects, choosing such as are strongly defined and well colored. Diatoms, blood-disks, or other objects which are delicately tinted or colorless are quite unfit for such use. A strongly colored eye of a fly, sting of a wasp, or other part of an insect, such as a claw of a spider, answer well.

In this case I have obtained the best results with Zentmayer's  $\frac{1}{10}$  objective, using an extra condenser, consisting of a plano-convex lens of about three inches focus, and an inch and a half in diameter, placed about an inch back of the object.

This greatly increases the illumination of the field.

In using the gas microscope, much depends upon the efficiency and convenience of the support for lenses and the stage, or what is known commonly as the "gas microscope attachment."

The microscope attachment for the Sciopticon is represented by the following wood cut.

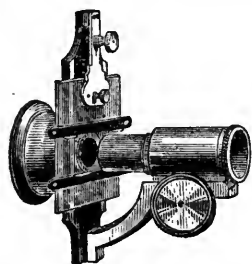

Fig. 54.

The microscope body, to which the objective is attached by a sliding tube, is fitted to the grooved arm, and moved by rack and pinion for accurate focusing, similar to our best table microscopes. This curved arm is fastened to the stage plate, which is attached to

the Sciopticon by a tube and flange, so that it can readily be removed.

The object carrier is made of strong plate glass, pressed down by an adjustable spring, admitting of a delicate movement of over one inch perpendicular and two inches lateral. Two sliding bars, fitted to the edges of the glass plate, hold the objects, which may be of different sizes, to the stage. In principle it is what is known by microscopists as Zentmayer's glass stage. If a secondary condenser is required, it is fitted to the attaching tube back of the stage.

#### THE MEGASCOPE.

Although the light reflected from the illuminated opaque object in the opaque lantern is dim, as compared with the direct rays through a magic lantern slide, and, notwithstanding the dispersion of a large portion of even this reflected light from the line of the Megascope objective, yet the image of small objects may be thrown upon the screen on a large scale with sufficient distinctness, not only to be interesting, but to be practically useful for purposes of illustration.

Bright objects presented at the proper angle, such as a watch with its movements, flowers, minerals, beetles, butterflies, etc., show quite brilliantly, while the images of duller objects, or of plain pictures, are hardly suggestive of the title of Wonder Camera, commonly applied to this arrangement.

Only a portion of most objects can be in focus at once, for the lack of a flat surface. To bring out a distinct image of even a flat object or picture, requires, theoretically, a larger and better objective than ordinary lantern projections, as may be seen in Fig. 14, page 25, where each point in the transparent object transmits (on the supposition that the light proceeds from a point) a single ray in the

direction of the corresponding point in the image, while reflected light spreads from each point in all directions.

The Sciopticon, with its draw-front removed, happens to be well shaped for shutting over the front end of the lantern body holding the condensing lenses  $p$  and  $q$ , the open end of the Megascop, which is shown in horizontal section, as if looking down upon it. (Fig. 55.) The

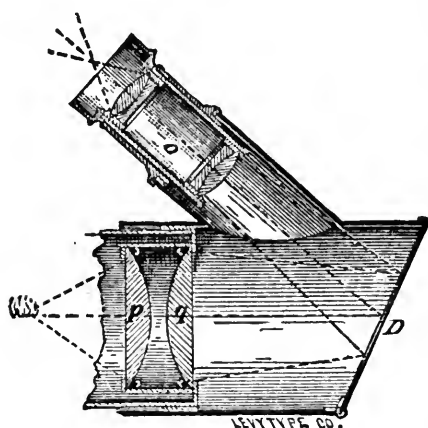

Fig. 55.

door  $D$ , hinged at the shorter side, closes at an angle to reflect the light in the direction of the focusing lens  $o$ , which in this case is the Sciopticon objective screwed into a duplicate flange. The aperture in the middle of this door, or Megascop stage, allows the object or *carte de visite* to be

attached to the outside by springs, and does not prevent the object or picture from being attached to the inner surface, which is also provided with springs.

Flame illumination has the peculiar advantage, in the Megascop, of covering some two and a half inches at this outer conjugate focus of the condenser, so that a portion of the margin lost in the lantern is here available. The lime-light makes at the focus a bright hot spot, sometimes necessitating the drawing the Megascop forward, which does not change the angles in relation to the lenses.

The Megascop has greater advantages as an attachment to the Sciopticon than as a separate apparatus, for the illumination is better; it telescopes over the lantern body, which is not in the way of the backward direction of its objective; it is simple and inexpensive, and what it can do for us we have with the least possible trouble, and at its best.

**THE MAGIC LANTERN KALEIDOSCOPE.**

THE KALEIDOSCOPE was invented by Sir David Brewster, in 1814, and all who have witnessed the beautiful effects produced by the instrument will welcome its adaptation to the magic lantern, which, notwithstanding the attendant optical difficulties, has at length been accomplished.

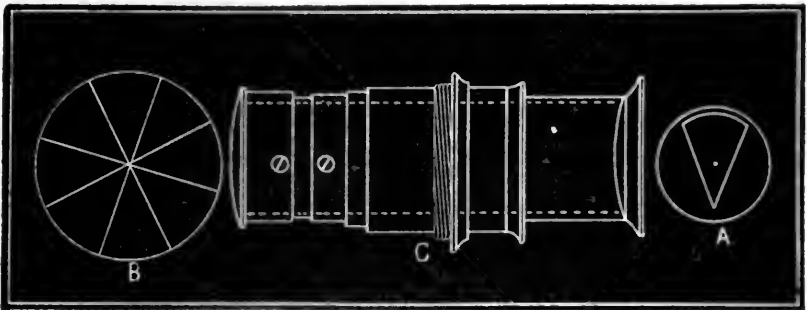
*Fig. 56.*

The instrument is shown in section at Fig. 56; *A* being a sectional view, showing the disposition of the mirrors; *B*, an outline of the eight-celled image; *C*, a side view of the brass mount, containing the reflectors and lenses, with sliding adjustment for focusing, and projecting the image upon the screen.

It is attached to the lantern by unscrewing the front and screwing the kaleidoscope into its place, turning it round in its sliding tube until the reflectors are upright, like the letter *V*. A rack slide, containing some fragments of colored glass, bugles, beads, and other transparent objects, is also shown; this is introduced into the usual slide-holder of the lantern, and the focus adjusted by sliding the kaleidoscope in or out until its back lens is at a proper distance from the slide.

In a former paragraph, the great importance of having

the various parts of the lantern and the objects to be shown *properly centred* has been dwelt upon at some length. Now, however, the direction is to raise the light about an inch above the centre of the condenser, which can best be done by sliding a narrow board under the blow-pipe. The maximum of illuminating power is obtained in the usual way, by pushing the light backwards and forwards, and the correct focus is obtained by means of the *front* sliding tube. Any dark portions of the image may be removed by turning the kaleidoscope round a very little to the right or left.

The instrument, before using, should be warmed, to prevent what is popularly known as the "steaming of the glass."

Rackwork frames, containing pieces of colored glass, are supplied by the opticians; but exceedingly beautiful effects are obtainable with the chromatrope, a piece of perforated zinc, the bow and the wards of a key, grasses, feathers, a bunch of oats, etc., etc.

#### THE OXYHYDROGEN POLARISCOPE.

Fig. 57 shows the Oxyhydrogen Polariscopes, which consists of two tubes inclined to each other at an angle of  $56^{\circ} 45'$ , and truncated at their points of junction; the oval space thus formed being closed by some ten or twelve pieces of thin crown glass, the lowest of which is blackened to absorb the polarized ray. This apparatus replaces the object-glass of the lantern, which should have condensers not less than  $3\frac{1}{2}$  inches diameter. When attached, it will be seen that the light emanating from the point *L*, after passing through the condensers *C'*, becomes incident on the crown glass *G*, inclined at the polarizing angle ( $56^{\circ} 45'$ ); the reflected, and in this case polarized, light then passes through the selenite,



or other object, in the aperture at *O*; after which it is brought to a focus by the object-glasses at *F*, and finally again polarized, or *analyzed*, by the Nicol's prism *P*, and thence thrown on the screen, the disc on which should not exceed three feet in diameter.

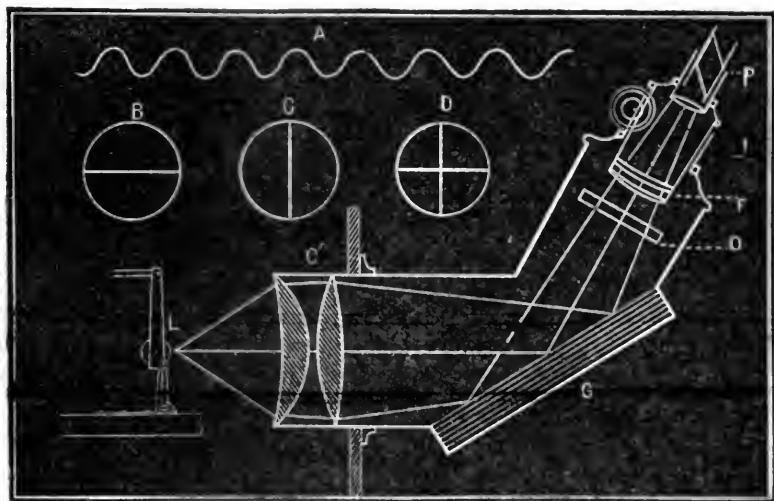

*Fig. 57.*

The phenomena connected with the polarization of light are attended by a most gorgeous display of colors, and are, in consequence, among the most attractive in the whole range of physical optics; an apparatus, therefore, which facilitates their exhibition to an audience becomes a most valuable adjunct to the magic lantern.

The subject itself is, however, of too recondite a nature to admit of adequate treatment in the present manual; the reader is therefore referred to Pereira's lectures on "Polarized Light," "Ganot's Physics," and other works on Physical Optics.

The objects best suited for the polariscope are designed with films of selenite of various thicknesses and forms;

sections of quartz, cut in different relation to the axis of the crystal, producing most splendid tints; unannealed glass, quill, Iceland spar, and, indeed, almost any matter the particles of which are in a state of tension. Specimens may be seen, and lists of the various designs are obtainable, from opticians supplying the apparatus.

In Fig. 57, the polarizer consists of a bundle of glass plates, *G*, with the Nicol's prism, *P*, to analyze the polarized, reflected rays.

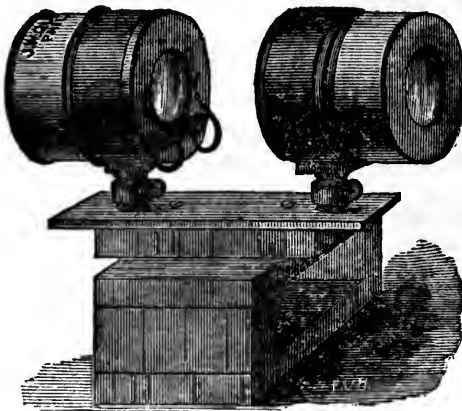

*Fig. 58.*

The polariscope here represented (Fig. 58) consists of a Foucault prism, of 36 millimetres in diameter, as polarizer, and a Nicol's prism, of 20 millimetres in diameter, as analyzer.

PRICED CATALOGUE  
OF  
SCIOPTICON APPARATUS  
AND  
MAGIC LANTERN SLIDES.



THE SLIDES ARE IMPROVED IN QUALITY, TO COMPARE  
IN EXCELLENCE WITH THE SCIOPTICON;

AND CHEAPENED IN PRICE,

TO ENCOURAGE MORE GENERAL INTRODUCTION.

---

L. J. MARCY,  
1340 CHESTNUT STREET,  
PHILADELPHIA.

## NOTICE—SIXTH EDITION.

---

Apparatus and slides may be ordered from this catalogue by simply giving the class and number, but what is taken from elsewhere should be written out in full, to avoid all chance of mistake.

The receipt of money will be acknowledged by return mail.

When goods are ordered by express, C. O. D., a remittance of ten dollars should accompany the order. The express charge for collection will be added to the amount of the bill.

It will save express charge for collection to send the amount of the bill at once, with the order.

Goods ordered to be sent as freight, or small articles ordered to be sent by mail, should be prepaid.

The best mode of remitting money is by a bank draft made payable to my order, or by a post-office money order, or by express.

The Sciopticon apparatus is our specialty, which we delight in making thoroughly satisfactory. We furnish slides, improved in quality and cheapened in price, not only because it is the right thing to do, but because it does credit to the Sciopticon and extends its usefulness.

All goods are packed with great care, and are warranted to be in good condition when they leave our premises.

We get no perquisites for boxing, packing, shipping, or other service. The common custom of adding extra charges subjects the buyer to unforeseen expense, which he cannot forecast when making prepayment.

Correspondents will oblige by giving, in a plain hand, their post-office address, and buyers should be particular in giving the express station to which the goods are to be forwarded.

Any further particulars that may be desired will be cheerfully given by letter.

L. J. MARCY,

1340 Chestnut Street, opposite the U. S. Mint,

PHILADELPHIA.

# INTRODUCTION

TO THE

## SCIOPTICON CATALOGUE.

---

### *Where to Look for Explanations.*

The Sciopticon Manual (price, in full binding, 75 cents) will be forwarded gratis to purchasers of such apparatus needing explanation as is described therein, to which, therefore, reference may here be made, as follows:—

For operating the Oil Sciopticon, see Manual, p. 33; or better, see inside the door of the Sciopticon case, which is usually purchased with the instrument, at the extra cost of three dollars.

For peculiar arrangements and advantages of the Oil Sciopticon, and of the Gas Sciopticon, and how to secure the fullest advantages of both, see Manual, p. 170, and this Introduction, following.

For Dissolving Views, see Manual, p. 39; Phantasmagoria, p. 45; Screen, p. 37; Producing Lantern Slides, pp. 61, 135; Chemical Experiments, etc., p. 83.

About Public Entertainments and Descriptive Lectures, see Manual, p. 94; and this Introduction, p. xxv.

For operating the Lime Light, each of the three, see Manual, pp. 152, 153, 155, 162, 163; Adjusting the Jet to the Oil Sciopticon, p. 160; Arrangement of Lenses and Distances, p. 164; Dissolving Cock, p. 170; Automatic Cut-off, p. 167; Preparation of Oxygen Gas, p. 172; Preparation of Hydrogen Gas, p. 174; Pressure Boards, p. 177; Gas Cylinders, p. 178; Multum in Parvo, p. 181; Gas Microscope, Zentmayer's Arrangement, p. 191; Sciopticon Kaleidoscope a Success, p. 197; Lime-light Polariscopes, p. 18; Sciopticon Megascope, p. 195.

For plans and directions for building Gasometers for Educational Institutions, say in the basement, that the Lime Light may be always available, at a moment's notice, in the lecture room, without its being in the way or tedious to prepare, see Manual, p. 182. As the apparatus described is believed to be the best for its purpose yet devised, and a style likely to be extensively introduced, the plans and specifications are made as distinct as possible, and easy for the builder to follow.

PECULIAR ADVANTAGES  
OF THE  
**OIL-LIGHT SCIOPTICON.**

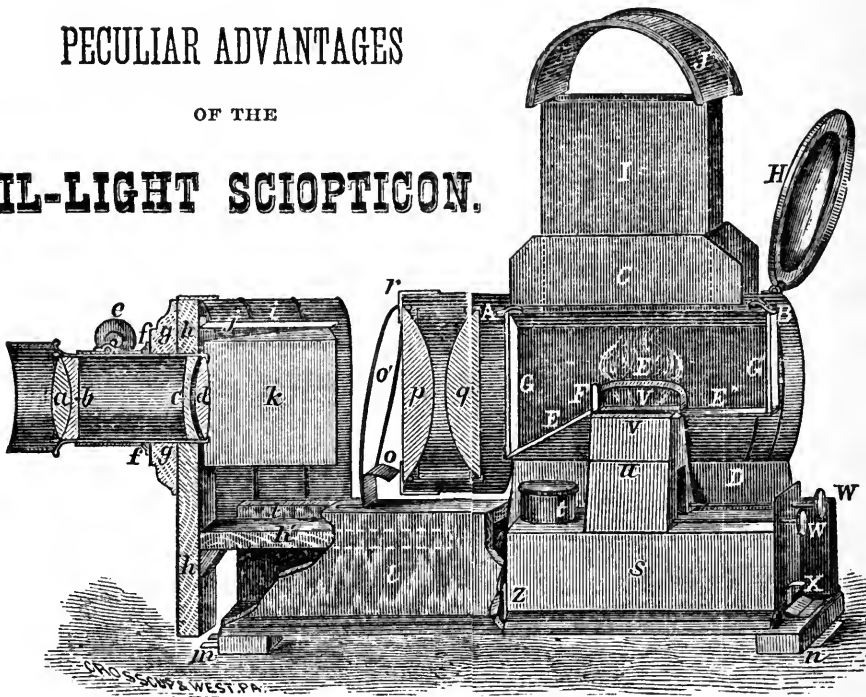

As the Sciopticon was originally known as an oil-light lantern, its peculiar advantages as such may be first enumerated.

**1. The Flame-chamber,** which is a distinctive characteristic of the Oil-light Sciopticon, is in itself a small

dark lantern with a front and a back glass *G G*, suspended by cross-strips within a well-ventilated protecting shell, where it can do most good with its light, and the least harm with its heat. Other parts of the apparatus are adjusted with ease and precision to this fixed centre of action, by means of the outer shell and wooden base, which are represented in the above illustration as mostly cut away to show these internal arrangements. Thus, by allowing unobstructed draft about the heated chamber, and by avoiding the conduction of heat by contact, the intense Sciopticon flames become available without inconvenience to the operator, or harm to adjacent parts.

2. *The Lamp (S)*, without deflecting cap or chimney, slides horizontally into place, so that the bottom of the flame chamber, with its peculiar-shaped aperture, becomes the deflecting cap, the flame chamber becomes the base of the chimney, and, with its continuation, is the chimney; which happily supersedes the troublesome and fragile small chimney, being much more than an equivalent. Besides being thus separate from the heated chamber, direct conduction of heat to the oil cup is further broken by breaking the connection on each side of each tube, as at *u*. The material is tin instead of brass, because it is not so free a conductor of heat.

3. *Two Flames*, starting wide apart at *v v*, are deflected toward each other over a rising current of air which thoroughly oxygenates the inner surfaces, their cumulative heat favoring perfect combustion, a free draft, and the rapid escape of the residual gases up the narrow space between.

Other dual burners (not infringements on this) either throw the two flames into one—and into only the efficiency of one, because only the outer surfaces are oxygenated—or

else deflecting them too far apart for both at once to be fully available in a magic lantern.

4. *The Two Parallel Sheets of Flame*, an inch and a half long, thrown as nearly together as possible without interfering with complete oxygenation, or the escape of the residual gases, are placed in the direction of the axis of the lenses, so as to fill all the space from which light can pass through both the condenser and the objective. Light from any added length would be mostly wasted, and its heat would be troublesome. If the flames were placed across the axis, much of its present extent would fail of reaching the illuminated disk.

5. *The Chimney Cap (J)* is held in place by telescoping the portion of the chimney to which it is attached, into the lower portion *I*. As soon as the flames warm into full vigor, being turned up to about the smoking point, the cap may be lifted some four inches, say by a wooden slide, to avoid touching it with the hand, which will increase the draft, slightly lower and whiten the flames, intensify the light, and more effectually draw off the heat. The light will remain steady and unchanged for two hours and more, without requiring the slightest attention.

6. *The Reflector (H)* is outside the flame chamber, and at sufficient distance from the flames not to be injured by them. Its burnished surface is kept from tarnishing by a protecting film. Its place is fixed so as to require no adjustment of distance or direction. It answers the two-fold purpose of a reflector and a door.

7. *The Condenser (pq)* is suspended free from contact, in a chamber separate from the flame chamber, with



free space between, open above and below. Its front band presents a good bearing for resting the slides against, without exposing the glass to be scratched by them. Its two lenses are removable, while yet they are securely held in concentric cells by wire rings sprung into grooves.

8. *The Cylindrical Form* of the body is suited to the size and shape of the condenser at one end, and the reflector at the other, with opening flaps, setting it above the wooden frame, giving a lamp chamber and a condenser chamber both separate from the flame chamber, and allowing unobstructed air passages without escape of light.

9. *The Stage* (*o*) is unobstructed by a bulky shell wider than itself, is under the hand of the operator standing behind and looking toward the screen, and allows the pictures to slide horizontally into place, one after another, without exposing a blank disk.

The catch drawn out from the under side of the stage, and turned back almost out of the way, is intended to stop the slide in its proper position, but not to interfere with its being moved smoothly along and out by the incoming slide, when slipped forward from the catch by the left hand.

The catch pushed back into its sheath, leaves the stage entirely unobstructed for those who prefer to adjust the slides by hand only, and for other than wooden slides.

The use of stops is the more necessary with a pair of instruments, as it is essential to a proper effect that the dissolving views should occupy exactly the same place on the screen without any readjustment after the dissolving becomes visible.

10. *The Extension Front* is readily removed, to

give access to the interior of the instrument and for various experiments. It can be drawn forward to suit a lens of longer focus. Its hood hides reflected and diffused light, and allows space for curtain and tinters.

11. *The Sciopticon Curtain.*—Turning the milled head at either side, gives the appearance upon the screen of a curtain rising, or falling, thus handsomely opening or closing an exhibition. It may also be temporarily closed at any time, to allow the attention to be directed to other exercises.

The process of changing the pictures may be hidden from view by shutting off the light with the left hand; then pushing the out-going picture into the left hand by sliding another into its place with the right; and then flashing on the light with the right hand; all of which may be sooner done than said. In any change of programme the awkwardness of showing the "full moon," or the disk without a picture, may always be avoided by using the opaque curtain.

This curtain also serves as a back cap for the objective, protecting the back lens from dust and light when not in use, as the front cap protects the front lens.

12. *The Sciopticon Tinters.*—The tinting-glasses are drawn up close behind the objective lens by means of rods terminating in knobs above. This lets the color down upon the screen, not with a sharp outline like the curtain, but with a gradual shading. With the blue tint partially drawn, this property gives to plain photographs of scenery a blue sky, shading off without abruptness down to the horizon. Slightly drawing up the blue, then the red, and then turning the button attached to the opaque curtain a little, fades away gradually the upper portion of the disk,

as is desirable in such slides as the Ascension. The reverse movements bring into view gradually the "Soldier's Dream," "Angel of Peace," etc., nearly as well as with two slides in the dissolving lanterns. All the appearances formerly produced by colored glass in the form of glass slides are better effected by these tinters. If at any time the rods become too loose, the *stop* screws may be tightened.

13. *The Wooden Base* is peculiarly suited to support the several parts and allow of their free and precise adjustments, and to break the metallic conductions. The claw (*m*) and the flange (*n*) hold it securely to the top of the carrying case, when the apparatus is in use.

14. *The Sciopticon is an Original and an Honest Lantern.*—Its materials are what they seem and what the purposes require. It took shape to effect the ends in view, without regard to precedent, or sacrifice to ornament. It is tidy and snug, and its beauty is in its fitness. It was awarded the highest premium by the Judges at the late Franklin Institute Exhibition, who reported as follows:—

"*The Sciopticon with two Coal Oil Flames.*—This lantern originated with Mr. Marcy, and gives the best light, in every respect, yet derived from oil. Portability, compactness, freedom from excessive heat, and *that unusual peculiarity of precisely answering its intended purpose,*" are among its special properties.

*The Centennial Medal* has been Awarded to this, as also to the Lime-light Sciopticon, with Diploma corroborating its claims

PECULIAR ADVANTAGES  
OF THE  
**LIME-LIGHT SCIOPTICON.**

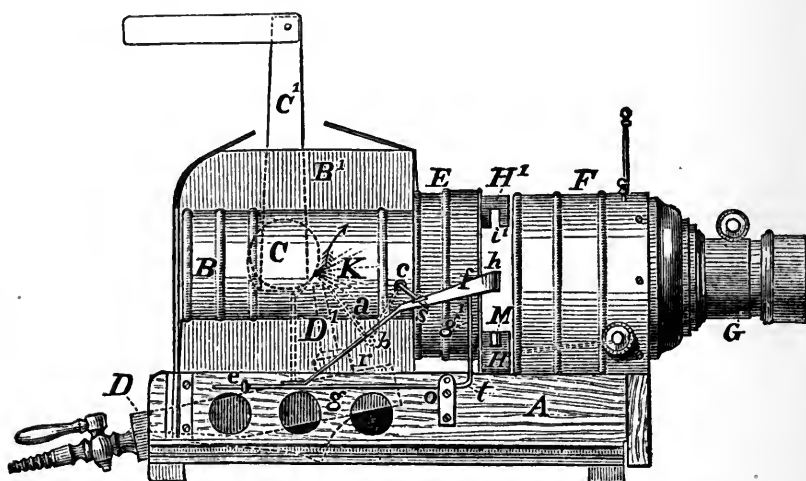

*It retains many of the peculiar features of its prototype, the Oil-light Sciopticon. By comparing the two, it will be seen that the wooden base, the lower and front part of the cylindrical body, the condensing lenses, with their peculiar mounting and attachment, the draw front, with hood, opaque curtain, tinters and objective, are the same, giving to it, so far as they go, the same advantages, and the same general appearance.*

But the distinctive Lime-light Sciopticon drops the flame chamber and its relative parts for the

*Triple Jet*, which has important advantages as a lime light apparatus.

It is mounted in wood plated with metal, which protects and holds the parts firmly in convenient position.

The lime is in the form of a wheel, two and a half inches in diameter, and five-eighths of an inch thick, giving an available surface on its edge, five-eighths of an inch wide, and about eight inches in length.

It lies loosely in its holder or cradle, with its projecting edge presented vertically to the blow-pipe, which, without intercepting the light toward the condenser, inclines backward more than is shown in the diagram, and impinges the gas just below the middle of the front, at about an angle of forty-five degrees, so the heat glances toward the open top, while the light is intercepted in that direction by the upper part of the lime wheel itself. Turning the lime wheel at its projecting back edge a quarter of an inch or so (by the thumb and finger, it being a non-conductor of the heat on its front edge), brings down to the jet a fresh but hot surface, which is kept to its fixed distance by resting against the front of its holder.

The flat mouth of the jet secures to a fuller flow of gas the proportional efficiency of a smaller opening, and moreover, favors the mingling of the gases outside as effectually as it is done in the mixed jet, or nearly so.

The mixed jet No. 3 now resembles No. 2 in appearance, and is tipped with a carefully selected gun nipple, extra ones being forwarded with the apparatus in case any accident befalls the first.

The elongated and curved top of the lime-holder socket serves as a rest for the lime cradle, as a guide to its stem, and as a shield from the alcohol wick.

The height of the alcohol in the wick tube is little affected by tilting the lantern, because the fountain rests abreast of it.

The three burners are interchangeable, giving to this one

compact and convenient arrangement the advantages of the three ordinary separate instruments.

The clamp acts by a simple turn of an outside lever, to hold firmly the base of the jet without interfering with raising or lowering it.

*The Shell* prevents the escape of light with the slightest surface and bulk for retaining the heat. It is provided with side fender near the light, and is arranged with open top and free ventilation. The direct light cannot be seen from behind, but its comparative intensity and distance from the jet are distinctly seen without harm to the eyes, as reflected from the surface of the condenser. Its compactness brings it so completely under the hand of the operator, standing behind, as to make him independent of an assistant.

*The Automatic Cut-off.*—All unnatural conditions and movements detract from that seeming reality which is so characteristic of projected pictures. Alas for seeming distance and solidity, when the changing of the slides suddenly contracts the scenes into dancing shadows on a screen. Even dissolving views, by which the change is effected so charmingly, present many incongruities at war with nature.

The Lime-light Sciopticon, however, with its automatic cut-off, shows no commotion nor commingling, to weaken the stereoscopic effect, nor any blank of appreciable duration, for suspense. It is more in consonance with nature, and is less hurtful to sight. It seems like closing the eyes on one scene and instantly opening them on another. Its operation is natural and agreeable, and we have its advantages in a single instrument, which is comparatively inexpensive. See Manual, pp. 167–170.

*How to Secure the Fullest Advantages of  
the Oil light and of the Lime Light,  
all at the Least Expense.*

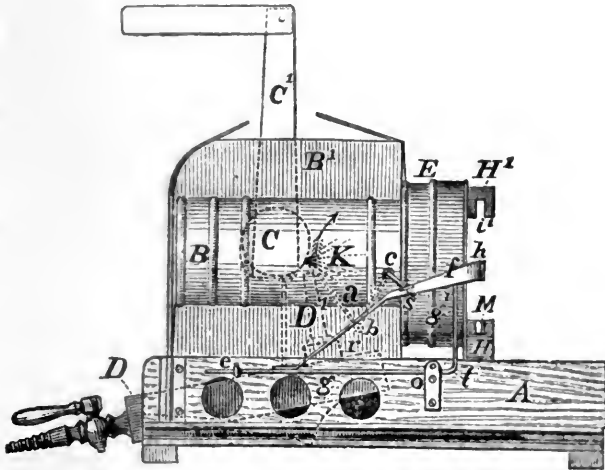

The portion of the Gas Sciopticon shown above, including the triple-jet, is all that is necessary for one having the Oil Sciopticon complete to have the Gas Sciopticon also complete, for the condenser, objective and draw-front are perfectly suited to either. The Lime light in the Oil-light Sciopticon (see Manual, p. 160) is not at its best, because it is somewhat inconvenient, and the clamp and the automatic cut-off cannot be attached to it; neither is the Lime-light Sciopticon with a Sciopticon lamp and flame chamber sliding into it a perfect arrangement. But, with the Oil Sciopticon complete, and with the Sciopticon and jet as shown above, either of them, with the lenses and draw-front, is at its best, and the cost of both is but seventy dollars, or sixty-five without the automatic cut-off.

### *Late Improvements.*

It will be seen, by examining the triple-jet as now made, that it has been improved since the illustrating cuts were drawn, by plating it completely with metal, to prevent burning, in case a piece of hot lime falls upon it; by the clamp operated at the side of the lantern body, to fix it firmly in position when adjusted; by an easier working screw in a more convenient position for regulating the height, and which will lower the jet so it will slide under the flame chamber of the Oil-light Sciopticon; by the backward inclination of the jet tubes so as to strike more in front of the lime; by giving the mixed jet a conical shape, and tipping it with a gun nipple or platina; by using a lime holder for the alcohol burner, which is held by its sliding over the alcohol tube, utilizing its heat in vaporizing the alcohol; by a roller attached to the latch of the winker, and a thumb-screw at its lower bearing, to ease and moderate its movement; by a chimney which more completely shuts in the light without preventing the escape of heat; by a hand-wrench which tightens or unscrews the outer tube by its half-round end, and works the oxygen tube and nipple with the other; by using a shorter holder and a larger lime (two and a half inches in diameter) for the gas lantern; and by an improved spring in the slide carrier.

Though we often indulge in reforming our apparatus, as has just been shown, we do not recommend the practice to purchasers at the first start. There is a tendency among experts in familiar styles to modify what is new into what is more in accordance with preconceived notions; so this apparatus sometimes gets twisted till it is not like itself, nor like anything else, either. For example, the goose-neck jet, which is a familiar form, and very good in its



place, does not match well when grafted on to the triple-jet. The peculiar advantages of the lime wheel are lost by a flat-side exposure. The several lenses of the objective, when taken apart by the curious, are often replaced haphazard, to the confusion of all distinctness in the image.

Many operators persist in standing at the front of the instrument, with back to the screen—because the old lanterns obliged them to—instead of standing behind, facing the screen, according to directions.

It is a mistake to suppose that the Lime-light Sciopticon is not as effective as the so-called Stereopticon, because it is smaller. The old style must be made large, because of the material of which it is made, and the amount of heat confined in it. The apparatus herein represented, beside being more convenient, is in every respect fully equal to the best, with many points of advantage for producing the intensest lime-light.

### *Lantern Projections as an Educational Appliance.*

The pathway to learning, though proverbially not a royal road, is, nevertheless, made pleasanter and less difficult by the pictorial illustrations now brought to bear in schools of every grade, and on subjects of almost every variety.

Small pictures, though invaluable for private use, seem comparatively tame when passed from hand to hand for the entertainment of a company, but when projected to life-size, they seem like living reality, and address themselves to multitudes at once. They are viewed with cumulative enthusiasm when all eyes are concentrated upon the views under discussion one by one, other objects being kept dark, and so out of mind.

Without the expense or fatigue of travel, as has been truthfully and glowingly said, the beholders are carried, in imagination, to far distant lands, where they may gaze upon the art treasures and wonders of the old world, or on the mystic temples and pyramids of the river Nile. They may run riot through the beautiful palaces of Versailles, or may see pass before them a panorama of events covering ages of ancient history.

These wonderful sun-pictures, seen as they are, magnified and illuminated by the intense lights used, convey to the mind of the spectator a better idea of the places and scenes depicted than could be had by reading volumes upon volumes of books of travel. In speaking of the statuary shown, the artists themselves say, that the fullest beauty of the original sculpture is stereoscopically reproduced ; in fact, the marble seems standing out before you in bold relief.

Projected pictures in the lecture room have peculiar advantages over charts and sketches, which are so much and so deservedly praised by modern educators. They arrest attention, as when there came forth fingers of a man's hand and wrote upon the plaster of the wall in Belshazzar's palace. They are not subject to wear and tear, like unwieldy picture charts let down from rollers or sorted out of mammoth portfolios, but they follow one another without fuss or confusion, "like the baseless fabric of a vision," and then dissolve away and relieve us from all care. They may be enlarged or contracted, or raised or lowered, or faced to right or left, or changed from grave to gay, or varied by a succession of surprises with the greatest facility, though in appearance they are as large and solid as the Alps.

They are free from the confusing gloss of painted and varnished surfaces ; they are seen from every direction in the best light, and are themselves the source of sufficient light

to relieve the room from unpleasant darkness. They fix impressions upon the brain, so to speak, with a photographic accuracy and fullness of detail not realized in that modern favorite, the blackboard, even with an accomplished draughtsman as lecturer.

While these projections may not fully take the place of models and physical instruments, they may be largely used in their stead, and, moreover, they can present enlargements of what in them is small, bring into view hidden parts, show in detail what is complex, and so cover the whole ground of an extensive and expensive assortment of other philosophical apparatus, and very much besides

An Oil-light Sciopticon and case, with a slide-carrier and a glass tank, and *two hundred* scientific sciopticon slides, showing more than two thousand objects distinct and clear, are all now herein offered for one hundred dollars. These representations are as well classified, and can be as plainly seen, to say the least, as the real objects in the cabinets of any academy of natural science. These sciopticon slides are remarkably clear, and yet vigorous, so as to be suited both for the oil and for the lime-light. Poor slides are sometimes sold at half price, but it is a new thing for the best slides to be offered at less than half price. There must be large demand to justify such reduction.

The cost of producing each depends much on the quantity made, and the profit depends much on whether the whole production meets with ready sale. As bottom prices and lavish advertisements are incompatible, I venture here to solicit of educators a good word freely spoken by those who know, to fellow-laborers who do not know, the advantages of our apparatus and terms.

## *Comparison of the Different Sources of Illumination.*

Of course, the brighter the illumination the more satisfactory are magic-lantern projections. Lights are so variable that an exact ratio of their relative intensity can hardly be given, and besides, their efficiency cannot be counted in exact proportion to the amount of light given.

The Electric light is by far the most intense, but, for the most part, the difficulties at present attending its use practically throw it out of the question.

The Magnesium light, though approaching the Lime light in brightness, is too uncertain to be relied on, and its fumes are troublesome.

House gas, though well suited for common illumination, lacks the concentration so essential in the lantern

Practically the Lime light, variously rated at 100 candles and upward, must mostly be relied on for brilliant public exhibitions.

Marcy's lamp gives the brightest flame illumination, but it is not only its amount of light and its intensity, but its advantageous shape, which gives it such remarkable efficiency in the Sciopticon

Of course the room should be effectually darkened preparatory to an exhibition. The apparent brightness of the pictures, however, depend very much on whether the pupil of the eye is more or less dilated. It is safe to say that a person coming to an Oil-light exhibition from the darkness of evening would be as much impressed by it as if coming suddenly from the light of day to witness the effect of lime light. Care should be taken, therefore, to give time for the eye to become accustomed to the darkness, and to prevent dazzling brightness from reaching the spectators from the instrument, or from the white screen, as well as from lights but partially shut off. According to the same principle, passing

colored shades over the screen occasionally, by using the tinters, gives a sense of a brighter light.

For large public exhibitions, the mixed jet lime-light is necessary, and is in common use, mostly in two lanterns, with the dissolving cock, for producing the dissolving views. A single lantern with automatic cut-off and glass slides produces an agreeable effect, and is much easier and cheaper. See Manual, page 168.

The Mixed Jet can also be used to great advantage in educational institutions, where the gases are stored in gasometers, as recommended in the Sciopticon Manual, page 182.

This makes available, at a moment's notice, the best light, and it can be used in the daytime, with such darkening of the windows as can easily be effected by shutters or curtains.

The effects of the Concentric Jet, No. 2, is scarcely inferior to the mixed jet, and there is a great advantage in using it, wherever the house gas is within reach, because it is easier to manage, and because it is not at all dangerous.

The Alcohol Burner, No. 1, is somewhat more difficult to manage than either of the other forms of lime light, but is used to advantage where hydrogen or house gas is not easily obtainable.

The Sciopticon with its oil lamp, rather than with its lime light, though less effective, continues to be the choice of the many, for its being always ready, easy to manage, and inexpensive to use; showing with great brilliancy and steadiness for hours without readjustments or annoyance, and without heating the oil or cracking the glass; while to close an exhibition, we have no further care than to turn down the wicks.

**As a Home Influence,** it is worthy of all praise. Without drudgery or delay it transforms the drawing room into an art gallery, where the family circle may pass their leisure

evenings "mid pleasures and palaces," without roaming from "home, sweet home."

**Sunday-school Workers** find it manageable and specially useful in explaining Bible scenes and localities, and Oriental manners and customs. The Sunday-school Concert is made intensely interesting by illustrating the recitations of the children, and by projecting hymns upon the screen, to be sung in concert. Series of Bible and Holy Land Views are very carefully selected, with special reference to the Sunday-school work. Illustrations in outline, mottoes, hymns, etc., can also be drawn by hand, as occasion requires. These fascinating representations and exercises not only promote the growth and usefulness of a Sunday-school, but when necessary, serve as a ready means of raising funds.

Scripture illustrations corresponding to the subjects enumerated in Class v, page 12, are now made very clear and distinct for Sunday-school use, in the Oil-light lantern, of which we give with the instrument and case a hundred slides, with five hundred distinct illustrations, for seventy-five dollars.

The Oil-light Sciopticon is the only efficient lantern for the lecture room that does not require constant watching and hours of drudgery. It permits the teacher to give his undivided attention to his subject, and so is in common use in first-class institutions, where the lime light is held in reserve for great occasions.

The Oil-light Sciopticon is also unrivaled for **Masonic** and other **Societies**, for ordinary **Public Exhibitions**, for **Social Entertainments**, for conveniently showing up chemical reactions, living insects, minnows, water newts, etc., photographs of microscopic objects, natural and diseased tissues, enlargements for sketching, negatives and positives for examination and discussion in photographic

associations, and for objects too numerous to particularize. With slides improved in quality and cheapened in price, this unique form of Magic Lantern is inaugurating a new era in this species of representation, for it can be easily used and with good effect, where troublesome and complicated arrangements would be altogether out of the question.

### *The Slide Question—Plain or Colored?*

The better class of colored slides will doubtless, to a large extent, continue to be a necessity, notwithstanding plain photographs on glass, which are now made so fine, so abundant, and so cheap, constitute our main reliance. The work of the skillful painter is too costly to be largely afforded, while glass photographs are printed and mounted by less and cheaper labor. The best colored slides are first photographed from large fine engravings, which give to the subsequent high coloring which these pictures admit of fine and distinct outlines; the best uncolored slides are mostly taken from sober nature, with such detail of shading as scarcely to admit of improvement from the painter's brush.

The colored slides in this catalogue are mounted in balsam, between plate glass, in wooden frames, with circular opening three and a half inches in diameter (see "New Departure," Manual, page 146). The price (\$2.50, the market price of the old-fashioned kind) continues to stand as in old editions, while the quality is far better, and the cost of production is considerably greater. Some subjects can be better mounted in frames with square opening; this style is priced the same, and is called, *par excellence*, the Artslide. It must be confessed, that there are comparatively few additional subjects corresponding in excellence with the colored slides enumerated in Classes I and II of

Part Second., so that customers looking for the most beautiful effects, without being restricted to a specific programme, will do well to consult these choice selected lists.

Plain slides are now more frequently called for than those colored and mounted in wood, not only because they are cheaper, but because they are really quite in the fashion.

Most of the plain or glass slides in market are in one or other of three shapes, viz. :

1. Views of interest in America, produced by American photographers, are mostly made on quarter plate B. P. C. glass (best polished crown glass, three and a quarter by four and a quarter inches). This gives to the sides of the three-inch pictures a margin of fully half an inch for labels and for handling. The Woodbury and the Scientific Sciopticon Slides are also of the same size and shape.

2. The French slides are but four inches wide, the quarter of an inch being taken from the picture, and they are of thin glass. They are extensively used, and the best of them are doubtless the best in the market.

3. The English slides have also a smaller picture, with just margin enough all round for binding, making the whole three and a quarter inches square. They are apt to fail of covering the full opening in the slide carrier; the name has to be stuck on the edge, and there are twice as many ways of getting it on to the screen in a wrong position.

The Scientific Sciopticon slides are the most uniformly good for their purpose, and are put at the low price of thirty cents each, or twenty-five cents each by the set, to insure their being introduced so extensively as to be manufactured to advantage. French slides are here reduced to sixty cents each, and the most of others to fifty cents.



### *Nature or Art?*

An unreasonable prejudice prevails, to some extent, against all slides not photographed from nature. When there is a choice, as, for example, between a photograph of the Egyptian Pyramids and an artist's representation, as roughly shown, page 113 of the Manual, the sun picture surely has the advantage; yet something can be said, even in this case, for the artist, who gathers the details of many chance observations into one view, and groups the camels and Arabs into an artistic pose more picturesque than would come within the range of a photographer's average luck. Historic and art pictures, and scientific illustrations, which have been wrought out by the best skill and learning of the present and the past, can, for the most part, only be copied into slides from these works of art.

### *Strong or Faint?*

It is a mistake to suppose that pictures intended for the Sciopticon should be selected with special reference to the light used. The proper density for the Sciopticon flame illumination differs little, if any, from what is best for the lime light proportionally enlarged. Dense pictures fogged in the high lights, may be shown a little, by lime light, and the glaring defects of coarse pictures may show less by oil light, but neither class is worthy of being recommended. The class of customers most anxious to secure clear, bright pictures, are professional exhibitors with a lime light.

### *The Bad and the Good.*

It is matter for regret, that with our present facilities for producing good slides of every class, so many bad ones

should flood the market. Faults may arise from poor subjects, bad chemicals, foggy plates, cloudy weather, careless manipulations, or any of the many drawbacks that glass-slide photography is peculiarly liable to, as well as from colors hastily and unskillfully applied. Slides, good, bad and indifferent, made in quantity and sold to dealers without remnants, can be afforded at low price. The anxiety of purchasers to buy at a bargain favors the working off of this stock.

To counteract this tendency the New Departure slides, though involving much greater outlay than those of the ordinary size, have nevertheless continued to be sold at the old price. Few would be willing to give more, and yet it is felt to be necessary to introduce a better class of slides, in order to show the capabilities of this species of representation. Unskillful productions of glass slides are avoided, and selections from good lots are very carefully made, and then priced at a low figure. We make it for the interest of purchasers to lay their commands on us, that they may have reason to be satisfied if they do so, and that they may be losers if they fail to do so.

### *What's in a Name?*

It is found that some rousing title to a public entertainment helps to popularize it in advance. The following is a suggestive list of subjects:—

The World, from Chaos to Man.	Constantinople and the Bosphorus.
The History of Joseph.	China and the Chinese.
The Pilgrim's Progress.	The Ice-bound Seas of the Frozen North.
Ten Nights in a Bar-room.	The Emerald Isle.
The Drunkard's Career and End.	An Evening with the Ancients—
Life and Journeyings of St. Paul.	Egypt, Greece, and Rome.
Milton's Paradise Lost.	The Wonders of the Star Depths.
Important Events in American History.	

The foregoing are mostly in colored slides: the following are plain photographs from nature:—

- |  |  |
|--|--|
| America, The Home of the Free.                 | Italy and the Art World.                         |
| Across the Continent, from Ocean to Ocean.     | Constantinople and the Mystic Orient.            |
| Magnificent Scenery of the Great West.         | Panorama of the Great Cities of Europe.          |
| California and the Yosemite Valley.            | Switzerland and Mont Blanc.                      |
| England and its Cathedrals.                    | St. Petersburg, Moscow, and the Kremlin.         |
| Scotland and the Highlands.                    | Jerusalem, the Holy City                         |
| Ireland and the Lakes of Killarney.            | Wandering on Holy Ground, from Dan to Beersheba. |
| London, the Metropolis of the World.           | The Wonders of Egypt and the River Nile.         |
| A Journey from London to Paris.                | The Alhambra and Sunny Spain.                    |
| Paris and the Louvre.                          | A Panorama of the Great Cities of the World.     |
| The Art Treasures of Paris and Versailles.     | A Tour of the World in Eighty Minutes.           |
| A Flying Trip to Places of Interest in Europe. | The Wonders of the World.                        |
| The Beautiful Rhine, its Castles and Romances. | Masterpieces of Ancient and Modern Art.          |
| The Cities of the Mediterranean.               | History of Culture.                              |
| Venice, Naples, Athens, and the Mediterranean. | Gems of the Centennial Exhibition.               |
| Rome, the Eternal City.                        |  |

We furnish Descriptive Lectures, without charge, to accompany sets of slides of the following subjects:—

- |  |  |
|--|--|
| Egypt and the Nile.                            | China and the Chinese.                           |
| Syria and Palestine.                           | Astronomy—Natural Phenomena                      |
| Life and Travels of St. Paul.                  | The Tabernacle and Temple.                       |
| Pilgrim's Progress.                            | Bible Animals, Scripture Customs and Manners.    |
| Christiana and her Children.                   | The Cities of Southeast Europe.                  |
| Rome, the Capital of the Cesars and the Popes. | The Cities of Northeast Europe.                  |
| Tour in Switzerland.                           | Italy, its Ancient, Mediaeval and Modern Cities. |
| Tour on the Rhine.                             | American Scenery in the Far West etc.            |
| Paris.   |  |
| Ireland.                                       |  |

Larger Works will be furnished at Publishers' prices. Manuscript descriptions of miscellaneous slides will be furnished at the cost of transcribing.

First-class "Stereopticon Exhibitions" are usually given with a pair of dissolving lanterns. All the mystery of dissolving, of tinting, and of cloud effects is particularly fascinating to an uninitiated crowd, who are all agape and in blissful ignorance of what's a coming. A Cabinet Organ in the hands of a good performer is found to be very effective. Vocal music can also be introduced, particularly in such entertainments as the "Pilgrim's Progress," etc.

Professor Cromwell, a pioneer in this modern style of giving "Art Entertainments," and those who follow in his wake, intersperse statuary, and copies of art treasures, etc., found at the places visited. The entertainments are closed with any of the Allegories, such as "No Cross, no Crown," "Rock of Ages," "Mother's Dream," etc., or with Chromotropes. The apparatus is usually hidden from vulgar eyes in about the middle of the hall, in a sort of inclosure, resembling, we may suppose, the Tabernacle in the Wilderness.

### *The Sciopticon Catalogue Arrangement.*

Catalogues abounding with cuts of magic lanterns, named in honor of people of every class and age, are issued by dealers, who act as agents for all other dealers, which gives great variety to the sizes and shapes displayed.

This Catalogue distinctively represents only the two types of the Sciopticon described in this Introduction, with the ordinary accessories and attachments. It claims to make up in quality what it lacks in variety. The showing is made as distinct as possible, in order to prevent perplexity before purchase, or disappointment after.

**Part First** comprises Sciopticon apparatus and accessories.

The sample combinations, beginning with No. 78, with such concessions as can be afforded, may serve in place of lengthy correspondence.

**Part Second** relates to colored wood-mounted slides and movables; of these, classes I and II now include our choicest selections. The order of the remaining classes is unchanged, as there seems little need of introducing confusion by altering the arrangement of standard colored pictures.

All our colored slides are now in the New Departure style, gotten up with additional care and cost, so that allowing the figures to remain the same is equivalent to a reduction in price.

The complete illustrations of the text of the Holy Bible, as first presented in 3-inch colored sealed slides in class v, would have cost 1200 dollars. Afterwards they were finished with less care and offered for 700 dollars. Now the same subjects, excepting some of the scenery, for which others are substituted, or more than 500 distinct and clear illustrations on 100 glass slides, are here offered for 25 dollars. This bit of history explains why class v did properly belong among the colored slides of Part Second, though now it represents but 100 glass slides, with several illustrations on each.

Great efforts have been made to keep lists to illustrate the International Sunday-school Lessons, but with indifferent success. Many of these peculiar slides are unavoidably poor, having no permanent value to outlast the day appointed for their use. It is now thought best, therefore, to keep the standard Scripture illustrations as complete as possible, and to fill out the lessons from time to time, as the demand seems to justify.

Full sets of Masonic and other lodge pictures (from nega-

tives which we exclusively hold) are made in New Departure style at \$2 50 each. All the emblems in the degrees of Entered Apprentice, Fellow Craft and Master Mason, arranged in accordance with the American system of lectures, are distinctly shown on thirty plain glass slides. The price of the set is ten dollars. These and some other technical subjects are not catalogued in detail.

Views of interest in different parts of the world, named in class VI, are among our most beautiful slides; and the list might be greatly extended to advantage, were it not that all subjects that admit of being taken directly from nature are now mostly preferred in Levy or other plain slides.

The Scientific Department of Part Second can hardly be better; the Scientific Sciopticon slides of Part Third, however, cover much more ground for less money, and in this direction we are resolved that something more than has been done shall be done. The same departure from the old three-inch size is carried into statuary and the wood-mounted scientific slides. The increased cost prevents reduction in price.

Great care has been taken to catalogue, in Part Third, the most desirable selections from the almost endless variety of foreign and domestic glass slides, and to arrange them in natural order.

It will be observed that we not only claim to represent improved apparatus, but that our prices, where concession is admissible, range very low.

We are gratified by the growing favor with which the Sciopticon in both forms is received, and we choose not to load it down in its course with lame accessories, poor slides, high prices, or unlooked-for contingent charges.

# Marcy's Sclipticon Catalogue.

---

## PART FIRST.

---

### PRICE LIST OF SCLIPTICON APPARATUS.

The ordinary Sclipticon condenser consists of a 4½-inch collecting lens and a 4 $\frac{3}{8}$ -inch concentrating lens, with a combined back focus of 2 inches. This arrangement seems the best for standard slides and for ordinary use. To substitute a 4½-inch condenser adds \$5 to the price. It adds \$3 to the expense to substitute an objective of 10-inch back focus with condenser to match, to be used in the back gallery of a church, for example (see Manual, p. 164).

1. **THE OIL SCLIPTICON**, complete, of the latest and most careful and finished construction (see Introduction, p. 111) \$45 00
2. **Sclipticon Case**, for carrying the instrument in, and for standing it upon when in use..... 3 00
3. **Sclipticon Case** (same as No. 2), with the addition of adjustable legs..... 5 00
4. **Box**, for 100 wooden-mounted slides..... 2 50  
**Box**, for 60 wooden-mounted slides..... 1 50
5. **Double Case**, for a pair of dissolving Sclipticons, which, with its adjustable legs, becomes the exhibiting stand; black walnut, finely finished and polished..... 10 00
6. **Dissolver**, for a pair of Sclipticons with oil lamps..... 2 00
7. **Pair of Sclipticons**, like No. 1, with case and dissolver, Nos. 5 and 6 (see Manual, p. 40, Fig. 16)..... 100 00
8. **Screen**, 12 feet long, 9 feet wide, without seam, hemmed and with loops..... 3 00  
Screens, rollers and frames of any specified size made to order.

9.	<i>Marcy's Triple Jet</i> , alcohol, concentric and mixed (see Manual, p. 158).....	\$15 00
	Without alcohol fountain.....	12 00
10.	<b>THE LIME-LIGHT SCIOPTICON</b> , complete, including triple jet and clamp, and the automatic cut-off, with its peculiar slide carrier (see Introduction, p. ix, and Manual pp. 161, 168).....	50 00
11.	<i>Same</i> as No. 10, but without the alcohol fountain.....	47 00
12.	<i>Same</i> as No. 11, but without the cut-off.....	42 00
13.	<i>Both</i> the Oil Sciopticon No. 1, and the Gas Sciopticon No. 10, all complete, but with only one set of lenses (see Introduction, p. xi).....	70 00
14.	<i>Same</i> as No. 13, but without alcohol fountain.....	67 00
15.	<i>Dissolving Cock</i> , with screws to adjust to either mixed or concentric jets (see Manual, p. 171).....	12 00
16.	<i>Dissolving Cock</i> , for alcohol burners.....	6 00

#### GAS BAGS, GENERATORS, ETC.

17.	<i>India-Rubber Bag</i> , best quality, 30 inches long by 24 inches wide, with large stop-cock.....	10 00
18.	<i>India-Rubber Bag</i> , best quality, 40 inches long by 30 inches wide, with large stop-cock.....	14 00
19.	<i>India-Rubber Bag</i> , large size wedge, best quality, 40 inches long by 30 inches wide, with large stop-cock.....	18 00
20.	<i>Pressure Boards</i> (generally improvised—see Manual, p. 175).....	3 00
21.	<i>Retort</i> and cap, wash-bottle and connections (see Manual, p. 173, Fig. 46, b, c, d, e, f).....	7 00
22.	<i>Gas Furnace</i> (see Manual, p. 173, Fig. 46, a).....	2 00
23.	<i>Alcohol Lamp</i> , with three wicks, for heating retort, etc. (common stove often used instead).....	1 00
24.	<i>Same</i> as No. 21, but of extra size, for gasometer, described in Manual, p. 182.....	9 00
25.	Five-gallon <i>Hydrogen Generator</i> (see Manual, p. 175, Fig. 47, a, b, d, e, f).....	7 00
26.	Ten-gallon <i>Hydrogen Generator</i> , for gasometer (boxing included, as usual).....	9 00
27.	Self-condensing <i>Oxygen Gas Cylinder</i> , with gauge and wrench (see Manual, p. 170).....	45 00
28.	Self-condensing <i>Hydrogen Gas Cylinder</i> , with gauge and wrench.....	60 00
29.	Pair of Self-condensing <i>Cylinders</i> , same as Nos. 27, 28.....	100 00
30.	<i>Rubber Tubing</i> , per foot.....	25



### CHEMICALS, CHEMICAL APPARATUS, ETC.

81. *Chlorate of Potash* and *Black Oxide of Manganese*, best quality, by the pound or hundred-weight, at the lowest market rates. Packages with a pound of the former and four ounces of the latter in each (see Manual, p. 172), per dozen..... \$6 00
82. *Zinc*, granulated, per pound..... 20  
 Scrap zinc, twisted so as not to mat, is better, and usually cheaper. Iron filings or nails will answer.
83. *Sulphuric Acid*, by the carboy of 160 pounds, boxed for shipment as freight (express companies refuse to take it) 7 50  
 Smaller quantities can be sent the same way, but generally it is better to get it of a near druggist. It must not be packed with other goods.
84. Four 2½-inch *Lime Wheels*, in patent canister..... 75  
 As soon as an exhibition is over, the lime can be placed in this portable canister, closing air-tight, and so will last for several occasions.
85. A Sealed Canister of a dozen 2½-inch *Lime Wheels*..... 1 75
86. *Sciopticon Tank* (see Manual, p. 84, Fig. 26)..... 1 00
87. *Tank*, with clamps (see Manual, p. 84, Fig. 26)..... 3 00
88. Two *Pipettes*, with rubber bulb and a dozen glass tubes..... 1 50
89. *Plate Glass*, 4¼ by 3¼, to show crystallization, etc., per doz. 1 50
40. *Glass*, quarter plate, B. P. C., per dozen..... 30
41. *Glass*, coated for tracing, per dozen..... 60  
 Scratching clear lines upon a coating of dense blue gives the best effect, and is the easiest to do. Drawing with India ink or carmine upon a clear varnished surface is most in use (see Manual, p. 135).  
 Chemicals for tank experiments, colors, mats, etc., for slides, and all lantern appliances not herein enumerated, will be furnished at the lowest market prices.

### SEPARATE PARTS OF APPARATUS OCCASIONALLY CALLED FOR TO SUPPLY DEFICIENCIES.

42. *Sciopticon Objective*, corrected for use on the Sciopticon (see Manual, p. 30, Fig. 15, *a, b, c, d*)..... 10 00
43. *Objective*, for long distances, 10-inch back focus (see Manual, p. 164)..... 12 00
44. *Sciopticon Condenser*, mounted, and fitting any of the new instruments..... 12 00
45. *Plano-Convex Condensing Lens*, diameter 3½ inches..... 8 00  
 4 inches..... 4 00  
 4⅞ inches..... 4 50  
 4½ inches..... 6 00  
 5 inches..... 7 50

46.	<i>Tinters</i> , with two colored films and opaque curtain.....	\$3 00
47.	<i>Flame Chamber Glass and Frame</i> , for front.....	50
	For back.....	25
48.	<i>Reflector</i> , of focus and shape to fit any Sciopticon.....	2 00
49.	<i>Sciopticon Lamp</i> (incomplete in itself; see Manual, p. 80, Fig. 15, s).....	2 50
50.	Sciopticon Lamp <i>Wicks</i> , per dozen.....	25
51.	<i>Brass Stage and Spring</i> , with stop.....	75
52.	<i>Slide Carrier</i> , a part of the automatic cut-off patent, but can be used in any Sciopticon (see Manual, p. 169, Fig. 44)	1 50
53.	<i>Ordinary Slide Carrier</i> .....	20
54.	<i>Chimney Cap and Extension</i> .....	1 00
55.	<i>Alcohol Jet No. 1</i> .....	1 00
56.	<i>Jet No. 2</i> .....	1 50
57.	<i>Centre Jet</i> .....	50
58.	<i>Mixed Jet No. 3</i> .....	2 00
59.	<i>Flat Jet Broach</i> .....	20
60.	<i>Jet Wrench</i> .....	50
61.	<i>Clamp for Base</i> .....	1 50
62.	<i>Lime Holder</i> .....	50
63.	<i>Base for Lime Holder</i> .....	50
64.	<i>Stop-cocks for Jet</i> , each.....	1 25
65.	<i>Lead Washers</i> , per dozen.....	25
66.	<i>Large Gas Bag Stop-cock</i> .....	2 00
	The price of gas bags without stop-cock is less by two dollars.	
67.	<i>Alcohol Fountain</i> , with stop-cock and feeder.....	2 50
68.	<i>Connection for tubing</i> .....	15
69.	<b>T</b> <i>Connection</i> for running two tubes into one.....	50

#### LANTERN ATTACHMENTS.

70.	<i>Sciopticon Gas Microscope Attachment</i> , Zentmayer's pat- tern (see Manual, p. 191).....	30 00
71.	<i>New Pattern Objective</i> , $1\frac{1}{2}$ inch.....	30 00
	$\frac{8}{10}$ inch.....	25 00
	$\frac{4}{10}$ inch.....	25 00
72.	<i>Microscopic Objects</i> , from 75 cents to.....	1 50
73.	<i>Holman's Siphon Slide</i> , with cover, rubber tubes and bot- tles (see Manual, p. 190).....	5 00
74.	<i>Holman's Life and Current Slide</i> .....	1 50

75. *Sciopticon Kalcidoscope*, with Chromatrope..... \$20 00  
 This is an improved arrangement; the position of light is not changed; it screws into the flange in place of the objective.
76. *Sciopticon Megascop*e, for either oil or lime light; easily attached in most advantageous position (see Manual, p. 195)..... 5 00
77. *Polariscop*e (see Manual, p. 199, Fig. 57)..... 60 00

**COMBINATIONS AND ESTIMATES.**

78. *Oxygen Bag*, etc., No. 17; Retort, etc., No. 20; a dozen oxygen charges, No. 31; four 2½-inch lime wheels, in patent canister, No. 34; a dozen feet of tubing, No. 30..... 30 00
79. *Gas Sciopticon* No. 11, with bag, etc., No. 78..... 77 00

This is complete for concentric jet where house gas is within reach.

With Alcohol Fountain, etc..... 80 00

80. *Same* as No. 79, with hydrogen bag No. 18..... 95 00

This is complete for either concentric or mixed jet, where the hydrogen bag can be filled from the house gas burner. Some timid exhibitors use the concentric jet in connection with a slight pressure on the hydrogen bag, instead of the mixed jet with equal pressure on both bags; but the mixed jet is unquestionably enough better, and more saving of gas, to give it the preference, when means for its production are at hand.

81. *Same* as No. 80, but with the hydrogen generator No. 25 and ten pounds of scrap or granulated zinc..... 100 00

82. *Gas Sciopticon* No. 10, with condensing gas cylinder for oxygen No. 27; a dozen oxygen charges; 4 limes; 12 feet of tubing..... 100 00

This No. 82 effects the same as No. 79 (see Manual, p. 181, Fig. 49)

83. *Gas Sciopticon* No. 11, with a pair of self-condensing cylinders No. 29, a dozen oxygen charges, four limes, six feet of tubing and ten pounds of scrap zinc..... 150 00

Either 81 or 83 is complete for the concentric or the mixed jet. The cylinders, if in perfect condition, are evidently the most convenient, and persons accustomed to their use would not willingly do without them; questions, however, as to their continuous reliability and enduring safety are still in dispute among experts, and in common with cylinders charged by the forcing pump, there is still some difficulty in using them in connection with dissolving views.

84. *The Oil Sciopticon* No. 1, and the Triple Jet No. 9..... \$60 00

It will be seen that it costs but \$62 to get both the Oil and the Gas Sciopticon and clamp, with one set of lenses; or \$70, if alcohol fountain and cut-off are all included; so, in most cases, where both oil and the lime lights are desired, both lantern bodies will also be preferred, as shown on page xiii of the preceding Introduction

85. *For Dissolving Views*: two Sciopticons No. 12 (the cut-off not needed), dissolving cock No. 15..... 96 00  
 With alcohol fountain and dissolving cock No. 16..... 96 00  
 With oxygen accessories No. 78..... 126 00  
 With hydrogen bag No. 18..... 144 00  
 With hydrogen generator No. 25..... 150 00  
 With double case and legs No. 61..... 160 00

Accessories may be varied to suit circumstances, as in the case of a single instrument.

86. As an element of a hundred dollar outfit an Oil Sciopticon No. 1, Case No. 2, and one best Chromatrope, or its equivalent..... 50 00
87. *Same* as No. 86, with 30 French slides of European Scenery, 30 American Scenery, 30 Woodbury slides, and 30 statuary and plain art slides..... 100 00
88. *Same* as No. 86, with 200 scientific Sciopticon slides..... 100 00
89. *Same* as No. 86, with 100 slides of Scripture illustrations..... 75 00
90. In wood mounted slides, the same departure from the old three-inch size is carried into statuary and the wood-mounted scientific slides. The increased cost prevents any general reduction, but as an element of an outfit limited to the following, for which there will be made special preparation: Six large colored slides, viz., Washington and Lafayette at Mt. Vernon, The Magic Grotto, The Little Foxes, Sunday in the Backwoods, and two effect slides, say Washington's Dream and The Believer's Vision, and a dozen statuary, blacked out and mounted in wooden frames, viz.:—Night, Morning, Europe, Asia, Africa, America, Tap at the Window, Faith at the Cross, Groups, etc..... 25 00
91. *Masonic Outfit*. Oil Sciopticon No. 1, Case No. 2, patent slide carrier No. 52, and over 100 symbols in the degrees of Entered Apprentice, Fellow Craft, and Master Mason, arranged in accordance with the American system of lectures, on 30 plain slides, very distinct and clear..... 55 00

# REDUCTION IN PRICES.

---

**Framed Colored Sealed Slides** (see Catalogue, Class I to X inclusive), in New Departure Style (3½ inches in the clear), are reduced from \$2.50 to \$1.50 each. The ordinary 3-inch Slides are reduced to \$1.50 each.

**Framed Statuary, etc.**, are reduced from \$1.50 to \$1.00 each. These include—

1. Blacked-out Statuary (see Class XIV).
2. Scientific Colored Slides (see Class XX to XXXIII inclusive).
3. Novelties, such as Lightning, Frost-work, some dozen Cloud Effects, Water Effects, etc., and such as Mercury, Venus, Angel of Peace, Night, Morning, etc., each in beautiful clouds, which can be very effectively used in one Lantern, and variegated by cut-off, tinters, etc.

The most of the above can be furnished smaller, and without frames, at from 50 to 75 cents each.

**Chromotropes**, improved and enlarged, are reduced in price. Those with three glasses, as Good Night, Washington, Bee Hive, Aquarium, Fountain, etc., to \$5.00 each. Those with two glasses to \$4.00 each.

**Unframed Colored Slides** are reduced to 75 cents each.

**Scientific Sciopticon Slides**, and Scripture Antiquities, etc., are 30 cents each, or \$25.00 per hundred.

**American Views** (see Class XI), are 50 cents each.

**Foreign Plain Slides** (see Class XII), are 60 cents each.

Further particulars furnished on application.

**L. J. MARCY,**  
1340 Chestnut Street, Philadelphia.



# Marcy's Scepticon Catalogue.

## PART SECOND.

### COLORED MAGIC LANTERN SLIDES.

The readiest way of setting forth lantern slides would be to catalogue everything procurable, whether good, bad or indifferent, and then to shirk responsibility by saying, "you pays your money and you takes your choice." But it seems particularly hard to pay the price of a colored picture without its bringing something nice to show for it; and so the following lists are very carefully sifted and arranged, with a view of helping purchasers to make satisfactory selections.

The concession in terms made in colored sealed slides consists, not in bringing the price down, but in bringing the quality up. If we have colored slides at all, we want them as effective as may be.

The price—\$2.50—remains the same as in former editions, where the common three-inch slides only were meant.

#### Class I. Choice Selected Slides.

PER SLIDE, \$2.50.

- |                             |                                       |
|-----------------------------|---------------------------------------|
| 1 Christmas Tree.           | 18 Nothing Venture—Nothing Have.      |
| 2 Wizard's Glen.            | 19 Forester's Family.                 |
| 3 Magic Grotto.             | 20 Love at First Sight (comic).       |
| 4 Cinderella.               | 21 The Bear Hunt.                     |
| 5 Youthful Darwin (comic).  | 22 Steamboat Race on the Mississippi. |
| 6 Song of the Nightingale.  | 23 Hide and Seek.                     |
| 7 Alpine Cottage—Moonlight. | 24 Babes in the Woods.                |
| 8 Sunday in the Backwoods   | 25 Coming Through the Rye.            |
| 9 In the Pasture.           | 26 Temperance Horses.                 |
| 10 Donkey Race (comic).     | 27 Pride and Humility.                |
| 11 Little Red Riding Hood.  | 28 Bargaining for a Horse.            |
| 12 Unconscious Sleeper.     | 29 Knitting Lesson.                   |
| 13 Great Expectations.      | 30 May Pole.                          |
| 14 Pleasures of Childhood.  | 31 Sea Bathing.                       |
| 15 Eagle and Shield.        | 32 The Little Fisherman               |
| 16 Monarch of the Glen.     |                                       |
| 17 The Soap Bubbles.        |                                       |

- 33 The Bird's Funeral.  
 34 Mud Pies.  
 35 Stream of Life.  
 36 Young Companions.  
 37 Little Foxes.  
 38 The Croquet.  
 39 Blue Bird.  
 40 Peasants Crossing the Stream.  
 41 The Bath.  
 42 Madonna in the Chair.  
 43 Washington Crossing the Delaware.  
 44 Washington at Trenton.  
 45 Washington and Lafayette at Mount Vernon.  
 46 The Spirit of '76.  
 47 Old Abe (Wis. War Eagle).  
 48 The Blind Piper.  
 49 The Mother's Blessing.  
 50 Both Puzzled.  
 51 Burns and his Highland Mary.  
 52 Rock of Ages.  
 53 Open Bible, Ps. xix.  
 54 Happy as a King.  
 55 Hunting the Walrus.  
 56 Icebergs—Life Boat Cove.  
 57 Piper and a Pair of Nut-crackers.  
 58 Landing of Columbus.  
 59 Apartment in a Mandarin's House.  
 60 Lobster Sauce.  
 61 A Pretty Kettle of Fish.  
 62 On the Lake.  
 63 On the Glacier.  
 64 Little Mischief.  
 65 Toilet.  
 66 Chimney Sweep.  
 67 Washing Day.  
 68 Fondly Gazing.  
 69 Empty Cradle.  
 70 Mater Dolorosa.  
 71 Ecce Homo.  
 72 Jerusalem in her Grandeur.  
 73 Jerusalem in her Fall—Selou's.  
 74 Cornelia and her Jewels.  
 75 Roman Ladies' Liberality.  
 76 Cattle at Watering Place.  
 77 Sheep in Pasture.  
 78 War.  
 79 Peace.  
 80 The Onconvaniance of Single Life.  
 81 The Raal Convaniance of Married Life.  
 82 Feeding the Ducks.  
 83 The Good Friends.  
 84 To the Rescue.  
 85 Saved.
- 86 The Challenge.  
 87 The Sanctuary.  
 88 The Mother's Joy.  
 89 The Widow's Comfort.  
 90 View on the St. Lawrence.  
 91 New England in Winter.  
 92 Highlands on the Hudson.  
 93 Settler's Hut on the Frontier.  
 94 Saw Mill, Lake Winnipissogee.  
 95 Mirror, Lake Yosemite.  
 96 Windsor Castle.  
 97 Balmoral Castle.  
 98 Burns' Mausoleum.  
 99 Innisfallen, Lake of Killarney.  
 100 Lower and Toic Lake do  
 101 Ballyhinch Lake.  
 102 Clew Bay, Ireland.  
 103 Glengariff Inn, Ireland.  
 104 Holy Cross Abbey, Ireland.  
 105 Cove Harbor, Queenstown.  
 106 City of Venice.  
 107 Cathedral and Leaning Tower Pisa.  
 108 Amalfi, Port of Salerno.  
 109 Bay of Naples—Eruption of Vesuvius.  
 110 Bingen, on the Rhine.  
 111 City of Cologne, on the Rhine.  
 112 St. Goar, on the Rhine.  
 113 Castle Reinstein.  
 114 Mill in the Alps—Winter.  
 115 Lake Como.  
 116 Lake Gmunden.  
 117 New Palace of the Sultan.  
 118 Court of St. Sophia.  
 119 Entrance to the Black Sea.  
 120 Seven Star Mountains, China.  
 121 Yellow Pagoda Fort, China.  
 122 Temple of Buddha.  
 123 Street in Canton.  
 124 Great Wall, China.  
 125 Ascent of the Himalayas.  
 126 Great Temple Baalbec (Interior).  
 127 Church of the Holy Sepulchre, Jerusalem.  
 128 Ferry at Old Cairo, Egypt.  
 129 Pyramids and Sphynx.  
 130 Island of Philae.  
 131 Hall of Columns, Karnak.
- EFFECT SLIDES FOR ONE LANTERN.
- 132 Washington's Dream.  
 133 Highlander's Dream.  
 134 American Soldier's Dream.  
 135 Mother's Dream.  
 136 Wife's Prayer.  
 137 Dream of Hope.  
 138 Believer's Vision.  
 139 Angel of Peace.  
 140 Good Night, in Wreath of Flowers.

(For effects for two lanterns, see Dissolving Views, p. 23.)



## Class II. Sacred History.

OLD TESTAMENT.—PER SLIDE, \$2.50.

- |  |   |
|--|---|
| <p>1 Adam and Eve in Paradise.<br/>         2 The Temptation.<br/>         3 The First Human Family.<br/>         4 Death of Abel.<br/>         5 Cain Builds the First City.<br/>         6 Three Tribes Descend from Cain.<br/>         7 The Deluge.<br/>         8 Noah's Sacrifice.<br/>         9 Tower of Babel.<br/>         10 Abraham and the Three Angels<br/>         11 Hagar's Departure.<br/>         12 Hagar in the Wilderness.<br/>         13 Abraham's Sacrifice.<br/>         14 Abraham Buries Sarah.<br/>         15 The Flight of Lot.<br/>         16 Rebekah at the Well.<br/>         17 Eliezar in the House of Bethuel.<br/>         18 Arrival of Rebekah.<br/>         19 Isaac Blesses Jacob.<br/>         20 Jacob's Dream.<br/>         21 Jacob in the House of Laban.<br/>         22 Joseph Thrown into the Well.<br/>         23 Joseph Sold to the Midianites.<br/>         24 Joseph's Bloody Coat Shown.<br/>         25 Joseph Interprets Pharaoh's Dream.<br/>         26 Joseph Makes Himself Known.<br/>         27 Joseph Meets His Father in Goshen.<br/>         28 Joseph Presents his Father to Pharaoh.<br/>         29 Jacob Blesses the Sons of Joseph.<br/>         30 Jacob Blesses his Twelve Sons.<br/>         31 Moses Exposed.<br/>         32 Moses Saved.<br/>         33 The Burning Bush.<br/>         34 Pharaoh Entreats Moses.<br/>         35 The Exodus from Egypt.<br/>         36 Pharaoh and his Host Drowned.<br/>         37 The Song of Miriam.</p> | <p>38 Gathering Manna.<br/>         39 Moses Smiting the Rock.<br/>         40 The Brazen Serpent.<br/>         41 The Golden Calf.<br/>         42 Moses Receiving the Tablets.<br/>         43 Moses Descends from Sinai.<br/>         44 Falling Walls of Jericho.<br/>         45 Jephthah's Daughter Meeting her Father.<br/>         46 Sacrifice of Jephthah's Daughter.<br/>         47 Samson and Delilah.<br/>         48 Samson Destroying the Temple.<br/>         49 Naomi and Ruth.<br/>         50 Boaz and Ruth.<br/>         51 Samuel and Eli.<br/>         52 Saul and the Witch of Endor.<br/>         53 David Slaying the Lion.<br/>         54 David Slaying Goliath.<br/>         55 David Returns Conqueror of Goliath.<br/>         56 David in Saul's Camp.<br/>         57 David Bringing the Ark.<br/>         58 Nathan's Parable.<br/>         59 Absalom Entangled in the Oak.<br/>         60 Solomon's Reception of the Queen of Sheba.<br/>         61 Judgment of Solomon.<br/>         62 The Widow's Oil.<br/>         63 Ascent of Elijah.<br/>         64 Children in the Flery Furnace.<br/>         65 Captives in Babylon.<br/>         66 Daniel in the Lion's Den.<br/>         67 Feast of Belshazzar.<br/>         68 Espousal of Esther by Ahasuerus.<br/>         69 Esther Confounds Haman.<br/>         70 Jonah Exhorts the Ninevites.<br/>         71 Jonah Cast into the Sea.<br/>         72 Jeremiah on the Ruins of Jerusalem.</p> |
|--|---|

### NEW TESTAMENT ILLUSTRATIONS.

- |  |  |
|--|--|
| <p>73 The Annunciation.<br/>         74 Naming of John the Baptist.<br/>         75 The Birth of Christ.<br/>         76 Birth of Christ Announced to the Shepherds.<br/>         77 The Star of Bethlehem.<br/>         78 The Adoration of the Magi.<br/>         79 Presentation in the Temple.<br/>         80 Flight into Egypt.<br/>         81 Slaughter of the Innocents.<br/>         82 Christ Disputing with the Doctors.<br/>         83 John Preaching in the Wilderness.<br/>         84 Baptism of Christ.<br/>         85 Calling of Matthew.<br/>         86 The Wedding at Cana.<br/>         87 Christ and the Samaritan Woman.</p> | <p>88 Christ Preaching on the Sea of Galilee.<br/>         89 Christ Healing the Sick.<br/>         90 The Sermon on the Mount.<br/>         91 Christ Stilling the Storm.<br/>         92 Resurrection of the Daughter of Jairus.<br/>         93 Christ Walking on the Water.<br/>         94 The Transfiguration.<br/>         95 The Good Samaritan.<br/>         96 The Parable of the Lost Sheep.<br/>         97 Parable of the Rich Young Man.<br/>         98 Miracle of the Loaves and Fishes.<br/>         99 Lilies of the Field.<br/>         100 Christ Healeth the Blind.<br/>         101 The Ten Virgins.<br/>         102 The Door was Shut.</p> |
|--|--|

- |  |   |
|--|---|
| 103 The Unmerciful Servant.                  | 124 Washing the Disciples' Feet.                  |
| 104 The Prodigal Son.                        | 125 Judas' Kiss.                                  |
| 105 The Prodigal Son—Dubufe.                 | 126 Jesus in the Garden of Gethsemane.            |
| 106 As a Swineherd.                          | 127 Jesus Before Pilate.                          |
| 107 His Return.                              | 128 Peter's Denial.                               |
| 108 Laborers in the Vineyard.                | 129 Christ Crowned with Thorns.                   |
| 109 The Wicked Husbandmen.                   | 130 Christ Rejected.                              |
| 110 "Neither do I Condemn Thee."             | 131 Christ Bearing His Cross.                     |
| 111 Lazarus at the Gate.                     | 132 The Crucifixion.                              |
| 112 Pharisee and Publican.                   | 133 Descent from the Cross.                       |
| 113 Christ Blessing Little Children.         | 134 Burial of Christ.                             |
| 114 The Sick of the Palsy Cured.             | 135 The Three Marys at the Sepulchre.             |
| 115 Jesus in the House of Mary and Martha.   | 136 Easter Morning—Christ Appears to Mary.        |
| 116 Resurrection of Lazarus.                 | 137 Christ and the Disciples at Emmaus.           |
| 117 Christ Entering Jerusalem.               | 138 Doubting Thomas.                              |
| 118 Mary Anointing Jesus' Feet.              | 139 Ascension.                                    |
| 119 Christ Clearing the Temple.              | 140 The Pentecost.                                |
| 120 The Tribute Money.                       | 141 St. John's Vision of the Celestial Jerusalem. |
| 121 The Poor Widow's Two Mites.              |   |
| 122 Predicting the Destruction of Jerusalem. |   |
| 123 The Last Supper.                         |   |

## LIFE AND TRAVELS OF ST. PAUL.

- |                                     |                         |
|-------------------------------------|-------------------------|
| 142 Martyrdom of Stephen.           | 157 Thessalonica.       |
| 143 Conversion of Saul.             | 158 Athens.             |
| 144 Paul at Athens.                 | 159 Piræus Athens.      |
| 145 Paul at Ephesus.                | 160 Corinth.            |
| 146 Paul at Malta.                  | 161 Ephesus.            |
| 147 Tarsus, the Birthplace of Paul. | 162 Miletus.            |
| 148 River Cydnus.                   | 163 Rhodes.             |
| 149 Jerusalem.                      | 164 Ptolemais.          |
| 150 Damascus.                       | 165 Cæsarea.            |
| 151 Nablous.                        | 166 Syracuse.           |
| 152 Antioch.                        | 167 Straits of Messina. |
| 153 Cyprus.                         | 168 Puteoli.            |
| 154 Antioch in Pisidia.             | 169 Rome.               |
| 155 Alexandria Troas.               | 170 Map of Travels.     |
| 156 Philippl.                       |                         |

## Class III. Holy Land and Egypt.

PER SLIDE, \$2.50.

- |  |  |
|--|--|
| 1 Jerusalem from the Mount of Olives.    | 18 Pool at Hebron.                       |
| 2 Enclosure of the Temple Area.          | 19 Pool at Siloam.                       |
| 3 Mosque of Omar.                        | 20 Pool of Hezekiah.                     |
| 4 Mount Zion, from Hill of Evil Council. | 21 Solomon's Pool, near Bethlehem.       |
| 5 Mount of Olives, from the Wall.        | 22 Well and Remains of Pool at Bethel.   |
| 6 Tower of Hippicus.                     | 23 Well near Emmaus.                     |
| 7 Church of the Holy Sepulchre.          | 24 Well of the Virgin.                   |
| 8 Jews' Place of Wailing.                | 25 Lake of Tiberias, from Castle Saphet. |
| 9 Arch in Via Dolorosa.                  | 26 Baths and City of Tiberias.           |
| 10 The Golden Gate.                      | 27 Nazareth toward Esdraelon.            |
| 11 Garden of Gethsemane.                 | 28 Vale of Nazareth.                     |
| 12 Bethlehem.                            | 29 Well of Nazareth.                     |
| 13 Etham, near Bethlehem.                | 30 Ramleh, with the Hills of Judea.      |
| 14 Fields of Bethany.                    | 31 Sidon and Mount Lebanon.              |
| 15 Hebron.                               | 32 Hills of Samaria.                     |
| 16 Harem at Hebron.                      |  |
| 17 Ancient Masonry near Hebron.          |  |

- 33 Mount Hermon.
- 34 Mount Carmel.
- 35 Mount Tabor.
- 36 Plain Er Raheb, Mt. Sinai.
- 37 Mount Hor.
- 38 Mount Nebo.
- 39 The Rock of Moses.
- 40 Mount Ararat.
- 41 Sarepta.
- 42 Rachel's Tomb.
- 43 Tombs in the Valley of Jehoshaphat.
- 44 Tomb of the Virgin.
- 45 Halt above the North End of the Dead Sea.
- 46 Damascus.
- 47 Scene near Ramleh.
- 48 Arab of the Desert.
- 49 Arab Camp.
- 50 Interior of a Caravansera.
- 51 Range of the Tombs, Petra.
- 52 Cæsarea.
- 53 Fords of the Jordan.
- 54 Tarsus.
- 55 Falls of the Cydnus.
- 56 Map of Palestine.
- 57 Theatre at Ephesus.

- 58 Ruins of Persepolis.
- 59 Ruins of Babylon.
- 60 Ruins of Balbec.

## EGYPT.

- 61 Ferry at Old Cairo.
- 62 Street in Cairo.
- 63 The Shadoof.
- 64 Nile Boat.
- 65 Pyramids and Sphinx.
- 66 The Sinoon.
- 67 Approach to Karnac.
- 68 Karnac.
- 69 Columns of Grand Hall, Karnac.
- 70 Colossi of the Plains.
- 71 Obelisk and Propylon Luxor.
- 72 Colossal Statue of Rameses the Great, at the Memnonium.
- 73 Approach to Philoe.
- 74 View from Philoe.
- 75 Sculptured Gateway, Philoe.
- 76 Pharaoh's Bed, Philoe.
- 77 Portico of Tem. Kalabshe, Nubia.
- 78 Tombs of Memlook Kings, Cairo.
- 79 Pylon of the Temple of Edfou.
- 80 Monument of Heliopolis.

## Class IV—Ancient Greece and Rome.

PER SLIDE, \$2.50.

## ANCIENT GREECE.

- 1 Plan of Athens.
- 2 Ancient Athens restored.
- 3 Ruins of Athens.
- 4 The Pyræus.
- 5 Mars Hill.
- 6 The Philosopher's Garden.
- 7 Ruins of the Parthenon.
- 8 The Parthenon restored.
- 9 Temple of Jupiter, at Olympia.
- 10 Oracle at Delphi.
- 11 Sacrifice to Neptune.
- 12 Sacrifice to Mars.
- 13 Statue of Pallas Athenæ.
- 14 Olympian Games.
- 15 Grecian Warriors.
- 16 Grecian Chariot.
- 17 Grecian Dwelling (interior).
- 18 Grecian Ceremony before Marriage.
- 19 The Areopagus.
- 20 The Assembly of the Gods.

## ANCIENT ROME.

- 21 Map of Rome.
- 22 Ruins of Rome.
- 23 Trajan's Arch.
- 24 Roman Cavalry.
- 25 War Elephant.
- 26 War Engines.
- 27 Victorious General thanking his Army.
- 28 Prisoners passing under the Yoke.
- 29 Roman Triumph.
- 30 Captives in the Forum.
- 31 Gladiators at the Theatre.
- 32 Gladiators at Funerals.
- 33 Sea Fight.
- 34 Roman Feast.
- 35 The Coliseum.
- 36 Section of Coliseum.
- 37 Wild Beasts and Victims in the Coliseum.
- 38 Sacrifice in Rome.
- 39 Temple of the Sun in Rome.
- 40 Funeral of an Emperor.

## Class V—Complete Illustrations to the Text of the Holy Bible.

PER SLIDE, \$1.50.

### BIBLICAL ANTIQUITIES.

#### EGYPTIAN.

- 1 Ancient Cymbals, &c.
- 2 Ancient Egyptian Armlets.
- 3 Ancient Egyptian Doors.
- 4 Ancient Egyptian Scales.
- 5 Ancient Egyptian Seats.
- 6 Body of Archers.
- 7 Bowing before a Public Officer.
- 8 Brickmaking.
- 9 Carrying Corn.
- 10 Chairs.
- 11 Couches.
- 12 Culinary Vessels.
- 13 Dandour.
- 14 Denderah.
- 15 Drawers and Girdle.
- 16 Earrings of Men.
- 17 Edfou.
- 18 Egyptian Amulets.
- 19 Egyptian Entertainment.
- 20 Egyptian Instrument.
- 21 Egyptian King on his Throne.
- 22 Egyptian Lady.
- 23 Egyptian Lamps.
- 24 Egyptian Vessels of Elegant Form.
- 25 Egyptian with a Tray of Meats.
- 26 Ephod and Censer.
- 27 Ephod and Girdle.
- 28 Ethiopian Car drawn by Oxen.
- 29 Fauteuils.
- 30 Harp.
- 31 Luxor.
- 32 Man-servant.
- 33 Metal Door-pins.
- 34 Mitres.
- 35 Mummy.
- 36 Mummy Case and Marble Sarcophagi.
- 37 Overseer of Cattle.
- 38 Priestesses.
- 39 Ring Money.
- 40 Rock-cut Temple, Ipsambul.
- 41 Scarabæi—Back and Side Views.
- 42 Scarabæi—Engraved under-surfaces.

- 43 Scribe.
- 44 Ship.
- 45 Side View of Memnon.
- 46 Signet Rings of Ancient Egypt.
- 47 Sistrums.
- 48 Sphinx and Pyramids.
- 49 Statue of Egyptian Lady.
- 50 Stewards.
- 51 Stringed Instruments.
- 52 Tambourine Players.
- 53 Theban Statue.
- 54 Thrones.
- 55 Water Bearers.
- 56 Windows.
- 57 Wine-press.
- 58 Worker in Iron.

#### JEWISH.

- 59 Altar of Burnt Offering.
- 60 Altar of Incense.
- 61 Booths.
- 62 Burnt Offering.
- 63 Costume of High Priest.
- 64 Costume of a Priest.
- 65 Meat Offering.
- 66 Ox-horn Blower.
- 67 Peace Offering.
- 68 Priests Sounding an Alarm.
- 69 Setting up the Tabernacle.
- 70 Sin Offering.
- 71 Solomon's Throne.
- 72 Supposed Form of the Laver.
- 73 Table of Shew-Bread.
- 74 The Golden Candlestick.
- 75 The Princes' Offering.
- 76 Trespass Offering of the Poor.
- 77 Alabaster Boxes.
- 78 Alexander the Great.
- 79 Ancient Battering Ram.
- 80 Ancient Shadoof.
- 81 A Phœnician Sarcophagus.
- 82 Ark borne by Priests.
- 83 Balista prepared for the Discharge of a Stone.
- 84 Bas-relief from the Arch of Titus.
- 85 Captive Jews.

- 86 Catapulta prepared for the Discharge of an Arrow.  
 87 Censers.  
 88 Chamber on the Wall.  
 89 Coin of Agrippa (Copper).  
 90 Coin of Archelaus (Copper).  
 91 Coin of Augustus.  
 92 Coin of Claudius.  
 93 Coin of Nero.  
 94 Coin of Tiberius.  
 95 Coin of Titus.  
 96 Cuirass.  
 97 Daggers.  
 98 Demi-Shekel (Copper).  
 99 Double Flutes, Greek.  
 100 Eastern Tables.  
 101 Eastern Writing Material.  
 102 Escape from a Window.  
 103 Garden Bedstead.  
 104 Garden House.  
 105 Gods of Wood.  
 106 Group of Altars.  
 107 Helmets.  
 108 Insignia of Office.  
 109 Interior of the Portico of the Great Temple of Denderah.  
 110 Judæa Capta.  
 111 King on Throne, with Attendants.  
 112 Metal Mirrors.  
 113 Nimrod.  
 114 Nisroch.  
 115 Palm Bedstead.  
 116 Persian Armlets.  
 117 Persian Torch and Lantern.  
 118 Pillows of Stone and Wood.  
 119 Quarter-Shekel (Copper).  
 120 Roman Judgment-Seat.  
 121 Roman Lantern and Flambeaux.  
 122 Sandals.  
 123 Shekel of Copper.  
 124 Shekel of Silver.  
 125 Ship, from a Painting at Pompeii.  
 126 Shrine with Idol.  
 127 Spoons.  
 128 Statue of Cyrus.  
 129 Sun Dial.  
 130 Teraphim.  
 131 The Ckumarah.  
 132 The Great King.  
 133 Tower in the Desert.  
 134 Winged Human-headed Bull.  
 135 Writing Materials.
- MANNERS AND CUSTOMS.
- 136 A Musical Procession.  
 137 An Oriental Migration.  
 138 Application to a Santon.  
 139 Arab Encampment.  
 140 Arab Female.  
 141 Arab Horde coming to a Halt.  
 142 Bargaining for a Slave.  
 143 Caravansera.  
 144 City Gate.  
 145 Cup Bearers.  
 146 Dance with Timbrels.  
 147 Drawing Water from the Nile.  
 148 Eastern Forms of Obeisance.  
 149 Eastern House.  
 150 Eastern Housetops.  
 151 Eastern Potter.  
 152 Eastern Prince.  
 153 Eastern Princess.  
 154 Egyptian Foot Soldiers.  
 155 Egyptian Soldiers.  
 156 Egyptian War Chariots.  
 157 Egyptian Worship.  
 158 Feast of Passover.  
 159 Feast of Tabernacles.  
 160 Female Mourners at Tomb.  
 161 Giving Water from Leathern Bottles.  
 162 Grecian Warrior in Armor.  
 163 Greek Worshipping with Head Uncovered.  
 164 Hand-mill.  
 165 Interior of the Tomb of the Kings at Jerusalem.  
 166 Jewish Physician.  
 167 Lady with Face-veil.  
 168 Marriage Procession of a Bride.  
 169 Marriage Procession of a Bridegroom.  
 170 Market at Gate.  
 171 Monumental Pillars.  
 172 Mourner at Tomb.  
 173 Musical Entertainment.  
 174 Oriental Cart.  
 175 Oriental Shepherds.  
 176 Ornaments of Egyptian Females.  
 177 Painted Eyes.  
 178 Potter at Work.  
 179 Pouring Wine from Leathern Bottle.  
 180 Praying with the Head Covered.  
 181 Raising Water.

- 182 Raising Water by the Ckutweh.  
 183 Reading the Law.  
 184 Rock-cut Tomb.  
 185 Roman Centurion.  
 186 Roman Consul.  
 187 Roman Eagle.  
 188 Roman Lictor.  
 189 Roman Soldiers.  
 190 Sackcloth.  
 191 Saddled Asses.  
 192 Searching for Leaven.  
 193 Shaving the Head.  
 194 Sheepfold.  
 195 Stones of Memorial.  
 196 The Taboot.  
 197 Threshing by Animals.  
 198 Threshing by the Drag.  
 199 Threshing by the Sledge.  
 200 Throwing a Javelin.  
 201 Walking Wrapper.  
 202 Warrior and Armor-Bearer.  
 203 Washing Hands.  
 204 Water Carriers.  
 205 Women of Priestly Families.  
 206 Women on Camels.  
 207 Women Wearing the Tob.

#### BIBLICAL SCENERY.

- 208 Absalom's Tomb.  
 209 Aceldama.  
 210 Adjeroud.  
 211 Alexandria.  
 212 Amphitheatre near Tiberias.  
 213 Anathoth.  
 214 Antioch.  
 215 Aqueduct of Jericho.  
 216 Arch of Titus, Rome.  
 217 Ascalon.  
 218 Ashdod.  
 219 Assyrian Grave Tower, Lebanon.  
 220 A View of Petra in Wady Mousa.  
 221 Baalbec.  
 222 Banias.  
 223 Bazaar in Damascus.  
 224 Bazaar in Jaffa.  
 225 Bethany.  
 226 Bethel.  
 227 Bethlehem.  
 228 Beyrout.  
 229 Birs Nimrod, Babylon.  
 230 Bringing First-fruits to Jerusalem.  
 231 Carmel.  
 232 Castle of Sion.  
 233 Cave at Benias.  
 234 Caves in the Cliffs of Wady Mousa, Mount Seir.  
 235 Cave under the Temple Hill.  
 236 Cedars of Lebanon.  
 237 Chapel of the Burning Bush.  
 238 Church of the Holy Sepulchre, Jerusalem.  
 239 Church of the Nativity.  
 240 Church Ruin at El'Bire.  
 241 Citadel on Site of Ft. Antonio.  
 242 Colosse.  
 243 Corinth.  
 244 Damascus.  
 245 Daniel's Grave at Susa.  
 246 Egyptian Monuments.  
 247 Egyptian Temple.  
 248 Elath.  
 249 Elias's Grotto on Mt. Carmel.  
 250 Emmaus.  
 251 Garden of Gethsemane.  
 252 Gaza.  
 253 Gibeon.  
 254 Gibeon.  
 255 Graveyard in Sidon.  
 256 Grave of Joseph of Arimathea.  
 257 Harvest in Palestine.  
 258 Hebron, with the Grave of Machpelah.  
 259 Hermon, from Meromsee.  
 260 Interior of Coliseum, Rome.  
 261 Interior of Convent, Mar Saba.  
 262 Interior of the Holy Sepulchre.  
 263 Isaiah's Grave.  
 264 Jacob's Bridge.  
 265 Jaffa.  
 266 Jaffa Gate, Jerusalem.  
 267 Jerusalem, from Scopus.  
 268 Jerusalem from the North.  
 269 Jews' Place of Wailing, Jerusalem.  
 270 Jews' Quarter, Jerusalem.  
 271 Jezreel.  
 272 Joseph's Grave.  
 273 Kaipha.  
 274 Kirjath-jearim.  
 275 Lake of Gennesaret.  
 276 Laodicea.  
 277 Lydda.  
 278 Magdala.  
 279 Malta.  
 280 Mars' Hill, Athens.

- 281 Mosque of Omar, Jerusalem.  
 282 Mount Ararat.  
 283 Mount Hor.  
 284 Mount of Olives from Jerusalem.  
 285 Mounts Ebal and Gerizim.  
 286 Mount Serbal.  
 287 Mount Tabor.  
 288 Nablous, the Ancient Shechem.  
 289 Nain.  
 290 Nazareth.  
 291 Nineveh.  
 292 Noah's Grave in Armenia.  
 293 Noph.  
 294 Old Jewish Tower.  
 295 On, or Heliopolis.  
 296 Patmos.  
 297 Pergamos.  
 298 Pharaoh's Palace.  
 299 Philadelphia.  
 300 Philip's Well.  
 301 Pilgrim's Pool, Succoth.  
 302 Plain of Jericho.  
 303 Pool of Bethesda.  
 304 Pool of Gihon.  
 305 Pool of Hezekiah.  
 306 Pool of Siloam.  
 307 Pools of Solomon.  
 308 Ptolemais.  
 309 Rachel's Grave.  
 310 Rama (Arimathea).  
 311 Remains of Ancient Temple Bridge.  
 312 Rhodes.  
 313 River Jobbok.  
 314 Rock of Moses.  
 315 Rock Valley in the Vicinity of Petra.  
 316 Roman Bridge, Lysanias.  
 317 Rome.  
 318 Ruins of Ammon.  
 319 Ruins of Cæsarea in Palestine.  
 320 Ruins of Gadara.  
 321 Ruins of the Forum at Rome.  
 322 Ruins of the Palace of Nero, Rome.  
 323 Ruins of Tyre.  
 324 Safed.  
 325 Samaria, Sebaste.  
 326 Samaritan Synagogue.  
 327 Sardis.  
 328 Sarepta.  
 329 Shiloh.  
 330 Sidon.  
 331 Smyrna.  
 332 St. John's Hospital, Acre.  
 333 St. Peter's, Rome.  
 334 Suez.  
 335 Summit of Mount Sinai.  
 336 Tadmor, Palmyra.  
 337 Tarsus.  
 338 Terrace Cultivation.  
 339 The Coliseum, Rome.  
 340 The Dead Sea.  
 341 The Grave of David.  
 342 The Holy Sepulchre.  
 343 The Jordan leaving the Lake of Tiberias.  
 344 The Mamertine Prison, Rome.  
 345 The Mujelibe, Babylon.  
 346 The River Jordan.  
 347 The Written Rocks, Wady Mokatteb.  
 348 Thyatira.  
 349 Tiberias.  
 350 Tomb at Petra.  
 351 Tomb of Ezra.  
 352 Tomb of Mordecai.  
 353 Tomb of the Kings.  
 354 Tower of David, Jerusalem.  
 355 Tower of St. Paul in Damascus.  
 356 Tyre.  
 357 Urfah, supposed Ur of the Chaldees.  
 358 Valley and Convent of Sinal.  
 359 Valley of Gihon.  
 360 Valley of Jehoshaphat.  
 361 Vaults beneath Solomon's Temple.  
 362 Vestibule within the Golden Gate.  
 363 Vivia Dolorosa.  
 364 View in the Land of Moab.  
 365 View of a Portion of the Ruins of Petra.  
 366 View on the Euphrates.  
 367 View on the Nile.  
 368 Watered Garden.  
 369 Well at Cana.  
 370 Well of the Virgin.  
 371 Wells of Moses

## BIBLICAL NATURAL HISTORY.

### BEASTS.

- 372 Asses  
 373 Bat.  
 374 Bear.  
 375 Beaver.

- 376 Camels.  
 377 Chameleon.  
 378 Common Dormouse.  
 379 Coneys.  
 380 Dark-banded Jerboa.  
 381 Dogs.  
 382 Dromedary.  
 383 Egyptian Fox.  
 384 Elephant.  
 385 Four-horned Ram.  
 386 Gazelles.  
 387 Greyhound.  
 388 Hippopotamus.  
 389 Jackals.  
 390 Lion.  
 391 Lioness and Whelps  
 392 Onyx.  
 393 Sheep.  
 394 Syrian Leopard.  
 395 Syrian Ox, Camel, and Ass.  
 396 Wild Ass.  
 397 Wolf.

## BIRDS.

- 398 Bee-eater.  
 399 Collared Turtle.  
 400 Cormorant.  
 401 Hawk.  
 402 Heron.  
 403 Hoopoe.  
 404 Ibis.  
 405 Osprey.  
 406 Owl.  
 407 Partridge.  
 408 Pelican.  
 409 Quail.  
 410 Sea Swallow.  
 411 Shoveller.  
 412 Stork.  
 413 Swallow of Palestine.  
 414 Syrian Dove.  
 415 The Aquiline Vulture.  
 416 The Crane.  
 417 The Eagle.  
 418 The Flamingo.  
 419 The Katta.  
 420 The Ostrich.

## REPTILES AND INSECTS.

- 421 Crocodile.  
 422 Egyptian Frogs.  
 423 Emperor Boa.

- 424 Hornet.  
 425 Lacerta Gecko.  
 426 Lacerta Sincus.  
 427 Lacerta Stellio.  
 428 Locust.  
 429 Scorpion.

## TREES AND PLANTS.

- 430 Almond Tree.  
 431 Apples of Sodom.  
 432 Balm of Gilead.  
 433 Bitter Cucumber.  
 434 Black Fig Tree.  
 435 Box Tree.  
 436 Cactus.  
 437 Carob.  
 438 Cinnamon.  
 439 Cluster of Dates.  
 440 Cone of the Pine.  
 441 Coriander.  
 442 Cypress.  
 443 Darnel.  
 444 Date Palm.  
 445 Dourra.  
 446 Ears of Wheat.  
 447 Figs.  
 448 Fig Leaves.  
 449 Fitches.  
 450 Frankincense.  
 451 Gopher Tree.  
 452 Gourd.  
 453 Grapes.  
 454 Henna Plant.  
 455 Holy Bramble.  
 456 Husks.  
 457 Hyssop.  
 458 Jasmine.  
 459 Jonah's Gourd.  
 460 Juniper.  
 461 Lentiles.  
 462 Lily.  
 463 Mandrakes.  
 464 Mustard.  
 465 Nuts.  
 466 Oleander.  
 467 Olive Branch with Fruit.  
 468 Olive Tree.  
 469 Orange Tree.  
 470 Palm Tree.  
 471 Plane Tree.  
 472 Pomegranate.  
 473 Prickly Oak.  
 474 Reeds.



- 475 Rice.  
 476 Rose of Jericho.  
 477 Rose of Sharon.  
 478 Sea-goose Foot.  
 479 Sesamum Oriental.  
 480 Stone Pine Tree.  
 481 Strawberry Tree.  
 482 Sycamore.  
 483 Sycamore Figs.  
 484 Tamarisk Tree.  
 485 Terebinth.  
 486 Thorn.  
 487 White Mulberry Tree.  
 488 Wormwood.

## MAPS, &amp;c.

- 489 Canaan in possession of the Twelve Tribes.  
 490 Geography of the Hebrews.  
 491 Journeys of the Children of Israel.  
 492 Plan of Jerusalem, Ancient.  
 493 Plan of Jerusalem, Modern.  
 494 Palestine, to illustrate the New Testament.  
 495 Travels of St. Paul in Asia and Europe.

## Class VI—Views of Interest in different parts of the World.

PER SLIDE, \$2.50.

## ENGLAND.

- 1 The New House of Parliament, London.  
 2 Windsor Castle.  
 3 The Horse Guards.  
 4 Greenwich Hospital.

## SCOTLAND.

- 5 Interior of Holyrood Chapel.  
 6 Melrose Abbey.  
 7 Balmoral Castle.  
 8 Fountain's Abbey.

## IRELAND.

- 9 Askeaton Abbey.  
 10 Adare " "  
 11 Furness " "  
 12 Muckcross " "  
 13 Castle and Town of Glenarm.  
 14 The Custom House at Limerick.  
 15 Thodmongate Bridge, "  
 16 The Coleraine Salmon Lake.  
 17 Dunluce Castle, County Antrim.  
 18 View of Londonderry.  
 19 Walker's Monument, Londonderry.  
 20 The Green Linen Market, Belfast.  
 21 High Street, "  
 22 Black Rock Castle, County Cork.  
 23 Statue of George II, "  
 24 Cove Harbor, "  
 25 Cork River.

- 26 Merchant Quay, Cork.  
 27 Blarney Castle.  
 28 Trinity College, Dublin.  
 29 College Street, "  
 30 Parliament Square, "  
 31 The King's Bridge, "  
 32 St. Peter's Chapel, "  
 33 The Four Courts, "  
 34 The Bank of Ireland.  
 35 Court-Yard, Dublin Castle.  
 36 Castle Kilkenny, County Dublin.  
 37 Belfry and Church of Swords, near Dublin.  
 38 Dunmore Pier, Waterford.  
 39 Lismore Castle, "  
 40 Inchmore Castle, Co. Kilkenny.  
 41 Kilkenny Castle.  
 42 The Old Abbey at Sligo.  
 43 The Boyne Water.  
 44 The Upper Lake of Killarney.  
 45 The Lower Lake of Killarney.  
 46 Innisfallen.  
 47 Queenstown Harbor.  
 48 Carrig Fergus Castle.  
 49 The Seven Churches of Clonmance.  
 50 Abbey of the Holy Cross, Tipperary.  
 51 Ballanahinels.  
 52 Enchanted Isles.  
 53 Giant's Causeway.  
 54 Cave at Giant's Causeway.  
 55 Fingal's Cave.

## FRANCE.

- 56 Cathedral of Amiens.  
 57 Abbeville Cathedral.  
 58 Castle of Ambrose.  
 59 Cathedral of St. Bovon.  
 60 View of Rouen.  
 61 Palace of Justice, Rouen.  
 62 Cathedral of Rouen.  
 63 Chapel of Vincennes, Lyons.  
 64 Strasbourg Cathedral.  
 65 Market Place, Liege.  
 66 The Exchange, Paris.  
 67 Théâtre de l'Opera Comique,  
 Paris.  
 68 Dôme des Invalides, Paris.  
 69 The Pantheon, "  
 70 Hotel de Ville, "  
 71 Flower and Shrub Market, Paris.  
 72 The Elysian Fields, "  
 73 Val de Grace Church, "  
 74 Luxembourg Palace, "  
 75 Jardin Mabille, "  
 76 Cathedral of Notre Dame, "  
 77 Place de la Concorde, "  
 78 Arc de Triomphe de l'Etoile, "  
 79 Chateau des Fleurs, "  
 80 Monument in Père la Chaise, "  
 81 Perigneux Pyranees, "

## SPAIN.

- 82 Fountain at Madrid.

## BELGIUM.

- 83 Town Hall, Antwerp.  
 84 Town Hall, Bruges.  
 85 Church of St. Salvador, Bruges.  
 86 Cormayer, Valley of Aosta, Pied-  
 mont.

## ITALY.

- 87 Amalfi.  
 88 Arch of Trajan, Ancona.  
 89 View of Florence.  
 90 View of Naples.  
 91 Villa Royal, Naples.  
 92 Villa Doria, Genoa.  
 93 View of Palermo.  
 94 Palazzo Reali, Palermo.  
 95 Lake of Como.  
 96 Convent of St. Martino.  
 97 Lake of Lugano.  
 98 Leaning Tower of Pisa.  
 99 Grotto di Posilipo.

- 100 Milan Cathedral.  
 101 St. Peter's, Rome.  
 102 Interior of St. Peter's, Rome.  
 103 Castle of St. Angelo.  
 104 Tivoli Falls, near Rome.  
 105 Coliseum.  
 106 Arch of Trajan.  
 107 Porta Maggiore.  
 108 St. Mark's, Venice.  
 109 The Bucentaur.  
 110 Bridge of Sighs.  
 111 Scilla and Charybdis, Sicily.  
 112 Mt. Ætna.  
 113 Port of Messina.  
 114 Duomo of Syracuse.  
 115 Valetta, Island of Malta.  
 116 View of Prague, Bohemia.  
 117 Ruins of Donanstauf, on the  
 Danube.

## TURKEY.

- 118 The Sultan's Palace, Constanti-  
 nople.  
 119 Street Scene, Constantinople.

## GERMANY.

- 120 View of Mayence, on the Rhine.  
 121 Fortress of Konigstein, near  
 Dresden.  
 122 Courtyard at Heidelberg.  
 123 View of Freiburg.  
 124 Freiburg Cathedral.  
 125 Interior of Wartburg Chapel.  
 126 Baden-Baden.  
 127 Lake of Ploen.  
 128 The Falls of the Rhine.  
 129 Church of the Knights Templar,  
 Luz.  
 130 Castle Bronnen.

## SWITZERLAND AND TYROL.

- 131 Trent, Tyrol.  
 132 View of Thun, Switzerland.  
 133 Meiringen.  
 134 Mount St. Bernard.  
 135 Castle Klam on the Oberinn  
 River, Tyrol.  
 136 View on the Alps in Steiermark,  
 Moonlight Effect.  
 137 Winter View on the Alps, near  
 Meiringen.  
 138 The Lake of the Four Cantons,  
 Switzerland.

- 139 The Lake of Luzerne.  
 140 View in the Alps.  
 141 View on the River Gossou, in Tyrol.  
 142 View on the River Inn.  
 143 View near Inspruk, Tyrol.  
 144 View in the High Alps—Tyrolese Gems-Hunters.  
 145 The Fountain at Salzburg.  
 146 On the Konigs-Lake, Tyrol.  
 147 View near Berechtsgaden, Tyrol  
 148 View near the Martinswand, Tyrol—Winter.  
 149 View near Salzburg, Tyrol—Summer.  
 150 View of the Lake of Thun, Switzerland.  
 151 Entrance to Meran, Tyrol.  
 152 View near Salzburg, Tyrol.  
 153 View of a Tyrolese Cottage, near Salzburg.  
 154 View near Aussee, Tyrol.  
 155 Interior View of an Alpine Shanty in Tyrol.  
 156 The Lake of Brienz.  
 157 Graubunden Lake.  
 158 Lake of Interlaken, Tyrol.  
 159 Interior of an Alpine Cow-house.  
 160 Lake of Gmunden, Tyrol.  
 161 Cottage in the Alps, near Snow-cap Mountain.  
 162 View of the River Inn, Tyrolese Alps.  
 163 Castle of Wolfstein, in Tyrol.  
 164 Tyrolese Village in the Lowlands, Winter Scene.  
 165 Tyrolese Farmers at Work, unloading Hay.
- INDIA.
- 166 The Hill Fortress of Gwalioz.  
 167 The Residency, Lucknow.  
 168 Mosque Mounher, Hindostan.
- CHINA.
- A series of views from original sketches, by Thomas Allom, Esq.
- 169 Chinese Cemetery, near Peking.  
 170 Temple of Buddha, Canton.  
 171 Raree Show at Lin-sin-choo.  
 172 Feeding Silk Worms and sorting Cocoons.  
 173 Apartment in a Mandarin's House, near Nanking.  
 174 Chinese Cat Merchants.  
 175 Rice Merchants at the Military Station of Tong-chang-foo.  
 176 Canton Barge-men fighting Quails.  
 177 Destroying the Chrysalides and Reeling the Cocoons.  
 178 Dyeing and Winding Silk.  
 179 Playing at Shuttlecock with the Feet.  
 180 Chinese Sacrifice to the Harvest Moon.  
 181 An Itinerant Barber.  
 182 Chinese Opium Smokers.  
 183 Chinese Marriage Procession.  
 184 A Devotee consulting the Sticks of Fate.  
 185 Great Temple at Honan, Canton.  
 186 A Mandarin paying a visit of Ceremony.  
 187 Scene from the Spectacle "the Sun and Moon."  
 188 Porcelain Tower, Nanking.  
 189 Show Room of a Lantern Merchant at Peking.  
 190 Punishment of the Cangue, at Ting-hai.  
 191 A Street in Canton.  
 192 An Itinerant Doctor at Tien-sing.  
 193 Kite Flying at Hae-kwan.  
 194 Ceremony of meeting the Spring.  
 195 The Imperial Travelling Palace at Hoo-kew-shan.  
 196 The Bridge of Nanking.  
 197 West Gate of Ching Keang Foo.  
 198 A Tartar of the Chinese Army.  
 199 The Tiger Guard.  
 200 Policeman and Prisoner.  
 201 Punishment of the Bastinado.  
 202 Punishment of the Bamboo.  
 203 Chinese Punishment of the Rack  
 204 Street Punishment.  
 205 Chinese Barber.  
 206 Cleaning Cotton.  
 207 The Kin-shan or Golden Island.  
 208 The Rev. Robert Morrison and his assistants in the translation of the Bible into Chinese.

## AMERICA.

- |  |  |
|--|--|
| <p>209 Cape Horn.<br/>         210 The Dome, Yosemite Valley, Cal.<br/>         211 The Three Brothers, Yosemite Valley, California.<br/>         212 Cathedral Spires, Yosemite Valley, California.<br/>         213 The Vernal Falls, Yosemite Valley, California.<br/>         214 Bridal Veil Falls, Yosemite Valley, California.<br/>         215 Grizzly Giant Tree.<br/>         216. Pacific R. R. Track on the Rocky Mountains.<br/>         217 The Rio Grande, near Frontera.<br/>         218 Monument Mountains, Rocky Mountains.<br/>         219 The Organ Mountains, New Mexico.<br/>         220 Spanish Peaks, New Mexico.<br/>         221 Fort Laramie.<br/>         222 The Wind River Mountains.<br/>         223 Fort Smith, Arkansas.<br/>         224 Pend d'Oreille Mission, Rocky Mountains.<br/>         225 The Garden of the Gods, Rocky Mountains.<br/>         226 Fight with a Grizzly Bear in the Rocky Mountains.<br/>         227 Ball-play Dance of Camanche Indians.<br/>         228 Archery of Mandan Indians.<br/>         229 A Buffalo Hunt—Surround.<br/>         230 Camanche Indians at Ball-playing.<br/>         231 Buffalo Hunt—The Chase.</p> | <p>232 Three Camanche Indians—Ball-players.<br/>         233 Buffalo Hunt—the Near Chase.<br/>         234 Wild Horses at Play.<br/>         235 Antelope Shooting—the Ambuscade.<br/>         236 Encampment on the Plains during a "Norther."<br/>         237 The War Dance of Camanche Indians.<br/>         238 Encampment surprised by Indians.<br/>         239 White Wolves attacking a Buffalo Bull.<br/>         240 Catching the Wild Horse.<br/>         241 A Buffalo Chasing Back.<br/>         242 The Capitol, Washington, D. C.<br/>         243 The White House, " "<br/>         244 U. S. Treasury Building, Washington, D. C.<br/>         245 U. S. General Post Office.<br/>         246 U. S. Patent Office.<br/>         247 General View of Washington from the Capitol.<br/>         248 Washington's Tomb, Mt. Vernon, Va.<br/>         249 Washington's Residence, Mt. Vernon, Va.<br/>         250 View up Broadway from Herald Office.<br/>         251 West Point from Garrison's.<br/>         252 General View of Niagara Falls.<br/>         253 William Penn's Cottage, Letitia Court, Philadelphia, from old engravings.<br/>         254 Continental Hotel, Phila.<br/>         255 Independence Hall, "</p> |
|--|--|

### Class VII—Illustrations of Important Events in American History.

PER SLIDE, \$2.50.

- |  |  |
|--|--|
| <p>1 Landing of Columbus.<br/>         2 Marriage of Pocahontas.<br/>         3 Embarkation of the Pilgrim Fathers.<br/>         4 English Puritans Escaping to America.<br/>         5 Landing of the Pilgrims.<br/>         6 Landing of Hendrick Hudson.<br/>         7 Landing of Roger Williams.<br/>         8 Elliott, the first Indian Missionary.</p> | <p>9 William Penn Treating with the Indians.<br/>         10 Washington Raising the British Flag at Fort Duquesne.<br/>         11 Patrick Henry in the Virginia Assembly.<br/>         12 Washington, Henry, and Pendleton going to the first Congress.<br/>         13 First Prayer in Congress.<br/>         14 Surprise of Ticonderoga.<br/>         15 Washington leaving for the Army.</p> |
|--|--|

- |  |   |
|--|---|
| 16 Washington taking Command of the Army, 1775.                      | 47 John Q. Adams, 6th Pres. U. S.   |
| 17 Putnam leaving the Plough.  | 48 Andrew Jackson, 7th "  |
| 18 Battle of Bunker Hill, 1775.                                      | 49 Martin Van Buren, 8th "  |
| 19 Drafting of the Declaration of Independence.                      | 50 General Harrison, 9th "  |
| 20 Declaration of Independence.                                      | 51 John Tyler, 10th "   |
| 21 Surrender of Burgoyne.  | 52 James K. Polk, 11th "  |
| 22 Putnam's Escape.  | 53 Zachary Taylor, 12th "   |
| 23 Washington cross'g the Delaware.                                  | 54 Millard Fillmore, 13th "   |
| 24 Treason of Arnold.  | 55 Franklin Pierce, 14th "  |
| 25 Capture of Major Andre.   | 56 James Buchanan, 15th "   |
| 26 Surrender at Yorktown.  | 57 Abraham Lincoln, 16th "  |
| 27 Com. Perry at the Battle of Lake Erie.                            | 58 Andrew Johnson, 17th "   |
| 28 General Taylor at Buena Vista.                                    | 59 U. S. Grant, 18th "  |
| 29 General Scott at Contreras.                                       | 60 Lincoln at Home—a beautiful picture of President Lincoln and his son Thaddeus. |
| 30 Bombardment of Fort Sumter.                                       | 61 Henry Clay.  |
| 31 Soldier's Dream.  | 62 Daniel Webster.  |
| 32 Monitor driving the Merrimac.                                     | 63 Stephen A. Douglass.   |
| 33 Picket duty on the Potomac.                                       | 64 Edward Everett.  |
| 34 The First Reading of the Emancipation Proclamation. By Carpenter. | 65 Washington Irving.   |
| 35 Gen. Sherman entering Savan'h.                                    | 66 Professor Longfellow.  |
| 36 Union Army enters Petersburg.                                     | 67 Dr. Kane, the Arctic Explorer.   |
| 37 Assassination of Pres't Lincoln.                                  | 68 Rev. Henry Ward Beecher, D.D.  |
| 38 Apotheosis of Abraham Lincoln.                                    | 69 Rev. H. W. Bellows.  |
| 39 American Eagle.   | 70 Hon. W. L. Dayton.   |
|  | 71 Horace Greeley.  |
|  | 72 Hon. John P. Hale.   |
|  | 73 Hon. Hannibal Hamlin.  |
|  | 74 Geo. D. Prentiss, of Kentucky  |
|  | 75 Stephen Girard.  |
|  | 76 Hon. Charles Sumner.   |
|  | 77 Hon. Simon Cameron.  |
|  | 78 Hon. S. P. Chase, Chief Justice U. S.  |
|  | 79 Gov. Andrew, of Mass.  |
|  | 80 Gov. Brownlow, of Tenn.  |
|  | 81 William Penn.  |
|  | 82 Benjamin Franklin.   |
|  | 83 Lewis Cass.  |
|  | 84 Thomas H. Benton.  |

PORTRAITS OF DISTINGUISHED  
AMERICANS.

- |                                  |  |
|----------------------------------|--|
| 40 George Washington, by Stuart. |  |
| 41 " " by Peale.                 |  |
| 42 Martha Washington.            |  |
| 43 John Adams, 2d Pres. U. S.    |  |
| 44 Thomas Jefferson, 3d " "      |  |
| 45 James Madison, 4th " "        |  |
| 46 James Monroe, 5th " "         |  |

**Class VIII—The Principal Battles of the Franco-German War of 1870.**

Drawn on the Spot by S. Kaim, and also the Portraits from Life of the principal actors during the War.

PER SLIDE, \$2.50.

- |   |   |
|---|---|
| 1 The Battle of Weissenburg, Aug. 4, 1870.                  | 3 Storming of Weissenburg, Aug. 4, 1870.              |
| 2 The Battle of Wörth, and flight of McMuhon, Aug. 6, 1870. | 4 General view of the Battle of Sedan, Sept. 1, 1870. |

- |   |  |
|---|--|
| <p>5 On the evening of the Battle of Sedan, General Reille bearing surrender.</p> <p>6 Interview between Napoleon and Bismarck at Doucheri, Sept. 1, 1870.</p> <p>7 Napoleon surrendering his sword to King William, Sept. 2, 1870.</p> | <p>13 Von Moltke.</p> <p>14 Minister of War, Von Roon.</p> <p>15 General Blumenthal.</p> <p>16 General Falkenstein.</p> <p>17 General Von Goben.</p> <p>18 Napoleon III.</p> <p>19 Empress Eugenie.</p> <p>20 Prince Imperial.</p> <p>21 General MacMahon.</p> <p>22 General Canrobert.</p> <p>23 General Frossard.</p> <p>24 General Bazaine.</p> <p>25 Garibaldi.</p> <p>26 Prince Napoleon.</p> <p>27 General Uhlrick.</p> <p>28 General Steinmetz.</p> |
|---|--|

PORTRAITS.

- 8 King William of Prussia.  
 9 Queen of Prussia.  
 10 Crown Prince of Prussia.  
 11 Count Bismarck.  
 12 Leopold of Hohenzollern.

**Class IX—Views in Sets, conveying Moral Lessons.**

PER SLIDE, \$2.50.

**1. THE PILGRIM'S PROGRESS.**

A Sunday-school Concert Exercise, called "The Song of the Pilgrimage," is much used with this set. Price, 60 cents per dozen.

- 1 The Pilgrim and his Burden.
- 2 The Pilgrim at the Gate.
- 3 The Slough of Despond.
- 4 Christian and the 3 Shining ones.
- 5 The Shining Light.
- 6 The Pilgrim and the Lions.
- 7 Christian and the Shepherds.
- 8 The Pilgrims found Sleeping.
- 9 Vanity Fair.
- 10 Giant Pope.
- 11 Christian Arming.
- 12 Passing through the Waters.

☞ This set can be extended to twenty pictures, if preferred.

**2. CHRISTIANA AND HER CHILDREN.**

A Sunday-school Concert Exercise, called "Christiana and her Children," is much used with this set. Price, 96 cents per dozen.

- 1 Christiana and her Children.
- 2 The Letter.
- 3 The Man with the Muck Rake.
- 4 The Bath of Sanctification.
- 5 Great Heart and the Pilgrims.
- 6 Fight between Great Heart and Grim.

- 7 The Young Pilgrims catechized by Prudence.
- 8 The Shepherd Boy in the Valley of Humiliation.
- 9 The Pilgrims in the Valley of the Shadow of Death.
- 10 The Pilgrims at the House of Gaius.
- 11 Death of Giant Despair.
- 12 Christiana preparing to Cross the River.

☞ Instead of this, a new Series of twenty slides can be furnished, if desired.

**3. DRUNKARD'S PROGRESS AND END.**

- 1 Domestic Happiness.
- 2 The Temptation.
- 3 A Loving Heart made Sad.
- 4 The Rum-hole—a Substitute for Home.
- 5 Rum instead of Reason.
- 6 Degraded Humanity.
- 7 The Cold Shoulder by old friends
- 8 Rumseller's Gratitude.
- 9 Poverty and Want.
- 10 Robbery and Murder.
- 11 Mania-a-potu—the Horror of Horrors.
- 12 The Death that precedes Eternal Death.

In Series 3 we just get a glimpse at the comic side of the melancholy career more than in Series 4.

## 4. THE BOTTLE.

From the originals by G. Cruikshank.

- 1 The bottle is brought out for the first time. The husband induces his wife "just to take a drop."
- 2 He is discharged from his employment for drunkenness. "They pawn their clothes to supply the bottle."
- 3 An execution sweeps off the greater part of their furniture. "They comfort themselves with the bottle."
- 4 Unable to obtain employment, they are driven by poverty into the streets to beg, and by this means still supply the bottle.
- 5 Cold, misery, and want destroy their youngest child. "They console themselves with the bottle."
- 6 Fearful quarrels and brutal violence are the natural consequences of the frequent use of the bottle.
- 7 The husband, in a furious state of drunkenness, kills his wife with the instrument of all their misery.
- 8 The bottle has done its work—it has destroyed the infant and the mother; it has brought the son and daughter to vice and to the streets, and has left the father a hopeless maniac.

## 5. THE BOTTLE—(COMIC.)

EIGHT SLIDES, PER SET, \$12.00.

- 1 The Toast.
- 2 Various Brands.
- 3 Irish Whisky, Scotch Gin, and Five Points Rum.
- 4 Stabbing.
- 5 Shooting.
- 6 Robbing.
- 7 Hanging.
- 8 The End.

## 6. STOMACH OF THE DRUNKARD IN ITS DIFFERENT STAGES OF DISEASE.

APPEARANCE OF THE STOMACH.

- 1 Of a Temperance Man.
- 2 Of the Moderate Drinker.
- 3 Of the Drunkard.
- 4 After a Debauch.
- 5 Of a Hard Drinker.
- 6 Of a Habitual Drunkard.
- 7 Of a Drunkard on the verge of the grave.
- 8 During Delirium Tremens.

## 7. THE GAMBLER'S CAREER.

- 1 The first seed of the passion planted in the young mind.
- 2 The development of the passion with higher stakes.
- 3 Finding himself always the loser, he resorts to false play.
- 4 He is detected and roughly handled by his friends.
- 5 Having finally lost his all, he leaves the gambling-house in despair and madness.
- 6 He ends his life in a mad-house, still occupied with his ruling passion.

## 8. THE TEN COMMANDMENTS.

ILLUSTRATED IN 12 PICTURES.

- 1 Thou shalt have no other gods before me.
- 2 Thou shalt not make unto thee any graven image.
- 3 Thou shalt not take the name of the Lord thy God in vain.
- 4 Remember the Sabbath day to keep it holy.
- 5 Honor thy father and thy mother.
- 6 Thou shalt not kill.
- 7 Thou shalt not commit adultery.
- 8 Thou shalt not steal.
- 9 Thou shalt not bear false witness against thy neighbor.
- 10 Thou shalt not covet.
- 11 Moses receiving the Tables of the law.
- 12 Moses delivering the Tables of the law to the people.

## 9. THE LORD'S PRAYER.

ILLUSTRATED.

Original designs by Nisle.

- 1 "Our Father which art in heaven."
- 2 "Thy will be done on earth as it is in heaven."
- 3 "Give us this day our daily bread."
- 4 "Forgive us our debts as we forgive our debtors."
- 5 "Lead us not into temptation."
- 6 "Deliver us from evil."
- 7 "Thine is the kingdom, and the power, and the glory, forever. Amen."

## 10. FOUR SCENES FROM THE LIFE OF A COUNTRY BOY.

- 1 Leaving Home.
- 2 Temptation and Fall.
- 3 Farther on—Gambling.
- 4 At Last—the Forged Check.

## 11. SHAKSPEARE'S SEVEN AGES OF MAN.

- 1 The Infant.
- 2 The School-boy.
- 3 The Lover.
- 4 The Soldier.
- 5 The Justice.
- 6 The Lean and Slippered Pantaloon.
- 7 The Last Scene.

## 12. MASONIC AND OTHER LODGE PICTURES.

- 1 Skull and Cross Bones.
- 2 Crown and Glory.
- 3 The Pilgrims.
- 4 The Knight.
- 5 Ascension.
- 6 The Skeleton.
- 7 Temple of Honor.
- 8 First Star.
- 9 Second Star.

- 10 Third Star.
- 11 Open Grave.
- 12 Closed Grave.
- 13 The Rainbow.
- 14 The Forge.
- 15 Punishment.
- 16 Family Happiness.
- 17 Washington.

## 13. TAM O'SHANTER.

ILLUSTRATING BURNS' POEM.

- 1 "And scarcely had he Maggie rallied,  
When out the hellish legion sallied."
- 2 "Gathering her brows like gathering storm,  
Nursing her wrath to keep it warm."
- 3 "The Souter tauld his queerest stories,  
The landlord's laugh was ready chorus."
- 4 "Nae man can tether time or tide;  
The hour approaches Tam maun ride."
- 5 "Ae spring brought off her master hale,  
But left behind her ain gray tail."
- 6 "And vow! Tam saw an unco' sight!  
Warlocks and witches in a dance."

## 14. NEW TALE OF A TUB.

A COMIC POEM ILLUSTRATED.

Each set of these Pictures is accompanied by a copy of the Poem.

- 1 Opening the Question—the Bengal Tiger.
- 2 Bengal Ease.
- 3 The Artful Dodge.
- 4 Look before you Leap.
- 5 Under Cover.
- 6 Increasing the interest of the Tail.
- 7 The Climax.



### 15. THE HISTORY AND AMUSING ADVENTURES OF RENARD, THE SLY FOX.

From the Celebrated Illustrations by Kaulbach, of Munich.

- 1 Renard leads Bruin to search for honey and entraps him.
- 2 Renard feigns death, deceives the crows, kills and eats them.
- 3 Renard deludes the storks, bites off their heads and eats them.
- 4 Renard entraps the hares.
- 5 Renard plots the destruction of the chicken family.
- 6 Renard kills the chickens, but is taken prisoner.
- 7 Renard condemned to death.
- 8 Renard taken from prison to cure the king, and succeeds.
- 9 Renard's cousin, a she-monkey, implores the king to pardon Renard.
- 10 Renard's life spared, on condition that he fights with the wolf.
- 11 Renard greases his whole body, so that the wolf cannot lay hold on him.
- 12 Renard succeeds in blinding the wolf, and conquers him with ease.
- 13 Renard receives the homage of the courtiers and the people.
- 14 Renard decorated by the king, and appointed counselor.
- 15 Renard lives henceforth a life of ease and opulence in his luxurious house.

### 16. SELECTIONS FROM THE FABLES OF LAFONTAINE.

ILLUSTRATED BY GRANDVILLE.

The Text to these amusing and interesting Fables may be found in E. WRIGHT'S English Translation, published by WILLIS P. HAZARD, Philadelphia.

- 1 The Grasshopper and the Ant.
- 2 The Raven and the Fox.
- 3 The Frog that Wished to be as Big as the Ox.

- 4 The Wolf and the Dog.
- 5 The City Rat and the Country Rat.
- 6 The Wolf and the Lamb.
- 7 The Thieves and the Ass.
- 8 Death and the Unfortunate.
- 9 Death and the Woodman.
- 10 The Fox and the Stork.
- 11 The Wolf accusing the Fox before the Monkey.
- 12 The Bird Wounded by an Arrow.
- 13 The Lion and the Gnat.
- 14 The Ass Loaded with Sponges, and the Ass Loaded with Salt.
- 15 The Lion and the Rat.
- 16 The Dove and the Ant.
- 17 The Astrologer who stumbled into a Well.
- 18 The Hare and the Frogs.
- 19 The Lion and the Ass Hunting.
- 20 The Miller, his Son, and the Ass.
- 21 The Wolf turned Shepherd.
- 22 The Frogs asking a King.
- 23 The Fox and the Goat.
- 24 The Drunkard and his Wife.

### 17. THE CRUSADERS.

- 1 Harangue to the Crusaders.
- 2 Departure of the Crusaders.
- 3 Combat between Crusaders and Saracens.
- 4 Crusaders besieging a City.
- 5 Breaking up of the Camp.
- 6 Return of the Crusaders.

### 18. THE ILL-FATED SHIP.

- 1 The Ship Leaving the Wharf.
- 2 The Ship Sailing with Fair Wind.
- 3 The Commencement of a Storm.
- 4 Height of a Storm.
- 5 The Ship on Fire.
- 6 The Raft.

### 19. SCHILLER'S SONG OF THE BELL.

- 1 Portrait of the German Poet, Fr. V. Schiller.
- 2 The Baptism.

- 3 Happy Home.
- 4 Going to Church.
- 5 Marriage Bell.
- 6 Harvest Home.
- 7 Fire Bell.
- 8 The Tocsin.
- 9 Funeral Bell.
- 10 Raising of the Bell.

## 20. RIP VAN WINKLE.

- 1 His Scolding Wife.
- 2 Rip with the Children.
- 3 Rip at the Village Inn.
- 4 The Drinking Party in the Mountain.
- 5 Rip Returns to his Home.
- 6 Rip Relating his Story.

## Class X—Miscellaneous Pictures.

PER SLIDE, \$2.50.

- |   |  |
|---|--|
| 1 Alpine Cottage.                           | 39 Crossing the Thay.                    |
| 2 Approach of Evening.                      | 40 Dancing Children.                     |
| 3 Angels of the Madonna Sixtina.            | 41 Darwin Expounding his Theory (comic). |
| 4 Angel of Peace.                           | 42 Daughter of the East.                 |
| 5 Angel of Light.                           | 43 Daughter of Zion.                     |
| 6 "A Baby was Sleeping."                    | 44 Deceiving Granny.                     |
| 7 Agriculture.                              | 45 Deer Stalkers.                        |
| 8 America.                                  | 46 Dinah Consoling Hetty in Prison.      |
| 9 Asia.                                     | 47 Doll's Birthday.                      |
| 10 Bacchus and his Panthers.                | 48 Donkey Race (comic).                  |
| 11 Bargaining for a Horse.                  | 49 Drawing the Net at Hawesworth.        |
| 12 Basanio and Portia.                      | 50 Driving Home the Flocks.              |
| 13 Bed Time.                                | 51 Drift Wreck from the Armada.          |
| 14 Behave Well.                             | 52 Drumming Lesson.                      |
| 15 Beware.                                  | 53 Eagle and Shield.                     |
| 16 Blessings of the House and of the Field. | 54 Engineering.                          |
| 17 Bo Peep.                                 | 55 Enjoying the Breeze near the Lake.    |
| 18 Bolton Abbey, in the olden time.         | 56 English Cottage.                      |
| 19 Both Puzzled.                            | 57 Evangeline.                           |
|   | 58 Eve of the Flight.                    |
|   | 59 Expectation.                          |
|   | 60 Faith.                                |
|   | 61 Fairy Tales.                          |
|   | 62 Faithful Friend.                      |
|   | 63 Family Happiness.                     |
|   | 64 Farewell.                             |
|   | 65 Farm Yard in Winter.                  |
|   | 66 Feeding the Dogs.                     |
|   | 67 First Alms.                           |
|   | 68 First Born.                           |
|   | 69 First Lesson.                         |
|   | 70 First Reformer's Protest.             |
|   | 71 Forester's Family.                    |
|   | 72 Flute Lesson.                         |
|   | 73 Full Practice.                        |
|   | 74 Game of Life.                         |
|   | 75 Gardener's Daughter.                  |
|   | 76 Gathering the Mistletoe.              |
|   | 77 Genius of Electricity.                |
|   | 78 Genius of Steam.                      |
|   | 79 Girl Milking.                         |
- "But, sir, if wanst naught be nothin', then twice naught must be some-  
thin', for its double what wanst  
naught is."
- 20 Brigand's Hat.
  - 21 Briquet Hound.
  - 22 Broken Doll.
  - 23 Cabman's Leisure Hour.
  - 24 Cavalry Charge.
  - 25 Cendrillon.
  - 26 Charity.
  - 27 Children's Dance.
  - 28 Children's Offering.
  - 29 Children Making Wreaths.
  - 30 Children of Charles the First.
  - 31 Christmas Eve.
  - 32 Christian Maiden.
  - 33 Cocoa Merchant.
  - 34 Come Along.
  - 35 Coming thro' the Rye.
  - 36 Consolation.
  - 37 Contentment.
  - 38 Cross of Prayer.

- 80 Glimpse of an English Homestead.  
 81 Going to Bed.  
 82 Going Halves.  
 83 Gourmand.  
 84 Grandma's Pet.  
 85 Grandpa's Siesta.  
 86 Gretchen and her Pet Lamb.  
 87 Hannibal Crossing the Alps.  
 88 Happy as a King.  
 89 Hero.  
 90 Highlander's Dream of Home.  
 91 Hold Straight.  
 92 Home Again.  
 93 Homeless.  
 94 Hope.  
 95 Hunting the Walrus.  
 96 Imaginary Sick Bachelor.  
 97 Inundation.  
 98 Knitting Lesson.  
 99 Last Parting of the Sons of Edward IV.  
 100 Lazy Little Girl.  
 101 Left in Charge.  
 102 Leopard Hunter.  
 103 Lily of Ghent.  
 104 Little Arithmetician.  
 105 Little Family.  
 106 Little Fruiterer.  
 107 Little Harvesters.  
 108 Little Shepherds.  
 109 Loan of a Bite.  
 110 Love at First Sight.  
 111 Love Token.  
 112 Maid of Orleans.  
 113 Martin Luther Burning the Pope's Bull, December, 1520.  
 114 Mama's Birthday.  
 115 Mary's Pet Lamb.  
 116 May Pole.  
 117 Men of War at Sheerness.  
 118 Milking the Goats.  
 119 Miracle of St. Mark.  
 120 Monarch of the Glen.  
 121 Mother's Shadow.  
 122 Mother's Grave.  
 123 Mother Goose.  
 124 My Lady's Page in Disgrace.  
 125 Napoleon's Death Bed.  
 126 Naughty Child.  
 127 Neapolitan Peasants.  
 128 Near the Falls.  
 129 Night.  
 130 Noon on the Lake Shore.  
 131 Norham Castle.  
 132 "Nothing Venture, Nothing Have."  
 133 Oh! or the Astonished Rustics.  
 134 On the Way to School.  
 135 On the Yorkshire Coast.  
 136 One Pipe and Two Crackers.  
 137 Open Bible. Psalm xix.  
 138 Othello Relating his Adventures.  
 139 Overtasked.  
 140 Peek-a-Boo.  
 141 Penman in Trouble.  
 142 Perdita and Florizel.  
 143 Persuasion.  
 144 Phoebe Mayflower.  
 145 Picture Book.  
 146 Playing at Doctor.  
 147 Play Ground.  
 148 Pride and Humility.  
 149 Primrose Gatherers.  
 150 Protection.  
 151 Rabbit Fanciers.  
 152 Reading the Psalms.  
 153 Renewal of the Lease Refused.  
 154 Return from the Fair.  
 155 Return of the Swallows.  
 156 Salmacis.  
 157 Saved.  
 158 St. Agnes.  
 159 Santo Barbara.  
 160 Saint Mark and the Saints.  
 161 Saint Peter, Martyr.  
 162 Scene at a Fire.  
 163 Sewing Lesson.  
 164 Scene at a Tournament.  
 165 Sheltering Tree.  
 166 Shepherd's Bible.  
 167 School Master in Love (comic).  
 168 Siesta after a Hearty Meal.  
 169 Siesta, Eugenio and Ladies.  
 170 Snow Storm.  
 171 Soldier's Home.  
 172 Spaniards and Peruvians.  
 173 Stag at Bay.  
 174 Steamboat Race on the Mississippi.  
 175 Stream of Life.  
 176 Study.  
 177 Summer Afternoon.  
 178 Tenderly Nursing.  
 179 Tight Cork (comic).  
 180 Three Christian Graces.  
 181 Three Members of the Temperance Society.

- |   |  |
|---|--|
| 182 Toilet.   | 191 Winter in New England.                       |
| 183 The Pets.   | 192 Winter's Morning.                            |
| 184 The Two Dogs.   | 193 Wounded Hound.                               |
| 185 The See-saw.  | 194 Writing Lesson.                              |
| 186 Unconscious Sleeper.  | 195 Youthful Anglers.                            |
| 187 Victor of the Glen.   | 196 Youthful Queen.                              |
| 188 Washington Irving and his<br>Literary Friends at Sunnyside. | 197 Young Companion and their<br>Hungry Friends. |
| 189 Washing Day.  | 198 Young Brood.                                 |
| 190 Whitewashing.   |  |

### Class XI—Dissolving Views.

Selected and executed with great care, in sets, so as to produce charming effects in dissolving.

*Four Slides, \$12.50.*

- 1 Fort Sumter in Time of Peace :  
Daylight, Moonlight.

Fort Sumter in time of War :  
On Fire during the Bombardment.  
Fire and Smoke Rising.

*Three Slides, \$10.00.*

- 2 Bay of Naples and Mt. Vesuvius :  
Day, Night,  
Eruption—Fire and Smoke  
Rising.

*Three Slides, \$10.00.*

- 3 Life Near the North Pole :  
Day, Night,  
Moving Aurora Borealis.

*Three Slides, \$10.00.*

- 4 Castle of St. Angelo and Church  
of St. Peter at Rome.  
Day, Night,  
Illuminated and Fireworks.

*Three Slides, \$10.00.*

- 5 Christmas Eve :  
At Home, In Camp,  
In Camp, Fire Burning, Smoke  
Rising.

*Four Slides, \$10.00.*

- 6 The Four Seasons :  
Spring, Autumn,  
Summer, Winter,

*Four Slides, \$10.00.*

- 7 Voyage of Life :  
Childhood, Manhood,  
Youth, Old Age.

*Two Slides, \$7.50.*

- 8 Water Mill in the Alps :  
Winter,  
Summer—Wheel Moving.

*Three Slides, \$7.50.*

- 9 The Brave Drummer-Boy and  
his Father :  
Both Enlist in the Union  
Army.  
In Battle against the Enemies  
of the Union.  
Both Mortally Wounded ; they  
Die together on the Battle-  
field.

*Three Slides, \$7.50.*

- 10 Love, Engagement, and Marri-  
age :  
The First Meeting.  
Five Minutes after the engage-  
ment.  
Five Years after Marriage.

*Three Slides, \$7.50.*

- 11 The Hopeful Bride.  
The Happy Mother.  
The Mourning Widow.

*Three Slides, \$7.50.*

- 12 Courtship for the Second Wife :  
The Ghost of the First Wife  
Appears.  
The Consternation.

*Three Slides, \$7.50.*

- 13 Life's Day:  
Morning, Noon,  
Night.

SETS OF TWO SLIDES.

*Per set, \$5.00.*

- 14 Cause and Effect :  
Rowing Against the Tide.  
Rowing With the Tide.
- 15 He who Marries does Well.  
He who does not Marry does  
Better.
- 16 Morning Star Rising.  
Evening Star Setting.
- 17 Grace Before Meat.  
Grace After Meat.
- 18 Expectation, Satisfaction.
- 19 Old Woman Reading.  
Old Woman Reeling.
- 20 Vase of Flowers in Bud.  
Vase of Flowers in Full Bloom.
- 21 Temptation, Perdition.
- 22 Castle of Ehrenfels on the Rhine :  
Summer, Winter.
- 23 Conway Castle, England :  
Day, Moonlight.
- 24 Windsor Castle :  
Day, Moonlight.
- 25 Isola Bella, Italy :  
Day, Moonlight.
- 26 The Settlement in the Back-  
woods.  
The First Beginning.  
The Increase.
- 27 Castle of Chillon on the Lake of  
Geneva, Switzerland :  
Day.  
Moonlight in Winter.
- 28 Death-bed of the Righteous :  
John Wesley's Last Moments  
Occupied in Praying.  
Death-bed of the Wicked :  
Cardinal Richelieu's Last Mo-  
ments Occupied in Card-  
playing.
- 29 Abel's Sacrifice Received.  
Cain's Sacrifice Rejected.
- 30 Noah Building the Ark.  
Noah Receiving Advice from  
Above.
- 31 Noah's Sacrifice.  
Appearance of the Rainbow.
- 32 Israelites Passing through the  
Red Sea.  
Destruction of Pharaoh and his  
Host.
- 33 The Witch of Endor Visited by  
Saul.  
The Witch of Endor raising  
Samuel.
- 34 Flower Pieces :  
Dahlias and Roses.  
Asters and Poppies.
- 35 Fruit Pieces :  
Grapes, Currants.
- 36 English Bull Dogs.  
English Sheep.
- 37 The Enemy at His Hiding Place.  
The Enemy at the Door.
- 38 Rebels Shooting a Prisoner.  
Rebels Defeated.
- 39 Before the Proclamation.  
After the Proclamation.
- 40 Vanity, Junketing.
- 41 War, Peace.
- 42 The Friendly Meal.  
A Temperance Meeting.
- 43 Joy, Sorrow.
- 44 Alexander and Diogenes.  
Jack in Office.
- 45 The Morning Kiss.  
The Evening Prayer.
- 46 High Life, Low Life.
- 47 Looking In, Looking Out.
- 48 Indolence and Folly :  
The Wrong Way of Spending  
the Sabbath.  
The Explanation of the Bible :  
The Right Way of Spending  
the Sabbath.
- 49 Fondly Gazing (very beautiful).  
"Fondly gazing on that young face,  
With anxious thoughts of future years;  
The mother watched each budding grace,  
And mused on all her hopes and fears!"  
The Empty Cradle (very beau-  
tiful).  
"Gone! from a world of pain and woe!  
Gone! from death—from sin's alloy,  
Gone! from temptation's wiles and, Oh!  
Gone! gone! from grief to endless joy!"
- 50 Mother's Dream.  
Angel of Peace.
- 51 Jeff in Power, Surrounded by his  
Generals.  
Jeff Powerless, Surrounded by  
his Captors.

- |   |  |
|---|--|
| <p>52 Oil Stocks, Up!<br/>Oil Stocks, Down!</p> <p>53 Old Patriot of '76 commenting<br/>on the Wicked Rebellion.<br/>Death-Bed of a Patriot in '64,<br/>Giving Advice to his Sons.</p> <p>54 The Farewell.<br/>The Farewell Goodnight.</p> <p>55 Puck and the Fairies.<br/>Puck and the Fairies Goodnight.</p> <p>56 The Dream, Goodnight.</p> <p>57 The Contraband.<br/>The Recruit.</p> <p>58 The Landlord, The Tenant.</p> <p>59 The Ball Room.<br/>The Workroom.</p> <p>60 St. James's, St. Giles's.</p> <p>61 In Public, In Private.</p> <p>62 Within, Without.</p> <p>63 The First Christmas Morning.<br/>The Star Appearing to the Shep-<br/>herds.</p> <p>64 The Pet of the Fancy.<br/>The Pet of the Ladies.</p> | <p>65 The Beggar.<br/>The Opulent.</p> <p>66 Outward Bound—The Quay at<br/>Liverpool.<br/>Homeward Bound—The Dock at<br/>Boston.</p> <p>67 My First Sermon.<br/>My Second Sermon.</p> <p>68 Summer Landscape.<br/>Winter Landscape.</p> <p>69 White Rose.<br/>Red Rose and Cupid.</p> <p>70 The Onconvaniances of Single<br/>Life.<br/>The Raal Convaniances.</p> <p>71 By the Seaside.<br/>Near the Falls.</p> <p>72 The Toilet.<br/>The Gourmand.</p> <p>73 Polar Landscape.<br/>Halo.</p> <p>74 Polar Landscape.<br/>Aurora Borealis.</p> <p>75 Highlander's Dream of Home.<br/>The Vision.</p> |
|---|--|

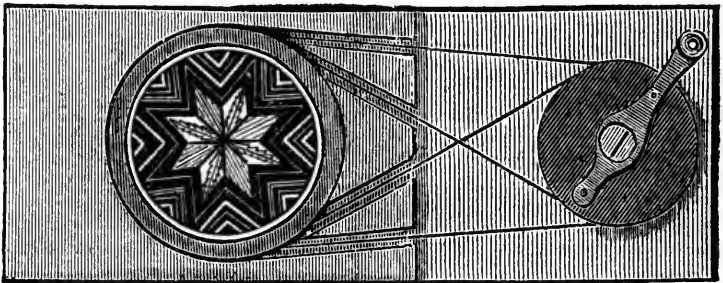

**Class XII—Chromatropes, or Artificial Fire-Works, &c.**

These slides are singularly curious, the effect being very similar to that of the Kaleido-scope. The pictures are produced by brilliant designs being painted upon two circular glasses, and the glasses being made to rotate in different directions. A pleasing variety of changes in the pattern are caused by turning the wheel—sometimes slowly, then quickly, backward and forward.

- |  |                           |
|--|---------------------------|
| <p>1 "The National Flag" Chromatrope. From designs expressly<br/>made to introduce the colors of our glorious National Flag.<br/>We have five different patterns of this Chromatrope. Each, .</p> <p>2 "The Geometrical" Chromatrope. A variety of entirely new<br/>and original patterns, of superior Chromatic and Geometrical<br/>effects. We have many different styles of this Chromatrope.<br/>Each, . . . . .</p> | <p>\$5 00</p> <p>5 00</p> |
|--|---------------------------|

3	"The Washington" Chromatrope. A new and beautiful design, with a photographic likeness of Washington in the centre (copied from Stuart's celebrated painting in the Boston Athenæum), and the stars and stripes revolving around it in glorious array. Each, . . . . .	\$5 50
4	"The Lincoln" Chromatrope. A correct likeness of our lamented President in the centre of a revolving display of brilliant colors. Each, . . . . .	5 50
5	"The Good Night" Chromatrope. The words "Good Night," encircled by a wreath of flowers in the centre of a Revolving Chromatrope—very appropriate as a closing piece of an exhibition. Each, . . . . .	5 50
6	"Good Night." The words of Good Night in a wreath of flowers—by moving a slip the words appear, . . . . .	3 50
7	Moving Waters. Represents the Waters moving in the Moonlight—a very beautiful and natural effect, . . . . .	2 50
8	Marcy's Eidotrope. . . . .	75

## PAINTINGS WITH REVOLVING MOTION.

9	View of Old Ruins, which, by being turned around, changes to Portrait of an Old Woman, . . . . .	5 00
10	Views of Rocks and Shrubbery, which by being turned around, changes to Portrait of a Satyr, . . . . .	5 00
11	Holland Windmill, with Revolving Fans, . . . . .	5 00
12	Jeff Davis <i>before the war</i> —a fierce-looking Soldier; by turning the slide, the same painting represents him <i>after the war</i> —a long-eared Jackass, . . . . .	5 00
13	Bombardment of Fort Sumter; the Ironsides throwing Shell, . . . . .	5 00
14	Mount Vesuvius—Eruption; throws out Fire and Smoke, . . . . .	5 00
15	Snow Slide—representing falling Snow. Each, . . . . .	4 50
16	The Seven Boys—The Pleiades, . . . . .	5 00
17	Fountain, . . . . .	5 00
18	Newton's Disc, revolving slides, with prismatic colors, for re-composing white light, . . . . .	5 00
19	A Slide representing the rolling up of a Curtain—intended for commencing an exhibition, . . . . .	5 50

This curtain is not needed with the Sciopticon, as its present front arrangement answers the purpose far better, and can be used with any slide.

## DISSOLVING CHROMATROPE, FOR USE ONLY IN THE DISSOLVING LANTERNS.

20	"Our Peacemakers," Dissolving Chromatrope. Arranged for dissolving effect, for two lanterns, on two slides. One slider exhibits the National colors in Chromatropic effect, with black centre, for one lantern. The other slider, intended for the other lantern, contains on a movable slider, five life-like portraits of President Lincoln, Major-Generals Grant and Sherman, and Admirals Farragut and Porter, which appear in the centre of the Chromatrope in succession. Per set, . . . . .	\$12 00
----	--	---------

- 21 "Our Departed Heroes," Dissolving Chromatrop. Arranged for dissolving effect, for two lanterns, on two slides. One slider exhibits the National colors in Chromatic effect, with black centre for the one lantern. The other slider, intended for the other lantern, contains on a movable slider five life-like portraits of distinguished heroes who lost their lives for the preservation of the Union. Per set, . \$12 00
- ☞ Extra Portrait Slides, adapted for the use of the Dissolving Chromatropes. Each slider contains five life-like portraits of distinguished Generals. Per slide, \$7.50.

### Class XIII—Original Leaf Designs.

Colored and mounted in wood.

PER SLIDE, \$1.50.

Motto, "God is Love."	Leaf Anchor.
" "Feed my Lambs."	" Harp.
" "God will Provide."	" Cross and Crown.
" "Faith, Hope, Charity."	" Merry Christmas.
Leaf Cross.	" Happy New Year.

### Class XIV—Statuary and Bas Reliefs.

Backed with opaque paint, and mounted in Wooden Frames.

PER SLIDE, \$1.50.

1 Night.	Thorwaldsen.	26 The Three Graces.
2 Morning.	"	27 The Greek Slave.
3 The Four Seasons—Spring.	"	28 Eve, before the fall.
4 The Four Seasons—Summer.	"	29 Night.
5 The Four Seasons—Autumn.	"	30 Morning.
6 The Four Seasons—Winter.	"	31 The Serenade.
7 The Council of War.	Rogers.	32 The Courtship.
8 The Fairy's Whisper.	"	33 The Minstrel.
9 Taking the Oath.	"	34 Dog Group.
10 Union Refugees.	"	35 The Sentry Box.
11 The Home Guard.	"	36 The Three Companions.
12 The Charity Patient.	"	37 The Cymbal Player.
13 The Returned Volunteer.	"	38 The Flower Girl.
14 The Wounded Scout.	"	39 Flora.
15 The Country Post-Office.	"	40 Psyche.
16 The School Examination.	"	41 Clio.
17 The Picket Guard.	"	42 Spring Season.
18 The Village School Master.	"	43 Solitude.
19 The Town Pump.	"	44 Woodman's Companion.
20 Mail Day.	"	45 The Little Market Girl.
21 The Bushwhacker.	"	46 Industry.
22 Courtship in Sleepy Hollow.	"	47 Pandora.
23 The Checker Players.	"	48 The Three Companions.
24 Uncle Ned's School.	"	49 Sympathy.
25 Apollo Belvidere.	"	50 The Invalid.



- |                                |                               |
|--------------------------------|-------------------------------|
| 51 The Two Companions.         | 71 Roman Emperor Caligula.    |
| 52 The Flower Girl of Paris.   | 72 Roman Emperor Caracalla.   |
| 53 Courtship.                  | 73 Minerva.                   |
| 54 Toilet Stand.               | 74 Rubens.                    |
| 55 Roman Vase.                 | 75 Michael Angelo.            |
| 56 Etruscan Vase.              | 76 Highland Mary.             |
| 57 The Mischievous Brothers.   | 77 Fisherman's Daughter.      |
| 58 Faith.                      | 78 Marguerita.                |
| 59 Evening.                    | 79 Jupiter and Hebe.          |
| 60 Morning.                    | 80 Sicilian Dancers.          |
| 61 Shakspeare.                 | 81 Cupid Asleep.              |
| 62 Ariadne and the Tiger.      | 82 Una and the Lion.          |
| 63 Feeding the Pet Dove.       | 83 The Hunter.                |
| 64 Our Saviour—after La Roche. | 84 After the Bath.            |
| 65 The Little Companion.       | 85 Amazon attacked by a Lion. |
| 66 Devotion.                   | 86 Amor Indignant.            |
| 67 Bedtime Prayer.             | 87 The Last Drop.             |
| 68 Innocence.                  | 88 The Pitcher-Girl.          |
| 69 The Pet Dove.               | 89 The Gladiator.             |
| 70 Faith.                      |                               |

**Class XV—Select Painted Comic Slip Slides, giving Laughable Motion to the Figures.**

PER SLIDE, \$1.25.

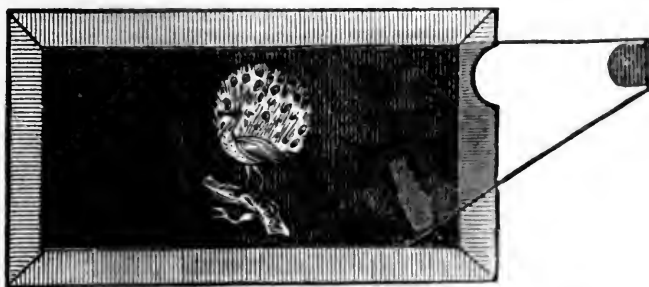

- |                                      |  |
|--------------------------------------|--|
| 1 Birth of Cupid.                    | 14 French Cook Cooked.                   |
| 2 Beggar.                            | 15 Good Night, in Wreath of Flowers.     |
| 3 Boy Smoking.                       | 16 Jugged Hare.                          |
| 4 Boys Birds' Nesting.               | 17 Lady with Expanding Dress and Bonnet. |
| 5 Cottage, with Bridge and Boats.    | 18 Lecture on Tobacco.                   |
| 6 Countryman and Dog Changing Heads. | 19 Lion—Moving Eyes and Jaw.             |
| 7 Cutting Corns.                     | 20 Lovers in Boat.                       |
| 8 Dentist Drawing Teeth.             | 21 Lodging-house Bedstead.               |
| 9 Drinking Fountain.                 | 22 Light-house in Storm.                 |
| 10 Dog in Kennel.                    | 23 Mischievous Monkey.                   |
| 11 Domestic Shower-Bath.             | 24 Man Swallowing Rats.                  |
| 12 Diver and Shark.                  | 25 Monkey Dipping Cat.                   |
| 13 Dutchman—Moving Eyes and Jaw.     | 26 Magician and Ghost.                   |

- |  |   |
|--|---|
| 27 Moving Water and Swan.                            | 39 Smuggler's Cave.                     |
| 28 Man Throwing Stick in Water,<br>and Dog Swimming. | 40 Spider and the Fly.                  |
| 29 Nightmare.  | 41 Turk's head—Moving Eyes.             |
| 30 Nearing Shore—Dog with Child<br>in Water.         | 42 Topsy—Moving Eyes.                   |
| 31 Pink Expanding.                                   | 43 Treading in Father's Shoes.          |
| 32 Pair of Snuffers.                                 | 44 Tax Collector.                       |
| 33 Peacock.  | 45 Taking off Boots.                    |
| 34 Performance on Two Chairs.                        | 46 Tulips.                              |
| 35 Parrot Pulling off Man's Wig.                     | 47 Windy Day.                           |
| 36 Rose and Fairy.                                   | 48 Woman with Cat's Head.               |
| 37 Somnambulist.                                     | 49 Woman with Growing Nose and<br>Chin. |
| 38 Sailor Smoking.                                   | 50 A Witch.                             |

PER SLIDE, \$1.75.

- |                                   |                                |
|-----------------------------------|--------------------------------|
| 1 Anti-Teetotaler.                | 17 Goose and Tailor.           |
| 2 Acrobats Performing.            | 18 Growing Nose.               |
| 3 Barber.                         | 19 Good Night.                 |
| 4 Blacksmith.                     | 20 How d'ye Do?                |
| 5 Cupid and Rose.                 | 21 Insect Changes.             |
| 6 Combing a Bald Head.            | 22 Man Eating Rats.            |
| 7 Cook and Boar's Head.           | 23 Mischievous Monkey.         |
| 8 Clown Performing.               | 24 Nightmare.                  |
| 9 Death on the Pale Horse.        | 25 Pickwick and Widow Kissing. |
| 10 Death in the Cup.              | 26 Parson and Punch.           |
| 11 Dentistry Improved.            | 27 Roman Nose.                 |
| 12 Drawing Boot.                  | 28 Scene on the Rhine.         |
| 13 Don't you Wish you may Get it? | 29 Stuck Fast.                 |
| 14 Expanding Crinoline.           | 30 Turk's Head.                |
| 15 Expanding Carnation.           | 31 Tiger's Head.               |
| 16 Ferocious Pig.                 | 32 Tailor and Geese.           |

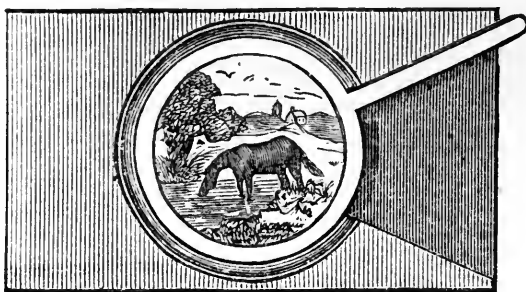

**Class XVI—Paintings with Levers, giving Laughable  
Motion to the Figures.**

PER SLIDE, \$2.50.

- |                |                    |
|----------------|--------------------|
| 1 Lady Riding. | 5 Cobbler at Work. |
| 2 Stag.        | 6 Bill Sticker.    |
| 3 Woodman.     | 7 Man's Face.      |
| 4 Moving Chin. | 8 Horse Drinking.  |

- |                                    |                                  |
|------------------------------------|----------------------------------|
| 9 Sambo Lecturing.                 | 32 Donkey Riding Extraordinary.  |
| 10 Stone Breaker.                  | 33 Sam Weller Cleaning Boots.    |
| 11 Large Ship by Night.            | 34 Woman Beating Boy.            |
| 12 Small Ship and Lighthouse.      | 35 Lady Praying.                 |
| 13 Boy on Donkey.                  | 36 Ship in a Gale.               |
| 14 Swan Drinking.                  | 37 Girl Feeding Goat.            |
| 15 Stag Drinking.                  | 38 Fiddler.                      |
| 16 Cow Drinking.                   | 39 Volunteer.                    |
| 17 Beggar.                         | 40 Monkey and Fish.              |
| 18 See-Saw.                        | 41 Doctor and Patient.           |
| 19 Boy Stealing Apples.            | 42 Dying Camel.                  |
| 20 Gout.                           | 43 Bathing.                      |
| 21 Digger.                         | 44 Dog of St. Bernard.           |
| 22 Monk Praying.                   | 45 Native Nursing.               |
| 23 Boy Cleaning Boots.             | 46 Pleasure Boat in Rough Water. |
| 24 Reaper.                         | 47 Steamboat Pleasure Trip.      |
| 25 Fractious Child.                | 48 Goat Feeding.                 |
| 26 Monkey Dipping Cat.             | 49 Natives.                      |
| 27 Lady Playing Pianoforte.        | 50 Look before you Leap.         |
| 28 Gent in Pegtops taking off Hat. | 51 Robinson Crusoe on his Raft.  |
| 29 Horse Eating.                   | 52 Looking Out for Papa.         |
| 30 Children in Boat.               | 53 Signals of Distress.          |
| 31 Grooming Horse.                 | 54 Farmer and Pig.               |

### Class XVII—Dioramic Paintings, with Moving Figures.

On Slides, from twelve to fourteen inches long, with two Glasses, on one of which the scene is painted, and on the other the Figures. The Glass containing the Figures is moved in a groove, and the Figures, Vessels, &c., pass across the Scene.

PER SLIDE, \$4.00.

- |                       |  |
|-----------------------|--|
| 1 Holyrood Chapel.    | 14 Israelites Crossing the Red Sea.  |
| 2 Dover Castle.       | 15 Noah Entering the Ark.  |
| 3 Bernard Castle.     | 16 Menagerie.—Keeper pointing to<br>the cage, in which various ani-<br>mals appear in succession |
| 4 Virginia Water.     | 17 Melrose Abbey.  |
| 5 Conway Castle.      | 18 Tintern Abbey.  |
| 6 Coventry.           | 19 Eddystone Light House.  |
| 7 Lambeth Palace.     | 20 Rome and the Tiber.   |
| 8 Sidon.              | 21 Arch of Trajan.—Procession of<br>Monks.   |
| 9 Smuggler's Cave.    | 22 Nagasaki in Japan.  |
| 10 Newstead Abbey.    | 23 Castle of Chillou.  |
| 11 Pyramids of Egypt. |  |
| 12 Warwick Castle.    |  |
| 13 Thames Tunnel.     |  |

### Class XVIII—Paintings Illustrating Nursery Tales.

- |  |        |
|--|--------|
| 1 Old Man, Son and Ass; or, the Folly of Trying to Please Every<br>One, eight paintings on two slides, . . . . . | \$4 00 |
| 2 House that Jack Built, ten paintings on two slides, . . . . .  | 4 00   |
| 3 Jack and the Bean Stalk, eight paintings on two slides, . . . . .  | 4 00   |
| 4 Whittington and Cat, ten paintings on two slides, . . . . .  | 4 00   |
| 5 John Gilpin, nine paintings on two slides, . . . . .   | 4 00   |
| 6 Cock Robin, ten paintings on two slides, . . . . .   | 4 00   |

7	Cinderella, eight paintings on two slides, . . . . .	\$4 00
8	Robinson Crusoe, eight paintings on two slides, . . . . .	4 00
9	Mother Hubbard, eight paintings on two slides, . . . . .	4 00
10	Seven Ages of Man, seven paintings on one slide, . . . . .	2 00
11	Blue Beard, four paintings on one slide, . . . . .	2 00
12	Jack and the Bean Stalk, eight slides, per set, . . . . .	11 00
13	Puss in Boots, twelve slides, per set, . . . . .	15 00
14	Tale of a Tub, seven slides, per set, . . . . .	10 50
15	Babes in the Wood, per set, . . . . .	12 00

### Class XIX—Beautifully Colored Photographs of Fine Engravings.

Lists in detail sent on application.

PER SLIDE, \$2.50.

	The number of Slides in each Set.
1 Dore's Illustrations to the Bible, . . . . .	230
2 Dore's Illustrations to Milton's Paradise Lost, . . . . .	50
3 Dore's Illustrations to Dante's Inferno, . . . . .	76
4 Dore's Illustrations to the Legend of the Wandering Jew, . . . . .	12
5 Pictures in the Royal Galleries of Dresden, Munich, and Berlin, . . . . .	80
6 St. Paul's Journeys Illustrated, . . . . .	34
7 Kaulbach's "Shakespeare Gallery," . . . . .	12
8 Views on the Bosphorus, . . . . .	80
9 Solomon's Temple, . . . . .	20
10 Selections from Bendemann's Frieze, in Royal Palace, Dresden, . . . . .	40
11 Præ-Raphaelite Pictures, by Italian masters, . . . . .	36
12 Scenes Illustrating Cooper's Novels, by Darley, . . . . .	32
13 Commodore Wilkes's Exploring Expedition, . . . . .	40
14 Dr. Kane's Arctic Explorations, . . . . .	14
15 American Civil War, . . . . .	1000
16 Franco-German War, . . . . .	50
17 Chicago Fire, . . . . .	50
18 The American in Europe, by H. C. Crocket, . . . . .	19
19 Fables of Æsop, . . . . .	24
20 Life and History of a Horse, . . . . .	8
21 Adventures of a Frog, . . . . .	15
22 Grisettes Grotesques, by Tom Hood, . . . . .	36
23 Illustrations of Burns's Poem, "Cottar's Saturday Night," . . . . .	8

Also many others which, if not in stock, can be made from negatives on hand, at short notice.

## SCIENTIFIC DEPARTMENT.

The pictures in the following Scientific Sets are photographs beautifully colored, except in such individual cases as do not admit of color.

When these are sealed in Canada Balsam, with carefully finished sky and background, they are sold at \$2.50 each. Considering, however, that for educational uses, there is little need for this extra finish, and that their demand for school purposes is likely to be large, the choicest of them have been selected to be sold in sets at an average of \$1.50 each. When not taken in sets, they are \$2.00 each; when sealed, as above indicated, they are \$2.50 each.

These Scientific Slides are just suited to the wants of Educationalists at this time. They need but to be known to be very highly appreciated. These, with the Sciopticon, are far more useful than huge piles of cumbersome philosophical apparatus of many times the cost.

### Class XX—Mammalia.

TWENTY SLIDES, PER SET, \$30.00.

- 1 Gorilla.
- 2 Lion.
- 3 Tiger.
- 4 Jaguar.
- 5 Leopard.
- 6 Lynx.
- 7 Hyena.
- 8 Wolf.
- 9 Newfoundland Dog.
- 10 Fox.
- 11 Grizzly Bear.
- 12 Seal.
- 13 Kangaroo.
- 14 Red Squirrel.
- 15 Porcupine.
- 16 Elephant.
- 17 Rhinoceros.
- 18 Reindeer.
- 19 Giraffe.
- 20 Camel.

ADDITIONAL ILLUSTRATIONS,

PER SLIDE, \$2.00.

- 21 King of the Cannibals.
- 22 Skeleton of Man and Gorilla.
- 23 Mandrill.
- 24 Diadem Lemur.

- 25 Vampire Bat.
- 26 Mole.
- 27 Hedgehog.
- 28 Serval.
- 29 Puma.
- 30 Shepherd's Dog.
- 31 Esquimaux Dog.
- 32 Weasel.
- 33 Skunk.
- 34 Raccoon.
- 35 Brown Bear.
- 36 Polar Bear.
- 37 Marbled Seal.
- 38 Crested Seal.
- 39 Sea Lion.
- 40 Walrus.
- 41 Opossum.
- 42 Gray Squirrel.
- 43 Beaver.
- 44 California Gopher.
- 45 Bushy-tailed Rat.
- 46 Brown Rat.
- 47 Guinea Pig.
- 48 Red Rabbit.
- 49 Sloth.
- 50 Armadillo.
- 51 Ant Eater.
- 52 Duck-bill.
- 53 Skeleton of Elephant.
- 54 Hippopotamus.

- 55 Malayan Tapir.
- 56 Wild Boar.
- 57 Horse.
- 58 Zebra.
- 59 Red Deer.
- 60 Gazelles.
- 61 Chamois.
- 62 Sheep.

- 63 Cashmere Goat.
- 64 Musk Ox.
- 65 Cow.
- 66 Zebu.
- 67 Buffalo.
- 68 Llama.
- 69 Greenland Whale.
- 70 Porpoise.

### Class XXI—Birds.

TWENTY SLIDES, PER SET, \$30.00.

- 1 Condor.
- 2 Harpy Eagle.
- 3 Virginian Eared Owl.
- 4 Undulated Parrot.
- 5 Sappho Comet and Crested Humming Bird.
- 6 Kingfisher.
- 7 Tailor Bird.
- 8 Mocking Bird.
- 9 Skylark.
- 10 Blackbird.
- 11 Baltimore Oriole.
- 12 Blue Jays.
- 13 Lyre Bird.
- 14 Royal Bird of Paradise, and Blue Girl.
- 15 Turkey.
- 16 Ostrich.
- 17 White Stork.
- 18 Flamingo.
- 19 Domestic Ducks.
- 20 Pelican.

ADDITIONAL ILLUSTRATIONS,  
PER SLIDE, \$2.00.

- 21 Skeleton of a Bird.
- 22 Turkey Buzzard.
- 23 Gerfalcon.
- 24 Imperial Eagle.
- 25 Bald Eagle.
- 26 Barn Owl.
- 27 Cockatoo.

- 28 Toucan.
- 29 Mexican Trogon.
- 30 Parrots.
- 31 Woodpecker.
- 32 Black-breasted and King of Humming Birds.
- 33 Ruby-throated Humming Bird.
- 34 Whippoorwill.
- 35 Momotus Ceruleiceps.
- 36 Missel Thrush.
- 37 Bell Bird.
- 38 Blue Bird.
- 39 Scarlet Tanager.
- 40 Swallow.
- 41 Great Northern Shrike.
- 42 Rose-breasted Grosbeak.
- 43 Tree Sparrow.
- 44 Raven.
- 45 Wild Pigeon.
- 46 Pheasant.
- 47 Peacock Pheasant.
- 48 Ruffed Grouse.
- 49 Cassowary and Emu.
- 50 Great Bustard.
- 51 Whale-headed Stork.
- 52 Sacred Ibis.
- 53 Snipe.
- 54 Curlew.
- 55 Bean Goose.
- 56 White Swans.
- 57 Mutton Albatross.
- 58 Great Northern Diver.
- 59 Cormorant.
- 60 Penguin.

### Class XXII—Reptiles and Fishes.

TWENTY SLIDES, PER SET, \$30.00

- 1 Green Turtle.
- 2 Crocodile.
- 3 Alligator.
- 4 Chameleon.
- 5 Boa Constrictor.

- 6 Rattlesnake.
- 7 Viper.
- 8 Cobra di Capello.
- 9 Bull Frog.
- 10 Natterjack.

- 11 Perch.
- 12 Mackerel.
- 13 Sword Fish.
- 14 Dolphin.
- 15 Fishing Frog.

- 16 Flying Fish.
- 17 Sea Horse.
- 18 Sturgeon.
- 19 White Shark.
- 20 Topedo.

### Class XXIII—Insects.

TWENTY SLIDES, PER SET, \$30.00.

- 1 Buprestian Beetles (4 species).
- 2 Harlequin Beetles.
- 3 Mole, Cricket, and Cockroach.
- 4 Katydid, Locusts, and Grasshopper.
- 5 Chinese Lantern Fly.
- 6 Bedbug.
- 7 Dragon Fly.
- 8 Ant-lion, and Lace-winged Fly, with larva.
- 9 Nymphalis Dissippe, with larva and chrysalis.
- 10 Peacock Butterfly, with larva and chrysalis.
- 11 Papilio Turnus.
- 12 Parsnip Butterfly, with larva and chrysalis.
- 13 Erebe-strix.
- 14 Five-spotted Sphinx, with larva and chrysalis.
- 15 Honey Bees—queen worker and drone, with comb.
- 16 Mosquito and Eggs.
- 17 Proboscis of Horse Fly.
- 18 Flea (of cat).
- 19 Human Louse.
- 20 Walking Stick.

#### TEN ILLUSTRATIONS ON THE HONEY BEE.

PER SET, \$20.00.

- 1 Queen, Working Bee, Drone, and Comb.

- 2 Head of the Worker.
- 3 Abdomen of the Worker.
- 4 Structure of the Eyes of a Bee.
- 5 Proboscis of the Worker.
- 6 Wing and Hind Leg of Worker.
- 7 Sting of Worker.
- 8 Digestive, Respiratory, and Nervous System of Bee.
- 9 Larva and Pupa of Worker.
- 10 Home of the Bees.

#### INSECT METAMORPHOSIS.

Showing the different stages of Transformations, with beautiful landscapes.

PER SLIDE, \$2.50.

- 1 Papilio Machaon.
- 2 Vanessa Io.
- 3 Attacus Lunar.
- 4 Teigne tapezella.
- 5 Vespa Sylvestris.
- 6 Anthophora Personata.
- 7 Melontha Vulgaris.
- 8 Lucanus Cervus.
- 9 Hydrophilus Piceus.
- 10 Dysticus Marginalis.
- 11 Cicindela Campestris.
- 12 Calandra Palmarum.
- 13 Phyllium Siccifolium.
- 14 Locusta Vividissima.
- 15 Gryllotalpa Vulgaris.
- 16 Æschna Maculatissima.
- 17 Cicada Fraxini.
- 18 Calliphora vomitoria and Sarcophaga Carnaria.
- 19 Stratiomys Chamæleo.
- 20 Eristalis tenax.

### Class XXIV—Arachnida, Crustacea, et Cœtera.

PER SLIDE, \$2.50.

#### SPIDERS, ARACHNIDA.

- 1 Lycosa tarentula.
- 2 Theridion aphanæ.

- 3 Epeira diadema, cornuta, angulata, and bicornis.
- 4 Scorpion (from Texas).
- 5 Cheese Mite.
- 6 Itch acarus.

## CRUSTACEA.

- 1 Bernard Hermit Crab.
- 2 Lobster.
- 3 Parthenope Florida.
- 4 American Edible Crab.
- 5 Ranine Dentata.
- 6 Pchnognon Littorale.

## ENTOMOSTRACANS.

- 1 Barnacles.
- 2 Limulus Longispinus.
- 3 Daphnia Pulex (male and female).
- 4 Cyclops Quadricornis.
- 5 Water Fleas, various kinds.
- 6 Fairy Shrimp, Chirocephalus.

## MOLLUSCA.

- 1 Paper Nautilus.
- 2 Octopus or Poulpe.
- 3 Sepia Officinalis.
- 4 Pearly Nautilus.

- 5 Pteroceras Aporrhais and Strombus.
- 6 Murex Tenuispina and Pyrula canaliculata.
- 7 Harp Shell.
- 8 Mitra Episcopalis and Papalis.
- 9 Cypraea.
- 10 Turritella, Scalaria, and Vermetus.
- 11 Helix Albolabris.
- 12 Pecten Irradians and Mytilus Edulis.

## RADIATA.

- 1 Holothuria, or Sea Cucumber.
- 2 Sea Urchin.
- 3 Star Fish.

## JELLY FISH, OR ACALEPHS.

- 1 Pelagia Noctiluca.
- 2 Cyanea Euplocamia.
- 3 Physalia Arethusa.

## Class XXV—Botany.

## VEGETABLE ANATOMY.

TWENTY SLIDES, PER SET, \$30.00.

- 1 Vertical section of extremity of Root (highly magnified).
- 2 Section of Leaf, White Lily and Oleander (highly magnified).
- 3 Section of Coniferous Wood, and Glands (highly magnified).
- 4 Longitudinal section of portion of Stem and Spiral Vessels.
- 5 Lactiferous vessels of Celandine and Ficus elastica.
- 6 A Sting of the Nettle, showing circulation of Sap.
- 7 (1) Air cells from stem Limnorcharis Plumieri: (2) ditto, showing open passages at angles of cells: (3) Epidermis of Oncidium altissimum: (4) Stomata of Croton variegatum.
- 8 Section of Elm Branch.
- 9 Section of Ash Branch.
- 10 Transverse and vertical section of Negundo, a year ago.
- 11 Section of Fern Stem and Scaliform tissue.

- 12 Polleen Grains (six varieties).
- 13 Polleen Masses (Orchis, Plantanthera, and Asclepias).
- 14 Starch Grains (Potato, Wheat, and Maize in cells).
- 15 Vertical section of Stigma of Ditura.
- 16 Conducting tissue in Stigma of Ditura.
- 17 Section of Ovule of Polygonum before and after fecundation.
- 18 Germination of Fern Spore.
- 19 Fern and Sporangia.
- 20 Spores and Sporidia of diseased grain of Wheat.

## BOTANICAL ILLUSTRATIONS.

TWENTY SLIDES, PER SET, \$30 00.

- 1 Parts of a plant.
- 2 Germination.
- 3 Roots.
- 4 Buds and Leaves.
- 5 Flowers and Inflorescence.
- 6 Stamens and Pistils.
- 7 Exogenous Structure.
- 8 Crowfoot Family, Columbine, &c.



- |                |  |
|----------------|--|
| 9 Pink Family. | 15 Composite Family, Chicory and Calliopsis. |
| 10 Tobacco.    | 16 Oak.                                      |
| 11 Clover.     | 17 Fir and Hemlock Spruce.                   |
| 12 Apple.      | 18 Endogenous Structure.                     |
| 13 Rose.       | 19 Date Palm.                                |
| 14 Melon.      | 20 White Garden Lily.                        |

### Class XXVI—Flowers and Plants.

Skeleton leaves are very beautiful when thrown upon the screen, and even ordinary leaves, petals, &c., show very well.

TWENTY SLIDES, PER SET, \$30.00.

- 1 The White Lily.
- 2 Lily of the Valley.
- 3 Holly.
- 4 Boursalt Rose.
- 5 Fuschia.
- 6 *Amaryllis Johnsoni*.
- 7 *Dahlia Variabilis*.
- 8 Strawberry, Flower and Fruit.
- 9 *Camilla Japonica*.
- 10 Oleander.
- 11 *Magnolia* and *Passion Flower*.
- 12 *Chrysanthemum*.
- 13 Venus' Fly Trap.
- 14 Peony.
- 15 Japanese White Lily.
- 16 Fruit Piece.
- 17 Nasturtion.
- 18 Violets.
- 19 "Consider the Lilies," (with text).
- 20 White Pond Lily.

PER SLIDE, \$2.00.

- 21 *Sarracenia Purpurea*.
- 22 *Pelargonium*.
- 23 Almond, Flower and Fruit.
- 24 Pomegranate.
- 25 Figs and Olives.
- 26 Rose.
- 27 Bunch of Roses.
- 28 *Rudbeckia Speciosa*, *Antirrhinum majus*, *Lilium Lancifolium*.
- 29 Pine Apple.
- 30 Scarlet Geranium.
- 31 *Cattleya Superba*.

- 32 Figs.
- 33 *Cactus Triangulaire* and *Gayac Officinale*.
- 34 Rose and Buds.
- 35 *Citrus Aurantium*.
- 36 Bunch of Fruit.
- 37 Stock Gillyflower.
- 38 Blackberry.
- 39 *Passion Flower*.
- 40 *Viburnum Opulus* and *Mespilus Germanica*.
- 41 *Wellingtonia Gigantea*.
- 42 *Cactus* (six-sided).
- 43 Hyacinth.
- 44 Tulip.
- 45 The Banyan Tree.
- 46 Wreath of Flowers.
- 47 Clover.
- 48 Tobacco Plant.
- 49 The Date Palm.
- 50 Mountain Vegetation of Java.

IMPORTANT PLANTS USEFUL TO MAN.

- 51 Black Pepper—*Piper nigrum*.
- 52 Cinnamon—*Laurus cinnamomum*.
- 53 Nutmeg—*Myristica moschata*.
- 54 Clove—*Caryophyllus aromaticus*.
- 55 Coffee—*Coffea Arabica*.
- 56 Tea—*Thea Bohea* and *viridis*.
- 57 Cocoa—*Theobroma Cacao*.
- 58 Vanilla—*Vanilla aromaticus*.
- 59 Opium Poppy—*Papaver somniferum*.
- 60 Peruvian Bark—*Cinchona cordifolia*.

**Class XXVII—Physical Geography.**

From the best authorities.

PER SLIDE, \$2.50.

- |  |  |
|--|--|
| <ul style="list-style-type: none"> <li>1 Forms of Snow Crystals.</li> <li>2 Glacier in Western Norway.</li> <li>3 Niagara.</li> <li>4 Great Fall—Yosemite.</li> <li>5 Canon.</li> <li>6 Coral Reef.</li> <li>7 Water Spout.</li> <li>8 Group of Palms.</li> <li>9 African Scene.</li> <li>10 Tropical Vegetation.</li> <li>11 Banian Tree.</li> <li>12 Varieties and Distribution of Man.</li> </ul> | <ul style="list-style-type: none"> <li>15 Plutonic Rocks, Hartz Mountains, Germany.</li> <li>16 Plutonic Rocks. Rock labyrinths, near Baden.</li> <li>17 Primary Rocks. Burning Mountain, near Duttwelles.</li> <li>18 Primary Rocks. The Lurley Rock, on the Rhine.</li> <li>19 Volcanic Rocks. Isola della Frizza.</li> <li>20 Secondary Rocks. The Rock of Gibraltar.</li> <li>21 Secondary Rocks. Chalk Mountains in Dorsetshire.</li> <li>22 Secondary Rocks. The Bielgrund, near Dresden.</li> <li>23 Tertiary Rocks. Tivoli.</li> <li>24 Alluvial and Diluvial Deposits. The Valley of the Nile.</li> </ul> |
|--|--|

ILLUSTRATIONS TO HUMBOLDT'S  
COSMOS.

- 13 Aurora Borealis.
- 14 Midnight Sun at the North Cape.

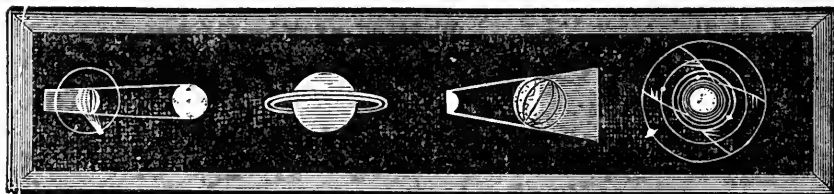
**Class XXVIII—Astronomy.**FORTY-ONE PAINTINGS, ON TWELVE  
LONG SLIDES.

PER SET, \$25.00.

Packed in a box, with descriptive book.

- |   |  |
|---|--|
| <ul style="list-style-type: none"> <li>1 The Earth's Rotundity (lever movable).</li> <li>2 New Moon.</li> <li>3 New Moon. First Quarter.</li> <li>4 Full Moon.</li> <li>5 The Moon's Phases.</li> <li>6 Telescopic View of the Sun.</li> <li>7 Telescopic View of Mercury.</li> <li>8 Telescopic View of Venus.</li> <li>9 The Earth and Moon.</li> </ul> | <ul style="list-style-type: none"> <li>10 Telescopic View of Mars.</li> <li>11 Telescopic View of Vesta, Juno, Ceres and Pallas.</li> <li>12 Telescopic View of Jupiter and his Moons.</li> <li>13 Telescopic View of Saturn and his Moons.</li> <li>14 Telescopic View of Saturn with rings edgewise and his Moons.</li> <li>15 Telescopic View of Uranus and his Moons.</li> <li>16 Orbit of a Comet.</li> <li>17 Comet of 1819.</li> <li>18 Comet of 1811.</li> <li>19 Comet of 1860.</li> <li>20 Solar System of Ptolemy.</li> <li>21 Solar System of Copernicus.</li> </ul> |
|---|--|

- 22 Solar System of Tycho Brahe.
- 23 Solar System of Newton.
- 24, 25 The Sun's Magnitude.
- 26 Eclipse of the Moon.
- 27, 28 Eclipse of the Sun.
- 29 The Moon's Orbit.
- 30 Different Eclipses of the Moon.
- 31 The Seasons.
- 32 The Zodiac.
- 33 Spring Tide at New Moon.
- 34 Spring Tide at Full Moon.
- 35 Neap Tide.
- 36, 37 Constellation Ursa Major.
- 38, 39 Constellation Orion.
- 40 The Milky Way.
- 41 Nebulae.

#### MOVABLE DIAGRAMS.

The motion produced by rack-work.

TEN SLIDES, PER SET, \$40.00.

Packed in a box, with lock and key.

- 1 The Solar System, showing the Revolution of all the Planets, with their Satellites, round the Sun.
- 2 The Earth's Annual Motion round the Sun, showing the Parallelism of its axis, thus producing the Seasons.
- 3 The Cause of Spring and Neap Tides, and the Moon's Phases, during its revolution.
- 4 The Apparent Direct and Retrograde Motion of Venus or Mercury, and also its Stationary appearance.
- 5 The Earth's Rotundity, proved by a Ship sailing round the Globe, and a line drawn from the eye of an observer placed on an eminence.
- 6 The Eccentric Revolution of a Comet round the Sun, and the appearance of its Tail at different points of its Orbit.
- 7 The Diurnal Motion of the Earth, showing the Rising and Setting of the Sun, illustrating the cause of Day and Night, by the Earth's rotation upon its **Axis**.

- 8 The Annual Motion of the Earth round the Sun, with the Monthly Lunations of the Moon.
- 9 The Various Eclipses of the Sun with the Transit of Venus; the Sun appears as seen through a Telescope.
- 10 The various Eclipses of the Moon; the Moon appears as seen through a Telescope.

Illustrating the Moon. Its Topography, Scenery, &c., with a Familiar Descriptive Lecture.

TEN SLIDES, PER SET, \$15 00.

- 1 Map of the Moon. (Beer and Madler.)
- 2 Diagram illustrating Refraction.
- 3 The Earth, as seen from the Moon.
- 4 Telescopic View of the Full Moon
- 5 Telescopic View of the Moon, first quarter.
- 6 Telescopic View of the Moon, last quarter.
- 7 Telescopic View of the Moon, past last octant.
- 8 Environs of Tycho (from a Photograph by W. de la Rue).
- 9 Region S. E. of Tycho.
- 10 View of Copernicus (Naysmith).

TWENTY SLIDES, PER SET, \$30.00.

- 1 Solar System.
- 2 Phases and Apparent Dimensions of Venus at its extreme and mean distance from the Earth.
- 3 Inclination of the Axis of the Planets—Venus, Earth, Mars, Jupiter, and Saturn.
- 4 Diagram illustrating Refraction.
- 5 Parallels, Meridians, and Zones.
- 6 True and mean Place of a Planet in its Orbit.
- 7 Signs of the Zodiac.
- 8 Telescopic View of the Full Moon
- 9 Telescopic View of the Moon past the last Quarter.
- 10 Cause of the Moon's Phases.
- 11 Mountains on the Moon.
- 12 Inclination of the Moon's Orbit.

- |  |   |
|--|---|
| <p>13 Diagram to explain Eclipses.<br/>         14 Illustration of the Tides.<br/>         15 Telescopic View of Mars.<br/>         16 Telescopic View of Jupiter.<br/>         17 Telescopic View of Saturn.<br/>         18 Comet of 1811.<br/>         19 Comparative Size of the Sun and Planets.<br/>         20 Star Cluster of Resolvable Nebulae.</p> <p style="text-align: center;">PER SLIDE, \$2.00.</p> <p>21 Bird's-eye View of Saturn and its ring system.<br/>         22 Saturn, luminous points visible near the period of the disappearance of the rings.<br/>         23 Telescopic View of Saturn.<br/>         24 Comparative size of Saturn and the Earth.<br/>         25 Telescopic View of the Moon, a little before last quarter.<br/>         26 Telescopic View of the Moon, just before the full.<br/>         27 Scenery on the Moon.<br/>         28 Mountains of the Moon; view of the region southeast of Tycho.<br/>         29 Comparative size of Sun, the Earth and Moon's Orbit.</p> | <p>30 Eclipses and passages of the Satellites of Jupiter, seen from the Earth.<br/>         31 Parallax.<br/>         32 Direct and retrograde motion of Mercury and Venus.<br/>         33 The apparent size of the Sun seen from the principal Planet.<br/>         34 Egyptian Zodiac.<br/>         35 The Micrometer.<br/>         36 Discovery of a small Planet by means of Ecliptic Charts.<br/>         37 Ecliptic Chart. From M. Chacornac's "Star Atlas."<br/>         38 Herschel's 40 feet Telescope.<br/>         39 Measure of the distance of an inaccessible object.<br/>         40 Deformation of the Sun's limb at sunset.<br/>         41 Convexity of the Ocean.<br/>         42 Solar Cyclone, May 5, 1857. (Secchi.)<br/>         43 Donati's Comet.<br/>         44 Spiral Nebulæ in Virgo. (Rosse.)<br/>         45 Nebulæ in Andromeda.<br/>         46 Elliptical annular nebula of the Lion. (Herschel.)<br/>         47 Spiral Nebulæ in Canes Venatici. (Rosse.)<br/>         48 Lunar Crater.</p> |
|--|---|

### Class XXIX—Geology.

TWENTY SLIDES, PER SET, \$30.00.

- 1 The Geological Record.
- 2 Ideal Section of the Earth's Crust.
- 3 Thickness of the Earth's Crust.
- 4 Section of a Volcano in action.
- 5 Fingal's Cave.
- 6 Grotto of Antiparos.
- 7 Glacier—Mt. Rose.
- 8 Glacier Tables.
- 9 Coral Island.
- 10 Corals.
- 11 Rain Drop Marks.
- 12 Trilobites.
- 13 Ammonites.
- 14 Pterichthys—Cocostes, Cephalaspis.
- 15 Fossil Fern—impression of.
- 16 A Thrust—in a Coal Mine.

- 17 Ichthyosaurus.
- 18 Pterodactyl.
- 19 Fossil Footmarks.
- 20 The Mammoth Restored.

PER SLIDE, \$2.00.

- 21 Skeleton of Megatherium.
- 22 Sigillaria.
- 23 Lepidodendron.
- 24 Tracks (the Stone Books).
- 25 Bone Cavern, Wirksworth, Eng.
- 26 Skeleton of Hydrarchos Harlanii.
- 27 Pentacrinites Briareus.
- 28 Apicrinites and Actinocrinites.
- 29 Forest of the Coal Period.
- 30 Dinornis Mantelii.
- 31 Foraminifera (from Atlantic soundings).
- 32 Lava Arch, Iceland.

- |   |   |
|---|---|
| 33 Section of the Cavern of Gailenreuth (Hartz.)<br>34 Sandstone Columns in Switzerland.<br>35 Skull of Mosasaurus. | 36 Temple of Serapis (Pozzuolo).<br>37 The Dodo (an extinct bird.)<br>38 Convoluted Strata.<br>39 Skeleton of Ichthyosaurus.<br>40 Diplacanthus Striatus. |
|---|---|

### Class XXX—Natural Phenomena.

TWENTY SLIDES, PER SET, \$45.00.

- |  |  |
|--|--|
| 1 Rainbow.<br>2 Tempest.<br>3 Aurora Borealis.<br>4 Halos.<br>5 Fata Morgana.<br>6 Will of the Wisp.<br>7 Water Spouts.<br>8 Sand Storm.<br>9 Geysers.<br>10 Falls of Niagara. | 11 Drooping Well.<br>12 Coral Reefs.<br>13 Caverns.<br>14 Fingal's Cave.<br>15 Perforated Rocks.<br>16 Glacier, Mt. Rose.<br>17 Glacier Tables.<br>18 Icebergs.<br>19 Volcanos.<br>20 Prairie on Fire. |
|--|--|

### Class XXXI—Anatomy and Physiology.

TWENTY SLIDES, PER SET, \$30.00.

- |  |  |
|--|--|
| 1 Human Skeleton.<br>2 Human Skull.<br>3 Section of the Spine, &c.<br>4 Teeth, and structure of same.<br>5 Muscles, front view.<br>6 Muscles, back view.<br>7 Muscles of the head, neck, and face.<br>8 General view of the Digestive Organs, in place.<br>9 The Digestive Organs. | 10 The Stomach, Liver, and Pancreas.<br>11 The Thoracic Duct.<br>12 Heart and Lungs.<br>13 Diagram of Circulation.<br>14 Skin and structure of same.<br>15 Brain and Spinal Cbrd.<br>16 General view of the Nerves.<br>17 Fifth Pair of Nerves.<br>18 Facial Nerves.<br>19 Diagram of the Eye.<br>20 Anatomy of the Ear. |
|--|--|

A set of 22 slides on Anatomy, copied from 22 plates in Iconographic Encyclopedia (from plate 119 to plate 140 inclusive), on glass three inches square. These, and illustrations of which we have the negatives, will be furnished at \$2.50 each. Illustrations of which the negatives must be made to order, will be furnished at \$3 each.

### Class XXXII—Microscopic Anatomy.

TWENTY SLIDES, PER SET, \$30.00.

- |   |  |
|---|--|
| 1 Tessellated and Ciliated Epithelial Cells.<br>2 Human Blood Discs, and Blood Discs of Frog. | 3 Longitudinal and transverse sections of Bone, Lacunae, and Canaliculi, highly magnified. |
|---|--|

- |   |  |
|---|--|
| <ul style="list-style-type: none"> <li>4 Muscular Fibres, Fasciculus, and Sarcolemma.</li> <li>5 Vertical and horizontal section of Stomach, Follicles, and Tubes.</li> <li>6 (A) Capillary Circulation of Frog's Foot; (B) Capillaries of Air Cells of Human Lungs; (C) Capillaries of Villi of the Jejunum.</li> <li>7 Origin of Hepatic Veins and Bile Ducts of the Liver Lobules.</li> <li>8 A Human Malpighian Corpuscle and transverse section of Supra-renal Capsule.</li> <li>9 Nerve Tubes, Cells, and Ganglia.</li> <li>10 Transverse section of Human Spinal Cord, close to the third and fourth Cervical Nerves.</li> </ul> | <ul style="list-style-type: none"> <li>11 Pus; (A) from Abscess; (B) Mucus Corpuscles from Schneiderian Membrane; (C) Mucus Corpuscles speckled with Pigment Granules from Larynx.</li> <li>12 Urinary Deposits; (A) Uric Acid; (B) Oxalate of Lime; (C) Triple Phosphate.</li> <li>13 Fatty Degeneration of the Liver.</li> <li>14 Tubercle; (A) in Air Cells of Lungs; (B) Miliary.</li> <li>15 Scirrhus Growth from Mammary Gland.</li> <li>16 <i>Tœnia Solium</i>.</li> <li>17 <i>Oxyuris Solium</i>.</li> <li>18 <i>Trichina Spiralis</i>, mature and in cyst.</li> <li>19 Liver Fluke, <i>Distoma hepaticum</i>.</li> <li>20 Thrush Fungus, <i>Oidium albicans</i>.</li> </ul> |
|---|--|

### Class XXXIII—Optics.

TWENTY SLIDES, PER SET, \$30.00.

- |   |   |
|---|---|
| <ul style="list-style-type: none"> <li>1 Reflection of Light.</li> <li>2 Formation of Image by Plane Mirror.</li> <li>3 Foci of Concave Mirrors.</li> <li>4 Formation of Image by Concave Mirror.</li> <li>5 Do. by Convex Mirror.</li> <li>6 Refraction of Light.</li> <li>7 Laws of Refraction and total Reflection.</li> <li>8 Refraction in Body with Parallel Sides.</li> <li>9 Forms of Lenses.</li> <li>10 Formation of Image by Convex Lens.</li> </ul> | <ul style="list-style-type: none"> <li>11 Formation of Image by Convex Lenses.</li> <li>12 Do. by Concave Lens.</li> <li>13 Spherical Aberration.</li> <li>14 Action of Prism—Chromatic Dispersion.</li> <li>15 Chromatic Aberration—Achromatic Prism and Lens.</li> <li>16 Diagram to explain Wave Lengths</li> <li>17 Double Refraction—Iceland Spar—Nichol Prism.</li> <li>18 Polaroscope, &amp;c.</li> <li>19 Colored Rings in Uniaxial Crystals with Polarized Light.</li> <li>20 Do. in Unannealed Glass Cube.</li> </ul> |
|---|---|

### Class XXXIV—The Microscope and its Revelations.

TWENTY SLIDES, PER SET, \$30.00.

- |  |   |
|--|---|
| <ul style="list-style-type: none"> <li>1 Tolle's Student's Microscope.</li> <li>2 Collins' Binocular Microscope.</li> <li>3 Diagrams. No. 1. Compound Microscope. 2. Huyghenian Eyepiece. 3. Ramsden Eyepiece. 4. Chromatic Aberration.</li> </ul> | <ul style="list-style-type: none"> <li>4 Diagrams. No. 1. Simple Microscope. 2. Spherical Aberration. 3. Diaphragm. 4. Achromatic Objective. 5. High and Low Angle of Aperture.</li> <li>5 Sheep Tick.</li> <li>6 Human Head Louse.</li> <li>7 Dog Flea.</li> <li>8 Larva of Mosquito.</li> </ul> |
|--|---|

- 9 Head of Male Mosquito.
- 10 Leg of Blow Fly.
- 11 Eye of Horse Fly.
- 12 Portion of Wing of House Fly.
- 13 Scales from Wing of Moth.
- 14 Wool Fibres.
- 15 Section of Wheat Straw.
- 16 Heliopelteia.
- 17 Fine Muslin—showing Cotton Fibre.
- 18 Foot of Fly—showing Structure of Pads.
- 19 Proboscis of Fly—*Anthromya Lardaria*.
- 20 Saws of Saw Fly.

Additional Photographs of Microscopic Objects enlarged from Nature.

PER SLIDE, \$2.00.

- 21 The Human Louse.
- 22 The Crab Louse.
- 23 The Bedbug.
- 24 The Flea.
- 25 The Fly.
- 26 Marine Algae.
- 27 Hunting Spider.
- 28 Parasite of Chicken.
- 29 The Common Mosquito.

- 30 Eye of Fly.
- 31 Sting of Bee.
- 32 Human Itch Insect.
- 33 Tongue of a Hornet.
- 34 Tongue of a Bee.
- 35 Parasite from a Fig.
- 36 Parasite from a Sparrow.
- 37 Scale from the Wing of a Butterfly.
- 38 Parasite of a Beetle.
- 39 Parasite of a Chaffinch.
- 40 Parasite of a Field Mouse.
- 41 Parasite of a Swallow.
- 42 Parasite of a Mole.
- 43 Flea of a Mole.
- 44 Flea of a Mole Pigeon.
- 45 Eye of a Beetle.
- 46 Gizzard of a Cricket.
- 47 Water Beetle.
- 48 Leaf Insect.
- 49 Scale from the Wing of a Moth.
- 50 Saw of the Saw Fly.
- 51 Spiracle of a Cockchafer.
- 52 Tongue of a Drone Fly.
- 53 Trachea of a Silk Worm.
- 54 Tongue of a Hornet.
- 55 Transverse Section of Bone.
- 56 Scale of a Fish.
- 57 Human Blood Corpuscles
- 58 Section of a Tooth.

### Class XXXV—Crystallography.

Arranged as in Roscoe's Chemistry.

TEN SLIDES, PER SET, \$15.00.

- |   |   |
|---|---|
| <ol style="list-style-type: none"> <li>1 The Primary Forms of the Six Systems.</li> <li>2 Secondary Forms of the First or Regular System.</li> <li>3 Secondary Forms of the Second or Quadratic System.</li> <li>4 Secondary Forms of the Third or Hexagonal System.</li> </ol> | <ol style="list-style-type: none"> <li>5 Secondary Forms of the Fourth or Rhombic System.</li> <li>6 Secondary Forms of the Fifth or Monoclinic System.</li> <li>7 Secondary Forms of the Sixth or Triclinic System.</li> <li>8 Ice Flowers (Tyndall).</li> <li>9 Snow Crystals.</li> <li>10 Ice Crystals.</li> </ol> |
|---|---|

### Class XXXVI—Spectrum Analysis.

TWENTY SLIDES, EACH, \$2.75.

- |  |  |
|--|--|
| <ol style="list-style-type: none"> <li>1 Decomposition of Light by Prism (Solar Spectrum).</li> <li>2 Comparative Intensity of Heating Luminous and Chemically Active Rays in Spectrum.</li> </ol> | <ol style="list-style-type: none"> <li>3 Fraunhofer's Map of Solar Spectrum. (1814-15.)</li> <li>4 The Spectroscope.</li> <li>5 Spectra of the Sun, Beta Cygni, and Hydrogen.</li> </ol> |
|--|--|

- |  |   |
|--|---|
| <ul style="list-style-type: none"> <li>6 Spectra of Potassium, Rubidium, Sodium, and Lithium.</li> <li>7 Spectra of Carbon Comet II, Brorsen's Comet (1868), Spark and Nebulæ.</li> <li>8 Spectra of Aldebaran, and Alpha Orionis.</li> <li>9 Kirchoff's Map (from 194 to 220) and Rutherford's Photograph of same.</li> <li>10 Spectra of Chlorophyll, Chloride of Uranium, Magenta, and Blood.</li> <li>11 Gassiot's Spectroscope. Made by Browning.</li> <li>12 Huggin's Map of Metallic Lines, from 320 to 279.</li> </ul> | <ul style="list-style-type: none"> <li>13 Huggin's Map of Metallic Lines, from 2790 to 5250.</li> <li>14 Huggin's Star Spectroscope.</li> <li>15 Map of Solar Spectrum, from 38 to 163.</li> <li>16 Map of Solar Spectrum, from 162 to 287.</li> <li>17 Map of Solar Spectrum, from 283 to 406.</li> <li>18 Coincidence of Spectrum of Iron with 65 of the Fraunhofer Lines.</li> <li>19 Spectra of the Sun, Chromosphere Prominences and Corona.</li> <li>20 The Atmospheric Lines.</li> </ul> |
|--|---|

### Class XXXVII. Geological Landscapes, etc.

PER SLIDE, \$2.50.

- 1 Silurian Period.
- 2 Devonian Period
- 3 Transition Period.
- 4 Carboniferous Period.
- 5 Forest of Coal Period.
- 6 Permian Period.
- 7 Triassic Period.
- 8 Conchylial Sub-Period.
- 9 Saliferous Period.
- 10 Lower Oolite Period.
- 11 Lower Cretaceous Period.
- 12 Cretaceous Period.
- 13 Eocene Period.
- 14 Miocene Period.
- 15 Drift Period.
- 16 Recent Period.

### EXTINCT ANIMALS.

From Originals by Waterhouse Hawkins.

- 1 Plesiosaurus, Teleosaurus, Ichthyosaurus, Petacrinites, Ammonites Gryphæa.
- 2 Megalosaurus, Pterodactyle.
- 3 Iguanodon, Hylæosaurus.
- 4 Anoplotherium Comune, Anoplotherium Gracile, Palæotherium.
- 5 Megatherium Glyptodon.
- 6 Elephas Primigenius, Hyæna Spelæa, Hippopotamus Major, Ursus Spelæus, Machairodus Latidens.

### Class XXXVIII. Society Emblems.

The Oil Sciopticon, with the improved and enlarged society slides now used with it, renders the projected emblems remarkably vigorous and impressive. Special slides will be made to order from furnished designs for \$3.00 each.

We are well prepared to furnish slides suitable for social entertainments, which in many cases greatly increase the usefulness of a society outfit.

### KNIGHTS TEMPLAR.

PER SLIDE, \$2.50.

#### FIRST PART.

- 1 Monument.
- 2 The Three Marys at the Sepulchre.
- 3 The Ascension.

#### SECOND PART.

- 4 Resurrection of Lazarus.
- 5 The Crucifixion.
- 6 Descent into the Grave.
- 7 The Resurrection.

- 8 The Cross.
- 9 Pilgrim.
- 10 Warrior.
- 11 Penitent.
- 12 Christ on the Cross.
- 13 Angel of Death.
- 14 Skull.
- 15 John's Vision.
- 16 Faith.
- 17 Cross and Crown.



**BLUE LODGE.**

Over 100 Emblems, on 30 Glass Slides.

PER SET, \$10.00.

Arranged in accordance with the American System of Lectures, in the degrees of Entered Apprentice, Fellow Craft, and Master Mason.

**THE PRINCIPAL LODGE EMBLEMS.**

On 25 Colored Sealed Slides.

PER SET, \$60.00

This series is the finest made, and is in use in the leading lodges. My negatives are from authorized drawings, gotten up at great expense, and the slides are colored and mounted in the best style.

**ODD FELLOWS.**

30 Emblems, on 4 Glass Slides.

PER SET, \$2.00.

- 1 The Great Commission. The All-Seeing Eye. Globe in Clouds. Sun of Righteousness. Three Links. Heart and Hand. Industry. Shepherd. Skeleton in Coffin.
- 2 Moses' Rod. Brazen Serpent. Justice. Coffin. Budding Rod. Ark and Dove. Horn of Plenty. Sun, Moon, and Seven Stars.
- 3 Covenant. Bow and Quiver. Bundle of Rods. Ark of the Covenant. Bow in the Clouds.
- 4 Smiting the Rock. Meeting Rebekah. Bible and Altar. Coming Down from the Mount. Aaron. Thomas Wildie.

**I. O. O. F. ENCAMPMENT.**

24 Slides.

PER SET, \$9.00.

**TEMPLE OF HONOR.**

8 Slides.

PER SET, \$20.00.

- 1 Five-pointed Star.
- 2 Six-pointed Star.
- 3 Star and Triangle.
- 4 Temple of Honor.

- |   |                     |
|---|---------------------|
| 5 | Open Grave.         |
| 6 | Closed Grave.       |
| 7 | Rainbow.            |
| 8 | Flash of Lightning. |

**THE TRUE TEMPLE**

is a variation from the above, but is similar in style and price.

**UNITED AMERICAN MECHANICS.**

PER SLIDE, \$2.50.

## Class XXXIX. Dissolving Effects, for Two Lanterns.

(SUPPLEMENT TO CLASS XI.)

- 1 St. Goar on the Rhine.  
Two Slides.....\$10.50  
Landscape at night. Clouds passing. The moon sometimes appears and illuminates the landscape and buildings.
- 2 Icebergs in the Northern Sea.  
Two Slides.....\$7.00  
The ice is seen moved by the tide; a ship is seen being wrecked by the iceberg.
- 3 The Highlander's Dream.  
Two Slides.....\$5.00  
A Highlander Soldier asleep by his camp fire. Vision of his return to the loved ones at home appears in the smoke of the camp fire.
- "Our bugles sang truce, for the night cloud had lowered,  
And the sentinel stars set their watch in the sky;  
And thousands had sunk on the ground, overpowered,  
The weary to sleep and the wounded to die.  
When reposing that night on my pallet of straw,  
By the wolf-scaring fagot that guarded the slain,  
At the dead of the night a sweet vision I saw,  
And thrice ere the morning I dream't it again.
- (The Vision is made to appear faintly.)
- "Methought from the battle-field's dreadful array,  
Far, far had I roamed, on a desolate track;  
T'was autumn—and sunshine arose on the way  
To the home of my fathers, that welcomed me back.
- (The Vision is made very brilliant.)
- 'I flew to the pleasant fields traversed so oft,  
In life's morning march, when my bosom was young.  
I heard my own moumtain-goats bleating aloft,  
And knew the sweet strain that the corn-reapers sung.
- "Then pledged we the wine-cup, and fondly I swore  
From my home and my weeping friends never to part;  
My little ones kissed me a thousand times o'er,  
And my wife sobbed aloud in fulness of heart—
- "Stay, stay with us—rest, thou art weary and worn;  
And fain was their war-broken soldier to stay:
- But sorrow returned with the dawning of morn,  
And the voice in my dreaming ear melted away."
- (The Vision vanishes away.)
- 4 Washington's Dream.  
Two Slides.....\$5.00  
Washington, tired with the day's cares, preparing despatches by candle light, in his camp at Valley Forge, has fallen asleep, and dreams of the future glory of America.
- 5 The American Soldier's Dream. Two Slides.....\$5.00  
The soldier is seen asleep by the camp fire, the sentinel in the distance. The vision of his promotion and return to the dear ones at home appears, and is then made to vanish.  
(Similar to the Highlander's Dream.)
- 6 The Martyred Christian; or Heavenward.  
Two Slides.....\$5.00  
The lifeless figure of a beautiful woman, the victim of heathen persecution, is seen floating upon the water, the moon shedding its rays upon her upturned face. Her spirit is seen borne to heaven by angels.
- 7 Mercy's Dream.  
Two Slides.....\$5.00  
Mercy is represented in a reclining position beneath a spreading tree. An angel from heaven appears and places a crown of glory on her head.
- 8 The Rock of Ages. Four Slides \$10.00, or Two Slides.....\$5.00  
A dark and stormy sky, and the waves dashing against the rocks, from which the Rock of Ages arises. A wreck is seen in the distance. The wreck disappears, and the figure of a woman appears clinging to the cross. The figure ascends to heaven.
- 9 The Orphan's Dream.  
Two Slides.....5.00  
This scene represents an orphan boy, who, tired by his pastimes, has fallen asleep upon his little couch. The spirit of his mother appears and bends tenderly over him, as if to give him her blessing.

- 10 **Angel of Peace.**  
Two Slides.....\$5.00  
A beautiful landscape showing a city at night, with the new moon in the sky reflected in the water. The figure of an angel bearing a child appears like a vision in the sky, and then fades away.
- 11 **The Mother's Dream.**  
Two Slides.....\$5.00  
The mother has fallen asleep by the baby's cradle, and dreams that the angel is bearing her babe away.
- 12 **Beethoven's Dream.**  
Two Slides.....\$5.00  
Beethoven is represented asleep, with his head resting upon his piano. A beautiful spirit playing upon a harp appears.
- 13 **No Cross no Crown.**  
Four Slides.....\$10.00  
Faith, surrounded by the waters of the River of Life, is represented gazing upon the vision of the Cross; then reclining beneath a spreading tree, her trials over, an angel crowns her.
- 14 **Ocean Steamer. Two Slides with movement.....\$6.00**  
A view of a harbor is represented, with a city in the distance, from which an ocean steamship, bound for Europe, sails away.
- 15 **The Serenade. Two Slides with movement.....\$6.00**  
A beautiful view, by moonlight, of a lake, on the borders of which is seen a castle brilliantly illuminated. The Serenader appears sailing in a gondola and playing a guitar. A lady steps out upon the balcony of the castle and listens to the serenade. (Music can be used in connection with this effect.)
- 16 **Magic Lily. Two Slides . \$7.00**  
Beautiful lily, from the centre of which a fairy with a wand arises.
- 17 **Train of cars. Two Slides with movement.....\$5.00**  
A railroad bridge in a dark forest, as seen by moonlight. A train of cars dashes by, the headlight and sparks flying from the engine making a very brilliant appearance.
- 18 **The Believer's Vision.**  
Two Slides.....\$5.00
- A beautiful lady is seen reclining on a sofa. She has fallen asleep after reading the Scriptures, and sees a vision of angels beckoning her away
- "There let my way appear  
Steps unto heaven;  
All that thou sendest me  
In mercy given;  
Angels to beckon me  
Nearer, my God, to Thee,  
Nearer to Thee!"
- 19 **Melrose Abbey, Scotland. \$5.50**  
The rising moon is seen through one of the windows.
- 20 **Stockholm by Moonlight.**  
Three Slides.....\$9.00  
A steamer has just arrived, from which smoke ascends. The moon glistens on the water. A boat with passengers is seen approaching the landing.
- 21 **St. Peter's Church at Rome, by day. Three Slides.....\$10.00**  
Night comes on. The church is seen by moonlight, and is then illuminated.
- 22 **Tower of London.**  
Two Slides.....\$5.00  
Day, Night.
- 23 **Views in the Arctic Regions.**  
Three Slides.....\$10.00  
Night sets in, and the aurora borealis is seen in the heavens.
- 24 **Mosque of Omar.**  
Two Slides.....\$5.00  
Day, Night, and Illuminated.
- 25 **Water Mill in Pennsylvania.**  
Five Slides.....\$20.00  
The wheel is seen in motion; a swan swims on the water and drinks; the moon rises and glistens on the water; the windows in the mill are now lit up; the ground is seen covered with snow, and the snow is seen falling.
- 26 **Trenton Falls, New York.**  
Two Slides.....\$8.00  
The water is seen pouring over the Falls and flowing away; this has a most beautiful effect.
- 27 **Castle on Lago Maggiore.**  
One Slide.....\$4.50  
A lover approaches in a boat, to serenade, upon which a lady appears on the balcony.
- 28 **Faust and Marguerite.**  
Two Slides.....\$8.00  
Faust as seen in his laboratory. Mephistopheles with magic bowl in his hand. Sud-

denly the vision of Marguerite appears, and flames dart out from the bowl.

- 29 Star of Bethlehem.  
Three slides.....\$8.00  
Shepherds are seen seated on the ground, and in the distance the star appears and gradually approaches until the Son of Man is seen in a halo of glory.
- 30 Westminster Abbey by Day.  
Two Slides.....\$5.00

Scene changes to moonlight, and interior is seen lighted up.

- 31 Magician and Caldron.  
Two Slides.....\$9.00  
Cave, and magician with his magic wand, with caldron in corner, out of which appears at various times, ghosts, witches, hobgoblins, etc.
- 32 White Chamber in the Royal Palace, Berlin, with the Ghost. Two Slides.....\$5.00

THE FOLLOWING ARE SUITABLE FOR EITHER ONE OR TWO LANTERNS.

- 1 Cole's Voyage of Life, a series of four allegorical pictures.....\$10.00.

#### CHILDHOOD.

A translucent stream is seen issuing from a deep cavern in the side of a mountain. Floating gently down the stream is a gilded boat, made of the sculptured figures of the Hours; while the prow is formed by the present hour holding forth an emblem of Time. It is filled with flowers; and on these a little child is seated, smiling with new-born joy as he looks upon the unnumbered beauties of the bright world around him; while a guardian angel is at the helm, with his wings lovingly and protectingly extended over the child.

"Fair CHILDHOOD starts, illumed with light,  
And pleasing visions trance the sight;  
Thus launched to sail o'er life's broad stream,  
The first bright days are but a dream;  
While onward through the opening morn,  
Still thoughtless of the gathering storm,  
Outward the being's vessel sweeps,  
To wider seas and mightier deeps."

#### YOUTH.

The Stream of Life is widened; the youth has taken the helm into his own hands and has turned the prow straight toward a gorgeous temple in the distance, whose walls are built on clouds, heedless of the dangers which may appear.

"Then Youth arrives. How fair the view!  
How radiant upward shines the blue!  
How kindly blows the gentle breeze  
That whispers through the shading trees!  
Enchanted youth! With longing sight  
He sees, amid the distant light,  
Magnificent, a temple rise,  
And, raptured, fame and honor cries."

#### MANHOOD.

The voyager is seen near the verge of a cataract, while a fearful storm rages around him. The rudderless bark is just about to plunge into the abyss below, while the voyager (now in the prime of manhood) is imploring the only aid that can avail him in the trying hour—that of Heaven.

"Alas! too soon, with MANHOOD's prime,  
The stream displays the rage of time:  
Wild lightnings play: mad thunders roar:  
The waves dash furious 'gainst the shore.  
What now, O God! through this stern strife,  
Can keep the voyager, save his life?  
What, but Thy blessing and Thy care,  
Who hear'st the troubled voyager's prayer."

#### OLD AGE.

The voyager, with hoary head, has reached the point where the waters of time and eternity mingle together. The hour-glass is gone. The old man is on his knees, with clasped hands and eyes turned heavenward. The angel is hovering just above him to transport him home, while countless angel faces look down upon him, "and above all

shines the benign light of the Cross."

"With Awe what brighter scenes appear!  
Behold! the harbor now is near,  
And sailing now a calmer tide,  
The radiant angel close beside,  
The voyager now, with straining eyes  
Enrapt, the glorious port descries:  
While o'er the dark, receding storm,  
Bright breaks the light of endless morn."

- 2 Jerusalem, Ancient and Modern. Two Slides.... \$5.00  
From Selou's Celebrated Paintings.

#### JERUSALEM IN HER GRANDEUR.

This painting represents the city after it had been rebuilt by Herod the Great, and during the lifetime of our Saviour.

#### JERUSALEM IN HER DECAY.

The general features of the landscape remain the same. The Temple, resplendent in snowy marble and gold, has given place to the Mosque of Omar, and the dreary inclosure of the Harem.

A descriptive book and key of Selou's two grand pictures, containing a detailed account

of nearly two hundred points of interest in Jerusalem, will be furnished for 30 cents.

- 3 Longfellow's Hiawatha, with poem. Per Slide.....\$2.50  
a Hiawatha's Wooing.  
b Hiawatha's Wedding.  
c The death of Minnehaha.  
d Hiawatha's Departure.
- 4 Abou Ben Adhem. Two Slides, with poem.....\$1.00
- 5 Origin of the Moss Rose. Four Slides, with poem.....\$10.00
- 6 Set of the Four Seasons. Per Slide.....\$2.50  
a Spring c Autumn  
b Summer d Winter
- 7 The Shipwrecked Mariners' Hope. Two Slides.....\$5.00  
Cast upon the rocks are seen the two survivors of a shipwreck; the first glimmer of dawn reveals a ship in the distance. Morning breaks and the ship now approaches them.
- 8 The Way of Salvation. Four Slides.....\$10.00  
Upon searching the Holy Writ and becoming convinced of the error of her ways, the repentant sinner knocks at the gate; then led by Jesus through the Dark Valley, she arrives on the shores of the Beautiful River.

#### EFFECT SLIDES, WITH REVOLVING MOTION.

- 1 The Bee Hive.....\$5.00  
The hive surrounded with flowers, bees in motion.
- 2 The Aquarium.....\$5.00  
The globe is surrounded by crimson and blue curtains. By a revolving motion gold and silver fish swim around.
- 3 The Fountain.....\$5.00  
The water appears to flow from a beautiful vase and fall into the basin below.
- 4 The Wind Mill.....\$5.00  
The sails are seen revolving.
- 5 The Wheel of Life.....\$7.00  
With four designs: The Skaters, the Fishes, the Bottle, the Ladder.
- 6 Dancing Skeleton.....\$6.00
- 7 Moon Rising. One Slide..\$3.50  
Can be adapted to dissolve with any slide.
- 8 Rainbow. One Slide.....\$3.50
- 9 Lightning Effect.  
One Slide.....\$3.50
- 10 Falling Snow.....\$3.00
- 11 The Cause of Spring and Neap Tides, and the Moon's phases during its Revolution.....\$5.00
- 12 The Earth's Rotundity shown by a ship sailing around the globe.....\$5.00
- 13 The Rotation of the Earth on its Axis.....\$5.00
- 14 The Various Eclipses of the Sun, with the Transit of Venus.....\$5.00
- 15 The Various Eclipses of the Moon.....\$5.00
- 16 Newton's Disk for showing re-composition of colors...\$8.00

# Marcy's Sclipticon Catalogue.

PART THIRD.

PLAIN GLASS SLIDES.

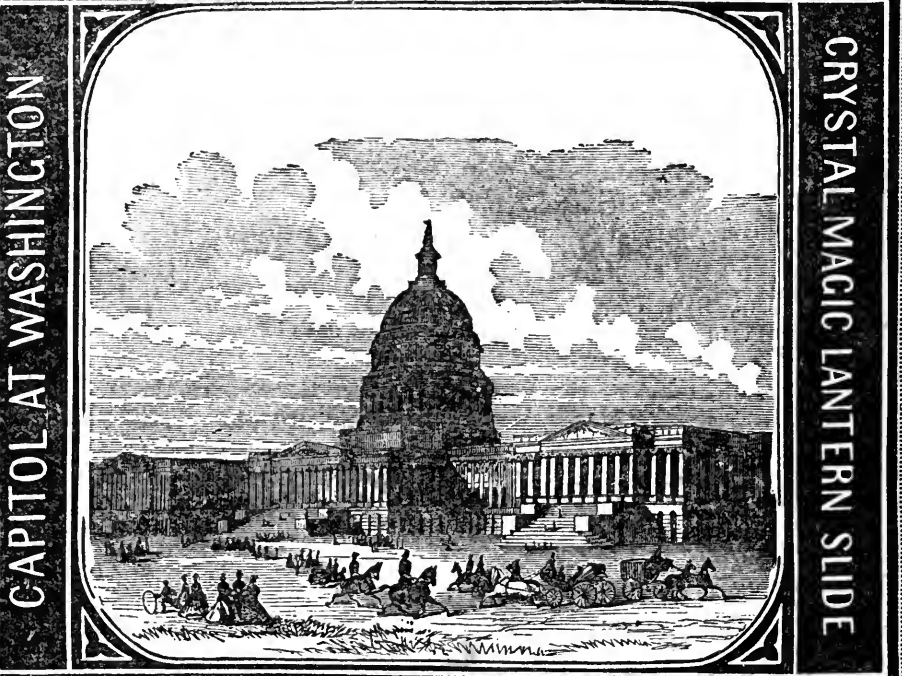

The above cut shows the exact size and shape of the transparency, the mat, the glass, and the binding of the Woodbury, the American, and the Scientific Sclipticon Slides. In French slides the lateral measure of the transparency is a little less.

In reducing the prices of plain glass slides to the following extremely low rates, our difficulty is very greatly augmented by our anxiety to sell only such as are unexceptionable in quality. In selecting our supply our chief solicitude will be in the future, as it has been in the past, to get hold of only the slides that will prove satisfactory to customers and creditable to the Sclipticon.

In revising these lists we have reference to our best sources of supply, to a wide distribution of subjects, and to limiting the enumeration to what is most desirable. Views of every variety in the market, whether herein enumerated or not, will be furnished at the cheapest rates.

Any of the following class, unless exceptionally rare or difficult to obtain, are priced as below.

### Class XL. American Views.

PER SLIDE, 50 CENTS.

#### NEW ENGLAND.

- |    |  |    |   |
|----|--|----|---|
| 1  | Lewiston, Maine.                       | 35 | Jacob's Ladder.                         |
| 2  | Continental Cotton-Mill, Lewiston, Me. | 36 | Diana's Bath, N. Conway, N. H.          |
| 3  | Post Office, Portland, Me.             | 37 | Artist's Falls, "                       |
| 4  | City Hall, "                           | 38 | Falls of the Ammonoosuc.                |
| 5  | United States Hotel, Portland.         | 39 | Gorham, N. H.                           |
| 6  | Panorama of Portland.                  | 40 | Centre Harbor, N. H.                    |
| 7  | Franconia Mountains, N. H.             | 41 | Lake Winnipiseogee.                     |
| 8  | Walker's Falls.                        | 42 | Daniel Webster's Place, Franklin, N. H. |
| 9  | Profile Lake.                          | 43 | Bethlehem, N. H.                        |
| 10 | Echo "                                 | 44 | Littleton, N. H.                        |
| 11 | Flume.                                 | 45 | Montpelier, Vt.                         |
| 12 | Suspended Boulder Flume.               | 46 | Newbury, Vt.                            |
| 13 | Pool.                                  |    |   |
| 14 | Profile House.                         |    | BOSTON, MASS., Etc.                     |
| 15 | Lonesome Lake.                         | 47 | Panorama of Boston.                     |
| 16 | Mt. LaFayette.                         | 48 | View of Boston Harbor.                  |
| 17 | White Mountains, N. H.                 | 49 | Navy Yard, Boston.                      |
| 18 | Mt. Washington.                        | 50 | Washington Street, Boston.              |
| 19 | " Signal Station.                      | 51 | Old South Church.                       |
| 20 | Summit House, White Mountains, N. H.   | 52 | Old State House.                        |
| 21 | Tip Top House, White Mountains, N. H.  | 53 | Quincy Market.                          |
| 22 | Carriage Road, White Mountains, N. H.  | 54 | Faneuil Hall.                           |
| 23 | Glen House, White Mountains, N. H.     | 55 | Bunker Hill Monument.                   |
| 24 | Silver Cascade, Crawford Notch.        | 56 | New State House.                        |
| 25 | Willey House.                          | 57 | Parker House.                           |
| 26 | " Family Furniture.                    | 58 | Tremont "                               |
| 27 | Crawford House.                        | 59 | Masonic Temple.                         |
| 28 | Pulpit Rock.                           | 60 | Boston Common.                          |
| 29 | Bridal Veil Falls.                     | 61 | The Old Elm, Boston Common.             |
| 30 | Frozen Fountain (30 ft. high).         | 62 | Public Gardens, Boston.                 |
| 31 | Frozen Falls.                          | 63 | The Brewer Fountain.                    |
| 32 | Mt. Washington Railway.                | 64 | Ether Monument.                         |
| 33 | Fabyan House.                          | 65 | Statue of Washington.                   |
| 34 | Twin Mountain House, Carroll, N. H.    | 66 | Commonwealth Avenue.                    |
|    |  | 67 | Summer Street.                          |
|    |  | 68 | Hanover "                               |
|    |  | 69 | Church of the Immaculate Conception.    |
|    |  | 70 | City Hall.                              |

- 71 Sea View House, Martha's Vineyard.  
 72 Gray Head Light House, Martha's Vineyard.  
 73 The Miles Standish House, Duxbury, Mass.  
 74 Plymouth, Mass.  
 75 Fall River, Mass.  
 76 American Print Works, Fall River.  
 77 State House, Newport, R. I.  
 78 Statue of Com. Perry, "  
 79 The Old Stone Mill, "  
 80 Ocean House, "  
 81 View of the Beach, "  
 82 Purgatory, "  
 83 Hanging Rocks, "  
 84 Steamer Bristol. "

## NEW YORK.

- 85 Broadway, from the Post Office.  
 86 The New Post Office.  
 87 City Hall.  
 88 The Tribune Building.  
 89 The Staats Zeitung Building.  
 90 The New York Times "  
 91 The New York Herald "  
 92 The Equitable Insurance Building.  
 93 Trinity Church.  
 94 Wall Street.  
 95 Fulton Ferry.  
 96 East River Bridge.  
 97 Grand Central Hotel, Broadway.  
 98 Stewart's Retail Store, Broadway.  
 99 Grace Church, Broadway.  
 100 Young Men's Christian Association Building.  
 101 Booth's Theatre.  
 102 The Masonic Temple.  
 103 Grand Opera House.  
 104 Astor Library.  
 105 Mercantile Library.  
 106 Cooper Institute.  
 107 Bible House.  
 108 Normal College.  
 109 Columbia College.  
 110 Worth Monument.  
 111 Windsor Hotel.  
 112 The Fountain, Central Park.  
 113 The Terrace, "  
 114 The Lake, "  
 115 Goat Team, "  
 116 Auld Lang Syne, "

## BROOKLYN.

- 117 Plymouth Church.  
 118 Prospect Park.  
 119 Oak Bridge, Prospect Park.  
 120 Echo "

- 121 Nethermead Arches, Prospect Park

## GREENWOOD CEMETERY.

- 122 Entrance Greenwood Cemetery.  
 123 Monument, James Gordon Bennett.  
 124 Monument, Miss Charlotte Canda.  
 125 Monument, Professor Morse.  
 126 " Niblo's Tomb.

## HUDSON RIVER, ETC

- 127 The Palisades.  
 128 The Tappan Zee.  
 129 Entrance to the Highlands.  
 130 West Point.  
 131 View North from West Point.  
 132 Catskill Falls.  
 133 Suspension Bridge, Hudson River.  
 134 Upper Hudson.  
 135 Jam of Logs on the Upper Hudson.  
 136 Birmingham Falls.  
 137 Glen's Falls.  
 138 Lake George.  
 139 " View at Bolton.  
 140 Ganousky Bay, Lake George.  
 141 Fort Wm. Henry Hotel, Lake George.  
 142 Fort Ticonderoga, Lake George.  
 143 Schrom Lake, from Leland's.  
 144 " Boat Landing.  
 145 Indian River, Adirondacks.  
 146 Eagle's Nest Lake, "  
 147 Hunter's Camp, Blue Mountain Lake.

## SARATOGA.

- 148 Grand Union Hotel.  
 149 " " Interior.  
 150 Congress Spring,  
 151 Empire "  
 152 High Rock "  
 153 Star "  
 154 United States Hotel.  
 155 Saratoga R. R. Depot.  
 156 Saratoga Lake.

## NIAGARA FALLS.

- 157 Point View, American and Horse Shoe Falls.  
 158 Terrapin Tower, Winter.  
 159 Ice Mound and American Fall.  
 160 American Fall from Goat Island.



- 161 Horse Shoe Fall from Clifton House.  
 162 Rapids above the Falls.  
 163 " below "  
 164 The Whirlpool Rapids.  
 165 Horse Shoe Fall from below.  
 166 Ice Bridge and Horse Shoe Fall.  
 167 Hermit's Cascade, and First Sister Island.  
 168 Suspension Bridge and Falls.  
 169 " "  
 170 " Interior.  
 171 Winter View from Prospect Point.  
 172 New Suspension Bridge.  
 173 Luna Island " "  
 174 Under the Banks.  
 175 Table Rock, Winter.  
 176 Frost Work Luna Island.  
 177 View in Front of the Cave of the Winds.  
 178 Moonlight View of the Falls.
- WATKIN'S GLEN, N. Y.**
- 179 Entrance Amphitheatre.  
 180 Lower Falls.  
 181 Still-Water Gorge.  
 182 Central View and Minnehaha.  
 183 Cavern Cascade and Long Staircase.  
 184 Mystic Gorge.  
 185 Glen Mountain House on North Cliff.  
 186 Cathedral Bridge and Butter-milk Falls  
 187 Central Staircase and Mammoth Falls.  
 188 Central Falls.  
 189 Looking down Glen Cathedral.  
 190 Rainbow Falls, from below.  
 191 Rainbow Falls and Triple Cascade.  
 192 Frowning Cliff, distant view.  
 193 Frowning Cliff and Narrow Pass.  
 194 Gothic Arch of Hope's Studio.  
 195 Pluto Falls.  
 196 Artist's Dream.  
 197 Elfin Gorge and Fairy Pool.
- NEW JERSEY.**
- 198 Princeton College, Princeton, N. J.  
 199 Passaic Falls, Paterson, N. J.
- PHILADELPHIA, PA., ETC.**
- 200 Custom House.  
 201 Post Office.  
 202 Independence Hall.  
 203 " " Interior.
- 204 Old Independence Bell.  
 205 Carpenters' Hall.  
 206 Old Christ Church.  
 207 Old Swedes' Church.  
 208 Girard College.  
 209 U. S. Mint.  
 210 Masonic Temple.  
 211 Arch Street M. E. Church.  
 212 Academy of Fine Arts.  
 213 " Music.  
 214 St. George's Hall.  
 215 Horticultural "  
 216 Union League.  
 217 La Pierre House.  
 218 New Public Buildings.  
 219 Ledger Building.  
 220 Wood's Museum.  
 221 Continental Hotel.  
 222 Cathedral St. Peter and St. Paul.  
 223 Girard Avenue Bridge.  
 224 Chestnut Street "  
 225 University of Pennsylvania.  
 226 Fairmount Park.  
 227 Steamboat Landing, Fairmount Park.  
 228 Connecting R. R. Bridge.  
 229 Fairmount Water Works.  
 230 Pavilion and Basin.  
 231 Belmont Mansion.  
 232 Benedict Arnold's House.  
 233 Lemon Hill Mansion.  
 234 Penn " "  
 235 Rockland " "  
 236 The Solitude  
 237 Iron Spring Fountain.  
 238 Graff Monument.  
 239 Lincoln "  
 240 Music Stand.  
 241 Grant's Cabin.  
 242 Sweet Brier Heights.  
 243 Lovers' Walk  
 244 Mineral Spring.  
 245 The Wissahickon.  
 246 Old Mill, Wissahickon.  
 247 Red Bridge, "  
 248 Laurel Hill Cemetery.  
 249 Entrance to Laurel Hill.  
 250 Chapel, "  
 251 Cresson Monument.  
 252 Old Mortality.  
 253 Entrance to Mount Vernon Cemetery.  
 254 Gardell Monument, Mt. Vernon.  
 255 Entrance to Woodland.  
 256 Bailey Monument.  
 257 Delaware River (Instantaneous).  
 258 Chew House, Germantown Battle Ground.  
 259 Washington's Headquarters, Valley Forge.  
 260 View of Cattle and Meadow, Media, Pa

- 261 Delaware Water Gap.  
 262 Indian Ladder Bluff.  
 263 Mauch Chunk, General View.  
 264 Mt. Pisgah, Mauch Chunk.  
 265 Mauch Chunk and Glen Onoko.  
 266 Terrace Falls, Glen Onoko.  
 267 Onoko Falls.  
 268 Dual Cascade.  
 269 Lehigh River, Dam and Rail Road.  
 270 Saw Mill, Cresson, Pa.

## DELAWARE.

- 271 Old Swedes' Church, Wilmington.

## BALTIMORE, MD.

- 272 Battle Monument.  
 273 Washington "  
 274 Peabody Institute.  
 275 City Hall.

## WASHINGTON, D.C., Etc.

- 276 The Capitol, full view.  
 277 " front "  
 278 Interior of the Dome.  
 279 The Marble Room.  
 280 Statue of Lincoln.  
 281 The Senate, Exterior.  
 282 " Interior.  
 283 House of Representatives, Exterior.  
 284 House of Representatives, Interior.  
 285 Treasury Building.  
 286 Marble Cash Room.  
 287 Post Office.  
 288 Patent Office.  
 289 " Interior.  
 290 The White House.  
 291 Red Room, White House.  
 292 Equestrian Statue of Gen. Jackson.  
 293 Smithsonian Institute.  
 294 Agricultural Building.  
 295 Market Square.  
 296 Statue of Gen. Scott.  
 297 Natural Bridge, Va.  
 298 View near White Sulphur Springs, Va.  
 299 Tomb of Washington, Mount Vernon.  
 300 Washington's Mansion, Mt. Vernon.  
 301 Ten Sided Barn Built for Washington.  
 302 Washington Monument, Richmond, Va.

## CHARLESTON, S. C.

- 303 Northeast from St. Michael's Church.  
 304 Broad Street and Ashley River.  
 305 North from St. Michael's Ch.  
 306 From South Battery.  
 307 Fort Sumpter and Castle Pinckney.  
 308 East from St. Michael's.  
 309 Chapel, Magnolia Cemetery.  
 310 Hayne's Monument.  
 311 Charleston Hotel  
 312 Mills House.  
 313 King Street.

## SAVANNAH, GA.

- 314 Liberty Street.  
 315 Bull "  
 316 Exchange.  
 317 Savannah River, Looking Down.  
 318 Savannah River, Looking Up.  
 319 Pulaski Monument.  
 320 View in Bonaventura Cemetery.  
 321 Tomb in Bonaventura Cemetery.

## FLORIDA.

- 322 St. James' Hotel, Jacksonville.  
 323 Bay Street and National Hotel, Jacksonville.  
 324 Stanton Institute for Colored Children, Jacksonville.  
 325 Panorama St. Augustine.  
 326 Old Cathedral, St. Augustine.  
 327 Fort San Marco, "  
 328 Palmetto Trees, near St. John's River.  
 329 Oranges.  
 330 The Plaza, St. Augustine.  
 331 St. Francis Street and Date Palm, St. Augustine.  
 332 Charlotte Street, St. Augustine.  
 333 Residence of Harriet Beecher Stowe, near Jacksonville.  
 334 Florida Winter House, Arlington Bluffs, near Jacksonville.  
 335 Green Cove Springs, near Jacksonville.  
 336 Clarendon House, Green Cove Springs.  
 337 State House, Tallahassee.  
 338 Market " "

## NEW ORLEANS, LA., ETC.

- 339 General View.  
 340 Levee and Steamers.  
 341 Steamer R. E. Lee.  
 342 Ferry Boat Louise.  
 343 State House.  
 344 Christ Church.  
 345 Opera House.  
 346 Custom "  
 347 City Hall.  
 348 French Cathedral.  
 349 St. Charles' Hotel.  
 350 St. James' "  
 351 Jackson Square.  
 352 Canal Street.  
 353 Charter "  
 354 Camp "  
 355 Four Panoramic Views from  
 St. Patrick's Cathedral, look-  
 ing N. N. E., N. W., S. W.  
 356 Vicksburg, Miss.  
 357 Memphis, Tenn., General  
 View.

## CINCINNATI, O.

- 358 Burret House.  
 359 Grand Hotel.  
 360 Court House.  
 361 Inclined Plane.  
 362 Lookout House.  
 363 Tyler-Davidson Fountain.  
 364 Suspension Bridge.  
 365 Steamers and Bridge.  
 366 Interior of Steamer.

## CHICAGO, ILL.

- 367 Chicago River and Shipping.  
 368 Michigan Avenue, Chicago.  
 369 Cattle Yards and Texas Cat-  
 tle, Chicago.  
 370 Clark Street, and the Ameri-  
 can Buffalo, Chicago.

## MINNESOTA.

- 371 St. Paul, Minn.  
 372 Falls of St. Anthony.  
 373 Minnehaha Falls, Summer.  
 374 " " Winter.

## WISCONSIN.

- 375 Dalles of the Wisconsin.  
 376 Devil's Chair, St. Croix River.  
 377 Fishermen on the "  
 378 Kinnickinick Falls, Wis.

## ST. LOUIS, MO.

- 379 Mississippi River Bridge, St.  
 Louis.

- 380 Steamer Great Republic, St.  
 Louis.  
 381 Saloon, Great Republic, St.  
 Louis.  
 382 Steamer Macomb (U. S. Snag  
 Boat).  
 383 Steamer and Bridge.  
 384 Levee and Shipping.  
 385 Southern Hotel.

UNION AND CENTRAL PA-  
CIFIC R. R., ETC.

- 386 Council Bluffs, Iowa.  
 387 Omaha, Neb.  
 388 Fremont City, Neb.  
 389 Pawnee Indians, Group.  
 390 " " Head Chief,  
 391 " " and Lodge.  
 392 Echo Cañon.  
 393 Pulpit Rock in Echo Cañon.  
 394 Witches' " "  
 395 The Devil's Slide.  
 396 Devil's Gate.  
 397 Weber Cañon.  
 398 Ogden "  
 399 "  
 400 Salt Lake City Panorama.  
 401 Mormon Tabernacle, Old and  
 New.  
 402 Old Mormon Tabernacle, In-  
 terior.  
 403 Residence of Brigham Young.  
 404 Main Street, Salt Lake City.  
 405 Virginia City.  
 406 Carson Valley and Van  
 Sickles Hotel.  
 407 Donner Lake, from Summit.  
 408 View from Buena Vista Peak.  
 409 Old Nick of the Woods (Lake  
 Tahoe).  
 410 Snow sheds.  
 411 " " Interior.  
 412 Summit of the Sierra Ne-  
 vadas, 10,000 feet  
 413 Teams Passing Through the  
 Snow.  
 414 American River from Cape  
 Horn.  
 415 Hydraulic and Placer Mining.

## CALIFORNIA, ETC.

- 416 Sacramento, Cal.  
 417 Stockton, Cal., Main Street.  
 418 San Francisco, Cal.  
 419 Chinese Joss House, Cal.  
 420 " " Interior  
 421 Seal Rocks.  
 422 Golden Gate from Telegraph  
 Hill.  
 423 Woodward's Gardens.  
 424 Digger Indians and Huts

## THE GEYSERS, ETC.

- 425 Entrance to Devil's Cañon.  
 426 Geysers Springs.  
 427 Looking up Devil's Cañon.  
 428 Geysers, Owens, Devil's Wash-  
 tub.  
 429 Geysers, the Steam Whistle.  
 430 The Devil's Tea Kettle.  
 431 Scene in Devil's Cañon.  
 432 Witches Caldron.  
 433 " and Devil's  
 Pulpit.

## YO-SEMITE VALLEY, ETC.

- 434 Inspiration Point.  
 435 Looking Down the Valley.  
 436 Cathedral Rocks.  
 437 El Capitan.  
 438 Mirror Lake.  
 439 Reflection of El Capitan.  
 440 Mirror View of Cathedral  
 Rocks.  
 441 Bridal Veil Falls.  
 442 Three Brothers, 4000 feet.  
 443 " Mirror View.  
 444 Cathedral Spires, 2600 feet.  
 445 Sentinel Rock.  
 446 Looking up the Valley.  
 447 Snow's Hotel.  
 448 The Three Graces.  
 449 Yosemite Indians.  
 450 The Lost Arrow.  
 451 North Dome and Washington  
 Tower.  
 452 North Dome and Cloud's Rest.  
 453 North and South Domes  
 454 " " R e -  
 flected.  
 455 Eagle Peak.  
 456 Cap of Liberty.  
 457 Yosemite Falls, 2600 feet  
 458 Lower "  
 459 "Our Party," Yosemite Val-  
 ley.  
 460 Nevada Falls, 700 feet.  
 461 Vernal Falls.  
 462 Ladder up Vernal Falls.  
 463 South Cañon Falls.  
 464 " Rapids.  
 465 Tenaya Falls.  
 466 Lake Tenaya.  
 467 Hoffman's Tower.  
 468 Volcanic Mountains.

## BIG TREES, ETC.

- 469 Clark's Hotel, Mariposa.  
 470 Grizzly Giant "  
 471 View of "  
 472 Big Trees, Mariposa Grove.  
 473 George Washington.  
 474 The Mother of the Forest.  
 475 The Fallen Monarch.

- 476 The Pioneer's Cabin.  
 477 Section of Original Big Tree.  
 30 feet diameter.

## MEXICO.

- 478 Aztec Idols.  
 479 Aztec Sacrificial Stone (60,000  
 human lives were sacrificed  
 upon this stone in one year.  
 —Prescott).  
 480 View in the City of Mexico.  
 481 Chapultepec.  
 482 Cathedral at Puebla.  
 483 Cathedral of Gaudaloupe.  
 484 Pyramid of Cholula.  
 485 Orizaba,  
 And 60 other views.

## BERMUDA ISLANDS.

- 486 View in Bermuda.  
 487 Fisherman's Home.  
 488 Heron Bay,  
 And 20 other views.

## CANADA.

- 489 City and Harbor, Montreal.  
 490 Panorama of "  
 491 Victoria Bridge, "  
 492 Montreal Bridge.  
 493 Grey Nunnery.  
 494 Victoria Statue, Montreal.  
 495 Wolf Monument, Quebec.  
 496 Wolf and Montcalm Monu-  
 ment.  
 497 Citadel from Queen's Wharf.  
 498 St. Lawrence River from Cita-  
 del.  
 499 Point Levi from Quebec.  
 500 Montmorenci Falls, Vicinity  
 of Quebec.  
 501 Indian Village, Lorette.  
 502 Parliament Building, Ottawa.  
 Four Views.  
 503 Canadian Cottage.  
 504 Canadian School House;  
 And other views.

## STATUARY.

- 505 Council of War.  
 506 Country Post Office.  
 507 Charity Patient.  
 508 Mother and Babe.  
 509 Feed my Lambs.  
 510 Rebecca at the Well.  
 511 Town Pump.  
 512 Union Refugees.  
 513 Wounded Scout.  
 514 Ino and Bacchus.  
 515 The Returned Volunteer.  
 516 Young England.  
 517 Old "

## Class XLI. Foreign Plain Slides.

PER SLIDE, 60 CENTS.

In the following carefully selected list of foreign views, we have observed a continuous arrangement, easy to refer to, and readily divided up into lantern journeys for private entertainments or public exhibitions. See list of descriptive lectures, Introduction, p. 25.

### ENGLAND AND SCOTLAND.

- 1 The Journey Across.
- 2 The Docks, Liverpool.
- 3 Castle Street, " "
- 4 House of Parliament.
- 5 Westminster Abbey, Interior.
- 6 " " Exterior.
- 7 Buckingham Palace.
- 8 Blue Room, Buckingham.
- 9 Promenade Gallery, " "
- 10 Throne, " "
- 11 Gallery of Paintings, " "
- 12 Grand Staircase, " "
- 13 Drawing Room, " "
- 14 St. Paul's Cathedral.
- 15 The Horse Guards.
- 16 Mansion House, Lord Mayor's Residence.
- 17 Somerset House.
- 18 Windsor Castle, London.
- 19 Corridor, Windsor
- 20 Red Room, " "
- 21 Reception Room, Windsor.
- 22 Throne " "
- 23 Tower of London.
- 24 Kensington Gardens.
- 25 Temple Bar.
- 26 Trafalgar Square.
- 27 Waterloo Place.
- 28 Bank of England.
- 29 Greenwich Observatory.
- 30 Greenwich Hospital.
- 31 The Custom House.
- 32 Smithfield Martyrs' Memorial Church.
- 33 Albert Memorial.
- 34 The Albert Memorial—  
     *a* Europe, by McDowel.  
     *b* Asia, by Foley.  
     *c* Africa, by Theed.  
     *d* America, by Bell.
- 35 The Thames Embankment.
- 36 Osborne House, Isle of Wight.
- 37 The Corridor, Osborne House.
- 38 Statue of Queen Victoria.
- 39 View of Cowes.
- 40 " Ventnor.
- 41 Carrisbrook Castle.
- 42 Balmoral Castle, Scotland.
- 43 Panorama of Edinburg.
- 44 Calton Hill, " "
- 45 Monument to Sir Walter Scott
- 46 Holyrood Castle.
- 47 Ruins of Chapel at Holyrood.

- 48 Melrose Abbey.
- 49 Lake Katrine.
- 50 Lake Lomond.
- 51 Rumbling Bridge at Dunkeld.
- 52 Trossacks and Benvenue.
- 53 Trossack's Hotel and Benvenue.

### FRANCE, SPAIN AND PORTUGAL.

- 54 Panorama of Paris.
- 55 Panorama of Eight Bridges.
- 56 Church of the Madeleine.
- 57 New Opera House.
- 58 The Bourse (the Exchange).
- 59 Rue de Rivoli.
- 60 Place de la Concorde.
- 61 Hotel de Ville.
- 62 The Tower of St. James.
- 63 Museum of the Louvre.
- 64 Room of Cariatides.
- 65 Assyrian Room, Museum of the Louvre.
- 66 Statue of the Nile.
- 67 Gallery of the Venus de Milo.
- 68 Statue of Diana, Museum of the Louvre.
- 69 Love and Psyche, by Canova.
- 70 Gallery of Paintings.
- 71 Palace of the Tuilleries.
- 72 Gallery of Diana, Tuilleries.
- 73 Throne Room, " "
- 74 Room of Apollo " "
- 75 Room of Peace.
- 76 Place Vendôme.
- 77 Triumphant Arch de l'Étoile.
- 78 Corps Legislative.
- 79 Pantheon.
- 80 Grand Hotel.
- 81 Royal Palace.
- 82 Place de la Concorde.
- 83 Arch of the Carousel.
- 84 Palace of the Corps Legislative.
- 85 Palace of the Institute.
- 86 Palace of Justice.
- 87 Palace of Luxembourg.
- 88 Throne Room, Luxembourg.
- 89 Luxembourg Chapel, Int.
- 90 Statue of Hope, by Lemoine.
- 91 Fountain de Medici, Luxembourg.
- 92 The Room of the Senate.
- 93 Holy Chapel.

- 94 The Invalides,  
 95 Tomb of Napoleon I.  
 96 Church of St. Augustine.  
 97 Church of St. Augustine, Int.  
 98 St. Germain l'Auxerrois.  
 99 St. Germain l'Auxerrois, Int.  
 100 Trinity Church.  
 101 St. Stephen of the Mount.  
 102 The Pantheon.  
 103 St. Vincent de Paul.  
 104 The Palace Royal.  
 105 Cathedral Notre Dame.  
 106 Cathedral Notre Dame, Int.  
 107 Palace Versailles.  
 108 Park " "  
 109 Gallery of Tombs, Versailles.  
 110 Gallery of the Warriors, " "  
 111 Mirror Gallery, " "  
 112 Gallery of Battles, " "  
 113 Grand Trianon Palace.  
 114 Saloon of Marie Antoinette.  
 115 Room of Malachites  
 116 Empress Josephine's Bed.  
 117 Queen Victoria's Chamber.  
 118 Castle of Fontainebleau.  
 119 Bed Chamber of the Emperor.  
 120 Bed Chamber of the Empress.  
 121 Bed Chamber of Pope Pius VII.  
 122 Room of the Apartments of  
 Pope Pius VII.  
 123 Lake and Castle Pierrefonds.  
 124 Castle Maintenon.  
 125 Castle Pierrefonds.  
 126 Castle of Chambord  
 127 Castle of Azay le Rideau.  
 128 Panorama of Madrid.  
 129 Palace of the Cortes, Madrid.  
 130 Fountain of Seasons.  
 131 Queen's Palace.  
 132 Queen's Room, Escorial.  
 133 Court of Lions, Alhambra.  
 134 Fountain of Lions.  
 135 Grenada.  
 136 Colonnade of Pilate's House,  
 Seville.  
 137 Fountain, Pilate's House, Se-  
 ville.  
 138 Palace of the Duke de Mont-  
 pensier.  
 139 Cathedral of Toledo.  
 140 Alcazar Segovia.  
 141 Cuenca.  
 142 Market Place, Cordova.  
 143 Malaga.  
 144 Cadiz.  
 145 Barcelona.  
 146 Gallery of Statues, Aranjuez.  
 147 Gallery of Statues, Casa del  
 Labrador.  
 148 Lisbon, Portugal.
- SWITZERLAND.
- 149 Schaffhausen.  
 150 The Falls of the Rhine.
- 151 Zurich.  
 152 St. Gall.  
 153 Lucerne.  
 154 Lion of Lucerne.  
 155 Weggis.  
 156 Fluellen.  
 157 Hospice St. Gothard.  
 158 Devil's Bridge, St. Gothard.  
 159 View of Goeschine Uri, St.  
 Gothard.  
 160 Andermat.  
 161 Airolo.  
 162 Entrance to the Tunnel, St.  
 Gothard.  
 163 Gallery of Stalvedro, St. Go-  
 thard.  
 164 The Rhigl.  
 165 Glacier of the Rhine.  
 166 Village of Simplon.  
 167 Hospice and Lake of Grimsel.  
 168 The Gorge of the Aar at Han-  
 deck.  
 169 The Falls of the Handeck.  
 170 Meyringen.  
 171 Falls of the Reichenbach.  
 172 Rosenlaur.  
 173 Baths of Rosenlaur.  
 174 Wellhorn and Wetterhorn.  
 175 The Grindelwald Glacier.  
 176 View at Grindelwald.  
 177 Mer de Glace.  
 178 Tête Noir.  
 179 Staubach Falls.  
 180 Engleberg.  
 181 Interlaken.  
 182 Falls of the Giesbach.  
 183 Lake Thun.  
 184 Thun.  
 185 Castle Rougemont, Lake  
 Thun.  
 186 The Gemmi Pass.  
 187 Valley of Zemat.  
 188 Monte Rosa.  
 189 The Gorner Glacier.  
 190 Mt. Cervin, on the Matter-  
 horn.  
 191 Martigny.  
 192 Unterseen.  
 193 Gorge of the Trent.  
 194 Hospice Great St. Bernard.  
 195 Sion.  
 196 Louche les Bains.  
 197 Dangerous Passage of the Bos-  
 sons.  
 198 Valley of Chamouni.  
 199 Ascent of Mt. Blanc.  
 200 Chamouni and Mt. Blanc.  
 201 Summit of the Buet.  
 202 Tifenkasters Grisons.  
 203 Chateau of Ortenstein.  
 204 Pfoeffers.  
 205 Baths of Pfoeffers.  
 206 Gorge of the Tamina.  
 207 Anney.  
 208 Hotel and Baths, St. Gervais.

- 209 View of the Muotta.  
 210 Lausanne.  
 211 Geneva.  
 212 Castle of Chillon.  
 213 Fribourg.  
 214 Berne.  
 215 Statue of Rodolph of Erlach  
 Berne.

## GERMANY—THE RHINE.

- 216 Bridge and Quay of Cologne.  
 217 Cologne from Deutz.  
 218 Cathedral of Cologne.  
 219 Bonn.  
 220 The Seven Mountains.  
 221 Drachenfels.  
 222 The Godesberg Castle.  
 223 Andernach.  
 224 Coblentz.  
 225 Ehrenbrelstein.  
 226 The Stolzenfels.  
 227 The Castle Maxburg.  
 228 Boppard.  
 229 Bornhofen and the Two  
 Brothers.  
 230 Le Souris (the Mouse) Castle  
 and the Rhine.  
 231 Tower of the Cat  
 232 The Cat and the Lorlei.  
 233 The Rhinefels.  
 234 Castle Reinfels.  
 235 St. Goar and St. Goarhausen.  
 236 Reichenberg.  
 237 Oberwesel.  
 238 Schoenburg.  
 239 Gutenfels.  
 240 Pfalz, Caub and Gutenfels.  
 241 Bacharach.  
 242 The Castle of Furstenberg.  
 243 Lorch.  
 244 Heimbach and Castle Heim-  
 berg.  
 245 The Castle of Sonneck.  
 246 The Castle of Reinstein.  
 247 The Castle of Falkenberg.  
 248 The Castle of Ehrenfels.  
 249 Bingen.  
 250 The Tower of Rats, Bingen.  
 251 Rudesheim.  
 252 The Palace at Biebreich.  
 253 Wiesbaden.  
 254 Mayence.  
 255 The Cathedral of Mayence.  
 256 Isle of Nonenthworth.  
 257 Kreuznach.  
 258 Frankfort-on-the-Main.  
 259 Monument to Guttenberg.  
 260 The Synagogue, Frankfort.  
 261 Hamburg.  
 262 Arcades, Hamburg.  
 263 Mannheim.  
 264 Heidelberg.  
 265 Ruined Tower, Heidelberg.  
 266 Baden Baden.

## ITALY.

- 267 Panorama of Genoa.  
 268 Panorama of Florence.  
 269 Statue of Dante and Church of  
 the Holy Cross.  
 270 Palace Pitti.  
 271 The Uffizi Gallery.  
 272 Fountain of Neptune, Boboli  
 Garden.  
 273 Gallery of Offices.  
 274 Room of Niobe.  
 275 Tomb of Julian de Medici.  
 276 The Campanile and Cathedral.  
 277 Church of the Grand Madre de  
 Dios Turin.  
 278 Panorama of Pisa.  
 279 The Leaning Tower of Pisa.  
 280 The Baptistry, Cathedral and  
 Leaning Tower.  
 281 Campo Santo, Exterior.  
 282 " Interior.  
 283 Panorama of Venice.  
 284 Venice from the Bridge Canon-  
 ica.  
 285 The Arsenal.  
 286 Bridge of Sighs.  
 287 Ducal Palace.  
 288 Giant's Staircase—Side.  
 289 " —Front.  
 290 La Loggia.  
 291 Palace of the Foscari.  
 292 St. Mark's Church.  
 293 St. Mark's and Ducal Palace.  
 294 The Bridge of the Rialto.  
 295 The Piazzetta.  
 296 Palace Vendramin.  
 297 " Cavalli.  
 298 " La Ca d'Oro.  
 299 Street in Venice.  
 300 Panorama of Milan.  
 301 Cathedral of Milan.  
 302 " " —Interior.  
 303 The Simplon Arch— " "  
 304 Cathedral of Verona.  
 305 Statue of William Tell, at Lu-  
 gano.  
 306 Lake Como.  
 307 Panorama of Bellagio.

## ROME.

- 308 Panorama of Rome.  
 309 Rome from the Tiberine Isle.  
 310 Bridge and Castle of St. An-  
 gelo.  
 311 Cathedral of St. Peter's.  
 312 " " Int'r.  
 313 The Chair of St. Peter.  
 314 Genius of Death, by Canova.  
 315 Statue of Moses, by M. Angelo.  
 316 The Vatican and Obelisk,  
 front of St. Peter's.  
 317 Library of the Vatican—Int'r.  
 318 Gallery of Maps.





## COPENHAGEN.

- 421 Thorwaldsen's Museum, Copenhagen.  
 422 Statuary, by Thorwaldsen.  
 423 Ganymede with the Cup.  
 424 Ganymede and the Eagle of Jupiter.  
 425 Night.  
 426 Morning.  
 427 Christ.  
 428 The Apostles, 1.  
 429 " " 2.  
 430 St. John Preaching.  
 431 Statue of Thorwaldsen.  
 432 Panorama of Christiana.  
 433 View on the Canal, "  
 434 Royal Palace, "  
 435 The University, "  
 436 Cathedral of Upsala, Sweden.  
 437 The Royal Palace, Stockholm.  
 438 The Church of St. Catharine.  
 439 The Mose Backe.

## RUSSIA.

- 440 Panorama of St. Petersburg.  
 441 Winter Palace.  
 442 Statue of Peter the Great.  
 443 The Marble Palace.  
 444 Alexander Theatre.  
 445 St. Peter's Church.  
 446 Castle of Peterhoff.  
 447 Imperial Library.  
 448 St. Catharine's Church.  
 449 Church of St Nicholas.  
 450 " " Casan.  
 451 Cascades of the Isle of Olga.  
 452 The Kremlin, Moscow.  
 453 The Emperor's Cannon, and the Baravidski Gate.  
 454 The Great Bell.

## CITIES OF SOUTHEASTERN EUROPE.

- 455 Constantinople.  
 456 The New Palace of the Sultan.  
 457 The Arsenal.  
 458 The Mosque of Sultan Soliman.  
 459 Gate of the Minarets at Galata.  
 460 Palace of Dolma Baytche.  
 461 Mosque of Sultan Achmet.  
 462 St. Sophia and the Ottoman Door.  
 463 Palace of the Sublime Porte.  
 464 Castle of Asia, Bosphorus.  
 465 The Golden Horn.  
 466 Mosque of Faeth.  
 467 Fountain of Top Khanl.  
 468 Porch at the Entrance of the Harem, Old Seraglio.

- 469 Therapia, Banks of the Bosphorus.

## GREECE.

- 470 Athens and Mars Hill.  
 471 The Acropolis, the Summit Crowned with the Parthenon.  
 472 The Parthenon.  
 473 The Portico of Adrian and Acropolis.  
 474 The Ruins of Athens.  
 475 Modern Athens.  
 476 Salzburg.  
 477 Statue of Mozart.  
 478 Cathedral, Salzburg.  
 479 Panorama of Innsbruck.  
 480 La Neustadt, New Street, Innsbruck.  
 481 Mill and Gorge of Zwieselstein, Ebzthot, Tyrol.  
 482 Vienna, View of the Graben.  
 483 Imperial Palace, Vienna.  
 484 Church of St. Charles Borromeo, Vienna.  
 485 The Belvidere.  
 486 Vienna Exposition Buildings.  
 487 St. Stephen's Church.  
 488 The Imperial Palace, Schonbrunn.  
 489 The Fountains, Schonbrunn.  
 490 Prague, Panorama, the Neustadt.  
 491 The Hradschin, Prague.  
 492 Museum of Sculpture, Munich.  
 493 Museum of Painting.  
 494 Bavaria and Rhumschalle.  
 495 Ratisbon.  
 496 Passau on the Danube.  
 497 Nuremberg.  
 498 Old Houses, Nuremberg.  
 499 Statue of Melancthon.  
 500 House of Albert Durer.  
 501 The Beautiful Fountain.  
 502 Panorama of Stuttgart.  
 503 Dresden, the Bridge.  
 504 Statue of Frederic Augustus, Dresden.

## EGYPT.

- 505 Cleopatra's Needle, Alexandria.  
 506 Pompey's Pillar.  
 507 On, or Heliopolis.  
 508 The Nile Boat.  
 509 Interior of a Nile Boat.  
 510 Bridge on the Nile.  
 511 Citadel, Cairo.  
 512 Street in Cairo.  
 513 Tombs of the Calliphs  
 514 Mosque of Amrou.

- |  |   |
|--|---|
| 515 Fountain of Ablutions, Amrou.            | 552 Tomb of St. James and Zacharias, Valley of Jehoshaphat. |
| 516 Mosque of El Moyed, Amrou.               | 553 Tomb of the Virgin, "                                   |
| 517 Palace of Choubra, "                     | 554 " David, "  |
| 518 " Ghezireh, "                            | 555 Tombs of the Kings, "                                   |
| 519 Pyramids and Sphynx.                     | 556 Bethlehem.  |
| 520 Approach to Karnac.                      | 557 Rachel's Tomb.  |
| 521 Karnac.                                  | 558 Women of Bethlehem.                                     |
| 522 Columns of the Grand Hall, Karnac.       | 559 Hebron, Mosque of Abraham.                              |
| 523 Colosse of the Plains, Thebes.           | 560 " the Reservoirs.                                       |
| 524 Colossal Statue at the Memnonum, Thebes. | 561 Gorge and Convent, Mar Saba.                            |
| 525 Philæ.                                   | 562 The Dead Sea.   |
| 526 Pharaoh's Bed, Philæ.                    | 563 The River Jordan.                                       |
| 527 Great Temple, "                          | 564 Bedouin Chiefs at Jericho.                              |
| 528 Sculptured Doorway, Philæ.               | 565 Convent at Mt. Carmel.                                  |
| 529 Temple of Edfou.                         | 566 Nazareth.   |
| 530 Obelisk and Propylon, Luxor.             | 567 Tyrian Laundresses.                                     |
| 531 Great Temple, Medinet Habos.             | 568 Two Women Grinding Corn.                                |
| 532 Harbor of Assouan.                       | 569 White Ass of Syria.                                     |
| 533 Temple of Dandouro, Nubia.               | 570 Turkish Lady.   |
| 534 " Dakkeh, "                              | 571 Samaria—Ruins of the Temple of Baal.                    |
| 535 Great Rock, Temple of Ipsambul, Nubia.   | 572 Temple of Jupiter, Baalbec.                             |
| 536 Little Temple of Ipsambul, Nubia.        | 573 Temple of the Sun, "                                    |
|  | 574 The Great Columns, "                                    |
|  | 575 Cyclopean Wall of the Great Temple, Baalbec.            |

## SYRIA AND PALESTINE.

- 537 Sinal, Mt. Horeb.  
 538 Jaffa, or Joppa.  
 539 Lydda.  
 540 Ramleh.  
 541 Jerusalem, from Mt. of Olives.  
 542 Church of the Holy Sepulchre.  
 543 Arch, Via Dolorosa, Ecce Homo.  
 544 Jews' Wailing Place.  
 545 Mosque of Omar.  
 546 Synagogue.  
 547 Golden Gate or Door.  
 548 Damascus Gate.  
 549 Garden of Gethsemane.  
 550 Tombs in Valley of Jehoshaphat.  
 551 Tomb of Absalom.

## INDIA AND JAVA.

- 576 Views in India.  
 577 Golden Temple, Umritsur.  
 578 Delhi Gate, at the Fort.  
 579 Poplar Avenue, Screennuggur.  
 580 Ruins of Martund.  
 The Chandi Chouk, principal street in Delhi, and 40 other views.  
 Set of 18 Java views, with descriptive lecture.

## BRAZIL.

- 581 City of Bahia.  
 582 Commerce Street.  
 583 The Bluffs and Upper City.  
 584 Church of Bom Fim, from the Portuguese Hospital.

## Class XLII, Centennial Slides.

PER SLIDE, 60 CENTS.

The following list, selected from a thousand subjects, will assist purchasers in getting the best, and such as will prove permanently interesting.

## CENTENNIAL CITY.

- 1 Independence Hall.  
 2 Interior "  
 3 Old Liberty Bell.  
 4 Carpenters' Hall.

- 5 U. S. Mint.  
 6 Masonic Temple.  
 7 Girard College.  
 8 Girard Avenue Bridge.  
 9 Fairmount.  
 10 " Park

## MAIN BUILDING.

- 926 North Entrance.  
 355 Opening Day, Choristers.  
 371 From Machinery Hall.  
 815 Main Avenue, looking East.  
 873 North Avenue, East End.  
 1428 From Northeast Tower.  
 2021 Chinese Court, Exterior.  
 2203 " " Interior.  
 2128 Chinese Round-top Bedstead  
 1480 Chinese Carved Bedstead.  
 2037 Mammoth Japan Vase.  
 2015 Japanese Porcelain Vases.  
 2170 Japanese Porcelain Ware.  
 2017 Japanese Mirrors and  
 Bronzes.  
 2167 Japanese Bronze and Silver  
 Birds.  
 2018 Althof & Co's Exhibit.  
 2329 Egyptian Section.  
 2050 Austrian " "  
 2110 " " Glass Ware.  
 2062 " " Porcelain Ware.  
 2009 Bohemian Glass Ware.  
 1827 German Bronzes.  
 2127 Russian Section.  
 2233 " " Educational Depart  
 ment.  
 1454 Italian Section.  
 1468 " " "  
 1230 Italian Terra-cotta Ware.  
 2301 Brown & Co's English Crock-  
 ery.  
 2032 Doulton Pulpit England.  
 2033 Daniel's China Court, Eng-  
 land.  
 178 Lambert Pottery, England.  
 943 Pompeian Plate, Elkinton.  
 705 Queen's Land Court.  
 2041 Swedish Ornamental Pot-  
 tery.  
 2218 Porcelain Mantel.  
 251 Gustotsberg's China.  
 1496 Scandinavian Peasants.  
 2362 The Wedding Ring.  
 1497 The New Baby.  
 1495 Baby's Death.  
 2387 The Clock Maker.  
 2349 The Dying Elk.  
 2307 Norwegian Peasants.  
 1498 Laplanders.  
 2303 Laplander and Reindeer.  
 2189 Brazilian Court.  
 2178 Portuguese Terra Cotta  
 Ware.  
 2225 Spanish Pottery.  
 2224 Spanish Metal Work.  
 2216 Peruvian Mummies, etc.  
 1887 Mexican Section.  
 2060 Viti's Alabaster Vases.  
 2081 " " "  
 2032 French Section.  
 2282 " " Bronzes.  
 2214 Shell Work, Bahama Islands.

- 376 N. Eng. Glass Exhibit.  
 2011 U. S. Chemical Department.  
 1526 Bryant Vase, Tiffany.  
 2285 Screens, etc., Netherlands.  
 2367 Swiss Carving, Cattle Piece.  
 2366 " " Ornamental Carving.  
 2109 Crystal Fountain.  
 249 Norwegian Furniture, Thir-  
 teenth Century.  
 431 Schroeder's Carved Pulpit.

## MACHINERY HALL

- 123 Exterior.  
 817 From Main Building.  
 966 South Avenue, Krupp Gun.  
 161 Corliss Engine.  
 808 North Avenue, looking East.  
 83 Transept.  
 819 South Avenue, looking East.

U. S. GOVERNMENT BUILD-  
ING.

- 921 Exterior.  
 1242 Main Avenue, looking West.  
 922 Model U. S. Steamship, An-  
 tletan.  
 930 War Canoe, and Models.  
 932 Group of Deer.  
 933 Nevada Minerals.  
 651 Rodman Gun.  
 732 Monitor Turret.

## AGRICULTURAL HALL.

- 329 Exterior.  
 815 Interior, looking West.  
 745 Main Avenue.  
 1181 California Grape Vine.  
 801 Old Time Windmill.  
 1114 Negatherium.  
 1381 Old Abe, Wisconsin Eagle.  
 898 Brazilian Cotton Exhibit.

## HORTICULTURAL HALL.

- 452 Exterior.  
 1714 Horticultural Hall and Foun-  
 tain Avenue.  
 737 Rhododendrons.  
 825 Portico.  
 1177 Miss Foley's Fountain.  
 288 From South Entrance.  
 276 Century Plant.  
 279 Banana.  
 266 Phoenix Doehlifera.  
 319 Letania Verbonicas.  
 269 Lemon Tree.  
 270 Orange Tree.

## MEMORIAL HALL.

- 366 Exterior.  
 365 Dying Lioness.



## CLASS XLV.

# SCIENTIFIC SCIOPTICON SLIDES.

### HISTORY OF CULTURE.

PER SLIDE, 30 CENTS.

The numerals referred to in German at the bottom of each slide are so small, and so irregularly distributed, that they are not easily traced, but the objects are mostly represented in horizontal rows, and this order being observed in the enumeration leads directly to their recognition. Objects not arranged in this order, such as relics, ornaments, utensils, etc., are, nevertheless, named in rows, so as to be as little exceptional as possible. The Bar (|) indicates the beginning of a lower row at the left hand.

To examine the German lists on the slides, a magnifying glass can be used to advantage.

#### 1.—Stone Period.

12-47.—Implements of Stone. 1-11, 48-57.—Of Deer Horns and Bones. | 74-78.—Prehistoric Skulls. 72.—Yellow Amber Pearl. 73.—Stone Hammer. 71.—Necklace of Teeth. | 58-70.—Vessels of Clay.

#### 2.—Ancient Relics from Alpine Lakes.

1 (centre).—Prehistoric Lacustrine Pile Village, restored. 2-4 (above).—Present State. 5-70 (right and left).—Utensils taken from the Bottom of Lake Brienze. 71-88 (below).—From other Swiss Lakes. 89, 90.—From Pile Buildings in Wismar. 91-95.—From Italian Lakes.

#### 3.—Bronze Period.

1-15.—Axes. | 26-31.—Daggers. 32, 33.—Sword Hilt. 24, 25.—Arrow Points. 16-19.—Knives. 20.—Saw. 21.—Awl. 22.—Needle. 23.—Fish-hook. | 34, 35.—Shields. 36-52.—Jewelry. 53.—Comb. | 58, 59.—Urns. 54.—Clay Bowl. 55-57.—Golden Vessels.

#### 4.—Graves.

9-16.—Hill Graves and Ash Urns. | 8.—Grave for Master and Slaves. 17, 18.—Graves with Unburned Corpses. 7.—Orkney Island Grave. 19.—Tentonic Burial Tree. | 5.—Grave of Huns in Mecklenburg. 4.—Cromlech of Stennis (Druidical Altars). 6.—Giants' Enclosure in West Gothland. | 2, 3.—Fairy Grottoes at Saumur. 1.—Grave of Huns in Saxony.

#### 5.—Egypt.

3.—Priestess. 4.—Priest. 9.—Ethiopian Queen. 2.—Egyptian Queen. 5.—Court Officer. 1.—Pharaoh. 6.—Fan Carrier. 7.—Judge. 8.—Body Guard. | 11, 12.—Egyptian Costumes. 13, 14.—Modern Numidians. 10.—Distinguished Egyptian. 15-17.—Border Nationalities.

**6.—Egypt.**

50.—Stone Pillow. 1-10.—Insignia of Royalty. 31-33.—Neck Collars. 34-39.—Ornaments. 40-44.—Amulets. 46, 47.—Seals. 48, 49.—Sandals. || 13-22.—Ornamental Furniture. 24-30, 45.—Musical Instruments. 51-66.—Tools. || 70-83.—Vessels. 81-90.—Kitchen Utensils. 67.—Scales. 68, 69.—Weights. 91.—Lamp. || 92-97.—Toilet Set. 106.—Palanquin. 105.—Harness. || 103.—Wagon. 104.—Whip. 98-102.—Furniture. 107.—Plan of a House. 23.—Mummy Sepulchre.

**7.—Egypt.**

17 (at the left).—Writing. 18, 19.—Names on Rings. 13.—Caske for the Dead. 9, 10.—Mummy Heads. 11, 12.—Embalmed Animals. 7.—Rock Chapel. 8.—Mausoleum. || 2 (centre).—Cleopatra's Needle. 1.—Interior of the Great Pyramid. || 16 (at the right).—Hieroglyphics. 5.—Entry. 4.—Front of Palace. || 20.—Astronomical Tables. 15.—Apis. 14.—Sphinx. 6.—Nile Bark. 3.—House.

**8.—Egyptian Life.**

1.—Agriculture. || 2.—Trades (Smith, Potter, Mason, etc.). || 3.—Traveling, Reception, Visiting.

**9.—Egyptian Deities.**

1.—Nod. 2.—Mu. 3.—Tefenut. 4.—Seb. 5.—Isis. 6.—Anubis. 7.—Hathor. 8.—Thoth. 9.—Saf. 10.—Seback. || 17, 18.—Mummies. 14.—King Sethos Offering Sacrifices. 13.—Ethiopian Deity. 11.—Horus. 12.—Selk. || 15.—Court for the Dead. 16.—Funeral.

**10.—Assyria.**

1, 2.—Assyrians. 3, 4.—Court Officials. 5.—King. 6.—Fan Carrier. 7.—Armor Bearer. 8.—High Priest. 9.—Butler. || 10.—Persian King. 11, 12.—Persians. 13-16.—Medes. 17, 18.—Body Guards.

**11.—Assyria.**

1 (centre).—King's Palace, restored. || 4-7 (left).—Head Coverings for Kings. 8, 9.—For Priests. 35.—Harness. 53-59, 46-49.—Vessels. 50.—Bell. 13.—Stone Prayer Cylinder. 36-45.—Furniture. || 10, 11 (right).—Necklace and Sceptre of Priest. 51-53.—Axes. 34.—Officer's Staff. 31-33.—Weapons. 14-28.—Jewelry. 29.—Sandal. 12.—Sacred Vessel. 2.—King on His Throne. 3.—Head of a King. 54.—Wagon. 55.—Persian Wagon.

**12.—Assyria.**

2.—Feroher. 3.—Dagon. 1.—Nisrock and the Sacred Tree. 7.—Astarte. 4.—Nergal. 10.—Salmanassar III. || 5, 6.—Deities at Nimrud. 8.—Altars of the Magi. 9.—King Sanherib. || 11-16.—Assyrian Life. 17.—Rock Inscriptions.

**13.—Arabia and Phœnicia.**

1-3.—Arabs. 4.—Phœnician Woman. 6, 7.—Northwestern Asiatics. 8.—Woman of Cyprus. 5.—Phœnician. 9.—Philistine. || 10-16.—Hebrews. 17.—Jewish Wagon.

**14.—India.**

7-17.—Jewelry. 18-20.—Buildings. || 32.—Axe. 1, 2.—Costumes. 36.—Buddhist Memorial Temple. || 31.—Standard. 34, 35.—Musical Instruments. 3-6.—Sculpture at Ellora. 37.—Feast of Juggernaut. 21-31.—Cay Vessels.

**15.—India.**

1.—Brama, Vishnu and Lacksmi. 3.—Mahadeva and Bhavani. 2.—Brahma and Saraswati. || 5.—Aroopansamy. 8.—Adoration of Deceased Parents. 6.—Breemun. 9.—Biddha. || 12.—Sacred Pillar. 10.—Vadschrapani. 13.—Ajunal. 7.—Sacred Bull. 14.—Aljushl. 4.—Kama. 11.—Japanese Prayer Wheel.

**16.—Grecian Costumes.**

1.—Chiton. 2.—Exomis. 3, 4.—Himation. 5.—Chlamis. 6.—Children's Wear. 7, 8.—Lady's Chiton. 9.—Doric Chiton. 10.—Combination Chiton. 11-19.—Festival Costumes.

**17.—Greece.**

36-38.—Baskets. 4-10.—Jewelry, etc. 135.—Wash Basin. 77, 78.—Theatre Masks. 42-71.—Table Dishes. 125-31.—Furniture 175, 76.—Altars. 39-41.—Household Utensils. 20, 21.—Musical Instruments. 73, 74.—Sceptres. 72.—Tools.

**18.—Greece.**

1, 3.—Supposed Ground Plan of Houses of Homeric and Later Period. 2.—Remains of Royal Palace at Ithaca. 14, 6, 5.—Court, Country House and Entry, restored. 17, 8.—Group of Grecian Houses, restored. 9.—Plan of Greek Town.

**19.—Grecian Life.**

1.—Childhood. 2-4.—Gymnastic Exercises. 5.—Student. 6.—Pedagogue. 7.—Hospitality. 8.—Marriage. 19-11.—Female Life. 12.—Mourning for the Dead.

**20.—Grecian Life.**

1.—Casting Statues. 2.—Armor Smith. 3.—Pottery. 14.—Farmer. 5.—Hunter. 6. Marketman. 7.—Fisherman. 8.—City Vehicle.

**21.—Grecian Life.**

1.—Priestess. 2.—Sacrifices. 3.—Danseuse. 4.—Flute Player. 15-7.—Social Life. 8.—Dramatic Instructor (sitting).

**22.—Classical Deities**

1.—Rhea. 2.—Saturn. 3.—Sibyl. 4.—Jupiter. 5.—Juno. 6.—Neptune. 7.—Vesta. 8.—Pluto. 9.—Ceres. 10.—Bacchus. 11.—Minerva. 12.—Apollo. 13.—Diana. 14.—Mars. 15.—Venus. 16.—Cupid. 17.—Mercury. 18.—Vulcan. 19.—Esculapins. 20.—Hygeia. 21.—Vertumnus. 22.—Melpomene. 23.—Erato. 24.—Thalia. 25.—Ganymede. 26.—Bacchantes. 27.—Silenus. 28.—Bacchantal Procession. 29.—Friton and Nereids.

**23.—Asia Minor—Costumes, Etc.**

7.—Phrygian. 6, 9.—Lydian. 1, 2.—Phrygians (sitting). 4, 5.—Greek Armenian. 10, 11.—Asia Minor. 11, 19.—Sassanides (H. rsema). 8, 3.—Phrygian Group. 12-17, 21.—Arabian Utensils and Vessels.

**24.—Roman Costumes.**

1, 2.—Etruskan. 5, 3.—Tunic. 4.—Toga. 6.—Female Dress. 7.—Priestess. 8.—Lictor. 9.—Peasant. 16, 17.—Galle. 12.—General, A. D. 430. 14.—Consul. 11.—G. dia Placidia. 10.—Valentinian III. 13.—Consul. 15.—Circus Servant.

**25.—Roman Life.**

1, 2.—Ladies. 3.—Ball Playing. 4.—Female Artist (sitting). 15.—Actors. 6.—Gladiators. 7.—Court. 8.—Public Sacrifice.

**26.—Roman Buildings.**

1.—Ground Plan of House in Pompeii. 2, 3.—Ground Plan and Section of Roman Houses. 10.—Bath. 11.—Amphitheatre, Pompeii (cross section). 12.—Sena Stabulis at Herculaneum. 14, 5, 6.—Houses and Garden at Pompeii, restored. 17.—Store. 8, 9.—Plan of Palace and Hall of Diocletian.

**27.—Roman Furniture.**

2.—Toilet Articles. 3.—Mirrors. 4.—Ornamental Pins. 14.—Dice. 5-7.—Rings. 12, 13.—Keys. 11.—Bathing Utensils. 15-19.—Clay Vessels. 20.—Seals. 11.—Writing Materials. 8, 9.—Perfumery Boxes. 10.—Comb. 21-30, 44-49.—Kitchen Utensils. 32.—Scales. 33.—Weights. 34.—Bucket. 35.—Lantern. 31.—Sickle. 131, 37.—Marble Vase and Table. 38, 39.—Lamps. 42, 43.—Chairs. 41.—Fripod. 40.—Candelabra.

**28.—Ancient Italy and Etruria—Celts.**

13-107.—Relics of the Iron and Bronze Period. 109.—Bronze Chair of King Dagobert. 108.—Icelandic Chair. || 3-12.—Etruscan Antiquities. 1, 2.—House Urns, Ancient Italy.

**29.—Byzantium, Persia and Scythia.**

1-3.—Emperor Justinian and Staff. 4, 5.—Empress Theodora and Court Ladies. 6-8.—Ancient Slavonian and Russian Costumes. || 9.—Western Europe, B.C. 10.—Dacian. 11.—Duke of the Langobards, with Surroundings. 12.—Frank. 13.—Scythians.

**30.—Mediæval Dress and Ornaments.**

1.—Emperor Henry the Holy. 2.—Emperor Frederick I. 3.—Queen Berengaria of England. 4, 5.—Dress in the Thirteenth Century. 6, 7.—Dress (about 1340). 8.—Italian, Fourteenth Century. || 9, 10.—Nobles, Fourteenth Century. 11.—Bell Girdle (1401). 12.—Female Costume (1430). 13.—Philip the Good of Burgandy. 14.—Lady at the Court of Charles the Bold. 15.—Citizen (1470).

**31.—Mediæval Fashions.**

1, 2.—Students, Sixteenth Century. 3.—Dancing Couple at a Patri-cian Ball (1510). 4.—Marriage (1550). 5.—Royal Bride and Attendant (1554). 6.—Bandit (1560). || 7, 8.—Town's People (1570). 9.—Spanish Gentry (1580). 10.—French Lady (1590). 11.—Italian Lady (1590). 12.—Hungarians. 13.—Turk. 14.—Russian.

**32.—Mediæval Fashions.**

1, 2.—Netherlands. 3.—French (1340). 4.—Louis XIV and Queen. 5, 6.—Gentleman and Lady of Fashion (1690). 7.—Nuremberg Council-man (1700). || 8.—Common People (1740) 9.—Gala Dress at Court of Berlin. 10.—Costumes (French Revolution). 11.—Court Costume (1800). 12.—A la Grecque (1800).

**33.—Head, Hair and Neck Dress, from 1500 to 1800.**

1, 2.—(1500). 3.—Linen Hood (1510). 4-6.—Neck Ruffling and Cap (1530 to 1560). || 7.—Broad Neck Ruffle (1590). 8.—Queen Elizabeth (1600). 9-12.—Collars and Hair Dress (1620-1630). || 13.—Collar (1660). 14.—Fur Hood (1670). 15.—Knitted Hood. 16.—Neckerchief and Peruke (Wig). 17.—Empress Claudia Felicitas. 18.—Elongated Peruke (1690). || 19.—Female (1700). 20, 21.—Peruke (1720-1750). 22.—Hair Bag. 23.—Queue. 24.—Female Hair Dress (1800).

**34.—Mediæval Building Arts.**

1.—Plan of Convent of St. Gall (Ninth Century). 2.—Plan of Ancient Castle at Nuremberg. 3.—View of same (Fifteenth Century). || 6.—Town of Forcheim (1632). 7.—Lake House at Nuremberg. || 4.—Old Plan of Wartburg Castle. 5.—Nuremberg. 8.—Manheim.

**35.—Mediæval Building Arts.**

1, 2.—Old German House Urns. 4, 3.—Mediæval Ground Plan and Dwelling at Hanover. 5, 6.—Ground Plans, Dwelling at Goslar, Palace at Venice. 7.—Dwelling at Le Mans (Fifteenth Century). || 8, 9.—Citizen's and Noble's Residence, Nuremberg (Sixteenth Century). 10.—Town Hall at Augsburg.

**36.—Mediæval Building Arts.**

1.—Female's Apartment (Fifteenth Century). 2.—Tavern of the Golden Goose, Nuremberg (Sixteenth Century). 3.—Spiral Staircase, Castle of Duke of Dunois. || 1.—Hall of Nobles, Town Hall at Augsburg. 5.—Ante-Chamber in the Belvidere Palace of Prince Eugene at Vienna.



**37.—Mediæval Furniture and Utensils.**

10-45 (scattered).—Furniture, Jewelry and Vessels of the Fifteenth Century. 8.—House Organ (1527). 9.—Chandeller (Sixteenth Century). | 3, 4.—Cupboards (Fifteenth and Seventeenth Centuries). 7.—Stove. 6.—Table. 21.—Clock (Sixteenth Century). | 1, 2.—Chairs (Twelfth and Sixteenth Centuries). 44.—Bound Book. 10.—Leather Trunk. 11.—Iron Trunk. 5.—Liquor Stand.

**38.—Trades and Professions—Institutes of Learning.**

1.—Pewterer. 2.—Coppersmith. 3.—Silk Embroiderer. 4.—Bathing. 5.—Physician (1566). | 6 School (1529). 7.—Fencing. 8.—Lecture Room, Tubingen University (Seventeenth Century). | 9.—Store. 11.—Bear and Boar Hunt. 10.—Counting Room (Sixteenth Century).

**39.—Social Condition and Amusements.**

1.—Departure of a Knight (1300). 2.—Social Entertainment (1340). 3.—Dinner Table of a Noble (1480). 4.—Travelers and Highwaymen (1530). | 5.—Shrove Tuesday (1580). 6.—Ball (1640). 7.—Morning Devotion (1780). 8.—Evening Social Entertainment (1810).

**40.—Amusements.**

1.—Court Ball (1560). 2.—Tournament. | 4.—Fireworks (1680). 3.—Royal Hungarian Herald. 5.—Theatre (1630).

**41.—Social Condition and Amusements.**

1.—Village Church Festival (1535). | 2.—Nuremberg Runner. 3.—Schuetzenfest (1614). 4.—Nuremberg Orator.

**42.—Social Conditions and Amusements.**

1-19.—National Costumes. | 20.—Sword Dance. 21.—English Races. 22.—Roman Carnival. | 23.—Passion Play at Oberammergau. 24.—Spanish Bull Fight. 25.—Russian Inclined Ice Road.

**43.—Court and State Festivals.**

1.—Emperor Charles VII Entering Munich. | 2.—Funeral of Countess Hedwig. | 3.—Emperor's Return after Coronation. 4.—Festival at Frankfort after Coronation. | 5.—Coronation of Empress Leonora (1630). 6.—Imperial Diet in Poland.

**44.—Insignia.**

1 (centre).—Roman Catholic German Emperor in Full State Dress. 2-5.—Imperial, Hungarian, Iron and Bohemian Crowns. | 6.—Imperial Gloves. 8.—Sword. 9.—Sword of St. Mauritius. 7.—Imperial Sandals. | 10.—Aral Dalmatica. 11.—Imperial Mantle. 12.—Romisa Dalmatica.

**45.—Coats of Arms from Thirteenth to Fifteenth Century.**

1-7.—Heraldic Colors. 8-11.—Fur Shields. | 12-22.—Shield Divisions. | 23-33.—Simple Escutcheons. | 34-57.—Ancestral German Dynastic Escutcheons. | 64-65.—Escutcheons from Thirteenth to Eighteenth Century. 58, 59.—Family Monograms.

**46.—Coats of Arms.**

12.—Austria. 13.—Hungary. 5.—Wirtemberg. 2.—Prussia. 6.—Baden. 14.—Russia. 15.—England. | 16.—France. 7.—Mecklenburg. 3.—Bavaria. 1.—German Empire. 4.—Saxony. 8.—Hesse. 17.—Italy. | 18.—Spain. 19.—Portugal. 9.—Saxe-Coburg-Gotha. 10.—Saxe-Weimar. 11.—Brunswick. 20.—Sweden and Norway. 21.—Denmark. | 22.—Netherlands. 23.—Belgium. 24.—Greece. 25.—Roumania. 26.—Switzerland. 35.—Papal States. 27.—Turkey. | 28.—Persia. 29.—China. 30.—Japan. 31.—United States of America. 32.—Mexico. 33.—Brazil. 34.—Australia.

**47.—Spanish Inquisition.**

1 (centre).—Chamber of Torture (Fourteenth Century). 2-10.—Its Implements of Torture, viz.: (Left) 2. Stocks; 3. Tar Pan; 4. Hamper Stone; 5. Foot Fetter; (right) 6. Spiked Hare; 7. 8. Executioner's Sword and Scabbard; 9. Fiddle; 10. Torture Mask || 11.—Inquisition by Torture. 13.—Execution of Insurgents at Prague, June 21st, 1621. 12.—Court Room (Fifteenth Century).

**48.—Ecclesiastics.**

1.—Byzantine Priest. 2.—Bishop in Full Regalia. 3.—Bishop in Mass Canonicals. 4.—Dean of Cathedral. 5.—(Seated) Cardinal. 6.—Deacon. 7.—Secular Priest. 8.—Armenian Bishop. 9.—Russian Patriarch Nikon. 10.—Italian Abbot. 11.—Protestant Clergyman. || 12.—Carthusian Monk. 13.—Benedictine. 14.—Capuchin Monk. 15, 16.—Dominicans. 17.—Franciscan. 18.—Jesuit. 19.—(Sitting) Carmelites. 20.—Augustinian Eremite. 21.—Franciscan Nun. 22.—Nun of St. Bridget. 23.—Dominican Nun. 24.—(Sitting) Nun of Port Royal. 25.—Carmelite Nun.

**49.—Royal European Orders.**

1.—Order of the Golden Fleece (Fifteenth Century). 2.—Secular Order. 3.—Clerical German Knight (Sixteenth Century). 4.—Knight of the Garter (Seventeenth Century). 5.—Grand Master of the Knights of St. John. 6.—Knight of the Order of the Holy Ghost. 7-36 (border).—Badges of Mediæval Knighthood Orders.

**50.—Church Furniture.**

1.—Altar in St. Chapelle, Paris. 2.—High Altar in Church of St. Elizabeth, Marburg. 3.—Sacarium, Vienna. 4.—Choir Seats, Hospital Church, Stuttgart. || 5.—Baptistry. 6.—Baptismal Font. 7.—Stall. 8.—Pulpit of Church of the Institute, Stuttgart.

**51.—Sacred Vessels and Church Furniture.**

1.—Ducal Goblet (Eighth Century). 2.—Goblet (1466). 3.—Planeta, St. Bernard (Twelfth Century). 4.—Planeta (Fifteenth Century). 5, 6.—Episcopal Rings. 7.—Rationale (Fourteenth Century). 8.—Mitre of Thomas à Becket. 9.—Mitre (1500). || 10.—Reliquary (Tenth Century). 11.—Portable (Twelfth Century). 12, 13.—Crozier (1471). 14.—Altar Candlestick. 15.—Mass Pitchers (Tenth Century). || 16.—Censer (Twelfth Century). 17.—Holy Water Kettle. 18.—Procession Candlestick. 19.—Crucifix (Twelfth Century). 20.—Ciborium (for the Sacred Wafer) (Thirteenth Century). 21.—Oil Receptacle (bird form). 22.—Aqua Manile (Ninth and Tenth Centuries).

**52.—Rites and Sacraments.**

1.—Sepulchres in the Catacombs. 2, 3.—Catholic Sacraments (Fifteenth Century). || 4.—Requiem for the Dead. 5.—Burial. 6.—Protestant Communion (Sixteenth Century). || 7.—Protestant Baptism (Eighteenth Century). 8, 9.—Russian Baptism and Christening.

**53.—Superstitions.**

1-6.—Amulets. 10, 11.—(Centre) Festival of Witches, Alchemist. 9, 13.—(Left) Horoscope, Theosophical Ring. 7, 8.—(Right) Key of Theophrastus Paracelsus. 12.—Zodiac Man.

**54.—Auto de Fé.**

(After a Contemporaneous Painting.)

**55.—Modern Developments.**

1.—Room in Grand Ducal Palace, Schwerin. 5.—Turner Hall, Leipzig (1863). 2.—Terrace, Ducal Palace, Schwerin. || 3.—S. Hiller Festival, Munich (1859). 6.—Rotunda, Exhibition Building, Vienna (1873). 4.—Artists' Festival, Weimar (1863). || 7.—Crystal Palace, Sydenham. 9.—German Colony of Blumenau, Southern Brazil. 8.—Masquerade Ball at Paris Grand Opera House.

# CLASS XLVI.

## ZOOLOGY.

PER SLIDE, 30 CENTS.

The objects on each slide are named in rows, as in Class XLV. In some cases the rows are made fewer and more readily traceable by including groups between the more distinct lines of separation.

### 1.

8. Magot. 9. Mandrill. 11. Black Roaring Ape. 13. Apella. Skulls—  
10. Of Baboon. 4. Of an Old Gorilla. 3. Of Young Chimpanzee. 5. Of  
Young Gorilla. | 1. Skeleton of Young Orang-Outang. 6. Kaban. 7.  
Mona. 12. Koaita. 15. Uistiti. 2. Chimpanzee.

### 2.

1. Loris. 2. Paw of Loris. 3. Skull of Loris. 5. Skull of Flying Maki.  
21. South African Reed Mouse. 18. Shrew Mouse. 22. Skull of Moun-  
tain Field Mouse. 8. Skeleton of Bat. 13. Skull of Horse shoe-nose.  
| 6. Finger Animal. 20. Skull of Water Shrew Mouse. 14. Skull of  
Pug-nosed Bat. 18. Skull of Mole. 11. Ear Bat, flying. 23. Canada  
Mole. 9. Head of Vampire. | 4. Maki. 17. Mole. 12. Pug-nosed Bat,  
cringing. 10. Ear Bat, hanging. 7. Flying Dog or Kalong. 15. Hedge-  
hog. 16. Skull of same.

### 3.

1, 2. Squirrel and Skull. 3, 4. Marmot and Skull. 5. Fat Dormouse.  
18. Porcupine. 7. Beaver. 11. Pouch Rat. 9, 10, 8. Fore Foot, Hind  
Foot, and Skull of Beaver. | 14. Wood Mouse. 22. Chinchilla. 19.  
Guinea Pig. 15. Skull of Field Mouse. 13. Hamster. 16. Lemming.  
| 17. Teeth of Rat. 12. Jerboa. 6. Skull of Dormouse. 20. Acoutt.  
21. Male Rat. | 25. Skull of Hare. 23. Paca. 21. Capybara (Lagomys).  
26. Hare.

### 4.

1. Lion. 4. Tiger. 5. Jaguar. | 3. Skull of Lion. 7. Serval. 8, 9.  
Wild Cat and Skull of Cat. 2. Lioness. 13. Skull of Hyena. 6. Leo-  
pard. | 10. Lynx. 12. Spotted Hyena. 11. Skull of Lynx. 14. Indian  
Leopard.

### 5.

1. Striped Hyena. 3. Wolf. 5. Prairie Wolf. 11. Genet. 13. Ich-  
neumon. | 2. Dog of the Desert. 4. Wolf's Skull. 7. Brazilian Fox.  
12. Pine Marten. 11. Rasse. 16, 20. Skulls of Marten and Fish Otter.  
| 6. Jackal. 10. Civet. 8. Fox. 9. Fennec. 15. Marten. 17. Weasel.  
18. Polecat. 19. Fish Otter.

## 76

### 6.

1. Ermine. 13. Skull of Bear. 9. Raccoon. 4. Honey Badger. 5. Striking Badger. 2. Glutton. 8. Skunk. 6. Badger. 3. Glutton's Skull. 10. Coati. 15. Binturong. | 16. Kinkajou. 11. Brown Bear. 12. Fore and Hind Foot of Bear. 14. Polar Bear. 20, 17. Seals. 19, 18. Above, Skull and Skeleton of Seal.

### 7.

1. Sea Lion. 2. Walrus. 15. Skull of Hippopotamus. 3. Skull of Walrus. | 7. Tapir. 5. Rhinoceros. 6. Skull of Rhinoceros. 8. Skull of Tapir. | 11. Donkey. 14. Emgalo. 4. Rock Badger. 13. Wild Boar. 10. Skull of Horse. 9. Horse. 12. Zebra.

### 8.

2. Elephant. 5. Skull of Babiroussa. 6. Stomach of a Ruminant. 4. Wild Hog. 1. Hippopotamus. | 10. Bison. 12. Sheep. 3. Skull of Young Elephant. 7. Bull. | 9. Buffalo. 13. Moufflon. 14. Goat. 11. Musk Ox. 8. Skull of Ox.

### 9.

5. Gnu. 2. Chamols. 6. Elk. 7. Reindeer. | 1. Wild Goat. 4. Gazelle. 3. Antelope of Canaa. 11. Skull of Musk Deer. 8. Stag. | 12. Dromedary. 13. Skeleton of Camel. 9. Roe. 10. Musk Deer.

### 10.

Perpendicular rows—1. Skull of Camel. 4. Skull of Giraffe. 6. Skull of Dugong. 3. Giraffe. 5. Manatus. | 2. Llama. 8. Skull of Dolphin. 7. Dolphin. 12. Skull of Whale. | 9. Narwhal. 15. Ant Eater. 11. Whale. 13. Fin Back Whale. | 16. Skull of Ant Eater. 18. Skull of Armadillo. 10. Skull of Spermaceti Whale. 17. Armadillo. 14. Pangolin. 19. Skull of Sloth.

### 11.

1. Two-toed Sloth. 2. Skull of Ground Hog. 18. Milk Glands and Young of Echidna. 8. Wombat. | 12. Flying Squirrel. 13. Shaggy Didelph. s. 5. Skull of Kangaroo. | 3. Kangaroo. 10. Skull of Opossum. 15. Ornithorynchus Paradoxus | 7. Female Organs of Opossum. 6. Opossum with Young. 16. Skull of Ornithorynchus, under part. 4. Skeleton of Kangaroo. 11. Beutel, or Pouch Wolf. 9. Opossum. 17. Echidna. 11. Wolverine.

### 12.

1. Skull of Parrot. 2. Head of Green Parrot. 3. Yellow Cockatoo. 4. Ara Parrot. 5. Wave Parrot. 6. Owl Parrot. 7. Pepper Eater. 8. Galbula. | 10. Cuckoo. 14. Bee Eater. 20. Head of Black Woodpecker. 18. Foot of Wryneck. 15. Hoopoe. 9. Trogon. | 12. Kingfisher. 16. Almond Rook. 11. Head of Cuckoo. 19. Variegated Woodpecker. 17. Wryneck. 13. Foot of Kingfisher. 24. Topaz Humming Bird. 21. Goat Sucker. 22. Head of same. 23. Martin.

### 13.

1. Skeleton of Humming Bird. 2. Mountain Cock. 3. Tyrant. 8. Sparrow. 7. Siskin. 11. Cross-bill. | 4. Synallaxis. 15. Foot of Lark. 5. Lyre Bird. 6. Bird of Paradise. 20. House Swallow. 22. Head of Gnat Snapper. 10. Hawfinch. 18. Fieldfare. | 17. Nightingale. 16.

Golden-crested Wren. 14 Sky Lark. 23. Head of Wren. 13. Crested Lark. 19. Blackbirds. 12. Hedge Sparrow. 9. Bullfinch. 21. Wax-wing.

## 14.

2. Golden Oriole. 3. Butcher Bird. 5. Head of Blue Woodpecker. 20. Osprey. 19. Golden Eagle. 21. Snake Eagle. | 6. Coal Titmouse. 9. Starling. 1. Wren. 11. Magpie. 4. Martlet. 18. Vulture. 10. Bird of Paradise. 17. Gray Vulture. | 8. Boat-tail. 15. Forest Screech Owl. 12. Mountain Jackdaw. 13. Stone Crow. 14. Horned Owl. 16. Condor.

## 15.

1, 2. Bearded Hawk and Skeleton. 10. Desert Fowl. 12. Woodcock. | 4. Falcon. 9. Entrails of Domestic Hens. 5. Secretary Bird. 13. Grouse. 14. Red Grouse. | 7. Ring Dove. 18. Jacana. 6. Didunculus. 3. Hawk. 8. Head of Stock Dove. 16. Turkey Cock. 17. Golden Pheasant. 11. Quail. 15. Partridge.

## 16.

1. Guinea Fowl. 2. Heath Cock. 3. Crested Curassow. 11. Kirol. 16. Chionts. | 4. Skeleton of Cassowary. 8, 9. Head and Foot of Ostrich. 5, 6. Head and Foot of Cassowary. 14. Oyster-fisher. 15. Plover's Head. 12. Woodcock. | 10. Nandu. 18. Serlema. 7. Ostrich. 13. Head of Snipe. 17. Dwarf Bustard.

## 17.

1. Agami. 4. Sun Heron. 3. Rail. 16. Wild Duck. 2. Aurena. | 8. Shadow Bird. 5. Head of Crane. 12, 13, 14. Skeleton, Head and Foot of Flamingo. 7. Head of Common Heron. 21. Foot of the Dwarf Sawyer. 10. Head of Avocet. 22. Head of Pelican. 20. Head of Sawyer. 19. Saw bill Duck. | 9. Stork. 11. Ibis. 6. Bittern. 15. Swan. 17. Eider Duck. 18. Water Hen.

## 18.

1. Pelican's Foot. 18. Robber-Sea-Swallow. 5. Snake Neck. 8. Herring Gull. 14. Mask Duck. 13. Crab Diver. | 4. Cormorant. 3. Frigate. 15. Guillemot. 11. Puffin. 12. Great Auk. 7. Albatross. | 2. Dodo. 17. Skua Gull. 9. Skeleton of Penguin. 16. Great Penguin. 10. Crested Grebe. 19. Tropic Bird. 6. Stormy Petrel.

## 19.

1. Skeleton of Tortoise. 7. Cauana, or Hawk's-bill Turtle. 15. Varan of the Nile. 4. Snapping Turtle. | 3. Turtle. 8. Leathery Turtle. 10. Head of Cayman. 6. Trionyx, or Fierce Snapping Turtle. 2. Land Turtle. 5. Matamata. 12. Crocodile Skull, profile. 13. Top of same. 16. Hedge Lizard | 9. Crocodile Skeleton. 14. Top of Skull of Gavia. 11. Crocodile of the Nile.

## 20.

1. Variegated Lizard. 6. Skink. 18. Cobra. 19. Flathead Snake. | 3. Frilled Gecko. 4. Hooded Basilisk. 7. Double Creeper Worm. 8. Ring Adder. 13. Viper's Head. 10. Skull of Ring Adder. 15. Skull of Rattlesnake. 9. Skeleton of Ring Adder. 21. Tortrix. | 5. Chameleon. 20. Boa Constrictor. 11. Adder. 16. Poison Apparatus of Rattlesnake. 12. Rattlesnake's Head. 2. Teguxin.

## 21.

1. Ringed Grub. 15. Masked Axolotl. 16. Axolotl. 14. Great Salamander. || 2. Tree Frog. 3. Green Frog. 13. Crested Newt. 10. Ground Salamander. 17. Congo Snake. || 18. Proteus. 9. Pipa. 4. Skeleton of Frog. 7. Toad. 8. Horned Toad. 12. Ribbed Salamander. || 5. Toad with Spawn. 6. Unke. 11. Hooded Salamander. 19. Arm Salamander, or Siren.

## 22.

5. Fore Part of Skeleton of Porpoise. 1. Protopterus. 11. Sturgeon. 13. Bellows Fish. 2. Skeleton of Starry Ray. 10. Pike. 17. Eel Mother. 16. Sea Butterfly, or Blenny. 6. Common Shark. 4. Saw Fish. || 9. Bony Pike. 15. Sea Bat. 8. Spöke. || 14. Sea Surgeon. 12. Skeleton of Sturgeon. 3. Torpedo Fish. 7. Hammer Shark. 18. Spouting Fish, or Beaked Chætodon.

## 23.

1. Tunny. 2. Mackerel. 7. Climbing Fish. || 6. Harder. 12, 13. Bass. || 3. Fan Fish. 4. Skeleton of Silver Plate. 10. Stickleback. 5. Corb. 8. Dorado. || 14. Horn Pike. 17. Turbot. 18. Sole. || 15. Swallow Fish. 19. Muræna. 11. Sand Eel. 9. Open Mouth of Dorado. 16. Skeleton of Zunge.

## 24.

1. Julis. 24. Myxon. 15. Bastard Carp. 25. Lancelet. 19. Silurus. || 7. Skull of Cod. 14. Carp. 6. Cod. 17. Gudgeon. 20. Moon Fish. || 11. Brook Trout. 12. Salmon. 9. Pike. 18. Loach. || 8. Eel Pout. 3. Sardel. 13. Maranc. 4. Anchovy. 22. Sea Horse. || 16. Trench. 5. Herring. 10. Salmon. 23. River Lamprey. 2. Eel. 21. Horned Trunk Fish.

## 25.

1-8. Termites. 41. Club Beetle. 36. Scaritida, or Sand Beetle. 38. Whirlwig Beetle. 46. Gloss Beetle. 45. Scaphidium. 61. Striped Beetle. 47. Colydium. 42. Stumpy Beetle. 57. Spring Beetle. 15. Migratory Locust. 14. Leaping Locust. 18. Shore Fly. 24. Feather Louse. 20. Dragon Fly. 22. Sugar Moth. 59. Cebriion. 21. Thrips. 27. Camel-neck Fly. 23. Glacier Flea. || 35. Larva of Rose Bug. || 10. Mantis, or Praying Insect. 62. Borer. 55. Scarabæus, or Dung Beetle. 11. Walking Leaf Insect. 17. Wood Louse. 19. May Fly, or Ephemera. 28. Scorpion Fly. 25. Ant Lion Larva, in pit. 53. Larva of Cockchafer Grub. 16. Earwig. 60. Glow Worm; *a*, male, *b*, female. 54. Chrysalis of Cockchafer. || 30. Xenos. 29. Vernal Fly. 31. 32. Coleoptera. 34. The Golden Running Beetle. 56. Splendid Bug. 33. Leather Running Beetle. 39. Fish Beetle. 52. May Bug. 12. Cricket. 43. Larva of Carrion Beetle. 9. Cockroach. || 37. Swimming Beetle. 40. Brachelytra, or Rove Beetle. 63. Chrysalis of the Gnawing Borer. 13. Mole Cricket. 58. Cebriion. 48. Cucujus. 49. Bacon Beetle. 60. Pill Beetle. 51. Ground Beetle. 44. Burying Beetle. 26. Ant Lion, in perfect form.

## 26.

4. Tenebrio Molitor, or Meal Bug. 5. Larva of same. 3. Larva of Augur Beetle. 1. Cockchafer. 2. Augur Beetle. 11. Spanish Fly. 21. Sponge Beetle. 22. Lady Bug. 29. Sand Wasp. 33. Brown Forest Wasp. 38. Rose Gall Wasp. 39. Plum Saw Wasp. 44. Caterpillar of Pear Wasp. || 8. Melandria. 9. Stinging Beetle. 17. Barkchafer. 6. Wool Beetle. 7. Cardinal, or Scarlet Beetle. 10. Male Oil Beetle. 12. Desert Bug. 18. Plum, or Stumpy Beetle. 14. Corn Weevil. 20.

Leaf Beetle. 27. Working Bee. 25. Honey Bee. 23. Head of Bee. 26. Drone. 28. Wasp. 52. Blockhead. 24. Hind Foot of Working Bee. 30. Road Wasp. 31. Spinning Ant. 32. *a*. The Yellow Working Ant; *b*. Yellow Male Ant. 35. Small Belly Wasp. 34. Female of Brown Forest Wasp. 36. Little Thrust Wasp. 41. Saw Wasp. 42. Caterpillar of same. 43. Pear Wasp. 40. Plum Wasp Caterpillar. 45. Corn Wasp. || 19. Alpine Goat Beetle. 59. Female Silk Spinner. 53. Glass Moth. 64. Grape-vine Moth. 49, 50, 51. Admiral Butterfly, Caterpillar and Chrysalis. || 46, 47, 48. Swallow-tailed Butterfly, Caterpillar and Chrysalis. 15. Vine Weevil. 60. Caterpillar of the Silk Spinner Moth. 63. Cabbage Caterpillar. 37. Glossy Wing Diptera. 62. Ypsilon. 55. Goat Moth. 65. Caterpillar of Grape-vine Moth, Dwarf Plum Beetle. 58. Male Silk Spinner. 61. Chrysalis of same. 57. White Spotted Moth. 54. Fir Dart. 13. Pea Weevil. 56. Swarming Hornet.

## 27.

1. Bear Moth. 2, 3, 4. Measuring Worm, Grub and Moth. 6, 5. Apple Roller. 7, 8. Wax Moth. 10. Feather Gnat. 11. Pricking Gnat. 51. Book Scorpion. 20. Armed Fly. 21. Hoverer Fly. 15. Snipe Fly. 17. Common Hover Fly. 23. Tree Bug. 18. Ant Fly. 14. Hawk Fly. 16. Thick Fly. 26. Flea. 19. Feather Fly. 22. Murder Fly. 25. Louse Fly. 23. Cattle Louse. 24. Blue Bottle Fly. || 9. Moth. 44. Felt Louse. 56. Singing Grasshopper. 37. Larva of same. 34. Water Scorpion. 33. Shore Scorpion. 38. Mining Grasshopper. 32. Water Runner. 30. Bed Bug. 29. Blind Bug. 49. Louse Shell. 12. Cattle or Gad Fly. 42. *a*, *b*. Cochinillifer and Pupa. 31. Dung Bug. 27. Beetle Bug. 43. Head Louse. 40. Ear Cricket. 39. Froth Grasshopper. 35. Backward Swimming Grasshopper. || 58, 57. Hopping Spider. 59. Cochinelle Mite. 41. Leaf Flea. 53. Weaver Spider. 55. Cross Spider. 55. Mining Spider. 54. Galeodes or Scorpion Spider. 52. Tarantula. 13. Maggot of Gad Fly. 60. Muscic Mite. 50. Scorpion. 45. Shield-footed Myriapoda. 46. Scolopendra Formosa. 48. Millipede. 47. Centipede.

## 28.

1. Grass Mite. 2. Hedge Hog Tick. 24. Ball Wood Louse. 7. Wood Louse Spider. 3. Cheese Mite. 9. Frog Crab. 8. Land Crab. 12. Purse Crab. 13. White Symnista. 21. Ghost Crab. 14. Galathea or Common Plated Lobster. 16. River Lobster. || 6. Tongue Worm. 18. Mantis Shrimp. 20. Sand Skipper. 4. Itch Mite. 19. Fresh Water Shrimp. 10. Spider Crab. 22. Arcturus or Sea Wood Louse. 15. Spiny Lobster. || 28. Trilobite. 31. Cypris Clavæ, or Muscle Crab. 32. Cyclops, or Crab Flea. 27. Long-tailed Molucca Crab. 5. Bear Mite. 30. Water Flea. 23. Armadillo Wood Louse. 29. Shield Shrimp. 26. Ione. 25. Fish Louse. 17. Ring-horned Prawn, or Shrimp. 11. Woolly Crab.

## 29.

1. Argulus or Carp Louse. 4. Barnacles. 3. Louse Worm. 11. Polyarthra. 9. Notomata. 6. Crown Parasite. 13. Nereis. 14. Hetro Nereis. 15. Phyllodoce Nereis. 10. Brachionus. 8. Notommata. 30. Clepsine. 29. Albione. 5. Sea Pock. 42. Double Worm. 25. Peripatka. 20. Chloræma. 28. Horse Leech. 18. Phyllochetopterus. 22. Hermella. || 2. Perch Sucker. 7. Snout Wheel. 17. Hetrocirrus. 19. Lug Worm. 31. Sagitta, or Arrow. 37. Hair Worm. 36. Sharp Tail. || 23. Serpula. 32. Sipunculus. 21. Teretella, or Shell Blunder. 34. Trichina. 41. Polycelis. 24. Tomopteris. 38. Itch Worm. 53. Trichina Capsule. 40. Monocelis. 27. Snout Nereis. 26. Earth Worm. 12. Porcupine Sea Mouse. 39. Meckella. 35. Horse Maw Worm.

## 30.

1. Three Hole Mollusk. 2. Liver Leech. 3. Larva of same. 4. Larva of Double Hole. 5. Tapeworm. 21. Tapeworm. 38. Navel Snail. 7. Embryo Tapeworms. 12. Scraggy Pimpled Worm. 8, 9. Scolex in the Hollow of the Lungs of Way Snail. 10. Saw Tapeworm. 22. Development of Tapeworm in a Dog's Intestines. 13. Head. 14. Joint of Pumpkin Tapeworm. 15. Head. 16. Joint of Black Tapeworm. 19, 20. Scolex de Quese Colony. 29. Ancyloceras. 26. Argonaut, or Ship Boat Nautilus. 27. Ammonites. || 24. Cuttle Fish. 28. Ceratit Ammonite. 30. Turritela. 18. Joint of Swiss Tapeworm. 17. Head of same. 33. Edible Snail. 25. Pearly Nautilus. || 23. Musk Pulpe. 31. Oxygyrus, or Heteropod. 34. Field Snail. 32. Firola. 39. Dish Snail. 35. Spike Shell Snail. 40. Sea Hare. 37. Cone Snail. 36. Cerithium.

## 31.

1. Thread Snail. 2. Elysia. 7. Spirifer. 15. Cockle Shell. 21. Spondylus. || 3. Hyalea. 4. Cho. 5. Terebratula. || 6. Barnacle. 10. Shipworm. 14. Venus Muscle. 11. Mud Muscle. 31. Pedicellina. 22. Oyster. 13. Date Stone Muscle. 25, 24. Salpa. 27. Transparent Sea Sheath. 28. Nipple Sea Sheath. || 16. Artist Muscle. 17. Ham Muscle. 29. Golden Botryllus. 38. Cassidulus. 23. Exogyra. 12. Stone Borer. 9. Terebratula. 39. Shield Sea Urchin. 32. Bugula Avicularia. || 18. Pearl Oyster. 19. Inside of same. 20. Variegated Scallop. 83. Hornwrack Coral. 26. Fire Roller. 30. Lophopus Crystallinus (on rootlets of Duckweed). 37. Heart Urchin. 8. Pentamerus. 34. Synapta. 36. Sea Cucumber.

## 32.

1. Galerites. 2. Piper Urchin. 6. Principal Medusa. 10. Nut Urchin. || 3. Sea Urchin. 4. Sun Star. 5. Serpent Star. 9. Encrinite. 8. Pentacrinus. || 7. Hair Star. 19. Rotifer. 14. Penalula. 15. Phylactis, or Sea Anemone. 12. Precious Coral. 23. Cydippe Pileus. || 21. Venomous Cyanæa. 22. Rhizostoma Cuvieri. 11. Winding Coral. 18. Madrepora. 16. Sea Anemone. 17. Edwardsia. 13. Polyps.

## 33.

1. Rosary, or Praya. 3, 4, 5. Fall Torment. 22. Millola. 8. Cydippe Willsia. 12. Sarsia. 15. Plagiophrys. || 2. Physalis, or Portuguese Man of War. 19. Opelina. 17. Trumpeter. 25. Sun Animalcule. 26. Carpoanium. 27. Collozoum. 10. Georyonia. 9. Aurelia. 21. Light Animalcule. 14. Prorodon. 11. Tiaropsis. 34. Trichia. 24. Textularia. 20. Tripos Perinidium. 16. Aspidiscus. || 29. Hallomma. 32. Flint Sponge. 13. Stylonichia. 7. Hydra. 30. Amœba. 31. Bathybius. 28. Eucyrtidium. 33. Protomyxa.



APPENDIX  
TO THE  
SCIOPTICON CATALOGUE  
OF  
APPARATUS AND LANTERN SLIDES,

Sold by L. J. MARCY,  
1340 Chestnut Street, Philadelphia.

---

**REDUCTION IN PRICES.**

It will be seen by the following, that we have not only brought prices down to meet the times, but to anticipate any probable future reduction that first-class lantern slides and apparatus can possibly reach. At all events we shall in the future, as in the past, accept the lowest figures, and what is much more difficult, shall endeavor to maintain our high standard of excellence, and furnish all that is most improved and worthy of being approved.

We have, moreover, the pleasure of announcing, in this Appendix, improvements in apparatus and slides, more fully than could be introduced into the body of the Catalogue without confusing its paging and numbering.

*Framed Colored Views.*

New Departure Slides ( $3\frac{1}{2}$  inches in the clear, see Manual, page 146) are now reduced from \$2.50 to \$1.75 each, and the ordinary 3-inch Slides to \$1.50 each.

All our new stock of Framed Slides, whether catalogued or not, are now made 3½ inches in the clear. Our customers would not now be satisfied with 3-inch Slides.

Of the many New Departure Slides worthy of being appended to the choice selections in Class I, we may here name twenty; which with us is a sort of fixed quantity for short lists.

**PER SLIDE, \$1.75.**

- |  |  |
|--|--|
| 1 The Highlander's Departure.                        | 12 Anne Boleyn—The Surprise.                   |
| 2 The Highlander's Return.                           | 13 The Black Brunswicker.                      |
| 3 Winter in the Alps.                                | 14 The Evening Prayer.                         |
| 4 Summer in the Alps.                                | 15 Crossing the Stream.                        |
| 5 The Magic Grotto.                                  | 16 At the Sea Side.                            |
| 6 The Dance of the Fairies.                          | 17 Washington and La Fayette at<br>Mt. Vernon. |
| 7 Enoch Arden—The Lonely Isle.                       | 18 Washington Receiving Salute at<br>Trenton.  |
| 8 Enoch Arden--The Hour of Trial.                    | 19 Sunday in the Backwoods                     |
| 9 Great Expectations.                                | 20 Gray's Elegy, etc.                          |
| 10 Steady Johnny.                                    |  |
| 11 Fortunate Escape of William,<br>Prince of Orange. |  |

Except, perhaps, the choice selections in Class I, the Scripture Views in Class II average the finest, because the best talent has been concentrated upon these subjects for ages. Whenever a better design can be found, it is immediately substituted, but it calls for no change in the title. The list is purposely limited to those which are more desirable, in order to influence purchasers toward what will give them the best satisfaction.

***Framed Statuary, etc.***

Reduced from \$1.50 to 1.00 each.

Our \$1.00 views, framed with 3½-inch opening, include—

- |  |  |
|--|--|
| 1 Blacked-out Statuary. See Class<br>XIV.  | and such as Mercury, Venus,<br>Angel of Peace, Night, Morn-<br>ing, etc.; each in beautiful<br>clouds, which can be very<br>effectively used in one lan-<br>tern, and variegated by cut-<br>off, tinters, etc. |
| 2 Scientific Colored Slides. See<br>Class XX to XXXIII.  |  |
| 3 Novelties: such as Lightning,<br>Frost-work, some dozen Cloud<br>Effects, Water Effects, etc., |  |

The above are furnished in crystal form, at from 50 cents to 75 cents each.

## *Movables.*

Our Chromatropes are now made with the painted surfaces so close together that all are alike in focus on the screen. They are constructed so as not to bind by the shrinkage of wood, and a fine appearance is given to them by protecting brass plates. They are also made with large opening, in New Departure Style. Those with three glasses, as Good Night, Washington, Bee Hive, Aquarium, Fountain, etc., are reduced from \$5.50 to \$5.00; and those with two glasses are reduced to \$4.00.

Slip Slides are 75 cents each.

## *Dissolving Effects.*

Each set enumerated in Class XI and in Class XXXIX, is now sold for the sum of the reduced prices of the slides included, as, for example, in the following new sets:—

- |  |  |
|--|--|
| <p>1 The Dream of Immortality. Two Slides, \$3.50. A beautiful lady, reclining upon a couch, has fallen asleep; near her sits a friend, who has been reading to her from the Bible. A vision of angels appears; one places a crown of glory upon her brow.</p> | <p>4 "Look Not Upon the Wine." Two Slides, \$3.50. A beautiful girl with cup of wine in her extended hand. As we gaze upon her, she becomes transformed into a ghastly skeleton, and a serpent appears in the cup, illustrating the words of Solomon. Prov. xxiii, 31.</p> |
| <p>2 The Bachelor's Reverie. Two Slides, \$3.50. A bachelor is seen seated by his fireside, asleep in his chair, his dog and cat upon the rug. A vision of his early love—a rosy-cheeked, barefooted country girl—appears.</p>                                 | <p>5. Fire in New York. Two Slides, \$3.50. A building on fire is seen in the distance, and a steamer, drawn by horses at full gallop, passing. The scene changes to full view of the burning building, with steamer and engines playing water upon it.</p>                |
| <p>3 Good Morning. Two Slides, \$3.50. The portico of a mansion, with shutters of the window closed; the shutters fly open, and the figure of a lovely girl is seen at the window.</p>   | <p>6. The Fairy Fountain. Frame Slide and Rack Work Chromatope, \$6.75. A beautiful colored vase, with play of water, produced by rack work.</p>   |

## *Novel Dissolving Effects.*

Dissolving apparatus, from its earliest history, has been observed to produce exceptionally curious effects when certain figures dissolve into or emerge from strikingly suggestive surroundings.

This phenomenon is now quite the rage among exhibitors. It is rare to find any who do not claim the originality of the idea, but Mr. John Q. Maynard seems the first to make it a prominent feature in his entertainments.

The "Flight of Mercury" is reported among the more striking performances, and its description here will show the general plan of doing such things, and the peculiar advantages of the Sciopticon stage, tinters, cut-off, etc., and the facility with which various blacked-out statuary may be smoothly passed over the disk by means of swinging the one or the other instrument about its front pivot.

These effects may be greatly varied, multiplied, and improved upon, by any one having a large collection of views, by the skillful use of tinters, clouds, ice views, etc. Indeed, originality stimulates skill in manipulation.

THE SLIDES AND MANIPULATIONS producing the Mercury effects are as follows:—

**Slide 1.** A cloud view, from which, by turning the dissolving cock (or dissolver, if oil Sciopticons are used), comes forth—

**Slide 2.** Mercury, the smallest figure, made to float from right to left, by smoothly sliding the rear of the Sciopticon. Gradually bring this out brighter and brighter, and then, the clouds disappearing, let Slide 1 be removed and the blue tinter drawn up, and turn the dissolving-cock handle only to the middle (or, if oil Sciopticons are used, slip the handle over the button, so the dissolver will hang down); thus you will secure the figure of Mercury with the

blue ground; then gradually turn off the light from Mercury till the blue tint alone appears, and from it bring out

**Slide 3.** Ice View. Now gradually vanish the blue light, and from the Ice View comes—

**Slide 4.** Mercury, medium size. The ice is made to disappear, and the figure of Mercury to grow more and more bright, and to be followed by—

**Slide 5.** Clouds, heavier than the former. Then follow with—

**Slide 6.** Our new Lightning Effect. Cover the objective by passing the hand forward to the front of it, and turn the dissolving-cock handle to the middle; with a quick movement, uncover the objective two or three times, by passing the hand back and forth in front of it; then moving the lightning slide an inch or so, repeat the operation, and so continue till all parts of the sky receive a due proportion of electric display. Removing the lightning slide, dissolve into the red tinter slowly, by withdrawing the hand from before the objective with the fingers a little open, so as to get a pretty effect of color upon the clouds, till they, in turn, gradually disappear, followed by—

**Slide 7.** Mercury, largest size, which manage as before, so as to have a bright view of the figure with the rosy background. Now vanish the tint and follow with—

**Slide 8.** A Colored Moonlight View, in which the statue will appear to rest.

This set of eight slides (equivalent to ten in lanterns without tinter attachments), all in crystal form, for the sake of uniformity, is priced at \$6.00.

Among other sets are the Magic Lily and Dance of the Fairies, Venus Emerging from the Sea, the Flight of Time, the Journey of Aurora, etc. The order of their showing is indicated by the numbers attached to each slide. The tinters and the same ice and clouds may be used with either set.

### *Unframed Slides.*

The Unframed Slides used in this country are mostly  $3\frac{1}{4}$  inches high and 4 or  $4\frac{1}{4}$  inches from side to side. The picture openings, however, differ both as to size and shape. The common round opening is necessarily somewhat less than  $2\frac{7}{8}$  inches in diameter, showing considerably less area than the opening in our crystal slides here represented,



whose diameter is  $3\frac{1}{2}$  inches where most needed. The crescent of sky and foreground thus cut from the enlarged picture is scarcely a disadvantage to most subjects, while there is an advantage in showing the full height of what is near the side margins. We endeavor, therefore, to have all our Unframed Slides correspond, in shape, size, and opening, to the foregoing cut.

## *Scientific Sciopticon Slides.*

**PER SLIDE, 30 CENTS; PER HUNDRED, \$25.**

We are in constant search for the most desirable scientific illustrations for use in Lantern Slides. We have availed ourselves of the best designs brought to light by the Centennial Exhibition, as well as of every other available source. We offer these superior slides at 30 cents each, for the special benefit of educational institutions. Many of them, however, are suitable for general use, and have found their way into families and Sunday schools.

The names in full of two series added to this reprint of the Catalogue, may make amends, in part, for our being forbidden, by the Post Office Department, to send specimen glass slides by mail.

Class XLV, Zoology, is as complete an exhibit of animal life as is possible to present in so small a compass.

Those who prefer one object only on a slide, may have them so, to some extent; but it should be remembered that 858 subjects, at the prevailing price, would thus cost over \$600, instead of less than \$10.

The History of Culture, also, catalogued in full, can hardly fail to interest people of culture, in the family as well as in educational institutions. To make the series still more popular, we can substitute, for a dozen slides or so, lacking in popular interest, such as *Cornelia* and *Her Jewels*, the *Death of Caesar*, *Old Stone Mill at Newport*, *Views in Buried Cities*, etc.

A similar list of the 41 Ethnological Slides will be forwarded on application, and with the slides. It seems inexpedient to enlarge the Catalogue, at present, with further minute enumerations.

## *Colored Crystal Slides.*

Colors abound in nature and in art, and, therefore, projected pictures of colored objects require proper coloring to appear in the highest degree natural and beautiful.

We are endeavoring to make our Colored Slides both good and cheap, so as to meet the requirements of good taste, and of a light purse as well.

Among these are included:—

1. A selection of new art pictures, similar to those catalogued in Class I, but not sealed or framed.

**PER SLIDE, COLORED, 75 CENTS; UNCOLORED 50 CENTS.**

- |                                      |  |
|--------------------------------------|--|
| 1 Spirit of '76.                     | 11 Auld Lang Syne.                           |
| 2 The American Eagle.                | 12 The Old Oaken Bucket.                     |
| 3 Heroine of the Lighthouse.         | 13 The Arkansas Traveler.                    |
| 4 Steamboat Race on the Mississippi. | 14 The N. E. Kitchen.                        |
| 5 Maternal Projects.                 | 15 To the Rescue.                            |
| 6 The Croquet Party.                 | 16 He is Saved.                              |
| 7 The Bird's Nest.                   | 17 Meeting of the Waters—Lakes of Killarney. |
| 8 Tom's Music Lesson.                | 18 Bally Hinch Lake.                         |
| 9 The Three Horses.                  | 19 Blarney Castle.                           |
| 10 The Three Foxes.                  | 20 Glengariff Inn, etc.                      |

2. A selection of Scripture subjects similar to those catalogued in Class II, but not sealed or framed.

**PER SLIDE, COLORED, 75 CENTS; UNCOLORED, 50 CENTS.**

### OLD TESTAMENT.

- |                                       |                                    |
|---------------------------------------|------------------------------------|
| 1 Adam and Eve.                       | 11 Moses Saved.                    |
| 2 Death of Abel.                      | 12 The Burning Bush.               |
| 3 Noah's Sacrifice.                   | 13 Pharaoh and his Host Drowned.   |
| 4 Abraham's Sacrifice.                | 14 The Brazen Serpent.             |
| 5 Hagar in the Wilderness.            | 15 Samuel and Eli.                 |
| 6 Rebekah at the Well.                | 16 David and Goliath.              |
| 7 Arrival of Rebekah.                 | 17 Solomon and the Queen of Sheba. |
| 8 Jacob's Dream.                      | 18 Ascent of Elijah.               |
| 9 Joseph's Bloody Coat Shown.         | 19 Daniel in the Lion's Den.       |
| 10 Joseph Interprets Pharaoh's Dream. | 20 Espousal of Esther.             |



**NEW TESTAMENT.**

- |                             |  |
|-----------------------------|--|
| 1 Adoration of the Magi.    | 12 The Lilies of the Field.                |
| 2 Jesus with the Doctors.   | 13 Giving Sight to the Blind.              |
| 3 Clearing the Temple.      | 14 The Prodigal Son as a Swine-herd.       |
| 4 Woman of Samaria.         | 15 The Prodigal's Return.                  |
| 5 Healing the Sick.         | 16 Christ in the House of Mary and Martha. |
| 6 Blessing Little Children. | 17 The Last Supper.                        |
| 7 Stilling the Storm.       | 18 The Crucifixion.                        |
| 8 Christ the Consolator.    | 19 Abide with Us.                          |
| 9 The Ninety and Nine.      | 20 The Ascension.                          |
| 10 The Ten Virgins.         |  |
| 11 The Transfiguration.     |  |

3. A selection of European Views, from nature, similar to those catalogued in Class XLI, and such as show color to advantage.

**PER SLIDE, COLORED, 75 CENTS; UNCOLORED, 50 CENTS**

- |                          |                              |
|--------------------------|------------------------------|
| 1 Balmoral Castle.       | 11 Mer de Glace.             |
| 2 Holyrood Chapel.       | 12 Paris.                    |
| 3 Abbotsford.            | 13 Notre Dame.               |
| 4 Melrose Abbey.         | 14 Park at Versailles.       |
| 5 Buckingham Palace.     | 15 Falls of the Terno.       |
| 6 The Horse Guards.      | 16 Rome.                     |
| 7 Windsor Castle.        | 17 Venice.                   |
| 8 St. Goar on the Rhine. | 18 Naples.                   |
| 9 Bingen on the Rhine.   | 19 New Palace of the Sultan. |
| 10 Castle Chillon.       | 20 Palace of the Kremlin.    |

4. A selection of Comic Scenes.

**PER SLIDE, COLORED, 75 CENTS; UNCOLORED, 50 CENTS.**

- |   |  |
|---|--|
| 1 Music hath Charms.                      | 12 Young Men, Take Warning—<br>Temperance.         |
| 2 'Twas a Calm, Still Night.              | 13 Preparing for Congress.                         |
| 3 The Polite Conductor.                   | 14 Flaw in the Title.                              |
| 4 Thou Hast Learned to Love An-<br>other. | 15 The Man who Sat the Old Year<br>Out.            |
| 5 Onconvenience of Single Life.           | 16 Love at First Sight.                            |
| 6 The Raal Convenience                    | 17 Man as He Expects to Be.                        |
| 7 'Twere Vain to Tell Thee All I<br>Feel. | 18 Triumph of Woman's Rights.                      |
| 8 Sweepstakes.                            | 19 The Youthful Darwin.                            |
| 9 Both Puzzled.                           | 20 Darwinian Picture Gallery (in<br>variety), etc. |
| 10 Cross Purposes.                        |  |
| 11 The Course of True Love.               |  |

### *500 Scripture Illustrations,*

On 100 glass slides, are now sold for 30 cents per slide, or \$25 per hundred. See Introduction, p. xxvii.

These 100 slides may be subdivided into four classes, viz: 25 Tabernacle, Customs, etc., with descriptive lecture; 25 Biblical Antiquities; 25 Biblical Natural History, and 25 Holy Land Views.

A portion of these illustrations require a slide for each, but mostly a number of objects are grouped together, so that a subject ordered from Class V may only be furnished with several others on the same slide. They are intended not so much for popular entertainment as for illustrating Bible lessons.

### *Plain Glass Slides,*

Photographed from nature, are still priced as in the Catalogue, 50 cents each for American, and 60 cents each for European views.

We have an unequalled assortment of good subjects, and the best facilities for keeping such in full supply.

It is our policy to stock up with clear, good slides, of desirable subjects, in much larger proportion than with those less used and of less merit; so, while we are not obliged to make "special offers of our selections" to clear off the dregs of careless importations, we are able to offer choice well-assorted lots (which we will particularize and define according to circumstances at the time of application) at very low rates. This arrangement will often save us the trouble of hunting up and filling out inferior lists compiled from Catalogues, and will prove less expensive and more satisfactory to those who use the Sciopticon.

We are the more anxious to secure direct trade, by low prices, for good pictures, because much injustice has often

been done the Sciopticon, not only by bungling imitations and second-hand sales of old forms of it, but by saddling it with poor slides.

To extend the use of the Sciopticon, particularly as a "home influence, worthy of all praise (See Introduction, page xix), we will gladly furnish good, clear slides, of our selection from this class, at extremely low prices.

---

## IMPROVEMENTS IN APPARATUS.

Having an inventor's pride in the Sciopticon, with its accessories, I naturally strive to improve it in every particular possible. New features, however, are not pushed into notice till thoroughly tried and found worthy of approval. Of course, many promising theories fail of giving satisfaction when reduced to practice. For example, my early three-wick theory, coeval with my first patent, failed to meet my expectations. Wider wicks gave more candle power *and more heat*, but not more illumination on the screen. Oxygen, supplied between the flames, brightened them beautifully, but the wicks soon burned away, and the adjacent parts became overheated. My efforts to advantageously substitute Hydrocarbon vapor in Burner No. 1 have not yet proved fully successful, though hope still survives. But space would not allow a full enumeration of the many experiments involved in reaching a few well-assured improvements.

The following settled modifications, not previously described, are here explained, not only for the purpose of calling attention to them, but of showing the operator how to use them.

### *The New Cut-off.*

Hitherto the advantages of the Automatic Cut-off (see *Manual*, p. 167) have been confined to the Gas Sciopticon and to the use of glass slides only. In the modified form the flap or curtain next the objective is closed at pleasure by a latch under the fingers of the left hand, and is opened by the outcoming slide.

A brass spring, shaped like an archer's bow, faces the wooden base of the stage and holds the framed slide, or slide carrier, when glass slides are used, by bearing at the sides of the picture-opening. The glass slide carrier is held down, and firmly in place, by the first cut in the stage spring.

Crystal slides are in place in this carrier when flush with the condenser; French slides are pushed along till the finger comes to the junction of the condenser ring and the bottom groove; English square slides must be pushed in till the forefinger hits the wire spring that holds them.

The best way to stop a framed slide exactly in the right place, without interposing any obstacle to its outgoing, is to take it an inch from the end, with the thumb nail in the cut which is, or should be, marked in each, and push horizontally along the stage till the thumb strikes the condenser ring.

The operator (stationed behind the instrument, be it always remembered) may pass the slides through from right to left, panorama style, without using the cut-off, if he chooses. It is sometimes necessary to leave the curtain closed till the tinters are drawn up, as for effect slides, etc., which can be done by not crowding the outcoming slide forward.

### ***To Operate the New Cut-off,***

Each framed slide is taken upside down, with the right-hand thumb nail at the mark, half an inch from the wire ring, and rested in readiness on the end of the stage, while the left hand is placed in readiness to close the latch with the fingers and to receive the outcoming slide, pressing it forward against the lever which opens the latch the instant the right-hand thumb reaches the condenser ring. The change may be effected instantaneously, but to prevent seeing any glimpse of movement on the screen it is better to time the starting of, first the left hand, then the right, by counting one, two. This order soon becomes habitual, when the counting may be discontinued.

Glass slides follow each other in the same way through the carrier, only each outcoming slide opens the latch at the first notch in the spring.

The operation is not quite automatic, like the original cut-off, but the effect is quite as satisfactory. It allows the operator to be governed by circumstances, it is not liable to get out of gear, and it is applicable to both oil and gas Sciopticons, and to all sorts of slides.

### ***The Sciopticon Lamp and Flame Chamber***

Can now be made interchangeable with the triple jet in the Gas Sciopticon, with cut-off arranged for all sorts of slides, all for \$65.00. Only the clamp has to be omitted to allow the base of the oil cup to run in the side grooves, the same as in the Oil Sciopticon.

This arrangement is better than introducing the triple jet into the Oil Sciopticon, as described in the Manual, p. 160; but it is not better, except in the matter of bulk, than using an extra body. See Catalogue, p. 2, No. 13.

This Lamp arrangement is not sold without a lantern.

### *Modifications in the Triple Jet.*

A platina tip for the mixed jet is now made interchangeable with the steel nipple. It is less liable to become roughened in the bore by oxidation, and less liable to burn should it accidentally come in contact with the incandescent lime. In case obstructions carried by the current get too tightly lodged in the narrow passage to be removed in the hurry of an exhibition, the difficulty may be quickly overcome by removing the tip and screwing in its place one of the spare nipples furnished with the instrument. This peculiar nipple, though it has gone out of use as a gun nipple, is the only one I have been able to find that well answers this purpose.

The aperture in the platina tip is moderately large, as is now generally approved. When, however, the strongest light is desired, it is common to give still larger vent to the mixed gases, with great pressure to counteract the increased tendency to ignite inside the jet.

For the alcohol burner, a peculiar limeholder, which has been before alluded to, may be used. Price \$1.00 The ordinary socket is removed, and the tube holding this limeholder slips down over the wick tube, communicating its heat to the alcohol, thus favoring its vaporizing. It also tends to keep the flame from following an accidental overflow. For the alcohol limelight to be at its best, a full supply of good alcohol and a plenty of wick is required.

Attached to each limeholder is a brass strip, bent in the form of a sugar tongs, to facilitate turning the lime.

The metallic sheathing over the base of the jet keeps it from becoming defaced by the heat, or by handling.

In the draw under the draw-front of the Sciopticon is kept the wrench, broach, extra nipples, lead washers, etc.

### *Vertical Attachment.*

In order to use larger condensers, as well as the most approved form of the vertical attachment, the brass cells for the two elements of the larger condenser are hinged together and held in place by a pin. The back cell is held to the shortened Sciopticon body by a bayonet joint.

For the vertical attachment the front element of the condenser, mounted as above, opens to a horizontal position, and is held in place to a tall draw-front, which holds the objective and mirrors, in the usual form.

The price of the Gas Sciopticon, with the 5-inch condenser, mounted as above described, is \$65.00.

The price, with the 4½-inch condenser, etc., thus mounted, is \$60.00.

The same, with the vertical attachment added, is \$70.00.

These condensers, the vertical attachment, and the achromatic microscopic attachment are only used with the lime light.

### *Dissolving Apparatus.*

The Crescent-shaped Dissolver (see Manual, p. 40, Fig. 16) now extends five narrow fingers each way, in order to more thoroughly blend the pictures over the whole disk, during its passage from side to side.

The rod *b* (Fig. 17), instead of being held by springs outside, between the lanterns R. L. (Fig. 16), now passes just under this surface, through holes in the ends of the case.

Instead of the arms *c* (Fig. 17), the end is now bent into a crank, which is limited in passing from side to side by stops in the case, so as just to allow the dissolver to cover the objectives alternately. When pictures from both Sciopticons are shown upon the screen at the same time, as in the *Soldier's Dream*, etc., the crank is sprung over the stop, so as to point upward, while the dissolver hangs downward.

Base boards for the Sciopticons R. L., each 6 inches wide, hinged at the rear, and hooked down in front when not in use, allow their range to be elevated, as a prop placed under the fore part is drawn back.

These various improvements in the Dissolving Apparatus add greatly to their convenience and efficiency, but not to the price.

The gas dissolving cock, as before said, is attached by letting its wedge-shaped plate down under wide screw-heads projecting from the rear end of the case; there is, therefore, no need of screw holes in the plate. Let it be remembered that the hydrogen left to burn in the lantern not in use, is increased or diminished by screwing in or out the small screws in the stops.

Instead of the legs, shown in Fig. 16, a tripod may be attached to the underside of the case, when preferred, for the greater convenience of transportation.

A curtain enclosing the apparatus and operator may be suspended from cross bars supported by a rod passing up through the case.

---

## THE SCIOPTICON ABROAD.

The Oil Sciopticon has been extensively introduced into foreign countries (from patterns furnished before my later improvements made their appearance), as may be inferred from the frequent allusions to it in foreign journals. In many cases it has, unfortunately, been modified and deteriorated by lessening the cost of construction, and by conforming it to fallacious theories.

It may not be out of place to insert, in this connection,



the following extract from a communication by Walter B. Woodbury to the Manchester Photographic Society, and published in the *British Journal of Photography*, March 1, 1878, page 98, under the heading of—

### *The Modern Magic Lantern.*

This instrument—still best known by its old, unscientific title—has, I think, in no part of the world been more used and experimented upon than in my own native town of Manchester, and therefore I consider it the most fit place to make a few remarks on those in present use. In order that all honor be given to the person to whose researches we owe our present compact and powerful oil lanterns, I wish it to be more widely known that the honor belongs to Mr. Marcy, of Philadelphia, who spent many years in working out and completing what he very appropriately named the Sciop-ticon.

The instrument itself requires no description to members of this Society, as I believe they nearly all possess one—its chief features, as you know, being a narrow double flame, placed edgeways to the condenser, and its very compact body, which does not much exceed the latter in diameter.

Now, next to inventing something useful myself, there is nothing gives me more pleasure than to introduce a foreign invention which I think may prove of use to my fellow-countrymen; therefore, when in America some six years ago, and seeing the advantages of Marcy's invention over the clumsy ill-lit things we were using, I determined to introduce it into this country on my return, and arranged with Mr. Marcy accordingly.

As I expected, the instrument became a great favorite with the scientific public, and no greater proof of its value

could be shown than in the number of imitations that have sprung up, more or less copied from it.

One departure from the Marcy form of wick is found in these, viz., that of dividing it at one end, which I think to be a mistake, as it nullifies the chief feature in the Sciopticon, and is really bringing us partly back to the old circular or broad wick, besides other disadvantages. On my return from America I tried a variety of forms of wicks as well as the triple, but came to the conclusion that no improvement was effected.

There are also new forms of lanterns in the market, but on examination they will all be found to have some parts copied from Marcy's Sciopticon.

At a late *conversatione* of the Philosophical and Literary Society of Leeds, England, a distinguished lecturer opened as follows:—

MR. PRESIDENT, LADIES AND GENTLEMEN:—I have the pleasure, this evening, to introduce to your notice the most charming and effective piece of educational apparatus it was ever my good fortune to possess. \* \* \* The appropriate name of Sciopticon has happily been given to this latest and best form of lantern, and in it I recognize alike emancipation from all its ungainly, troublesome predecessors, and a suitable designation by which to class it with our most useful scientific instruments. To point out and explain all the excellencies of this charming little instrument would require a special lecture. At present, suffice it to say, it is packed in a neat, small case, which can be easily carried in the hand. It can be taken out and set up in action in less than five minutes, and, when the lecture is over, can as soon be packed up.

The weight of the Sciopticon and case, with an average number of slides, all in a strong packing box, is about 40 pounds.

Expressage varies with weight, distance, railroad rules, routes, etc., so that companies are unwilling to furnish the public with their tables of rates, lest their agents should become embarrassed by possible variations. It may, however, afford a convenient clue to state, as a specimen, that the ordinary expressage on 50 pounds from Philadelphia to New York city is 50 cents; to Baltimore, 50 cents; to Washington, 75 cents; to Boston, \$1.05; to Pittsburg, \$1.05; to Wheeling, \$1.65; to Cleveland, \$1.65; to Chicago, \$2.10; to Raleigh, \$2.50; to Charleston, \$2.75; to St. Louis, \$2.75; to Memphis, \$3.00; to Savannah, \$3.75; to New Orleans, \$4.00; to Galveston, \$5.00; to Omaha, \$3.65; to San Francisco, \$11.50.

Freight charges are considerably less, but goods are considered more fully insured, when in charge of express agents.

Our prices and arrangements are made with special reference to having our goods not "handled by middle men," but to their being delivered, without overhauling, directly to the parties who buy and use them. Local dealers, purchasing only when an article is called for, are tempted to favor old styles, or bungling imitations of ours, for their "larger margin," or, if the Sciopticon is specially ordered, then to saddle it with inferior slides, to the no small damage of its reputation. It is easier and safer to send goods and accompanying explanations directly to the party principally interested. Particulars and answers to special inquiries can be communicated more conveniently, and with better grace, in an unbroken line.

For the general catalogue notice, see second page.

## INDEX.

	PAGE		PAGE
Apparatus, .....	3	Insect Metamorphosis, .....	39
American History, .....	20	Lantern Readings, .....	61
American Views, .....	50	Leaf Designs, .....	32
Anatomy and Physiology, .....	45	Lever Slides (Comic), .....	34
Anatomy, Microscopic, .....	45	Life of a Country Boy, ..	24
Astronomical Views, .....	42	Lord's Prayer, The, .....	24
Arachnida, Crustacea, etc., .....	39	Masonic and other Lodges, .....	24
Adventures of Reynard, the Sly Fox, .....	25	Mammalia, .....	37
Birds, .....	38	Microscope and its Revelations, .....	46
Botanical Illustrations, .....	40	Miscellaneous Pictures, .....	26
Bottle, The, .....	23	Natural Phenomena, .....	45
Christiana and her Children, ..	22	New Testament Illustrations, ..	8
Chromatropes, .....	30	Nursery Tales, .....	35
Colored Photographs in Series, ..	36	Old Testament Illustrations, ..	7
Crusaders, .....	25	Optics, .....	46
Crystallography, .....	47	Physical Geography, .....	42
Dioramic Paintings, .....	35	Paintings with Revolving Mo- tion, .....	31
Dissolving Views, .....	28	Pilgrim's Progress, .....	22
Dissolving Chromatropes, .....	31	Reptiles and Fishes, .....	38
Effect Slides, .....	61	Scientific Department, .....	37
Egypt, Views in, .....	11	Schiller's Song of the Bell, .....	25
Fables, .....	25	Shakspeare's Seven Ages of Man ..	24
Flowers and Plants, .....	41	Slip Slides (Comic), .....	33
Foreign Slides, .....	57	Spectrum Analysis, .....	47
Franco-Prussian War, .....	21	Statuary, .....	32, 49
Geology, .....	44	Stomach of a Drunkard, .....	23
Greece and Rome, .....	11	Tam O'Shanter, .....	24
Holy Bible, Complete Illustra- tion of, .....	12	Tale of a Tub, .....	24
Holy Land, .....	9	Ten Commandments, The, .....	23
Hymns, .....	52	Views of Interest in Different Parts of the World, .....	17
Ill-fated Ship, .....	25	Views in Sets, conveying Moral Lessons, .....	22
Insects, .....	39		







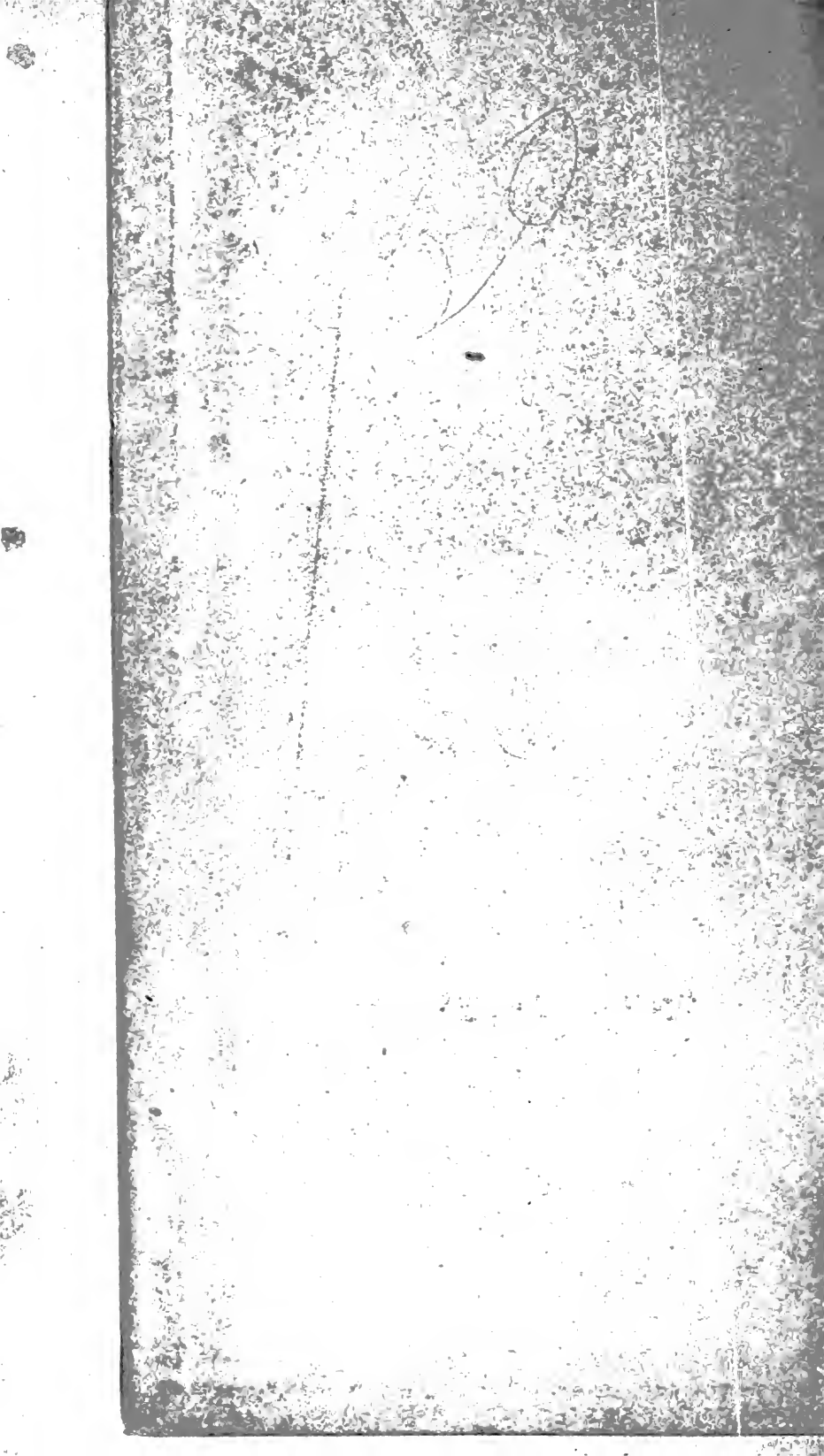



FL: 20-4-69

TR Marcy, Lorenzo J.  
730 The Sciopticon manual  
M32  
1877

~~P&A Sci.~~



PLEASE DO NOT REMOVE  
CARDS OR SLIPS FROM THIS POCKET

---

UNIVERSITY OF TORONTO LIBRARY

---



