



Digitized by the Internet Archive
in 2007 with funding from
Microsoft Corporation

THE SERVICE
OF
COAST ARTILLERY

BY

FRANK T. HINES

UNITED STATES ARMY

Captain, Coast Artillery Corps; Honor Graduate, United States Coast Artillery School

AND

FRANKLIN W. WARD

NATIONAL GUARD OF NEW YORK

Major, Coast Artillery Corps, Ninth Artillery District; Member Division Examining Board for Artillery Officers

PUBLICATION AUTHORIZED BY THE WAR DEPARTMENT



NEW YORK

GOODENOUGH & WOGLOM COMPANY

122 NASSAU STREET

UF450
H6

GENERAL

Copyright, 1910,

By FRANK T. HINES AND FRANKLIN W. WARD

All rights reserved

The Scientific Press
Robert Drummond and Company
New York



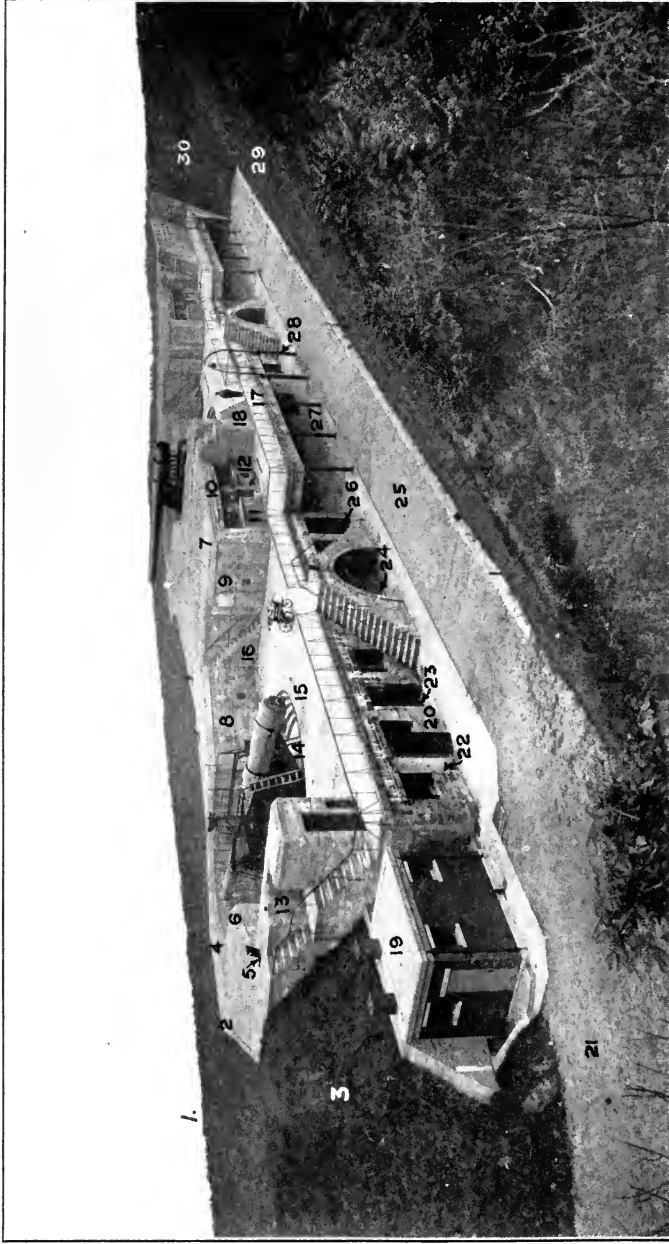

A Seacoast Gun Battery

- | | | |
|-------------------------------|---|--------------------------------|
| 1. Exterior Slope of Parapet. | 16. Platform Stairs. | 24. To Magazine. |
| 2. Superior Slope of Parapet. | 17. Corridor. | 25. Battery Parade. |
| 3. Interior Slope of Parapet. | 18. Corridor Wall. | 26. Office. |
| 4. Blast Slope or Apron. | 19. Latrine. | 27. Gallery. |
| 5. Magazine Ventilator. | 20. Parade Wall. | 28. Crane. |
| 6. Interior Crest. | 21. Approach. | 29. Interior Slope of Parados. |
| 7. Traverse. | 22. To Oil and Tool Room. | 30. Traverse Slope of Parados. |
| 8. Interior Wall. | 23. To Shell Room. | |
| | 9. Traverse Wall. | |
| | 10. Canopy. | |
| | 11. Reserve Table. | |
| | 12. Delivery Table. | |
| | 13. Observing Station
(Crow's Nest). | |
| | 14. Gun Platform. | |
| | 15. Loading Platform. | |

Frontispiece.

PREFACE

FEW words are needed to state the purpose of this work. It represents an earnest attempt to furnish an informative book for the use of coast artillerists with special reference to militia duty in coast defense.

The organization of the United States Coast Artillery presents a need which the National Government is not wholly able to supply. The Coast Artillery Corps of the United States Army at its present strength cannot provide at the utmost for more than one-half of one manning detail for the armament of our far-reaching coast fortifications. To supply this deficiency in personnel Congress has authorized the development of a Coast Artillery Reserve to which various coastwise states have transferred specially qualified regiments of infantry from their militia organizations.

In these regiments, and in other organizations not so transferred whose services will be required as Coast Artillery Supports and Coast Guard, are many officers and men desirous of fitting themselves for the technical service of coast defense. A complete programme of instruction has been issued by the War Department, and it is to supplement this, as well as to furnish a suitable reference book for the Regular personnel, that the present work was prepared.

The authors believe they have brought together in simple form and compact shape the detailed information indispensable to efficiency on the part of the coast artillerist, be he officer or man. In the descriptions of armament and material, they have held strictly to information procured from Ordnance Department publications; as well as Coast Artillery orders, memoranda and circulars. In most cases the information given here is transcribed from official documents. No pretense is made that the work is exhaustive or conclusive, but so far as it goes it has the kindly approval of Brigadier-General Arthur Murray, Chief of Coast Artillery, and other distinguished officers of the Army.

The authors indulge the hope that the order and arrangement of the text may be helpful to every patriotic student of coast defense, and if the hope shall be realized they will consider themselves amply repaid for their labors. Their thanks are due and gratefully tendered to Major William G. Haan, Coast Artillery Corps, for his consistent encouragement, generous advice and valuable suggestions. They desire to express their obligations to Colonel Erasmus M. Weaver, Chief of Division of Militia Affairs; Lieutenant-Colonel Charles J. Bailey, Assistant to the Chief of Coast Artillery; Lieutenant-Colonel Adelbert Cronkhite, Coast Defense Officer, Department of the East; Major Thomas W. Winston, Coast Artillery Corps, editor of the *Journal of the United States Artillery*; and Mr. Samuel L. Williams.

It is believed that this book is better illustrated than any on the subject which has preceded it; an advantage mainly due to the skill of Captain Bruno F. Wetzelberg, Coast Artillery Corps, N. G., N. Y., by whom the original photographs and many of the drawings were made, and to whom the authors are deeply indebted. They also desire to express their thanks to Master Gunner George D. Meece, Coast Artillery Corps, for drawings.

The volume has no other motive than to contribute to the efficiency of a most important arm of the United States military service, The United States Coast Artillery Corps.

FORT WADSWORTH, N. Y., September, 1909.

CONTENTS

CHAPTER I

DEFINITIONS, ABBREVIATIONS AND SIGNS

	PAGE
Including Approved Interpretations of all Technical Terms and Phrases used in the Coast Artillery Service, together with Explanations, Descriptions and Simplified Outlines of all Elements of Coast Defense and Related Subjects.....	1

CHAPTER II

THEORY AND PRINCIPLES OF COAST DEFENSE

Theory of Defense, Attacks from Sea, Plan of Land Defense, Field Combat, Fire in Field Combat and Night Attacks.....	66
--	----

CHAPTER III

ORGANIZATION AND PERSONNEL

The Tactical and Administrative Organization, Personnel, Staff Officers, Coast Artillery Reserve Officers, Commands Appropriate to Grade, and Non-commissioned Officers, etc.....	76
---	----

CHAPTER IV

GUNNERY AND BALLISTICS

Gunnery, Method of Gun Construction, Rifling and its Twist, The Projectile in the Gun, The Projectile in its Flight or the Trajectory, Aiming and Laying, Accuracy of Fire and Practice, Ballistic Symbols and Simple Formulas, Geometrical Magnitudes, etc.....	79
--	----

CHAPTER V

ARMAMENT

Detailed Description and Classification of the Primary, Intermediate and Secondary Armament, Firing Mechanisms, Subcaliber Guns, Recoil Systems, etc.....	107
---	-----

CHAPTER VI

EXPLOSIVES, PROJECTILES, PRIMERS AND FUSES

	PAGE
Low Explosives, High Explosives and Fulminates, their Chemical Properties and Method of Manufacture. Preparation and Blending of Charges, Weights, Velocities, Pressure, etc. Service Projectiles, Color Scheme and Method of Painting, Weights, Penetration, etc. Composition, Construction and Action of all Types of Primers and Fuses.....	245

CHAPTER VII

INSTRUMENTS, DEVICES AND CHARTS

Depression Position Finders, Telescopes, Azimuth Instruments, Surveyor's Transit, Plotting Boards, Mortar Predictor, Range Board, Deflection Boards, Wind Component Indicator, Aeroscope, Time-interval Clock, Interrupter, Telautograph, Telephone, Thermometer, Mercurial and Aneroid Barometers, Anemometer, Atmosphere Board, Open and Telescopic Sights, Gunner's Quadrant, Crusher Gauge, Time-range Board and Powder Chart.....	304
--	-----

CHAPTER VIII

SEARCHLIGHTS

Tactical Location and Use, Types of Projectors, Effective Ranges, Nomenclature and Operation.	402
--	-----

CHAPTER IX

SUBMARINE MINES, SMALL BOATS, ETC.

Mechanical and Electrical Types of Mines, Mine Fire-Control System, Mining Casemate, Loading Room, Method of Making Turk's Head, Telegraph Joint, Okonite Joint, etc. Loading Mines, Duties on the Water, Care and Preservation of Mine Material, Small Boats and Boat Drill	414
--	-----

CHAPTER X

SEACOAST ENGINEERING

Theory of, Location and Measurement of Base Lines, Triangulation in Connection with the Location of Horizontal Base Lines, Gun Centers and Directing Points of Batteries, Determination of the True Azimuth, Location of Pintle Centers, Orientation of Gun and Mortar Azimuth Circles (with problems), Leveling and Hydrographic Surveying.....	431
--	-----

CHAPTER XI

CORDAGE

	PAGE
Types of Ropes, Method of Making Splices, Knots, Hitches and Straps, Blocks and Tackle, Power of Tackle, Levers, Differential Pullies, Gins, Shears, Derricks and Cranes, and Hydraulic Jacks.	460

CHAPTER XII

MAGAZINE RIFLE

Points in Handling, Dismounting and Assembling, Cleaning, and Care, Gun Sling, Ammunition, Ball Cartridge, Blank Cartridge, Dummy Cartridge and Guard Cartridge.	483
--	-----

CHAPTER XIII

POINTS FOR COAST ARTILLERISTS

Battle Commanders, Battle Command Drill, Fire Commanders, Fire Command Drill, Orders of Fire, Searchlight Commands, Communication Officer, Battery Commanders, Solution of Target Practice Problem, Adjustments of Gun and Carriage, Training of Personnel, Calibration, Observation of Fire, Emplacement Officers, Range Officers, Tug Officer and Observer, Shore Tug Signals, Maneuver Signals, Sound Signals, Wig-wag Signals, Night Signals, Wireless Communication, Observers, Gun Pointers, Range Setters, Meteorological Observers, Tide Observers, Camp Sanitation, and Types of War Vessels.	494
--	-----

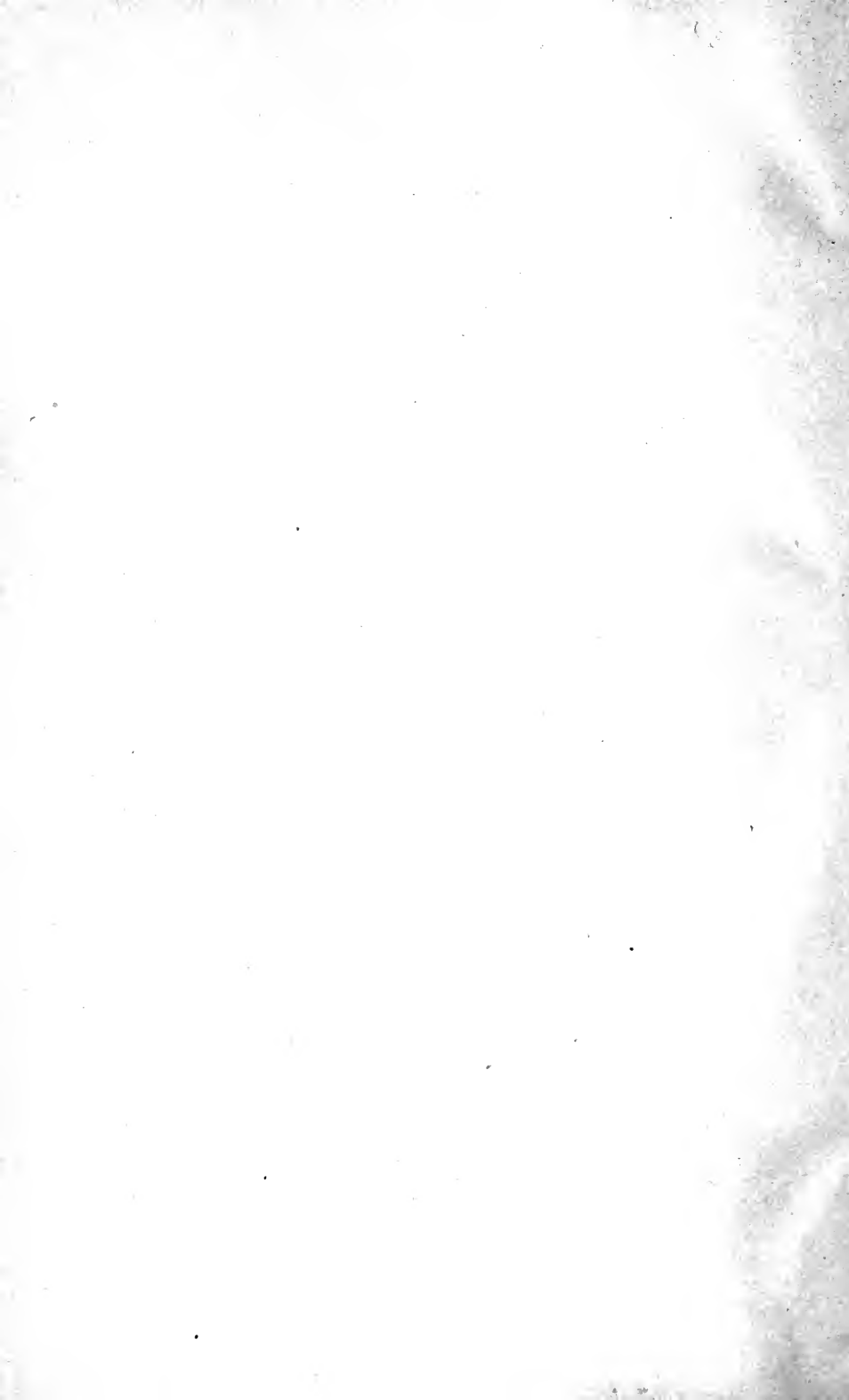



THE SERVICE OF COAST ARTILLERY

CHAPTER I

DEFINITIONS, ABBREVIATIONS AND SIGNS.

INCLUDING APPROVED INTERPRETATIONS OF ALL TECHNICAL TERMS AND PHRASES USED IN THE COAST ARTILLERY SERVICE, TOGETHER WITH EXPLANATIONS, DESCRIPTIONS AND SIMPLIFIED OUTLINES OF ALL ELEMENTS OF COAST DEFENSE AND RELATED SUBJECTS.

"A" Row.—See HOOPS.

Abatis.—In field fortification, rows of felled trees, with the smaller branches lopped off, and the others sharpened and turned towards the enemy.

Abbreviations.—See page 63.

Absolute Deviation.—The distance measured in a straight line from the center of the target to the point of impact.

Accumulator Room.—A room in the battery provided for a storage battery.

Adjutant.—See ARTILLERY DISTRICT ADJUTANT, POST ADJUTANT.

Aeroscope.—A device used in the meteorological station and the fire, mine, and battery primary stations for the indication of the azimuth of the wind in degrees, the velocity of the wind and the density of the atmosphere by reference numbers. In the latter stations it may also contain a dial indicating the height of tide.

Aiming.—The operation, with the aid of a sight, of giving a cannon the direction and elevation necessary to hit the target.

Air Spaces.—The galleries and narrow spaces around interior rooms to facilitate ventilation and assist in keeping the rooms dry.

All-Round-Fire.—Fire delivered through the entire circumference of an azimuth circle.

Ammunition.—Any material used in charging ordnance, as powder, shot, shell, etc.

Ammunition Hoist.—The device by means of which ammunition is raised to the loading platform. Separate hoists are used for projectiles and powder, or the latter is served by hand.

Ammunition Recess.—The space built in the parapet wall at loading platform level for the temporary storage of ammunition.

Ammunition Shoes.—Any type of slipper made entirely of a non-metallic substance.

Ammunition Truck.—A steerable three-wheeled truck, with suitable space for carrying a complete charge from the delivery or reserve table to the breech of cannon.

Anemometer.—An instrument used in the meteorological station to determine the velocity of the wind in miles per hour.

Aneroid Barometer.—A watch-shaped instrument used in the meteorological station to determine the pressure or density of the atmosphere.

Angle.—The figure made by two straight lines that meet or would meet if sufficiently prolonged, or, two straight lines starting from the same point. It is measured by the arc of a circle included between its sides, the center of the circle being its vertex. An angle of 90 degrees is known as a *right angle*; an angle of more than 90 degrees is known as an *obtuse angle*; one less than 90 degrees as an *acute angle*.

Angle of Departure.—The angle between the line of departure and the line of sight. This is the angle given in range tables. See QUADRANT ANGLE OF DEPARTURE.

Angle of Fall.—The angle of fall is the angle which the tangent to the trajectory at the point of impact makes with the line of shot. In practical gunnery the angle of fall is often expressed as a slope, i.e., 1 on 10, meaning that for one foot of drop in vertical height the projectile would travel ten feet horizontally.

Angle of Impact.—The complement of the angle of incidence.

Angle of Incidence.—The angle between the line of impact and the normal to the surface at the point of impact.

Angle of Jump.—See JUMP, ANGLE OF.

Angle of Position (or Depression).—The angle between the line of sight and a horizontal plane through the axis of the trunnions.

Angle, Quadrant.—See QUADRANT ANGLE.

Angle, Striking.—See STRIKING ANGLE.

Angular Elevation or Depression.—The angular elevation or depression of the target includes the depression due to the curvature of the earth. It is sometimes called *position angle*.

Angular Velocity.—The ratio of the angular travel or motion of a body, to the time consumed in describing the angle.

Approaches.—The water area over which the enemy may be expected. In fortification, roadways entering the battery parade.

Apron.—The reinforced concrete or metal portion of the superior slope of a parapet and the interior slope of a mortar pit designed to protect against blast. Also called *blast slope*.

Arc.—Any part of a circumference.

Area.—An extent of surface.

Armament.—Guns and mortars of various sizes and powers, including their carriages. In the coast artillery service armament is classified as primary, in ermediate, and secondary.

Armor.—The protection afforded the sides and decks of warships. It is classified as wrought iron, compound, all steel and face-hardened armor.

Armor Belt.—The side protection of the vitals of warships.

Armor-Piercing Projectiles.—Shot and shell designed to penetrate heavy side and turret armor of war vessels.

Armstrong Guns.—The built-up gun construction of Great Britain, the germ of which is to be found in the coiled welded system of Sir William Armstrong, introduced in 1852.

Armstrong Rapid-Fire Gun.—A seacoast cannon usually 40 to 50 calibers long and of 6-inch and 4.72-inch caliber. The latter is usually called "four point seven."

Artillery.—The name given to all firearms discharged from carriages ashore in contradistinction to "small arms," which are discharged from the hands. It also denotes the particular troops employed in the service of such firearms.

Artillery in the U. S. military service is known as coast artillery and field artillery, the latter being classified as light artillery, horse artillery, siege artillery, and mountain artillery.

Artillery District.—An artillery district is a subdivision of the coast line, including the entire personnel of coast artillery troops proper, and coast artillery supports assigned to duty in connection with the fixed defenses thereof.

For tactical purposes it consists of those battle commands which are within supporting distance of one another.

For administrative purposes, forts not within supporting distance may be included in the district.

In the regular service, districts are designated by name, as "Eastern Artillery District of New York," "Artillery District of the Columbia," etc. In the organized militia it is customary to designate them by number, as "Thirteenth Artillery District, N. G., N. Y."

Artillery District Adjutant.—A coast artillery officer responsible, under the district commander, for the various reports, returns, rosters, details, records, orders and communications pertaining to the administration of an artillery district, together with all other duties prescribed for regimental adjutants so far as they are applicable to artillery districts. His tactical duties are those of a communication officer of a battle command, unless otherwise assigned by the district commander.

Artillery District Commander.—District commanders are assigned to artillery districts in orders from the War Department. The command of an artillery district devolves upon the senior regular coast artillery officer present, whether he has been assigned in orders or not. However, with the sanction of higher authority a district commander may continue to exercise the more important functions of his command when absent temporarily from his district on artillery duty.

The district commander assigns field officers as battle, fire and mine commanders, and staff officers as searchlight and communication officers. In detailing officers other than staff officers as searchlight and communication officers no battery should be left with less than the number of officers required by its manning table. If officers are not available, non-commissioned officers should be detailed.

The district commander is responsible for the efficiency of his district. He has control within its limits of all matters relating to artillery instruction, drill and practice, and is responsible for the procurement of the proper supplies and

accessories. He sees that orders prescribing drills and other exercises are properly and uniformly carried out.

Accompanied by members of his staff, he inspects all forts in his district at prescribed periods. During the period for out-door instruction he inspects all armament, fire-control equipment, light equipment, all necessary material and fort record books and battery emplacement books. On these occasions the personnel are required to be at their posts and the inspection includes drills of the various elements of the defense, as well as the physical condition, clothing and equipment of the personnel.

Within the time specified in orders after the last inspection of each quarter, he submits his quarterly report on the prescribed form, through military channels, to The Adjutant General of the Army.

The operation of all means of water transportation, assigned by competent authority, for exclusive use of the artillery district, including harbor vessels, tugs, lighters, dispatch boats and landings is under his supervision. He sees that economy is exercised in their maintenance and operation. He makes the official visits required to foreign and naval officers visiting in the harbor.

He conducts combined artillery drill and tactical exercises of all the elements of defense of his district, in accordance with existing orders.

He regulates the boat service so that a target may be towed one day each week for each post during the out-door period.

He is charged with the preparation of all plans of defense for his district against hostile attack, and forwards a copy thereof through military channels, to the Chief of Coast Artillery, for approval and makes such suggestions as to the modification thereof as may, in his opinion, be required by new conditions.

He should have knowledge of the plans of the general defense of the coast line in the vicinity of his district and be instructed by the general officer commanding as to his duties in connection therewith.

During hostilities he is charged with the supervision of all military operations in his district and in connection therewith. He establishes and maintains a system of security and information on both the water and land fronts. He keeps the various subordinate commanders informed as to conditions. He appoints the artillery district staff officers; and upon proper recommendation and examination appoints the non-commissioned officers and men of the several grades and ratings serving in companies, in the district.

In the organized militia the commanding officer of an organization assigned to the coast artillery reserve, when at home station, receives this title.

Artillery District Commander's Flag.—See FLAG OF ARTILLERY DISTRICT COMMANDER.

Artillery District Engineer.—See DISTRICT ARTILLERY ENGINEER.

Artillery District Ordnance Officer.—A coast artillery officer charged with the requisition, accountability, inspection and repair of all ordnance property and stores pertaining to the seacoast armament and equipment of an artillery district. He has immediate supervision and control of the district machine shop and resident machinists. His tactical duties may be those of communication or searchlight officer of a battle command, unless otherwise assigned by the district commander.

Artillery District Quartermaster.—An officer of the Quartermaster's Department, or a coast artillery officer, who is accountable and responsible for

all quartermaster property used in connection with district headquarters, and all water transportation assigned for use of the artillery district, including harbor vessels, etc. Under the district commander he is responsible for their maintenance and supply, personnel, and operation. If a coast artillery officer, his tactical duties are prescribed by the district commander.

Artillery Engineer.—See DISTRICT ARTILLERY ENGINEER.

Artillery Garrison.—The personnel assigned to duty at a coast artillery fort.

Atmosphere Board.—A device pertaining to the equipment of the meteorological station. A graphic table by means of which the reference numbers to be recorded on the dial of the aeroscope indicator can be determined from readings of the barometer and thermometer.

Automatic Firing.—A term applied to one of three methods of exploding submarine mines, i.e., where the apparatus is so arranged that the mine explodes upon contact.

Automatic Machine Guns.—Rapid-fire guns in which the force of recoil is used to operate the breechlock and to load and fire the piece.

Auxiliary Horizontal Base System.—When either the battery primary or secondary station becomes inoperative, the battery commander's station is used as a base end station in place of the disabled station.

Auxiliary Power Plant.—See SECONDARY OR AUXILIARY POWER PLANT.

Axial Vent.—A vent in which the opening is parallel with the axis of the bore. It is the type of vent used in modern seacoast cannon.

Axis.—A straight line, real or imaginary, passing through a body, on which it revolves or may be supposed to revolve.

Axis of Gun.—The axis, or central line, of the bore.

Axis of Trunnions.—That axis, or central line of the trunnions.

Azimuth of a Point.—In coast artillery, the horizontal angle measured in a clockwise direction from south to a line from the observer to the point. For example, the azimuth of a point *B* from *A* is the angle (measured clockwise from the south) between the north and south line through *A* and the line from *A* to *B*. The north point has an azimuth of 180 degrees.

Azimuth Difference.—The difference between two azimuths of a point as read from two other points, as, for example, the difference between the azimuth of the target as read from the primary station and the azimuth of the target as read from the directing gun or point of a battery.

Azimuth Instrument.—An instrument for determining azimuths. It is sometimes used as a position-finding instrument in secondary stations.

Azimuth Setter.—The member of a mortar detachment who lays the mortar in azimuth.

"B" Row.—See HOOPS.

Backlash.—The play between a screw and its nut where the latter is loosely fitted. A reverse movement of any part of a mechanical gear, caused by irregularities, without moving other connecting parts.

Bale.—That part of an assembled submarine mine used for the attachment of the mooring cable to the mine case; also provided for the protection of the joint where the single conductor cable enters the mine.

Ballistic Board. See RANGE BOARD.—A device used to determine the total range corrections to be applied to the range found on the plotting board.

Ballistic Tables.—Tables of data used in connection with ballistic formula

in the solution of ballistic problems; certain functions used in the various formulas are previously calculated for the certain velocities and then tabulated.

Ballistics.—That branch of the science of gunnery which treats of the motion of projectiles.

Bandoleer.—A khaki-colored small arms ammunition belt, consisting of six pockets, each containing two clips or ten rounds. Worn over one shoulder and under the opposite arm.

Banquette.—The step between the truck and loading platform.

Banquette Tread.—In field fortification, a tread or foot bank running along the inside of the interior slope upon which soldiers stand to fire over the parapet.

Bar and Drum Sight.—An open sight used on rapid-fire guns.

Barbette.—A mound of earth or a platform on which guns are mounted to fire over a parapet. In field fortification this level is distinguished by the name of *Banquette Tread*.

Barbette Carriage.—See CARRIAGE OR MOUNT.

Barometer.—See ANEROID BAROMETER and MERCURIAL BAROMETER.

Base-end Station.—An observing station located at either end of a base line, designed to contain an azimuth instrument or depression position finder. Base-end stations are designated as primary, secondary, or supplementary.

Base Fuse.—A firing device inserted in the base of cored shot and armor-piercing shell to ignite the bursting charge. Base fuses are used when the point of shell requires great strength, as for penetrating armor.

Base Line.—A horizontal line the length and direction of which has been determined. This line is used in position finding, especially for long ranges; the stations at its ends are called base-end stations. It is called "right" or "left" handed, depending on whether the primary station is to the right or left of the secondary facing the field of fire.

Battery.—The entire structure erected for the emplacing, protection and service of one or more guns or mortars, together with the guns and mortars so protected. The guns of a battery are of the same size and power, and are grouped with the object of concentrating their fire on a single target and of their being commanded directly by a single individual.

Normally a battery of the primary armament consists of two guns or two pits of mortars. Under exceptional circumstances a single gun with its fire-control service may constitute a battery.

In the case of intermediate and secondary armament a battery may consist of any number of guns assigned to it.

Battery Commander.—The senior artillery officer present for duty at a battery.

The battery commander exercises both administrative and tactical command.

As an administrative officer he is responsible that every effort is made to keep the battery supplied with the proper equipment, implements and ammunition. He keeps a record of the daily attendance at drill and instruction, with names of absentees, reason and authority for such absence.

As a tactical officer he is responsible that the personnel of his battery is efficient in drill, in practice and in action, that the equipment and fire-control installation provided for his battery are in serviceable condition and that no permanent modifications are made therein without proper authority. He is

required to see that the officers and men of his battery are instructed in the care, preservation and use of artillery material, and that records are kept and reports rendered as prescribed in orders and regulations.

He is authorized to modify the manual of the piece within the limits prescribed by the drill regulations and to make temporary modifications or changes in the fire-control installation, provided such modifications or changes permit of prompt return to their original condition. Permanent changes may be made in the provisional installations upon the approval of the district commander, the changes to be reported to the War Department. Changes in the standard installation can only be made with the approval of the War Department.

He should be encouraged by his superiors to improvise devices and methods that will simplify the fire-control system or increase the efficiency of his command.

He is responsible that the plotting-room details for the fire and battle commanders' stations are kept in practice during the period of indoor instruction.

He should inspect his battery and make a test of the fire-control system thereof weekly.

In battle command or fire command drill or action he exercises limited fire control, acting on orders received from higher commanders. When "battery commander's action" is ordered he exercises independent fire-control and fights his battery in accordance with his own judgment. In cases of emergency he acts without waiting for orders, in accordance with instructions previously given.

Battery Commander's Station.—An observing station at or near the battery, usually in rear of the center traverse. The new type is a combined observing room, emergency instrument room, plotting room, etc., at the rear of the traverse.

Battery Commander's Walk.—The elevated walk leading from the battery commander's station along the rear of the battery.

Battery Emplacement Book.—A loose-leaf record book provided for each battery, in which all important data relating to the emplacements, guns, fire-control equipment, etc., of a battery are kept.

Battery Field of Fire.—The area covered by the armament of a battery; it covers that portion of the fire area which can be most conveniently defended by the battery in question.

Battery Manning Table.—A table containing a list of names detailing the personnel of a battery to their posts.

Battery Parade.—The area in rear of the emplacements of a battery where the sections form.

Battle Area.—The area covered by the armament of a battle command.

Battle Chart.—A chart used in battle, fire, and mine command stations which covers their respective areas. It is constructed to show the channels and different depths of water passable by the several types of war vessels; i.e., the sector of any water area navigable by battleships, cruisers, torpedo boats and smaller craft. It also shows the sectors of fire of the several batteries in the particular command, and in the case of mine commands the position of the fields, etc. It also shows the penetration in Krupp armor for each 1,000 yards of range for the several classes of armament. It is provided with an

azimuth circle the center of which marks the location of the station to which the chart belongs.

Battle Command.—A battle command includes that portion of the armament assigned to any particular portion of the water area of an artillery district in which a naval attack may be expected and over which one man may exercise efficient control of the artillery fire and other means provided for defense.

Two or more fire commands and one mine command usually constitute a battle command. There may be one or more battle commands in an artillery district.

Two or more artillery forts or posts situated so that their armament covers the same or adjacent water areas may constitute one battle command.

Responsibility for the sufficiency and condition of the material of a battle command devolves upon the commanding officers of districts or posts in which the battle command is located.

Battle Commander.—A coast artillery officer assigned as such in orders from district headquarters. He commands, for tactical purposes only, the personnel of a battle command and is responsible for its tactical efficiency.

A battle commander sees that all orders prescribing battle-command drills and other exercises are properly and uniformly carried out. By frequent visits to the fire commands he keeps posted as to the condition of the material and personnel, so as to be able to report at all times as to their drill efficiency and the condition of his battle-command service. He should exercise in battle-command drill and in action, fire control throughout his command and over the battle area, and command the fire action from his station—from which the whole battle area and approaches thereto should be visible.

He should have full knowledge of the nature and position of the mine fields and any obstructions in his battle area and should be in communication with the district commander, and his fire and mine commanders. He should be informed of the general scheme of land defense, and after a careful study of his battle area, prepare plans of defense against the forms of attack liable to be adopted by the enemy. He should be prepared to prevent reconnaissance in force on the part of the enemy calculated to determine the strength and location of the batteries.

At night the searchlights assigned to his battle area are under his immediate control. Searchlights intended primarily for the mine service remain ordinarily under the control of the mine commander, but when the battle commander deems it necessary to use a mine-field light for searching, such light is under control of the searchlight officer temporarily.

Battle Commander's Station.—A station overlooking a battle area, occupied by the battle commander, and necessary assistants, during drill or action.

Battle Flag.—The national flag (garrison flag) displayed at a seacoast or lake fort at the beginning of and during an engagement, whether by day or night. It is also flown from the mainmast of vessels engaged.

Battleships.—War vessels of massive appearance with broad beam as compared with length. They have heavily armor-plated turrets and belt from 8 to 18 inches in thickness; deck and other armor 3 to 6 inches in thickness. Average displacement 10,000 to 26,000 tons; length 375 to 550 feet; beam 60 to 75 feet; draft 24 to 30 feet; speed 16 to 21 knots (the measure of a nautical mile or knot is 6080.27 feet, as against a statute mile, which measures 5280 feet).

Armament consists of: *Main*, 14-inch, 13-inch, 12-inch. *Intermediate*, 8-inch, 7-inch, 6-inch guns, and torpedo tubes. *Secondary*, 3-inch and smaller rapid-fire guns.

Battle Tactics.—As pertaining to fortress warfare, the science of the disposition and handling of coast artillery units in action.

Berm.—In field fortification, a moulding of natural ground between the foot of the exterior slope and the scarp.

Bevel Wheel.—A wheel having teeth cut on a bevel or conical surface called a face; where the inclination of the face is 45 degrees it is called a *miter wheel*. Two of these wheels with teeth engaged at right angles to each other form a bevel or miter gear.

Bivouac.—A temporary place of repose for troops, in which they are sheltered by shelter-tents, bowers, or improvised shelter of any kind, or sleep in the open air.

Blast.—See POWDER BLAST.

Blast Slope or Apron.—See APRON.

Blasting-Gelatine.—The most powerful of the detonating and disruptive explosives. It is only suitable for purposes of demolition.

Blending Powder.—The process of mixing powders of the same or different lots so as to obtain charges of uniform characteristics.

Blending Room.—A dry, well-lighted and ventilated room in which several charges of the same lot of smokeless powder are taken from the powder storage cases and thoroughly mixed and blended.

Blind Shell.—A shell which does not explode upon impact or when intended to do so.

Boat Telephone.—A simple type of telephone used in communicating over cable between boats at distribution boxes in the mine field and the mining casemate.

Bomb.—A missile which also receives the names of bombshell and shell. The use of the word is practically obsolete in gunnery.

Bomb-Proof.—A term applied to military structures of such immense thickness and strength that shells can not penetrate them.

Booth or Recess.—Any recess or construction for the accommodation of telautograph, telephone, etc.

Bore.—The interior of a cannon forward of the front face of the breech block. It is composed of the powder chamber, the centering slope, the forcing cone, and the rifled portion, called the main bore.

Bore, Length of.—See LENGTH OF BORE.

Bore-Plug.—See CLINOMETER REST.

Bore-Sighting.—In coast artillery, the process by which the line of sight and axis of the bore prolonged are caused to converge on a point at or beyond mid-range.

Bottom of the Bore.—The surface of the powder chamber formed by the face of the obturator-head when the breech-plug is home.

Bound.—The path of a shot comprised between two grazes.

Bourellet.—That part of a projectile between the main body and the head, which includes the beginning of the ogive.

Brackets.—Metal supports for telautograph cases, etc.

Breech.—The mass of metal behind the plane of the bottom of the bore.

Breechblock.—The metal plug which closes the breech.

Breech Bushing.—That part of the breech which contains the threaded and slotted sectors of the breech recess.

Breech Detail.—A detail of the gun detachment charged with the duty of opening and closing the breech.

Breech, Face of.—See FACE OF BREECH.

Breech Mechanism.—The breechblock, obturating device, firing mechanism, and mechanism for operating the breechblock.

Breech Recess.—That part of the cannon which receives the breechblock.

Breech Reinforce.—The part of the cannon in front of the breech and in rear of the trunnion band.

Brown Prismatic Powder.—A brown gunpowder of translucent celluloid appearance, in the form of a six-sided prism with a hole in the center.

Building up Charges.—The operation of preparing charges of brown prismatic, nitro-cellulose or spero-hexagonal powder, by properly placing the grains in silk bags.

Built-up Cannon.—Types of cannon in which the parts are built up of either cylindrical forgings or a single forging wrapped with a rectangular or ribbon form of wire.

Buoy.—A floating object moored to the bottom, used for temporarily marking the positions of mines, junction and distribution boxes, channels, and target positions.

Bursting Charge or Shell Filler.—The charge of explosive required for bursting a projectile; it may be poured in loose or by melting.

Butt.—In gunnery, a solid earthen parapet, to fire against in the proving grounds or in practice.

Button Drill Primer.—A form of primer so called from the fact that the head of the friction wire is formed in the shape of a button.

“C” Row.—See HOOPS.

Cake Powder.—Gunpowder which has become lumpy from having absorbed moisture.

Caliber.—A name given the minimum diameter of the bore of a firearm; it is the diameter of the main bore in inches measured at the top of diametrically opposite lands, or minimum diameter of the rifled portion of the bore. Also used to express the length of cannon; e.g., a 12-inch gun 42 calibers long would be 42 feet long; a 6-inch gun 52 calibers long would be 26 feet long.

Calibration.—The operation of adjusting the range scale so that the range reading at any particular elevation of the gun will indicate the true distance to the center of impact of a group of shots fired from that particular gun and mount at that elevation with the standard velocity and under normal atmospheric conditions.

It is desirable to calibrate the guns of a battery under the same atmospheric conditions, although this is not absolutely necessary. It is absolutely necessary that uniform ammunition be used for calibration firing of all guns of a particular battery. When the individual guns of a battery are calibrated the battery is calibrated, for the centers of impact of a series of shots from each gun under normal atmospheric conditions will coincide at the point indicated by any range setting. When guns of a battery “shoot together” (that is, give the same range for the same range setting) they may be fired on the same data, but are

not calibrated unless the range under normal atmospheric conditions is that indicated by the range setting.

It is not feasible to determine by actual firing all the points of a range scale, and therefore it is assumed that the gun is calibrated when a range scale constructed from a computed range table is adjusted on the gun so as to give the proper setting for a mid-range.

Call to Arms.—A musical signal at which, if practicable, each man goes direct to his post at a run.

Cannister.—A projectile with a thin wall inclosing a number of small steel balls but without a bursting charge, the case being ruptured by the shock of discharge as the projectile leaves the gun. Designed for use against infantry at short range.

Cannon.—A general term for artillery weapons and firearms not carried nor fired in the hands, from which projectiles are thrown by the force of expanding powder gases.

Guns are long (generally from 30 to 50 calibers) have flat trajectories, and are used for low-angle fire (less than 15 degrees), with high velocities (from 2000 to 3000 f.s., about).

Mortars are short (generally about 10 calibers), and are used for high-angle fire (from 45 degrees to 70 degrees), with low velocities (from 550 to 1300 f.s., about).

Howitzers are intermediate between guns and mortars.

The term "piece" is used when referring to a cannon of any class. Cannon in the United States land service are classified according to their use into coast, siege, and field.

Cannon Ball.—Properly speaking, this term should only be applied to spherical solid projectiles which are fired from cannon.

Cannon Powder.—A term applied to large-grained black or brown gunpowder to distinguish it from rifle, mortar or mammoth powder. It is used as a base in the manufacture of prismatic powders.

Cannonade.—The act of discharging shot and shell from cannon for the purpose of destroying an enemy. To discharge cannon. Also written *canonry*.

Cannoneer.—An artilleryman engaged in the firing, or one who manages or assists in managing a cannon.

Canopy.—The projecting roof over delivery tables of ammunition hoists of modernized gun batteries.

Cap-Square.—That portion of the iron work of a gun or mortar carriage which folds or laps over the exterior portion of the trunnions to keep the piece from jumping out of the trunnion bed.

Capital.—The line through the gun pintle perpendicular to, or bisecting the arc of the interior crest.

Capped Projectile.—A projectile having a soft iron cap over its point to give stability to the point when commencing penetration and to give the armor an initial pressure at the point of penetration.

Carriage or Mount.—The means provided for supporting a cannon. It includes the parts for giving elevation and direction, for taking up the recoil on discharge, and for returning the piece to the firing position. They are classified as follows:

1. *Fixed.* A mount provided for guns and mortars in permanent works and not designed to be moved from place to place.

2. *Movable or Wheeled.* A carriage or mount provided with wheels for ready transportation of the piece mounted thereon. Guns of the movable armament are mounted on this type of carriage.

COAST CARRIAGES. Those used for coast artillery cannon. They may be divided into four classes, depending upon the nature of cover afforded by the emplacements:

a. *Barbette.* Where the gun remains above the parapet for loading and firing.

b. *Disappearing.* Where the gun is raised above the parapet for firing, and recoils under cover for loading.

c. *Masking mount.* Where the gun remains above the parapet for loading and firing but can be lowered below the level of the crest for concealment.

d. *Casemate.* Where the gun fires through a port.

RAPID-FIRE GUN CARRIAGES (except the 6-inch on disappearing carriage) are constructed so that the gun recoils in a sleeve and returns to the loading position immediately after firing.

Note.—If the carriage can be traversed so that the gun may be fired in all directions it is said to have all-round fire. If it can not be traversed so that the gun can be fired in all directions, it is said to have limited fire.

Cartridge.—A complete charge contained in or held together by a case or shell of metal.

Cartridge Bags.—Bags made of a special quality of silk and sewed with silk thread; used to contain the powder charge for cannon. This material burns rapidly and completely, thus avoiding the danger of a smouldering residue in the powder chamber.

Cartridge Extractor.—That part of a breech-loading gun which ejects the empty cartridge case from its seat in the bore.

Cartridge Room.—A room of the magazine for the storage of cartridges.

Case.—The charge holder of a submarine mine.

Case I.—In gunnery, a class of gun pointing where direction and elevation are both given by the sight.

Case II.—In gunnery, a class of gun pointing where direction is given by the sight and elevation by the range scale on the carriage.

Case III.—In gunnery, a class of gun pointing where direction is given by the azimuth scale and elevation by quadrant or by the range scale on the carriage.

With mortars this Case is used exclusively. It is used with guns, (1) in firing by battery, (2) when the position of the target is known but the target is not visible from the gun on account of smoke, fog, etc., (3) in predicted firing by piece when for any reason direction cannot be accurately given by the sight.

Casemate.—An obsolete bombproof chamber, usually of masonry, in which cannon were placed to be fired through embrasures or portholes; or one capable of being used as a magazine. See **MINING CASEMATE**.

Casemate Battery.—A storage battery in the mining casemate provided as a means of furnishing direct current for the mine system.

Casemate Electrician.—A specially qualified member of a mine command

assigned to the care and operation of the mining casemate. **Insignia:** Red mine case with red bar below within a yellow circle, all to be of cloth.

Casemate Officer.—A coast artillery officer stationed at the mining casemate who controls its operation.

Casernes.—In a general acceptance, casernes signify barracks.

Cast-Iron Shot.—Projectiles made of cast iron, used in service target practice.

Castramentation.—The art or act of encamping, or the act of marking or laying out a camp.

Cathead.—A projecting piece of timber or iron with a pulley at the head, attached to either side of the bow of mine planters, by which anchors and mine cases are hoisted or lowered.

Center of Gravity.—That point in a body, or system of bodies rigidly connected, upon which the body or system will balance itself in all positions, though acted upon by gravity.

Center of Gravity Band.—A painted band one-half a caliber wide on gun projectiles, and six inches wide on mortar projectiles. The center of gravity of the projectile is the center of the band. It also indicates where the shot tongs are placed.

Center of Gravity of Cannon.—The center of gravity of a cannon is near the intersection of its axis and the axis of the trunnions. The preponderance is the excess or moment of weight in rear of the axis of the trunnions over that of the front, or the converse.

Center of Impact.—The mean point of impact, or the mean of all the hits. When a projectile strikes the target a number of times, it is the mean trajectory.

Center Pintle.—A term applied to a seacoast carriage when its axis of rotation is approximately through the center, that is, when it traverses about a point at its center.

Centering Slope.—The conical part of the powder chamber between the main chamber and the forcing cone.

Centrifugal Force.—A force whose direction is from a center. For instance, water is thrown from the blades of a propeller from the force issuing from its center.

Centrifugal Fuses.—Firing devices, the action of which depend upon centrifugal force; inserted either in the base or point of an armor or deck-piercing shell to ignite the bursting charge.

Chamber.—See SHOT OR POWDER CHAMBER.

Charge.—The charge consists of the powder and the projectile. The powder for all large cannon, to include 4.7-inch guns, is enclosed in silk or serge bags and is separate from the projectile. In guns of greater caliber than six inches it is put up in two or more sections or bags. For smaller calibers the projectile and powder are not separate; such ammunition is called "fixed."

Charts.—See HARBOR, DIFFERENCE, POWDER, VESSEL, BATTLE AND SYMBOL CHARTS.

Chase.—The part of a cannon in front of the trunnion band.

Chassis.—The traversing base frame of a gun carriage upon which the top carriage moves backward and forward.

Chief Loader.—A non-commissioned officer in charge of the loading of sub-

marine mines. Insignia: Red mine case within a yellow circle, all to be of cloth.

Chief of Ammunition Service.—A non-commissioned officer in charge of the magazines, galleries, and service of ammunition for a gun battery, or a mortar emplacement.

Chief of Coast Artillery.—A general officer of coast artillery charged with the duty of keeping the War Department advised of the efficiency of the coast artillery personnel and material, and making such recommendations as will tend to promote its efficiency; to confer with and advise the chiefs of bureaus in all matters relating to coast artillery; to correspond direct with commanders of artillery service schools and the president of the Artillery Board on questions of a technical character not involving matters of command, discipline, administration or the status or interests of individuals; to make recommendations as to the instruction, examination, promotion, assignment, special duty, and transfer of coast artillery officers and men, as well as methods and courses for their instruction; to issue direct to coast artillery officers bulletins and circulars on technical matters. He is a member of the General Staff Corps and the Board of Ordnance and Fortifications.

Chief of Coast Artillery's Flag.—See FLAG OF CHIEF OF COAST ARTILLERY.

Chief Planter.—A non-commissioned officer in charge of the service of a mine planter. Insignia: Red mine case within a yellow circle, all to be of cloth.

Chronograph.—An instrument for measuring the velocity of projectiles.

Chronometer.—An instrument for accurately measuring time.

Circle.—A plane figure bounded by a curved line, called its circumference, which returns into itself, and which is everywhere equally distant from a point within it called a center. A circumference is divided into 360 equal parts, each of which is known as a *degree*; each degree into 60 parts, each of which is known as a *minute*; each minute into 60 parts, each of which is known as a *second*. In the coast artillery service degrees are divided into *hundredths*, and the minutes and seconds eliminated.

Circuit-Closer.—A device by which submarine mines are fired electrically by the vessel closing the circuit.

Circumference.—See CIRCLE. The circumference of any circle is 3.1416 times the length of its diameter.

Cleaner.—An artilleryman charged with the care of armament out of service.

Clinometer.—An instrument for measuring accurately the inclination of the axis of the bore to horizontal.

Clinometer Rest.—The support for a clinometer inserted in the muzzle of the gun; it is also called *bore-plug*.

Coast Artillery Board.—A board, consisting of such number of coast artillery officers as the War Department may direct, to which may be referred from time to time all subjects pertaining to the coast artillery upon which the War Department or the Chief of Coast Artillery may desire the board's opinion and recommendations.

Coast Artillery Company.—An integral part of the Coast Artillery Corps, assigned to some portion of the armament. The strength is fixed in orders; the present authorized personnel of a gun company of the primary armament is, Captain, 1 First Lieutenant, 1 Second Lieutenant, 1 First Sergeant, 1

Quartermaster Sergeant, 8 sergeants, 12 Corporals, 2 Mechanics, 2 Musicians, 2 Cooks, and 81 Privates. The number of privates may be varied in companies depending upon the armament to which it is assigned; this is particularly the case in companies of the mine defense.

Coast Artillery Fort.—The coast defenses at any military post and the garrison assigned thereto. Its command devolves upon the senior regular coast artillery officer present.

Coast Artillery Garrison.—The personnel, to include regular coast artillery, coast artillery reserves, and coast artillery supports, assigned to a coast artillery fort.

Coast Artillery Material.—Coast artillery material is classified as armament, range equipment, power and light equipment, and submarine defense equipment.

Coast Artillery Reserves.—Militia troops organized as coast artillery for the purpose of supplementing the regular coast artillery.

Coast Artillery Supports.—Infantry or other troops assigned to coast artillery forts to support the artillery in repelling land attacks in the immediate vicinity of the fortifications.

Coast Carriage.—See CARRIAGE or MOUNT.

Coast Defense.—The military and naval dispositions and operations necessary to resist a naval attack on any part of the coast line.

Coast Defense Officer.—A coast artillery officer assigned to duty on the staff of division or department commanders to act in an advisory capacity with respect to matters pertaining to the efficiency of coast artillery material and to the drill, instruction and employment of coast artillery in connection with coast defense generally.

Coast Defense Ships.—Ships of the monitor or gunboat type, supplementing the shore defenses at points where the latter do not give adequate protection, by reason of the width of the approaches or the nearness of the harbor, city, or anchorage, etc., to the sea.

Coast Guard.—Mobile troops placed at strategical points near fortified portions of the coast line.

Collar.—A device made of wood, placed upon the chase of a gun to make the diameter equal to that of the body of the piece, to enable it to be rolled with facility.

Colors.—The silken national, and district or regimental flags carried by regiments or battalions of engineers, troops comprising coast artillery districts, and regiments of infantry. The word is used in contradistinction to *standards*, which are smaller in dimension and are carried by regiments of cavalry, and regiments of field artillery. They are carried in battle, campaign, and on all occasions of ceremony at district or regimental headquarters where two or more companies of the district or regiment participate.

Each coast artillery post, where two or more companies of coast artillery are stationed, is furnished with a service color, which is the national color made of bunting or other suitable material, but in all other respects similar to the silken national color. Garrisons of coast artillery posts other than district headquarters may use them upon all occasions.

Colors of the Coast Artillery Corps.—The national color is of silk 5 feet 6 inches fly, 4 feet 4 inches on the pike, which is 9 feet long, including spear-

head and ferrule; the union is 2 feet 6 inches long, with stars embroidered in white silk on both sides of the union; the edges are trimmed with knotted fringe of yellow silk $2\frac{1}{2}$ inches wide; there are two cords 8 feet 6 inches long, having tassels, and composed of red, white, and blue silk strands. The official designation of the artillery district is engraved on a silver band placed on the pike.

The corps color, of the same dimensions as the national color, is of scarlet silk, having embroidered upon it in colors the official coat of arms of the United States, of suitable size. Below the coat of arms, in the middle, embroidered in yellow silk, are two cannon, crossed; also a scroll embroidered in yellow silk and bearing the inscription, "U. S. Coast Artillery Corps," embroidered in red silk; the edges are trimmed with knotted fringe of yellow silk $2\frac{1}{2}$ inches wide; cord and tassels same size as those of the national color, but of red and yellow silk strands. Both sides of the color are embroidered alike.

One set of national and corps colors is issued to the headquarters of each artillery district.

Colors on Projectiles.—See PAINTS ON PROJECTILES.

Combination Electric Friction Primer.—A primer combining the principles of friction and electric primers, the electric features being modified.

Combination Fuse.—A fuse inserted in the point of shrapnel which ignites the bursting charge either upon impact or at the completion of the set time interval; it contains both a time and percussion fuse, thus increasing the chance of bursting.

Commissary Sergeant.—See POST COMMISSARY SERGEANT.

Common Electric Primer.—A primer whose action depends upon the ignition of a small charge of fulminate fired by means of a platinum bridge heated to incandescency by an electric current.

Common Friction Primer.—A primer which operates solely by friction.

Communication Officer.—A coast artillery officer charged with the duty of receiving and transmitting communications during drill or action.

The communication officer of a battle command has entire charge of the system of communication, inspects the equipment of the station, excepting the equipment pertaining to the searchlight system, verifies the adjustment of the position-finding instruments, receives the report of details and reports to the battle commander when the station is in order, or reports any defects that he cannot immediately correct. He receives all orders from and transmits all communications to the district commander, and all orders to and communications from the fire and mine commanders. He sees that an accurate record is kept of all orders of the battle commander and all communications of whatever character received at the station.

The communication officer of a fire command is in charge of the station under the fire commander. He inspects the equipment of the station, verifies the adjustment of the position-finding instrument, plotting board, etc. Receives the reports of the battery commanders and transmits them to the fire commander. He transmits the orders of the fire commander to range officers, or through the latter to the battery commanders; receives all orders from the battle commander, and immediately transmits same to the fire commander. He sees that an accurate record is kept of all orders and communications to and from the station.

Communications.—Means of transmitting orders or messages through the tactical chain of artillery command. In the case of mobile troops it includes all routes, such as roads, railroads, etc., by which an army communicates with its base, or by which several parts of an army communicate with each other.

Composite Artillery Type Telephone.—A special type of telephone provided for permanent artillery communications.

Computer.—A member of the fire-control section who operates a range or deflection board.

Concentric.—That which has a common center with something else. A stone thrown in a motionless pool of water would cause concentric circles to form on its surface.

Cone of Dispersion.—See CONE OF SPREAD.

Cone of Spread.—The imaginary cone containing the diverging bullets or fragments upon the explosion of a shrapnel shell. This cone is very long.

Conical.—Round and tapering to a point.

Console.—A bracket whose projection is not more than half its height; any small bracket.

Contact Firing.—The electrical firing of a submarine mine when it is struck by an enemy's ship.

Converted Gun.—A smooth-bore gun in which a tube containing rifling has been inserted.

Cordage.—Ropes and cord collectively. See chapter on CORDAGE.

Cored Shot.—A projectile the center of which is partly hollowed. It can be filled with a bursting charge and used the same as a shell.

Corrected Range.—The fictitious range which determines the elevation to be given the gun, in order to hit the target.

Corridor or Truck Corridor.—The elevated passageway in rear of the traverse connecting adjacent gun emplacements at the loading platform level.

Corridor Wall.—The traverse wall along the corridor.

Counter Attack.—A counter attack, during an engagement of mobile troops, is directed against the enemy's attack, i.e., it meets him before, or at the moment of, arrival at the defended position. The term also applies to an attack made after a prior defensive attitude and directed against troops not previously engaged, for example, in turning the flank of an attacking force. This is called the decisive counter attack, although, properly speaking, it is the assumption of the offensive.

Countermining.—The operation of clearing a channel of mines, by exploding large charges sufficiently near the mines to cause their destruction. The usual method consists of dropping in succession two or more parallel straight lines of countermines at such distance from each other that their simultaneous explosion will destroy all mines within their destructive radius.

Note.—The success of this is very doubtful, however, under the present mine system.

Counter Recoil.—The return of the gun in battery, immediately after recoil.

Counterscarp.—See SCARP.

Counterweight.—The weight used on disappearing carriages to take up part of the force of recoil, and to carry the gun to the firing position. The term is also applied to the weight on masking parapet mounts.

Counterweight Well.—The pit in the front end of a gun platform for the reception of the counterweight of a disappearing carriage.

Cover Post.—Positions for the members of a mortar detachment at the command "*Take Cover.*"

Cradle.—A device employed for transporting heavy guns a short distance.

Crane.—A mechanical device for raising ammunition by means of differential or other blocks.

Critical Dimension.—A term used in connection with powder grains. It is the dimension or thickness of the web between the perforations in a multi-perforated grain. Also called *least dimension*. See chapter on BALISTICS.

Cross Fire.—Cross fire is where the projectiles from guns in different positions cross one another at a particular point.

Crow's Nest.—The name commonly applied to the observing station located in the parapet or traverse.

Cruiser.—A war vessel of graceful and regular outline. *Armored Cruisers* have a narrow beam as compared with length, a high freeboard, armor-plated turrets and belt. Average length about 400 feet, beam 60 to 70 feet, draft 22 to 24 feet, speed 22 to 24 knots, displacement 13,000 to 15,000 tons, armor 3 to 6 inches in thickness, armament 10-inch, 8-inch, 6-inch, and smaller rapid-fire guns, and torpedo tubes.

Protected Cruisers differ from armored cruisers in having only protected deck at water line. Average length 300 to 430 feet, beam 40 to 50 feet, draft 17 to 27 feet, speed 19 to 23 knots, displacement 3,000 to 9,000 tons, armor of deck 1½ to 4 inches, armament 8-inch, 6-inch, 5-inch, 4-inch, and smaller rapid-fire guns, and torpedo tubes.

Scout Cruisers differ from other types in having no armor protection. Average speed 22 to 26 knots, armament small rapid-fire guns.

Cruiser Battleship.—A war vessel the armament of which is equal in power, or nearly so, to a battleship, but which cannot fight in a naval "battle line" owing to the lightness of its armor protection. This type of war vessel carries, as its capital caliber, eight 12-inch guns; its armor, however, is only about one-half the thickness of that of battleships. This saving in weight being given to motive power, their speed being about 26 knots. Their functions are to drive in or destroy the enemy's armored cruisers and discover the strength of his battle front. They may also be used to harass the enemy's battleships either before or during an action.

Crusher Gauge.—A device inserted in the mushroom head of the breech-block, or in the bottom of the bore, to determine the maximum pressure of the bore. Commonly called *pressure gauge*.

Curvature of the Earth.—A term applied in gunnery to define the amount of bending of the water surface of the earth from the normal due to the earth's shape. This bending of the water surface causes the target to be on a lower level than that of the gun, i.e., the apparent difference of level between the axis of the gun and mean low water as the position of the target is increased in proportion to the range.

Curve or Curved Line.—A line that changes direction at every point.

Curved Fire.—See FIRE.

Cut-off Jack Set.—A form of telephone bridged on lines to primary sta-

tions and booths to enable communication officers to talk direct to any primary station in the fire command.

Cylindrical.—Having the form of a cylinder; uniformly circular.

Cylindro-Conical.—Having the form of a cylinder (the forward portion of which is conical).

“D” Row.—See HOOPS.

Danger Range.—See DANGER SPACE.

Danger Space.—The horizontal distance within which a target of given height would be hit by a projectile. It is usually computed for the standard-size target. The danger space varies with the range, the flatness of the trajectory, the height of the target, and the height of the gun above the target.

Data Line.—See INTELLIGENCE LINE.

Datum Point.—A fixed point in the field of fire the true azimuth and range of which has been determined by the Engineer Corps. Such point or points are used in proving the accuracy of range and position finding instruments.

Deflection.—The horizontal angle between the plane of sight and plane of departure; it is expressed as a *reference number* and is set off on the sight deflection scale.

Deflection Board.—A device for determining the algebraic sum of the deflection corrections for wind, drift and travel of target during the time of flight and the predicted interval. It is used to determine the reference numbers for the deflection scale of the sight in Cases I and II, and the azimuth correction reference number in Case III; and, for mortars, the corrected azimuth.

Deflection Scale.—A scale provided on sights, graduated in degrees and hundredths for the purpose of obtaining and applying corrections for deviation.

Delayed Automatic Firing.—A term applied to one of the three methods of exploding submarine mines, i.e., where the apparatus is so arranged that the mine is exploded when a signal is given which indicates that it has been struck.

Delivery Table.—The table from which ammunition is delivered to the truck.

Density of Loading.—The mean density of the whole contents of the powder chamber. It is the ratio of the weight of the powder charge to the weight of a volume of distilled water at a temperature of 39.2 degrees F., which would completely fill the powder chamber. The formula for computing it is Δ (density of loading) = $(27.7W)/V$, in which W is equal to the weight of the powder in pounds and V the volume of the chamber in cubic inches.

Department Artillery Officer.—See COAST DEFENSE OFFICER.

Department Commander.—A general officer assigned by order of the President to command all the military forces of the government within the limits of territorial divisions and departments which are not excepted from his control by the War Department.

Department Commander's Flag.—See FLAG OF DEPARTMENT COMMANDER.

Depression Position-Finder.—A telescopic instrument used in the primary and secondary stations of a fire-control base line, to read either vertical or horizontal angles. When used in the first instance it is a depression-position finder, while in the second it is used the same as an ordinary azimuth instrument. Objects when viewed from an elevation appear under different angles of depression according to their distance from the point or points of observation; this fact is taken advantage of in the vertical base system and is the

principle upon which depression-position range finders are constructed. The depression-position range finder solves, mechanically, the problem of determining one side of a vertical right triangle, having given a side and two adjacent angles. The given, or base side, is the distance above sea level of the axis about which the telescope is elevated or depressed. The lower angle is constant and equal to 90 degrees. The depression angle varies with the distance of the observed target.

Detonation.—The practically instantaneous combustion or decomposition of a disruptive explosive of high order.

Deviation.—Distances measured either in the horizontal plane at the level of the target or in a vertical plane through the center of the target at right angles to the plane of direction. If from the point of impact of a shot a perpendicular be drawn to the plane of direction, the length of this perpendicular is the lateral deviation, and it is plus or minus according as the point of impact is to the right or left of the line of direction looking from the gun. The distance from the foot of this perpendicular to the center of the target is the longitudinal deviation. It is plus when the point of impact is beyond the target and minus when it is short.

Deviation at the Target.—If from the target a line be drawn perpendicular to the plane of direction intersecting the plane containing the line of shot, the length of this perpendicular is the "deviation at the target."

Deviation, Absolute.—See ABSOLUTE DEVIATION.

Deviation, Mean Lateral.—See MEAN LATERAL DEVIATION.

Deviation, Mean Longitudinal.—See MEAN LONGITUDINAL DEVIATION.

Deviation, Range.—See RANGE DEVIATION.

Diameter.—A line passing through the center and terminating at both ends in the circumference of a circle.

Difference Chart.—A graphic device constructed upon geometric principles by which information as to range and azimuth of a target from one point—the primary station—is converted mechanically into similar information with respect to any other point, as the directing gun or point of a battery.

Direct Fire.—See FIRE.

Directing Gun.—See DIRECTING POINT.

Directing Point.—A point at or near the battery for which relocation is made at the plotting room. It is the point over which the gun center of the plotting board is adjusted. When the pintle center of a gun of a battery is taken as the directing point, such gun is called the *directing gun*.

Disappearing Carriage.—A gun carriage so constructed that it will carry its gun to a firing position above the parapet and upon discharge carry it back to the original loading position behind the parapet.

Displacement.—The horizontal distance from the vertical axis of the position finder of the battery primary station to the pintle center of the directing gun, or some other directing point.

In a marine sense the word implies the quantity of water displaced by the hull of a ship, the weight of the displaced liquid being equal to that of the displacing body.

Displacement of any Point.—The horizontal distance in yards of that point from the directing point.

Distribution Box.—A cast-iron case through which the cables of a group

of submarine mines are distributed from the multiple-core cable which runs to the mining casemate.

District Artillery Engineer.—A coast artillery officer charged with the requisition, supervision, maintenance, inspection and accountability of the signal, submarine mine and engineer installations, property and stores of an artillery district. He inspects all such installations, property and stores at each post in his district at least once a month. His tactical functions are those of a searchlight officer of a battle command, unless otherwise assigned by the district commander.

District Commander.—See ARTILLERY DISTRICT COMMANDER.

District Drill.—A drill conducted by the district commander in which all the artillery elements of defense of the district take part.

Ditch.—In field fortification, the trench in front of the parapet, designed as an obstacle to the assailant. It was formerly called also a *moot* or a *fosse*.

Double Primary Station.—A building so constructed as to contain under one roof two primary stations with their plotting rooms.

Double Secondary Station.—A building so constructed as to contain under one roof two secondary stations.

Drift.—The divergence of the projectile from the plane of departure due to its rotation, its ballistic character and the resistance of the air. It is generally in the direction of rotation, except for extreme elevations of high-angle fire, in which case it *may* be opposite to the original direction of rotation. For the United States service rifled guns it is to the right. It may be expressed either in yards or angular measure.

Driggs-Schroeder Rapid-Fire Gun.—A rapid-fire gun of 2.24-inch caliber, commonly called 6-pounder. They are distinguished by two models of breech mechanism, namely, screw-block and drop-block.

Driggs-Seabury Rapid-Fire Gun.—A rapid-fire gun of 2.24 and 3-inch caliber, commonly called 6 and 15-pounders respectively.

Drill Primer.—A primer provided for reloading, used for drill purposes.

Dunnite.—See EXPLOSIVE "D."

Dynamite.—A detonating and disruptive explosive of high order used for filling submarine mines and demolitions of all kinds.

Earthworks.—In fortification, a general term for all military constructions, whether for attack or defense, in which the material employed is chiefly earth.

Ecrasite.—A high explosive compound of foreign manufacture.

Eight-inch Gun.—A seacoast cannon usually 40 calibers long and of 8-inch caliber.

Elasticity.—That property by which bodies recover their former shape and volume after having yielded to some force. Elasticity of steel permits its extension to a certain limit, beyond which a permanent set would take place. This limit is known as the limit of elasticity.

Electric Ballistic Machine.—See CHRONOGRAPH.

Electric Firer.—See EXPLODER.

Electric Mines.—Submarine mines fired by electric current; they are of two classes, controllable and non-controllable.

Electric Primer.—See COMMON ELECTRIC PRIMER.

Electrician Detachment.—A detachment consisting of the electrician ser-

geants and necessary assistants detailed from the enlisted personnel, charged with the care and preservation of the electrical installations, etc., of a fort.

Electrician Sergeant.—A non-commissioned staff officer. Electrician sergeants are of two classes. The first class are charged with the immediate supervision, care, and operation of a division of the electrical installations, including searchlights and power plants when necessary, in addition to the duties prescribed for electrician sergeants, second class. Any duty in connection with the electrical installations, including the mechanical work of repairing electrical apparatus and the care and operation of searchlights. The second class are charged specifically with the care, repair and maintenance of the electrical installations, including lines and means of communication, as well as any duty in connection with the electrical installations, including mechanical work necessary in repairing the electrical apparatus, and the care and operations of searchlights and small power plants. Insignia: *First Class.* Gold wreath with a white forked lightning within and a small red bar about three-quarters of an inch long between the lightning and the wreath, all below a sergeant's chevrons. The lightning, bar, and wreath to be of silk embroidery thread. *Second Class.* Same as first class, omitting the small bar.

Elevation.—A general term used to denote the inclination in a vertical plane given to the axis of the gun in pointing. See SIGHT ELEVATION, QUADRANT ELEVATION.

Elevation Setter.—The member of a mortar detachment who lays the mortar in elevation.

Elliptical.—Oblong with rounded ends.

Elongated Projectiles.—The modern type of coast artillery projectiles.

Emergency Position Finder.—A self-contained horizontal position finder, or a depression position finder constructed for use on low sights and sufficiently accurate for emergency purposes. It is operated from the observing station (crow's nest) at a battery in case the regular instrument or station is destroyed.

Emergency Station.—A range-finding station provided for use in case a regular station of a permanent base line has been destroyed. These stations are so located that they can be used to replace the primary or secondary station of one or more base lines. The term is also applied to the observing station at the battery, where an emergency depression position-finder is mounted.

Emergency System.—A system of position-finding, used in an emergency. It employs a self-contained position-finder located at the battery, with or without a plotting board.

Emplacement.—That part of a battery pertaining to the position, protection and service of one gun or mortar, or a group of mortars.

Emplacement Book.—See BATTERY EMBLEMMENT BOOK.

Emplacement Officer.—A coast artillery officer in immediate charge of the emplacements of a gun battery or one pit of a mortar battery. He is the battery commander's assistant at the guns to which he is assigned. He is responsible to the battery commander for the condition of the emplacement and material, as well as for the efficiency of its service. Upon arrival at the emplacement before a drill, practice or action, he makes a careful inspection of all parts of the guns and carriages, the equipment and implements to be used, giving special attention to the elevating and traversing devices as well as those

for running the piece in and from battery; recoil cylinders—to see that they are properly filled with the right amount and kind of oil, and that the plugs are properly inserted; obturators—to see that they are properly adjusted; pads—in serviceable condition. In case of firing—to see that the throttling and buffer valves are properly set and locked; to see that the motor generator, motors and controllers, firing attachments, firing batteries and circuits are in order; that the sights, subscales of azimuth circles are in adjustment; that sponges and rammers are of proper kind and gauge and in serviceable condition; that suitable vessels are provided for the water necessary for sponging out the bore; that all necessary charts are on hand; and that ammunition hoists are in working order.

As the efficiency of a battery depends primarily on the correctness of adjustment of each of the devices mentioned above, the necessity of a thorough inspection can not be too strongly recommended.

Emplacement officers of mortar batteries are charged with the corresponding duties in so far as they pertain to a mortar battery.

Endurance of Cannon.—The life of a cannon or the number of times a piece is capable of being fired before relining is necessary. In the case of heavy guns their life is assumed to be approximately 250 service shots.

Energy of the Projectile.—The energy stored up in the projectile by the force of expanding powder gases generated by the explosion of the charge. It is expressed usually in foot-tons. When a projectile is in motion it is said to have energy, i. e., it is capable of doing work and overcoming resistance. The formula for computing it is: $E = Wv^2 / (4480g)$, in which W is the weight of the projectile in pounds, v is velocity in feet per second, and g the acceleration due to gravity (mean value 32.16).

Energy of Recoil.—An expression denoting the work done in recoil of a gun when fired. The recoil may be reduced by decreasing the weight of the projectile, decreasing the muzzle velocity, or by increasing the weight of the gun.

Enfilade Fire.—Fire which rakes a fighting line, the gun being on the prolongation of the line. In naval or fortress engagements fire delivered on the stern or bow of a ship so that the projectiles rake the whole length of the deck.

Engineer.—A non-commissioned staff officer whose duty it is to supervise, care for, and operate the power plants, machine and repair shops, and such mechanical and electrical apparatus used for power purposes as may be placed under his charge. He may be required to perform such other technical duties as may be necessary in the district or at the post to which assigned. Insignia: Gold wreath with a red governor within and a small white star about one-half of an inch above the governor, all to be of embroidery thread.

Equalizing Pipe.—A pipe connecting corresponding ends of two recoil cylinders for the purpose of equalizing the pressure therein.

Erosion of the Bore.—The wearing away of the rifling of the bore.

Estuary.—A passage, as at the mouth of a river or lake where the tide meets the current; an arm of the sea.

Exploder.—An electrical machine operated by hand, used to fire electric fuses and primers.

Explosive.—A substance or a mixture of substances which, when heated,

struck, or subjected to the shock of another explosive results in the rapid formation of a great volume of highly heated gas.

Explosive Compound.—An explosive whose ingredients are united chemically. Nitro-glycerine and guncotton are explosive compounds.

Explosive "D," or Dunnite.—A shell filler the exact ingredients of which are secret. It is a high explosive compound. It is not fusible and shells are filled by compression. It is the least sensitive to shock of all the explosives used in the service.

Explosive House.—A structure in which high explosives are stored on a military post; frequently referred to as a magazine. Authorities do not agree as to the most suitable type. Some advocate light wooden structures, the debris of which in case of explosion would be thrown a comparatively short distance; others recommend a building of corrugated iron with asphaltum floors, making the house fireproof. Structures of this character are usually protected by earthworks.

Explosive Mixture.—An explosive whose ingredients are mixed mechanically. Gunpowder is an explosive mixture.

Exterior Crest.—The line of intersection of the superior and exterior slopes.

Exterior Slope.—The outer slope of the parapet of a battery.

Extreme Range.—The greatest accurate range obtained by a projectile in its flight. For example, the extreme range of the 16-inch breech-loading rifle, model 1895, is approximately 21 miles. The extreme range against armor for the 12-inch breech-loading rifle, model 1900, is approximately 13,000 yards, or $7\frac{1}{2}$ miles.

Face of the Breech.—The rear terminal plane of the gun perpendicular to the axis of the bore.

Face of the Muzzle.—The front terminal plane of the gun perpendicular to the axis of the bore.

Faces of the Rimbases.—The end planes of the rimbases perpendicular to the axis of the trunnions.

Faces of the Trunnions.—The end planes of the trunnions perpendicular to their axis.

Field of Fire.—The designation of the area covered by certain armament, for example, that of a battery.

Fifteen-Pounder.—Term applied to a 3-inch rapid-fire gun. It denotes the proper weight of projectile for the piece.

Fillet.—That portion of metal, filling the re-entrant angle formed by two surfaces not tangent, thus avoiding a sharp corner. The term is also applied to the metal cut away in removing the sharp edge formed by the intersection of two surfaces.

Final Velocity.—See REMAINING VELOCITY.

Fire.—The discharge of firearms and the destruction caused by their projectiles. Artillery fire is classified as *direct*, *curved* and *high-angle* fire. Direct fire is fire with high velocities and angles of elevation not exceeding fifteen degrees. Curved fire is fire with low velocities and angles of elevation not less than fifteen degrees. High angle fire is fire with low velocities and angles of elevation not less than forty-five degrees. See ORDERS OF FIRE; ENFILADE FIRE; FLANKING FIRE; FRONTAL FIRE; OBLIQUE FIRE; REVERSE FIRE.

Fire Area.—The area covered by the armament of a fire command.

Fire Command.—A fire command consists normally of four batteries of two guns each, or in the case of a mortar fire command, of two mortar batteries consisting of two pits each. The batteries of a fire command should be so located that their fire covers the same or adjoining water areas, and so located that the artillery fire therein will not interfere with that of any other fire command.

The armament of an artillery fort or post may be divided into two or more fire commands.

Fire Commander.—A coast artillery officer assigned in orders from district headquarters to command a fire command.

A fire commander is responsible to the battle commander for the tactical efficiency of his command. He is in direct communication with his battle commander and each battery commander in his command.

He is both an administrative and tactical commander; his administrative duties, however, are confined to those affecting the tactical efficiency of the fire command. In general he exercises his administrative duties verbally or informally. Generally orders to his fire command are issued from post headquarters. All communications to and from post headquarters affecting his fire command are referred to him for his information and remark. His office is not one of record; he consults the records at post headquarters for any needed information.

On battery drill days he visits the batteries of his command during drill, and on days of indoor instruction visits the companies during instruction hours. He supervises battery target practice.

He requires a thorough knowledge of the installation, equipment and system of fire control and drill on the part of the officers of his command, and encourages and recommends improvements in drill or material.

He should keep himself constantly informed as to the condition of the material of each battery in his command as well as to the efficiency of all supplies.

In battle command drill or in action, he takes up promptly the attack of the targets assigned or indicated by the command of the battle commander. When ordered to assume the exercise of independent fire action, he fights his batteries in accordance with his own judgment. He is authorized by regulations to order independent battery action whenever, in his opinion, the condition of the naval attack renders such action advisable, provided independent fire command action has been ordered, or urgency renders it necessary. He uses his own judgment as to orders of fire and rate of fire, unless these have previously been prescribed by the battle commander.

At night the illuminating light assigned to his fire area is under his immediate control.

Fire Commander's Station.—A station overlooking a fire area occupied by the fire commander and necessary assistants during drill or action.

Fire Control.—The exercise of those tactical functions which determine: (a) The objective of fire. (b) The volume and concentration of fire. (c) The accuracy of fire.

The term *fire-control system* includes the means employed in fire-control, the scheme of its installation and method of its use. The material as installed, which is employed in the fire-control of a battery or district, is called the *fire-*

control installation for that battery or district. Installations are either standard or provisional.

Fire-control material may be classified under the following heads:

a. Instruments for the observation and location of targets.

b. Instruments for the determination of firing data.

The personnel employed in fire control is called the *fire-control personnel*.

Fire-Control Installation.—See FIRE CONTROL.

Fire-Control System.—See FIRE CONTROL.

Fire Left.—When marked on the deflection scales of telescopic sights indicates minus deflection (muzzle pointed left).

Fire Right.—When marked on the deflection scales of telescopic sights indicates plus correction (muzzle pointed right).

Fired Standard Primer.—See DRILL PRIMER.

Fireman.—A non-commissioned staff officer charged with such duties as pertain to the care and operation of boilers and accessories, including the police of the boiler and engine room. He may be required to assist the engineer in his work. Insignia: A bar and an arc of one bar of red cloth inclosing a red governor made of yellow cloth.

Firing Interval.—The interval of time between consecutive shots of the same gun or mortar in continuous firing.

Firing Machine or Electric Firer.—See EXPLODER.

Five-Inch Gun.—A rapid-fire gun usually 45 to 50 calibers long and of 5-inch caliber. Made by the Ordnance Department.

Fixed Ammunition.—When the cartridge case is attached to the projectile, the two together are called fixed ammunition. It is not used in large calibered guns on account of the disadvantage of handling and the difficulty of arranging and preserving.

Fixed Armament.—Guns and mortars of various sizes and powers, mounted on stationary carriages.

Fixed Defenses.—Defensive works ashore within the line of defense.

Fixed Mount.—A mount or carriage provided for guns and mortars in permanent works and not designed to be moved from place to place.

Fixed Light.—A searchlight intended to demarcate the outer limit of a battle area and illuminate any vessel entering it.

Flag of Admiral of the Navy.—A flag consisting of four white stars, on a blue field of bunting, placed at the corners of an imaginary square, whose diagonals are horizontal and vertical.

Flag of Artillery District Commander.—A flag of scarlet bunting, rectangular in shape, 1-foot 6-inch hoist and 2-foot fly for small boats and launches, and 2-foot 3-inch hoist and 3-foot fly for large boats. In the center of both sides, crossed cannon in yellow, with a medallion at their intersection, in scarlet, having an oblong projectile in yellow. The truck of the staff to be a gilt ball.

Flag of Assistant Secretary of the Navy.—The same as that for Secretary of the Navy, except the anchor and stars are blue on a white field of bunting.

Flag of Assistant Secretary of War.—The same as that for Secretary of War, except the stars are scarlet on a white field of bunting.

Flag of Chief of Coast Artillery.—A flag of scarlet bunting, rectangular in shape, 3-foot hoist and 4-foot 9-inch fly. The rank to be indicated by a white star (or stars of appropriate number if above the rank of brigadier general)

of suitable size placed in the center line of the length of the flag. The truck of the staff to be a gilt ball.

Flag of Department Commander.—Same as that of Chief of Coast Artillery, with rank indicated by appropriate number of stars.

Flag of Post Commander (Coast Artillery).—A pennant of bunting, triangular in shape, 1-foot hoist and 3-foot fly; the third nearest the staff to be a blue field bearing thirteen stars and the remaining two-thirds to be scarlet. The truck of the staff to be a gilt ball for post commanders above the rank of captain, and for post commanders of a lower grade to be flat.

Flag of President of the United States.—A flag consisting of the official coat of arms of the United States, of suitable size, in the center of a blue field of bunting.

Flag of Rear Admiral of the Navy.—A flag consisting of two stars, on a blue field of bunting, symmetrically placed on a vertical line in the center of the flag.

Flag of the Secretary of the Navy.—A flag consisting of four white stars, on a blue field of bunting, symmetrically placed in the four corners, surrounding a vertical white anchor.

Flag of the Secretary of War.—A flag consisting of four white stars, on a scarlet field of bunting, surrounding the official coat of arms of the United States.

Flag of the United States.—A flag with thirteen horizontal stripes, seven red and six white, the red and white stripes alternating; the union of the flag consists of white stars in a blue field placed in the upper quarter next the staff, and extending to the lower edge of the fourth red stripe from the top, the length of the union being $13/32$ of the full length of the flag; the number of stars is the same as the number of States in the Union.

Flag of Vice Admiral of the Navy.—A flag consisting of three stars, on a blue field of bunting, placed at the vertices of an imaginary isosceles triangle, whose base is horizontal.

Flags.—See BATTLE FLAG, COLORS, COLORS OF COAST ARTILLERY CORPS, GARRISON FLAG, POST FLAG, STORM FLAG, SUBMARINE BOAT SIGNAL FLAG.

Flagship.—The vessel which carries the commanding officer of a fleet or squadron. It is distinguished by the flag of the officer in command, flying at the main mast.

Flanking Fire.—Fire directed along the front of or nearly parallel to the enemy's line.

Floating Defenses.—Vessels used for defensive purposes, including monitors, gunboats, scout ships, torpedo boats, submarine boats, patrol and picket boats.

Foot-Ton.—The energy expended or necessary to raise a weight equal to a long ton, or 2,240 pounds, one foot.

Forcing.—As applied to a projectile, forcing is the operation by which a projectile is made to take hold of the grooves of the bore.

Forcing Cone.—The part of the bore of a gun immediately in front of the centering slope. It is formed by cutting away the lands so as to decrease their height uniformly from front to rear.

Fort Commander.—See COAST ARTILLERY FORT.

Fort Record Book.—A permanent confidential record book containing the history of the works, their object, armament, scheme of defense, and all infor-

mation of value regarding the equipment and installation. It is supplemented by the Fort Record Book Files, in which copies of all confidential papers and maps are kept.

Fortified Point.—A general term indicating a city, harbor, anchorage, estuary, or any limited portion of the coast line that is defended by fixed defenses.

Fosse.—See DITCH.

Four-Inch Rapid-Fire Gun.—A seacoast cannon, usually 40 calibers long and of 4-inch caliber.

Friction.—A force acting between two bodies at their surface of contact, so as to resist their sliding on each other. Friction is of three kinds; sliding and rolling friction, which act with solids; and fluid friction, which acts with liquids and gases.

Friction Primer.—See COMMON FRICTION PRIMER.

From Battery.—The position of a gun when withdrawn from its firing position.

Front Pintle.—A term applied to a coast carriage where its axis of rotation is at or near its front end, i.e., where it traverses about a point in front of its center.

Frontal Fire.—Fire which is directed perpendicularly, or nearly so, to the objects fired at.

Frustum.—That part of a solid next to a base formed by cutting off the top.

Fulcrum.—A means of support for a lever about which it turns in lifting or moving a body.

Fulminate.—A very sensitive explosive compound used in fuses, primers and caps.

Fuse.—A mechanical firing device used for exploding a bursting charge. See chapter on FUSES AND PRIMERS.

Gabion.—A wicker cylinder of strong basket-work open at both ends. Its usual dimensions are 2 feet in diameter and 2½ feet in height. They are filled with earth and used for defensive purposes in field fortification.

Gallery.—Any passage covered over head and at the sides.

Galvanometer.—An instrument used for detecting the existence, and determining the strength and direction of an electric current.

Garrison Flag.—The national flag, 36 feet fly and 20 feet hoist. Hoisted only on holidays, important occasions and during engagements. In the latter case it is called the battle flag.

Garrison Gin.—A lifting tackle used in mechanical maneuvers of coast artillery armament.

Gas Check.—The essential mechanical feature of an obturator which enables it to prevent the escape of gas.

Gas Check Pad.—A pad made of asbestos and tallow enclosed in a canvas cover and compressed under heavy pressure. Under the weight of firing the plastic nature of the pad causes it to press outward against the gas check seat and inward against the spindle, forcing the split rings firmly in their seats and completely stopping the passage to the escape of gas.

Gear Wheel (or Cog Wheel).—A wheel with teeth on the circumference to mesh with a rack, worm ring, or another gear wheel.

General Defense Plan.—The scheme of defense formulated prior to an at-

tack. A variety of these plans, based on the character of attack to be expected, should be prepared and issued to the command.

Glacis.—In field fortification a mound of earth which inclines from the front of the ditch toward the foreground, thus forcing the assailant to full exposure to the fire from the parapet before reaching the ditch.

Gravimetric Density.—A term which refers to the ratio of the weight of a unit volume of a standard powder to the weight of the same volume of any other powder, i. e., the gravimetric density of a powder is the weight in pounds of a volume of 27.68 cubic inches of the powder not pressed together by its own weight. (27.68 is the number of cubic inches occupied by one pound of water).

Gravity.—That force which tends to draw all bodies toward the earth with uniformly increasing velocity. Its mean value equals 32.16 foot-seconds. An example of gravity may be demonstrated as follows: A projectile thrown from a mortar at, say, an angle of 90 degrees, would travel upward until the propelling force under or behind it ceased to exist, it would then take a downward course—drawn by gravity—and strike the surface at a velocity equal to the original initial velocity which it had on leaving the muzzle.

Graze.—The point at which a projectile strikes a surface and rebounds onward.

Grooves.—In ordnance, the spiral hollow cuts made in the surface of the bore.

Guard Room.—A room in the battery, or guard house, set aside for the use of the guard.

Gun.—A term applied in its most general application to any weapon which throws or propels a missile to a distance; any firearm or instrument for throwing projectiles by the expanding force of powder gas, consisting of a tube or barrel closed at one end. In a restricted sense, the term is applied to that class of cannon in which the length of bore is great in comparison with the caliber.

Gunboat.—Any boat of light draft carrying one or more guns. They usually resemble cruisers, but are much smaller. Speed less than 14 knots, displacement 2,000 tons or less. Armament, 6-inch, 5-inch, 4-inch and smaller rapid-fire guns.

Gun Carriage.—See CARRIAGE or MOUNT.

Gun Commander.—A specially qualified non-commissioned officer in direct charge of a gun section. When assigned in command of mortar pits they are called *pit commanders*; to ammunition sections, *chiefs of ammunition service*.

Gun Commander's Range Scale.—See RANGE SCALE.

Gun Company.—A company assigned to the service of direct-fire guns only.

Gun Cotton.—A detonating and disruptive explosive of high order made of unspun cotton waste, used in shells, torpedoes and for demolitions of all kinds.

Gun Differences.—Differences in range and azimuth to the target from the gun and from the directing point, due to gun displacement.

Gun Displacement.—The horizontal distance in yards from the vertical axis of the directing gun to the pintle center of any other gun of the battery, or from the directing point to the pintle center of any gun of the battery.

Gun Lift.—See CARRIAGE or MOUNT.

Gun Platform.—That part of a battery upon which the gun carriage rests.

Gun Pointer.—A specially qualified member of a gun section charged with

the proper aiming or laying of a gun, or the chief of a mortar detachment who supervises the loading and laying of a mortar. *Insignia*: Red crossed cannon within a yellow circle, all to be of cloth.

Gun Section.—A detail of the enlisted personnel, consisting of a gun commander, a gun detachment, ammunition detachment and reserve. There is one gun section for each piece assigned to a battery of the primary armament for service or drill; for batteries of the secondary armament, the detachment for all of the pieces constitutes one gun section under a single gun commander.

Gunner.—A specially qualified enlisted man who has passed the examination in elementary gunnery. They are classified as first- and second-class gunners. *Insignia*: *First Class*. In gun or mortar company; red projectile, with red bar below. In mine company; red mine case, with red bar below. *Second Class*. Same as first class, omitting the bar. All to be of cloth.

Gunner's Quadrant.—An instrument usually used in laying mortars to give quadrant elevation by either applying it at the breech or muzzle.

Gunnery.—That branch of military science which comprehends the theory of projectiles, and the manner of constructing and using ordinance. See BALLISTICS.

Gunnery Specialists.—Specially qualified enlisted men, such as Master Gunners, Master Electricians, Engineers and Electrician Sergeants who have successfully pursued the course of instruction at the Coast Artillery School.

Gunpowder.—A black or brown granular explosive mixture of low order, made of niter, charcoal and sulphur.

Hang Fire.—A delayed ignition of the powder charge caused either by defective primer or charge. See MISSFIRE.

Harbor Charts.—Charts covering the water area of each fortified harbor within the field of fire of the armament at that point. They are made on a scale of 500 yards to the inch and the area covered is marked off in one-inch squares which are numbered consecutively. The outlines of the harbor, depths of water, channels, locations of batteries and stations are accurately indicated. A chart mounted on a suitable board, with a range-scale arm pivoted at the point indicating the station to which it pertains is furnished each Battle, Fire, Mine and Battery Primary Observing Station.

High Angle Fire.—See FIRE.

Hoist.—See AMMUNITION HOIST.

Hoist Room.—The room in the battery containing the receiving table of the ammunition hoist.

Homogeneous.—Of the same kind or nature; consisting of similar parts or of elements of like nature.

Hoops.—In ordnance, hoops are cylindrical forgings concentric with the tube of built-up cannon, superimposed upon the tube, jacket, or other hoops.

The "*A*" Row are over the jacket, extending from the breech to the trunnions.

The "*B*" Row when used are on "*A*" Row.

The "*C*" Row are all those hoops in contact with the tube in front of the jacket.

The "*D*" Row are over the front end of the jacket and the "*C*" Row in front of the trunnions.

Horizontal.—On a plane parallel to the horizon.

Horizontal Angle.—An angle measured in the horizontal plane, or whose sides lie wholly in such plane.

Horizontal Base System.—The system of range-finding in which the position and range of the target are definitely located by the use of the primary and secondary arms of the plotting board, from azimuth readings taken simultaneously at the primary and secondary observing stations.

Horizontal Plane.—That plane which passes through or contains the line of the horizon. The horizontal plane referred to in the artillery position finding service is the horizontal plane containing the water level.

Horizontal Position Finder.—The Azimuth instrument.

Horizontal Range.—The longitudinal distance from the muzzle of the gun to the point of fall measured in the initial plane. It is the range given in all fundamental range tables.

Horizontal Velocity.—The component of the muzzle velocity parallel to the horizontal plane passing through the muzzle of the gun.

Howitzers.—Those cannon whose relative length and caliber range between the gun and mortar classes. They are used principally by the mobile army.

Hydraulic Jack.—A portable machine for exerting great pressure for lifting or moving a heavy body through a small distance by hydraulic power.

Hygrometer.—An instrument for measuring the degree of moisture in the atmosphere.

Hypothetical Targets.—Imaginary targets of assumed dimensions, for heavy guns. This target is outlined by two standard pyramidal targets towed 60 feet from center to center with a red streamer suspended from a wire or hemp cord midway between them, the hypothetical target represented being a vertical rectangle 30 by 60 feet. For mortars the hypothetical target is a circle 100 yards in diameter the center of which is indicated by a pyramidal target.

Identification of Target.—The act or process of recognizing a target which has been designated.

Igniter or Igniter Charge.—A small charge of rifle powder placed in contact with the propelling charge to insure the ignition of the latter. See PRIMER CHARGE.

Igniting Primer.—Primers used in cartridge cases for subcaliber tubes not provided with percussion firing mechanism. They require for ignition an auxiliary friction or electric primer which is inserted in the vent of the spindle in the same manner as for service firing.

In Battery.—The term used to indicate that a gun is in its proper position for firing.

In Commission.—The term used to indicate those batteries to which personnel is assigned.

In Service.—The term used to indicate those batteries to which personnel is assigned and at which daily drills are held.

Indication of a Target.—Any method employed to designate a target.

Inflammation.—The spread of flame over the surface and into the perforations of powder grains.

Illuminating Light.—A searchlight whose primary function is to follow a target that has been assigned to a fire command.

Initial Pressure.—The first or starting pressure. The term is frequently

applied in reference to initial tension, or the stress developed in the body of a built-up gun, by the method of fabrication. Initial tension is produced by shrinking over a tube or hoop a heated hoop that will have a slightly smaller diameter when cooled, each hoop compressing the one beneath it.

Initial Velocity.—The rate of travel at which a projectile leaves the muzzle of a cannon. Generally called muzzle velocity.

Initial Velocity of Rotation.—The rate of motion at which a projectile is traveling around its longer axis at the instant it leaves the muzzle of the gun.

Initial Velocity of Translation.—The rate of motion at which a projectile is traveling in the direction of its flight at the instant it leaves the muzzle of the gun. See MUZZLE VELOCITY.

Inside of a Beam.—A point is so called when it lies between the battle commander's station and a line passing through the axis of a searchlight beam.

Intelligence Line.—A telephone line connecting a primary and secondary station; used for the transmission of general information. The line over which data are sent from the reader at the secondary station to the secondary arm setter at the plotting board in the primary station plotting room is called the *data line*.

Interior Crest.—The line of intersection of the interior wall or slope with the superior slope.

Interior Slope or Wall.—The inner slope or wall of gun parapets or mortar pits.

Intermediate Armament.—The armament of a coast artillery fort used to attack lightly armored or unarmored vessels; it may be employed effectively to supplement the primary armament in the attack of armored vessels, or the secondary armament in the defense of the mine fields. It includes the 6-inch, 5-inch and 4.72-inch guns.

Jacket.—A cylindrical forging, concentric with and shrunk on the tube; it generally extends from the breech of the gun to a plane beyond the trunnions.

Judgment Firing.—See OBSERVATION FIRING.

Jump, Angle of.—The angle included between the line of departure and the axis of the bore when the piece is pointed. Experience has shown that the actual range for a given elevation does not correspond to the computed range. For convenience it is assumed that the entire discrepancy is due to an increase or decrease of the elevation of the gun at the instant the projectile leaves the muzzle, and this small difference in angle is called the jump. Therefore in determining the sight or quadrant elevation to be used to obtain a given range, a correction, which differs for different guns, carriages and ranges, must be applied to the angle of departure given in the range table. It may be determined by experiment. In practice it is included in the necessary range corrections as determined by trial shots.

Junction Box.—A device used in splicing cable, its object being to protect the joint and cause the strain to come upon the armor of the cable rather than on the joint itself.

The *Single junction box, small*, consists of two rectangular plates of cast iron $\frac{1}{2}$ -inch in thickness, 20 inches long and 6 inches wide, united by four $\frac{1}{2}$ -inch bolts at the corners (the bolts having square shanks and hexagonal nuts to facilitate clamping); the plates are hollowed in the middle to form a chamber which receives the turks' heads and joint. The ends of the plates are curved

to admit the cable ends, and the turks' heads are clamped to the lower plate by straps and screw bolts, the cavity of the upper plate covering them when bolted in position. This type of box is used in splicing single conductor cable.

The *Single junction box, large*, is similar in construction and is used in splicing multiple cables or cables of more than one core.

The *Grand junction box*, or junction box used as a distribution box when 7 conductor multiple cable is used, consists of two circular plates of cast iron, $\frac{3}{4}$ -inch in thickness and 21 inches in diameter, united by four 1-inch bolts at the corners. The joints and 7 conductors and multiple cable are clamped in the box in a similar manner to that described for the single junction boxes.

Kentledge.—Old cast iron articles which have become unserviceable, such as condemned guns, shot and shell, etc.

Lafin & Rand Firing Machine, or Electric Firer.—See EXPLODER.

Land Front.—Those portions of the defenses which are provided to repel an attack from the land area in rear of or on the flank of permanent seacoast works.

Lands.—In ordnance, the surfaces or ribs of the bore between two adjacent grooves of the rifling.

Lanyard.—A strong cord to one end of which a brass hook is attached. Used for exploding the friction primer when the piece is to be fired. See SAFETY LANYARD.

Large Caliber Guns.—The class of guns included in the primary armament.

Lateral.—Of or pertaining to the sides.

Latrine.—A closet for soldiers in camps or barracks.

Laying.—The operation of giving a gun the direction and elevation necessary to hit the target without the use of a sight.

Least Dimension.—A term used in connection with powder grains. The least dimension of a grain of powder is the dimension measured between the perforations of a multi-perforated grain over or through which the fire spreads in order to consume the entire grain. See CRITICAL DIMENSION.

Le Boulenge Chronograph.—See CHRONOGRAPH.

Length of the Bore.—The distance from the front face of the breechblock when seated, to the face of the muzzle.

Limited Fire.—Fire delivered through a restricted circumference of an azimuth circle.

Limits of Fire.—The terminating azimuths of the field of fire of a battery.

Line.—A line is that which has length, but not breadth nor thickness. A curve or curved line is a line having no finite portion of a straight line.

Line of Collimation.—The line in which the optical axis of the telescope should be when properly adjusted. The line of collimation and the line representing the axis of the telescope, when in proper adjustment, coincide.

Line of Defense.—In coast artillery, the coast line; it consists of fortified and unfortified portions. The fortified portions are those which include important harbors, cities, roadsteads, estuaries and approaches thereto. The unfortified portions are those lying between or adjacent to the fortified portions.

Lines of defense for both the coast guard and coast artillery supports are determined upon and planned in detail in time of peace for each fortification; the works necessary for each line are surveyed and mapped out in detail.

Line of Departure.—A line representing the prolongation of the axis of the

gun at the instant the projectile leaves the bore; it is therefore tangent to the trajectory at the muzzle. It is sometimes called the line of fire.

Line of Direction.—A line in the vertical plane from the gun to the center of the target at the instant the shot strikes.

Line of Impact.—The line tangent to the trajectory at the point of impact.

Line of Shot.—The line from the gun to the point of impact.

Line of Sight.—A straight line passing through the sights of the piece; at the instant of firing this line passes through the target.

Litmus.—A dye stuff extracted from certain lichens as a blue amorphous mass which consists of a compound of the alkaline carbonates, with certain coloring matters relating to orcin and orcein. When litmus is used as a dye it is turned red by acids and restored to its blue color by alkalis (common salt is a good one).

Litmus Paper.—Paper saturated with blue or red litmus, used in testing for acids or alkalis. It is essential to the service in that it is used for testing powder and explosives to determine whether or not they are deteriorating in storage; which fact is indicated when the blue litmus paper is turned red in the presence of acid fumes which are given off to a greater or less extent when a powder or explosive is deteriorating. The amount of deterioration is indicated by the length of the time required for the paper to change color.

Loading Platform.—That surface upon which the cannoneers stand while loading the piece.

Loading Position.—At gun batteries; breech closed, cannoneers at posts for inspection, projectile and powder charges on truck near the delivery table.

At mortar batteries; mortars horizontal, breech closed, cannoneers except No. 6, at post of inspection, projectiles on trucks about ten feet in rear of mortars, powder at entrance to pit, No. 6 is at the entrance to the powder magazine.

Loading Room.—A room suitably equipped for the loading of submarine mines.

Loading Tray.—A device used to protect the breech while loading.

Location of a Target.—The determination of its range and azimuth from a given point. See RELOCATION OF A TARGET.

Longitudinal.—Extending in length; running lengthwise. The longitudinal extent of a gun would be its length from breech to muzzle.

Long Roll.—A drum alarm signal, when, if practicable, each man goes direct to his post at a run.

Lug.—A projecting piece to which anything is attached, or against which anything bears, or through which a bolt passes.

Lyddite.—A high explosive of British manufacture.

Machine and Rapid-Fire Gun Mounts.—Guns of this class used in coast defense are mounted on *moving* or *traveling* carriages, and *fixed mounts*, called rapid-fire mounts, which are disappearing or non-disappearing, recoil or non-recoil.

Machine Guns.—Guns of one or more barrels using fixed ammunition and provided with mechanism for continuous loading and firing. The mechanism may be operated by man power or by the force of recoil. They are designed to deliver a strong, rapid, continuous and accurate fire of small projectiles. See AUTOMATIC MACHINE GUNS and SEMI-AUTOMATIC MACHINE GUNS.

Magazine.—In a literal sense any place where stores are kept; as a military expression a magazine signifies rooms and galleries for the storage of powder, primers, fuses, etc. Magazines are classified as *peace magazines* and *storage magazines*.

Main Bore.—That part of the bore in front of the forcing cone.

Maneuvering Rings.—Large cast iron rings fastened in the walls of emplacements, designed for holdfasts in mechanical maneuvers.

Manning Party.—The personnel assigned to the service of any specific element of the defense.

Manning Table.—A list of the names of those who constitute a manning party, with the particular post to which each is assigned.

Mark One.—A term used to indicate the first improvement of the original model of a particular type of gun, mortar, etc.

Marine Obstructions.—Sunken hulks, subwater piles, dams, booms, barricades, rope entanglements and any other form of barrier that may delay the enemy in navigating a defended water area.

Masking Mount.—See CARRIAGE or MOUNT.

Master Electrician.—A non-commissioned staff officer charged with the general supervision of the electrical and power installations of an artillery district or post. He assists the artillery engineer in his work and is required to make inspections and tests of electrical plants and installations, and perform such other technical duties as may be necessary. Insignia: Gold wreath with red forked lightning within and a small white star about one-half of an inch above the red lightning, all to be of silk embroidery thread.

Master Gunner.—A non-commissioned staff officer employed in photographic work and seacoast engineering, in the preparation of tables, charts and maps, and for such other technical artillery duties as he may be qualified to perform. Insignia: Gold wreath, inclosing a red projectile and a small white star about one-half of an inch above the projectile, all to be of silk embroidery thread.

Material Target.—A target used for all subcaliber practice with guns. When used as a fixed target it is moored fore and aft, as nearly broadside to the battery firing as possible. For battle, fire and mine command practice two or more targets are used on the same towline, separated by about 100 yards. For record subcaliber practice at moving targets it is towed at the end of a 300-yard towline. The standard material target for use as stated above consists of a buoyant base upon which is mounted a vertical rectangular frame 10x24 feet, covered to within 2 feet of the bottom with white cotton cloth divided into three panels, the middle panel being painted black. The base consists of two parallel flotation sills each of a 10x10 inch timber, surmounted by a 3x10 inch plank nailed thereto; three cross-pieces, a prow and four diagonal braces, the whole being fastened with a bridle for towing.

All record firing for rapid fire guns below 4.7-inch caliber is made with the above size of target. For guns above 4-inch the standard material target 30 feet high by 60 feet long is used. See PYRAMIDAL TARGET, HYPOTHETICAL TARGET.

Maul.—A heavy wooden beater or hammer, used in driving stakes, tent pegs, etc. Usually miscalled mallet by inexperienced soldiers.

Maximite.—A high explosive shell filler. It is fusible and very suitable for

armor piercing shell, which are charged by melting the maxinite and pouring it in.

Maximum.—The greatest value of a variable quantity or magnitude, in opposition to *minimum*, the least.

Maximum Ordinate.—The vertical distance between the line of sight and the summit of the trajectory.

Maximum Pressure.—The greatest pressure in the bore of a firearm. The pressure indicated by the pressure gauge.

Maximum Range.—The greatest range obtainable by using the maximum elevation permitted by the carriage.

Mean Lateral Deviation.—The arithmetical mean of the lateral deviations of the points of impact of a series of shots, from the center of the target.

Mean Longitudinal Deviation.—The arithmetical mean of the longitudinal deviations of all the points of impact of a series of shots, from the center of the target. For example, if six shots were fired and struck as follows: No. 1—50 yards over. No. 2—10 yards short. No. 3—10 yards over. No. 4—30 yards over. No. 5—2 yards over. No. 6—12 yards short. The mean longitudinal deviation would be $114 \div 6 = 19$ yards.

Measure of Uniformity.—The regularity in the velocity given by a number of consecutive shots. It is calculated by taking the mean observed velocity, and from it deducting the difference in velocity of each shot, and dividing the sum of the differences by the number of shots fired.

Mechanic.—A specially qualified artilleryman holding the grade of that name in a coast artillery company. Insignia: Two crossed hammers of red cloth.

Mechanics.—The science which treats of the nature of forces and of their actions on bodies, either directly or by the agency of machinery.

Medium-Caliber Guns.—Guns of 4-inch, 4.7-inch, 5-inch and 6-inch caliber.

Melinite.—A high explosive compound of foreign manufacture

Melting and Thawing Explosives.—The explosive shell filler maxinite is melted by placing it in a copper watertight vessel and immersing it in a boiling water bath, the temperature being kept practically at 212 degrees F. Dynamite is thawed by putting the cartridges or sticks of frozen dynamite in a watertight vessel and immersing it in warm water. If sufficient time is available a better method would be to leave the boxes open for several hours in a warm room or by taking the cartridges out of the boxes and laying them on a shelf in a room at which the temperature is about 70 degrees F., and thus allow the cartridges to thaw out gradually.

Mensuration.—The act or process of measuring. That branch of applied geometry which gives rules for finding the length of lines, the areas of surfaces, etc., from certain simple data of lines and angles.

Mercurial Barometer.—An instrument used in the meteorological station to determine the pressure or density of the atmosphere.

Meteorological Message.—The message sent to fire commanders by a meteorological observer. It includes the barometer and thermometer readings, the atmosphere reference numbers and the velocity and azimuth of the wind.

Meteorological Observer.—An enlisted man in charge of the meteorological station.

Meteorological Station.—A station containing instruments for obtaining and sending out to the various primary stations data relating to the density of the atmosphere and the velocity and direction of the wind.

Micrometer.—An instrument, used with a telescope, for measuring minute distances or apparent diameters of objects which subtend minute angles. The measurement given directly is that of the image of the object formed at the focus of the object glass.

Micrometer Caliper or Gauge.—A caliper or gauge with a micrometer screw for measuring dimensions with great accuracy.

Military Crest.—The military crest is that part of a hill or mountain, from which all or a greater part of the downward slope within range can be seen and subjected to direct fire. It generally differs from the actual or topographical crest, which is at the highest point or watershed.

Mine.—See SUBMARINE MINE.

Mine Command.—Such portions of submarine defenses and rapid-fire guns for the protection thereof as may be efficiently controlled by one man.

A mine command consists normally of one or more rapid-fire batteries, with the necessary elements for a complete mine system, including proper installation, control and repair of the mine fields. There may be more than one mine command in a battle area, depending upon the size of the harbor and the mine defenses necessary for the protection thereof.

Mine Commander.—A coast artillery officer assigned as such in orders from district headquarters. He exercises both administrative and tactical command of a mine command.

As an administrative officer it is his duty to have his command supplied with all material necessary for carrying out the improved scheme of submarine defense. In this he is assisted by a property officer, who is responsible to the mine commander for the material and equipment of the command.

Tactically the mine commander is responsible to his battle commander for the condition of the submarine defense material of his command and the efficient service thereof at drill or in action.

He is responsible for the instruction of the officers and men of his command in all matters pertaining to the care and use of the mine defense material and rapid-fire guns assigned to his command.

In battle-command drill and in action he undertakes to destroy such vessels crossing the mine field as the battle commander may direct. When ordered to exercise independent fire action he fires the mines in accordance with his own judgment. He exercises the same command over rapid-fire batteries assigned to the mine command, as is the case in fire commands.

He has control over and is responsible under the battle commander, for, the use of the mine field searchlights.

Mine Company.—A company assigned to the service of submarine mines.

Mine Field.—The area of water in which submarine mines are planted.

Mine-Field Lights.—Searchlights that may be used for searching when no attack on the mine field is anticipated, and to illuminate the channel for the purpose of aiding the entrance of friendly vessels. During an attack on the mine field their function is to deceive the enemy by searching over an area outside the field. The mine field should not be illuminated until the enemy's boats approach one of the fields.

Mine-Field Officer.—A coast artillery officer in charge of laying and maintaining the mine field.

He is responsible that the planting and loading sections perform their duties correctly and that proper material is used in the assembling and planting of mines; that all precautions for safety are taken in loading, planting and taking up of mines.

Mine Planter.—A seagoing tug 150 feet in length and about 30 feet beam. It has large deck space forward and little rigging. It is equipped with booms, winches, davits, catheads, triplex blocks, etc., necessary in handling and planting assembled mines.

Mining Casemate.—A protected building containing the controlling mechanism of the mine defense.

Minus Correction.—When conditions require the use of a range less than the actual range it is termed minus correction.

Minus Deflection.—A piece is said to have minus deflection when its axis points to the left of the target.

Misfire.—The failure of a powder charge to explode. In case of a misfire in artillery practice the breech will not under any circumstances be opened for ten minutes, nor until the primer has been removed, except when the primer is seated in the cartridge case.

Miter Wheel.—See BEVEL WHEEL.

Moat.—See DITCH.

Mobile Torpedo.—Ordinarily a cigar-shaped metal case containing an explosive charge and firing device; intended to run under the surface of the water and attack the hull of an enemy's vessel. There are two classes, dirigible and automatic. The former is controlled by electrical or other cables; the latter carry their own propelling agent and keep a given direction automatically. The latest type of automobile torpedo, known as the Whitehead torpedo, is now used almost exclusively. This torpedo is made of steel or phosphor-bronze, about 15 feet long and 19 inches in diameter, divided into compartments and carrying a large explosive charge forward which is fused and explodes on impact. Their functions in coast defense are as adjuncts to fixed mines, to cover waters of channels too deep or too swift to mine. They are usually fired from above water from launching tubes located ashore.

Monitors.—Armored vessels with very low freeboard and 10-inch and 12-inch gun turrets, one fore and one aft, of 11-inch armor. Average displacement 3,000 to 4,000 tons; length 250 feet; beam 50 to 60 feet. Armament usually consists of 10-inch and 12-inch guns and light rapid-fire guns on upper decks. The principal functions of monitors are to supplement the regular fortifications of coast defense.

Mortar.—A cannon employed to throw projectiles at high angles of elevation. Their length of bore is small in comparison with the caliber.

Mortar Battery.—The entire structure erected for the emplacement, protection and service of one or more pits of mortars.

Mortar Company.—A company assigned to the service of mortars.

Mortar Pit.—See PIT.

Mount.—See CARRIAGE or MOUNT.

Mounting Cannon.—The mechanical maneuvers necessary to place coast cannon in position.

Movable Armament.—Small caliber guns on wheeled mounts, such as the Colt automatic and Gatling machine gun.

Movable Carriage or Wheeled Mount.—A carriage or mount provided with wheels for ready transportation of the piece mounted thereon.

Mushroom Head.—The front face of the obturator.

Muzzle.—The front end of a cannon, including the mouth of the bore, the face and the swell.

Muzzle Velocity.—The rate of travel at which a projectile leaves the muzzle of a cannon. It is sometimes called initial velocity.

Nitro-Cellulose Powder.—The name applied to a form of smokeless powder used in modern ordnance, in which cellulose (unspun cotton waste) is the base.

Nitro-Glycerine Powder.—The name applied to a form of smokeless powder used in modern ordnance, in which nitro-glycerine is the base.

Non-commissioned Staff Officers.—The Coast Artillery Corps non-commissioned staff officers consist of sergeants major, senior grade; master electricians, engineers, electrician sergeants, first class; electrician sergeants, second class; master gunners, sergeants major, junior grade, and firemen. They are appointed after due examination, and receive warrants signed by the Chief of Coast Artillery.

Nose.—A name sometimes given to the point of projectiles.

Object Glass.—The glass in a telescope which is placed at the end of the tube nearest the object.

Oblique Fire.—Fire which is directed obliquely to the object fired at.

Observation Firing.—A term applied to one of the three methods of exploding submarine mines, i.e., where the time of firing is given from the mine commanders' station.

Observation Telescope.—A telescope used in target practice and in action to observe the striking point of shots.

Observer.—A member of the fire-control section who is in charge of and uses an observing instrument. Insignia: *First Class.* Red triangle with a red bar below within a yellow circle. *Second Class.* Same as first class, omitting the bar. All to be of cloth.

Observing Interval.—The time in seconds between two consecutive observations on a target (between two signals of the time interval bell) during tracking. The regular interval for guns is 15 seconds, and for mortars 30 seconds.

Observing Room.—The room of a primary station in which the position-finding instrument and necessary accessories are located.

Observing Station.—A position constructed in a favorable place for observing the field of fire. A protected position constructed in a parapet or traverse for the purpose of observation, commonly called "Crow's Nest."

Obturator Primer.—A primer of any type so constructed as to prevent the escape of powder gas through the vent.

Obturator.—In gunnery, any device for preventing the escape of gas; the term includes the entire mechanism.

Obturator Head.—The mushroom head of the breechblock.

Occult Light.—The act of screening or shutting off the beam of a searchlight.

Offensive Return.—An offensive return, during an engagement of mobile troops, consists in the assumption of the offensive by the defender with the pur-

pose of recovering ground just captured by the enemy, and of *returning* to the original position.

Ogive.—That curve of the head of a projectile which terminates at the point.

Oil Room.—A room in the emplacement for the storage of oil.

Oils.—The principal oils used in the coast artillery service are: *Hydroline*, for filling recoil cylinders. *Synovial*, for lubricating the breech recess and breechlock of cannon, and general lubrication of the carriage. *Light Slushing*, for slushing the bore of cannon and all exposed surfaces of the carriage. *Lubricant No. 4½*, for filling grease cups. *Linseed* (boiled), for use on retraction ropes, mixing paints, etc. *Kerosene*, for cleaning purposes.

Omniscope.—An apparatus used in the Lake type of submarine boats for observation, sighting and steering.

One-Pounder.—A rapid-fire gun whose projectile weighs one pound. The caliber 1.457-inch pompom, Vickers-Maxim gun is an example of this type.

Open Sight.—See SIGHT.

Opposite Angles.—When two lines meet and cross each other four angles are formed, and the opposite angles are equal to each other.

Orders of Fire.—1. *Unrestricted Fire.* When the only limitation imposed by the fire commander upon the action of a battery is the assignment of a target, the fire is said to be unrestricted. This is the normal fire action of a battery.

2. *Restricted Fire.* When the range at which to fire, the number of shots, the firing interval, or any other limitation except as to target, is imposed upon the action of a battery, the fire is said to be restricted.

In unrestricted fire, and also in restricted fire when the rate is not specified, the fire should be as rapid as possible.

Ordnance.—The term applied to artillery armament and the accessories and stores pertaining thereto.

Ordnance Machinist.—A civilian expert ordnance machinist, resident at each coast artillery fort.

Ordnance Officer.—See ARTILLERY DISTRICT ORDNANCE OFFICER, POST ORDNANCE OFFICER.

Ordnance Sergeant.—A non-commissioned staff officer charged with the care and preservation of all ordnance property at a coast artillery fort. Chevrons and Insignia: Three bars inclosing a shell and a flame. All to be of black cloth piped with red.

Orientation.—The process of adjusting an instrument, gun or mortar in azimuth.

Orientation Table.—A table showing the azimuths and distances of various points in a harbor.

Out of Commission.—A term applied to armament and fire-control stations that are not in such condition that they could be made ready for service in 24 hours.

Out of Service.—A term applied to armament and fire-control stations to which no manning party is assigned but which could be made ready for service in 24 hours.

Outposts.—Detachments thrown out from a force for the purpose of protecting it from surprise.

Outside of a Beam.—A point is said to be outside of a searchlight beam

when it lies on the outer side of a line passing through the axis of the beam as seen from the battle commander's station.

Paints on Projectiles.—Projectiles are painted so as to show the material used in their manufacture, their armor-piercing qualities, their center of gravity and their character.

Pantograph.—A device used on the plotting board of a fire-command station, to relocate for data for use at any battery in that command.

Parade Slope or Wall.—The rear slope or wall of an emplacement.

Parados.—Earthworks in rear of a battery for protection against fire from the rear. It may have interior, superior, exterior and traverse slopes.

Parallax.—An apparent displacement of an object observed through a telescope, due to the real displacement of the observer, so that the direction of the object with reference to the observer is changed.

In optics, parallax is an apparent displacement of the image upon the cross-wires in a telescope when the eye is moved across the eye-piece. It is due to the non-coincidence of the cross-wires with the focal plane of the objective. Both the image, as formed by the objective, and the cross wires, should lie in the focus of the eye-piece, i.e., in the same plane.

The image may be moved back and forth by moving the objective in or out, but the plane of the cross wires is fixed. When the two are brought into the same plane the image is brought upon the cross-wires. To accomplish this the eye-piece should first be focused on the cross-wires so that they appear most distinct, the irregularities of the wires being very apparent. There should be no image visible during this operation, that is, the objective should either be thrown out of focus by turning the focusing knob either all the way out or in; or the telescope should be pointed to the sky. The eye-piece should then be moved until the inner and outer limits of distinct vision of the wires are found, and then set at the mean position. The telescope should then be pointed toward the object and moved until the image also comes into focus accurately. If parallax is now found it should be removed by refocusing.

The adjustment of the eye-piece will be correct for the same observer regardless of the range and object sighted upon, but it may be necessary to refocus the objective when the range differs materially.

Parallel.—Parallel planes and lines are the same distance apart at all points; if prolonged they will never meet.

Parapet.—That part of a battery, composed of earth, timber, stone, metal, etc., which give protection to the armament and personnel from front fire.

Patrol Boats.—Boats of the torpedo-boat destroyer type. During fog or thick weather they are necessary to guard the mine fields and such independent mine groups as are not covered by the shore defenses; also, at night, they patrol the approaches within the battle area with the object of preventing the small craft of the enemy from stealing into the inner waters, under cover of darkness of the land shadows. In case searchlights are occulted or fail, the boat patrol is the only means available to discover any movement of the enemy and give the alarm.

Pawl.—A pivoted tongue, sliding bolt or catch, adapted to fall into notches or indental spaces in such a manner as to permit motion in one direction and prevent it in the reverse, as in a windlass.

Penetration of Projectiles.—The ability of a projectile to overcome the

resisting qualities of an armor plate by completely or partially perforating it. The ability to perform this function depends on the relative merits of the particular projectile, the plate against which it is fired, the striking velocity and the angle of impact.

Percussion Cap.—A cap in which the method of explosion is due to a blow; used in fixed ammunition.

Percussion Fuse.—A fuse which is armed or prepared for action by the shock of discharge and acts upon impact.

Percussion Primer.—The type of primer used in fixed ammunition which is exploded by a blow of the firing pin.

Periscope.—An apparatus used on the Holland type of submarine boat, for observation, sighting and steering.

Perpendicular.—Exactly upright or vertical; at right angles with the plane of the horizon. When two lines so intersect each other as to form four equal angles they are said to be perpendicular to each other.

Personnel.—The personal composition of any organized group of officers or men which has for its purpose the accomplishment of some service.

Picket Boats.—Any speedy boat or boats stationed outside the battle area to watch for the enemy and give warning of his approach.

Picric Acid.—A detonating and disruptive explosive of high order used as a base for explosives or shell fillers.

Piece.—The name applied to any type of cannon, whether gun or mortar. It is also used as a matter of convenience to designate both cannon and carriage when the cannon is mounted.

Pit.—That part of a mortar emplacement designed for mounting one or more mortars, usually four.

Pit Commander.—A non-commissioned officer (gun commander) in charge of a mortar pit.

Plane.—A surface without curvature which has length and breadth but no thickness; a surface real or imaginary, in which, if any two points are taken, the straight line which joins them lies wholly in the surface.

Plane of Departure.—The vertical plane containing the line of departure.

Plane of Direction.—The vertical plane containing the line of direction.

Plane of Sight.—The vertical plane containing the line of sight.

Planter.—See MINE PLANTER.

Planting Section.—A section of the enlisted personnel of a mine company, consisting of men required afloat. It is divided into a planter detachment and the small boat detachments.

Plotter.—A specially qualified enlisted man in charge of the plotting board at a fire-control station. Insignia: Red triangle with a red bar below within a yellow circle, all to be of cloth.

Plotting Board.—A device used in the position-finding service to quickly plot to scale the data sent from the position-finding instruments, and in connection with range and deflection boards, to determine the corrected data for firing. It consists essentially of a semi-circular drawing board with a radius of 45 inches, made of well-seasoned lumber. It has mounted upon it the necessary scale arms and gun center to determine the rate of travel of the target both in range and azimuth for use on the range and deflection boards.

By means of the gun arm the range and azimuth to the target from the directing point of the battery is found.

Plotting Room.—The room in which the plotting detachment works. It is usually located below and communicates with, the instrument room of the battery commander's station, or with the observing room of the primary station.

Plunging Fire.—Fire in which the line of departure passes below the horizontal plane.

Plus Correction.—When conditions require the use of a range greater than the actual range the correction is called plus correction.

Plus Deflection.—A piece is said to have plus deflection when its axis points to the right of the target.

Point.—That which has neither length, breadth, nor thickness—only position. In communicating numerals a word used as a mark of division, i.e., a period. For example, 106.20 would be expressed: "One-zero-six-point-two-zero."

Point Fuse.—A firing device inserted in the point of a shell not intended to penetrate; as shrapnel.

Point of Fall.—The point of intersection of the trajectory where it crosses the horizontal plane passing through the muzzle of the gun. See THEORETICAL RANGE.

Point of Impact.—The point where the projectile first strikes on meeting an opposing body.

Pointing.—The operation of giving a piece the direction and elevation necessary to hit the target. When the sight is used it is called "aiming"; when the sight is not used, it is called "laying."

Position Angle.—See ANGULAR ELEVATION.

Position Finder.—An instrument for locating a target. See AZIMUTH INSTRUMENT, DEPRESSION POSITION FINDER, HORIZONTAL POSITION FINDER, and SELF-CONTAINED POSITION FINDER.

Position-Finding System.—The system of position finding includes:

1. The horizontal base system, which employs azimuth reading instruments in stations at the ends of a base line, and a plotting board.
2. The depression-position finding system, which employs a depression-position finder at a considerable elevation above the sea level, and a plotting board.
3. The emergency system, which ordinarily employs a self-contained instrument located at the battery, with or without a plotting board.

Post Adjutant.—A coast artillery officer responsible, under the post commander, for the various reports, returns, rosters, details, records, orders and communications pertaining to the administration of a post. It is his duty to sustain the reputation, discipline and harmony of the command under all circumstances. He is assisted by a sergeant major and as many clerks as may be required. His tactical duties are those prescribed for regimental or battalion adjutants of infantry and, unless otherwise assigned, communicating officer of a fire command.

Post Artillery Engineer.—A coast artillery officer holding all engineer and signal property at a post on memorandum receipt to the district artillery engineer, and, except when it is so held by the commanding officer of a company or detachment assigned to the mine defense, he holds mine property in

the same manner. He is responsible to the post commander for the care, preservation and efficiency of all engineer and signal property under his control. He is charged with the supervision, test and maintenance of the electrical and lighting plants, also searchlights and lines of electrical communication. He is assisted by master electricians, engineers, electrician sergeants, firemen and such additional enlisted men as may be necessary. His tactical duties are those of searchlight officer unless otherwise assigned.

Post Commander.—The senior coast artillery officer assigned to duty at an artillery post. He has control, within the limits of the post and subject to higher authority, of all matters relating to coast artillery, its personnel and material. He appoints the post staff officers on duty at the post, corresponding to those of an artillery district, unless the headquarters of an artillery district is stationed at the post, in which event the artillery district staff officers serve as the corresponding post staff officers.

Post Commander's Flag.—See FLAG OF POST COMMANDER.

Post Commissary Sergeant.—A post non-commissioned staff officer in immediate charge of all commissary stores and property at a post. Chevrons and insignia: Three bars and a crescent (points to the front), all to be of cadet gray cloth.

Post Flag.—The national flag, 20-foot fly and 10-foot hoist. Hoisted daily in pleasant weather.

Post Non-commissioned Staff.—Ordnance sergeants, post commissary sergeants, and post quartermaster sergeants.

Post Ordnance Officer.—A coast artillery officer charged with the care of all ordnance property not charged to battery commanders. He holds all ordnance property and stores pertaining to the modern seacoast armament at the post on memorandum receipt from the artillery district ordnance officer. He is responsible that batteries out of service are kept in such condition that they can be prepared for service upon not more than 24 hours' notice. He is assisted by the post ordnance sergeants and necessary assistants. His tactical duties are those of a company officer unless otherwise assigned.

Post Quartermaster.—An officer charged with the care and supervision of all quartermaster property at a post, as well as the receipt and issue of all quartermaster stores, etc. His tactical duties, if a coast artillery officer, are those of company officer unless otherwise assigned.

Post Quartermaster Sergeant.—A post non-commissioned staff officer in immediate charge of all quartermaster property at a post. Chevrons and Insignia: Three bars of buff cloth and insignia of Quartermaster Department.

Post Telephone Switchboard.—A central telephone station.

Powder.—See GUNPOWDER.

Powder Blast.—The force of the powder gas for a short distance in front of the muzzle, which acts destructively on objects close at hand lying within its path.

Powder Cases.—Cases in which powder is contained in shipment from arsenals or storage until used. Three types are in common use; the zinc storage case with balata washers; the wooden storage case; and the metallic cartridge case hermetically sealed. The latter is rapidly replacing all the others in the service.

Powder Chamber.—The chamber in the bore for the reception of the powder

charge; it is usually cylindrical, but frequently conical and sometimes elliptical. It is between the breech recess and the centering slope, which unites it with the forcing cone.

Powder Chart.—A graphic chart used to determine the velocity to be expected from a given charge of powder considered as a function of the temperature of the powder.

Powder Chute.—In gun emplacements an inclined well or shaft for returning cartridges or dummies to magazine.

Powder Hoist.—A device for raising powder from the magazine to the loading platform.

Powder Hoist Well.—The shaft through which the powder hoist operates.

Powder Magazine.—See MAGAZINE.

Powder Room.—See CARTRIDGE ROOM.

Power and Light Equipment.—Equipment including engines, dynamos, storage batteries, motors, electric and other kinds of lights, and all material and supplies pertaining thereto.

Power Room.—A room in the battery provided for the necessary motor generators, induction motors and switch-boards.

Power Section.—A detachment of the enlisted personnel of a mine company consisting of the operators and assistants required at the power plants, searchlights and mining casemate of a mine command.

Power Station or Plant.—The principal source of supply of energy, usually electrical, for the power system of the fortifications and stations. The plant consists of a sufficient number of direct connected units to supply all the power needed for the entire installation under conditions of full load.

Predicted Firing.—Firing at which guns and mortars are given direction and elevation corresponding to a predicted point.

Predicted Point.—A point on the course of a moving target, as indicated on the plotting board at which it is predicted the target will arrive at the expiration of an assumed interval of time. This interval of time is called the *predicting interval*.

Predicted Time.—The time at which the target should reach a predicted point.

Predicting Interval.—See PREDICTED POINT.

Predictor.—An accessory of the mortar plotting board used to locate the position of the predicted and set-forward points.

Preponderance.—The excess (moment) of weight of that part of the piece in rear of the trunnions over that of the front, or the converse. It is measured by the force expressed in pounds necessary to balance the cannon when resting freely on the trunnions.

Pressure Cylinder.—A soft copper cylinder used in crusher gauges which is compressed by the explosion of the charge.

Pressure Gauge.—See CRUSHER GAUGE.

Primary Armament.—The armament of a coast artillery fort used to attack the side, turret and deck armor of war vessels, and carry large explosive charges into their interiors. It includes the 8-inch, 10-inch, 12-inch, 14-inch and 16-inch guns, and 12-inch mortars.

Primary Station.—The principal station of a base line. See BASE-END STATION.

Primer.—A wafer, cap, tube or other device for communicating fire to the powder charge. There are five classes of primers used in the U. S. Coast Artillery service, namely: Friction, percussion, electric, combination and igniting.

Priming Charges.—A charge consisting of black powder, quilted in each end of the bag containing the sections of smokeless powder for the purpose of igniting it.

Prismatic Powder.—A molded gunpowder hexagonal in shape, with a single round perforation through the center of the grain. It is either brown or black in color, depending upon the color of the charcoal used. The black prismatic powder is made of the ordinary black granulated powder, the "cannon powder" grain being taken as a base.

Probability Factors.—A table of factors which, multiplied by the width of a zone containing fifty per cent. of the hits, will give the width of zones containing any other percentage of hits.

Probability of Error.—As referred to gunnery, is that particular error in any direction in which it is an even chance will not be exceeded by any shot. It is based upon the rule that when the value of any quantity or element has been determined by means of a number of independent observations, each one liable to a small amount of accidental error, the result of determination will also be liable to some uncertainty. The probable error, therefore, is the quantity, which is such that there is some probability of difference between the determination and the true absolute value of the thing to be determined, exceeding or falling short of it. The probable error of a gun, in any direction, is a distance measured in that direction from the center of impact, of such length that it is an even chance that it will not be exceeded by a single shot, and for which it can be predicted that in the long run 50 per cent. of all shots fired will have a less error.

Probable Zone.—The space bounded by two parallel straight lines of such length that by the theory of probabilities 50 per cent. of the points of impact will probably be found.

Profile Board.—A thin plate or board having its edge so cut as to represent the outline of an object; it is used to prove the models of the breech and other exterior parts of a gun.

Progressive Powder.—An explosive or propelling agent of low order; for example, the charcoal and nitro-cellulose powders. The explosion of powders of this kind is marked by more or less progression. The mass is ignited at one point and the combustion proceeds progressively over the exterior exposed surfaces and then at right angles to these surfaces.

Projectile.—A term applied to a missile usually thrown from a firearm by some explosive, to strike and destroy some distant object. The principal parts of a modern projectile include the point or nose, the ogive, the bourrelet, the base, the rotating band and the fuse hole.

Projector.—The technical name of a searchlight.

Proof of Gunpowder.—A certain test made on separate lots of gunpowder before it is accepted by the War Department.

Proof Plug.—See CRUSHER GAUGE.

Property Officer.—The senior company officer of a mine command. He is responsible to the mine commander that requisitions are made for the necessary

apparatus and material for the mine defense. He has direct charge of all property appertaining to the care, loading and planting of submarine mines.

Protractor.—A mechanical instrument used for laying out and measuring angles on paper.

Pyramidal Target.—A material target in the form of a pyramid, covered with canvas painted vermilion, divided into rectangles 2 feet wide, which are painted alternately vermilion and white. This pyramid is mounted on a float made of two parallel sills of timber, joined by transoms, two diagonal braces and a prow to which a suitable bridle is attached for towing. This target is used as a fixed target for all trial shots, and in case the material target for heavy guns has not been furnished, two of these targets are towed 60 feet from center to center, with a red streamer suspended from a wire or hemp line at the middle point between them, to represent the material target. For service practice with mortars this target is used to represent the center of a circular hypothetical target 100 yards in diameter. For subcaliber practice with mortars this target without canvas covering but with a flagstaff and flag is used.

Quadrant.—The quarter of a circle or the quarter of the circumference of a circle; an arc of 90 degrees. See GUNNER'S QUADRANT.

Quadrant Angle of Departure.—The angle between the line of departure and the horizontal plane through the muzzle. It is obtained from the angle of departure by correcting for the angular elevation or depression of the target, including curvature of the earth.

Quadrant Elevation.—The angle between the horizontal and the axis of the bore when the piece is pointed. It is obtained from the angle of departure by correcting for the angular elevation or depression of the target including curvature of the earth and for jump.

Quartermaster.—See ARTILLERY DISTRICT QUARTERMASTER and POST QUARTERMASTER.

Quartermaster Sergeant.—See POST QUARTERMASTER SERGEANT.

Quick-Firing Guns.—A British term for rapid-fire guns.

Quickness of Burning.—The rapidity with which a grain of powder is consumed. When it is said that the powder is too quick or too slow for a gun; the quickness of burning through the "critical dimension" of the grain is referred to.

Rack.—A bar or arc, having teeth that engage with those of a gear wheel or worm.

Radial Vent.—A vent extending at right angles to the axis of the bore.

Radius.—Any line extending from the center to the circumference of a circle; it is one-half the diameter.

Rammer.—A rod provided with a graduated brass ring; used for properly seating a projectile in the bore of seacoast cannon.

Ramp.—An inclined plane or foot-path, serving as a means of communication from one level to another.

Rampart.—A broad embankment of earth around a place upon which a parapet is raised. A structure forming the substratum of every permanent fortification.

Range.—The range in gunnery is the horizontal distance from the muzzle of the gun to the target. The word is applied in a general sense to other hori-

zontal distances, as, for instance, to the distance between the position finders and the target, or between a position finder and a splash, etc.

The range of a shot is the horizontal distance from the center of the gun to the point where the projectile first strikes.

Range-Azimuth Table.—A table of ranges and the corresponding azimuths from a gun to points in the center of the main ship channel or channels. It is kept at the gun and used for firing without the use of the range-finding apparatus.

Range Board.—A device for obtaining the range corrections which must be made for wind, atmosphere, tide, velocity, and travel of target during the observing interval and time of flight.

Range Deviation.—The difference between the range to the target and the range to the point of impact.

Range Difference.—The difference in range of a point from any other two points, as, the difference between the range to the target from the directing gun, and the range to the target from any other gun of the same battery.

Range Finder.—An instrument for determining the range to a target or object, from some fixed point.

Range Keeper.—A specially qualified member of the fire-control section, who operates the time range board and calls out the range to the range setter as often as may be necessary to insure the piece being kept at proper elevation. In restricted fire at a specified interval he keeps the time and indicates to the chief of detachment the proper time to trip the gun.

Range of Ballistic Tables.—See THEORETICAL RANGE.

Range Officer.—A coast artillery officer in immediate charge of all or a part of the fire-control section.

He is stationed at the battery plotting-room. He is responsible to the battery commander for the condition of the material pertaining to the fire-control service, for the instruction of the fire-control personnel and for the efficiency of that service in general. Upon opening the station he should make careful inspection of the equipment, verify the adjustment of the position-finding instruments, plotting-board, etc. After satisfying himself that everything is in order and receiving the reports of the chiefs of details, he reports to the battery commander: "Sir, fire-control stations in order," (or reports defects he cannot readily correct).

In battle and fire-command drill or action, he receives directly from the fire commander and executes orders, as to the assignment of targets. When direct communication between the fire commander and the battery commander is impracticable he receives directly and executes other orders pertaining to the fire action of the battery. He is responsible to the battery commander for the prompt and accurate transmission to the battery commander of orders received by him from the fire commander.

At the close of the drill or action he directs stations to be closed, inspects them and reports to the battery commander, handing him all records pertaining to the work at his station.

Range Rake.—An instrument made in the form of an ordinary rake. The main arm is shaped like a gun stock with the cross arm extended at front end. At a convenient distance on the main arm is placed a guide peg representing the rear sight, while on the cross arm pegs are placed at intervals of one-

half of an inch to represent points, each point having a value in mils equal to 1/1000 the length of the towline connecting the target with the tug upon which the observations with the range rake are taken. To use the range rake the observer takes position at a point in the center of the stern of the tug and aims the rake so that the line of sight from the guide peg will pass over the center peg on the cross arm and thence to the target. At the instant the splash of the shot occurs, the observer, keeping the rake pointed as above described, sights over the guide peg and in the direction of the splash, observing which peg on the cross arm is in line with the splash. For example, if a shot struck five divisions of the rake beyond the target (or five pegs), assuming the value of each peg at 10 mils, the reading in mils would be 50; if the towline wet measured 295 yards, the shot would have struck 14.75 yards over. This is obtained as follows: $50 \times 295 \div 1000 = 14.75$ yards.

Range Scale.—The graduations in yards either on the range scale arc of rapid fire guns, or the quadrant arc of large-caliber guns.

Range Setter.—A specially qualified member of the gun section who lays the gun for range.

Range of a Shot.—See RANGE.

Range Table.—A properly constructed range table for a particular piece, containing the range, time of flight, drift, etc., for each elevation.

Rapid-Fire Gun.—A single-barrel breech-loading gun provided with breech mechanism, mounting, and facilities for loading, aiming and firing with great rapidity. The breech mechanism is operated by a single motion of the handle or lever. The smaller calibers use fixed ammunition.

Rapid-Fire Gun Carriage.—See CARRIAGE or MOUNT.

Rate of Fire.—The average rate of fire of heavy caliber guns with service charge should be about one shot in forty or fifty seconds.

Ratings.—A particular class or grade to which enlisted men belong. In the coast artillery they may be rated as sergeants major, master electricians, engineers, electrician sergeants, master gunners, firemen, casemate electricians, observers, plotters, chief planters, chief loaders, gun commanders, gun pointers and gunners.

Ready.—At gun batteries, a signal given to indicate to the gun pointer that the piece is ready to be fired. At mortar batteries, a signal given to the battery commander that the mortars are ready to be fired.

Rear Slope.—The rear slope to the parade in rear of the battery.

Receiving Table.—The hoist table on which ammunition is placed preparatory to raising it to the loading platform level.

Recoil.—The backward movement of the gun on firing. It is measured by the distance which some point on a gun or carriage travels during recoil. See SECTOR OF EXPLOSION.

Recoil Cylinder.—The hydraulic cylinder attached to the carriage for controlling the recoil of the piece.

Reconnaissance.—An examination of a territory or military position, for the purpose of obtaining information necessary for directing military operations.

Reconnaissance in Force.—A demonstration conducted in the same general manner as a regular attack. It is made for the purpose of drawing the fire of the defense, discovering his strength, dispositions, location of batteries, etc.

Recorder.—An enlisted man stationed at each battle- and fire-commander's

station who keeps an accurate written record of all orders and communications received and transmitted by the battle or fire commander.

Records of Firing.—Data taken during target practice or that relating to the gun, carriage, conditions of loading, laying, etc., which would be of value in connection with future firings.

Rectangular Target.—See MATERIAL TARGET.

Redoubt.—Usually a roughly constructed field-work of varying shape in which all or nearly all the angles are salient angles. They are usually employed only in positions in which a small body of troops desire to make a very vigorous defense.

Reference Numbers.—Arbitrary numbers used to avoid “plus” and “minus,” “right” and “left,” in data for firing. These numbers are used on the graduations of scales on devices of the position-finding equipment to avoid liability of error by the use of one set of numbers instead of two sets. Without reference numbers it would be necessary to have one set of numbers for plus, and another set for minus corrections. For example, if the wind curves on the range board were numbered in both directions from zero, there would be a “plus” 10-mile wind curve and a “minus” 10-mile wind curve. In use it would be comparatively easy to make the mistake of taking the *plus* 10, instead of the *minus* 10. The corresponding reference numbers, however, for wind would be 60 for *plus* 10, and 40 for *minus* 10 (50 being the zero). In this manner the liability of error is minimized.

Regulations.—Under the Constitution of the United States, any rules for the government and regulation of the army made by Congress. Regulations imply regularity and signify fixed forms; a certain method, order or precise determination of functions, rights and duties. It embraces administrative service, system of tactics, and the regulation of service in campaign, garrison and in quarters.

Reinforce.—See BREECH REINFORCE.

Relay.—The command given when mortars are not to be fired as laid, but are to be fired on the next data furnished.

Relocation of a Target.—Any process whereby having the location of a target from one point, its range and azimuth from some other point may be determined without further observation.

Remaining Velocity.—The velocity of a projectile at any point of the trajectory.

Reserve Table.—A table in a sheltered position for reserve ammunition.

Resistance of the Air.—The retarding effect of the air on projectiles during their flight.

Restricted Fire.—See ORDERS OF FIRE.

Retardation.—The velocity a projectile loses in consequence of a resisting medium.

Retractor.—A device for withdrawing the empty cartridge shell rearward from the bore of small-calibered guns.

Reverse Fire.—Reverse fire is when the object is fired at from the rear.

Ricochet.—The rebound of a projectile along a surface.

Rifle.—A cannon or gun with the interior surface of its bore grooved with spiral channels or cuts, thus giving the projectile a rotary motion. If the interior surface of the bore is smooth, the cannon is known as *smooth bore*.

Rifling.—The spiral grooves cut in the surface of the bore of a rifle for the purpose of giving a rotary motion to the projectile.

Rifling, Twist in.—See TWIST OF RIFLING.

Rimbases.—The masses of metal uniting the trunnions with the trunnion band.

Ring Resistance Fuse.—A base or point fuse used in charged shell and shrapnel. The name is derived from the manner in which the firing pin is maintained in its normal or unarmed position by a brass split-ring spring.

Roadstead.—A water area where ships may ride at anchor some distance from the shore. An anchorage off shore.

Rocket.—A projectile set in motion by forces residing within itself, usually used for signaling.

Rotating Band.—The copper band encircling projectiles near their base for the purpose of giving them angular rotation in passing through the rifling of the bore.

Rotation.—The act of a body turning on its axis.

Rotation of Projectile.—The act of the projectile turning upon its axis during the time of flight.

Round.—A round of ammunition includes a projectile, charge and primer. To fire one round is to discharge one shot from each gun of a battery.

Roving Light.—A searchlight intended to search the battle area within the field not covered by fixed lights.

Row.—See HOOPS.

Rubber Impression of the Bore.—An impression taken on rubber and used to determine the amount of erosion or other irregularities of any portion of the bore.

Safety Lanyard.—A safety device attached to seacoast cannon consisting of a lanyard wound on a drum working against the action of a spring and attached to the gun. It is so arranged, by means of a ratchet and pawl, that a pull on the firing lanyard can not be transmitted to the primer until the gun is in battery.

Salvo.—To fire all the mortars of a pit or battery, or the guns of a gun battery simultaneously.

Salvo Fire.—Fire concentrated from one or more batteries against a salvo point.

Salvo Point.—A point, the azimuth and range of which are known and conspicuously posted in the battery; at which a concentrated fire from one or more batteries may be directed. Certain points in narrow channels are usually selected as salvo points.

Salvo Table.—A table giving ranges and azimuths of salvo points.

Scarp.—In field fortification the wall of the ditch adjacent to the parapet. It is always made at as large an angle as the nature of the soil will permit, the design being to offer the greatest possible obstacle to the assailant. The opposite wall or side is called the counterscarp.

Scout Ships.—Speedy seagoing ships that patrol at a distance off shore, to discover the approach of the enemy and signal information thereof to the signal stations ashore.

Screw Box.—The breech recess of seacoast cannon.

Searchlight.—A high-power electric arc light, used for night illumination.

Searchlights are classified as, Fixed Lights, Roving Lights, Illuminating Lights, Mine Field Lights and Battle Lights. The standard diameters are the 60-inch and the 36-inch lights. A few 30-inch and 24-inch lights are still in use.

Searchlight Area.—The area of land or water illuminated by a searchlight.

Searchlight Observer.—A member of a searchlight detachment equipped with a night glass, stationed outside of fixed or roving lights at such distance that he can detect readily any vessel passing into the beam.

Searchlight Officer.—A coast artillery officer in charge of the searchlight system covering a battle area, and the manning party assigned thereto. His station is at the battle-command station, or within speaking distance of the battle commander. He is responsible to him for the condition of the searchlight material and for the efficiency of the searchlight system. At night drill and in action he stands ready to execute the orders of the battle commander as to searching the battle area. When deemed necessary by the battle commander, the searchlight officer may temporarily take charge of the mine-field lights. He is responsible for the instruction of the personnel assigned to the control and operation of the searchlights, and by frequent inspections sees that they are thoroughly familiar with their duties and the prescribed method of searchlight control. In performing his duties from the battle commander's station he should be constantly on the alert to see that no vessel enters the battle area without being detected either by himself or one of his observers, and should so direct the searchlights as to promptly pick up any vessel entering the harbor.

Searchlight Operator.—An enlisted man specially trained in the care and operation of searchlights.

Searchlight Range.—The distance at which a target can be illuminated sufficiently for identification and range-finding purposes. The maximum effective illuminating range on a clear night would be approximately 8,000 yards for horizontal-base range-finding system; for purposes of water-lining the target in using the vertical base system the range would be approximately 6,500 yards.

Searchlight Tower.—An elevated structure containing the searchlight and its operating mechanism.

Seat of the Charge.—The form of that part of the bore of a firearm which contains the charge.

Secondary Armament.—The armament of a coast artillery fort used to defend the mine field; to attack lightly armored or unarmored ships, the upper works, etc., and personnel of war ships and defend the inner waters against small boats and landing parties. It includes 3-inch guns, small-caliber guns, and machine guns when on fixed mounts.

Secondary or Auxiliary Power Plant.—A reserve unit of power supply usually located at each battery, to furnish it with power in case the central power plant or main source of power supply fails or is put out of action.

Secondary Station.—A position-finding station furnished with an authorized range-finding instrument upon which readings are taken simultaneously with those at the primary station—if the horizontal-base system is used; or upon which range and azimuth readings are taken if the vertical-base system is used and it is desired to make observations and obtain data taken from that position.

Sector.—A plane figure part of a circle, inclosed between two radii and the included arc.

Sector of Explosion.—At the moment a cannon is fired, there is a sort of spherical sector of fire formed in front of the piece, called sector of explosion. The extremity of this sector presses against the rear end of the bore while the external portion of it terminates in the air, which it compresses and drives in every direction; the air thus forming a support, the sector reacts with its full force upon the rear end of the bore and causes the recoil of the piece.

Segment.—A piece of metal in the form of the sector of a circle, or part of a ring.

Self-Contained Horizontal Position Finder.—A position-finding instrument containing a horizontal base line within itself. This base line is from eight to twenty-five feet in length.

Semi-Automatic Machine Guns.—Rapid-fire guns in which the force of recoil is used to operate the breechblock, but not to load and fire the piece. See AUTOMATIC MACHINE GUNS.

Separate Observing Room.—An observing room which does not adjoin a plotting room or other observing room.

Separate Plotting Room.—A room in which the plotting board is located and used; instead of being located in the primary station.

Sergeants Major.—Coast artillery corps non-commissioned staff officers assigned to duty as assistants to adjutants in administrative functions. Their tactical duties are the same as those of regimental or battalion sergeants major of infantry and any coast artillery duty pertaining to their proper position. Chevrons: *Sergeant Major, Senior Grade.* Three bars and an arc of three bars. *Sergeant Major, Junior Grade.* Three bars and an arc of two bars. All to be of red cloth.

Service Charge.—The maximum quantity of powder that is prescribed to be used in any seacoast cannon.

Serving Table.—A table for keeping a supply of projectiles convenient to the breech during loading. It is usually mounted on wheels.

Serving the Vent.—The term implies the removing of the old primer from the obturator, inserting a new one, adjusting the slide of the firing attachment, attaching the firing wire or lanyard and cleaning the vent.

Set-Back Point.—A point on the course of a target determined in a similar manner as a *set-forward point*, but in the opposite direction.

Set-Forward Point.—A point on the course of the target in advance of a predicted point, at a distance from the latter equal to the distance passed over by the target during the time of flight of the projectile for that particular range.

Set-Forward Ruler.—A celluloid rule that may be used in the position-finding system for mortars, to determine the set-forward point. It consists of a time-of-flight scale in seconds, a travel scale in yards and a scale giving yards of travel during time of flight plus one minute. It is arranged in the form of a slide rule.

Shears.—A form of tackle consisting of two spars lashed together at one point, forming an inverted V.

Shell.—A steel or cast iron projectile the center of which is hollowed to be filled with the bursting charge.

Shell Filler.—See BURSTING CHARGE.

Shell Room.—The room for the storage of projectiles.

Shell Tracer.—A device attached to the base of a projectile which enables its flight to be followed. In the daytime a yellow smoke is emitted, and at night a bright flame.

Shimose Powder.—A high explosive of Japanese manufacture.

Shot.—A term applied to all solid projectiles.

Shot Chamber.—That part of the bore in which the projectile is seated. It includes part of the centering slope and the rear portion of the forcing cone.

Shot Gallery.—A gallery or room in the emplacement for the storage of projectiles.

Shot Hoist.—A device for raising projectiles from the hoist room to the loading or truck platform.

Shot Hoist Well.—The shaft through which the shot hoist operates.

Shot Room.—The room in earlier emplacements for the storage of shot.

Shot Tongs.—A mechanical device used to encircle the projectile at the center of gravity to facilitate handling.

Shrapnel.—A projectile composed of a number of spherical balls inclosed in a cast iron case, with a bursting charge in either point or base to scatter the missiles. The point is armed with a combination fuse. It is distinguished from shell by this point.

Sight.—An instrument by which the gun pointer gives the gun the proper direction for firing. Sights are of two classes, open and telescopic. The former consists of two points which are brought into line with the target by the unaided eye; the latter uses the magnifying power of the telescope and is the standard sight.

Sight Deflection.—The horizontal angle between the line of sight and the axis of the piece. It is used to correct for conditions of drift, wind, and movement of target tending to cause deviation.

Sight Elevation.—The elevation measured from the line of sight; it is the angle between the line of sight and the axis of the bore when the piece is pointed. It is obtained from the angle of departure by correcting for jump.

Sight Standard.—A vertical steel post supporting the sight.

Signal Rocket.—An ordinary skyrocket used in fortress warfare and exercises, as a means of communication.

Signal Station.—A station located if practicable at a height sufficient to give a sky background, from which visual signals are displayed.

Signs.—See PAGE 65.

Six-Inch Gun.—A rapid fire gun from 40 to 50 calibers in length and of 6-inch caliber; mounted either upon disappearing or pedestal carriage.

Six-Pounder.—A rapid-fire gun of 2.24-inch caliber. The name denotes the proper weight for the projectile of the piece.

Small Boats.—Launches, cutters, gigs and yawls, used in connection with submarine mine work, boat drill and transportation.

Small-Caliber Guns.—Guns of 3-inch caliber, 6 and 1-pounders.

Smokeless Powder.—The name given to nitro-cellulose and nitro-glycerin gunpowder.

Smooth-Bore Cannon.—See RIFLE.

Sound Travel.—The rate of travel of sound. Under normal conditions it is approximately 1,150 feet per second.

Specific Gravity.—The ratio of the weight of a body to the weight of an equal volume of water, in the case of solids and liquids; and to an equal volume of air in the case of gases; taken as the standard or unit.

Sphero-Hexagonal Powder.—A black gunpowder in the form of a small ball with a six-sided ring around the middle.

Spline.—A rectangular piece fitting grooves like key seats in a hub or shaft, so that while the one may slide endwise on the other, both must revolve together.

Sponge.—A swab used for cleaning the chamber and bore of guns and mortars.

Sprocket Wheel.—A toothed wheel that engages the links of a chain.

Spur Ring.—A ring having radial teeth on the circumference.

Spur Wheel.—A gear wheel having external radial teeth on the circumference.

Staff.—For administrative and other purposes, the staff of a coast artillery fort includes an adjutant, surgeon, artillery engineer, ordnance officer, quartermaster and commissary.

Standards.—See COLORS.

Stand Fast.—A command at which cannoneers halt until the previous command is repeated. When one member makes a mistake this command is given before the mistake is corrected.

Star Gauge.—A device for measuring the diameter of the bore of cannon. It is used during the manufacture and when it is necessary to determine if any enlargement of the bore has taken place.

Storage Magazine.—A building provided for the storage and preservation of powder or explosives; located so as to be protected from the fire of the enemy.

Storehouse.—Every coast artillery fort is provided with one or more storehouses for the care and storage of accessory material.

Storeroom.—A room in the emplacement for the storage of necessary material.

Storm Flag.—The national flag 8-foot fly by 4-foot 2-inch hoist. Hoisted in stormy or windy weather.

Strategy.—The art of moving an army in the theater of operations with a view to placing it in such a position, relative to the enemy, as to increase the probability of victory, increase the consequences of victory, or lessen the consequences of defeat.

Strength.—The number composing any military body.

Striking Angle.—The angle which the line of impact makes with the horizontal plane. It is equal to the angular depression of the point of impact plus the angle between the line of impact and the line of shot.

Striking Energy.—See ENERGY OF PROJECTILE.

Striking Velocity.—The velocity of the projectile at the point of impact.

Subcaliber Platform.—A steel platform attached to the breech of large-caliber guns upon which the breech detail stands to load the subcaliber tube during practice. After the platform is attached the piece is placed in battery. At batteries not equipped with the prescribed pattern a platform of wood is

constructed by lashing heavy planks to the sighting platforms so that they will extend about six feet in rear of the breech; flooring is then nailed to the planks.

Subcaliber Quadrant Scale.—Scales used on gun carriages to set the piece in elevation during subcaliber practice in place of the regular service scale. They are constructed for ranges in yards corrected for height of site and curvature, and are used in the same manner as the regular quadrant scale.

Subcaliber Tube.—A small caliber gun which is seated in the bore of a gun of larger caliber; used for target practice with ammunition of smaller charges and caliber than the gun in which it is used. In rapid fire guns this device is contained in a dummy projectile. They are classified as 30/100-inch caliber, 1-pounder, and 18-pounder.

Submarine Boat.—Small boats capable of maneuvering under the surface of the water. There are two types, namely: Holland and Lake. On the surface they have the appearance of a small monitor; when submerged only the conning tower, hood and sighting apparatus are visible; when completely submerged only the signal mast is visible and this only when desired or when submergence is not great. They fire torpedoes from one or two tubes in all three positions. Average length 60 to 70 feet; beam 11 to 14 feet; speed 10 to 12 knots; partially submerged 8 to 10 knots; submerged 8 knots.

Submarine Boat Signal Flag.—A flag of bunting showing a black fish on a white surface and surrounded by a red border. This flag is flown from the tender or parent vessel attending submarine boats. Its function is to notify shipping that a submarine boat is below the surface of the water in the vicinity.

Submarine Defense Equipment.—Submarine defense equipment includes submarine mines, mobile torpedoes, obstructions and all material pertaining to the placing and service of these means of defense.

Submarine Defenses.—Submarine defenses include submarine mines, mobile torpedoes, marine obstructions and submarine boats.

Submarine Mine.—A submerged stationary torpedo consisting of an explosive charge and firing device, inclosed in a water-tight steel case, to be fixed in position in a channel which it is desired to close against the passage of an enemy's vessels. They are classified as mechanical, when they are exploded by means of a firing device; and electrical, when exploded by electricity.

Superior Slope.—The top slope of a parapet or traverse.

Supplementary Station.—An auxiliary base-line station used to furnish data in place of the secondary station in case said station is put out of action, or to furnish data over a field of fire not covered by the secondary station.

Surface.—The exterior part of anything that has length and breadth; the outside, as the surface of the earth.

Surveyor's Transit.—An angle-measuring instrument similar in its essential parts to the azimuth instrument, but of more delicate and complicated design. It may be used to measure both horizontal and vertical angles as well as give the magnetic bearing. Its principal parts are shown by name and detail in chapter on Fire-Control Instruments, etc.

Swell of the Muzzle.—The enlargement of the exterior of the gun at the muzzle.

Symbol Charts.—See VESSEL CHARTS.

Tackle.—A purchase formed by reeving a rope through two or more blocks, for the purpose of hoisting.

Tactical Chain of Artillery Command.—The combined tactical units of seacoast defense.

Tactical Command.—Command at drill and during action.

Tactical Responsibility.—Responsibility for all matters affecting the efficiency of a tactical command.

Tactics.—The art of drilling troops, and of handling and maneuvering them in the presence of the enemy. See BATTLE TACTICS.

Take Cover.—A command which can be given at any time, at which all numbers not designated to remain at their post move at a run to some designated place under cover. As a rule this command is given in mortar batteries only.

Tangent.—A line lying in the plane of a circle and touching the circumference at one point.

Tangent of an Arc.—That part of the tangent which, touching the arc at one extremity, is limited by the line passing through the other extremity and the center of the circle.

Tangential Force.—A force which acts on a moving body in the direction of the tangent to the path of the body, its effect being to increase or diminish the velocity; distinguished from a *normal force*, which acts at right angles to the tangent and changes the direction of the motion without changing the velocity. A ricochet shot or a foul tip in base ball, are examples of applied tangential force.

Targ.—The piece of metal used to indicate the intersection of the arms on the plotting board.

Target.—The object at which guns or mortars are pointed; as a boat, ship or other object, whether stationary or moving.

Target or Vessel Tracking.—The process whereby successive positions of a moving target are plotted on a chart or plotting board. It includes the observations made by the observers at the position-finding instruments, the plotting of the results of these observations on a plotting board at the same time tracing thereon the plotted track of the course of the target.

Telautograph.—An electro-mechanical instrument by means of which the movement of an attached pencil used by a person in writing at one end of the circuit, will automatically trace or reproduce the characters, as written, at the other end.

Telephone.—An instrument by means of which a sound produced at one end of a wire is reproduced at the other end. There are two types in use—the Service Telephone, used in temporary installations; and the Composite Artillery Type Telephone, used in permanent installations.

Telescopic Sight.—A combination sight and telescope used for the aiming of guns at ranges greater than an object could be distinguished with the naked eye. The advantage of telescopic sights are the increased power of vision; large decrease in personal error; and the great facility and accuracy of aiming a gun at the greater ranges. See SIGHT.

Ten-Inch Gun.—A seacoast cannon usually 35 to 40 calibers long and of 10-inch caliber.

Terrain.—The ground, its configuration and natural and artificial diversifi-

cation. The topographical character of the country, region or tract, as viewed from a military standpoint.

Thawing Explosives.—See MELTING AND THAWING EXPLOSIVES.

Theater of Operations.—All the territory an army may desire to invade, and all that it may be necessary to defend.

Theoretical Range or Range of Ballistic Tables.—The horizontal distance from the muzzle of the gun to that point of the descending branch of the trajectory, called *the point of fall*, which is at the level of the muzzle of the gun. This definition of the theoretical range is strictly accurate and is conveniently applicable in using quadrant elevation, as with mortar fire; but in using sight elevation it is more convenient, assuming the principle of the rigidity of the trajectory, to define the theoretical range as the distance from the muzzle of the gun to the point of intersection of the trajectory with the line from the muzzle to the target, the distance being measured along this line. The point of intersection is called the point of fall.

Theory of Probability.—See PROBABILITY OF ERROR.

Thermometer.—An instrument for measuring temperature.

Three-Inch Gun.—A rapid-fire gun 40 to 50 calibers long and of 3-inch caliber. Commonly called "Fifteen Pounder."

Throttling Bar.—A bar in the recoil cylinder to regulate the size of the orifice through which the oil escapes from one side of the piston head to the other.

T-I Bell.—See TIME-INTERVAL BELL.

Tide Gauge.—A mechanical device used to register the height of tide in feet and hundredths above the datum plane (mean low water). It consists essentially of a float connected with an automatic registering device.

Tide Indicator.—A device operated electrically to indicate height of tide in all primary stations. It is operated by a controller located in the tide station.

Tide Station.—A station at which periodical readings of height of tide are made, recorded and sent to the various primary stations throughout the fire-control command.

Time Fuse.—A fuse which ignites the bursting charge at some fixed time after the projectile leaves the muzzle.

Time-Interval Bell.—A bell with electrical attachment, located in all emplacements, primary and secondary stations, for the purpose of sounding simultaneous signals to indicate the observing interval. Commonly called "T-I Bell."

Time of Flight Scale.—A scale giving the time of flight in seconds for any particular muzzle velocity and projectile, for ranges from one to twelve thousand yards. The term is also applied to the travel of the vessel in yards during the time of flight for any projectile at the range considered. In the case of mortars, the term is applied to the time of flight scale on the predictor, which gives the yards of travel during the time of flight plus one minute.

Time-Interval Recorder.—The ordinary stop-watch.

Time-Range Board.—A board to show range of target from battery at any instant. It is placed on the emplacement wall and is operated on data from the plotting room.

Tool Room.—A room in the battery for the storage of necessary tools and implements.

Torpedo.—An explosive device belonging to either of two distinct classes of submarine destructive agents intended for use in time of war. The torpedo proper to which the name properly applies, is a cigar-shaped vessel designed for offensive subwater attack against the enemy's ships. The other class to which the name is applied is a purely defensive weapon and is more correctly termed *submarine mine*. It consists of an explosive charge inclosed in a water-tight case which is submerged and anchored in channels, etc. See MOBILE TORPEDO.

Torpedo Boats.—Long, low and narrow war vessels modeled after torpedo-boat destroyers. They have no armor protection. Average speed, 22 to 29 knots, tonnage 103 to 107 tons. Armament, three to five one-pounders and three torpedo tubes. They are nothing more than metal shells three-eighths of an inch thick. They are necessary for each important fortified point, to meet and repel attacks made by the enemy's torpedo boats on the shipping at anchor inside the line of fixed defenses; to attack large ships of the enemy when opportunity offers, and protect the mine fields.

Torpedoboot Destroyers.—Long, low and narrow war vessels, with high bow and higher freeboard forward than aft. They have no armor protection. Average speed 29 to 31 knots, tonnage 275 to 740 tons. Armament, six to eight 14 and 6-pounders, and two torpedo tubes. Their functions in connection with coast defense cover the same general duties as those of torpedo boats, except that they have better seagoing qualities.

Torpedo-Detonating Pierce Fuse.—A delayed action fuse used to detonate high-explosive bursting charges in mortar projectiles.

Torpedo Shell.—A deck-piercing shell with an unusually large explosive cavity, fired from mortars for the purpose of carrying a large explosive charge to the decks of war vessels.

Towing Target.—Any target which is capable of being towed behind a boat.

Tracking.—The method employed in locating the course of a vessel on the plotting board, by taking simultaneous readings at the two base-end stations at regular intervals, and plotting the location of the target at the instant of each observation. See TARGET OR VESSEL TRACKING.

Trajectory.—The curve described by the center of gravity of the projectile. The path of a projectile in its flight through the air from the muzzle of the gun to the point of impact.

Transit Instrument.—See SURVEYOR'S TRANSIT.

Travel of Projectile.—The distance from the base of a projectile in its seat in the bore to the muzzle of the gun.

Travel of Target.—The distance passed over by the target in the time of flight. It is also used to express the distance passed over by the target in an observing interval.

Traverse.—In fortification, the structure perpendicular or oblique to the parapet wall, protecting the armament and personnel from flank fire. In gunnery, a term used to indicate the horizontal travel of the piece either to the right or left.

Traverse Slope or Wall.—The side slope or wall of the traverse.

Traversing Indicator.—A device used by gun pointers to control the traversing of a gun without command.

Tray.—See **LOADING TRAY**.

Trial Shots.—Shots fired before practice or action to determine, for guns, the muzzle velocity to be used; for mortars—the range and deflection corrections to be applied.

Trinitrotoluol.—A detonating and disruptive explosive of high order used as a base for shell fillers.

Tripping.—The act of releasing the counterweights of a disappearing carriage, thereby carrying the piece in battery, i.e., moving the top carriage forward so that the muzzle extends over the parapet.

Trolley.—A mechanical device for transporting projectiles on horizontally suspended tracks.

Truck.—See **AMMUNITION TRUCK**.

Truck Platform.—If the ammunition trucks run on a different surface from that of the loading platform, this surface is called the “truck platform.”

Truck Recess.—The spaces built in the parapet wall for the storage of ammunition trucks.

Trunnion Band or Hoop.—The hoop around a cannon, of which the trunnions form a part, located at about the center of gravity.

Trunnion-Sight Bracket.—A bracket attached to the right trunnion of a gun, which may be used for holding the telescopic sights.

Trunnions.—Trunnions are cylinders designed to rest in bearing surfaces of carriages, called “trunnion beds,” their axis being perpendicular to the axis of the bore, and ordinarily in the same plane; they connect the gun with the carriage and transmit the force of recoil from one to the other.

Twelve-Inch Gun.—A seacoast cannon usually thirty-five to forty calibers in length and of 12-inch caliber.

Twelve-Inch Mortar.—A seacoast mortar usually nine to ten calibers in length and of 12-inch caliber.

Twist of Rifling.—The inclination of the grooves to the axis of the gun at any point in the bore. The twist is said to be *increasing* when the inclination gradually increases from the breech to the muzzle; *uniform* when the inclination is constant. Twist is generally expressed in terms per caliber, viz.: one turn in 40 calibers, meaning that the projectile makes one complete revolution in passing over a length of the bore equal to 40 calibers.

Tube.—The inner wall of the bore of a built-up gun extending usually from the breech to the muzzle, ordinarily made one piece.

Tug Observer.—A coast artillery officer detailed by the post commander for duty aboard a tug engaged in towing and maneuvering targets during subcaliber or service target practice. His principal duties are to supervise the use of the camera or range rake in taking range deviations (overs and shorts).

Tug Officer.—A coast artillery officer in charge of a tug engaged in towing and maneuvering targets during subcaliber or service target practice. The actual maneuvering of targets from the tug is under the supervision of the master of the tug, subject to the orders of the tug officer.

Union Jack.—A flag of bunting consisting of 46 white stars, in six rows,

the first, third, fourth and sixth rows to have 8 stars, and the second and fifth rows 7 stars each, in a blue field.

Unit.—A military body acting together. Military units are divided into two classes, i.e., administrative units, which include those necessary for the proper care, housing, clothing, feeding, instruction, disciplining and keeping of military records; and tactical units, which are organized and equipped with a view of their highest efficiency in action.

Unrestricted Fire.—See ORDERS OF FIRE.

Vedette.—A mounted sentinel.

Velocity.—The common term used to denote speed, or rate of motion. Velocities with guns vary from 2,000 to 3,000 feet per second, with mortars from 550 to 1,300 feet per second.

Velocity of Combustion.—The rate of burning of a powder grain.

Velocity of Rotation.—The rate of motion of a body around its axis, as a wheel, as distinguished from progressive motion of a body in the direction of a distant point. In gunnery it is the rate of motion of the projectile at any point in the trajectory around its longer axis.

Velocity of Translation.—The rate of travel of the projectile in the direction of its flight.

Vent.—A small channel leading from the exterior to the powder chamber for ignition of the powder charge.

Ventilators.—The shafts or flues with movable covers for ventilation, leading from interior galleries or air spaces and opening through the superior slope.

Vernier.—A small auxiliary scale enabling the measurement of hundredths (or minutes and seconds) in connection with the main scale.

Vertical.—Perpendicular to the plane of the horizon. The line of direction through the center of the earth which is taken up by the plumb bob when freely suspended by a line and allowed to come to rest.

Vertical Angle.—An angle whose sides lie wholly in the vertical plane.

Vertical Base System.—The system of range finding in which the azimuth and range are determined by one position-finding instrument, located at either of the (horizontal) base-end stations. The base line in this system extends from the horizontal axis of the trunnions of the instrument vertically to mean low-water level. The vertical base feature of the position-finding instrument is used exclusively in this system.

Vessel Charts.—Charts, usually blue prints, used in the identification of targets. These charts consist of a system of vessel symbols giving a classification in outline of warships in connection with funnels and masts.

Vertical Plane.—Any plane which passes through a vertical line or contains the line of the plumb bob when freely suspended by a line and allowed to come to rest.

Vertex of an Angle.—The point at which the sides of an angle meet.

Vessel Tracking.—See TARGET OR VESSEL TRACKING.

Vickers-Maxim Gun.—A rapid-fire gun of 1.457-inch caliber, usually called "one-pounder."

Water Front.—That portion of the defenses bearing upon the navigable water areas that may be open to an enemy.

Wheeled Mount.—See CARRIAGE OR MOUNT.

Winch.—A machine operated by steam or other motive power, used on mine planters for raising anchors and other heavy weights. It consists of a drum, crank and the necessary gearing arranged for gaining power.

Wind-Component Indicator.—A device used in primary stations of the fire-control system to indicate to the operators of the range and deflection boards, the reference numbers corresponding to the range and deflection components of the wind as sent from the meteorological station.

Wind Vane.—A device pertaining to the meteorological station, which indicates the azimuth of the wind.

Wireless Station.—A station located within the fortification in which wireless telegraph apparatus is installed.

Worm.—A short threaded portion of a shaft, constituting an endless screw, formed to mesh with a gear wheel.

Xylol.—A colorless oily inflammable liquid, used in the bath for making the 135-degree stability test of nitro-cellulose powder.

Zero.—The point from which instruments, etc., are graduated. In communicating numerals it is a word used to indicate a cipher or naught. For example, 340.30, would be expressed: "Three-four-zero-point-three-zero."

Zone Energy.—A term denoting the relative armor-piercing power of different guns. It is estimated by the number of foot-tons per inch of the shot circumference. At the muzzle this power is a maximum, but owing to the resistance of the air it gradually diminishes during flight.

Zone Mort.—A French military expression denoting the space in which the projectile has lost its strength, or is spent.

Zone of Fire.—A term synonymous with specified fire areas. In mortar firing it is the particular area in which projectiles fall for a given charge of powder when the elevation is varied between minimum and maximum. The several zones of fire for the 12-inch steel mortars are, 1st Zone, 2,210 to 2,970; 2d Zone, 2,600 to 3,431; 3d Zone, 3,070 to 4,030; 4th Zone, 3,631 to 4,800; 5th Zone, 4,429 to 5,940; 6th Zone, 5,520 to 7,476; 7th Zone, 7,027 to 9,250; 8th Zone, 8,758 to 12,019 yards.

























In the case of rifle fire the defensive area between the guns and 4,000 yards range, is known as the "inner defense zone," between 4,000 and 8,000 yards range, as the "middle defense zone;" and between 8,000 and 12,000 yards range, as the "outer defense zone."

ABBREVIATIONS.

A.R.F.	All-round fire.
A.P.	Armor-piercing (shot or shell).
B'	Primary station of a battery.
B''	Secondary station of a battery.
B'''	Supplementary station of a battery.
BC	Battery commander's station.
B.C.	Battery commander.
B.L.L.	Bolt-locking lug.
B.L.R.	Breech-loading rifle.
C	Battle commander's station.
C.A.C.	Coast artillery corps.
C.A.D.	Coast artillery district.
C.A.D.R.	Coast artillery drill regulations.
C.E.	Corps of engineers.
C.I.	Cast-iron (shot or shell).
D.C.	Disappearing carriage.
D.C.L.F.	Disappearing carriage limited fire.
D.P.	Deck piercing.
D.P.F.	Depression-position finder.
D.R.	Drill regulations.
D-S	Driggs-Schroeder or Driggs-Seabury.
E	Emergency station.
F'	Primary station of a fire command.
F''	Secondary station of a fire command.
F'''	Supplementary station of a fire command.
F.A.	Frankford Arsenal; field artillery.
F.C.	Fire commander.
f.s.	Feet per second.
H.P.F.	Horizontal position finder.
I	Illuminating light.
I.V.	Initial velocity.
M.	Mortar; model.
M'	Primary station of a mine command.
M''	Secondary station of a mine command.
M'''	Supplementary station of a mine command.
M'-M'	Double primary station of a mine command.
M''-M''	Double secondary station of a mine command.
Met.	Meteorological station.
Mr.	Mark one, meaning, first modification.
mi.	Miles.
M.L.R.	Muzzle-loading rifle.
M.V.	Muzzle velocity.
O	Separate observing room.
O.D.	Ordnance department.
P	Separate plotting room.
P.	Pressure.

P.S.B.	Post telephone switchboard.
Proj.	Projectile.
R.	Rifle.
R.F.	Rapid fire.
S.	Searchlight.
S.E.	Striking Energy.
SS	Signal station.
S.V.	Striking velocity.
Sub. Cal.	Sub-caliber.
T	Tide station.
T.	Torpedo.
T.D.	Torpedo-detonating (Pierce fuse).
T. I. Bell	Time-interval bell.
V.	Velocity.
W.	Weight.
W.D.	War department.
WS	Wireless station.
Q.F.	Quick-firing.
Q.M.D.	Quartermaster department.
W. & S.	Warner & Swasey.

SIGNS.

<i>Primary Station of a Battery</i>	
<i>Secondary Station of a Battery</i>	
<i>Supplementary Station of a Battery</i>	
<i>Battery Commander's Station</i>	
<i>Battle Commander's Station</i>	
<i>Emergency Station of a Battery</i>	
<i>Primary Station of a Fire Command</i>	
<i>Secondary Station of a Fire Command</i>	
<i>Supplementary Station of a Fire Command</i>	
<i>Illuminating Light</i>	
<i>Primary Station of a Mine Command</i>	
<i>Secondary Station of a Mine Command</i>	
<i>Supplementary Station of a Mine Command</i>	
<i>Double Primary Station of a Mine Command</i>	
<i>Double Secondary Station of a Mine Command</i>	
<i>Meteorological Station</i>	
<i>Separate Observing Room</i>	
<i>Separate Plotting Room</i>	
<i>Post Telephone Switchboard</i>	
<i>Searchlight</i>	
<i>Searchlight 36 inch</i>	
<i>Searchlight 60 inch</i>	
<i>Tide Station</i>	
<i>Signal Station</i>	
<i>Wireless Station</i>	

CHAPTER II

THEORY AND PRINCIPLES OF COAST DEFENSE

THE fundamental object of coast defense—in the general acceptation of the term—is to afford suitable means of protection to the coast line with a view to resisting invasion by an enemy. Harbor defense is that branch of coast defense which has for its object the protection of important harbors and cities situated on or near the sea, as well as the securing of adequate anchorages and bases for the navy in time of hostilities. Thus coast defense in the largest sense becomes not only protective in its strength but a productive contributor to the nation's ability to carry on war beyond her coast line.

It is not practicable to fortify the entire extent of the coast in such a manner that an enemy in command of the sea could not land upon some portion of it. The cost of such an undertaking would be excessive, and the maintenance and number of men required as a personnel would make it prohibitive. It is essential, however, that certain selected points shall be permanently fortified, and in their selection the following conditions should be considered:

First.—The value of the property accumulated at such points and the importance of this property to the function of commercial pursuits, as well as the value of such points to the enemy.

Second.—The importance of defending convenient, well-protected and sheltered harbors or anchorages for naval and military bases, and preventing the occupation of such points by the enemy.

The means of defending the coast line are divided into two general units. The first of these comprehends the fortifications manned by the Coast Artillery troops proper; which include the personnel of the Regular Coast Artillery Corps, assisted by the Coast Artillery Reserve. The fortifications are protected against attack of small landing parties, by infantry troops, called Coast Artillery Supports.

The second general unit comprehends the troops necessary to protect unfortified portions of the coast line.

The functions of the navy are not within the scope of this work.

However, the navy is prepared, by reason of its mobility, to carry on offensive warfare. The means of protecting unfortified portions of the coast line are also tactically offensive in their action, while the harbor defenses or fortifications are purely defensive. Ships of the line and smaller craft such as monitors, scout ships, torpedo boats and submarine boats may be attached to the land forts and assigned as floating defenses unless it is desirable that they be otherwise engaged. Their functions consist of assisting the artillery defense at any point or points required in the plans of defense.

The functions of the coast artillery troops proper, are the manning and operation of the armament of coast forts, the control of the submarine defense and the location of such marine obstructions as may be found necessary at the entrance of harbors.

The coast artillery supports are charged with the duty of flank and land front security and information, as well as the protection of the fortifications against attack by small parties of the enemy landed close to their flanks, thus making sure that the coast artillery troops proper shall not be harassed or annoyed in the performance of their proper duties.

The function of the coast guard is the protection of unfortified portions of the coast line lying adjacent to fortifications, such protection being sufficient to resist the most powerful landing parties of the enemy and prevent the capture of the fortifications, together with the cities and harbors they defend. In this duty they will be supported by field armies.

THE THEORY OF DEFENSE

Before entering into a discussion of the various phases of fortress warfare it is appropriate to weigh the efficacy of fire to be delivered by the two combatants. It is evident that fire from ships cannot be delivered at as great an accurate range as that available to the guns of coast fortifications. The enemy is at a disadvantage in not being able to use the higher elevations with any degree of accuracy, which necessarily reduces his maximum effective range. In this connection attention may be called to the fact that the turret openings in the later types of battleships allow a twenty-degree elevation, which, with a 12-inch gun will give an extreme range of something like 21,000 yards. It is conceded, however, that accuracy cannot be obtained at a range exceeding say 10,000 to 12,000 yards, and this requires the ability to see the target, which would be extremely difficult if modern seacoast

batteries be the targets. On the other hand, the maximum accurate effective range of the land defenses is approximately 12,000 yards, or about seven miles, with moving targets easily identified.

It may be stated that the relative value of a battery ashore to that of one afloat is not a matter of gun against gun; it is a function of the relative degree of protection which each enjoys, as well as the volume of fire each can deliver. The protection afforded the battery of a seacoast fortification is much greater than that afforded the guns of ships.

The protection of a large-caliber gun mounted afloat, with its mechanism and ammunition, is limited to the necessities of compromise as to space and weight which pertain to all marine construction, while that of the gun ashore is limited only by that of cost. Apart from the question of its immediate protection, the gun afloat is necessarily dependent upon its platform, that is, upon the safety of the ship upon which it is mounted, and this is vulnerable throughout its entire underwater body to a mine or submarine boat, and, to a lesser degree, to shot and shell. If a ship is sunk the guns which it carries, together with the mobility which constitutes their special value, are destroyed and lost to their country for the remainder of the war.

It is right that a war vessel should take this risk when involved in a contest against her proper antagonist—the warships of the enemy—but it is indeed an exceptional case when a vessel should accept or involve herself in a contest with shore batteries and mine fields. The cost even of success in such a contest would probably be too great. Again, fortifications have a decided advantage in the means afforded them to determine the necessary data for laying the guns, while owing to the shortness of base lines in the range-finding system afloat, the data determined therefrom must necessarily be less effective than that obtained by the longer base lines used ashore. It must also be remembered that the shore gun, with its emplacement and disappearing carriage, is completely protected from the fire of the gun afloat and in most cases is entirely hidden from view, at the same time having a clear definition of the target.

ATTACKS FROM THE SEA

In order that definite plans of defense may be formulated, it is necessary to assume that the enemy will make one of the several forms of attack herein outlined:

Frontal Attack.—If it is assumed that the enemy will make a

frontal attack, that is, will attempt after bombardment, to run by the fortifications, the best means and principles to follow would necessarily be to have fortifications strong enough to repel such an attempt by graded artillery fire in the outer defense zones. To conduct an effective bombardment the enemy's vessels would in all probability steam successively to a buoy anchored at a known distance from the works, deliver their fire and go out again.

It is scarcely probable, however, that a frontal attack would take place at any of the more strongly fortified positions. Nevertheless, if the armament at these points compels the enemy to land in order to effect their capture, such armament is fulfilling its proper function in the role of defense.

This form of attack would be impracticable until the enemy had obtained command of the sea. As long as such command was in doubt, it would be his purpose to seek our fleet and engage it. If unsuccessful, it is hardly to be expected that he would attempt a frontal attack upon any fortification with the intent of entering a fortified harbor. A frontal attack must, therefore, take up such form more for the purpose of locating positions of the batteries than an attempt to run by.

Moreover, if a direct frontal attack of the enemy should be successful in silencing the fortifications, neither the ships themselves nor their personnel have the requisite tactical organization to complete the victory by landing. They are not able to supply the necessary number of men to take actual physical possession of the fortified points secured, capture the guns and other property, guard the large number of prisoners taken, and overcome the defense of the coast artillery supports, the coast guard and other available troops. It is therefore necessary that the enemy's army be present and ready to land when the attack is negotiated, and such a condition is not likely to exist until after command of the sea had been obtained.

The "Run By."—The object of a fleet in attempting to run by fortifications would be to enable it to enter a harbor and operate in the rear, as well as to make such a blow felt by the destruction or capture of the property in such harbors. The matter of a "run by" has become a most difficult problem for a fleet—and especially a foreign fleet operating against the United States—since the development of the present mine system. Without the mine fields, it is conceded as being possible for the fleet at full speed, at night and under favorable conditions of smoke, fog, etc., to run by the batteries without being discovered, or without the batteries being able to deliver an effective and deliberate fire. To accomplish this under present conditions, however, all regard

for the mine fields must be left out of consideration. They must be made ineffective by counter mining—the success of which is indeed very doubtful, if at all effective—or by cutting the cables beforehand. The location of the mine fields will always be kept a secret, so the matter of cable cutting must necessarily be done in order to assure success, although how such an operation will be successful is extremely hard to outline when consideration is given to the authorized floating defenses. The only other means available for the enemy would be that of dragging for cables, in which event it would be necessary, for success, to cover almost the entire ground occupied by the mines, and it is hardly possible that this operation would be effective under the conditions of security maintained by the floating and shore defenses, and the character of the mines themselves.

Leaving out of consideration the matter of fog, etc., the coast batteries are practically as effective at night with the searchlights in action, as they are in the daytime; and for an enemy to effect a “run by,” it must necessarily first put the searchlights out of action. These, together with the range-finding stations, and other fire-control stations, while apt to be rendered unserviceable by a chance shot, can only be successfully destroyed by landing parties.

It may therefore be stated that a successful “run by” can only be accomplished when the mine fields have been put out of action. The days of the “run by” fortifications, like those of charges by massed bodies of infantry, belong to the warfare of the past rather than to that of the future.

Landings.—During the second period of a war, or after the navy had been rendered ineffective, the object of a victorious enemy would probably be to obtain final decision upon the issues by invading United States territory with landing parties, or troops landed from transports, etc. There are many points on the coast at which an army might be landed, but to make such invasion effective and at all permanent, a suitable base must be obtained, that is, possession taken of a good harbor with terminal facilities for supplies, etc.

From both military and naval standpoints, such a port must be captured or established by the enemy before he can make his occupation effective and secure. It is reasonable to suppose he would try to effect a landing, and by that means attempt to capture a fortified point, rather than attempt it from the water side, as under the conditions of this assumption it is supposed a combination of armament and mines will effectively prevent any modern navy from entering a fortified harbor.

Bearing in mind historical cases of attacks on fortifications, namely,

Sevastopol and Port Arthur, the above assumption would seem reasonable, as both of these fortifications were captured from the land side. The allied fleets in the first instance, and the Japanese in the second, had command of the sea, maintained a blockade and kept their communications open, but left the reduction of the strongholds to the slow but certain process of siege operations. At Sevastopol the British and French men-of-war in concert on one occasion, attacked the harbor forts ineffectively and with considerable loss to themselves.

More recently at Port Arthur, the Japanese vessels did not even expose themselves to the fire of the Russian land batteries, but waited for their army to reduce the fortifications from the land side.

The general considerations attending combat with landing parties, belong to the functions of the coast artillery supports, the coast guard and the field army. It is one of the problems that confront commanders of mobile troops.

It is practically safe to assume that the enemy would attempt to effect a landing only under one of three conditions.

The first of these would be when he found a suitable unfortified place, uncovered or but sparsely occupied by troops, and so situated that it would be impossible to mobilize an army from the surrounding country of such strength, and in time, to defend or prevent the landing. Such a point might be found along the coast, particularly if the plans of the enemy were drawn with marked strategical insight. In other words, with the real idea of landing at the north a series of feints or false landings, apparently in force, might be demonstrated at the south, or vice versa.

At first glance we might consider such a line of reasoning as unsound, if not altogether impossible, under the assumption that the force necessary to accomplish such an enterprise would prevent its execution, particularly in view of the facilities for information and transportation afforded us by reason of our commercial telegraphs, railways, etc. Indeed, it would be impracticable, if we were contending with a second-class power or one of moderate limits of credit or men. However, before Napoleon, in the Marengo campaign, emerged from the Great St. Bernard Pass, after the passage across the Alps, few military specialists could have been found who would have admitted the possibility or likelihood of such an enterprise. The late Colonel Wagner, in commenting upon this feat, remarks that it would have been impossible at the present time with the facilities now enjoyed for information. He continues, however, that in all probability Napoleon would have won with as much ease to-day as he did yesterday; and the facts that con-

front us are that with all our enterprise and ingenuity, our cables, telegraphs, newspapers and fleets, a few years ago Cervera's fleet came over from Spain and unknown to us sailed into the harbor of Santiago de Cuba without being detected and without the slightest material strategic attempt being made to turn our heads to any other point than Cuba.

The questions of time and means are undoubtedly the leading things to be considered. Landings in force have the advantage of a powerful covering base, namely, the protecting fleet. Against this base no force of mobile troops would be effective. The length of time necessary to bring up and land an army with its necessary impedimenta is an extremely difficult problem to solve. The period, however, should not be in excess of the time required for the United States to mobilize a force strong enough to give it combat of enough effectiveness to prevent its advance to the nearest fortified point, for with the latter taken, the fleet—kept until that time beyond the range of the shore batteries—would sail quietly in and anchor.

With our navy destroyed or at points not accessible, and barring storms that might temporarily dislodge its base, the danger from landings in force may be considered as of grave import.

The second condition under which landings could be effected on unfortified portions of the coast, would be after bombardment by the fleet. The means of protection against such fire is a function of the engineers, and a consideration to be dealt with in the plans of defense of unfortified portions of the coast. The duty of the personnel, however, of the mobile army, coast guard, and coast artillery supports are attached closely to the means provided in these plans. Their functions might be characterized as those of a purely tactical nature, while the plans themselves belong rather to the science of strategy. In other words, no plan of defense could go to the length of explaining exact tactical dispositions. These must of necessity be left to the professional abilities of the commanding officer on the ground. Hence, in preparing himself, his officers and men, for the duty to be performed, there are set rules that should be studied theoretically and developed, if possible during peace time. It has been said, with much good reason, that it is not well to await an ideal condition of affairs in military instruction, but to make the best of things as they are, to economize time and utilize means as effectively as surrounding circumstances admit.

PLAN OF LAND DEFENSE

Before drawing up the plan of land defense for the locality considered, it will be necessary to make a careful examination of the ground in the vicinity with reference to the following details:

- (a) The best general line to be occupied by the infantry.
- (b) The best positions for mobile artillery.
- (c) The most favorable lines of advance for the enemy, should he succeed in effecting a landing.
- (d) The weak flank of the position, and the most favorable ground for counter attack.
- (e) Ground for the reserve, for the general reserve, for mounted troops, and for rallying positions in case of retreat.

In order to conceal the main position as long as possible, advanced lines may be established in front of the main trenches. Trenches should never be constructed so as to bring the troops against the sky line.

FIELD COMBAT

The established rules of field combat, briefly, are as follows: An engagement generally presents three distinct phases, namely, the *preparatory stage*, the *decisive action* and the *completion*.

The corresponding distribution of troops should be such as to carry out the following plan:

- (a) To engage the enemy, wherever he may attempt to land, with sufficient troops to stop him.
- (b) To withhold a part of the available forces for a powerful effect at the decisive point or moment.
- (c) To maintain a reserve, screened from the enemy's view and protected from loss, to take part in a vigorous pursuit in case of success, or to avert complete disaster by disputing his advance in case of failure.

In combat against landings in force these phases would not necessarily be fully developed; the preparatory stage might be brief and the decisive attack begun suddenly. Such combat is necessarily offensive and has the advantage of the choice of position, which should be selected so as to afford shelter to the defenders from bombardment and if possible screen them from view. Ranges in the foreground should be measured and marked.

The manner of occupying a position will vary with the nature of the ground, and with the strength and character of the troops available. It is therefore impracticable to apply fixed rules.

The troops available will generally be divided into two principal parts—one for occupation of the intrenchments, including local reserves; and the other the general reserve for reinforcing parts of the line and for the delivery of the decisive counter-attack or of the offensive return.

Should the enemy succeed in gaining a position threatening the line of defense, or penetrate that line, a counter attack becomes imperative, and the sooner it is made the better, so that the enemy may not have time to strengthen the ground he has gained. Such local counter-attacks are the special duty of the local reserves; they are made upon the initiative of officers in command of subdivisions of the defense.

Should the enemy attempt an assault he will be met with rapid fire and a counter charge with fixed bayonets. Every available man should be brought up and the enemy struck in flank if possible. If the defenders are successful and the assailants abandon the offensive the enemy should be pursued vigorously. If retreat on the part of the defenders is necessary, some artillery and intact infantry should occupy the rallying position and the remainder of the troops endeavor to gain the cover of the rallying position and there reorganize.

FIRE IN FIELD COMBAT

Fire direction is a function of the company commanders. Their instructions as to the general direction and character of the fight as well as the part their companies are to take in it are received from the next higher commanders. From the beginning of the action collective concentrated controlled fire should be delivered. To each platoon and section there should be allotted a certain subdivision of the enemy's line at which to fire, so that the distribution may be evenly divided along the assailant's front.

Fire control, in so far as it pertains to seeing that the orders for fire are implicitly obeyed, that proper ranges are used, that men are supplied with ammunition, that ammunition is not wasted and that the fire is concentrated on the portion of the enemy's line designated, is the duty of the lieutenants and non-commissioned officers.

NIGHT ATTACKS

The third condition under which an enemy would endeavor to effect a landing would be either at night or in foggy weather. In discussing this condition the night operations of the defense should be considered.

On the assumption that the enemy would attempt to land, outside of the range of the guns of permanent fortifications, night operations of the defense should be studied with a view of rapid concentration of troops for the decisive attack. Nothing but the most general rules for the defensive can be prescribed. The outposts must exercise the utmost vigilance, and the dispositions must be such that the line of resistance can be stubbornly held and quickly reënforced. Whenever practicable the position should be covered with obstacles, and successive echelons placed in positions favorable for the assumption of the offensive. Arrangements should be made to enable them to form their ranks with the least possible delay.

Smoking, talking, laughing and other noises in ranks should be prohibited. The watches of all officers should be set with those of the commanding officer.

The infantry should withhold its fire as long as possible and open with volleys.

Small Landing Parties differ from landings in force in that their objects are: (1) to procure information as to the position and strength of the land defense, condition of the land front, the armament, and morale, etc.; (2) to annoy the garrison by attacks in the nature of reconnaissance in force; (3) to attempt gaining admission to the fortifications by stealth or subterfuge for the purpose of destroying power plants, searchlights, etc.

Men landing from boats under these conditions are always at a disadvantage and are especially subject to severe loss from the fire of the movable armament assigned to fortifications, as well as the rifle fire of the coast artillery supports. Indeed, such landing parties have little or no importance if an efficient system of outposts and patrols is constantly maintained.

CHAPTER III

ORGANIZATION AND PERSONNEL

THE Regular Coast Artillery troops are organized as a corps, and assigned to artillery districts. The coast artillery reserve is composed of regiments, battalions and companies of the organized militia permanently assigned to fortifications at or adjacent to their home stations. The regular Coast Artillery troops and the coast artillery reserve together constitute the *coast artillery troops proper*.

Coast artillery supports are not a part of the Coast Artillery troops proper. They consist of mobile troops of the line of the Army. When assigned as such they are under the immediate orders of the Artillery District Commander.

The coast guard is not a part of the coast artillery troops proper. It consists of mobile troops of the line of the army. It is placed at strategical points near fortified portions of the coast line. It is organized the same as a field army.

TACTICAL

For tactical purposes artillery districts are divided into Battle Commands, Fire Commands, Mine Commands, and Battery Commands. The function of each is described in the DEFINITIONS.

ADMINISTRATIVE

For purposes of drill and administrative organization the Regular Coast Artillery Corps is divided into companies and assigned to coast artillery forts or posts. The strength of companies is prescribed in regulations. There is no battalion or regimental organization, except in the coast artillery reserve, when at their home stations, where provisional regimental or battalion organization is maintained.

In the regular service the Company, Post, District, Department, and War Department constitute the administrative channel.

PERSONNEL

The personnel of the Regular Coast Artillery Corps consists of a Chief of Coast Artillery, officers assigned to duty at the War Department, officers assigned to the Coast Artillery Board, officers assigned to the Coast Artillery School, officers assigned to the headquarters of each division or department in which coast artillery is located, and other officers and enlisted men designated as follows:

District Commander, Battle Commander, Fire Commander, Mine Commander, Battery Commander, Range Officer, Emplacement Officer, Communication Officer, Searchlight Officer, Property Officer, Mine-Field Officer. The duties of each will be found in the DEFINITIONS.

STAFF OFFICERS

For administrative purposes coast artillery officers are assigned to the following staff positions: At each headquarters of an artillery district, an Artillery District Adjutant, District Artillery Engineer, Artillery District Ordnance Officer, and Artillery District Quartermaster.

At coast artillery forts or posts the corresponding post staff officers are appointed. The duties of each will be found in the DEFINITIONS.

COAST ARTILLERY RESERVE OFFICERS

A coast artillery reserve officer assigned to any of the commands enumerated above, when taking part in drills or exercises at a coast artillery fort or post, or when mustered into the service of the United States, performs the same duties so far as compatible with those noted for regular officers, unless otherwise directed by competent authority.

If a regular and a reserve officer of equal rank are acting together, as contemplated in the preceding paragraph, the reserve officer would act as assistant to the regular officer. In cases where regular and reserve officers are assembled together on duty, reserve officers take precedence next after all regular officers of the same rank, irrespective of the seniority of such reserve officers.

COMMANDS APPROPRIATE TO GRADE

Colonels of coast artillery are usually assigned to staff duty at the War Department, on the Coast Artillery Board, as commandants of the Coast Artillery School, and as artillery district commanders.

Lieutenant-colonels as artillery district commanders, battle, fire, or mine commanders, and commanders of coast artillery forts or posts.

Majors as battle commanders, fire or mine commanders, and as commanders of coast artillery forts or posts.

Captains as battery commanders and in command of mine, gun, or mortar companies. Also as commanders of small coast artillery forts or posts.

Lieutenants as communication, searchlight, property, mine-field, casemate, range or emplacement officers; assigned to companies, or staff duty.

All field and line officers of coast artillery are subject to detail as staff officers or on special duty.

NON-COMMISSIONED OFFICERS, ETC.

In the Coast Artillery Corps the following non-commissioned officers and graded men are authorized:

Sergeant Major, Senior Grade; Sergeant Major, Junior Grade; First Sergeant; Quartermaster Sergeant; Sergeant; and Corporal.

In addition to the above the following ratings are authorized:

Master Electrician; Engineer; Electrician Sergeant, First Class; Electrician Sergeant, Second Class; Master Gunner; Fireman; Gunner, First Class; Gunner, Second Class; Gun Commander; Gun Pointer; Plotter; Observer, First Class; Observer, Second Class; Casemate Electrician; Chief Planter; Chief Loader. The duties of each will be found in the DEFINITIONS.

Other positions to which the enlisted personnel are detailed are as follows: Mechanic; Range-Setter; Meteorological Observer; Tide-Observer; Assistant Plotter; Range-correction Computer; Deflection-Computer; Primary Arm-Setter; Secondary Arm-Setter; Telautograph Operator; Telephone Operator; Range Keeper; Reader; Searchlight Operator; Searchlight Watcher; Wireless Operator; Recorder; Orderly; Musician; Cook.

Chiefs are assigned to the various sections, detachments and details shown in the drill regulations.

CHAPTER IV

GUNNERY AND BALLISTICS

IN this chapter it is intended to make the ballistic formulas which are necessary to the practical artilleryman less formidable than the term implies, with the hope that gunners will not instinctively avoid them. One need not be an expert mathematician in order to be a practical gunner and successfully apply ballistic formula.

As concerns the artilleryman, ballistics is divided into two classes: First, that which relates to the behavior of the projectile in the gun, known as "Interior Ballistics," and second, that which deals with the projectile's action in its flight through the air, called "Exterior Ballistics." It is believed that a comprehensive understanding will be had of each, if the explanation is preceded by a few words on gunnery, or the art and science of operating the guns to which both Interior and Exterior Ballistics are to be applied.

GUNNERY

The Gun.—A gun may be called the simplest form of gas engine. To move the projectile through the bore requires the expenditure of energy. The energy which produces the force to propel the projectile is heat, and the heat carrier is gaseous, hence the term "gas engine."

This machine or gun is made entirely of steel; its essential parts being a tube, jacket, breech-bushing, and the A, B, C and D rows of hoops. The number of hoops has been successively reduced and their length increased, as steel manufacturers have become able to make larger forgings; and this increase in the length of hoops has greatly augmented the efficiency of guns.

The tube is enveloped by a jacket and the several rows of hoops; it is inserted into the jacket from the breech end and a shoulder upon its exterior abuts against a corresponding one near the front end of the jacket. The outside diameter of the tube is successively reduced from the front end of the jacket, to the muzzle, by 6 shoulders. The jacket projects to the rear of the tube a sufficient distance to allow room for the

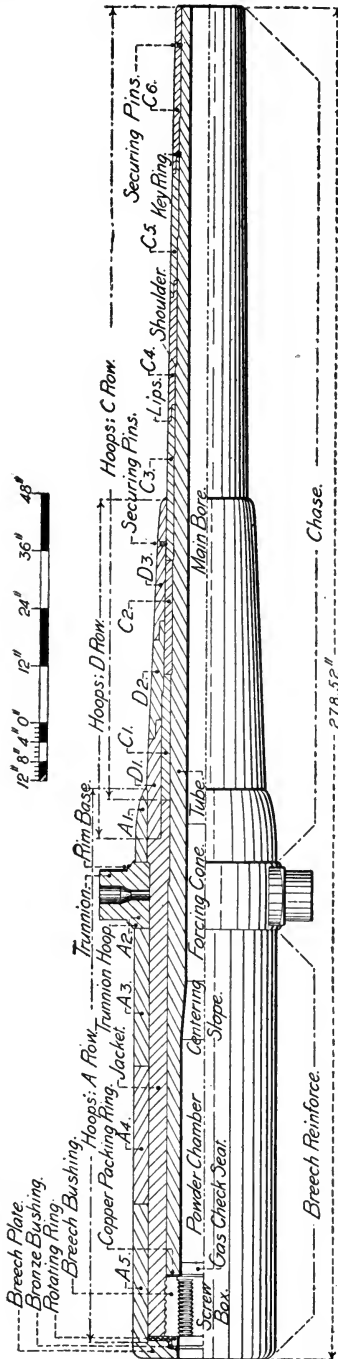

FIG. 1.

screw box, or breech recess. Figures 1, 2 and 3 illustrate the method of construction of seacoast cannon. The 8-inch gun, model 1888 (Fig. 1), is here used for purposes of demonstration, by reason of its being the first of the modern types of built-up gun construction. In this model the jacket and C-1 hoop, the C-1 and C-2 hoops, and the C-2 and C-3 hoops, are not directly locked together. The remaining C-hoops, three in number, are locked together with a lip on the forward hoop by overlapping a lip on the rear one, the contact surface of the rear one being a frustum of a cone, with the smaller base at the breech end.

In front of the C-5 hoop is a key ring, which being part in a groove of the tube and part in front of the hoop, prevents forward motion of any of the C-hoops in the rear. The C-6 hoop is fastened to the tube by three radial securing pins. Overlapping the front end of the jacket and covering the C-1, C-2 and part of the C-3 hoops, there are three D-hoops, locked together by lips similar to those on the C-hoops and having three radial securing pins passing into the D-3 and the C-3 hoops. Five A-hoops, the second of which is the trunnion hoop, cover the jacket and part of the D-1 hoop.

The trunnion hoop has the shock of discharge transmitted to it through a shoulder on the jacket. Into the portion of the jacket projecting beyond the breech and the tube is screwed the steel breech

bushing, which on its interior is threaded to receive the breechblock. The breech bushing is secured against unscrewing by four spline screws, halved into it and the jacket. A space of 0.05 inch is left between the breech of the tube and the breech bushing. At the interior of this

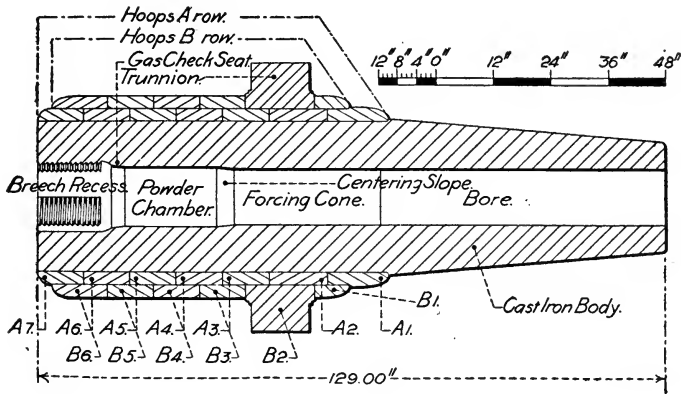

FIG. 2.

joint there is a copper ring, given a compression of 0.01 inch between the tube and bushing.

The trunnion band is also a hoop, by which connection is made with the carriage of the piece. The trunnions are the cylindrical arms supporting the piece when mounted.

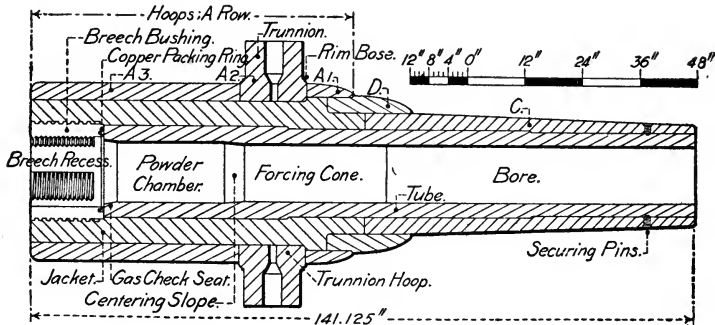

FIG. 3.

The rim bases are the shoulders uniting the trunnions with the trunnion band. The face of the trunnion and the face of the rim bases are their end surfaces. The section of the gun between the rear of the trunnion band and the breechplate is called the *breech reinforce*, while



the section between the front of the trunnion band and the front of the muzzle is called the *chase*.

The bore is the hollow portion in the center of the piece, and is subdivided into the following parts, commencing at the breech end of the tube: Gas check seat (conical), powder chamber (cylindrical), centering slope, forcing cone, shot chamber and the main bore. The centering slope is used for the purpose of bringing the axis of the projectile to coincide with the axis of the bore, the copper rotating band on the projectile also stopping it at its proper distance forward, by seating it in the slope. At the junction of this slope and the forcing cone the rifling commences, beginning flat and gradually increasing to its proper height and gauge. The tube is closed at the breech end of the gun by the breechblock.

THE BREECH MECHANISM

The breech mechanism of the gun considered consists of the breechblock, obturator, breechplate, rotating crank, tray latch, securing latch and hinge pin.

In studying the breech mechanism, probably the best method is to dismantle it. The illustration shown in Fig. 4 gives an excellent idea of the location of parts herein described, as well as an illustrated nomenclature of this model of breech. The principal parts of the breechblocks are 3 threaded sectors, 3 slotted sectors, 2 guide grooves, vent cover and translating stud. The block is threaded with a V thread with rounded top; the rear portion is left unthreaded to prevent the entrance of dust. The threaded portion is divided into 6 equal segments, 3 threaded and 3 slotted. The 2 guide grooves are cut in the bottom slotted sector 30 degrees each side of the element of the unlocked block; they fit upon, and pass over the rails of the console or tray when the block is drawn to the rear. In the model considered, two handles are cut out of the solid metal upon the rear end of the block, for use in case of failure of the mechanism.

The vent cover is a steel arm, mounted in a mortise in the block, and suspended on the vent-cover screw. By means of a shoulder in the bronze bushing, which is stationary in the breechplate, the vent cover is constrained to move when the block is rotated, so as to cover the vent, over which it remains until the block is returned to its locked position. The translating stud, attached to the rear face of the block, by a screw in a slotted seat, projects radially from the face of the block. When

the latter is rotated the 60 degrees necessary to unlock it the stud revolves into the groove in the translating roller.

The obturator consists of the mushroom head and stem, gas-check pad, front and rear exterior split rings, filling-in disk, obturator-spindle nut, locking-nut and the obturator-spindle washers. The vent is drilled through the spindle in front of which there is a copper bushing-plug forced into an undercut on the face of the mushroom head; in passing through this plug, the vent contracts from 0.2 to 0.1 inch, or one-tenth of an inch. This bushing may be replaced when badly eroded. The rear end of the vent channel (old model) is elongated and threaded for an obturating primer, used to ignite the charge.

The gas-check pad is made of asbestos and tallow, inclosed in a canvas cover.

The exterior split rings are of steel, split diagonally through one side. They are slightly larger than the conical seat and are sprung together in being forced into place.

The interior ring is of similar construction but slightly smaller than the spindle. The filling-in disk acts as a washer in the rear of the pad, a shoulder on its front face supports the interior edge of the rear split-ring, and a fillet on the rear face of the mushroom-head performs the same office for the front split-ring.

The obturator-spindle nut is screwed on the rear end of the stem with a right-hand thread; it draws the obturator head and gas check to a bearing against the face of the block; it abuts against the spindle washers, and has under its front edge a thin steel spring washer designed to keep out dust. In rear of the spindle nut is a locking nut, screwed on with a left-hand thread, designed to prevent the spindle from unscrewing.

The four obturator-spindle washers are alternately bronze and steel. The object of having one of bronze and one of steel is to reduce friction, taking advantage of the principle that metals of different kinds, bearing upon each other, have less friction than those of the same kind. They are assembled with a bronze washer in front, and the others alternately steel and bronze.

The breechplate is a steel casting attached to the breechface by 12 large screw bolts. Its function is to cover the rotating gears and connect the tray with the gun by means of the hinge pin. On it are mounted the rotating gears and their journals, the gear segment actuated by them, the bronze bushing seat of the gear segments, and the securing latch. On its rear face are the hinge-pin ears, and the rear-sight seat. The recess in its face acts as a catch for the tray latch.

The bronze bushing for the gear segment is permanently attached to the plate by 4 screw bolts in a recess in its front face. It supports the gear segment in rear and on its outer surface and is provided with oil channels in its face, to facilitate lubrication.

The rotating crank and gears are the means of unlocking the block. They consist of the gear segment, rotating pinion, the rotating crank and associate parts. The steel gear ring encircles the breechblock and is mounted in the bronze bushing; from this ring projects radially the gear segment of 70 degrees, in which gear teeth are cut.

The gear ring fits over the cylindrical portion of the block with a lug extending inward into the upper right-hand slotted sector prolonged to the rear to receive it. It acts as a key in this slot to cause the block to rotate. When the latter is withdrawn from the screw box, the slotted sector slides from under the lug.

The pinion is a small gear whose function is to rotate the gear segment into which it meshes. Its journal, mounted in a bronze sleeve seated in the upper part of the breechplate, extends to the rear beyond the face of the breechplate, and has the rotating crank mounted upon its square end, secured by a nut and stay pin. By it the pinion is turned, which rotates the gear segment, and in turn, the block. Over the two faces of the pinion there are oil holes, closed by screws, for the lubrication of the rotating gears.

There is a spring catch mounted in the face of the crank arm, by which the gear system is locked when the breech is closed and the block rotated to its firing position. This catch consists of a bolt, a spiral spring, a housing nut and a winged nut. The bolt is seated with its head projecting to the front, through the crank arm. Its forward end is beveled on one side, and squared on the other. It is held in bearing against its seat by a spiral spring on its back, compressed by the housing nut screwed over it. The rear end of the bolt is threaded and has a winged nut mounted upon it, having the projecting lug on one side. When the nut is revolved 180 degrees, so that the bolt presents its beveled side in the direction of rotation, the crank may be revolved, carrying the gear segment to either of its extreme positions. The handle of the rotating crank is covered with a loose sleeve to facilitate turning.

By the rotation of the block, the translating stud on the block is revolved into the thread of the translating roller, and the block is in position to be drawn directly to the rear of the breech recess onto the tray.

The tray or console is of bronze, mounted in the rear of the breech

and supported by a hinge pin on the right-hand side, the ears being cast in the breechplate. The parts are the tray proper, the translating roller and crank, the tray latch, and the catch for the securing latch.

The translating roller is seated in a right-hand thread in the upper surface of the body of the tray; it has two independent threads cut in opposite directions on its surface. The translating stud engages in the left-hand thread in the roller.

The translating crank is mounted on the squared end of the roller. The rotation of this crank causes the roller to screw in its right-hand thread, and hence, travel back in the tray, drawing the block with it. It also causes the translating stud, attached to the block, to travel as a nut in the left-hand thread. Thus a double motion of translation is given to the block, drawing it onto the tray by fewer revolutions of the crank than if either of the threads acted upon it singly. In the reverse motion, the tray latch serves to secure the tray to the face of the breech, while the block is translated into its seat in the screw box.

The tray latch is mounted in a longitudinal slot in the web on the under side of the tray, on a latch bolt. Its front end terminates in a hook lip which engages in a catch seat recessed in the breechplate. On its rear end is a transverse handle. A spring bolt mounted in the tray, above the latch, holds it so that it cannot be unlatched while its bolt is covered by the translating roller. When the latter is quickly withdrawn beyond it, the relation between the excess of weight in front of the latch journal and the tension of the bolt spring is such that the jar will unlatch it. The tray may then be swung about its hinge pin until caught by the securing latch, thus uncovering the screw box. The securing latch is mounted in a recess in the breechplate, through which its handle protrudes on the left, and its catch end on the right. Its pivot is a screw bolt passing through the lower hinge ear, hinge pin and breechplate. Its latch lip engages in a catch on the diagonal web of the tray. It may be released by lifting the handle, or pressing down the latch end.

The hinge pin is a cylindrical bar mounted in two ears on the side of the breechplate; it is lubricated from an oil hole in the upper hinge ear. It is entered from below and held in position by the same screw bolt upon which the securing latch is pivoted.

The type of gun construction described in this chapter is known as the "built-up" cannon, designed to utilize, to the best advantage, the elastic qualities of the metal. No portion of the bore of a gun should be strained, either at rest or during firing, beyond its elastic limit.

The elastic limit of a metal is that point beyond which, if it is strained either by extension or compression, a permanent set will take place. There is an elastic limit of compression, as well as extension, and if the metal is strained beyond either limit, permanent deformation will occur. If the strain is continued, a rupture will take place when the ultimate strain is exceeded. In a gun made of a single piece of homogeneous steel in its natural condition, with no initial compression or extension, the metal at the bore cannot be stretched by the expansion of the powder gases beyond the limit of elasticity for extension without a permanent "set" taking place. If, however, the gun of the same exterior dimensions be made of concentric tubes, properly assembled, so that the metal at the surface of the bore is contracted to its elastic limit for compression, this surface will, in firing, stand a corresponding stress necessary to stretch it back to the normal condition of the first cannon, and, therefore, it may be further strained so as to utilize the elastic qualities for extension. As the greatest strain is at the bore, this portion of the wall is compressed, when at rest, up to its elastic limit for compression, and it is extended, when under the stress of the powder gases, nearly or quite up to its elastic limit for extension. It is to obtain this greater tangential strength that modern cannon are built up in the manner just described. The tangential strength of a cannon is the resistance it offers to being torn apart in a plane parallel to its axis.

RIFLING AND ITS TWIST

In order to give elongated projectiles angular velocity of rotation, and thereby cause them to rotate around their longer axis, spiral grooves are cut in the bore of seacoast cannon. Attached to the base of projectiles is a soft copper band, which is forced into the grooves when the gun is fired. This band being rigidly attached to the projectile, the motion of rotation is transmitted to the projectile, and it turns around its longer axis as it moves through the bore. This rotation of the projectile around its longer axis gives greater accuracy of flight, by keeping the projectile tangent to the trajectory, thereby presenting the surface of least resistance to the air and thus giving greater range and penetrative power.

As stated in the DEFINITIONS, grooves are the spiral cuts made in the bore, and lands the spaces between two adjacent grooves.

Although a great factor in the accuracy of fire, rifling is also the source of weakness in guns, due to the erosive effect of the powder

gases on the bore at the junction of the lands and the grooves. Since first introduced into gun construction, the tendency has been to reduce the depth, and increase the number of grooves. In the United States coast artillery service, the number of grooves is usually 6 times the caliber, their width approximately thirty-seven one-hundredths of an inch, and their depth from six to seven one-hundredths of an inch.

The rifling commences at the junction of the centering slope with the forcing cone. The tops of the lands, at this point, are cut down so that less power is required at first to force them through the copper rotating band on the projectile. The twist of rifling, i. e., the inclination of the grooves to the axis of the bore at any point, increases from 1 turn in 50 calibers at its origin, to 1 turn in 25 calibers at a point several inches in rear of the muzzle, and retains this latter twist uniformly up to the muzzle. In other words, the projectile, at the start, would make one complete revolution around its longer axis in passing over a distance of 400 inches for an 8-inch rifle, 500 inches for a 10-inch rifle and 600 inches for a 12-inch rifle; its velocity of rotation gradually increasing as it passes through the bore until at a point near the muzzle its velocity is such that it would make one complete revolution in passing over a distance of 200 inches for an 8-inch rifle, 250 inches for a 10-inch rifle and 300 inches for a 12-inch rifle, or the projectile is turning twice as fast as at the start. The twist is then uniform to the muzzle in order to steady the projectile as it leaves the gun.

When the inclination of the grooves is constant, the twist is said to be uniform. When it increases gradually from the breech towards the muzzle, the twist is said to be increasing. In the United States service, the rifling of seacoast guns and mortars is increasing—for the guns—from 1 turn in 50 calibers at the breech, to 1 turn in 25 calibers at a distance of about 2 calibers from the muzzle, from which point to the muzzle it is uniform; for mortars, from 1 turn in 40 or 42 calibers, to 1 turn in 20 or 25 calibers.

With rapid-fire guns, the twist is different in most cases. In the 6-pounder (Driggs-Seabury and Driggs-Schroeder) the twist is from 0 to 1 in 26 calibers. In the 4-inch (Driggs-Schroeder), and the 6-inch rifle, model of 1905, it is practically the same. The twist in the 4.72-inch Armstrong, 40 caliber, is from 1 in 100 to 1 in 34 calibers, and the same gun, 50 calibers long, has a twist of rifling from 1 in 600 to 1 in 30 calibers.

The necessity for the increasing twist of rifling will be readily understood when it is considered that as the projectile starts from its seat, on the first part of its travel through the bore, the pressure of the

powder gases rise to a maximum, and the angular velocity is impressed upon the projectile at this point also. It is necessary, therefore, that the least resistance to starting be offered by the projectile at this point. With an increasing twist, the projectile takes the grooves gradually, and the strain on the gun is not very great. With uniform rifling, the gun would be submitted to the greatest pressure due to the starting, and at the same time would be subjected to the greatest pressure due to the rotation of the projectile, which would unnecessarily strain the gun. As the projectile moves along the bore, the pressure of the powder gases falls off while the twist is gradually increasing until it reaches the final value necessary to impart the desired angular velocity to the projectile. The pressures are thus more uniformly distributed along the bore and the gun strained less at the start, while the final velocity of rotation is as great as if the rifling had been uniform.

THE PROJECTILE IN THE GUN

Explosion, the principle of propulsion employed in modern artillery, is simply the expansion of gases released by the decomposition of chemical substances. The gases thus liberated exert an equal pressure at all points on the surfaces which they touch. The propulsive energy of these forces is controlled and regulated by the mechanism of the gun, and absolute precision in their use is the first condition both of safety and efficiency.

The potential energy stored up in a pound of powder, when expanding to infinity, is capable of doing 576 foot-tons of work. In the bore of the gun the space in which gases are free to expand is limited, and the gases from a pound of powder expanding to the volume of the bore do approximately only 75 foot-tons of work. This therefore is the usual energy available to do the total work in the gun. The other 501 foot-tons of energy cannot be utilized because of the limited length and diameter of the bore. Again, a considerable portion of the total work in the gun is lost in heating the gun; expanding the walls of the gun; driving the column of air in front of the projectile out; driving out the products of combustion, deforming the rotating band; overcoming the friction in the bore; giving rotation to the projectile, and finally, accelerating the projectile, that is, gradually increasing its velocity from rest until it attains its final initial velocity at the muzzle with which the projectile starts in its path through the air.

As the principal object is to give acceleration to the projectile it is important to know how much of the total work in the gun can be

utilized for this purpose. The ratio of the useful work to the total energy of the powder is called the "coefficient of useful effect," or the "coefficient of efficiency," and has been shown by experiment to be between 80 and 90 per cent. of the total work in the gun. If a charge of powder is burned in a rigid space, that is, one that has a fixed capacity, the expansive force of the gas will at any instant depend upon the amount of gas that has been formed and its mean temperature. As the amount of gas and its temperature increase the expansive force will increase. If at any instant the space in which the powder is burning be increased, the other conditions remaining the same, the expansive force will decrease. In a gun, the space in which the powder is burning has a fixed capacity until the projectile starts to move, after which the space increases. The pressure on the walls of the gun and on the base of the projectile at any instant depends upon the expansive force of the gas at that instant, as well as the increase of expansive force due to an increase of the amount of powder burned, or to temperature. If this is greater than the decrease of expansive force due to increase in the space it occupies, the pressure on the walls of the gun and on the base of the projectile is increasing. When the decrease, due to the increase in the space, is greater than the increase due to the amount of powder burned, or to temperature, the pressure falls off.

Theoretically, the last atom of powder should be converted into gas as the projectile leaves the bore. The more gradually the projectile is evolved, the less the strain on the gun; but the greater must be the length of the bore in order that all the power-charge may be converted into gas before the projectile leaves the bore.

What happens in a gun is this: The explosion of the powder-charge gives rise to a large amount of gas, which expands, and the pressure from the same acting on the base of the projectile starts the projectile to move in the bore of the gun. The pressure increases up to a certain amount and as the space in which the powder charge is burning is increasing as the projectile moves through the bore, the pressure commences to fall off. The greatest pressure acting on the base of the projectile is called the maximum pressure, and this is the pressure indicated by the crusher gauge. For any gun, the maximum pressure must not be exceeded.

The form and size of the powder grain should be so regulated as to produce the greatest possible initial velocity with a maximum pressure not exceeding that which is allowed for the gun. It is sufficient to say that within certain limits, the larger the grain, the less will be the initial burning surface per pound of powder, and the less will be the

maximum amount of pressure produced for a given charge of powder. Due to this fact, the larger the grain, the larger the charge of powder that can be used, as a rule, and therefore a greater muzzle velocity. As the size of the grain is increased the percentage of the grain which will be consumed while the projectile is in the bore is decreased, leaving a certain portion of each grain unburned when the projectile leaves the muzzle. For this reason, the size of the powder grain can be increased within certain limits only. When the point is reached at which the weight of the unburned powder will equal the additional amount of powder which has been put in the chamber, no further increase of velocity can be obtained. If we continue to increase the size of the grain without increasing the charge the velocity will fall off.

For each class of gun, therefore, there is a limit to the size of grain, which must not be exceeded. There is also a limit in the opposite direction and it is possible to produce dangerous pressures in a gun by using a small charge of powder where the grain is too small for the gun in question. For this reason, powder should not be used in a gun for which it is not designed, or it should be used in a gun of smaller caliber than that for which it is designed, and never for one of larger caliber. The rate at which gas is emitted from a burning grain is dependent upon its rate of burning, and the area of the burning surface.

The ratio of burning increases with the pressure and also with the temperature of the inflamed gases. The larger the grain, the less will be the area of burning surface, per pound of powder, and the slower will be the rate of emission of gas for the same rate of burning. For every grain of powder, no matter what form, there is always one dimension, which, when burned through, the entire grain is consumed. This dimension is known as the "least dimension," and is sometimes called the "critical dimension" of the grain. In the multi-perforated grain,—the kind used with modern seacoast guns,—or with smokeless powder, the critical dimension is the thickness of the web between the perforations. For example: If two tubular grains are the same length, one of them one-half inch in diameter and the other one inch in diameter, both having the same thickness of wall (one eighth-inch) it is manifest that as soon as the wall is burned through both grains will have been consumed. The grain which is one inch in diameter would weigh about twice as much as the other, and twice the amount of gas would be evolved. For similar guns, the critical dimension of the grain should be in proportion to the caliber of the gun.

When a grain is said to be too large or too small for a gun, too quick or too slow for a gun, it is the critical dimension that is referred

to. The denser the powder, the slower will be the combustion. An extremely hard and very smooth grain is difficult to ignite. Uniformity of action of powder is dependent upon the ignition and inflammation of the charge. By ignition is meant setting fire to the charge, and by inflammation is meant the spread of the fire from grain to grain over the surface and into the perforations of the several grains. It is desirable to produce as nearly as possible a simultaneous ignition of the entire charge in order to eliminate the variation in the rate of emission of gas, due to an irregular spread of inflammation from grain to grain. A charge composed of large grains inflames quicker than one composed of small grains; this is due to the larger opening between the grains. A grain with large or multi-perforations inflames more readily than one with small perforations. The longer the grain, the slower will be the inflammation with the same-sized perforations. Black powder ignites very readily, which is just the opposite of the smokeless powder, which is now the standard powder and which requires a large amount of flame to insure instantaneous ignition. For this reason an igniting charge of black powder is put in the base of each section of the charge of smokeless powder used in large caliber guns.

From what has been said, it can readily be seen that a charge composed of large grains will burn more slowly and exert less strain on the gun than one composed of small grains. Hence the danger of using the same weight of charge of black powder in place of that of smokeless powder or powder of large grains, is obvious.

The glazing of gunpowder, which smooths and hardens the surface of the grain, is done to retard the ignition and make it a slower-acting powder. Moisture in powder also reduces the rate of burning and consequently, the velocity and pressure. Uniformity in size, shape, density, surface smoothness, and toughness of the grain are essential in order to obtain uniform results of velocity. The maximum pressure and muzzle velocity are also affected by the density of loading, which is fully defined in the DEFINITIONS.

It is important that the projectile should always be seated so that its base will be at the same distance from the face of the breech, in order that the volume of the powder chamber will be more nearly constant for each charge. The smaller the space the higher will be the initial velocity and the greater the pressure. Again, it is important that the powder charge for each round fired should be the same length. The length of the cartridge for any powder chamber should not be less than nine-tenths (9-10) the length of the chamber. This is necessary in order to eliminate what is known as wave motion. It has been

found by experiment that if a cartridge is much shorter than the powder chamber, it is liable to produce a motion of air in the gases formed in the chamber which greatly increases the maximum pressure on the breech. It has been found that in long chambers wherein simultaneous ignition and inflammation is difficult, wave motion is more apt to occur, in which cases abnormally high local pressures have been produced. It is in order to contain the required amount of powder without giving the chamber undue length that in modern construction the powder chamber of the guns have been given greater diameter than that of the main bore.

The causes affecting the velocity and pressure may be summarized as follows: *First*, the size, shape, density, surface smoothness, and toughness of the grain. *Second*, the length of the bore and the construction of the gun. *Third*, the increase or decrease of the weight of the charge. *Fourth*, the density of loading.

THE PROJECTILE IN ITS FLIGHT, OR THE TRAJECTORY

The projectile in flight will be considered, for convenience of explanation: first, in the plane of departure, ignoring deviating effects; second, the entire trajectory, including the effects of wind and drift.

The projectile in its flight is influenced by: 1. The expansive force of the powder gases which gives it the initial velocity of translation. 2. The force of gravity. 3. The resistance of the air. These forces determine its trajectory.

The weight and dimension of the projectile as well as the shape of its head also affect the path of its flight, but only because they act upon the retardation of the projectile due to the resistance of the air.

Under the influence of the expansive force of the powder gas the projectile would move with uniform velocity in a straight line or in continuation of the axis of the bore.

The actual velocity of the projectile as it leaves the muzzle of the gun is difficult to determine. It is, however, usually measured by means of an instrument called the chronograph, at some point a short distance from the muzzle. The velocity thus obtained is called instrumental velocity at the point measured from the muzzle. By means of ballistic formula this instrumental velocity may be reduced to what it would be, under the laws of resistance, at the muzzle. The velocity thus calculated is called "muzzle velocity," as it is assumed to be the initial velocity of the projectile in the trajectory. In other words it is the velocity, which under the laws of resistance of the

atmosphere when computed with ballistic formula, would give the projectile a velocity equal to the instrumental velocity at the point measured by the chronograph.

If the gun were fired where there is no resistance to the air, or in vacuo, and leaving out of consideration the effect of gravity, the projectile would move in a straight line with uniform velocity and would pass through equal distances for each second of its flight. For example,

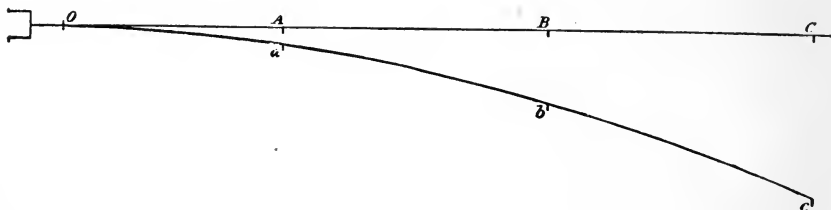

FIG. 5.

if a projectile had an initial velocity of 2,000 feet per second, it would pass through 2,000 feet during each second of its flight, or referring to diagram (Fig. 5) it would pass in each second over OA, AB, BC, these distances being equal in each case.

If the same gun were fired in air, horizontally, without considering the action of gravity, it would move in the same straight line, but the distance passed over during each successive second of its flight would

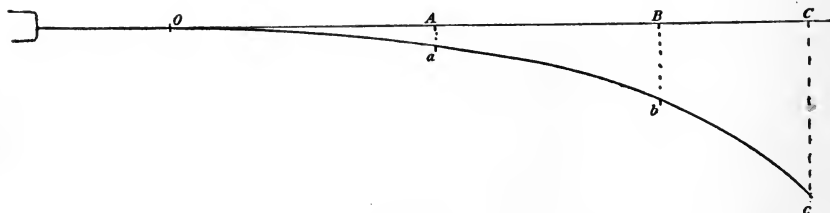

FIG. 6.

gradually decrease, that is, the projectile would lose velocity in consequence of the resistance of the air. In such a case the distance passed over during each second of its flight would be, referring to Fig. 6, the distances OA, AB, BC.

Under the influence of gravity alone the space through which the projectile will fall in vacuo is determined by the simple formula: Space (S) in feet equals one-half of the acceleration of gravity (g), mean value 32.16 feet per second, times, seconds squared (t^2), or in

Referring to figures 7, 8 and 9 it is evident that a gun may be fired so as to produce trajectories similar to those illustrated, that is: *First*, the trajectory which is entirely above the horizontal plane, or where the target is above the level of the horizontal plane, passing through the muzzle; *second*, where the target is on a level with the plane, passing through the muzzle, and *third*, where the target is below the horizontal plane, passing through the muzzle, which is the usual trajectory found in practice.

In order that the terms may be thoroughly understood, the different elements of the trajectory are indicated.

The horizontal trajectory is the one considered in all fundamental ballistic computations. It is very seldom, in actual practice, that the target is in the initial plane; therefore, the trajectory most commonly found in practice is the trajectory described where the target is below the horizontal plane passing through the axis of the gun. It is there-

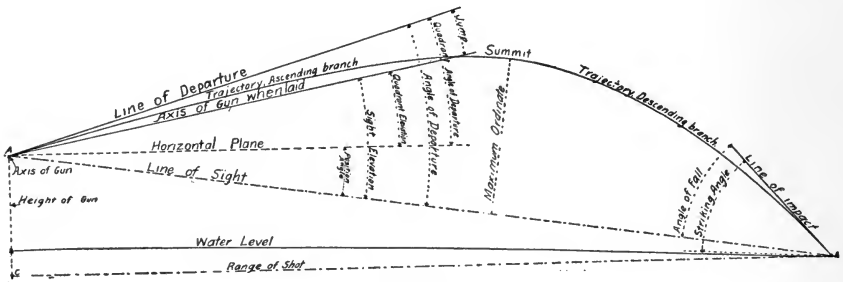

FIG. 9.

fore evident that some means of applying the computations for the horizontal trajectory, or the values given in the range table, must be devised to apply to the trajectory in the three cases heretofore mentioned. This is accomplished by a method known as the principle of rigidity of the trajectory, which may be defined as follows: The principle of the rigidity of the trajectory assumes that the relations existing between the elements of the trajectory and the chord representing the range are sensibly the same, whether the latter be horizontal or inclined to the horizon.

The acceptance of this principle assumes that knowing the angle of departure necessary to hit a certain point at a horizontal range "X" from the gun and on the same level, the angle of departure necessary to hit a certain point "h" feet below the level of the gun would be obtained by subtracting the value of the position angle from the angle of departure of the horizontal trajectory.

Likewise if the target is above the level of the gun the position angle would be added to the angle of departure of the horizontal trajectory. Both of these are shown graphically in Figs. 7 and 9.

The power of a projectile to overcome the resistance of the air is dependent upon its weight, dimensions, and shape of its head. It is a well-known fact that given two balls, one a baseball, and one a light hollow rubber ball of the same size, the heavy ball can be thrown further than the light ball. This is because its greater weight gives it more power to overcome the resistance of the air. If the two balls were of the same weight, one being larger than the other, the larger ball would meet with more resistance than the smaller one because there would be more surface exposed to the resistance of the air. Applying this principle to ballistics, a number is given, known as the ballistic coefficient, which expresses the power of a projectile to overcome the

resistance of the air. It is expressed by $C = f \frac{\delta_1 w}{\delta c d^2}$ in which delta sub one is the standard density of the air; delta, the density of the air when firing; w , the weight of the projectile in pounds; c , the coefficient of reduction, depending for its value upon the smoothness of the projectile and its steadiness in flight; and d , the diameter of the projectile in inches; f is known as the altitude factor. Two other factors are frequently introduced into the equation in order to account for the increased wind effect on the projectile as it rises, indicated by the symbol f_w and may be either negative or positive depending upon whether a rear or head wind component is considered. The other factor is known as the reducing factor, which takes into account the oblique presentation of the projectile to the resistance of the air; this factor is expressed by the Greek letter "gamma" (γ) and its value is based upon experimental firings. The complete coefficient then becomes $C = \frac{\delta_1}{\delta} \cdot f_a \cdot f_w \cdot \frac{w}{c \gamma d^2}$.

For similar projectiles, that is, projectiles which have proportional dimensions and the same shape head, the ballistic coefficient is directly proportional to the weight of the projectile and inversely proportional to the area of cross-section, or is proportional to the square of the diameter; that is, $C = W$, divided by D squared.

It is a well-known fact that a long-tapered tool can be forced into a resisting medium more readily than one having a shorter taper; that is, the sharper the instrument, the less power it requires to force it through the medium. This same principle is true of projectiles passing through the air—the longer the taper of the head, the less power required to force it through the air, because the area exposed to the resistance of

the air is less. We may, therefore, consider that the sharpening of the head of a projectile increases its power to force its way through the air, which is equivalent to increasing its weight.

The coefficient of form, represented by "*c*," is usually taken as unity, and depends for its value upon the results of experimental firings.

Should a projectile not keep its head on in flight, the value "*c*" would necessarily be greatly increased above unity, and therefore, decrease the ballistic coefficient, or decrease the projectile's power to overcome the resistance of the air.

Considering now the deviating effects upon a projectile in its flight, which are those due to drift and wind, we find that the path of the projectile, instead of being as shown in Fig. 6, or lying in the vertical plane of departure, describes a curve of double curvature, the horizontal projection of which is shown in plan in Fig. 10. The only case in which the projectile would remain in the plane of departure is when the wind exactly equaled the deviating effect, due to drift. The first deviating

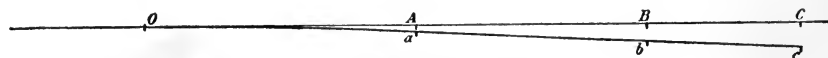

Horizontal projection.

FIG. 10.

effect, or that of drift, is due to rifling of the gun, which causes the projectile upon leaving the muzzle, to drift to the right for guns with the twist of rifling to the right.

The wind has considerable effect upon the flight of projectiles. In the United States coast artillery service it may be designated in two ways: *First*, by its azimuth, and *second*, by what is known as the "clock convention." That is, a wind blowing from the west is said to have an azimuth of 90 degrees; a north wind, an azimuth of 180 degrees. The clock convention refers the wind to the line of direction; that is, the observer is supposed to be at the center of a clock dial, the figure 12 pointing towards the target. A head wind is known as a 12-o'clock wind; a rear wind, as a 6-o'clock wind; a wind directly from the right, as a 3-o'clock wind; and a wind from the left, as a 9-o'clock wind, and so on, the entire circle being divided into 12 sections, following the known figures of the clock dial. The direction of the wind as sent to each primary station is given in azimuth by means of the aëroscope.

The effect of the wind upon a projectile is directly proportional to the wind velocity; that is, if a one-mile wind will shorten the range

5 yards, a ten-mile wind will shorten it ten times as much, or 50 yards. Again, if a one-mile wind will cause the projectile to deviate 3 yards to the right or left, a ten-mile wind will cause the same projectile to deviate approximately 30 yards. The effect of a head or retarding wind is to shorten the range. A wind blowing in the direction of the range, that is, a 6-o'clock wind, would tend to increase the range. A 3-o'clock wind would cause the projectile to deviate to the left, and a 9-o'clock wind to deviate to the right. A wind blowing from any other direction than those stated would cause a change in range and deviation. In such cases, it is necessary to determine the component of the wind's velocity which affects the range, and also the component which would cause it to deviate. The component which affects the range and which is parallel to the line of direction, is called the range component; while that component which acts at right angles to the line of direction is known as the deviating component. The range component of a 1 o'clock wind, for example, is 87 per cent. of the wind's velocity; the deviating component is 50 per cent. of the wind's velocity. That is, if a wind had a velocity of 20 miles per hour, its range component would be 17 miles per hour and its deviating component would be 10 miles per hour. The velocity of the wind is determined by an instrument called the anemometer.

AIMING AND LAYING

In order to give a gun the direction and elevation necessary to hit the target, it must be properly aimed, or laid to the data previously determined by the methods hereafter outlined. The term "aiming" will be employed when using the sights, and "laying" when the gun is given direction by means of the azimuth circle, and elevation by means of the elevation scale or quadrant. The three cases of pointing are as follows:

Case I.—When direction and elevation are both given by the sight. In this case the sight is placed on the gun trunnions.

This method is used only with rapid-fire guns not provided with quadrant-range scales. In using the sight the gun pointer for the first shot sets the elevation scale to the deflection ordered. He observes the splash caused by the shot and corrects the deflection for the next shot. This is done by keeping the vertical hair on the designated point on the target by traversing the carriage until the shot strikes and then bisecting the splash with the vertical hair by turning the deflection screw. The difference between the readings of the deflection scale after bisecting

on the splash and the original reading then gives the error made, and the setting in deflection should be corrected accordingly. The vertical wire is then brought back to the target by traversing the carriage.

Case II.—When direction is given by the sight and elevation by the range scale on the carriage.

The sight in this case is placed upon the bracket on the sight standard. It is the normal method used with guns of the primary and usually intermediate armament. Corrected ranges are sent to the guns for the next bell every fifteen seconds and the range scale set accordingly by the range setter. The gun pointer keeps the sight set at the deflection received from the plotting room until after the first shot, and traverses or directs the traversing so as to keep the vertical wire on the target. With the disappearing carriage the traversing is stopped long enough for the projectile to be put in the gun. The gun pointer fires or gives the command "fire," and then observes the fall of his shot and corrects the deflection as previously explained, unless otherwise ordered by the battery commander.

Case III.—When direction is given by laying the gun in azimuth by the azimuth circle, and the elevation by quadrant or range scale on the carriage.

This case is used for mortars, and for guns when conditions are such as to prevent the using of Case II.

ACCURACY OF FIRE AND PRACTICE

Accuracy of fire depends upon: 1. The accuracy of the gun. 2. The uniform action of the carriage during recoil. 3. The uniform action of the powder. 4. The uniform weight of the projectile. 5. The uniformity of loading.

Accuracy of practice depends upon: The accurate working of the personnel: (a) Correct location of the target. (b) Accuracy of corrections for wind, drift, travel of target and conditions of the atmosphere, etc. (c) Accuracy of the gun pointer and range setter. (d) Correct judgment upon observation of fire.

From the above it is readily seen that the "accuracy of fire" is measured by the mean distance of the points of impact of all the shots in a group from the center of impact, or the center of the points of impact of the group of shots, while the "accuracy of practice" is measured by the distance of the center of impact from the center of the target. For example:

Five shots are fired at a fixed target at a range of 7,000 yards. The shots all fall within a rectangle 10 yards long and 5 yards wide, and the average distance of the five shots from the target is 200 yards short and 5 yards right.

The accuracy of fire was excellent, but the accuracy of practice very poor.

Ballistic Symbols and Simple Formulas.

f. s. stands for "foot-seconds," which is the unit of measure for velocities. For example: 32.16 *f. s.* is read 32.16 foot-seconds, and means that the body considered is moving at the rate of 32.16 feet per second.

w (small *w*) means "weight," and in ballistic formulas stands for the weight of the projectile in pounds.

d (small *d*) means "diameter," and in ballistic formulas stands for the diameter or caliber of the projectile in inches.

δ_1 (delta sub one) stands for the density of the air two-thirds saturated with moisture, at standard temperature and barometric pressure, usually taken at 60° F. and barometer 30 inches.

F written after figures denoting temperature means "*Fahrenheit*," which is the name given to the kind of thermometer in common use in this country. 60° F. therefore is read sixty degrees Fahrenheit.

δ (delta) stands for the density of air, two-thirds saturated with moisture, for the readings of the thermometer and barometer taken at the time of firing the particular shot under consideration.

$\frac{\delta_1}{\delta}$ is read *delta sub one divided by delta*, and means the density of standard air divided by the density of air at the time of firing the shot.

A *coefficient* is a number written before any symbol to indicate how many times the symbol is to be taken. Thus, $2g$ means twice gravity, or $2 \times 32.16 = 64.32$.

c (small *c*) in ballistic formulas is called the "*Coefficient of Reduction or Form*." It is introduced in order to convert the result obtained for a projectile of a particular form to that for a projectile of some other form and is determined by experiment.

C (large *C*) in ballistic formulas is called the "*Ballistic Coefficient*." It depends upon the density of the air and the weight, diameter, and form of the projectile, and might be written $\frac{\delta_1}{\delta} \frac{w}{cd^2}$ (omitting reference

to altitude, wind and reducing factors). This last expression is read, *delta sub one divided by delta, multiplied by w divided by cd^2 , which means density of standard air divided by density of the air at the time of firing, multiplied by the weight of the projectile in pounds divided by the coefficient of reduction multiplied by the square of the diameter of the projectile in inches.*

V (large V) stands for muzzle velocity. That is, the number of feet per second at which the projectile is moving when it leaves the muzzle.

v (small v) stands for the velocity in f. s. of the projectile at any point of its trajectory.

v_ω (v sub omega) stands for the velocity in f. s. at the point of fall.

v_0 (v sub zero) stands for the velocity in f. s. at the summit of the trajectory.

ϕ (phi) stands for the angle of departure of the projectile.

θ (theta) stands for the angle which the tangent to the trajectory at any point makes with the horizontal. In the ascending branch this angle will always open outward from the gun, and will therefore be regarded as positive. At the summit of the trajectory the tangent will be horizontal, and *theta* will therefore become zero. In the descending branch the angle will open inward, that is, towards the gun, and will therefore be regarded as negative.

ω (omega) represents the angle of fall, that is, the angle at which the projectile strikes the horizontal plane passing through the muzzle of the gun. The angle of fall (ω) is always greater than the angle of departure (ϕ).

x (small x) represents the horizontal distance from the muzzle to any point within the range of the projectile.

y (small y) represents the height of the projectile above the horizontal plane passing through the muzzle of the piece at any point of the trajectory.

x and y are called the co-ordinates of any point of the trajectory, x representing the horizontal distance of the point from the muzzle of the piece, and y its vertical distance above the horizontal plane passing through the muzzle. x is known as the *abscissa* of the point, and y as the *ordinate*. Taken together they are called the *coördinates* of the point.

X (large X) represents the horizontal range, that is, the distance from the muzzle to the point where the projectile first grazes the horizontal plane passing through the muzzle.

T (large T) represents the time of flight in seconds, that is, the time it takes the projectile to travel from the muzzle to the point where it first grazes the horizontal plane passing through the muzzle. It is the " T " for the range X .

t (small t) represents the time of flight to any point within the range of the projectile. It is the " t " for the range x .

E (large E) stands for the energy of the projectile in foot-tons. It is equal to the weight of the projectile in pounds multiplied by the square of its velocity and divided by 4480 times gravity. The equation

$$\text{being } E = \frac{wv^2}{4480g} \text{ foot-tons.}$$

π (π) represents the ratio between the diameter and the circumference of a circle. It is equal to 3.1416.

e (small e) represents the energy of a projectile per inch of circumference. It sometimes appears in problems of penetration. The equation is $e = \frac{wv^2}{4480\pi dg}$ foot-tons, which may be thus interpreted:

Energy per inch of circumference equal to weight of projectile \times square of its velocity, and divided by $4480 \times 3.1416 \times$ diameter of projectile $\times 32.16$.

W (large W) stands for the velocity of the wind in f. s.

W_x (read W sub x) represents the velocity of the wind parallel to the range.

W_y (read W sub y) represents the velocity of the wind normal, that is, at right angles to the range.

u (small u) represents the horizontal progress of the projectile in f. s.

ρ (ρ) represents the resistance of the air to the motion of the projectile in pounds.

τ (τ) stands for the thickness of armor in inches.

f_a (small f sub a) represents the altitude factor and depends for its value upon the height the projectile rises above the level of the gun.

f_w (small f sub w) represents the wind factor and takes in to consideration the effect of the wind on the projectile as it rises.

y_0 (small y sub zero) represents the maximum ordinate or height in feet to summit of trajectory.

Z , A , $\text{Log } B'$, T' and $\text{Log } C'$ are functions from Table II, Artillery Circular M.

FORMULAS

For use with Table II, Artillery Circular M.

$$C = \frac{\delta_1}{\delta} \cdot f_a \cdot f_w \cdot \frac{w}{c\gamma d^2};$$

$$f_a = 1 + .000020y_0;$$

$$f_w = 1 \pm \frac{2W_x T^{5/4}}{X};$$

$$Z = \frac{X}{C};$$

$$\sin 2\phi = AC;$$

$$u = v_w \cos w \sec \phi;$$

$$A = a'_0;$$

$$x_0 = Cz_0;$$

$$y_0 = a''_0 C \tan \phi;$$

$$\tan \omega = B' \tan \phi;$$

$$T = CT' \sec \phi;$$

$$v_w = \frac{u \cos \phi}{\cos w} = u \cos \phi \sec w;$$

$$E = \frac{1}{2}MV^2 = \frac{wv^2}{4480g}.$$

For a given weight of charge the velocity increases slightly with the temperature of the powder at the instant of firing, and for a given increase of temperature this increase in velocity varies with the initial velocity.

For all lots of powder tested recently the charges have been adjusted to give the prescribed velocities when fired at the standard temperature of 70°. In the earlier tests only the temperature of the air was recorded, and for these lots but slight error will result from taking this as the temperature of the powder.

According to the data available at present, the following table gives the corrections for temperature.

Temp., Degr. F.	Normal Initial Velocities.												
	833	917	980	1056	1148	1220	2000	2100	2150	2200	2250	2400	2600
10	27	30	32	34	38	40	65	67	69	71	72	77	84
0	26	29	31	33	37	39	63	66	67	69	70	75	81
10	25	28	29	31	35	37	60	62	64	66	67	71	77
20	23	26	27	29	32	34	55	58	59	61	62	66	71
30	20	23	24	25	29	30	49	51	53	54	55	59	64
40	17	19	20	21	24	25	41	43	44	46	46	49	53
50	13	14	15	16	18	19	30	32	33	34	34	36	39
60	7	8	8	9	10	10	17	18	18	19	19	20	22
70	0	0	0	0	0	0	0	0	0	0	0	0	0
80	9	9	10	11	12	13	21	22	22	23	24	26	28
90	19	21	22	24	26	28	46	48	50	50	52	56	60
100	32	35	37	41	44	47	77	81	82	84	87	92	100

To be deducted from normal initial velocity.

To be added to normal initial velocity.

NOTE—This table applies to lots tested at a temperature of 70°.

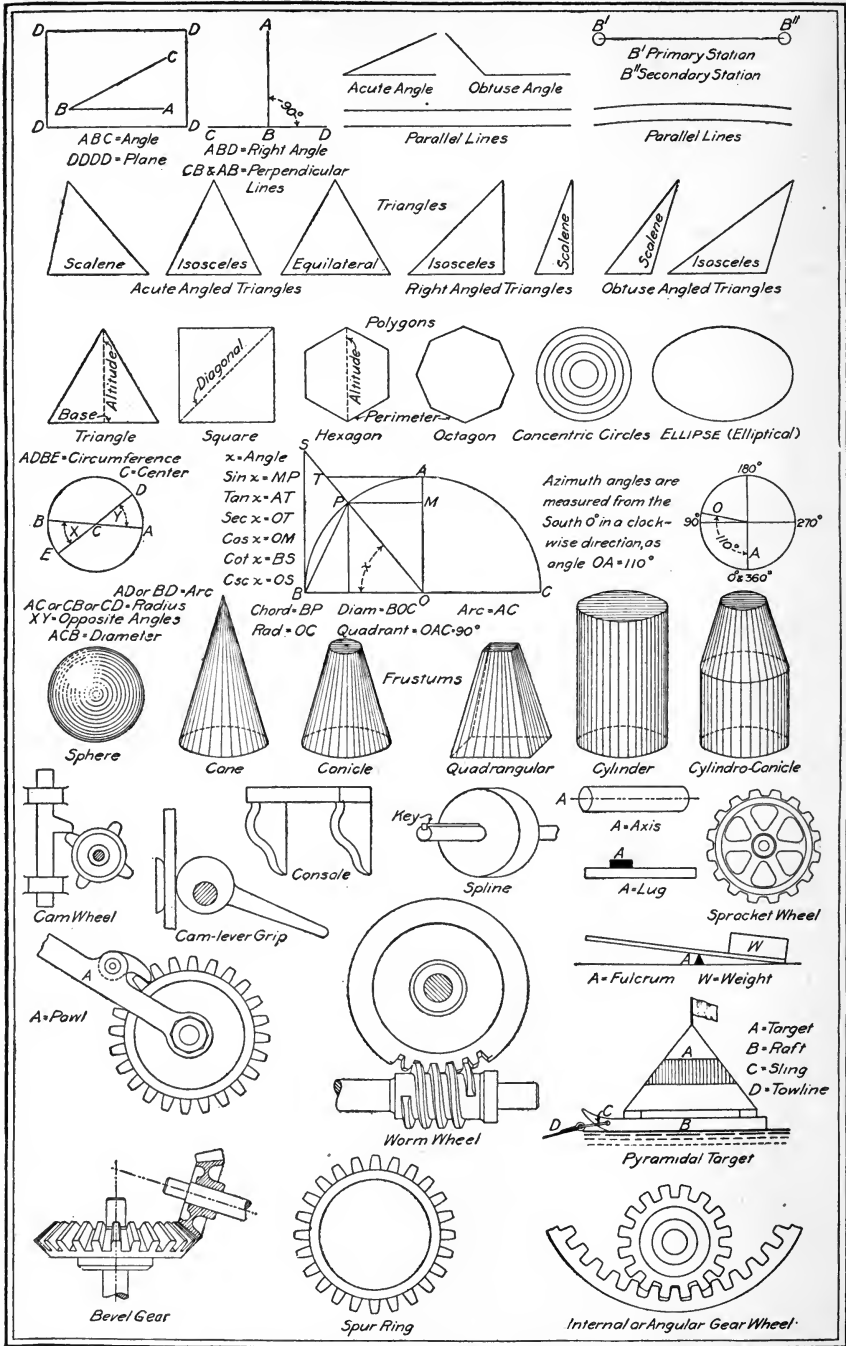

FIG. 10a.—Geometrical Magnitudes, Etc.

CHAPTER V

ARMAMENT

THE seacoast armament of the United States is a development of the last twenty-five years. The construction of the first type of 8-inch breech-loading rifle for coast defense purposes was undertaken in 1883 and completed at the West Point foundry three years later. In 1888 Congress began making appropriations for seacoast armament and has continued the policy ever since. The present system of coast defense is the result.

All the large-caliber guns now mounted have been designed, manufactured and mounted since 1888. In fact, it was not until 1895 that the modern material began to be turned over to the coast artillery, and the greater part of the present armament has been installed since 1897.

The United States has been, until recently, wedded to built-up gun construction of steel forgings. Of late, however, the Ordnance Department has taken up the manufacture of the wire-wound type of built-up gun and is at present manufacturing a 14-inch rifle of that type.

Designs of a 6-inch wire-wrapped rifle and a new design of 12-inch wire-wrapped mortar were recently completed. In the case of the mortar the employment of the wire wrapping is said to decrease the weight by something like 30 per cent; while the cost is greatly reduced by the fact that the cost of the wire per pound is less than one-half that of steel forgings which it replaces. The new mortars have a breech mechanism similar to that of the later seacoast rifles, which will greatly increase the rapidity of loading.

The disappearing carriage system was adopted by the Endicott Board in 1886, after exhaustive inquiry and careful consideration by the officers who composed it. It was later accepted by the joint committee of Congress that had the general subject of coast defense in charge. The disappearing system has always challenged that of the barbette on two important points: First, that of the protection afforded the gun, its carriage and personnel. Second, inability to discover the position of batteries until they open fire. While the disappearing sys-

tem has these advantages, its cost is greatly in excess of that of the barbette system, to say nothing of the difference in the care and attention required by the two types.

COAST ARTILLERY ARMAMENT

Coast artillery armament is classified as PRIMARY, INTERMEDIATE, and SECONDARY.

PRIMARY ARMAMENT

16-INCH BREECH-LOADING RIFLE, MODEL OF 1895

The general drawing, Fig. 1, indicates the method of construction. A series of this type of gun was recommended by the Endicott Board for the defense of the harbors of New York, San Francisco, Boston and Hampton Roads. In point of energy and range it is the largest gun in the world.

It is of the built-up forged-steel type and consists of a tube, jacket, 2 C hoops, 3 B hoops, 1 D hoop, trunnion band or hoop, trunnion rim-bases, breech plate, breech-block, breech bushing, screw box, copper rotating ring, powder chamber, forcing cone, centering slope, shot chamber and main bore.

The breech mechanism (Stockett) is practically the same as that of the 10-inch rifle, model of 1895, shown in Fig. 13, except in dimensions; the breechblock having a diameter of 26 inches and total length of 27 inches. The threaded portion is divided into 12 sectors, six threaded and six slotted, each sector being 30 degrees and corresponding to similar sectors in the breech recess; the rotating and translating racks are cut out of a solid block, the console or tray is made of cast steel. The bore has 96 grooves, twist of rifling one turn in 50 calibers to one turn in 25 calibers.

Total length 591 inches, with a diameter at the breech of 60 inches, gradually diminishing to 28 inches at the muzzle. Weight 127 tons; length of bore 35 calibers; weight of projectile, capped, 2,400 pounds; weight of propelling charge, nitro-cellulose powder, 612 pounds; weight of bursting charge, high explosive, for A.P. shot, 46.1 pounds; for A.P. shell, 139.3 pounds.

Muzzle velocity 2,150 foot-seconds. Muzzle energy 76,904 foot-tons. Maximum pressure 38,000 pounds per square inch. Maximum elevation permitted by the carriage 15 degrees, corresponding range

15,558 yards. Penetration Krupp cemented armor, normal impact at muzzle, 42 inches.

Only one gun of this type has been built and it has never been permanently mounted.

14-INCH BREECH-LOADING RIFLE, MODEL OF 1907

Guns of this caliber were recommended by the Chief of Ordnance in 1906, based upon the recommendation of the National Coast Defense Board, which consisted of officers of the army and navy. The question of erosion as affecting the accuracy and life of seacoast cannon caused the Ordnance Department to consider means of increasing the caliber of high-power guns and decreasing the velocities used, at the same time retaining the maximum gun power or increasing it. The importance of these deliberations may be understood when it is stated that the 12-inch B.L. rifle, Model of 1900, with a muzzle velocity of 2,500 feet per second, is not expected to last through an engagement of more than one and one-half hours' duration, assuming that the rate of fire permissible with this piece is used, this result being due to the rapid rate at which the bore is worn away under high conditions of loading and firing.

It was therefore decided that in order to meet the evil effects of this gun erosion, high velocities and heavy powder pressures should be abandoned, and return made to the custom of firing heavier projectiles with smaller velocities, at the same time retaining equal or greater gun power. It may thus be seen that the larger caliber gun was only decided upon after considerable experience and careful study on the part of the Ordnance Department.

It may be said in connection with the above, that it is entirely feasible to reline guns, but the cost of inserting new liners is considerable, especially when it is observed that the guns have to be dismantled and transported from their position in coast forts to some ordnance arsenal, where the work of relining is done.

The 14-inch gun is designed primarily for the defense of wide channels and harbors where the highest gun power is required. Its general construction and nomenclature are practically the same as that of the 12-inch B.L. Rifle. The muzzle velocity is 2,100 foot-seconds. Penetration in Krupp armor, normal impact at 8,500 yards, 12 inches. The life of this gun with the muzzle velocity indicated may be taken at 10 years, with the regular service practice firing.

12-INCH BREECH-LOADING RIFLE, MODEL OF 1888

This rifle follows the general method of built-up forged steel construction. It consists of the tube, jacket, 6 C hoops, 2 D hoops, 4 B hoops, 5 A hoops and other parts as indicated in Fig. 1.

The breech mechanism (interrupted screw system) is the same as that of the 10-inch rifle, model of 1888; except in dimensions, and that roller or ball bearings are introduced into the tray hinge, to carry easily the greater weight. The bore has 72 grooves, twist of rifling, one turn in 50 calibers to one turn in 25 calibers.

Total length 439.9 inches; weight 52 tons; length of bore 34 calibers; weight of projectile, capped, 1,046 pounds; weight of propelling charge, nitro-cellulose powder, 268 pounds; weight of igniter charge 7 pounds; weight of bursting charge, gun cotton, for A.P. shot, 13 pounds; for A.P. shell, 39.4 pounds.

Muzzle velocity 2,250 foot-seconds. Muzzle energy 36,824 foot-tons. Maximum pressure 38,000 pounds per square inch. Maximum range 15,134 yards. Penetration in Krupp cemented armor, at 5,000 yards, 13 inches.

12-INCH BREECH-LOADING RIFLE, MODEL OF 1888, MI

This rifle is similar in construction and power to the original model, except that it has 5 C hoops, 2 D hoops, 3 B hoops and 4 A hoops. Only a few of this modification were made.

12-INCH BREECH-LOADING RIFLE, MODEL OF 1888, MI $\frac{1}{2}$

This rifle is similar in construction and power to the original model, except that it has 3 C hoops, 1 D hoop, 3 B hoops and 3 A hoops.

Total length 442.56 inches; weight 51 tons; length of bore 35 calibers.

Maximum range 11,636 yards.

12-INCH BREECH-LOADING RIFLE, MODEL OF 1888, MII

This rifle is similar in construction and power to the original model, except that it has 2 C hoops, 1 D hoop, 3 B hoops, and 3 A hoops.

12-INCH BREECH-LOADING RIFLE, MODEL OF 1892 (1896)

This rifle was originally called the model of 1892. Its breech mechanism was changed to a design similar to the model of 1895—except that the operating crank was above instead of below the tray. After the change the rifle was called the model of 1896. Only one was made.

12-INCH BREECH-LOADING RIFLE, MODEL OF 1895

This rifle is similar in construction and power to the model of 1888 MII, except that its total length is 442.56 inches; length of bore 35 calibers and maximum range 11,636 yards.

The breech mechanism (Stockett) is the same as that of the 10-inch rifle model of 1895, except that the number of turns of the operating crank and the number of teeth on compound gear and worm wheel are increased.

12-INCH BREECH-LOADING RIFLE, MODEL OF 1895, MI

This rifle is practically the same as the original model.

The breech mechanism is the same as that of the 10-inch rifle, model of 1895, except in dimensions, and that the number of turns of the operating crank and the number of teeth on the compound gear and worm wheel are increased.

12-INCH BREECH-LOADING RIFLE, MODEL OF 1900

(See Plates I, II and III)

This rifle is exceedingly powerful. It is similar in construction to the model of 1888, except as follows:

Stockett breech mechanism is provided (for description, see 10-inch B.L.R. Mod. 1895).

Total length 504.3 inches; weight 59 tons; length of bore 40 calibers; weight of propelling charge, nitro-cellulose powder, 325 pounds; weight of igniter charge 9 pounds; weight of bursting charge, gun cotton, for A.P. shot, 13 pounds; for A.P. shell, 39.4 pounds.

Originally the muzzle velocity of this model was 2,550 foot-seconds, with a muzzle energy of 47,299 foot-tons. With this velocity it is capable of penetrating 12 inches of latest type battleship armor, with

normal impact of 8,700 yards; 11 inches at 10,000 yards, and 7 inches at all fighting ranges. In developing this energy, however, the high temperature due to the smokeless powder and great increase in volume of gas, produces an erosion of the bore, which materially shortens the life of the gun.

This fact caused the reduction of the service muzzle velocity to 2,250 foot-seconds, which has normally increased the life of the gun from 4 to 5 years, to at least 12 years, in peace time.

With the present velocity its penetration at 5,000 yards is 13 inches. Maximum pressure 38,000 pounds. Maximum elevation permitted by the carriage 10 degrees; maximum range at this elevation 13,513 yards.

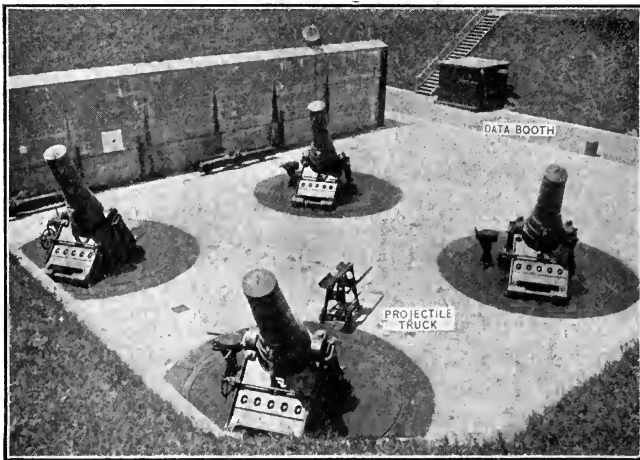

FIG. 11.—Pit of 12-inch Mortars.

12-INCH CAST-IRON MORTAR, MODEL OF 1886

(Cast-Iron Body, Steel Hooped)

This mortar is constructed of cast iron, reinforced by two rows of short steel hoops; that is, 7 A hoops, breaking joints with 6 B hoops. It is of the built-up type, the method of construction being shown in Fig. 2. Mortars have no breechplate; the breechblock is supported by the cast iron body and has screwed to its rear face a face plate, commonly called, the "banjo," to which is attached the block handle or handles.

The breech mechanism of mortars (see Fig. 12 and Plates IV, V and VI) is practically the same for all models, except those of the wire-

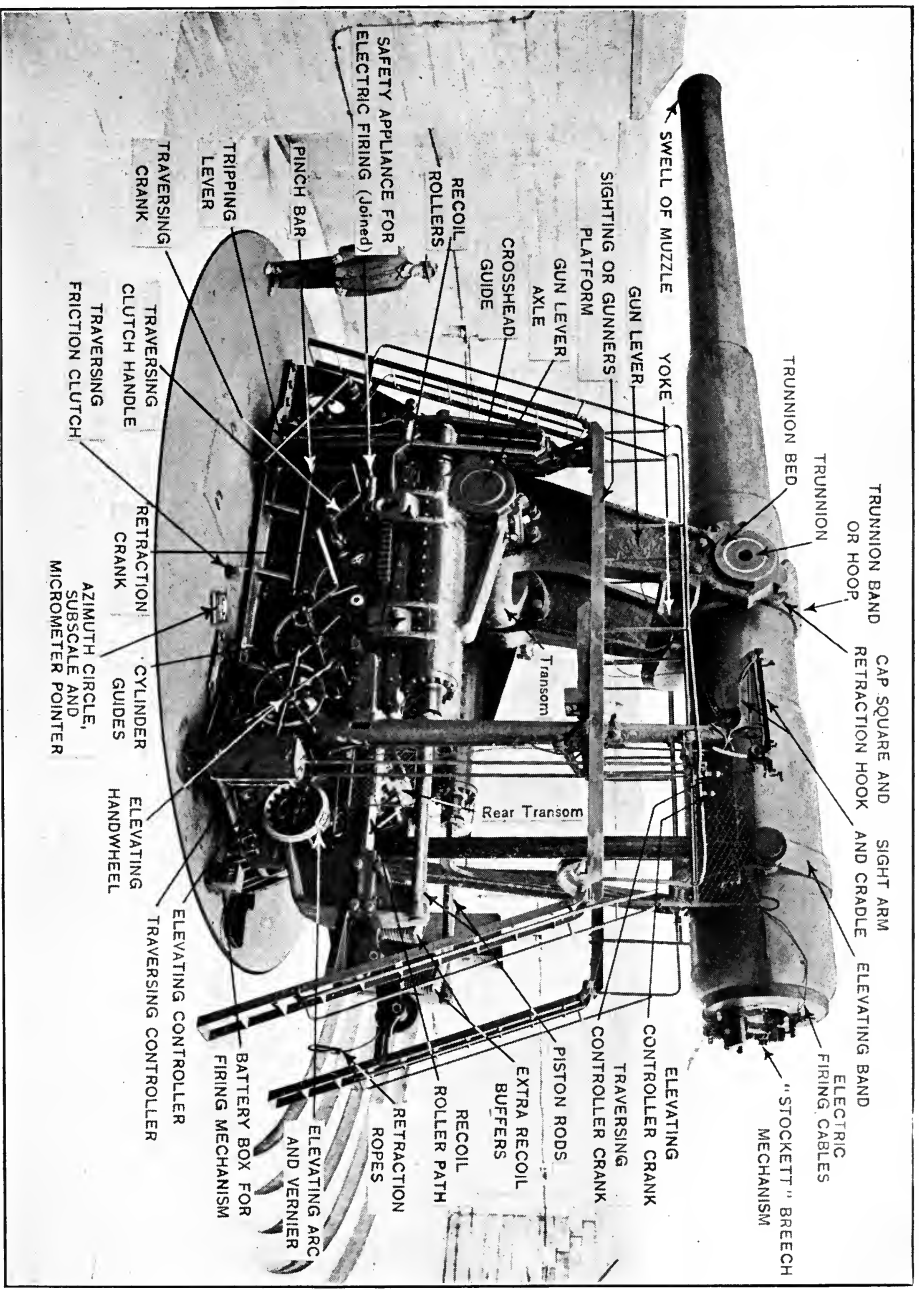

12-inch B. L. Rifle M. 1900. Mounted on D. C. L. F. M. 1901. "In Battery" (Firing Position).



12 inch B.L. Rifled Mortar. - Steel, 13 tons
 Breech Mechanism
 BLACK INSIGNO, READY FOR WITHDRAWAL

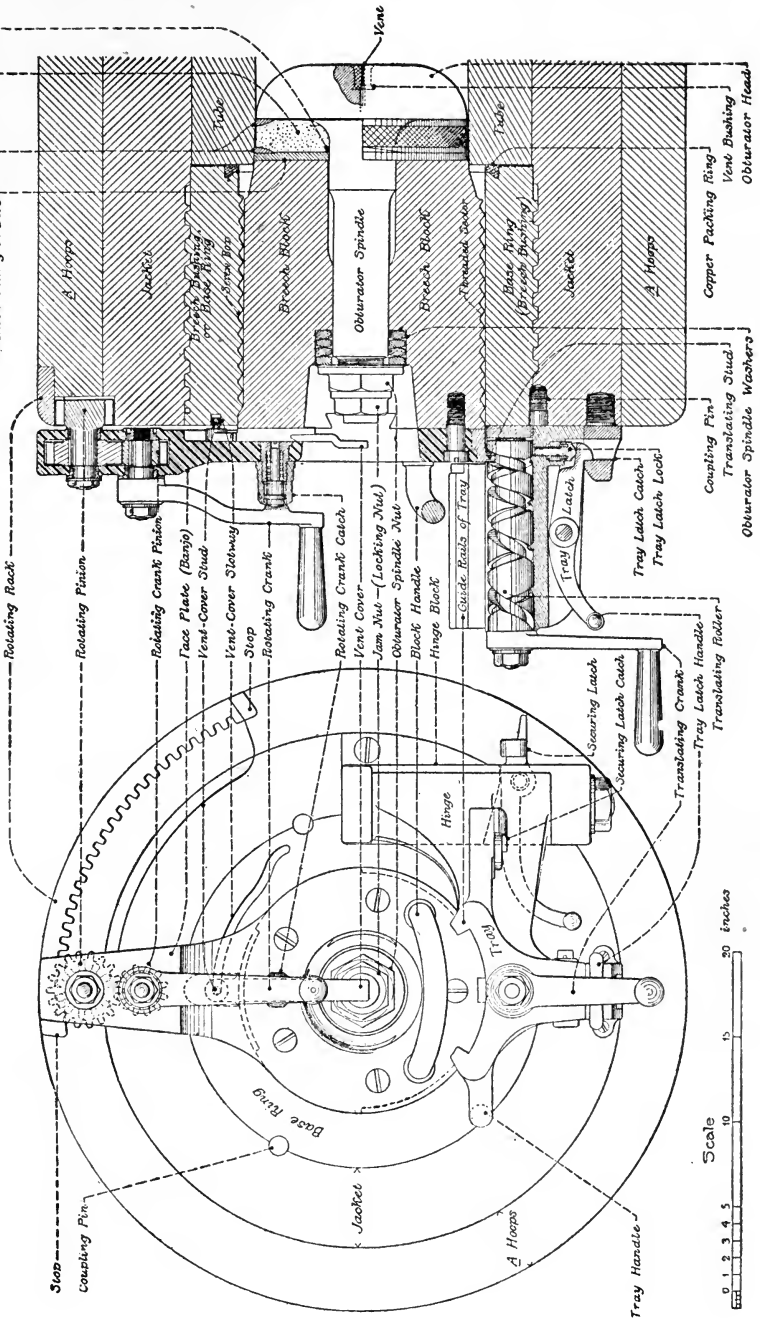

FIG. 12.

wrapped type noted at the beginning of this chapter. In all the models described herein the points of difference are of a minor character. In this particular model the threads of the breechblock have the ratchet section instead of the V used in the all-steel mortars, and the gear-rack teeth are cut on the exterior of the segment instead of on the interior, as in the later models.

The breech mechanism of mortars, with the exceptions noted above, consists of the breechblock, obturator spindle, tray, hinge, face plate, rack, translating roller, tray latch, securing latch or tray back latch, firing mechanism of safety-bar slide, and associate parts.

The breechblock is threaded with a V thread with rounded top. The rear portion is left unthreaded to prevent the entrance of dust. The threaded portion is divided into six equal sectors, three threaded and three slotted. The guide grooves fit upon and pass over the rails of the tray when the breechblock is drawn to the rear. The face plate (or "banjo"), is attached to the breechblock by five screws and a dovetail tenon fitting in a transversely slotted seat. The arm has a rectangular mortise cut perpendicularly to the axis of the breechblock, through the upper end, in which the rotating pinion and rotating crank gear are housed.

The rotating crank gear (the lower one when the arm of the face plate is pointing upward) is mounted upon an axle which extends to the rear and has the rotating crank mounted upon it. This rotating crank gear meshes into a larger one above it, the rotating pinion, which is mounted upon a second axle also having its bearings in the walls of the mortise. The bearings are bushed with bronze. The rotating gear is mounted on the latter journal, in front of the arm. This rotating gear meshes into a circular rack, geared on the interior, and bolted upon the rear face of the breech in a recess cut for the purpose. This rack is now cut in the solid metal of rear face of the A3 hoop. The rear face and upper surface of the rack are flush with the face of the breech and upper surface of the mortar.

Rotating the rotating crank turns the rotating crank gear, which turns the rotating pinion and the rotating gear, which, being engaged in the rack, travels in it and causes the breechblock to rotate. The rotating crank has a lock consisting of a housing, two studs, a spring and a handle. The housing is screwed into the rear side of the face-plate arm. The front stud is mounted in a cylindrical recess in the housing and extends through the face-plate arm. It moves in a groove of varying depth in the breech of the gun. A rear stud enters the rotating-crank arm from the front, extends to the rear, and has a

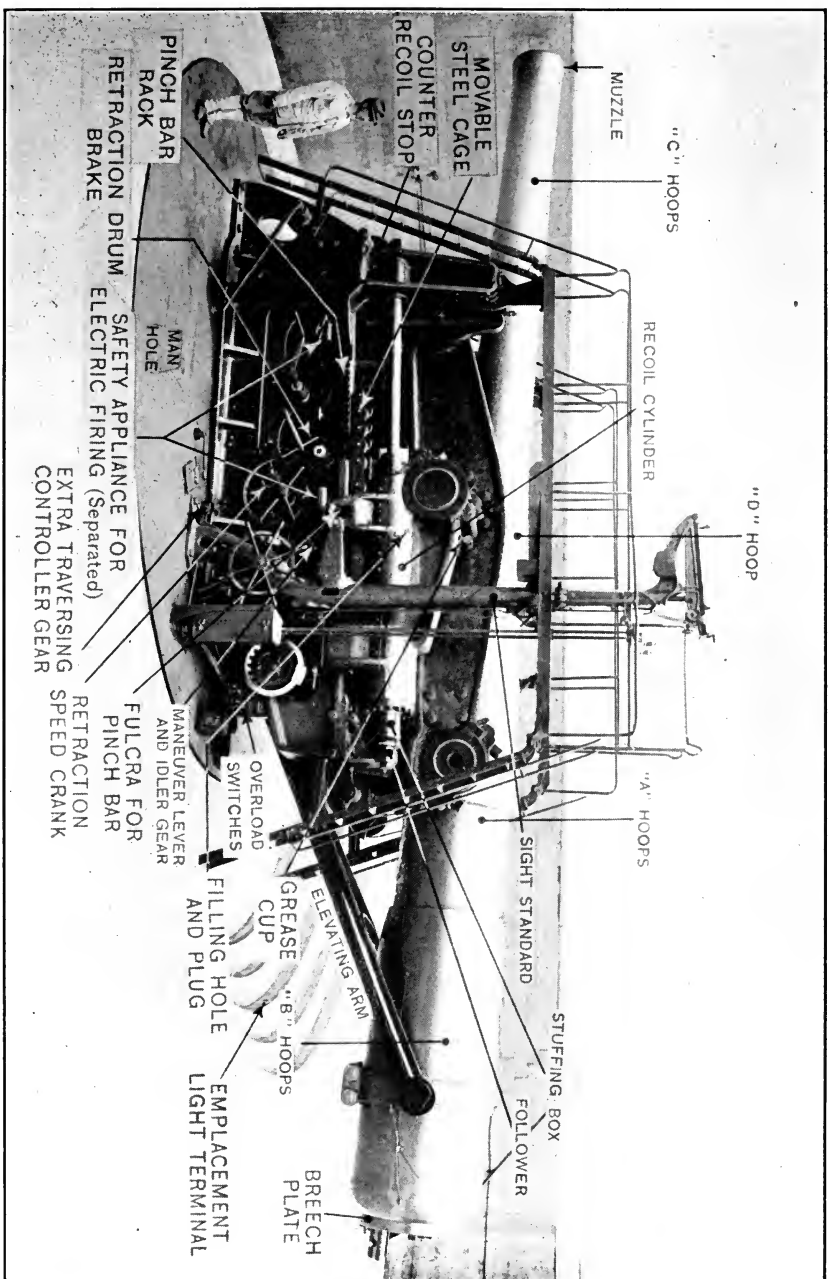

12-inch B. L. Rifle, M. 1900. Mounted on D. C. L. F., M. 1901. "From Battery" (Loading Position).



LIBRARY
OF THE
UNIVERSITY
OF
WISCONSIN

handle screwed upon the extension. About its shank is a spiral spring with its front bearing against the rear of the rear stud head. The front face of the rear stud is crowned, enabling the crank to pass the housing by compressing the spring. As long as the front stud moves in the shallow portion of its groove in the breech it entirely fills the recess in the housing.

When the rotation of the breechblock is completed and the front stud arrives at the well at the end of the groove, thus being free to move forward, the pressure of the spring forces the rear stud into the recess in the housing, latching the rotating crank. It follows that the rotating crank is also latched at any time that the breechblock is not fully translated home. In the earlier models there is no handle, and only one stud, which is crowned and fits into a seat on the front face of the rotating-crank arm, latching the rotating crank. As in the later model, the rotating crank is enabled to pass the housing by compressing the spring. A handle of steel or bronze is attached to the face plate.

Obturator Spindle

The obturator spindle, tray, and translating roller are similar to those used in the 8-inch, 10-inch, and 12-inch rifles, Model of 1888. A hinge set into the face of the breech and secured by four screws is provided with two lugs in which the hinge pin is mounted, and with two cylindrical bosses which fit in corresponding cavities in the face of the breech. The translating stud attached to the rear face of the breechblock projects vertically from the face of the block. It is shaped like the sector of a thread in a nut. Previous to 1896 it was made cylindrical in form. When the block is rotated through the arc necessary to unlock it, the translating stud revolves into the groove in the translating roller.

The obturator spindle consists of the spindle (head and stem), pad, front and rear split rings, small split ring, filling-in disk, obturator nut, and the obturator-spindle washers. The vent is drilled through the spindle, in the front of which there is a copper bushing plug forced into an undercut on the face of the head. Vents are now drilled to a diameter of 0.200 inch throughout with a radius of 0.025 inch at front end. This bushing may be replaced when badly eroded.

The front and rear rings are of steel, split diagonally through one side. They are slightly larger than the conical gas-check seat, and are sprung together in being forced into this seat. The small split ring is of similar construction, but slightly smaller than the

obturator-spindle stem. The rear filling-in disk acts as a washer in rear of the pad. A shoulder on its front face supports the interior edge of the rear split ring, and a fillet on the rear face of the obturator-spindle head performs the same office for the front split ring. The obturator nut is screwed on the rear end of the stem with a left-hand thread; it draws the obturator-spindle head, gas-check pad, and split rings to a bearing against the face of the breechblock. It abuts against the obturator-spindle washers and has under its front edge a thin steel dust cover. This obturator nut is now provided with a clamp screw to clamp it on obturator spindle to prevent its rotation, thus doing away with the old locking nut. In some of the earlier models the obturator nut has a right-hand thread.

The four obturator-spindle washers are alternately bronze and steel. They reduce the friction between the obturator nut and the rear face of the breechblock recess and enable the breechblock to be rotated independently of the gas check, during the first part of its movement in unlocking. They are assembled with a bronze washer in front and the others alternating steel and bronze.

The translating roller is seated in a right-hand thread in the upper surface of the body of the tray. It has two independent threads cut in opposite directions on its surface. The translating stud engages in the left-hand thread. The translating crank is mounted on the squared end of the translating roller. The rotation of this crank causes the roller to unscrew in its right-hand thread and travel back in the tray, drawing the breechblock with it. It also causes the translating stud attached to the breechblock to travel as a nut in the left-hand thread. Thus a double motion of translation is given to the breechblock, drawing it on to the tray by fewer revolutions of the crank than if either motion were used singly.

The tray latch secures the tray to the face of the breech while the breechblock is entering or being withdrawn from its seat in the breech recess. It is mounted in a longitudinal slot in the web on the under side of the tray, on a tray-latch pivot. Its front end terminates in a hook lip, which engages in the tray-latch catch when the tray is against the face of the breech. On its rear end is a transverse handle. A tray-spring bolt mounted in the tray above the tray latch holds it so that it can not be unlatched so long as the tray-spring bolt is covered by the translating roller.

When the latter is quickly withdrawn beyond it, the relation between the excess of weight in front of the tray-latch journal and the tension of the tray-spring bolt spring is such that the jar will unlatch

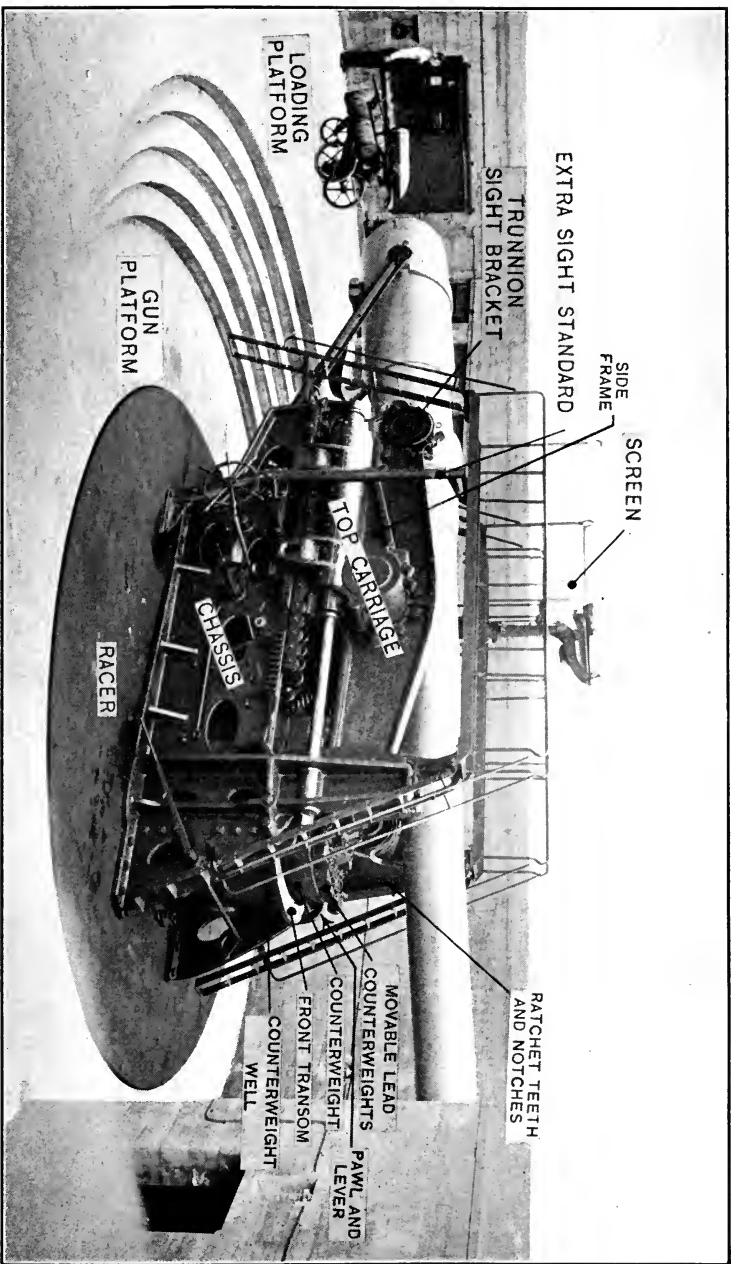

12-inch B. L. Rifle, M. 1900. Mounted on D. C. L. F., M. 1901. Showing front of carriage.



LIBRARY
OF THE
UNIVERSITY
OF
CALIFORNIA

it. The tray-latch catch is a recess cut into the face of the breech. When the tray is swung around so as to fully uncover the breech, it is held by the tray-latch, which is mounted in a mortise in the hinge on a tray-back-latch bolt passing through the hinge. This tray-back latch engages a tray-back-latch catch on the tray. It is released by lifting the tray-back-latch handle at its left end.

Action of Breech Mechanism.—When the breechblock is in the firing position the threads are in bearing with those of the breech recess; the face plate is inclined 60 degrees to the right; the rotating crank is pointed toward the vent and is held in position by the rotating-crank lock; the tray is against the face of the breech; the tray latch is engaged in its catch; the translating stud is 60 degrees to the left of its seat in the translating roller; the translating crank is vertical with the crank pointing downward, and the pad and split rings are in the gas-check seat.

To Open the Breech.—Pull out the rotating-crank lock, turn the rotating crank three turns in direction indicated by the arrow marked "open" on the face plate. The threads of the breechblock are now opposite the slotted sectors of the breech recess, the face plate is vertical, the rotating crank points downward, and the translating stud is in the translating-roller thread. Then turn the translating-roller crank three turns in a direction opposite that of the hands of a clock, ending with a quick motion to bring the breechblock to its final position in the tray with a jar which will release the tray latch. Grasp the tray handle and swing the tray about the hinge pin till the tray-back latch engages in its catch. The breechblock swings around 145 degrees and clears the breech for loading.

To Close the Breech.—Release the tray-back latch by raising its left end; swing the tray against the face of the breech by taking hold of the tray handle; turn the translating roller three turns in the direction of the hands of a clock; then turn the rotating crank three turns in the same direction. It is not necessary to count the number of turns either in opening or closing the breech, as there are stops for all motions.

To Remove and Dismount the Breech Mechanism.—Turn the rotating crank until the translating stud is out of its seat in the translating roller, thus bringing the face plate to its vertical position, remove the translating roller; grasp the breechblock handle and withdraw the breechblock on to the tray as far as possible, so that the obturator spindle head will clear the breech recess; raise the tray latch and swing the tray around; remove the obturator-spindle nut and washers,

then take off the breechblock by passing a rope through it and slinging it, using a gin or crane.

The face plate, when necessary, can then be removed by taking out the screws, but this should not be done except at the gun factory.

In case any nuts are to be removed, their pins should be driven out carefully, using a drift so as not to batter them.

The tray is removed as follows: Remove the tray latch, block up under the tray or sling it securely and remove the hinge pin. The tray-back latch is removed after removing the tray.

To Assemble the Breech Mechanism.—Put on tray-back latch, then the tray, then the tray latch; put on the breechblock on the tray (by using a sling as before); put in the obturator spindle, then the obturator nut and washers, swing the tray around against the face of the breech; push the breechblock home; rotate it slightly and put in the translating roller.

The above order of assembling assumes that the face plate has not been removed from the breechblock. In case it has, it should be put on before the breechblock is put on the tray.

If, after firing, the breechblock can not be unlocked by the rotating crank, remove the obturator nut and obturator-spindle washers, and then unlock the breechblock, leaving the spindle in the gun. Then remove the spindle by inserting a heavy timber in the muzzle and striking the head until it is loosened, being careful not to allow the spindle to drop.

The bore has 68 grooves; twist of rifling, one turn in 42 calibers to one turn in 25 calibers.

The total length is 129 inches; weight 14.25 tons; length of bore 9 calibers; weight of projectiles, deck-piercing shell, capped, 1,046 pounds and 824 pounds. With 1,046-pound projectile the powder charges, nitro-cellulose powder, are issued made up, to give velocities for zones as follows: First zone 560 foot-seconds; second zone 610 foot-seconds; third zone 670 foot-seconds; fourth zone 743 foot-seconds; fifth zone 837 foot-seconds; sixth zone 910 foot-seconds. With 824-pound projectile, seventh zone 1,050 foot-seconds. Weight of propelling charge approximately 33 pounds; weight of igniter charge 1.25 pounds.

Muzzle energy, between 6,298 and 6,544 foot-tons. Maximum pressure 27,500 pounds per square inch. Maximum range, with 45 degrees elevation, 9,557 yards. Minimum range, with 65 degrees elevation, 2,225 yards.



LIBRARY
OF THE
UNIVERSITY
OF
CALIFORNIA

12-INCH CAST-IRON MORTAR, MODEL OF 1886, M

This mortar is similar in construction and power to the original model, except that it has 5 A hoops.

12-INCH STEEL MORTAR, MODEL OF 1886-90, M_I

This mortar is similar in construction and power to the model of 1890, except that it has 5 A hoops breaking joints with 5 B hoops.

Total length 129.25 inches; weight 12 tons; twist of rifling, one turn in 40 calibers to one turn in 25 calibers. Only a few of this model were made.

12-INCH STEEL MORTAR, MODEL OF 1890

This mortar is similar in construction to the model of 1886, except that it has a tube, jacket, breech bushing, 2 C hoops, 1 D hoop, 3 A hoops and other parts as shown in Fig. 3.

The breechblock is supported by the jacket through the breech bushing. The two C hoops are shrunk on the tube from the front, each having a shoulder abutting against one on the tube. Four securing pins, screwed through the C2 hoop into the tube prevent the C hoops from moving to the front. The D hoop is put on from the front and abuts against the shoulder on the jacket, covering the joint between it and the C1 hoop. The A1 hoop, assembled from the rear, abuts against a shoulder on the D hoop and covers the joint between the jacket and the D hoop. The A2 hoop, or trunnion hoop, abuts against a shoulder on the jacket.

The bore has 72 grooves; twist of rifling one turn in 40 calibers to one turn in 20 calibers.

The total length is 141.125 inches; weight 13 tons; length of bore 10 calibers. The powder charges, nitro-cellulose powder, weigh from 54 to 62 pounds; igniter charge 1.25 pounds. With 1,046 pound projectile the powder charges are issued made up, to give velocities for zones as follows: First zone 550 foot-seconds; second zone 600 foot-seconds; third zone 660 foot-seconds; fourth zone 725 foot-seconds; fifth zone 810 foot-seconds; sixth zone 915 foot-seconds; seventh zone 1,050 foot-seconds. With 824-pound projectile, eighth zone 1,300 foot-seconds.

Muzzle energy between 9,647 and 10,077 foot-tons. Maximum pressure 33,000 pounds per square inch. Maximum range, with 45 degrees elevation, 12,019 yards. Minimum range, with 65 degrees elevation, 2,210 yards.

12-INCH STEEL MORTAR, MODEL OF 1890, M1

(See Plates IV, V and VI)

This is the latest type of built-up forged steel mortar. It is practically identical with the original model.

10-INCH STEEL MORTAR, MODEL OF 1890

This mortar is similar in construction to the 12-inch model of 1890.

Total length 117.1 inches; weight 7.5 tons; length of bore 10 calibers.

Weight of projectile 604 pounds; weight of charge, including igniter, 604 pounds.

Muzzle velocity 1,150 foot-seconds. Muzzle energy 5,287 foot-tons. Maximum pressure 33,000 pounds per square inch. Maximum range 10,798 yards. This type was entirely experimental and very few were made.

10-INCH BREECH-LOADING RIFLE, MODEL OF 1888

(See Plates VII and VIII)

This rifle is similar in construction to rifles previously described. It has 7 C hoops, 5 A hoops, 2 D hoops, and 4 B hoops.

Weight 30 tons; total length 30.6 feet; length of bore 34 calibers; the bore has 60 grooves; twist of rifling, one turn in 50 calibers to one turn in 20 calibers.

The breech mechanism, commonly called the "interrupted screw system," consists of the breechblock, obturator, breechplate, rotating crank and gears, tray, translating roller, translating crank, tray latch, tray back latch, hinge pin, and associate parts as shown in Plates VII and VIII, and Fig. 4. The principal parts of the breechblock are the threaded sectors, the slotted sectors, the guide grooves, and the translating stud.

The block is threaded with a V thread with rounded top. The rear portion is left unthreaded to prevent the entrance of dust. The threaded portion is divided into eight equal sectors, four threaded and four slotted. The two guide grooves are cut in the two bottom slotted sectors 30 degrees each side of the lowest element of the unlocked breechblock. They fit upon and pass over the rails of the tray when the breechblock is drawn to the rear.

The breechblock is slotted across its breech face for a rotating lever

which may be attached by two screw bolts. The translating stud projects radially from the rear face of the block and is secured in its seat by a screw.

When the breechblock is rotated the necessary to unlock it, the stud revolves into the groove in the translating roller. The obturator consists of the spindle, pad, the filling-in disc, and small split rings, the filling-in disc, the obturator nut, and the obturator-spindle washers. The vent is drilled through the spindle, in the front of which is a copper bushing forced into an undercut in the face of the mushroom head. This bushing permits of being replaced when badly eroded. In passing through this plug, the vent contracts from two-tenths to one-tenth of an inch. The rear end of the vent channel is enlarged and threaded for an obturating primer used to ignite the charge.

The pad is made of asbestos and tallow with a canvas covering. The front and rear split rings are of steel, split diagonally through one side. They are slightly larger than the conical seat, and are sprung together in being forced into place. The small split ring is of similar construction, and fits tightly over the spindle. The filling-in (or gas-check) disc acts as a washer in rear of the pad; a shoulder on its front face supports the interior edge of the rear split ring; a fillet on the rear face of the obturator-spindle head performs the same office for the front split ring. The obturator nut is screwed on the rear end of the spindle with a right-hand thread in the earlier guns, and in the later with a left-hand thread; it abuts against the spindle washers, draws the obturator spindle head and pad to a bearing against the face of the block, and has under its front edge a thin steel-spring washer, designed to form a tight joint over the recess for the spindle washers to prevent the entrance of dust, sand, etc. It is provided with a clamp screw to prevent the obturator nut from unscrewing.

The four obturator spindle washers are alternately bronze and steel, assembled with one of the former in front. They reduce the friction between the spindle nut and the rear face of the block recess, enabling the block to be rotated independently of the pad, leaving the latter in its seat until the block is unlocked.

The breech plate is a steel casting attached to the breech face by two large screw bolts. On it are mounted the rotating mechanism, securing latch, and the hinge lugs. A recess in its face acts as a catch for the tray latch. The rotating mechanism for the block consists of the rotating ring, the bronze bushing, the rotating gears, and the rotating crank and associate parts. The steel rotating ring encircles the breechblock and is mounted in the bronze bushing. From this

ring projects radially the gear segment of 70 degrees, in which the teeth are cut. The gear ring fits over the cylindrical portion of the block, with a lug extending into the upper right-hand slotted sector, which is prolonged to the rear to receive it when the block is locked. This lug acts as a key in the sector to constrain the block to rotate, and when the latter is withdrawn from the screw box the slotted sector slides from under the lug.

The bronze bushing is attached to the breech plate by four screw bolts and is lubricated by oil channels in its face.

The rotating gears are three in number—two single and one compound; the first, single, called the rotating-crank pinion, is solid with its journal, which works in bronze bushings and extends through the breech plate, the rotating crank being mounted on the rear end and secured thereon by a nut and pin. The intermediate gear, also single, works into the larger wheel of the compound gear. The latter is in one piece, forming two gears of different diameters; the smaller engages the gear segment, and thus, by the crank, the breechblock is rotated.

There is a spring catch called the rotating-crank box, mounted on the rear face of the rotating crank, by which the gear system is locked when the breech is closed and the block rotated to its locked position. This lock consists of two locking bolts, each controlled by a spiral spring which hold the bolts down in the locking recess in the breech face of the gun. These locking bolts act alternately, that is, one locks the rotating crank when the breech is closed and ready for firing, and the other locks the rotating crank in its horizontal position when the breech is open and ready for loading. These bolts are manipulated by means of a small crank which is provided with inclined or beveled surfaces at its pivoted end. These surfaces come into contact with lugs formed on the outer end of the locking bolts, and by swinging the small crank to the right the breech can be opened, and to the left the breech can be locked. The handle of the rotating crank is covered with a loose sleeve.

By the rotation of the block the translating stud is revolved into the thread of the translating roller, and the block is in position to be drawn directly to the rear out of the breech recess on to the tray. The tray, of bronze, is mounted in rear of the breech, supported on the right-hand side by a huge pin working in lugs on the breech plate. The associate parts are the translating roller and crank, the tray latch, and the catch for the securing latch.

The translating roller is seated in a right-hand thread in the upper portion of the tray and has also cut upon it a left-hand thread in

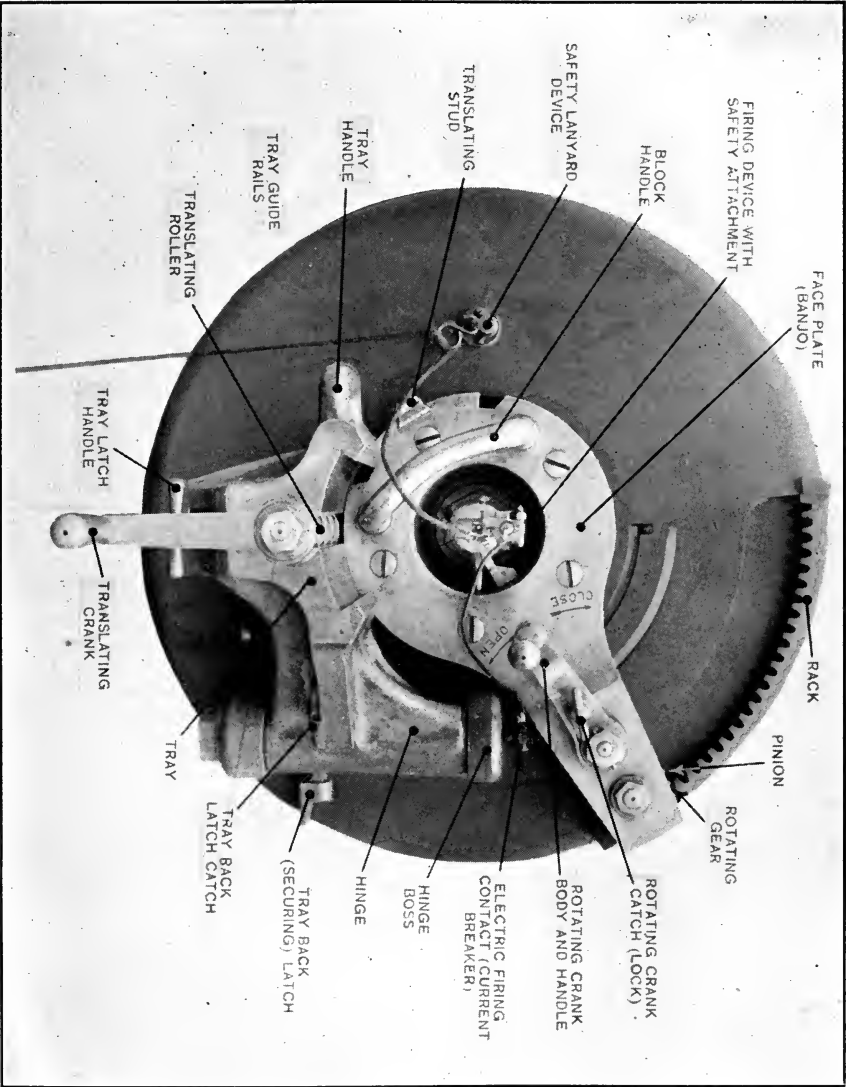

Breech Mechanism (Interrupted Screw), 12-inch Steel Mortar, M. 1890 M. (Closed)



which the translating stud works. The action of the crank causes the roller to unscrew in its right-hand thread and the translating stud attached to the block to travel as a nut in the left-hand thread, drawing the block with it; thus the translation of the block is given by fewer revolutions of the crank than if either were used singly, and has only to travel one-half the distance.

The tray latch secures the tray to the face of the breech; it is pivoted in a longitudinal slot on the under side of the tray, has the front end terminating in a hook lip, which engages in its seat in the breech plate, and has a transverse handle on its rear end. A spring bolt, mounted in the tray, holds the latch so that it can not be released while its bolt is covered by the translating roller. When the latter is quickly withdrawn beyond the bolt, the relation between the excess of weight in front of the latch journal and the tension of the tray-spring bolt is such that the jar will unlatch the tray. Just in rear of the latch spring is a bolt, passing through the web of the tray and into a recess in the roller when the block is withdrawn, thus preventing any motion of the block to the front when in the loading position.

This bolt is operated by a lever hinged to the web of the tray, one end entering the slot in the bolt, the other joined by a link, which, in its turn, is joined to the tray latch. When the latch is unfastened its rear end is forced downward by the spring bolt, thus, through the connections, raising the lock bolt into its seat in the roller; when the latch is fastened the lock bolt moves downward out of its seat.

The tray latch being unfastened, the tray may be swung to the right until caught by the securing latch. This latch is mounted in a recess in the breech plate, through which its handle protrudes on the left and its catch end on the right; its pivot is a short screw, with countersunk head located in the breech plate directly back of the tray hinge. The latch engages in a catch on the diagonal web of the tray, and may be released by lifting the handle or pressing down the latch end.

The hinge pin is a cylindrical bar, mounted in two lugs on the right side of the breech plate; it is entered from below and held in position by two small screws through the tray hinge, thus locking hinge and pin together. An oil hole in the upper hinge lug permits of the pin being lubricated.

Action of Breech Mechanism.—When the breechblock is in the firing position the threads are in bearing with those in the breech recess; the rotating crank is vertical; the rotating-crank lock bolt is bearing in its recess. The translating stud is 45 degrees to the left

of its seat in the translating roller; the tray latch is engaged in its catch; the rotating ring is rotated to extreme right-hand position and the gas-check pad is in its seat.

To Open the Breech.—Turn the winged nut of the rotating crank catch (lock) 180 degrees to the left; turn the rotating crank in the direction of the hands of a clock, as indicated by the arrow marked "open" on the breech plate, until the translating stud is in the translating-roller thread; the rotating crank latch (lock) will then be opposite the upper steel lock plate, which has a recess in its center to receive it; the guide grooves in the breechblock will be opposite the guide rails in the tray. Turn the translating crank in a counterclockwise direction four times, ending with a quick motion to bring the block into its final position in the tray with a jar, which will release the tray latch and swing the tray until the securing latch engages the catch.

To Close the Breech.—Release the securing latch; swing the tray to the face of the breech; reverse the motion of the translating crank until the breechblock is seated, then that of the winged nut of the rotating-crank catch (lock), and that of the rotating crank.

To Remove and Dismantle the Breech Mechanism.—The operations are the reverse of those described for assembling it. If, after firing, the block can not be unlocked by the rotating crank, put on the rotating lever and endeavor to turn the block. If this fail, remove the obturator nuts and washers and unscrew the block, leaving the obturator in the gun. If the block can not be unscrewed, remove the tray and breech plate. Support the tray by blocking and take out the hinge-pin bolt and remove the hinge pin and tray. Then support the breech plate by blocking and turn out the breech-plate screws, loosening all before any are entirely removed, and taking out the top and side ones last. To avoid marring the thread, let one man hold a heavy screw-driver in the slot and a second turn its blade with a screw wrench, catching the blade near the screw head. Put on the rotating lever and unscrew the block. The breech plate should not be taken off unless it be absolutely necessary; if necessary to remove it, an eyebolt, which screws into the oil hole, is provided for convenience in handling. If the block can be unlocked, but not drawn back, aid the translating roller by gently ramming on the face of the obturator, interposing a hard-wood block between the rammer and the obturator.

To Assemble Breech Mechanism.—The tray will be swung in the loading position, in which it is held by the tray-back latch. The translating roller must be removed if it should have been put into the tray previously, but this should not have been done. The obturating

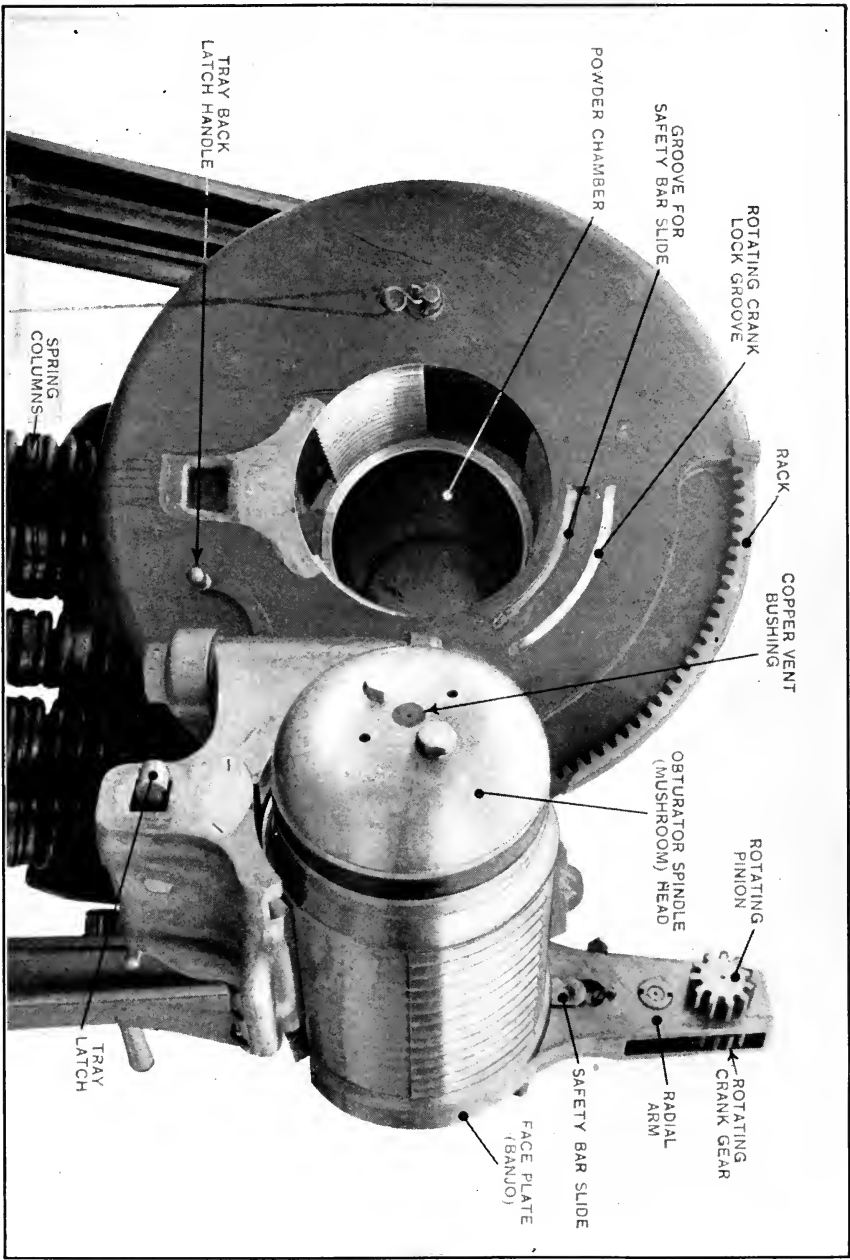

Breech Mechanism (Interrupted Screw), 12-inch Steel Mortar, M. 1890 Mt. (Open.)





spindle with the gas-check pad will be removed from the breechblock, a rope sling will be passed over the threads around the center of the breechblock and at right angles to its axis, the block being in translating position—i. e., the translating stud at its rear end points downward. The sling will be attached to the hook of the loading crane or the gin. The breechblock will be hoisted until it can be swung into the screw chamber; it will be inserted as far as the rope permits. A handspike will be inserted into the spindle cavity, and by means of this two or three men can hold the block in place while the position of the rope sling is being changed farther back. The block will now be forced into the breech recess and rotated till the rotating crank reaches its vertical terminal position.

The tray will now be swung to the breech plate and the translating roller screwed into the tray for the first time. The translating roller should not be screwed home with the tray in any other than the firing position, otherwise the rear end of the tray latch would have to be lifted up to the proper height to prevent interference between the lock bolts and the translating roller.

In case neither loading crane nor gin are available, the shot truck may be utilized. The breechblock is rolled onto the truck by means of a plank ramp, and supported thereon in its proper position by means of bits of wood. The shot truck will then be adjusted to the proper height and angle and the breechblock forced into the breech recess and rotated, as above described.

The operation of inserting and adjusting the obturating spindle is as follows: The breech will be opened and breechblock and tray swung into the loading position. The obturator spindle, with the split rings and pad in place, will be inserted into the breechblock and will be secured by screwing up the obturator nut on the rear end of the spindle. The breechblock is then translated and rotated into the firing position and the wrench applied to the large nut, which is tightened as much as possible by one man. The clamping screw on the obturator nut should then be tightened. This screw should be set up only moderately hard. The spindle is properly adjusted if while it has no play longitudinally, it can be turned round freely by taking hold of the obturator-spindle (mushroom) head with both hands.

This last adjustment may have to be repeated after a few rounds have been fired, if it is found that the spindle has any longitudinal play.

Weight of projectile, capped, 604 pounds; weight of propelling charge, nitro-celulose powder, 155 pounds; weight of igniter charge,

4 pounds; weight of bursting charge, gun cotton, 22.4 pounds, for A.P. shell; 7.5 pounds for A.P. shot.

Muzzle velocity 2,250 foot-seconds. Maximum pressure, 38,000 pounds per square inch. Muzzle energy, 21,293 foot-tons. Maximum range 12,259 yards. Penetration in Krupp cemented armor at 5,000 yards 9.8 inches.

10-INCH BREECH-LOADING RIFLE, MODEL OF 1888 MI

This rifle is similar in construction and power to the Model of 1888, and differs only in having 5 C hoops.

10-INCH BREECH-LOADING RIFLE, MODEL OF 1888 MII

This rifle is similar in construction and power to the Model of 1888, and differs only in the following points:

2 C hoops, 1 D hoop, 3 A hoops, and 3 B hoops.

The steel breech plate and bronze bushing used in the other models are replaced in this one by a bronze plate.

10-INCH BREECH-LOADING RIFLE, MODEL OF 1895

This rifle is similar in construction and power to the Model of 1888, and differs only in the following points:

Total length 369.1 inches; weight 30 tons; length of bore, 35 calibers.

The breech mechanism, known as the Stockett system (see Fig. 13 and Plates IX and X), consists of the breechblock, block-locking device, obturator, tray, tray latch, hinge, compound gear worm-wheel, worm and shaft, hinge pin and nut, rotating crank, ball bearings and bronze bushings for worm shaft.

The breechblock has 6 threaded and 6 slotted sectors. From the rear face, to the right, projects a rotating lug with teeth, into which mesh the teeth of the compound gear. Projections on the upper and lower edges of this lug strike against the gear and limit the rotation of the block in both directions. A translating rack is cut in the slotted sector which is at the same height as the compound gear when the block has been fully rotated for withdrawing. The function of this rack in conjunction with the compound gear, is to withdraw the breechblock, swing it and the tray into the loading position, and in closing the breech to perform the reverse operation. The breechblock has two guide grooves each 30 degrees from the lowest element of

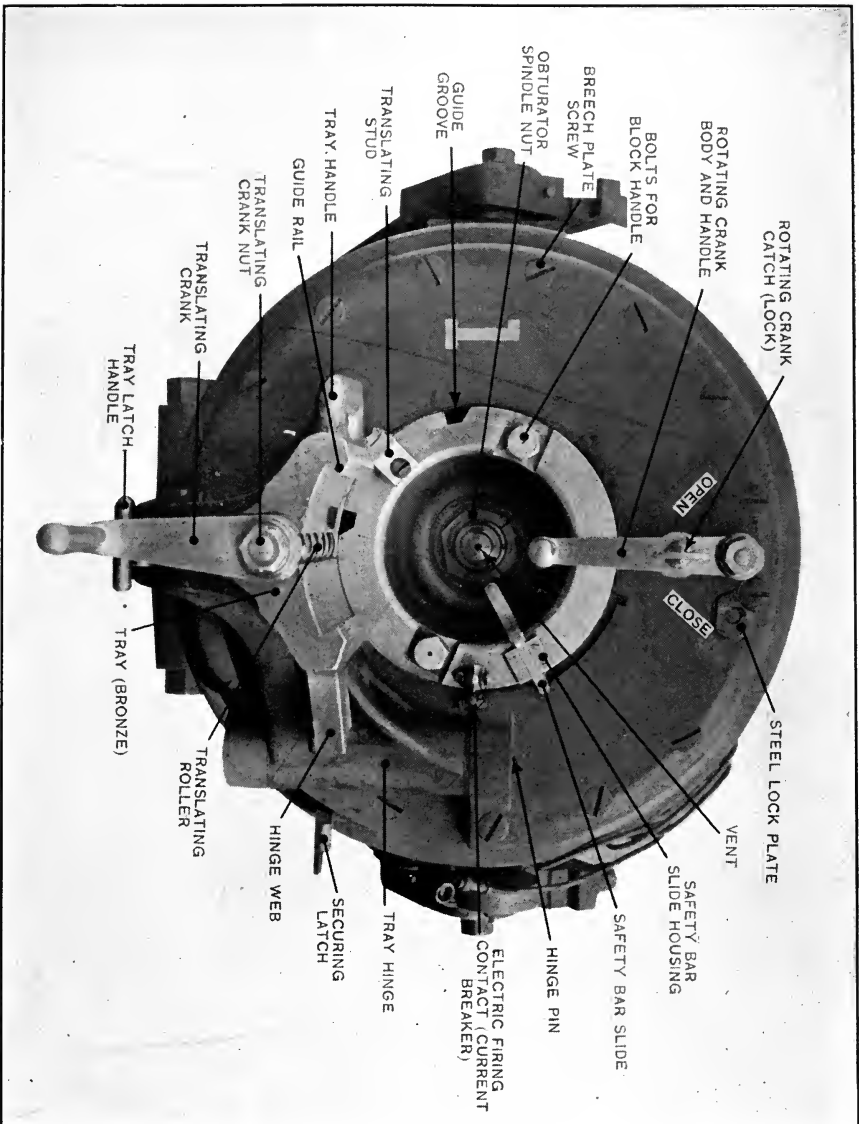

Breech Mechanism (Interrupted Screw), 10-inch B. L. Rifle, M. 1888. (Closed).



the block, when it is in position for withdrawing, and ending in shoulders near the front face.

There are two short grooves, midway between the guide grooves and parallel to them at opposite ends of the block, ending in inclined shoulders; they form seats for the toes of the tray latch when the block is withdrawn.

The block-locking device consists of a bell-crank lever pivoted to the breech face near the upper end of the hinge pin, the longer arm of which is connected to a spring-controlled locking bolt, which is

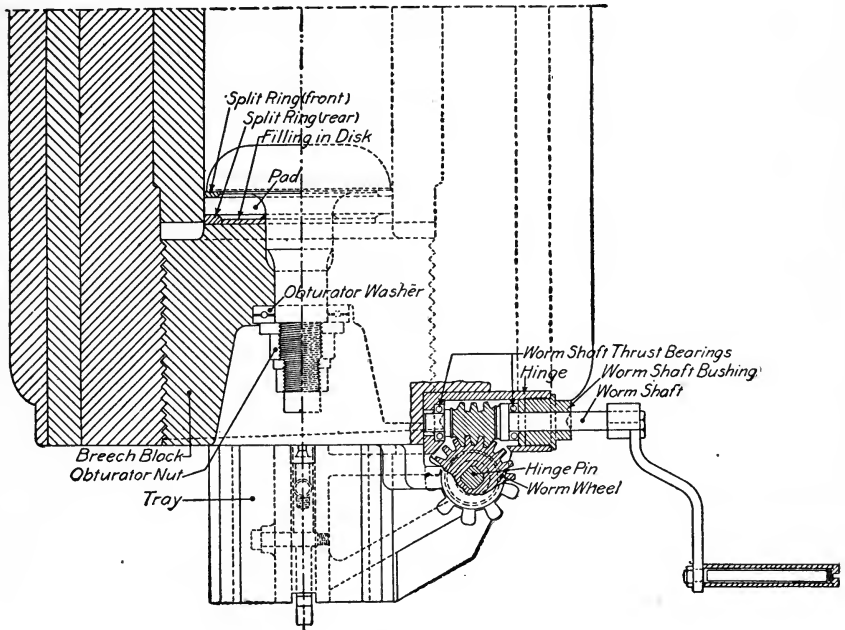

FIG. 13.

seated in the breech face, its lower end being engaged in a notch cut into the periphery of the block. The short arm of the bell crank is arranged to fit into a notch cut into a cap fitted to the upper end of the hinge pin. The bell crank is provided with an operating handle for controlling the locking bolt. The block-locking bolt must be tripped from its seat in the breechblock before the breech mechanism can be opened, that is, before the breechblock can be rotated. During the rotation and translation of the block the short arm of the bell-crank lever is out of its notch in the hinge-pin cap and is bearing against

the periphery of the cap; this holds or supports the locking bolt in its upward or unlocked position, so that there is no interference between the locking bolt and the breechblock when the latter is being closed. The locking bolt works automatically when the breech mechanism is closed, but must be operated by hand before the breechblock can be rotated for opening.

The obturator is of the same construction as for the model 1888 gun, except that ball bearings are used instead of spindle washers. The tray is of steel, mounted in rear of the breech, and consists of two guide rails, a cylindrical hinge, and a heavy connecting web. A hinge pin passing through two lugs on the hinge plate supports the tray. A tray latch, with locking bolt and spring, is also provided. The tray latch consists of the latch proper, and its catch, with latch spring, locking bolt and spring, and the operating stud.

The latch proper is a steel lever, pivoted by a bolt to the web of the tray. It has a toe and handle at the rear end, and a toe and hook at the front end. The front toe is bored through for the passage of the operating stud, and there is a seat on the upper surface of the latch for the latch spring. The latch spring is spiral, and is seated in the lower face of the web and the upper space of the front half of the latch. The locking bolt is cylindrical, and has a spiral spring in rear, constantly pushing it forward. The operating stud, which controls the locking bolt, passes through the front toe of the latch. The tray-latch catch is a steel stud, screwed into the breech, and is of a shape to receive the hook of the latch. The hinge plate is of steel, and is assembled by seven screw bolts to the breech of the gun, on the right-hand side. Its rear face is flush with the breech, and has two lugs for the hinge pin. The lower end of the plate is bored out to receive the worm and shaft, and its bearings.

The hinge pin is cylindrical, with a flange on top, a square surface for the bronze worm-wheel beneath the lower lug, and a thread for a securing nut below the wheel. Just below the upper lug, at opposite extremities of a diameter, are two splines, upon which the compound gear is assembled. The upper lug hole is large enough to permit these splines passing through, and the pin is correspondingly enlarged at the upper end. The compound gear is assembled between the upper hinge lug and the hinge, and is secured from rotating on the pin by the splines that fit into two grooves on the inner surface of the gear. The latter is formed by first cutting large tooth-shaped screw threads, and then cutting longitudinal grooves at regular intervals, thus forming a combined spiral gear (to rotate the block), and a pinion (to operate

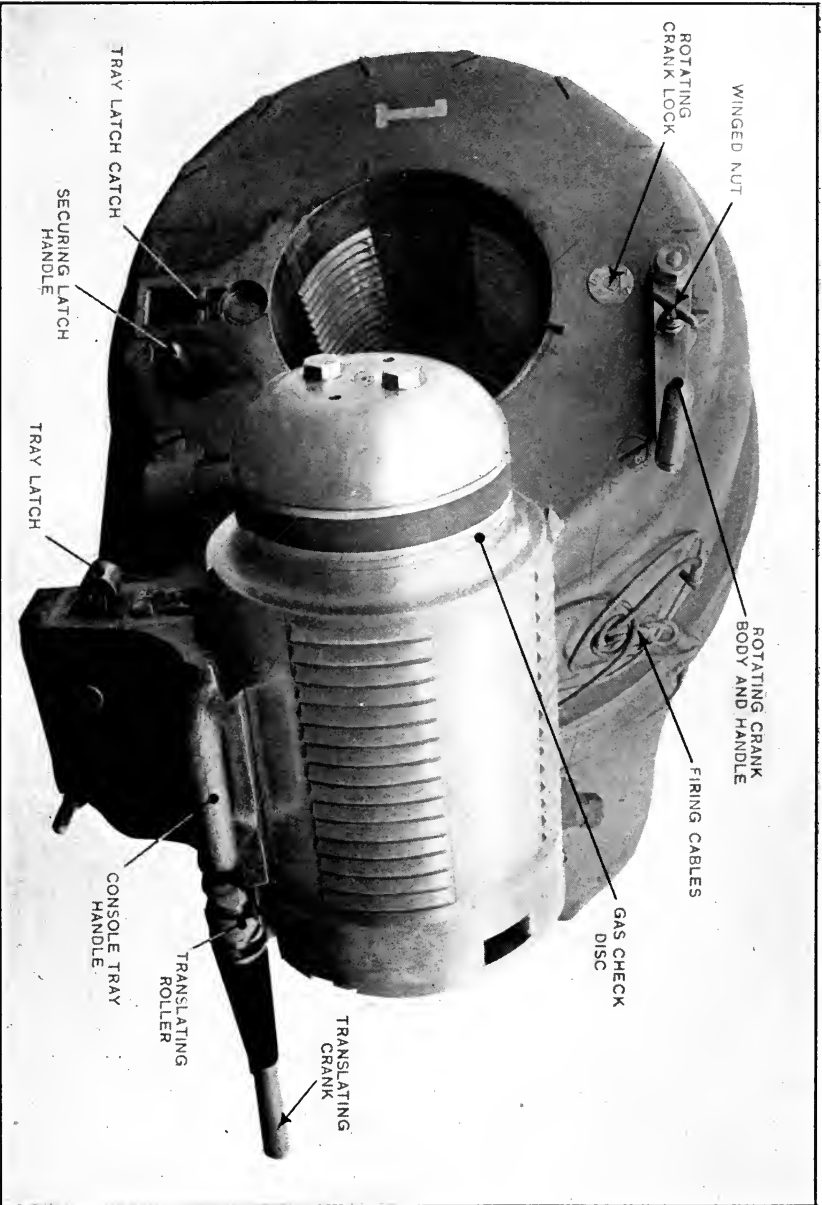

Breech Mechanism (Interrupted Screw), 10-inch B. L. Rifle, M. 1888. (Open.)



LIBRARY
OF THE
UNIVERSITY
OF
CALIFORNIA

on the translating rack). A ball-bearing washer of steel is placed between the hinge and lower hinge lock, to reduce friction in swinging the tray and block. Between the ends of the worm and bronze bushing are placed hardened steel ball bearings, to reduce the friction due to the end thrust. The outer end of the shaft is squared to receive the crank, the handle of which has a loose-fitting brass sleeve to facilitate operation.

Action of the Breech Mechanism.—The block, when in firing position, has its threads engaged in those of the breech recess, and is provided with a locking bolt fitted in a recess in the breech face of the gun, having its lower end seated in a notch formed on the periphery of the block. The upper teeth of the rotating rack are engaged in those of the compound gear; the tray is latched to the breech; the rear toe of the latch projects above the upper surface of the tray; the front toe is on a level with this surface, and the rear face of this toe retains the latch locking bolt in its recess.

To Open the Breech.—First release the locking bolt from its seat in the block by pressing downward on its handle. The crank is then turned continuously towards the muzzle, until the tray comes to rest against the hinge. As the crank is turned, the teeth of the compound gear, working in those of the rotating rack, cause the block to rotate to the left until its guide grooves are opposite the guide rails of the tray. In this position the lower shoulder on the lug strikes the lower surface of the gear, preventing further rotation of the block. The teeth of the gear then engage in the translating rack, and the block is withdrawn. At the end of its travel it strikes the inclined surface on the rear toe of the tray latch, forcing it down against the action of the latch spring, thus unlatching the tray. The front toe of the latch then rises and engages in its groove in the block; the locking bolt moves forward and enters its seat in the latch, forcing the operating stud to the front. The block is prevented from moving to the rear on the tray by the bearing of the guide rails against the shoulders of the guide grooves, and from moving forward, by the front toe of the latch. The block and tray swing with the hinge pin to the right, until the tray rests against the hinge. In this position the crank handle is horizontal and in front of the shaft, the weight of the frame being sufficient to retain the block and tray in place, without a back or securing latch.

To Close the Breech.—The crank is turned to the rear, until the projecting shoulder on the upper surface of the rotating lug strikes the gear. As the block is locked to the tray, turning the crank to the

rear swings both block and tray to the left until the tray strikes the breech of the gun. The operating stud, projecting through the front of the latch, being pressed back by bearing against the breech, forces the locking bolt into its recess and releases the tray latch in front. The first small forward motion of the block when the tray strikes the breech releases the rear toe of the latch, and the latch spring forces the hook over the catch, thus locking the tray to the breech. The block now being free to move forward, is forced home by the translating rack and gear and rotated to the right by the rotating lug and gear, until in the firing position again, when the projection on the upper surface of the lug strikes the gear, preventing further motion.

To Assemble the Breech Mechanism.—The breech recess, also all surfaces of contact with parts of the breech mechanism, will be carefully cleaned and any traces of rust removed.

All parts of the breech mechanism will be carefully cleaned also.

In assembling the breech mechanism, the worm shaft with its ball bearings will be put into place first. Insert one ball bearing into seat at inner end of worm recess. Assemble other ball bearing on worm shaft outside of worm and insert worm shaft with this ball bearing into recess. Then put the threaded bronze bushing into place and screw entirely home, when its collar will be in perfect contact with the hinge plate.

The tray (console) will be assembled next, with its ball bearing tray latch, and catch bolt. The hinge pin will be slipped into place to support the tray and allow it to be swung into position to receive breechblock. The obturating spindle with the gas-check pad, split rings, and disk will be removed from the breechblock so that block can be suspended by a rope sling through hole in breechblock. This rope sling to be hung from a gin or crane erected for the purpose.

The breechblock will be hoisted until its guide grooves are opposite the guide rails of the tray, and will be pushed on from the front of tray (as stops would prevent the opposite), taking care that the breechblock is horizontal.

Note that in the 12-inch rifle the tray must be rotated till its front surface is parallel to the axis of the gun when the block is being slid into place, as otherwise the rear of block would not clear the upper hinge lug when the block is well in the recess.

Disengage the rope.

Swing tray with block against end of gun, push the block into breech recess of gun, shoving it entirely home, but do not rotate it.

The tray should now be supported by blocking or otherwise, so

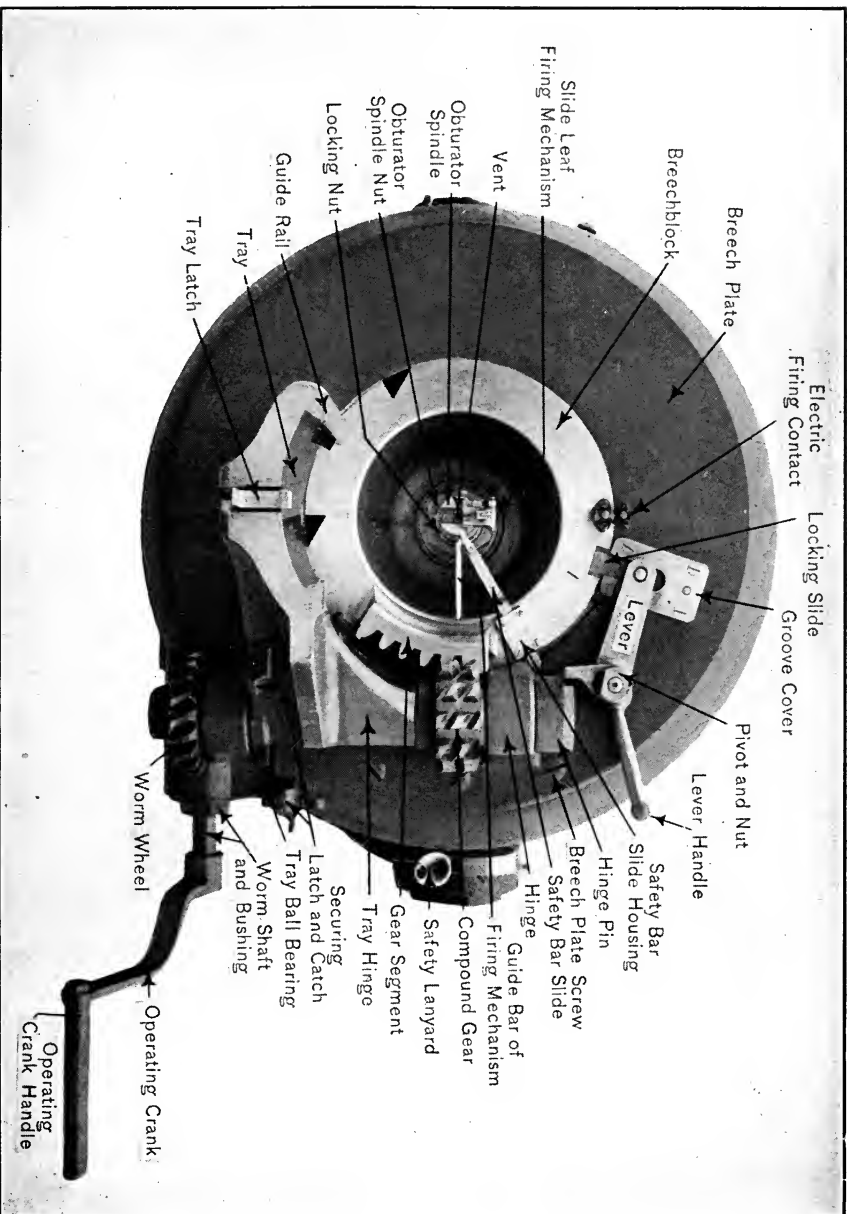

Breech Mechanism (Stockett), 12-inch B. L. Rifle, M. 1900. (Closed.)



LIBRARY
OF THE
UNIVERSITY
OF
CALIFORNIA

that the hinge pin may be withdrawn. After which hold in position the spiral gear with the face having cylindrical hub uppermost, the two teeth marked *A* and *B* being inserted into spaces marked *A* and *B* on rotating rack of block. The vertical line engraved on the spiral gear must now be coincident with that on the upper hinge lug. Insert hinge pin with vertical line thereon coincident with above and lower gently through spiral gear and tray and lower hinge lug, but not below the latter. Hold in this position while bronze worm wheel is put into place, as follows: The worm wheel has upper face marked "Top," and the marked spaces on wheel must engage the similarly marked teeth of the worm. The worm wheel should now be rotated by the worm (so that proper engagement of teeth is preserved) until the line engraved upon the wheel coincides with the before-mentioned vertical line of hinge lugs and spiral gear and hinge pin. Then hinge pin can be lowered completely into place, and nut at bottom screwed on, and the locking pin driven through nut and hinge pin.

The crank handle should be placed upon the worm shaft in the position indicated by the engraved line and the set screw.

The insertion and securing of the spindle will be performed as follows: With the breechblock in loading position, the spindle, with split rings, gas-check pad, and gas-check disk upon it, will be inserted into the block. The large ball bearing will be put in place upon rear end of spindle projecting through block, and spindle secured by screwing up by hand the spindle nut.

The adjustment of the spindle is the same as described for model of 1888 guns.

To Remove and Dismount the Breech Mechanism.—The operations are the reverse of those given above.

The maximum elevation of the carriage is 15 degrees, corresponding range, 14,062 yards.

10-INCH BREECH-LOADING RIFLE, MODEL OF 1900

This is the latest type of 10-inch rifle. It is similar in construction to the model of 1895, and differs only in the following points:

Total length 420 inches; weight 34 tons; length of bore 40 calibers. The first guns constructed of this model had rifling consisting of 60 grooves; twist, one turn in 50 calibers to one turn in 25 calibers. The later guns of this model have 90 grooves; twist, increasing from 0 to 1 caliber. The powder chamber is made cylindro-conical, instead of cylindrical, as in all other types of this caliber.

Weight of propelling charge, nitro-cellulose powder, 205 pounds; weight of igniter charge 4 pounds; weight of bursting charge, gun cotton, A.P. shell 22.4 pounds; A.P. shot 7.5 pounds.

Muzzle velocity 2,250 foot-seconds. Muzzle energy 26,169 foot-tons.

Maximum pressure 38,000 pounds per square inch. Maximum elevation permitted by the carriage 12 degrees; corresponding range 14,162 yards. Penetration in Krupp cemented armor, at 5,000 yards, 11.6 inches.

8-INCH BREECH-LOADING RIFLE, MODEL OF 1888

This rifle is one of the earliest models of the built-up forged steel type, and was for that reason taken as an example and described in detail in the chapter on Gunnery and Ballistics.

Total length 278.52 inches; weight 14.50 tons; length of bore 32 calibers. The bore has 48 grooves; twist of rifling, one turn in 50 calibers to one turn in 25 calibers. Weight of projectile, capped, 316 pounds; weight of propelling charge, nitro-cellulose powder, 80 pounds; weight of igniter charge 1.5 pounds; weight of bursting charge, gun cotton, A.P. shell 11.5 pounds; A.P. shot 4 pounds.

Muzzle velocity 2,200 foot-seconds; Muzzle energy 10,683 foot-tons. Maximum pressure 38,000 pounds per square inch. Maximum elevation permitted by the carriage 12 degrees; corresponding range 11,019 yards. Penetration in Krupp cemented armor, at 5,000 yards, 6.8 inches.

8-INCH BREECH-LOADING RIFLE, MODEL OF 1888 MI

This rifle is similar in construction and power to the Model of 1888, and differs only in the following points:

5 C hoops. The size of the D hoops altered slightly.

8-INCH BREECH-LOADING RIFLE, MODEL OF 1888 MII

This rifle is similar in construction and power to the model of 1888 MI, and differs only in the following points:

2 C hoops; 1 D hoop; 4 A hoops. Jacket increased slightly in length. Bronze breech plate.

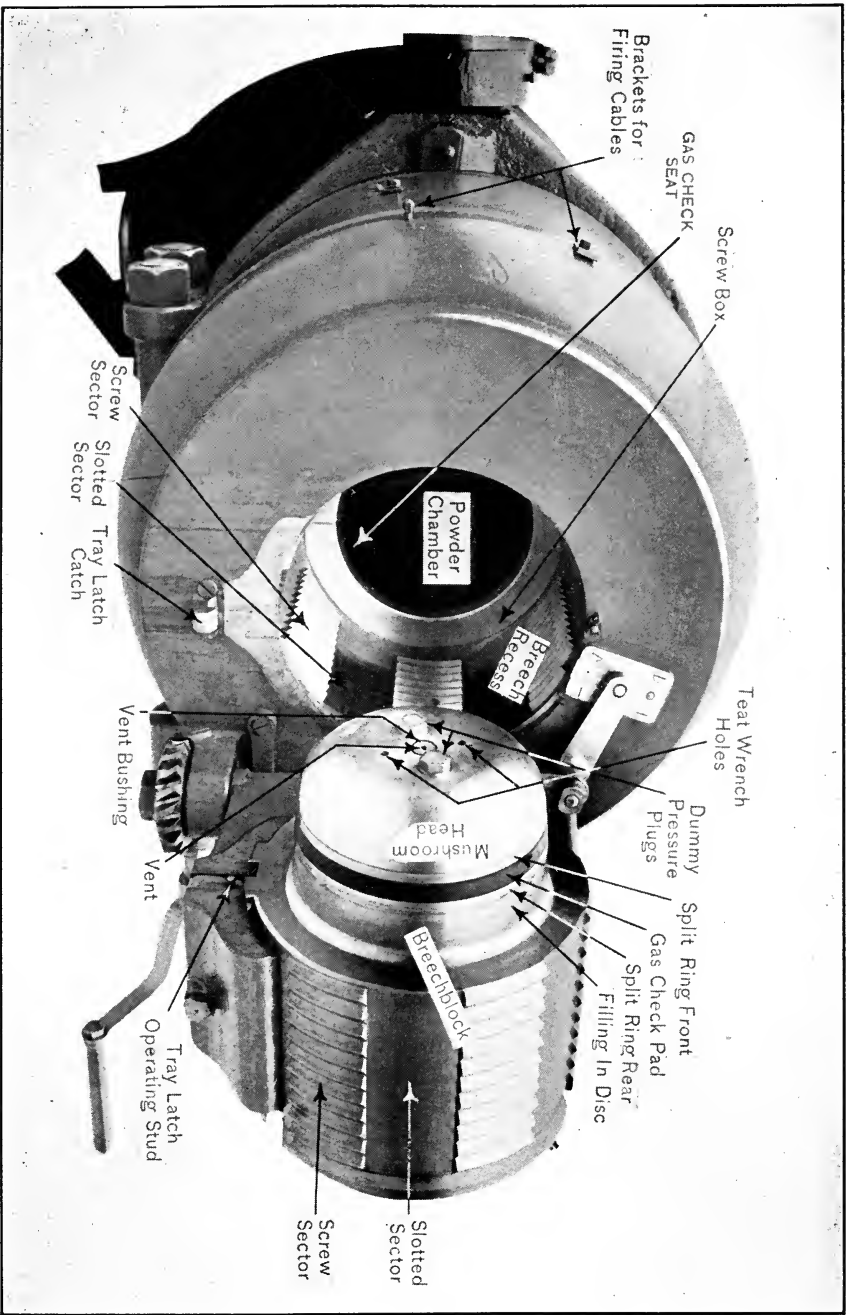

Breech Mechanism (Stockett), 12-inch B. L. Rifle, M. 1900. (Open.)



INTERMEDIATE ARMAMENT

6-INCH QUICK-FIRING ARMSTRONG GUN

(See Plates XI and XII)

This rifle is manufactured by the W. G. Armstrong Company, England. It consists of a tube, jacket, 2 C hoops, 1 A hoop, 1 D hoop, and a breech ring.

It is constructed entirely of steel, and is designed for obtaining great rapidity of fire. For this purpose it is mounted on a special mounting, and is not provided with trunnions, but is carried by a cradle which encircles the gun, and in which it slides when recoiling. This cradle is provided with trunnions on which the gun and cradle are balanced. The breech of the gun is surrounded by a breech ring which has a projecting arm on it for connecting the gun with the recoil cylinder, which forms part of the cradle. The mechanism for closing the breech is of the interrupted-screw system, so arranged that it can be quickly opened or closed by a single movement. The gun is provided with electrical firing gear, connected with an electrical pistol, fixed to the mounting in a convenient place, so that the man laying the gun can fire while looking over the sights. It is also provided with a percussion arrangement for mechanical firing in case of failure of the electrical gear. The gun sights are fixed to the gun cradle, and do not therefore recoil with the gun. The powder is contained in a metallic cartridge case, the base of the projectile resting against the front end of this case.

Breech Mechanism (Plate XII).—The breech of the gun is closed by a screw formed in two steps, the front step being tapered and of less diameter than the rear; both steps have three portions of their threads removed, each one-sixth of a turn, the threads on one step standing opposite to the blank spaces on the other; this arrangement distributes the strain all round the circumference of the breech screw. The interior of the gun at the breech is prepared in a similar manner, and admits of the breech screw being swung into place and locked by a simple mechanism to be described.

The breech screw is supported by a carrier, on which it is free to revolve through an angle of 60 degrees; the carrier is hinged to the right side of the breech ring, so that the screw can swing clear of the breech opening for loading. The screw is secured on the carrier by means of the stop bolt. The breechblock is unscrewed and with-

drawn from the gun by a single horizontal movement of the hand-locking lever, which is pivoted on the right side.

A projecting pin is screwed into the rear face of the breech screw, and enters a traversing bush in the sliding block. This block slides in a seat in the carrier, and is connected to the hand-locking lever by the link. When the breech is open the screw is prevented from turning on the carrier by a spring catch on the carrier, which engages a notch in the screw as it is withdrawn from the gun; when closing the breech the catch comes in contact with the face of the gun, thus releasing the screw and leaving it free to be screwed home.

It is impossible to fire the gun until the breech is completely locked. This is insured by means of a safety gear consisting of a pawl fitted to a spindle. The pawl engages a lip on the striker, and prevents the latter from touching the primer while the hand lever is in the unlocked position. On the lower end of the spindle is formed a lever with a projection which engages in a recess on the hand lever. Another projection is formed on the lever, which is acted upon by the sliding block so that the pawl is retained in position by a key on the spindle falling into a notch in the carrier, while the hand lever is drawn clear in unscrewing the breechblock.

When the hand lever is in the locked position, it is held there by the torsion of the spiral spring when the gun is elevated.

The striker is secured in the carrier by a retaining nut, and can be readily removed by slightly withdrawing it and turning the nut a quarter of a turn.

To fix the striker it is pushed into the gun, and the retaining nut turned to the right or left.

Electrical Firing Gear.—This gear consists of an insulated firing needle fitted in the axis of the breech screw. The needle is surrounded by a spiral spring, which holds it against the electrical primer in the base of the cartridge case. The needle is provided with a projection at the rear end by which it is drawn back, the projection being acted upon by a lever on the spindle. On the lower end of the spindle is fitted a pawl, having a projecting piece on the under side, which is held in a cam groove cut in the hand lever. When the hand lever is moved away from the locked position, the spindle is revolved by its projecting piece working in the cam groove, thus causing the pawl to engage the projection, and draw the needle back a sufficient distance to effectually prevent it from making a contact with an electric primer.

Two brackets are provided, one fitted to the gun, while the other is fitted to the gun cradle. These brackets carry the insulated electric

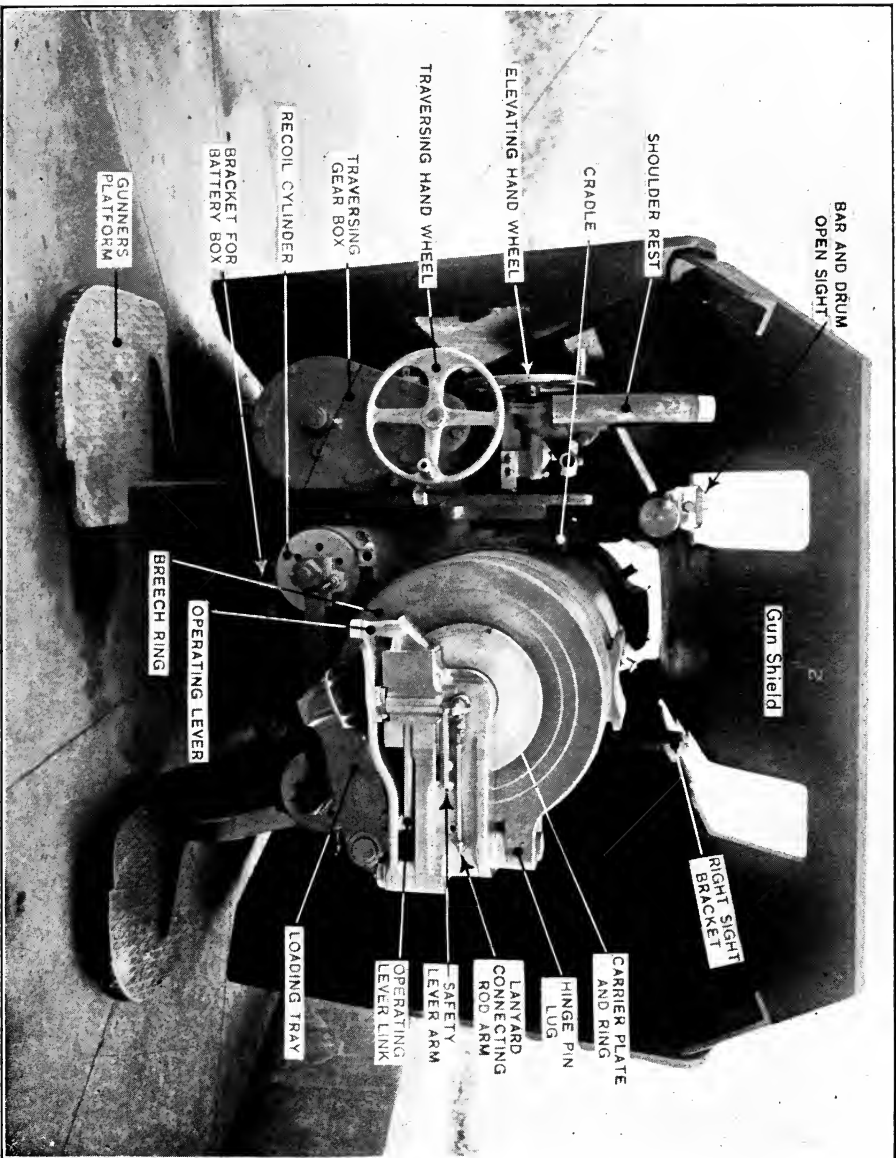

6-inch Q. F. Armstrong Gun, Model of 1898, Barbette Carriage (Pedestal Mount).



cable and the contact pieces on the ends of these cables, the contact pieces being forced out by springs so that their contact is always insured. The cable from the needle passes to the bracket on the gun, and there contact is made through the contact pieces to the cable attached to the bracket on the gun cradle, which is connected to the electric firing pistol. This pistol is fitted to the mounting in a convenient position for the man who lays and fires the gun. A three-cell electric battery is placed on the mounting; one of the terminals of this battery is connected to the pistol and the other to the mounting as an earth connection. The brackets are detachable and can be easily removed, which allows a spare cable to be readily applied if required.

An alternative electrical firing gear is also provided, which can be immediately put into action if the other one becomes short circuited or the insulation fails. It consists of a long cable, having a split pin at one end, which is pushed into a hole in the head of the needle. The other end is connected to the terminal of the battery. About the middle of the cable is a firing key, which is held in the hand of the man who lays the gun. On pushing down the end of this firing key the circuit is completed and the current passes direct from the battery to the needle, and thus fires the gun.

Before connecting this alternate cable to the battery and the needle, the parts of the other cables, which are connected to the battery and the needle, should be removed.

Percussion Firing Gear.—This gear is fitted to the retaining nut, and consists of a spring trigger with loop to receive the lanyard.

To fire by percussion the firing pin or needle is pulled to the rear until it is caught by the trigger, which retains it until the latter is displaced by the lanyard attached to the trigger loop. This leaves the firing needle free to travel forward and strike the primer.

When firing with this gear the adapter is screwed into the base of the cartridge case and the percussion primer placed into its chamber in the adapter.

When the trigger is displaced the projection on the head of the trigger is moved into a slot provided in the carrier, which prevents the retaining nut from being turned if the lanyard is pulled in an upward direction.

Cartridge Extractor.—The cartridge is started by the extractor, which only has sufficient motion to insure its being free for the remainder of the extraction, the conical shape of the cartridge case and chamber rendering a small motion sufficient for this purpose. The cartridge

is then completely withdrawn and laid in the recess by means of a hand extractor, which readily fits over and firmly holds the primer.

The mechanical extractor is worked by the carrier in opening the breech screw. It consists of a lever passing through one side of the gun and fitting into the groove for the rim of the cartridge case in such a manner that when it is turned about its own axis the fitted part acts as a lever and presses the cartridge to the rear.

The extractor is brought back into its place as the breech is closed by means of a strong helical spring outside the gun. This spring also serves as a buffer to prevent the breech screw and carrier being swung too violently around. The extractor is fitted on the right-hand side, so that it is out of the way of loading or damage from a projectile when the latter is being entered into the gun.

The bore has 24 grooves; twist, from 0 to 1 in 30 calibers. The powder chamber is conical.

Total length 249.1 inches; weight 6.6 tons; length of bore 40 calibers; weight of projectile 106 pounds; weight of propelling charge, nitro-cellulose powder 19 pounds; Cordite 13.3 pounds; weight of bursting charge, Maximite or Explosive D, 4.3 pounds.

Muzzle velocity 2,150 foot-seconds. Muzzle energy 3,400 foot-tons. Maximum pressure 34,000 pounds per square inch. Maximum elevation permitted by the carriage 16 degrees; corresponding range 10,185 yards. Penetration in Krupp cemented armor, at 5,000 yards, 2.9 inches.

6-INCH RAPID-FIRE GUN, MODEL OF 1897

(Sec Modification I)

6-INCH RAPID-FIRE GUN, MODEL OF 1897, MI

(Ordnance Department Model)

This rifle follows the general method of built-up forged-steel construction. It is of American manufacture. It consists of a tube, jacket, 4 A hoops (one of which is the trunnion hoop), 2 C hoops, 1 D hoop. The powder chamber is cylindrical.

The breech mechanism consists of the breechblock, gear segment, block carrier, lever, pinion, latch, obturator, and associate parts.

The breechblock is cylindrical, with an axial hole for the reception of the spindle and washer. The front part of the block for a short distance back is reduced in diameter. This reduced part or nose of

the block leaves a space in the breech recess of the gun, in which fouling may collect without interrupting the working of the block.

On the outer surface of the block is cut a V-shaped screw thread with rounded top and bottom. This screw thread is divided circumferentially into eight equal parts, and the threads cut from the alternate sectors. The sectors from which the threads are cut are called the slotted sectors, and permit the entry of the block past the corresponding threaded sectors in the breech recess. The threaded sectors of the block are then engaged with the threaded sectors of the recess by revolving the block through an angle of 45 degrees about its longitudinal axis. Portions of the threaded sectors on the block are cut away and parts of the slotted sectors deepened to provide clearance between the block and breech recess when the former is swung to or from the piece.

The rear end of the block is turned down to a smaller diameter, and the cylindrical surface thus formed is prolonged into the block and increased in length by means of an annular groove cut in the rear face of the block. This cylindrical surface is called the guide cylinder, and the annular groove, the guide groove of the block. That portion of the rear face of the block which lies outside of the guide groove is called the stop flange. When the block is withdrawn the stop flange strikes the bottom of the stop groove in the block carrier and limits the rearward motion of the block. The guide cylinder supports the breechblock in the carrier and guides it in its motions of rotation and translation. The guide flange of the block carrier fits into the guide groove of the block and assists in supporting and guiding the latter. Four oil holes are drilled radially from the exterior of the block to the bottom of the guide groove to facilitate oiling the bearing surfaces. These holes also act as air vents. An oil hole cut radially in the nose of the block and closed by a screw is provided for oiling the front face of the block.

The locking recess is cut in the surface of the guide cylinder. The depth of this locking recess gradually increases from rear to front, beginning at zero at the rear and terminating at the front end in a well, called the locking recess. When the block is withdrawn the inner end of the latch bolt drops into the locking recess and locks the block positively to the block carrier.

The gear segment is attached to the rear end of the breechblock by a spline and two screws. It consists essentially of a segment of a bevel gear and a short rack, which mesh with a pinion pivoted on the block carrier and actuated by the lever. Part of the periphery

of the pinion is cut into a bevel gear and another part into a pinion, meshing with the corresponding parts of the gear segment. The bevel-gear parts rotate the block and the rack-and-pinion parts translate it. These motions are successive; the termination of the motion of rotation in opening the breech brings the rack and pinion into the proper position to withdraw the block, and the termination of the motion of translation in closing the breech brings the bevel-gear segments into mesh to rotate it.

The block carrier is a steel casting pivoted by means of a hinge pin to a hinge plate attached to the jacket on the right side of the breech. As its name indicates, its principal office is to support the block in its various movements. It is bored to take the breechblock guide cylinder. On the front face of the carrier surrounding this bore is a projecting ring called the guide flange which enters the guide groove of the block and assists in supporting and guiding it. An annular groove, called the stop groove, cut in the front face of the carrier at the base of the guide flange, increases the length of the latter, and forms a stop against which the stop flange of the breechblock strikes, limiting the motion of the block to the rear.

A lug projects to the rear from the lower part of the block carrier and forms a seat for the pinion. The latter is mounted on this seat upon a pivot in the form of a screw bolt which passes through the pinion and screws into the lug. This screw-bolt pivot is prevented from unscrewing by the pivot nut which is screwed on it under the lug. The lever for actuating the pinion is fitted upon a square extension upon the latter. The free end of the lever terminates in a vertical handle.

The latch is a locking device for the block carrier. It consists of the lock bolt, latch spring, latch lever, and latch-lever pivot, mounted in the block carrier, and the latch-bolt seat and tripping stud secured to the breech face of the piece by screws. The latch bolt lies in a radial hole drilled through the block carrier. The end of the bolt nearer the axis of the block is tapered to facilitate its entering the locking recess in the breechblock guide cylinder. It is also slightly beveled on the end so that it will the more easily ride out of the locking recess and up the inclined bottom of the groove. The outer end of the bolt has a mortise cut through it in which one end of the latch lever works. This end of the latch bolt is also slightly beveled to make it ride out of the latch-bolt seat. The latch-bolt seat is a lug secured to the breech face by two screws. (There are a few guns in service having the latch-bolt seat and tripping stud in the form of screw

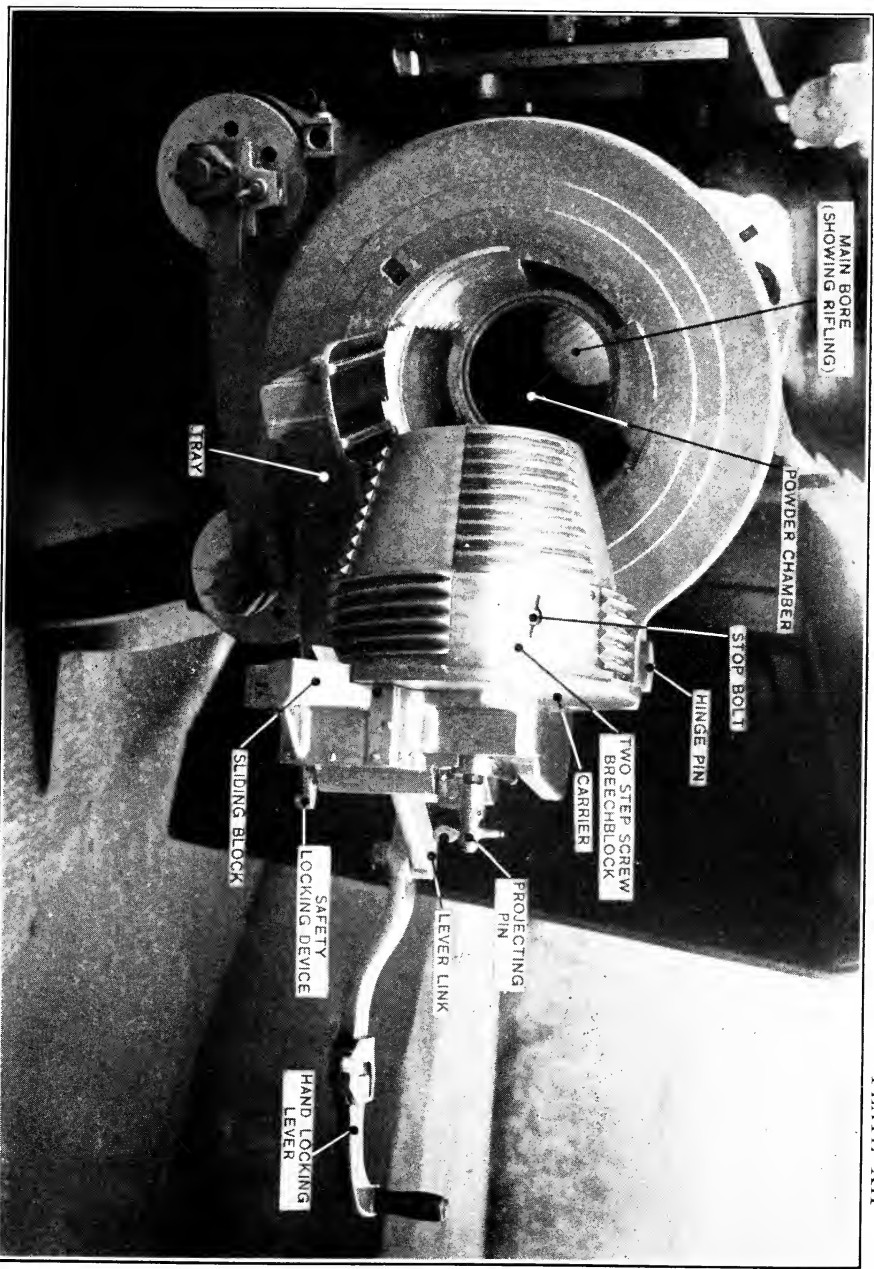

Breech Mechanism of 6-inch Q. F. Armstrong Gun, Model of 1898.



bolts screwed directly into the breech face of the piece.) Through it is drilled a radial hole into which the latch bolt enters when the carrier is against the breech of the piece.

The latch lever is pivoted in a circumferential slot cut in the exterior surface of the carrier. The latch-lever pivot is a small screw bolt inserted from the outer base of the carrier. One end of the lever works in the mortise in the latch bolt; the other end is broadened, forming a shoulder against which a spiral spring, called the latch-lever spring, bears. This spring is compressed between the block carrier and the latch-lever shoulder, by means of the tripping stud. This operation withdraws the latch bolt from the breechblock. When the block is swung away from the breech, the inner end of the latch bolt rests in the locking recess and locks the block to the carrier. In this position the upper end of the latch lever, against which the spring bears, projects slightly beyond the exterior surface of the carrier. In closing the breech, just before the carrier comes in contact with the breech face of the piece, this projecting part of the lever strikes the beveled surface of the tripping stud and is forced toward the axis of the block. This motion of the lever lifts the latch lock from the locking recess and leaves the block free to be translated through the block carrier.

The tripping stud is a lug secured to the breech face by two screws. Its inner face is beveled so as to trip the latch as just explained. The complete action of the latch is as follows: With the breech closed, the outer end of the latch bolt rests in the latch-bolt seat, locking the block carrier to the breech face; the inner end of the latch bolt bears against the guide cylinder of the block and, at the end of the motion of rotation of the block in opening the breech, rests in line with the end of the latch groove. When the block is withdrawn the bolt rides down the inclined bottom of the latch groove and its outer end is withdrawn from the latch-bolt seat, freeing the block carrier from the breech. At the end of the motion of withdrawal the inner end of the latch bolt enters the locking recess in the breechblock. As the bolt carrier is swung away from the piece the end of the latch lever clears the tripping stud so that the full force of the latch spring comes into play and the latch bolt is forced to the bottom of the locking recess, securely locking the block to the carrier. In closing the breech the action of the latch is the reverse of that just given.

With breech open the block is locked to the carrier. As the latter is swung against the breech face, the tripping stud, by means of the lever, raises the latch bolt far enough from the bottom of the latch-

groove locking recess for the end of the bolt to ride on the inclined bottom of the groove as the block is moved forward through the block carrier. As the bolt rides up the inclined bottom of the latch groove its outer end enters the latch-bolt seat and locks the block carrier to the breech face.

The obturator is composed of the following parts: The spindle, front and rear exterior split rings, interior split ring, pad, filling-in disk, spindle nut, and spindle-ball washer.

The object of the obturator is to prevent the escape of gas from the powder chamber to the rear during firing, and to transmit to the breechblock the stress of firing resulting from pressure of gases upon the bottom of the bore.

The spindle is mounted in the block in the spindle recess, the rear end of the stem is threaded for the spindle nut, while the front end is enlarged into a mushroom-shaped head which forms the bottom of the bore of the gun.

The vent is axial and is drilled through the spindle. A copper bushing, forced into an undercut in the face of the mushroom head, protects the vent from erosion and enables repairs to be easily made. In passing through this copper plug the vent is reduced in diameter, and the rear end of the vent is formed into a primer seat to take the primer used to ignite the charge.

The split rings are of steel accurately finished, and split diagonally through one side. The exterior ones are made of slightly greater diameter than the gas-check seat in the gun and are sprung into place. The interior one is slightly smaller than its seat on the spindle. The filling-in disk is a steel washer interposed between the gas-checking device and the front face of the breechblock. A slight shoulder on the rear face of the mushroom head supports and centers the front split ring. The rear split ring is similarly held by an offset on the front face of the filling-in disk.

The gas-check pad is a disk of asbestos and tallow, compressed under heavy pressure and covered with canvas. It forms a yielding medium for the transmission of pressure to the block. Under the pressure of firing the plastic nature of the pad causes it to press outward toward the gas-check seat and inward against the spindle, forcing the split rings firmly against their seats and completely stopping the passage of gas.

The spindle-ball washer consists of two steel rings with a groove cut in one face of each ring to form a pocket for twenty $\frac{3}{8}$ -inch hardened-steel balls. The rings with the balls between them are held together

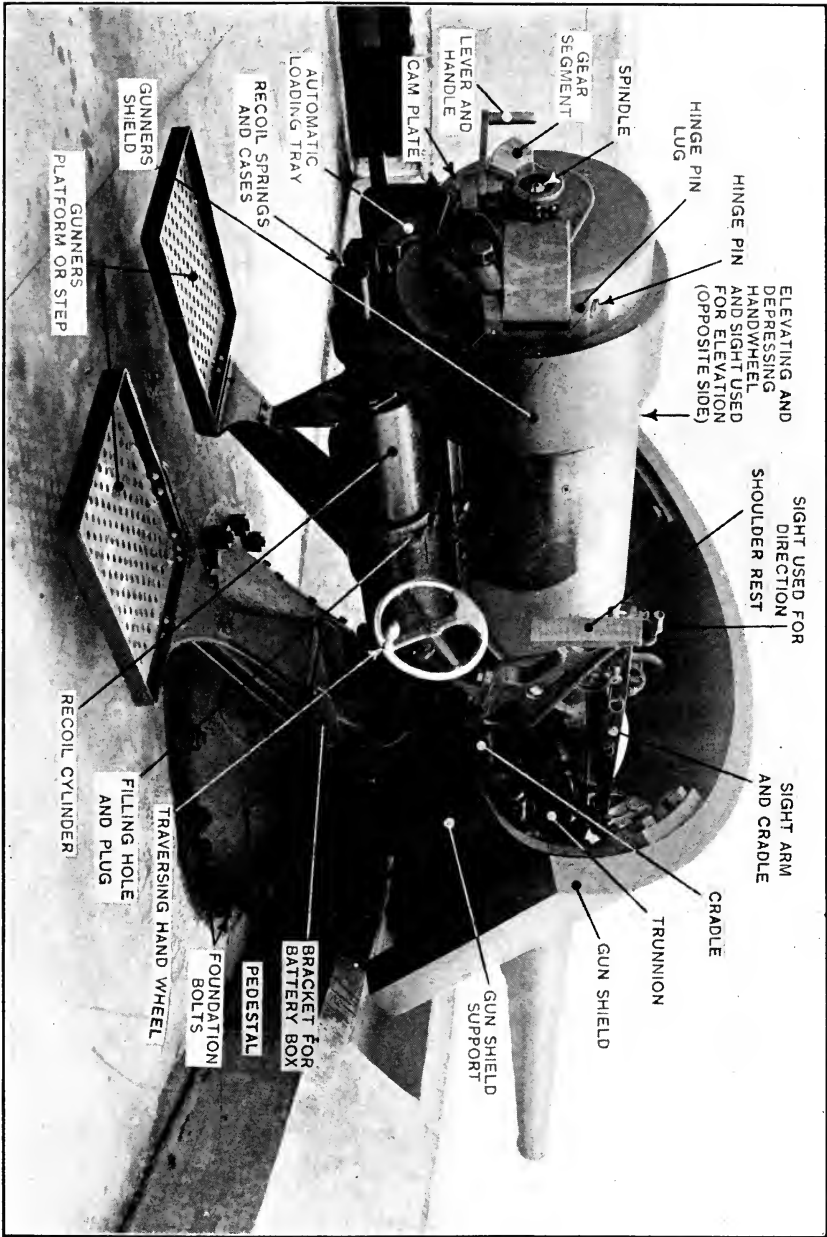

6-inch R. F. Gun, M. 1900. Barbette Carriage (Pedestal Mount).



LIBRARY
OF THE
UNIVERSITY
OF
CALIFORNIA

by a cylinder of $\frac{1}{32}$ -inch copper, which lines the bore of the rings and has its ends flanged outward over their end faces. The washer is interposed between the spindle nut and the breechblock and reduces the friction between them when the block is rotated.

The spindle nut is screwed on the rear end of the stem of the spindle, and holds the spindle in its position in the block. It is turned on the exterior, provided with a screw-driver slot, and plainly stamped to indicate direction of unscrewing.

The spindle key extends radially downward through the carrier and block, and its inner end enters a longitudinal slot cut in the stem of the spindle. It acts as a stop for limiting the rotation of the block, and also prevents the spindle from turning.

A slot is cut in the guide cylinder in which the key moves during the rotation of the block, and thus the firing mechanism is always held in an upright position.

To Open the Breech.—With the block closed the lever lies parallel to the face of the breech, with handle to the left. Moving the handle to the rear and right, describing an arc about the pinion pivot as a center, rotates the block through an angle of 45 degrees and disengages the threaded sectors on the block from those in the breech recess. A further movement of the handle about the same center draws the block to the rear until the stop flange strikes the bottom of the stop groove and the head of the latch bolt comes opposite the locking recess. This movement of the block to the rear frees the gas check from its seat in the gun sufficiently to enable the block, supported by the carrier, to be swung out of the recess and to one side of the piece about the block-carrier hinge pin as a center. At the end of the motion of withdrawal the outer end of the latch bolt is withdrawn from its seat, freeing the block carrier from the breech face of the gun so that a further motion of the lever handle to the right swings the block carrier and block away from the piece. During this movement the inner end of the latch bolt enters the locking recess in the block and locks the block in position in the block carrier.

To Close the Breech.—Move the lever handle to the left as far as it will go. The action of the various parts of the mechanism is the reverse of that given above. When the breech is open it will be noted that the block is locked to the block carrier and that, until it is unlocked, relative motion of the lever handle with reference to the block and carrier can not occur, so that the first movement of the lever handle to the left swings the block into its recess and the carrier against the face of the piece. The action of the latch now frees the block from the

carrier and locks the latter to the piece. Further motion of the lever handle first forces the block forward in the breech recess and then rotates it to its seat.

The movement of the lever handle to open or close the breech above described is one continuous motion.

To Remove and Dismount Breech Mechanism.—Detach firing cable from contact piece. Pull outward on slide stop and lift slide from housing. Rotate operating lever until it stands perpendicular to the face of the breech. Remove the yoke. The housing may then be withdrawn to the rear, bringing with it the safety lever. Open the breech. Remove the gear segment. Remove the breechblock stop. Take out the latch-lever pivot and remove the latch-lever spring and bolt. The block is then free to be removed from the carrier. Drive out the pivot pin and remove the pivot nut, unscrew the pivot and the pinion and lever are then free to be removed from the carrier. Drive out the hinge pin, being careful to support the carrier while doing so, and the carrier is then freed from the piece.

To Assemble the Breech Mechanism.—The operations are the reverse of those given above.

Total length 277.85 inches; weight 7.25 tons; length of bore 44.6 calibers. The bore has 36 grooves; twist, one turn in 50 calibers to one turn in 25 calibers.

The weight of the projectile is 106 pounds; weight of propelling charge, nitro-cellulose powder, 29.75 pounds; weight of bursting charge, Maximite or Explosive D, 4.3 pounds. Maximum pressure 38,000 pounds per square inch. Muzzle velocity 2,600 foot-seconds. Muzzle energy 4,973 foot-tons. Maximum elevation permitted by carriage 15 degrees; corresponding range 11,799 yards. Penetration in Krupp cemented armor, at 5,000 yards, 3.78 inches.

6-INCH RAPID-FIRE GUN, MODEL OF 1900

(See Plates XIII and XIV)

This rifle is of Ordnance Department manufacture. It is similar in construction to the model of 1897, and differs only in the following points: 2 A hoops. Powder chamber considerably larger in diameter and shorter in length. Thread of the breechblock cut in a breech bushing, instead of into the jacket.

This model of gun is made in two types, one for use on disappearing carriage and the other for rapid-fire carriage, the gun used on the former being slightly heavier than that used on the latter.

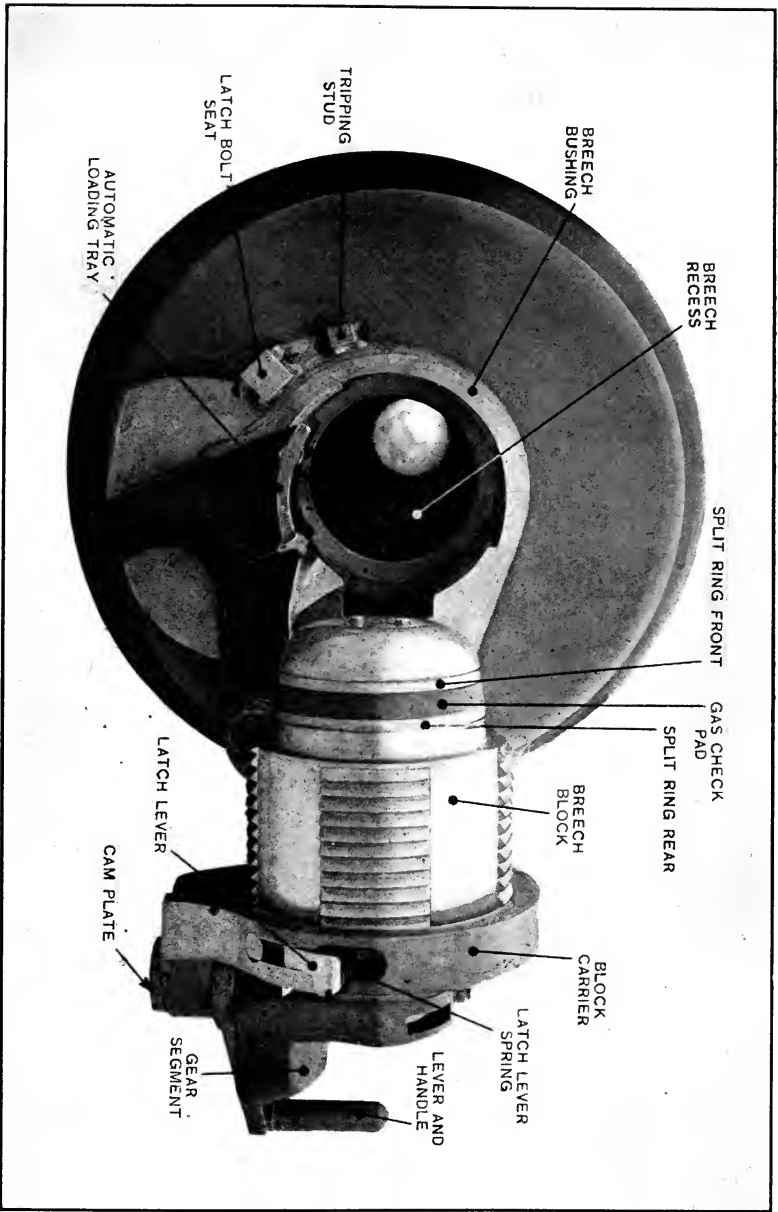

Breech Mechanism 6-inch R. F. Gun, M. 1900 (Open).



LIBRARY
OF THE
UNIVERSITY
OF
CALIFORNIA

Total length 310.4 inches; weight 8.5 tons; length of bore 50 calibers.

The powder chamber is cylindro-conical. The breech mechanism is the same as that of the model 1897 M1 excepting that the loading tray pivot has a solid head and is screwed into the breech face of the rifle.

Weight of propelling charge, nitro-cellulose powder, including igniter, 42 pounds; weight of bursting charge, Maximite or Explosive D, 4.3 pounds. Muzzle velocity, 2,600 foot-seconds. Muzzle energy 6,180 foot-tons. Maximum pressure 36,000 pounds per square inch. Maximum elevation permitted by carriage, 15 degrees; corresponding range, 13,077 yards. Penetration in Krupp cemented armor at 5,000 yards, 3.94 inches.

6-INCH RAPID-FIRE GUN, MODEL OF 1903

This rifle is practically identical in construction to the model of 1900, except in breech mechanism. It is slightly heavier for use on disappearing carriage.

The first guns of this model to be manufactured had the same number of grooves in the bore and the same twist of rifling as the model of 1897 M1. The later guns have 54 grooves, with a twist of rifling 0 to 1 in 25 calibers.

The breech mechanism consists of the breechblock, block carrier, operating spool, operating lever, rack, latch, obturator, loading tray and associate parts.

The breechblock is in the form of a truncated ogive with the interior hollowed out, forming a central cylindrical stem, which is prolonged beyond the rear face of the block. Through the center of the stem is an axial hole for the reception of the obturator spindle and obturator spring. The front part of the block for a short distance back is reduced in diameter, leaving a space in the breech recess of the gun in which fouling may collect without interrupting the working of the block. On the outer surface of the block is cut a screw thread with rounded top and bottom. The rear face of the thread is more inclined to the surface than the front thread. This screw thread is divided circumferentially into 12 equal parts, and the thread cut from alternate sectors. A stop groove is cut through the stem of the block to allow the spindle key to pass into the spindle groove. The spindle key thus serves the purpose of a breech block stop.

A roller is attached to the block by an axle screwed into the block. This roller works in the roller groove of the operating spool entering

the groove at the beginning of rotation in closing the breech, and remaining in the groove until the end of the rotation in opening the breech. The functions of the roller are to act as a lock to prevent the rotation of the block under firing pressure, to give the slow and powerful thrust to the block at the beginning of rotation in opening the breech, and a complete rotation of the block in closing the breech after the rack tooth disengages.

A translating groove is cut in the surface of the block. The translating stud on the opposite spool works in this groove, to cause a translation of the block. On the rear end of the breechblock stem are two teeth which engage the teeth of the rack to cause rotation of the breechblock.

The block carrier is pivoted by means of the hinge pin, to the hinge lugs of the hinge plate. It is provided with a central hub bored to take the stem of the breechblock.

A groove is cut in the inside of the hub to allow the teeth on the block stem to pass in assembling. A slot is cut through the hub to permit the spindle key to pass into the stop groove. The upper end of the spindle key is held in a slot cut in the upper part of the block carrier.

The firing lever passes through, and is pivoted in the same slot, the firing lever pivot passing through the spindle key, and holding it in place. On the rear face of the carrier a horizontal groove is formed to carry the rack. The slide stop is screwed into the top surface in the upper wall of the rack groove.

The operating spool is placed vertically between the two block-carrier hinge lugs. The hinge pin passes vertically through the center of the spool. That portion of the hinge pin within the spool is squared, causing the spool to rotate with the hinge pin. The roller groove is cut in the surface of the spool. The translating stud is formed on the surface of this spool. A groove is cut near the top of the spool for the upper latch stud. A notch is cut in the lower edge of the spool to receive the end of the latch body in locking together the spool and carrier while the block is swung away from the breech.

The operating lever fits over the squared end of the hinge pin, and is held in place by a nut. The breech mechanism is actuated by the operating lever acting through the operating spool. When the breech is closed, the operating lever lies against the face of the breech, and is held in this position by the lever latch. The lever latch consists of a bolt with vertical motion in a housing, and pressed downward by the lever-latch spring. The housing is attached to the breech plate by the housing screws. The downward motion of the latch bolt is

limited by a stud on its upper end, striking the ends of the groove in the housing in which the stud travels. When the operating lever is against the breech, the head of the bolt enters a corresponding depression in the top surface of the operating lever, holding the lever against the breech.

The rack has a horizontal motion in a groove in the rear face of the block carrier. A tooth on its inner end engages between teeth on the stem of the breech block. A lug on the outer end of the rack works in the rotating grooves in the spool. A housing is formed on the rear face of the rack for the rack lock. The rack-lock bolt has a vertical motion in this housing, and is pressed upward by a spring. A handle is screwed into the lower end of the rack-lock bolt. The upper motion of the bolt is limited by a shoulder on the handle striking the housing. The upper end of the bolt enters a slot in the side of the firing mechanism, causing the slide to move horizontally with the rack. By pulling down the handle the bolt is withdrawn from the notch in the slide, allowing the slide to operate independently of the rack.

The latch is housed in a notch cut through the lower hinge lug of the block carrier, and held in place by the latch retainer. A stud on the upper end of the latch rides in a groove cut in the operating spool, and actuates the slide. A similar stud rotates in the groove cut in the lower hinge plate lug. When the block carrier is against the breech, the lower stud rests in a vertical portion of the groove of the hinge-lug pallet, locking the carrier in position during rotation and translation of the block. In opening the breech, when the translation of the block is complete, the latch is elevated by the upper stud, causing the lower stud to rise onto the vertical groove and free the carrier from the face of the breech. At the same time the upper end of the body of the latch enters a notch cut in the operating spool, locking the spool and block carrier together while the block is swung away from the breech. The action of the latch in closing the breech is the reverse of that in opening. The latch retainer consists of a block of steel provided with a ring handle and a spring catch. It is inserted in the latch slot in the hinge lug, and holds the studs of the latch in their grooves. It is prevented from dropping out of the slide by the latch-retainer spring.

The principal parts of the obturator are the mushroom head, spindle, front and rear exterior split rings, interior split ring, pad, filling-in disk, and spindle spring. They operate in a manner similar to those described for other breech mechanism.

The loading tray provided remains in the breech recess at all times. The center section of the tray is cut away to a width equal to one

of the sectors of the breechblock, leaving a solid section of the same width on each side. A lip is formed on the front edge and one on the rear edge of the tray, extending downward. These lips rest in annular grooves in the breech recess, holding the tray in place when the breech is opened, and guiding the tray during its rotation with the breechblock. When the breech is open, the solid sections of the tray cover the two lower threaded sectors of the breech recess. The tray is prevented from being displaced laterally by a shoulder in the rear groove on the right side and by the loading-tray latch on the left side. The loading-tray latch consists of a bolt with radial motion in a hole bored through the gun, and pressed inward by a spring. When the breech is closed, the lower threaded sector of the block enters the solid sector of the tray. At the same time, the block bearing against the inner end of the tray-latch bolt forces it outward and frees the tray. During the rotation, the threaded sector of the block working in the slotted sector of the tray carries the tray upward to the left, uncovering the two lower threaded sectors of the breech recess to permit their engagement into their corresponding threaded sectors of the block.

To Open the Breech.—Grasp the handle of the operating lever, and carry it to the right. The roller causes the block to rotate until the rack tooth engages the teeth on the block stem. The remaining operations are the reverse of those described in closing the breech.

To Close the Breech.—Grasp the handle of the operating lever, and carry it to the left until the lever latch engages. The operating spool turns with the lever. During the first part of this motion, the latch body is entered in its notch in the spool, causing the block carrier to swing with the spool until the carrier strikes the breech. At this time the latch body drops out of its notch in the spool, freeing the spool from the carrier. The downward motion of the latch causes the lower latch stud to enter the vertical portion of the groove in the hinge-lock bolt, locking the carrier against the breech. As the spool continues to rotate, the translating stud enters the translating groove and the block is forced forward into the breech recess. At the end of the translation, the translating stud leaves the translating groove, freeing the spool for further rotation. The rack stud now enters the rotating groove and the rack is forced to the left, acting through the teeth to rotate the block to the right. Before the rotation of the block is complete, the racking tooth passes beyond the teeth on the stem of the block, the edge of the left tooth of the stem being faced off for this purpose. The roller, actuated by the cam shaped roller groove, then completes the rotation of the block. The lower part of the roller

groove is so shaped that the roller acts as a stop to prevent the block from rotating under firing pressure.

To Remove and Dismount Breech Mechanism.—Open the breech, withdraw the latch retainer and remove the latch. The breechblock is now free to be translated and rotated as if it were in the breech recess. Hold the block carrier and rotate the operating lever until translation of the block is completed. Remove the firing lever pivot pin and pivot. Lift the firing lever out of its slot in the block carrier. Lift the spindle key out of its slot in the block carrier. If the spindle key seems to stick, move the operating lever slightly to and fro until the key is free.

Continue the rotation of the operating lever until rotation of the block is completed. Detach firing cable from the firing-cable bracket. Support the housing of the firing mechanism, and with the wrench provided for the purpose rotate the mushroom head to the left until the housing is free from the spindle, when the housing may be withdrawn to the rear by holding down the rack-lock bolt.

Remove the spindle from the block and remove the spindle spring. The operating lever should now be rotated a short distance farther. This causes the teeth on the end of the stem to enter the groove provided for them in the hub of the carrier. The stem of the block may now be removed from the carrier. Slide the rack to the left out of its groove. Remove the hinge-pin nut and take off the operating lever. Support the block carrier and drive out the hinge pin, using a copper drift. The block carrier and operating spool are now free to be removed.

To remove the loading tray, press down on the tray-latch bolt and lift the tray from its place.

To dismount the lever latch, force the latch bolt upward until the stud is free of its groove. Turn the bolt 180 degrees until the stud points to the left, when the bolt may be lowered out of the housing, the stud passing through a groove cut in the housing for this purpose.

To Assemble the Breech Mechanism.—Place the hinge-lug bushing in its seat so that one of the diagonals of its rectangular interior will be perpendicular to the face of the breech. Place the carrier bushing in its seat so that one of the diagonals of its rectangular interior will lie in the plane of the carrier. Support the carrier so that its plane is perpendicular to the face of the breech, placing its lugs in position to receive the hinge pin. Place the spool between the lugs of the carrier, and turn so that the circular lower end of the roller groove faces the body of the carrier. Insert the hinge pin carefully, using no force

unless positive that the rectangular holes in the spool, hinge-lug bushing, and carrier bushing are in line.

Place the operating lever on the hinge pin so that the lever lies in the plane of the carrier and screw on the hinge-pin nut. Rotate the operating lever slightly to the left and enter the stem of the breech-block in the carrier until the roller enters the roller groove. Place the rack in its groove. Press the block toward the carrier, at the same time rotating the operating handle slightly to the right and entering the stud of the rack in the rotating groove.

Assemble the obturator and firing-mechanism housing, being careful to stop the rotation of the mushroom head when the ejector drops into its slot in the spindle. The slide must be assembled in the housing before the housing is assembled to the spindle. Rotate the operating lever until rotation of the block is completed.

Assemble the spindle key and firing lever; rotate the operating lever until translation of the block is completed. Insert the latch. On one end of the latch the dovetail projection from the latch retainer is cut away. This is the lower end of the latch. Assemble the latch retainer.

6-INCH RAPID-FIRE GUN, MODEL OF 1905

This is the latest type of 6-inch rifle and differs in construction from the model of 1903 only in the following points:

1 A hoop, which extends forward of the trunnion hoop and is locked to the D hoop by a locking hoop. Form of powder chamber cylindrical.

5-INCH RAPID-FIRE GUN, MODEL OF 1897

This gun follows the general method of built-up forged-steel construction. It consists of a tube, jacket, locking hoop, breech mechanism and associate parts.

The tube forms the bore and powder chamber, and is reinforced by the jacket and locking hoop. The method of assembling is similar to that of larger calibers. The object of the locking hoop is to lock the tube and jacket in place, thus preventing any backward movement of the jacket. It has a shoulder on its inner surface which bears against the front face of a corresponding shoulder on the tube just in front of the forward end of the jacket. The breech end of the jacket projects beyond the rear face of the tube and forms a recess which is threaded with a V-shape thread with rounded top and bottom, slotted for the interrupted screw mechanism; this forms the seat for the breechblock.

The powder chamber is cylindrical and has the breech end slightly enlarged to form a conical gas-check seat which permits the easy insertion and withdrawal of the gas-checking device. There is also a conical slope and forcing slope. The twist of rifling is increasing from one turn in 50 calibers to one in 25 calibers; there are 30 grooves in the bore.

The breech mechanism consists of the breechblock, gear segment, block carrier, lever, pinion, latch, obturator, and associate parts. The breechblock is cylindrical with an axial hole for the reception of the spindle and washer.

The front part of the block for a short distance is reduced in diameter; this allows a space in the breech recess of the gun in which fouling may collect without interruption to the working of the block.

The outer surface of the block has cut upon it a V-shaped screw thread with rounded top and bottom; this screw thread is divided into 8 equal parts and the threads are cut from alternate sectors. The sectors from which the threads are cut are called the slotted sectors; while those alternating with them are called the threaded sectors. The sectors from which the threads are cut permit the entry of the block past the corresponding threaded sectors in the breech recess. By revolving the block through an angle of 45 degrees with its longitudinal axis, the threaded sectors of the block are engaged with the threaded sectors of the recess. In order to provide sufficient clearance for the breechblock to swing away from the piece certain parts of the threaded and slotted sectors are cut away.

The rear end of the block is turned down to a smaller diameter, and the cylindrical surface thus formed is prolonged into the block and increased in length by means of an annular cut in the rear face of the block. This cylindrical surface is called the guide cylinder; the annular groove being called the guide groove of the block. That portion of the rear face of the block which lies outside of the guide groove is called the stop flange. When the block is withdrawn the stop flange strikes the bottom of the stop groove in the block carrier and limits the rearward motion of the block. The block is guided and supported in its motions of rotation and translation by the guide cylinder. The block is provided with four oil holes drilled radially from the exterior of the block to the bottom of the guide groove; this is to facilitate oiling of the bearing surfaces as well as acting as air vents.

A locking recess is cut in the surface of the guide cylinder gradually increasing in depth from rear to front; when the block is withdrawn

the inner end of the latch bolt drops into the locking recess and locks the block to the carrier.

The gear segment is attached to the rear end of the breechblock and consists essentially of a segment of beveled gear and a short rack, which mesh with a pinion pivoted on the block carrier and actuated by the lever. Part of the periphery of the pinion is cut into a beveled gear and another part into a pinion, meshing with the corresponding parts of the gear segment. The beveled gear part rotates the block and the rack and pinion parts translate. The termination of the motion of rotation in opening the breech brings the rack and pinion into the proper position to withdraw the block, and the end of the motion of translation in closing the breech brings the beveled gear segments into mesh and thus rotated.

The block carrier is a steel casting provided by means of a pivoted pin to a hinged plate attached to the jacket on the right side of the breech; its function is to support the block in its various movements.

For actuating the pinion, a lever is fitted on a squared extension of the lug; the free end of the lever terminates in a vertical handle.

The latch consists of the latch bolt, latch spring, latch lever and latch-lever pivot; which are mounted in the block carrier; and the latch-bolt seat and tripping stud, which are secured to the breech face of the piece by screws. The function of the latch is to lock the block to the carrier. When the block is swung away from the breech, the inner end of the latch bolt rests in the locking recess and locks the bolt to the carrier. In this position the upper end of the latch lever, against which the spring bears, projects slightly beyond the exterior surface of the carrier. When the breech is closed, just before the carrier comes in contact with the breech face of the piece, this projecting part of the lever strikes the beveled surface of the tripping stud and is forced toward the axis of the block. The lever lifts the latch bolt from the locking recess and the block is then free to be translated through the block carrier.

A summary of the complete action of the latch may be stated as follows: With the breech closed, the outer end of the latch bolt rests in the latch-bolt seat, locking the block carrier to the breech face of the gun; the inner end of the latch bolt bears against the guide cylinder of the block, and at the end of the motion of rotation of the block in opening the breech, rests in line with the end of the latch groove. When the block is withdrawn the bolt rides down the inclined bottom of the latch groove and its outer end is withdrawn from the latch-bolt seat, freeing the block carrier from the breech of the piece. At the end

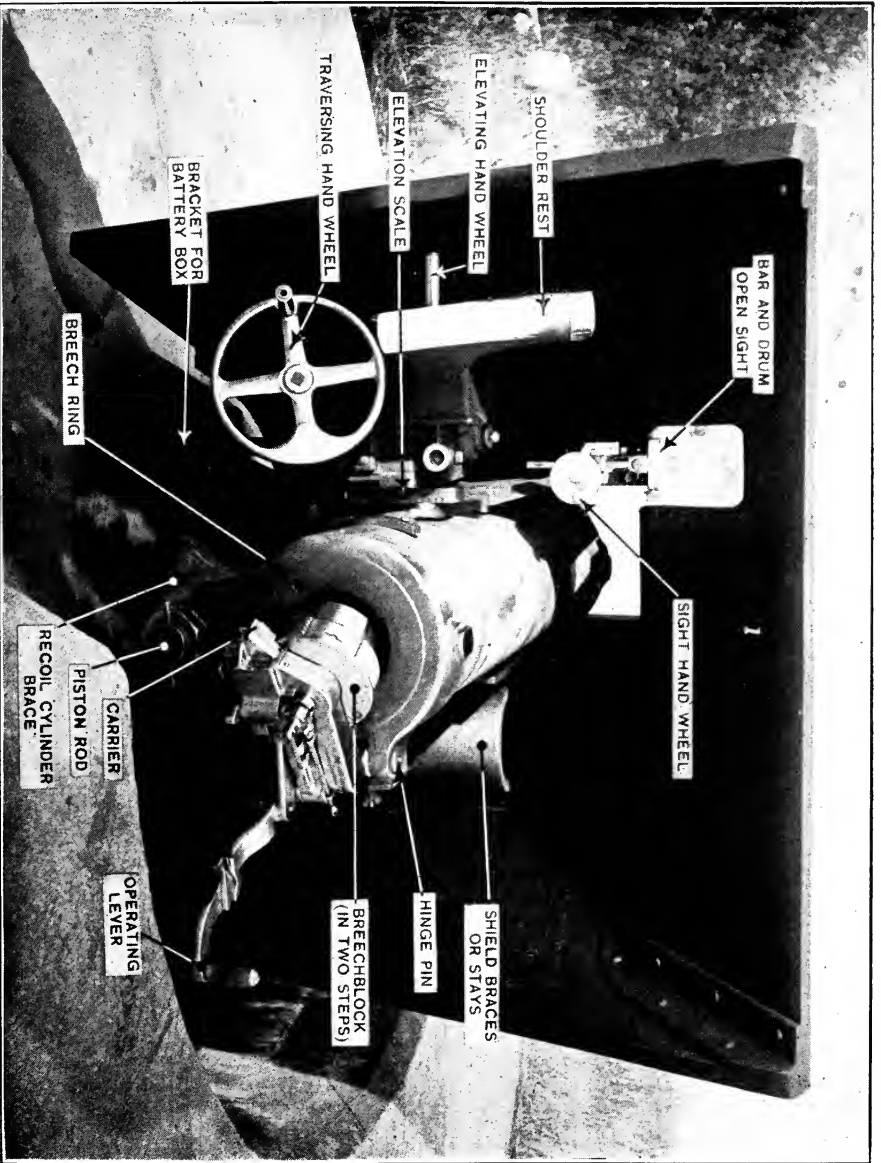

4.72-inch Q. F. Armstrong Gun, M. 1898., Barbette Carriage (Pedestal Mount).



of the motion of withdrawal the inner end of the latch bolt enters the locking recess in the breechblock. When the block carrier is swung away from the piece the end of the latch lever clears the tripping stud so that the full force of the latch spring comes into play, and the latch bolt is forced to the bottom of the locking recess, thus securely locking the block to the carrier. When the breech is closed the action of the latch is the reverse of that just given. With the breech open, the block is locked to the carrier. When the carrier is swung against the breech face of the piece, the tripping stud, by means of the lever, raises the latch bolt far enough from the bottom of the latch-groove locking recess for the end of the bolt to ride on the inclined bottom of the groove as the block is moved forward through the block carrier. As the bolt rides up the inclined bottom of the latch groove its outer end enters the latch-bolt seat and locks the block carrier to the breech face of the piece.

The obturator consists of the spindle, front and rear exterior split rings, interior split ring, pad, filling-in disk, spindle nut, and spindle-ball washer. Its purpose is to prevent the escape of gas from the powder chamber to the rear during firing, and to transmit to the breechblock the stress of firing resulting from the pressure of the gases upon the bottom of the bore.

The gas-check pad is a disk of asbestos and tallow, compressed under heavy pressure and covered with canvas. It forms a yielding medium for the transmission of pressure to the block, and under the pressure of firing the plastic nature of the pad causes it to press outward toward the gas-check seat and inward against the spindle, forcing the split rings firmly against their seats and completely stopping the passage of gas.

The spindle-ball washer consists of two steel rings with a groove cut in one face of each ring to form a pocket for twenty hardened-steel balls. The washer is interposed between the spindle nut and the breechblock for the purpose of reducing the friction between them when the block is rotated.

To Open the Breech.—When the block is closed the lever lies parallel to the face of the breech, with the handle to the left. Moving the handle to the rear and right rotates the block through an angle of 45 degrees and disengages the threaded sectors on the block from those in the breech recess. The further movement of the handle draws the block to the rear until the stop flange strikes the bottom of the stop groove and the head of the latch bolt comes opposite the locking recess. This movement of the block to the rear frees the

gas check from its seat in the gun sufficiently to enable the block, supported by the carrier, to be swung out of the recess and to one side of the piece about the block-carrier hinge pin as a center. At the end of the motion of withdrawal the outer end of the latch bolt is withdrawn from its seat, freeing the block carrier from the breech face of the gun so that a further motion of the lever handle to the right swings the block carrier and block away from the piece. During this movement the latch bolt has locked the block to the block carrier.

To Close the Breech.—The lever handle is moved to the left as far as it will go. The action of the various parts of the mechanism in closing the breech is the reverse of their action in opening it.

To Remove, Dismount and Assemble Breech Mechanism.—See method under 6-INCH R.-F. GUN, MODEL OF 1897 Ml.

Total length 231.6 inches; weight 7,583 pounds; length of bore 45 calibers; weight of projectile 58 pounds; weight of propelling charge, nitro-cellulose powder, 16½ pounds; weight of bursting charge, A.P. shell 2.3 pounds of gun cotton; C.I. shell 2 pounds of rifle powder; shrapnel .75 pounds of rifle powder.

Muzzle velocity 2,600 foot-seconds. Muzzle energy 2,721 foot-tons. Maximum pressure 38,000 pounds per square inch. Maximum elevation permitted by carriage 15 degrees; corresponding range 10,431 yards. Penetration in Krupp cemented armor, at 5,000 yards, 2.36 inches.

5-INCH RAPID-FIRE GUN, MODEL OF 1900

This rifle is similar in construction to the model of 1897, except that it has 2 A hoops, 2 C hoops, and 1 D hoop. The powder chamber is cylindro-conical.

The breech mechanism in this model has the guide groove tapered instead of cylindrical; there is no spindle key; the rotation of the block is limited by a breechblock stop; there is an automatic loading tray of bronze.

Total length 258.5 inches; weight 11,120 pounds; length of bore 50 calibers; weight of projectile .58 pounds; weight of propelling charge, nitro-cellulose powder, 26 pounds.

Muzzle velocity 2,600 foot-seconds. Muzzle energy 3,623 foot-tons. Maximum pressure 36,000 pounds per square inch. Maximum elevation permitted by the carriage 15 degrees; corresponding range 11,791 yards. Penetration in Krupp cemented armor, at 5,000 yards, 2.89 inches.

4.72-INCH QUICK-FIRING ARMSTRONG GUN, 50 CALIBERS

(See Plate XV)

This rifle follows the general method of built-up forged steel construction. It consists of a tube, jacket, and what in the service would be termed 2 C hoops, and 1 A hoop. In order to obtain great rapidity of fire a special mount is provided. The gun has no trunnions. It is carried in a cradle which encircles it and in which it slides when recoiling; this cradle is provided with trunnions upon which the gun and cradle are balanced. The powder chamber is conical. The breech is surrounded by a breech ring which has a projecting arm on it for connecting the gun with the recoil cylinder, which forms part of the cradle. The mechanism for closing the breech is of the interrupted screw type, so arranged that it can be quickly opened or closed by a single movement.

The breech mechanism is practically the same as 6-inch Armstrong rifle, except that it is smaller in dimension, and is of the screw form in two steps, the front step being tapered and of less diameter than the rear. Both steps have three portions of their threads removed, each one-sixth of a turn; the threads on one set standing opposite to the blank spaces on the other; this is done in order to distribute the strain all around the circumference of the breech screw. The interior of the gun at the breech is prepared in a similar manner and admits of the breech screw being swung into place and locked by a simple mechanism provided.

The breech screw is supported by a carrier on which it is free to revolve through an angle of 60 degrees; the carrier is hinged to the right side of the breech ring so that the screw can swing clear of the breech recess for loading. A stop bolt is provided for securing the carrier and the block together. A projecting pin is screwed into the rear face of the breechblock, and enters the traversing bush in the sliding block. This block slides in a seat in the carrier and is connected with the hand-locking lever by the link. The block is prevented from turning on the carrier when open by a spring catch which engages a notch in the block as it is withdrawn from the gun. When the breech is closed the catch comes in contact with the face of the gun, releases the block and allows it to be screwed home.

A safety gear consisting of a pawl and spindle, the pawl of which engages a lip on the striker and prevents the latter from touching

the primer until the block is completely closed and locked, makes it impossible to fire the gun until everything is safe.

To Open the Breech.—The breechblock is unscrewed and withdrawn from the gun by a single horizontal movement of the hand-locking lever, which is pivoted on the right side. A reverse movement completely closes and locks the block.

Total length 236 inches; weight 6,160 pounds; length of bore 49 calibers. The bore has 26 grooves, twist of rifling 1 turn in 600 calibers to one turn in 30 calibers. Weight of projectile 45 pounds; weight of propelling charge, nitro-cellulose powder, 8.2 pounds; cordite 10.5 pounds. Weight of bursting charge, strong head steel shell, 2 pounds of high explosive; steel shell 4.5 pounds of high explosive; cast iron shell 1.2 pounds of rifle powder; shrapnel .125 pound of rifle powder.

Muzzle velocity 2,600 foot-seconds. Muzzle energy 2,111 foot-tons. Maximum pressure 34,000 pounds per square inch. Maximum range 11,211 yards.

Penetration in Krupp cemented armor with uncapped projectile, at 5,000 yards, 1.3 inches.

4.72-INCH QUICK-FIRING ARMSTRONG GUN, 45 CALIBERS

This rifle is similar in construction to the 50-caliber model of the same make, with the following exceptions:

Total length 212.6 inches; weight 5,958 pounds; length of bore 44 calibers. Number of grooves in bore 26; twist of rifling increasing from 0 to 1 in 30 calibers. Weight of projectile 45 pounds; weight of propelling charge, nitro-cellulose powder, 8.2 pounds, cordite 10.5 pounds.

Muzzle velocity 2,570 foot-seconds. Muzzle energy 2,063 foot-tons. Maximum range 11,110 yards. Penetration in Krupp cemented armor with uncapped projectile, at 5,000 yards, 1.27 inches.

4.72-INCH QUICK-FIRING ARMSTRONG GUN, 40 CALIBERS

This rifle is similar in construction to the 50-caliber model of the same make, with the following exceptions:

Total length 194.1 inches; weight 4,648 pounds; length of bore 40 calibers. Number of grooves in bore 22; twist of rifling from one turn in 100 calibers to one turn in 34 calibers. Weight of propelling charge, nitro-cellulose powder, 7.5 pounds; cordite 5.5 pounds.

Muzzle velocity 2,150 foot-seconds. Muzzle energy 1,444 foot-tons. Maximum range 9,669 yards. Penetration in Krupp cemented armor with uncapped projectile, at 5,000 yards, 1.3 inches.

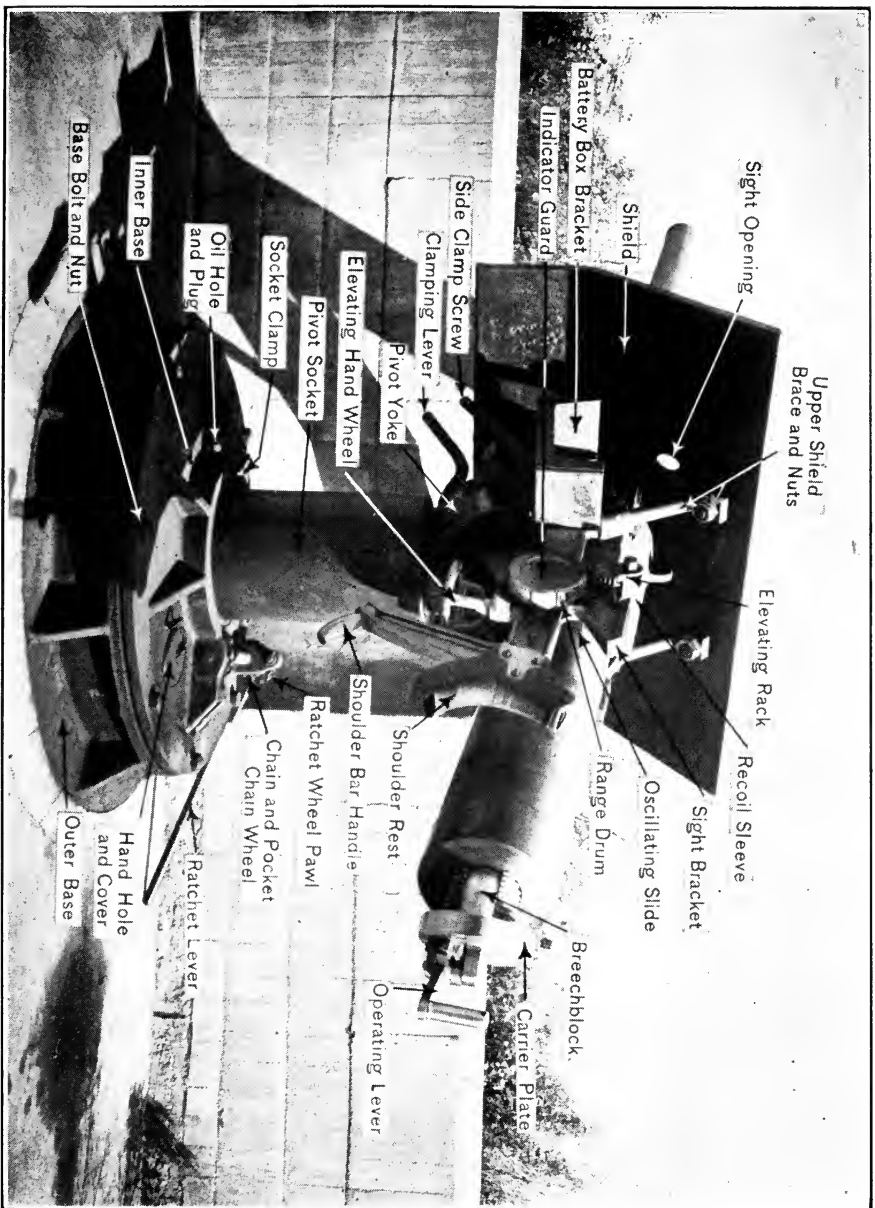

3-inch (15-pounder) Driggs-Seabury R. F. Gun, M. 1898. Barquette Carriage (Masking Parapet Mount).



LIBRARY
OF THE
UNIVERSITY
OF
CALIFORNIA

4-INCH RAPID-FIRE DRIGGS-SCHROEDER GUN

This rifle follows the general method of built-up forged-steel construction. Manufactured by the American Ordnance Company.

Total length 166.5 inches; weight 3,613 pounds; length of bore 40 calibers; twist of rifling 0 to 1 in 25 calibers; weight of projectile 33 pounds; weight of propelling charge, nitro-cellulose powder, 7.5 pounds; weight of bursting charge approximately 4.5 pounds of high explosive for shell, 2 pounds for strong-headed shell.

Muzzle velocity 2,300 foot-seconds. Muzzle energy 1,212 foot-tons. Maximum pressure 34,000 pounds per square inch. Maximum range 8,864 yards.

SECONDARY ARMAMENT

(See Plate XVI)

3-INCH (15-POUNDER) R. F. GUN, DRIGGS-SEABURY MODEL OF 1898

This rifle follows the general method of built-up forged-steel construction. Manufactured by the Driggs-Seabury Company. It consists of a tube, jacket, and breech bushing.

The breech mechanism (Figs. 14 and 15) consists of the block, the carrier plate, the carrier-plate ring and its screws, the block-locking spring, the operating lever and pin, the lever-catch plunger, spring and cotter pin, the firing pin and spring, the sear, the sear spring, the extractor, and the hinge pin.

The principal parts of the breechblock are three threaded sectors, three slotted sectors, the thread for the carrier ring, the operating-lever slots, the recess for the firing pin, the rotating stop, and the seat for the block-locking spring.

The thread is V-shaped, rounded at top and bottom, and for about $\frac{3}{4}$ inch in rear is continuous; the remainder is divided into six equal sectors, three threaded and three slotted. The continuous thread engages in that of the carrier-plate ring, and the threaded sectors engage those of the breech recess. The slotted sectors of both blocks and recess are cut away sufficiently to permit the block to enter the recess when swung about the hinge pin. The slot for the block-locking spring is so placed that when the threads of the block are disengaged from those of the breech recess the spring enters the slot of the locking block and carrier plate together.

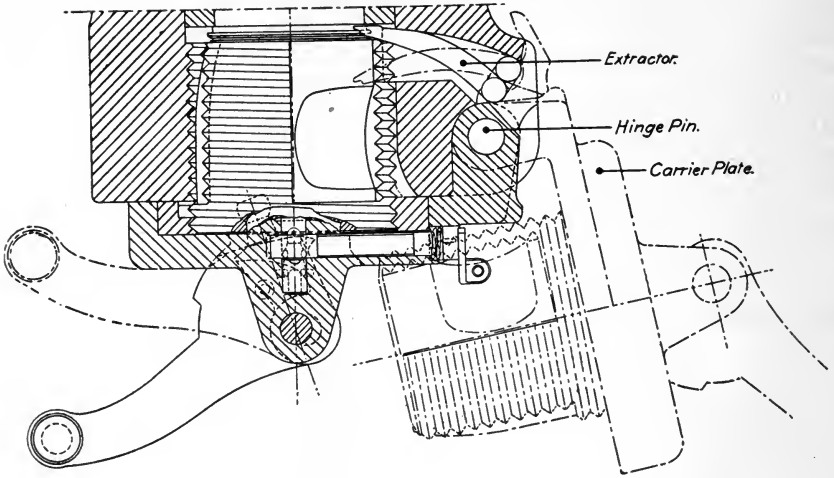

FIG. 14.

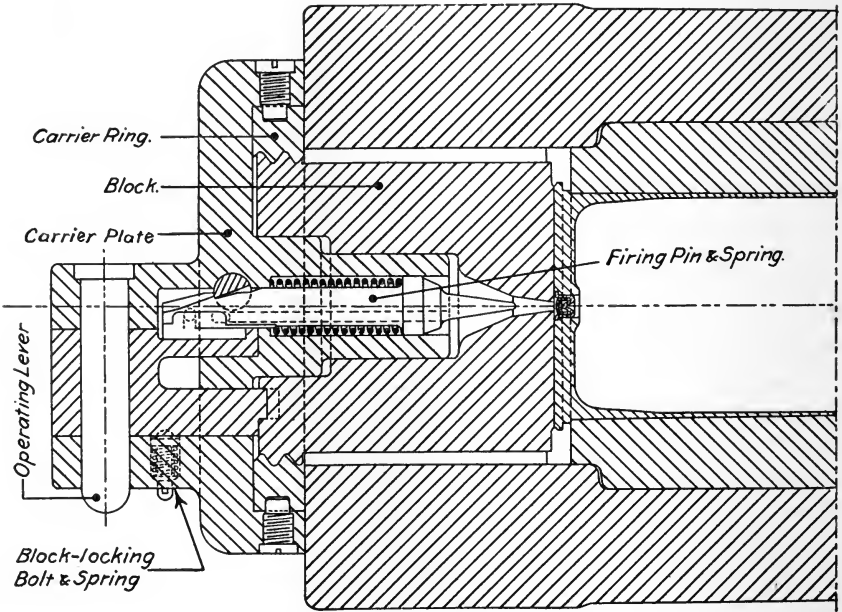

FIG. 15.

The carrier plate has a lug, at right angles to its face, through which passes the hinge pin, and which is so shaped as to operate the extractor in opening the breech. Two lugs, projecting from the rear face, carry the operating-lever pin, and the lower one also furnishes the seat for the lever-catch mechanism. A lug on the front face is bored out to receive the firing pin and its spring, and is assembled into the cavity of the block. The carrier plate is bored from the right-hand side to receive the sear and its spring. The rotating stop groove is annular, ends in a shoulder, and is cut in the front face of the carrier plate.

A slot for the operating lever is cut through the carrier plate, and another for the cocking toe is cut partly through. The front face of the carrier plate is counter-sunk to receive the carrier-plate ring, which is assembled to it by means of two screws, the holes for which are centered by a rib on the carrier plate and a corresponding groove on the carrier-plate ring.

The carrier-plate ring is threaded on its inner surface to receive the breechblock, and is assembled to the carrier plate by two screws. A groove in the front face seats the block-locking spring, has a rib part of its length, and ends at the interior of the ring in a recess for assembling the spring and for the seat of its locking lug. The threads are slightly cut away in two places to make a clearance for the operating lever.

The block-locking spring is assembled to the carrier-plate ring by means of a dovetail groove. At the lower end of the spring there is a lug that locks the block to the ring when the spring is not compressed; when it is compressed, one side of the lug on the spring forms a continuous surface with the thread of the ring, permitting rotation of the block.

For all guns after number 80 a modified form of block-locking bolt and spring is employed.

The locking bolt for securing the block to the carrier in the open position passes through the carrier-plate ring, being forced forward by its spring. When in the forward position a projection on the bolt enters a recess in the rear face of the block, locking it to the carrier. When the carrier is closed the locking bolt is forced to the rear and held there, its front end being in contact with the face of the breech.

The operating lever is assembled to lugs on the rear face of the carrier plate and consists of the lever proper, the operating knob, the cocking cam, the handle, the seat for the pin, and the seat for the lever-catch plunger. The lever passes through the carrier plate, the knob engaging in its seat in the block and forcing it to rotate when

the lever is turned about its pin. The cocking cam engages a lug on the firing pin and is so shaped that in opening the breech the pin is retracted until caught and held by the sear. The lever projects to the front sufficiently to form a locking lug that, by the final motion in closing, is seated in a groove in the rear face of the block, thus preventing rotation of the block due to pressure of the powder gas. The final movement of the lever in closing, and the first in opening, is perpendicular to the face of the plate, the pin hole being elliptical for the purpose. The seat for the lever-catch plunger is on the under side of the lever. The handle makes a right angle with the lever and is vertical.

The lever-catch plunger, with its spring, is assembled in the lower lever lug and is secured in place by the cotter pin passing through the lower end of the plunger. The mechanism prevents rotation of the handle during counter recoil.

The firing pin and spring are assembled in their seat in the carrier plate, the pin, when released, passing through an aperture in the front of the block. The pin has, at the rear end, a cocking lug and a notch for the engagement of the sear, and in front a shoulder for the spring. The spring is coiled around the pin and abuts against the shoulder on the pin in front and the carrier plate in rear.

The sear and its spring are assembled to the carrier plate in a seat bored parallel to the right-hand horizontal radius. The sear is so shaped at its inner end as to hold the firing pin in its retracted position, except when rotated upward. The outer end of the sear terminates in a short lever, carrying an eye for the lanyard; near this eye there is a seat for one end of the sear spring, the other end of which is secured in the carrier plate, the tendency of the spring being to keep the sear rotated downward.

The extractor passes through a slot in the right side of the jacket into the breech recess, is assembled to the jacket by two studs fitting into grooves, and is operated by a lug on the carrier plate, so shaped as to give the extractor a quick, lateral motion for the purpose of throwing the case clear of the breech. The hinge pin assembles the carrier plate to the jacket.

Action of Breech Mechanism.—Immediately after the gun has been fired the block threads engage those of the breech recess, the operating lever is against the carrier plate, the locking lug on the lever is seated in its groove in the block, the lever-catch plunger is in its seat, the firing pin is forward against the primer, and the block-locking spring lug forms a part of the carrier-ring thread.

To Open the Breech.—Rotate the handle to the right until the carrier comes to rest against the jacket. At the beginning of the movement to open the breech, the locking lug on the lever is withdrawn from its seat, the knob causes the block to rotate from left to right until the threaded sectors are disengaged from those of the breech recess, the stop on the block strikes the shoulder of its seat when this disengagement is complete, and the block swings clear of the breech recess. During the rotation of the lever the cocking cam retracts the firing pin, which is then held by the sear. As soon as the carrier has moved far enough from the face of the breech, the block-locking spring is released and locks the block to the ring.

To Close the Breech.—Rotate the handle to the left until the lever brings up against the carrier plate. The block-locking spring is compressed by striking the breech, and then the action of the mechanism is that of opening, reversed, except that the firing pin is not affected. For drill purposes an empty cartridge case should be inserted in the chamber, as otherwise, unless care is taken that the operating lever is left firmly against the breech after closing, snapping the lock is liable to break the firing pin.

To Assemble the Breech Mechanism.—Seat the extractor. Put the carrier plate in position and insert the hinge pin. Put the lever-catch plunger spring in its seat, insert the plunger, press it down, and enter the cotter pin. Seat the block-locking spring in the carrier ring. Place the carrier ring in the carrier plate and insert the securing screws. Close the carrier plate until it rests against the breech of the gun. Insert the sear and its spring, guiding the end of the latter into its seat in the carrier plate. Assemble the firing-pin spring to the pin. Swing the carrier plate away from the breech, seat the firing pin in the stem of the plate, keeping the guide rib downward, and compress the spring until the pin is held by the sear. A block of wood should be used against the point of the pin in compressing the spring.

Place the breechblock on the stem of the carrier plate, compress the block-locking spring, and rotate the block to the left until the stop comes in contact with the shoulder of its groove in the carrier plate. Release the block-locking spring. Place the operating lever in position and insert the lever pin. Close the breech.

To Dismount the Breech Mechanism.—Reverse the operations of assembling, being sure that the firing pin is cocked before beginning.

The other parts of the breech mechanism, except the extractor, may be first assembled to the carrier plate and then the whole assembled

to the gun; dismounting may be similarly effected by first removing the mechanism as a whole.

Total length 154.5 inches; weight 1,782 pounds; length of bore 50 calibers. The bore has 24 grooves; twist of rifling 1 in 50 to 1 in 25 calibers. Weight of projectile, shot, shell, or shrapnel, 15 pounds; weight of propelling charge, nitro-cellulose powder, 5 pounds.

Muzzle velocity 2,600 foot-seconds. Muzzle energy 703.8 foot-tons. Maximum pressure 34,000 pounds per square inch. Maximum elevation permitted by carriage 12 degrees, corresponding range 7,849 yards. Penetration in Krupp cemented armor, at 5,000 yards, uncapped projectile, .77 of an inch.

3-INCH (15-POUNDER) RAPID-FIRE GUN, MODEL OF 1902

(See Plate XVII)

This rifle follows the general method of built-up forged-steel construction. It consists of a tube, jacket, hoop, breech mechanism, etc. The tube is enveloped by a jacket and hoop for a distance of 84 inches from the breech end.

The breech mechanism consists principally of the block, carrier plate, latch, carrier hub, operating lever, link extractor and firing mechanism.

The block is cylindrical in form, 4.4 inches long, 5.7 inches in exterior diameter, except at the rear end, where there is a collar with an exterior diameter of 6.7 inches. The part in front of the collar consists of four threaded and four slotted sectors of about equal area. The metal in each of these sectors is cut away sufficiently to allow the block to swing clear of its recess. A boss on the rear face of the block forms a seat for the link pivot. A stud screwed into the rear face of the block, carrying an insulated copper plug, forms half of the circuit breaker for the electric firing mechanism. The block is bored axially to a diameter of 2.5 inches, and a depth of 2.4 inches from the rear face. The bore is continued through the block on a diameter of 4.69 inches, and the front end being counter-bored to a diameter of 2.1 inches. The bore in the front end is threaded and a plug having an axial hole for the firing pin is screwed into it. A spline screw prevents this plug from turning. The larger diameter bore at the rear end is also threaded, the thread being rectangular in form, and having the same pitch as that on the exterior of the breechblock. A slot on the left-hand side of this bore allows for movement of the breaker when the block is in its closed position. A notch in the collar of the block forms a seat for the latch when the block is locked to the carrier.



LIBRARY
OF THE
UNIVERSITY
OF
CALIFORNIA

The carrier consists of a steel plate having a lug for the hinge pin at right angles to its face. This lug is so shaped as to operate the extractor when the breech is opened. The plate is bored and threaded the same as the interior of the block, and on line with the axis of the gun when the breech is closed.

The latch locks the block to the carrier when its threads are disengaged from those of the breech recess, and locks the carrier to the gun when the threads of the block are engaged or partly engaged with those of the breech recess. When the carrier is being closed against the breech of the gun, an inclined face on the latch slides against a similar face on the recess in the breech of the gun, withdrawing the latch from the notch in the collar of the breechblock, and allowing the block to rotate. At the same time, a lug on the latch is forced into an undercut part of the recess in the breech of the gun, and held there by the collar of the breechblock, thus locking the carrier to the gun.

The carrier hub is a bronze cylinder with rectangular head at the rear end. It forms the connection between the breechblock and the carrier, and contains the firing mechanism complete.

The firing mechanism is of the type known as continuous-pull percussion, combined with electric. It consists of the following parts: Firing pin with insulation, firing-pin sleeve, firing-pin guide and firing-pin shoulder, firing-pin spring, pin and breaker pin, cocking link and stud, cocking-stud block. For electric firing, when the block is closed, the firing pin projects about $5/100$ inch, or enough to make contact with the primer. The firing pin is completely insulated, and is connected with the circuit breaker by an insulated cable with standard connections.

Action of the firing mechanism is as follows: Supposing the gun to be loaded and the block closed. The firing-pin guide is pressed forward by the firing-pin spring against the front firing-pin shoulder. The firing pin is thus pressed forward against the primer. The connection is now complete for electric firing. Unless held back by the primer, the projection of the firing pin in this position is about $5/100$ inch. For percussion firing the breaker is pulled to the rear until the cocking piece is left from the firing-pin sleeve. In this movement, the firing pin is pulled to the rear about $8/10$ inch. When released, the spring drives it forward until the firing-pin guide strikes the breechblock plug. The inertia of the firing pin and sleeve then carries them $1/10$ inch further forward. Total projection of the firing pin in percussion firing is $15/100$ inch.

The operating lever of the breech mechanism is hinged to the block-carrier hinge pin. It is connected to the block by a single link with

the hinge pivots in the block and lever. A latch fitting in a seat in the link pivot in the breechblock locks the lever when the block is closed.

The extractor is hinged on a pin through the lugs on the right-hand side of the gun. The rear end of the tube is slotted to allow for increased thickness of the inner arm of the extractor. This inner arm grasps the rim of the cartridge case. The outer arm has a cammed surface against which another cammed surface on the carrier plate slides when the latter is opened. These two cammed surfaces are so shaped as to give the extractor an accelerated movement which ejects the cartridge case clear of the gun.

To Open the Breech.—Rotate the handle to the right until the carrier plate comes to rest against the extractor. By this movement the lever-latch plunger is withdrawn from its seat, thereby allowing a further pull on the lever to rotate the block contra-clockwise by means of the link through an angle of 45 degrees. The threads of the block are now disengaged from those of the breech recess. The block latch is situated in its notch in the collar of the breechblock, thereby locking the carrier plate to the breechblock and enabling one by further pulling on the lever handle to swing the block clear of the breech recess. During the rotation of the block the cam on the breechblock plug retracts the firing pin by means of the lock on the firing-pin sleeve. When the rear of the carrier plate strikes the extractor, its inner arm is caused to move to the rear, thus extracting the cartridge case.

To Close the Breech.—Rotate the handle to the left until the lever latch seats itself and further motion is impossible. During this operation the latch recess in the breech of the gun draws the latch out of its notch in the block, thereby allowing the block to be rotated in a clockwise direction. The latch then locks the carrier to the gun, and is prevented from unseating itself by the collar of the block.

To Assemble the Breech Mechanism.—First assemble the latch and spring to the carrier plate, then the extractor and carrier plate to the gun. In putting in the carrier-plate hinge pin, the carrier should be made to turn the carrier plate so that an arrow marked on it comes opposite a corresponding arrow marked on the gun. Assemble the insulation on the firing pin, then put the front shoulder over the insulation and the firing-pin guide over the front shoulder, the rear shoulder and firing-pin spring on the firing-pin sleeve, and then slip the sleeve over the firing-pin insulation. The insulation washer, nut and taper pin on the rear are placed to the rear end of the firing pin. The breaker, with spring pin and cocking link are assembled to the

carrier hub. Screw the carrier hub into the carrier plate until its front end is flush with the front face of the plate. Push the assembled firing pin to its place in the front end of the carrier hub, at the same time pulling back on the breaker. Hold the breechblock in the closed position against the front face of the carrier plate. In this position screw the carrier hub to its seat and tighten the locking screw. The operating lever and link are assembled and the block rotated until the latch locks it to the carrier plate.

To Dismount the Breech Mechanism.—The operations for dismounting the breech mechanism are the reverse to those given above for assembling it.

Total length 154.35 inches; weight 1,950 pounds; length of bore 50 calibers. Fixed ammunition is used; also projectiles as described for the Driggs-Seabury gun.

3-INCH (15-POUNDER) RAPID-FIRE GUN, MODEL OF 1903

This rifle is of Ordnance Department manufacture and corresponds to the Bethlehem Model of 1902, except in power.

Total length 170 inches; weight 2,692 pounds; length of bore 55 calibers; weight of projectile 15 pounds; weight of propelling charge, nitro-cellulose powder, 6.06 pounds.

Muzzle velocity 3,000 foot-seconds. Muzzle energy 935.8 foot-tons. Maximum pressure 41,000 pounds per square inch. Penetration in Krupp cemented armor, at 5,000 yards, with uncapped projectile, .85 of an inch.

2.24-INCH (6-POUNDER) R. F. GUN, DRIGGS-SEABURY MODEL OF 1898

This rifle follows the general method of built-up forged-steel construction. It consists of a tube, jacket, hoop and breech mechanism. The tube is enveloped by the jacket and hoop for a distance of about 52 inches from the breech end, the two being locked together by a bronze sleeve screwed on and locked in place.

The sleeve is machined so as to form upon each side of its exterior two parallel bearing surfaces by which the gun is supported in the mount.

MECHANISM OF THE GUN

The jacket extends beyond the rear end of the tube far enough to form a breech recess and is cut away at the bottom to receive the block.

The bore is composed of a cartridge seat, forcing slope and main bore. There are 24 grooves in the first six guns manufactured and 18 grooves in the others. The twist of rifling is from 0 to 1 turn in 25.8 calibers at the muzzle.

The breech recess is cut away at the top to form two steps against which corresponding projections on the block abut, and on each side to receive the operating lugs and the pivots of the extractor. The end of the tube is cut away also to receive the arms of the extractor. A hole is drilled through each cheek for the operating shaft.

The breech mechanism (known as the drop-block system) consists of the block, operating shaft, cam sleeve, locking spring, extractor, percussion-firing lock, operating handle and associate parts.

On the top of the breechblock are formed two locking shoulders arranged in steps, and on its sides two operating lugs and rotating stops, on the lower side of which the extractor-cam surface is formed.

The block is drilled through transversely for the insertion of the operating-cam sleeve and an axial seat is formed in the rear for the firing lock. The locking shoulders engage against the steps at the top of the breech recess; the under surfaces of the operating lugs are in contact with the cams of the sleeve while the upper surfaces bear against the top of the slots in the sides of the breech recess.

The rotating stops limit the rotation of the operating shaft to the rear and are partly cut away to clear the jacket when the breech is open. The extractor-cam surface is so shaped as to give a throw to the extractor at the end of its movement.

The seat for the firing lock is cylindrical except at the forward end, where it is shaped for the passage of the point of the firing pin; the rear end is counter bored to a larger diameter and threaded to receive the firing lock.

A seat for the pin of the bracket-locking spring is cut in the rear face of the block.

The operating shaft is mainly cylindrical with a journal at the right end and another near the left. Adjoining these journals on the inside the shaft is made hexagonal to fit corresponding seats in the sleeve. There is a slot for the locking spring, also for the key on the inside of the handle; the slot is wider than the key. This permits a small amount of rotation of the handle around the shaft.

The cam sleeve consists of two cams joined by a hollow cylinder. The interior of each end is made hexagonal to fit the operating shaft, and the cams are shaped to act with the operating lugs of the block.

The operating handle is a hollow rod with a lug at one end bored

out to receive the left end of the operating shaft. A key let into the lug works in the corresponding slot in the operating shaft and a short slot is cut on the right or inner face of the lug for the seat of a lug on the locking spring.

The locking spring is a steel bar with two lugs on one side and a third at the outer end. This last secures the operating handle; the next one, in conjunction with the handle, operates the spring and locks the shaft to the jacket, while the third serves to lock the shaft in the gun.

The extractor is roughly Y-shaped. Two flanges on the arms engage the rim of the cartridge case, the stem forms the toe by which the extractor is operated, and two pivot lugs serve to support the extractor in the jacket.

The percussion-firing lock is called a continuous-pull firing mechanism; that is, one in which the pull on the lanyard first compresses the firing spring and then releases it, allowing the spring to drive forward the pin. It consists of the firing pin, the pawl, the firing spring, the bracket bearing, the trigger, the trigger spring, and the bracket-locking spring.

The firing pin is mainly cylindrical, with the taper point and a shoulder in front and a flattened section in rear. A slot for assembling the firing pin to the bracket bearing is cut just forward of the flattened portion, a small hole is drilled in rear of the head of the firing pin to hold the end of the firing-pin spring, six longitudinal grooves are cut in the head for gas vents and two holes are drilled through the flattened section, one for the pivot to which the pawl is assembled and the other for the lanyard.

The pawl is slotted to fit the rear of the firing pin and has a pivot hole and a seat for a small pin. The firing spring is a coiled steel-wire spring that abuts against the head of the firing pin in front and the bracket bearing in rear. The front end is seated in a small hole in the pin and the rear is held between the bracket and a shoulder in a counterbore in the block. The bracket-bearing screws into the block, closing the firing-pin cavity, and serving as a support for the rear of the firing pin. It also carries an arm upon which the firing trigger is pivoted. It is provided with a pin, which, working on a longitudinal slot in the firing pin, prevents the latter from turning. On its rear face is riveted the bracket-locking spring, a leaf spring formed in a half circle and carrying at its end a pin which is pressed into a seat in the block when the bracket is screwed home.

The trigger is an arm pivoted on the bracket bearing and carrying

the cocking toe. Near the upper end a hole for attaching the lanyard is drilled, and below this it is slotted for the stop pin on the pawl. The trigger spring is of coiled steel wire assembled around the trigger pivot, having one end in the bracket arm and the other in the trigger. Its function is to force the trigger to the front or normal position after firing.

Action of the Breech Mechanism.—Immediately after firing, the block is in its seat in the breech recess, the operating handle is to the front, the lugs on the locking spring are in their seats in the handle and the jacket, the operating lugs on the block are supported in the vertical portions of their slots by the cams on the cam sleeve, the flanges of the extractor engage the rim of the case, the pivot lugs of the extractor are in the rear part of their slots, the point of the firing pin is flush with the front face of the block, and the cocking toe is forward of the pawl.

To Open the Breech.—Rotate the handle to the rear. During the first part of this movement the handle rotates about the shaft, compressing the locking spring and releasing the lug from its seat in the jacket; then the operating shaft and cam sleeve rotate together to the rear, and the cams are moved so as to permit the operating lugs, and consequently the block, to descend until the latter is disengaged from the shoulder at the top of the breech recess; (if the block does not descend by its own weight, the operating cams bearing on tops of the rotating stops force it down.) In this position the cams abut against the rotating stops and cause the block to rotate with the operating shaft until stopped by the flanges at the bottom of the breech recess between the checks of the jacket. During the rotation of the block the extractor cam surface strikes the stem of the extractor and forces the pivot lugs forward in their slots, causing the arms of the extractor to move to the rear sufficiently to loosen the case in its seat; when the pivot lugs bring up against the shoulder of the slots, the cam surface continuing to act rotates the extractor about the lugs, giving a quick throw that fully ejects the case.

To Close the Breech.—Rotate the handle smartly to the front until it comes to a stop. The action of the mechanism is the reverse of opening.

To Fire the Gun.—Insert the hook of the lanyard in the eye of the trigger and pull until the firing pin is released. The cocking toe, except when forced to the rear, is constrained by the trigger spring to remain against the face of the bracket bearing, forward of the pawl, so that when the trigger is pulled, carrying the toe to the rear, the

pawl and consequently the firing pin go with it. As the toe rotates while the pawl is forced to move in a straight line, the latter is released when it has been retracted about $\frac{3}{4}$ inch, and moving forward under the action of the spring, the pin impinges against the primer. When the tension on the lanyard is released the trigger moves forward, under the action of its spring, until the toe strikes the bracket bearing. In this movement the pawl is first rotated by the toe, clearing the latter, and afterwards rotated back by its pin, passing into the slot in the trigger arm. The firing toe and pawl are thus again ready for firing. The point of the firing pin is kept normally flush with the front face of the block, because the firing-pin spring, being fastened at both ends and properly adjusted, works in both directions and holds the pin in that position. In firing, the momentum given the pin by the spring carries it beyond its point of rest with sufficient force to explode the primer.

In case the firing toe does not engage the pawl, rotate the pawl to the front with the hand. The gun may be fired, in case the trigger becomes injured, by attaching the lanyard directly to the eye of the firing pin. In case of a misfire additional blows may be given the primer by slacking on the lanyard to allow the toe to again engage the pawl.

To Assemble the Breech Mechanism.—The shoulder bar being out, put the block in place from below, and hold it firmly against the top of the breech recess; insert the extractor, arms upward, flanges next to the tube, and engage the pivot lugs in their slots; lower the block, let go the extractor, and incline the block so that the cam-sleeve seat is clear. Place the cam sleeve in position, larger end to the left, so that the cams lie between the operating lugs and the rotating stops; keeping a rearward pressure on the cam sleeve as long as possible, move the block slowly into the open position; by a pressure underneath the block, line up the holes for the operating shaft; place the locking spring in its slot in the operating shaft and seat the latter, keeping the slot on top, and compressing the spring; put on the operating handle, partly close the block, and screw the firing lock home until the pin of the locking spring enters its seat; close the breech; the handle should then point to the front and be nearly parallel to the axis of the bore. The firing lock is furnished assembled.

To Dismount the Breech Mechanism.—Reverse the operation of assembling. The locking spring must be compressed until its locking lug is free from the circumferential slot in the left cheek of the gun; the block should be supported by the hand while the shaft is being

driven out. For this operation use a piece of wood or a copper drift.

Sights.—Telescopic sights have been issued with some of these guns and mounts. When so issued they are placed, when in use, upon a sight bracket which is fastened to the right trunnion of the oscillating slide of the mount. Such brackets are attached to all mounts of the modification of this model.

Total length 118.12 inches; weight 845 pounds; length of bore 50 calibers; weight of projectile 6 pounds; weight of charge, nitro-cellulose powder, 1.35 pounds; nitroglycerine 1.25 pounds.

Muzzle velocity 2,400 foot-seconds. Muzzle energy 240 foot-tons. Maximum pressure 37,460 pounds per square inch. Penetration in Krupp cemented armor .4 inch.

2.24-INCH (6-POUNDER) R. F. GUN, DRIGGS-SEABURY MODEL OF 1900

(See Fig. 16)

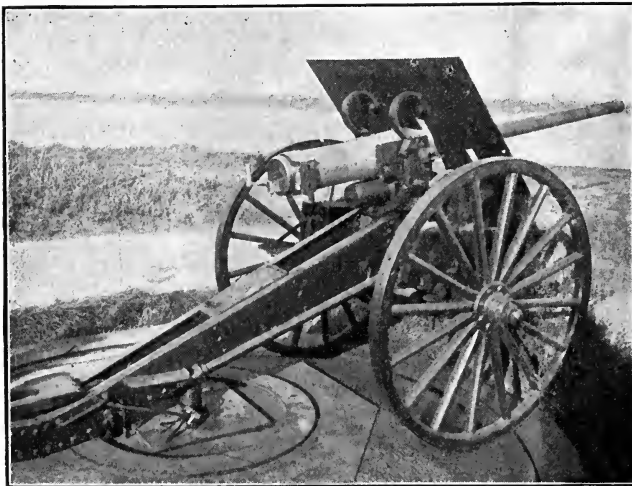

FIG. 16.—2.24-inch (6-pounder) R. F., D.-S. Gun, M. 1900. Interrupted Thread Breech Mechanism. Mounted on Wheeled Mount.

This rifle is essentially the same as the model of 1898, except that the breech recess in the jacket is differently shaped and is threaded and slotted to accommodate the interrupted-thread mechanism.

MECHANISM OF THE GUN

The breech mechanism (known as the interrupted-thread system) consists of the block, carrier plate and ring, operating lever, hinge pin, lever pin, firing mechanism, locking bolt and spring, extractor, and associate parts.

The breechblock has two full threads at the rear end on which the carrier-plate ring is screwed. In front of these there are three threaded and three interrupted sectors. The interior of the block is hollowed out to receive the hub of the carrier plate which carries the firing mechanism. The front end of this cavity is conical, corresponding in shape to the head of the firing pin, and serves as a stop to limit the forward movement of the pin. A small safety screw, inserted from the front face of the block, projects into this cavity. Its function is described in connection with the description of the firing pin. A cylindrical projection on the rear face of the block forms a stop which, rotating in a limited annular groove in the front face of the carrier plate, limits the rotation of the block.

The carrier plate carries all the mechanism for operating the block and the firing mechanism. It is hinged to lugs on the gun and has two projecting lugs on its rear face to which the operating lever is hinged. On the front face is a projecting hub which supports the block and within which the firing pin and mechanism are placed. On its front there is also a counterbored seat in which the carrier-plate ring is set and secured by two screws.

A bolt for locking the block to the carrier in the open position passes through the carrier-plate ring, being forced forward by its spring. When in the forward position a projection on the bolt enters a recess in the block, locking it to the carrier. When the carrier is closed the bolt is held in the rear, its front end being in contact with the face of the breech.

The operating lever projects through a slot in the carrier plate and has a knob in front bearing in a slot in the rear face of the breechblock. The lever-pin hole in the operating lever is elongated, and a locking lug is formed on the front edge of the lever, which, at the final motion of closing, is made to enter a slot in the rear face of the block, thus preventing rotation of the block due to the powder pressure. The lever-catch plunger in its spring are assembled in the powder-lever lug. Their object is to prevent rotation of the operating lever in counter recoil.

The extractor has trunnions resting in slots in the hinge-pin lugs. It is operated by a cam surface on the carrier plate.

The firing mechanism consists of the firing pin and spring, the pawl, the trigger, and trigger spring, and the lanyard button. The firing pin is composed of two parts, the body and the head. The body is cylindrical, except for a short distance near the center, where it is cut away on one side to clear the cocking toe on the trigger. At this point also a lug is formed upon the top of the pin to which the pawl is pivoted. The rear cylindrical part has two longitudinal grooves as gas vents, and the end of the pin is provided with a lanyard eye. The front end of the body of the pin is drilled and tapped to receive the head, which is screwed in and secured by a small pin. The head itself is cone-shaped, the apex being drawn out and hardened to form the firing point. The base of the cone is grooved longitudinally to permit the escape of gas in the event of a blow-back. A circular recess is made in the side of the cone in which the end of the safety screw pin is seated when the block is closed and locked. At other times the rotation of the block has removed the screw from its position opposite the recess and it bears against the side of the firing-pin head, thus preventing the projection of the pin through the block and the resulting possibility of a premature discharge.

The firing-pin spring is a coiled steel spring mounted on the body of the firing pin between its head and the pawl lug. The front end is bent to fit into a hole drilled in the body close to the head, while the rear end is brought forward over the coils parallel with the body, and in its normal position abuts against the shoulder at the front of the block. In this position the firing point is held retracted within the block, as a movement to the front would extend the spring. In the firing the momentum of the firing pin carries it forward beyond its point of rest and against the action of the spring far enough to explode the primer. To remove the firing spring it is necessary to take off the firing-pin head.

The trigger is an arm having at one end a lug to form a long pivot bearing and at the other a hook over which the lanyard button passes. Upon one side of the arm is formed the cocking toe which engages the pawl, and on the same side near the upper end is a short slot in which a projecting pin on the pawl is caught in the forward movement of the trigger after firing.

The trigger spring is coiled around the trigger pivot and secured at both ends. Its action is to force the trigger forward after firing and thus engage the pawl again in readiness for the next shot.

The lanyard button is a straight piece, slotted out to pass over and engage the hook on the trigger, and also provided with a lanyard eye at its rear end. It extends to the rear through a hole in the carrier plate, and is prevented from being drawn to the front through the plate by a button-shaped enlargement.

To Open the Breech.—The first motion of the operating lever to open moves it to the rear, due to its elongated pivot bearing, and unlocks the lug on its front edge from the slot in the breechblock. The knob on the operating lever then causes the block to rotate until its threads are unlocked from those of the breech recess. Further rotation of the block around its axis is prevented by its stop reaching the end of the groove in the carrier plate; rotation, as a whole, takes place around the hinge pin. As soon as this rotation begins the lock-bolt spring presses the bolt forward, locking the block to the carrier plate, and the extractor is constrained to move on its cam bearings, causing the point to withdraw the cartridge case at first slowly and then rapidly.

The operation of closing the block is the reverse of the above.

The firing mechanism, being of the continuous-pull type, is not operated in any way by the operation of the block.

To Fire the Gun.—Insert the hook of the lanyard in the eye of the lanyard button and pull until the firing pin is released. Pulling the lanyard button causes the trigger to rotate around its pin. The cocking toe of the trigger catches the pawl and the firing pin is pulled to the rear against its spring until the short arm slides off the pawl, when the firing pin is released and is driven forward by its spring. When the pull on the lanyard is released the trigger spring rotates the trigger forward, causing the toe to pass the pawl. The long arm then strikes a pin on the pawl, causing the pawl to rotate downward, so as to be caught by the toe of the trigger, when the firing mechanism is again ready for firing.

To Assemble the Breech Mechanism.—Seat the extractor. Put in the block-locking bolt and spring in the carrier plate. Assemble the carrier ring in the carrier plate, securing it by the screws, top and bottom. Slide the firing pin with its spring and pawl assembled into its seat from the front of the carrier plate. Slip the trigger containing its spring into place from beneath, taking care that the exposed end of the spring enters its seat in the carrier plate; insert the trigger pin carefully so as not to displace the coils of the spring. Pass the lanyard button from the rear through the slot in the carrier plate and hook it over the trigger, lifting the pawl so that the trigger may be pulled

back far enough for that purpose. Holding the trigger in that position by means of the lanyard button, slip the block over the hub of the carrier plate and screw it home in the carrier ring. Seat the carrier plate on the gun with the block exposed and insert the hinge pin. Put the lever-catch plunger and spring in its seat, press it down and enter the cotter pin. Push in the block-locking plunger, rotate the block to its closed position and insert the operating lever in its seat. In this position the lever will be home against the carrier plate. Insert the operating-lever pin and enter its cotter pin. Swing the block and carrier to the full open position by means of the lever, and by further pulling the latter rotate the block to its proper position for entering the breech.

If an attempt is made to close the breech before the last operation the block will jam.

To Dismount the Breech Mechanism.—Reverse the preceding operations. Care should be taken not to snap the firing pin except when the block is closed and locked, as in any other position the firing-pin head will strike the end of the safety screw. A few such blows will bend or break this screw.

2.24-INCH (6-POUNDER) R.-F. GUN, AMERICAN ORDNANCE CO. MIII

This rifle follows the general method of built-up forged-steel construction. It consists of a tube, jacket, hoop, and breech mechanism. The tube is enveloped for a distance of 42.90 inches from the breech end by the jacket and hoop. The jacket is assembled from the rear, the end of the tube abutting against a shoulder in the former. The hoop is assembled from the front, the two parts being locked together by a bronze sleeve with screws over the joint, and is held in place by a key. A shoulder formed in the tube abuts against a corresponding shoulder in the hoop and prevents forward movement of the tube. The exterior of the bronze sleeve is machined to form parallel bearing surfaces or guides by which the gun is supported in the mount.

The portion of the jacket in the rear of the tube is enlarged to form the recess for the breechblock and extractors.

The bore, which is 50 calibers in length, is composed of a seat for the cartridge, a forcing slope, and a main bore, which is 2.244 inches in diameter between lands.

The rifling begins at a point 12.873 inches from the breech end of the tube with a right-hand twist, increasing from 0 to 1 turn in 26.36 calibers at the muzzle.

The top of the breech recess is rounded and has four circumferential grooves into which corresponding ribs on the block fit when the latter is locked. Seats for the pivots of the extractors are drilled on either side near the front of the breech recess, and a transverse hole or bearing, for the main bolt is drilled through each cheek. A guide bolt is also screwed into each cheek, the end projecting slightly into the breech recess.

Breech Mechanism.—These guns are fitted with the Driggs-Schroeder breech mechanism, the principal parts of which are the block, face plate, main bolt, cam, operating handle, lever lock, lever-detent spring, extractors and firing mechanism.

The general shape of the block is the same as that of the breech recess. On its rounded top are formed four ribs which serve to lock the block in the firing position and transmit the thrust to the jacket. On each side of the block is a curved slot in which work the ends of the guide bolts. Undercut slots are cut in the front and rear faces of the block to receive the face plate and the sear, and its interior is hollowed out for the cam and the firing pin. Recesses are also cut in each side of the front face for the extractors and surfaces for operating the same, formed on the sides of the block.

Access to the interior of the block is gained through an opening in the front face, which, when the block is assembled, is closed by the face plate. The latter is a steel plate seated in an undercut slot and secured in place by the front end of the sear spring. It is drilled to permit the passage of the point of the firing pin, and has a thumb notch for easy assembling.

The main bolt consists of two cylindrical surfaces of different diameters joined by a hexagonal seat for the cam. It passes through an elongated hole in the block and the cylindrical ends fit into the supporting bearings drilled through the cheeks of the breech recess. On the smaller end which projects through the left cheek the operating handle is fitted and secured to it by a feather lug and the lever lock. The lever lock is a circular-shaped lever pivoted to the operating handle just above the lug and carrying on its under side a projection which passes through a seat in the lug and engages in a seat in the main bolt, thus securing the handle in place.

The handle is prevented from movement in counter recoil by the lever-detent spring, a spring circular in shape and dovetailed to the handle lug. The free end partly embraces the lever-stop pin when the breech is closed, thus preventing movement of the handle.

The cam is a short sleeve mounted upon the main bolt within the

block. It has a projecting cam surface which bears against the interior of the block and controls the movement of the latter, and in addition a shoulder, which by engaging an arm on the firing pin, cocks the pin during the opening movement.

There are two extractors, one on each side. Each consists of an arm, slightly bent, on which is formed at right angles a pivot that seats in a bearing drilled in the side of the breech recess.

The upper end of the arm carries the flange which engages the cartridge case, while on the lower end is formed a cam which works against a corresponding surface on the block.

The Firing Mechanism is composed of the firing pin, the firing-pin spring, the sear, and the sear spring.

The firing pin consists of a cylindrical body carrying on the underside the full-cock stud and the cocking arm and terminating in an eye for the drill-washer support in rear. On the upper side of the front end of the body is formed a lug, which is drilled and slotted to receive the split stem of the point. The firing-pin point is made in the form of a short spring split pin, the split end of which carries two locking shoulders. The lug on the firing-pin body is slotted to permit the passage of these shoulders, so that when the head is pressed home and partly rotated a bayonet joint is formed. The spring effect tends to spread the locking shoulders and prevent accidental rotation of the head. The firing spring lies between the lug of the firing pin in front and a shoulder of the block in rear.

The sear is a simple slide working in an undercut slot in the rear face of the block. Actuated by the sear spring, it presses up against the firing pin and engages the full-cock stud when the pin is retracted. Near its lower end a projecting lanyard eye is formed.

The sear spring is a flat spring enlarged at both ends, the rear end being notched to engage the sear, while the front end is cylindrical and serves both as a fulcrum for the spring and as a retaining pin for the face plate.

In the open position the block is supported by the tray, a channel-shaped forging, which is secured to the rear ends of the cheeks by screws.

To Open the Breech.—Turn the operating handle smartly to the rear. This movement unlocks the main bolt by releasing the lever-detent spring from the stop pin, and rotates the main bolt and cam. The first movement of the latter starts the retraction of the firing pin. As soon as the latter is retracted within the block the cam begins to act on the block, forcing it down until the ribs on the block clear the

grooves in the gun. The cam and guide bolts then cause the blocks to rotate backward around the main bolt until its front face is parallel to the axis of the gun. During this movement the firing pin has been fully retracted and caught by the sear. As the block rotates backward the lower arms of the extractor follows the cam surfaces on the former, causing the extractors to start the empty case slowly at first and afterward to eject it quickly.

The breech is closed by turning the operating handle to the front. The block is first turned, then raised and locked, the firing pin being left in the full-cock position.

To Fire the Gun.—Pass the lanyard beneath the tray and hook it into the eye on the sear. A quick pull on the lanyard will draw down the sear and release the firing pin. To permit of snapping the firing pin for drill purposes and without a cartridge case in the gun, a rubber ring, called the drill washer, is slipped over the rear end of the firing pin and held in place by the washer support, which passes through the eye on the end of the pin. When the trigger is snapped under drill conditions this rubber ring acts as a buffer between the rear face of the block and the support and thus lessens the shock on the firing pin.

The drill washer does not interfere with firing the gun, and should be left on at all times in order to avoid the possibility of snapping the trigger without it.

To Dismount the Breech Mechanism.—Cock the firing pin either by opening and closing the breech or by pulling it to the rear with the breech-mechanism tool until the sear engages. Remove the handle, having first raised its locking lever.

Withdraw the main bolt, supporting the block from beneath by the hand; remove the block by lowering it until the ribs on top are disengaged, and then withdrawing it straight to the rear until clear of the gun.

Lay the block on its right side on a wooden surface, withdraw the sear spring from the front and slip out the face plate; turn the block face down and pull down the sear, thus liberating the firing pin and spring; lift up the block, and the cam, firing pin, and spring will drop out clear.

Care should be taken to see that the firing pin is cocked before attempting to remove the face plate; otherwise the point of the pin will be bent or broken by the plate. If there is no wood surface convenient for snapping the firing pin into, hold it back with the tool and ease it forward on removing the sear.

To Assemble the Breech Mechanism.—Reverse the preceding operations. Put in successively the firing spring, firing pin, and cam; the front side of the latter is marked "Out." Put on the face plate, being careful to see that the firing pin is retracted while so doing. Insert the sear spring and engage the notch at its rear end with the sear. Replace the block in the breech in the closed position and insert the main bolt, bringing the arrow on its head in line with the arrow on the cheek in order to insure the proper location of the cam on its hexagonal seat. Put on the handle and close the locking lever into its seat, taking care that it is pushed home.

FIRING MECHANISM, MODEL OF 1903

USED ON ALL 8-INCH, 10-INCH AND 12-INCH RIFLES, AND 12-INCH MORTARS

(Plates V and IX)

The principal parts of the firing mechanism, of the above model, are hinged collar, housing, slide, and firing leaf.

The hinged collar embraces the rear end of the spindle, two ribs on its inner surface engaging in corresponding grooves in the spindle.

The housing screws over the hinged collar, which is threaded to receive it, and a spring catch locks the collar to the housing when it is fully screwed home. The collar is thus prevented from opening and secures the housing to the spindle.

A guide bar projects from the right side of the housing into a longitudinal groove cut in the block recess and causes the housing to rotate with the block.

The slide travels vertically in grooves cut in the rear face of the housing and when in its lowest position holds the primer to place in the primer seat. Its motion is limited by the slide stop on the left side of the housing. The slide catch serves to lock it in place when lowered, and to support it at the proper height to allow the primer to be inserted when raised.

The ejector is an L-shaped piece with trunnions at its angle, about which it swings, and which enter two slots cut for them in the housing. The lower arm of this extractor is fork-shaped and hangs over the mouth of the primer seat under the head of the primer. The horizontal arm projects to the rear into a recess in the slide, and when the latter is lifted this arm is carried upward and the ejector rotated about its

trunnions so as to throw the horizontal arm to the rear, ejecting the primer.

The firing leaf is pivoted to the slide at its upper end. It has a vertical slot cut in its lower edge through which the wire of the primer projects when the slide is in its lower or locked position. At the right-hand lower corner of the leaf is an eye into which the lanyard is hooked for friction firing. When the leaf is drawn to the rear it engages the button on the end of the primer wire and draws the wire out and fires the primer.

Electric connection with the primer is made through the two brass arms of the contact clip which embrace the head of the primer. The contact clip is held in place by a housing which is secured to the rear face of the leaf. The electric-cable terminal is made of a piece of steel rod bent at a right angle. To one arm is attached the electric cable; the other arm is slit to form a spring which is inserted into a hole in the contact-clip housing on the firing leaf.

A safety bar prevents accidental firing of the piece by the lanyard before the breech is locked; and a circuit breaker serves to prevent firing the piece by electricity before the breech is locked.

The first motion of rotation of the block to unlock the breech forces the safety bar inward so as to engage the leaf and prevent its being drawn to the rear, while at the same time the electric circuit is broken by the same movement of rotation.

A safety lug on the right side of the housing engages a groove in the firing leaf and prevents the latter from being drawn to the rear before the breechblock is rotated to its locked position. The last part of the motion of lowering the slide makes electric connection with the primer. It will be seen from this that accidental firing of the piece is impossible until the breech is locked and the slide of the firing mechanism is in its lower or locked position.

The circuit breaker is of bronze and consists of two principal pieces which are brought together when the block is rotated to its locked position. A plunger working under the pressure of a spring serves to make electric contact between the two pieces. Both parts of the circuit breaker are insulated from the piece by vulcanized fiber. The electric cable is attached to the circuit breaker by a spring fork.

Instructions for the Care and Use of Seacoast Firing Mechanism, Model of 1903.—While this mechanism forms part of a heavy gun, it is in itself small and light; the several parts are very closely adjusted, and it has been necessary to make the clearances very small. *The*

greatest care must be exercised, therefore, in keeping the mechanism well oiled and free from rust and dirt.

It should not be left on the gun when not in use, but should be kept habitually in the small box provided for it, and stored in the armament chest.

To Assemble the Mechanism on the Gun.—Clasp the hinged collar over the end of the spindle with the two ribs of the collar engaging in the corresponding grooves of the spindle, keeping the hinge at the top.

Take the mechanism in the right hand, holding the collar with the left, and put the mechanism over the end of the collar, screwing the latter to the left until the catch on the under side of the mechanism engages and locks it into position. While doing this, see that the guide bar which projects from the right side of the mechanism enters the groove cut in the breechblock for it, and that the pin on the safety-bar slide (which is attached to the gun), enters the hole in the outer end of the safety bar of the mechanism.

Do not attempt to use the mechanism until it is absolutely certain that the collar has been screwed entirely home and locked.

After the primer has been inserted lower the slide until the catch engages in the notch of the housing.

Be sure the slide is entirely down before attempting to fire the piece; otherwise the primer may be blown to the rear, endangering the lives of the detachment.

To Dismount the Mechanism.—To remove the mechanism from the spindle, draw the collar catch to the rear and unscrew the hinged collar.

To remove the slide from the housing, draw the slide stop out to the left as far as it will go. The slide may then be lifted from the housing.

To remove the firing leaf and slide catch from the slide, start the split pin which passes through the leaf pivot by pressing it against the bench or other surface and then draw it out. The pivot is then free to be removed, and its removal frees the leaf and slide catch from the slide.

The collar catch may be removed by unscrewing the screw at the lower edge of the housing.

The slide stop may be removed by unscrewing it from the housing with the wrench provided for that purpose. The slide stop should not be removed except when necessary to repair it or to replace a broken spring.

The contact-clip housing may be removed from the leaf by unscrew-

ing the nut on the under side of the leaf. The contact clip is held in place in its housing by spring pressure only, and may be removed by drawing or pushing downward after the cable terminal has been removed.

FIRING MECHANISM 6-INCH R.-F. GUN, MODEL OF 1903

The principal parts of this firing mechanism are the housing, slide, firing leaf, ejector, contact clip, and firing cable.

The housing is screwed on the rear end of the obturator spindle and does not rotate with the block, due to the action of the spindle key. A groove on the rear face of the housing carries the slide, which has a horizontal motion on the right side of the axis of the gun limited by the slide stop.

A notch on the under side of the slide receives the rack-lock bolt. The left end of the slide is V-shaped, with the point of the V to the right. The point of the V is extended to the right by a notch cut through the slide. When the slide is in position, breech closed, the stem of the primer passes through the notch, the base of the primer being supported by the body of the slide.

The firing leaf is a vertical lever, pivoted to the slide by the firing-leaf pivot and pivot pin. A horizontal notch is cut into the left side of the lower arm of the firing leaf. The stem of the primer passes through this notch when the slide is in the firing position.

The contact clip is attached to the firing leaf by the clip housing and housing nut. The housing is insulated from the slide by the clip-housing insulation. When the slide is in firing position, the clip embraces the button on the end of the primer stem, forming electrical connection with the primer.

The firing cable is connected to the clip housing by the firing-cable terminal, consisting of a split pin with enlarged end, held in place by friction. The other end of the firing cable is similarly attached to the firing-cable bracket on the breech of the gun. The lower arm of the firing lever lies against the upper arm of the firing leaf when the slide is in firing position. When the lanyard is drawn to the rear, the lower end of the firing lever presses the upper end of the firing leaf to the front, causing the lower end of the leaf to strike the primer button and draw it to the rear, exploding the primer.

When the rack moves to the right in opening the breech, the rack lock carries with it the slide, leaving the primer free to be ejected and freeing the leaf from contact with the firing lever.

In closing the breech the leaf does not come in contact with the firing lever nor the contact clip embrace the primer button until the rotation of the block is practically completed. By drawing downward on the rack-lock handle, the slide is freed from the rack and may be moved independently, to permit the placing of a primer in the vent without opening the breech.

The ejector consists of a horizontal lever, pivoted to the housing of the firing mechanism. The right end lies in a groove cut in the end of the spindle. This end is forked, the fork partially surrounding the mouth of the vent and lying in front of the rim of the primer. The left end of the ejector is broadened to be struck with the hand. The ejector spring, acting on the left end of the ejector, holds the fork normally in its groove in the spindle. One side of this groove is beveled to allow the fork to ride out of the groove in dismounting the mechanism. When the left end of the ejector is struck, the fork acts on the rim of the primer to throw the primer clear of the vent.

FIRING MECHANISM, 6-INCH R.-F. GUN, MODEL OF 1905

The firing mechanism for this model of gun is very similar to that of the model of 1903. The essential differences are given below:

The mechanism consists of a housing, slide, firing lever, firing leaf, safety plunger, ejector, and circuit breaker.

The slide is operated entirely by hand and carries a handle for this purpose. The slide catch holds the slide in its firing position.

The catch consists of a lever pivoted at the base of the handle. A hook on one end of the catch engages a shoulder on the housing. The hook is pressed forward by the slide-catch spring. The hook is disengaged from the shoulder by the pressure of the hand on the other arm of the catch in grasping the slide handle.

The safety plunger has a vertical movement in a slot cut in the spindle key and extended in the carrier. The upper end of the plunger carrier is a stud, which works in a groove in the spindle key to guide the plunger and limit its downward movement. The plunger is pressed downward by the plunger spring. When the breech is fully closed, the lower end of the plunger enters a notch cut in the surface of the gear segment. When rotation of the block in opening the breech begins, the plunger is forced upward out of the notch. The upper end of the plunger now engages a shoulder on the firing lever, preventing any movement of the lever until the breech is again fully closed.

The circuit-breaker housing is attached to the carrier by two

screws. Two contact pins pass vertically through the housing and are held in place by the contact-pin nuts screwed on their lower ends. The circuit-breaker is arranged so that when the breech is closed, the contact plungers are carried by the operating lever under the contact pins, thus completing the firing circuit only when the breech is fully closed.

FIRING MECHANISM, 6-INCH R.-F. GUN, MODEL OF 1897 MI; AND 5-INCH R.-F. GUN, MODEL OF 1897

This mechanism is intended for use with a combination electric and friction primer. It consists of the following principal parts: Slide, slide housing, ejector, firing leaf, contact-clip, firing cable, circuit breaker and safety bar.

The housing is attached to the rear end of the spindle by means of an interrupted screw thread and is secured in place by a spline screw.

The slide has a vertical movement in guides which project from the rear portion of the housing, and its movement is limited by the slide stop, which has a horizontal movement in a slot cut in the housing, its inner end projecting into a groove in the side of the slide. The slide stop is pressed inward by a helical spring.

The firing leaf is pivoted at its upper end to the slide against which it lies flat when in its normal position.

A notch is cut through both the slide and the leaf, so that when in its lowered position the slide supports the head of the primer against the pressure of the powder gases, while allowing the primer wire to extend through the notch.

When the leaf is swung to the rear, its rear face catches the button at the end of the primer wire and explodes the primer.

The contact clip makes electrical connection with the primer by bearing against the button on end of primer wire when the slide is in its lowered position. The contact clip is held in a housing which is secured to the firing leaf by the housing nut and is insulated from the leaf by the housing insulation.

One end of the firing cable is attached to the clip housing by the firing-cable terminal, consisting of a split pin with enlarged end held in place by friction, the other end attached to the circuit-breaker contact piece.

The circuit-breaker contact piece is secured to the outside of the gear segment by two screws and insulated therefrom. When the block is rotated in closing, the circuit-breaker contact piece comes into

contact with the circuit-breaker contact pin, making electrical connection with one of the firing leads.

The circuit-breaker contact pin and spring are inclosed in a housing which is attached to the block carrier by two screws and insulated therefrom. The pin is held against the contact piece by the pressure of its spring. The end of the firing lead is secured to the circuit-breaker housing by a fork. The firing lead is held in place by the cable clamp screwed to the block carrier.

The ejector consists of a horizontal and a vertical branch with two trunnions near the angle. It is supported in the housing by these trunnions, and in its normal position, the lower branch, which is in the form of a fork, hangs vertically over the mouth of the primer seat, engaging the rim of the primer on two sides. The horizontal branch projects to the rear into a recess cut in the front face of the slide. The lower end of this recess is a cam surface. When the slide is raised, this cam surface forces the horizontal branch upward, ejecting the primer. When the slide is lowered, the ejector drops into position against the mouth of the primer seat.

The safety bar is a lever pivoted in the slide housing and actuated by a stud on the gear segment working in a slot cut through the outer end of the safety bar. At the beginning of rotation of the block in opening the breech the inner end of the safety bar rotates inward, entering a slot in the right side of the firing leaf, thus preventing any movement of the firing leaf, except when the breech is fully closed.

To Dismount Mechanism.—Open the breech. Unscrew safety-bar pivot and remove safety bar. Detach firing cable from circuit-breaker contact piece. Pull outward on slide stop and lift slide from housing. Unscrew housing spline screw and revolve housing 90 degrees to the right, when the housing may be drawn to the rear from the spindle. Unscrew the spindle nut and the spindle-key screw, and remove the spindle key.

Be careful not to remove spindle nut and spindle key before opening the breech, as in that case the split rings are liable to drop down and prevent the withdrawal of the block.

The spindle, split rings, pad, etc., are then free to be removed from the block.

Take out the two gear-segment screws and drive off the gear segment, using a copper drift to prevent injury to the gear segment.

Take out the latch-lever pivot and remove the latch lever, spring, and bolt. The block is then free to be removed from the carrier. Drive out the pivot pin and remove the pivot nut, unscrew the pivot,

and the pinion and lever are then free to be removed from the carrier. Drive out the hinge pin, being careful to support the carrier while doing so, and the carrier is then free from the piece.

FIRING MECHANISM, 5-INCH R.-F. GUN, MODEL OF 1900

This mechanism is practically the same as used in the model 1897, except as follows: The housing of this mechanism is attached to the spindle by means of a yoke. The firing mechanism turns with the block during rotation. The safety lever lies in a groove in the surface of the guide cylinder.

A projection on the front end of the safety lever rides in a groove cut in the block carrier. When the breech is fully closed, this projection enters a well cut at the end of the groove in the block carrier, allowing the hook on the rear end of the safety lever to drop and free the firing leaf. At the beginning of rotation of the block in opening the breech the safety-lever hook rises and prevents any movement of the firing leaf.

ADJUSTING GAS-CHECK PADS

Experience has shown that, as a rule, gas-check pads are too tight. It has been customary, because of the simplicity of the method, to adjust the pad with the breech open by tightening the spindle nut until the pad could just be turned by hand. In cold weather when the pad is relatively rigid this adjustment is satisfactory; in warm weather, however, the pad being more plastic is forced outward readily till it extends beyond the surface of the split rings. When this occurs, even though the pad can be turned by hand, the pad is not in proper adjustment, since when forced into its seat it will be pressed over the rear ring and injured. As the object of the pad is to form a perfect gas check at the rear of the tube, the best adjustment is made with the pad seated.

To Adjust Pads.—Close the breech, having the spindle nut loose, but not so loose as to permit slipping of the pad or split rings; rotate the block until one-half of the rotation has been accomplished. With the mechanism in position, screw up the spindle nut as tight as it can be screwed with the wrenches provided.

With the new spindle nut, having a locking device, it is necessary to insert the end of a screw-driver in the opening of the nut in order to spread it sufficiently to allow its rotation without rotating the spindle.

Lock the spindle nut and rotate the breechblock until the breech is completely closed. This last operation presses the pad in its seat, due to the forward motion of the block.

The pad is now in proper adjustment for firing.

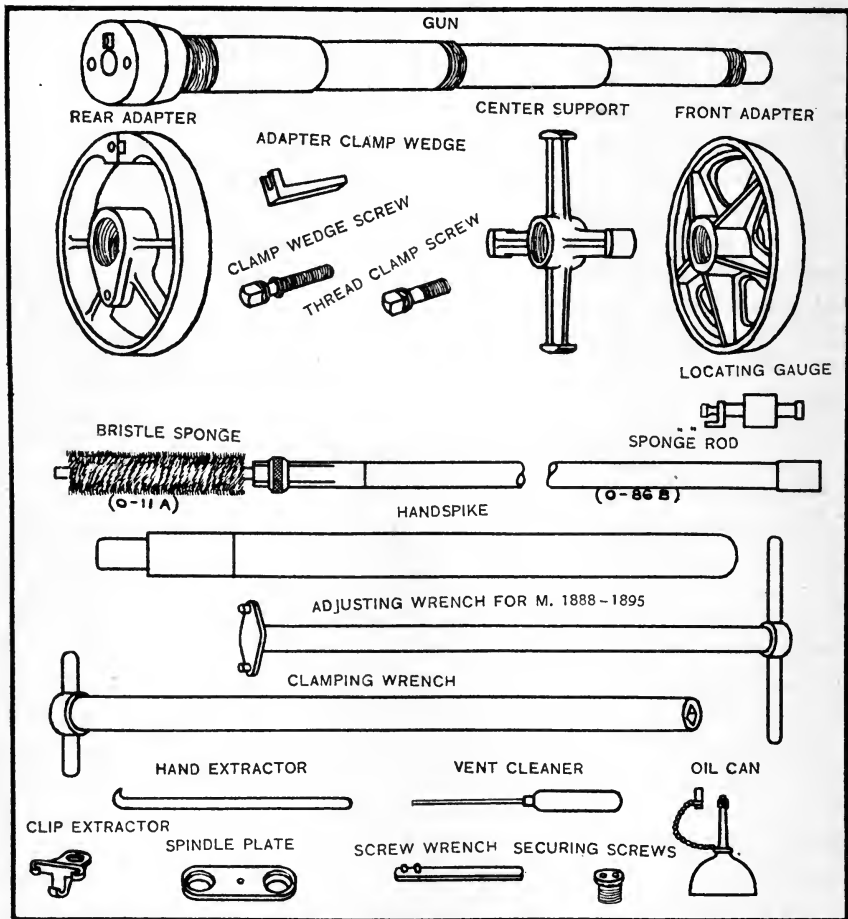

FIG. 17.

THE 1-POUNDER AND 2.95-INCH SUBCALIBER GUNS

As the name implies, the subcaliber tube is in reality a gun of lesser caliber than the gun in which used. It is inserted into the bores of seacoast cannon for the purpose of providing a means of practicing

in firings with these guns under conditions resembling those of service practice, the difference being that the projectile of the subcaliber gun is of much smaller caliber when compared to the bore of the larger gun.

The principal parts of a type of subcaliber tube are shown in detail in Fig. 17.

A statement of the various sizes of tubes provided for use in sea-coast cannon, as well as the interchangeability of the same, is given in the following table:

INTERCHANGEABILITY OF SUBCALIBER GUNS.

Subcaliber guns for 5-inch guns, model of 1900.	} Are interchangeable; that is, these guns will all fit into the 5-inch guns, model of 1900; 6-inch guns, models of 1900, 1903 and 1905; and 8-, 10-, and 12-inch guns of all models when fitted with the proper adapters.
Subcaliber guns for 6-inch guns, models of 1900, 1903, and 1905.	
Subcaliber guns for 8-inch guns, model of 1888.	} They will not fit in the 4-inch Driggs-Schroeder 5-inch and 6-inch guns, model of 1897, and 4.72-inch and 6-inch Armstrong guns, as these guns must have subcaliber guns fitted with special rear adapters forming a permanent part of the subcaliber gun.
Subcaliber guns for 10-inch guns, models of 1888, 1895, and 1900.	
Subcaliber guns for 12-inch guns, models of 1888, 1895, and 1900.	} Are interchangeable in 4-inch Driggs-Schroeder guns, and 8-, 10-, and 12-inch guns of all models when fitted with the proper adapters.
* Subcaliber guns for 4-inch Driggs-Schroeder guns.	
* Subcaliber guns for 5-inch guns, model of 1897.	} Are interchangeable in 5-inch guns, model of 1897, and 8-, 10-, and 12-inch guns of all models when fitted with the proper adapters.
* Subcaliber guns for 6-inch guns, model of 1897.	
Subcaliber guns for 4.72-inch and 6-inch Armstrong guns.	} Are interchangeable, respectively, in all 4.72-inch and 6-inch Armstrong guns, and 10- and 12-inch guns of all models when fitted with the proper adapters.

* The 4-inch Driggs-Schroeder, 6-inch 1897, and 6-inch Armstrong subcaliber guns should have adjusting wrench holes, if not already provided, drilled in the breech face, if these guns are ever mounted in 10- or 12-inch guns.

Each caliber and model of gun requires a special adapter which can not be used in any other model of gun.

The 2.95-inch subcaliber guns for 12-inch mortars, model of 1886, are not interchangeable with those for 12-inch mortars, model of 1890.

The directions for assembling and using the tubes are practically the same for all guns, so that an explanation of the 1-pounder subcaliber tube used in the bores of 8-, 10-, and 12-inch B.-L. Rifles will serve as a guide:

To Assemble the Tube.—First see that the chamber and bore of the subcaliber gun, and of the gun itself, are perfectly clean. Remove the blank pressure plugs from the mushroom head and put on the obturator spindle plate with its two screws. This is done by using the securing screw wrench. The screw heads should be tightened well upon the plate. Then insert the loading tray to prevent injuring the adapters on the breech threads.

The subcaliber gun with its adapters should now be inserted into the chamber of the large gun by pushing it forward with a handspike sufficiently far to cause the front adapter to seat firmly in the slope of the powder chamber. It is tapered so that it will fit this slope. With the 10- and 12-inch rifles, model of 1900, the subcaliber gun should be supported with a handspike while the bronze shoe is slipped under the rear adapter.

When the subcaliber gun is as far forward as it can go remove the handspike and insert locating gauge in the chamber of the subcaliber gun with its flange pulled to the rear. Then completely close the breech of the large gun and open it again and note whether the flange of the locating gauge is flush with the face of the subcaliber gun. If the gauge protrudes revolve the subcaliber gun left-handed. If below the face of the subcaliber gun turn the gun right-handed. One complete turn of the gun will make a difference in the distance from the face of the subcaliber gun to the mushroom head of $1/10$ of an inch. This adjustment is made with the adjusting wrench, having its lugs entered into the holes in the rear face of the gun.

The subcaliber gun should be adjusted in this manner until the flange of the locating gauge is brought exactly flush when the breech is closed. The thread clamp screw should be tightened with the clamping wrench so that the subcaliber gun will be prevented from turning. The gun is then ready for firing.

To Use the Subcaliber Gun.—Insert a subcaliber cartridge, close the breech and fire as with the regular ammunition. The breech is then opened, the empty cartridge case removed after each round with the hand extractor. Should a cartridge case stick so that it can not be removed with the hand extractor, use the clip extractor, which is provided for such emergencies. It may be necessary to pass a light rope through the eye of the clip extractor in order to apply greater force against the face of the breech.

To Dismount the Tube.—Insert the loading tray and loosen up both clamp screws. Then insert the handspike, leaving same to support the weight, and remove the adapter shoe. Then pull the subcaliber

gun to the rear and out. Should the gun stick attach a rope over the enlargement of the breech and pull out, being careful that the gun does not come to the rear too rapidly after being released.

It is important that the subcaliber gun be unloaded and then loosened before the adapter shoe is removed from under the rear adapter, because if the shoe is removed before the gun is loosened the lowering of the breech of the subcaliber gun will cause the front adapter to bind in its seat and considerable difficulty will be had in removing the tube. Care should be taken in assembling and dismounting in order to prevent the turning surfaces of the adapters from striking the threads of the breech recess or any other hard substance and burring them. Care should also be taken in loading not to drive the point of the shell against the edge of the chamber of the subcaliber gun. Both guns should be thoroughly cleaned and oiled after firing.

CARRIAGES FOR COAST ARTILLERY CANNON

The method of mounting seacoast guns determines the design of emplacements. Conversely, the design of emplacements also has a bearing upon the suitability of mounts for guns. It is evident that the principal object of an emplacement is to provide a firm, unyielding support for the gun and carriage, so that the gun may be loaded, manipulated and fired under conditions giving the greatest protection to the personnel and armament from the fire of the enemy.

Elements influencing the selection of type of carriage may be briefly stated as follows:

1. **Rapidity of Fire.**—With large guns (10- and 12-inch calibers) greater rapidity of fire is undoubtedly obtained with the disappearing type of carriage. The advantage in time and less fatigue of men are such as to give a decided preference for the disappearing mount. When the caliber of the gun is six inches or less the advantage obtained by the use of the disappearing type of carriage may be considered as nil, and for calibers less than six inches the non-disappearing type is decidedly preferable.

2. **Exposure of Gun, Carriage, or Mount.**—With the non-disappearing carriage without a shield, substantially every man working at the gun, except those on the elevating cranks, is exposed to direct fire; while with the disappearing carriage and direct laying (Case I and II) only one man is exposed. In indirect laying (Case III) none of the personnel are exposed for small angles of fall.

Considering the non-disappearing type of carriage illustrated by the Armstrong Pedestal Mount with shield, it may be stated that the gunner has better protection than with any other type of mount. The gun, however, on a non-disappearing carriage is exposed at all times; while with the disappearing type it is only exposed, in direct laying, for the few seconds required for aiming; and for indirect laying it is exposed for even a shorter time, that is, while the piece is actually being fired.

The damage, caused by a shot hitting the disappearing type of carriage, when exposed to the direct fire of the enemy, is more apt to be greater and more serious than the damage, from the same shot, to the non-disappearing type; due to the numerous additional devices required in the former type.

Carriages for coast artillery cannon are classified as follows:

1. According to the nature of the cover afforded by the emplacements, into:

Barbette (Barbette Proper, Pedestal Mount, Special Mounts),
Disappearing,
Masking Mount,
Casemate,
Mortar.

2. According to the axis of rotation about which they are traversed, into:

Front Pintle,
Center Pintle.

3. According to the area of fire covered by them, into:

Limited Fire,
All-around Fire.

BARBETTE

Barbette Proper.—This class of carriage includes the non-disappearing types, with guns that remain above the parapet for loading and firing. Carriages of this type may be either front pintle or center pintle, limited fire, or all-around fire. A type of this class of carriage is illustrated in the 12-inch barbette carriage shown in Plate XVIII. The carriage is of the center pintle form and consists essentially of the following parts: A base ring resting upon the masonry platform, a traversing roller ring, a combined racer and chassis, and a top carriage containing the trunnion beds and the recoil cylinders.

The base ring is of cast iron, in one piece, 10 feet 8 inches in diameter, secured to the platform by sixteen 2-inch bolts through

PLATE XVIII

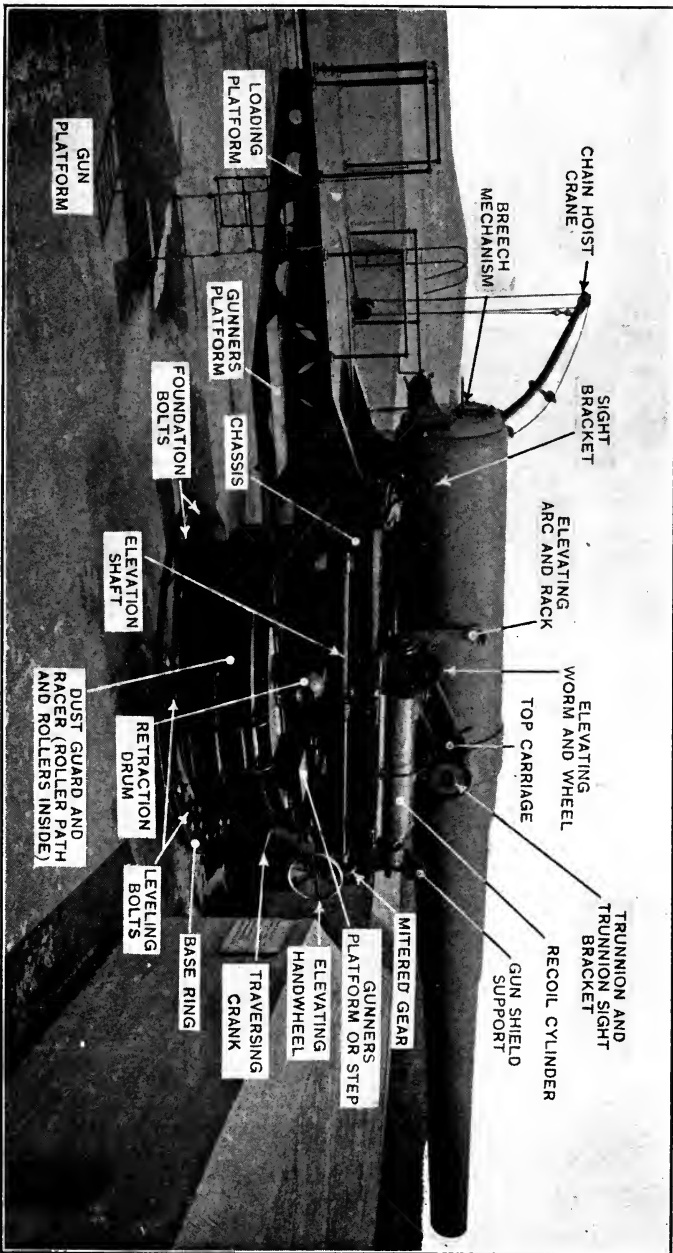

12-inch B. L. Rifle, M. 1898. Mtr. Mounted on Barbette Carriage, M. 1892.



LIBRARY
OF THE
UNIVERSITY
OF
CALIFORNIA

the flange. The lower roller path, with an outside diameter of 96.7 inches, is on its upper surface.

The pintle rising from the center of the base ring is a right cylinder, 8.05 inches high and 37.97 inches in diameter, with an oil groove on its outer surface. Upon the lower roller path rests a circle of twenty forged-steel conical rollers securely held in place by two concentric distance rings. The distance rings are kept concentric by ten separators, bolted between them, and the system is held concentric with the pintle by flanges on the inner ends of the rollers.

The combined racer and chassis is of cast iron, made in one piece, with transoms and inner and outer strengthening ribs. The lower surface, constituting the upper roller path, rests upon the traversing roller-ring system. Four forged-steel clips are bolted to its lower exterior surface with five $1\frac{1}{8}$ -inch tap bolts. The lips of these clips engage under a corresponding flange on the base ring. Between these clips is a dust guard, in four sections, extending around the traversing roller-ring system. A circular flange on the interior of the racer constitutes the pintle ring, and extends down over the pintle on the base ring.

The top carriage rests upon eight steel rollers, 8 inches in diameter, mounted on a U-shaped recess in the top of the chassis rails. These rollers are bushed with bronze and mounted upon 2-inch screw axles seated in the walls of the recess. The chassis rails have an inclination upwards and to the rear, of four degrees, and are strengthened by three transoms. The piston rods pass through lugs which project upwards from the front ends of the rails and are secured by the piston-rod nuts and check nuts. The front surface of these lugs and of the rails is planed as a seat for a shield to protect the guns.

The top carriage is of steel, cast in one piece. It consists of the two trunnion bed side frames in which are cast the two recoil cylinders united by a transom passing under the gun.

Flanges upon the recoil cylinder are clipped over corresponding flanges on the chassis rails. The cylinders are $8\frac{1}{2}$ inches in interior diameter, fitted each with a piston rod $3\frac{1}{4}$ inches in diameter, having a piston with a clearance of 0.1 of an inch all around. During the recoil the pistons remain stationary, and the top carriage with the recoil cylinders is drawn over them. Uniform resistance in the cylinders is obtained by the passage of the liquid from front to rear, through varying orifices caused by throttling bars whose inner faces are curved. There are two throttling bars in each cylinder, and each piston has rectangular slots, one on each side, which fit over them.

The sectional areas of these bars are such that the orifices for the flow of liquid vary with the position of the piston during recoil so as to obtain the desired resistance in the cylinder. The energy of recoil is taken up by the resistance which the fluid offers to being driven through the orifices.

After recoiling, the gun returns to the firing position by the action of gravity, the slope of the chassis rails being sufficient to permit the top carriage to move forward on the rollers. The rear end of each cylinder is closed by a screw plug-cover which has in its front face a cylindrical cavity 5 inches deep with rounded bottom, and the end of the piston rod fits into this cavity with a clearance of .0075 of an inch on the diameter. When the gun returns to the firing position the liquid caught in the cavity can only escape by the small clearance, thus acting as a buffer to check the velocity at the end of the return into battery. At the front end of the recoil cylinder there are the usual stuffing boxes, with glands and followers.

A copper equalizing pipe entering immediately behind the glands connects the front ends of the cylinders. By this means the pressure in both cylinders is always the same. The recoil should be about 40 inches.

The cylinders are provided with filling and emptying plugs suitably placed.

The cap squares are dovetailed and secured by two 1-inch tap bolts.

The carriage is traversed by a chain, coupled through its end links to two ear bolts passing through lugs cast on the outer vertical surface of the base ring below the roller path. By means of nuts on these bolts the length of the chain may be given all necessary adjustment.

Wrought-iron bolts are mounted vertically 8 inches each side of the longitudinal axial (plane) bolted upon a racer. A rectangular slot is mortised through the lower end of these bolts, in the walls of which are mounted $1\frac{1}{2}$ -inch steel bolts which serve as axles for pulleys for changing the direction of the traversing chain, to carry it up over a sprocket wheel splined to a worm gear in front of it. This sprocket wheel and worm gear are mounted on a horizontal steel axle bolt in a bearing cast on the racer.

The traversing worm gear engages in a worm keyed on a transverse through shaft, mounted in bronze bush bearings in brackets cast on and projecting to the front from the chassis rails. On the squared

ends of the traversing shaft there are crank levers 18 inches long, with handles covered with loose brass sleeves.

Pointing in elevation is given by a rack, bolted by two $1\frac{1}{4}$ -inch bolts to the elevating band on the gun. A pinion, mounted upon a short cross shaft, engages in the rack. This elevating pinion shaft is mounted in a bearing drilled in the top carriage over the rear end of the right-recoil cylinder. On the outer end of the same shaft there is keyed a friction clutch disk, fitting in a ground seat in the outer face of the worm gear, and is brought to a bearing in its seat by a nut on the end of the shaft. By this clutch excessive stress on the elevating system is relieved during firing.

This worm gear engages in a worm splined upon a vertical shaft having its bearings in two lugs on the outside of the top carriage. On the lower end of this worm shaft there is splined a bevel gear which takes in a second bevel gear upon the main elevating shaft; this is supported, parallel to the top surface of the right chassis rail, by the two wrought-iron brackets bolted to the outer face of the latter. This second bevel gear slides upon the squared section of this shaft, being carried back and forth in the recoil of the top carriage by an arm cast upon the latter, through which the hub of the gear extends, secured by a nut abutting against the front side of the arm. There is a hand wheel on the rear end of the shaft for the use of the gunners. The front end has another bevel gear mounted thereon, which engages in a bevel gear mounted on a transverse through shaft, having its bearings in bronze sleeves, bolted to the chassis rails, near their forward ends, as bushings of holes drilled in the same. On each end of this shaft there is a bronze handwheel to assist in elevating the gun.

For the shot hoist there is a through shaft journaled in the rear ends of the chassis rails above the upper roller path, with a bronze bushed middle bearing in the lug projecting from the rear transom. This shaft is held against lateral motion by a collar on the outside of each chassis rail. A bevel gear keyed upon this shaft under the right chassis rail takes in a bevel gear splined on the lower end of the vertical shaft journaled in two other lugs extending from the rear transom. Above this latter gear there is a worm splined on this same vertical shaft, which worm takes in a segment of a worm wheel keyed upon a second shaft called the shot-hoist shaft, parallel to the first through shaft. The bearings of this last shaft are in brackets extending to the rear from the chassis side frames, and cast in one piece with them.

A lever mounted upon a squared section of this second shaft, terminating in a fork with slotted ends, is designed to receive the trunnions of the projectile tray, support being given lower down on the tray by a third arm projecting below the fork. Power is applied to the crank levers on each end of the first shaft. By the rotation of these cranks the tray, with its projectile, is lifted to the position for ramming. The handles of these levers are covered with loose brass sleeves.

The shot is brought to the gun in a tray, resting upon a three-wheeled truck or shot barrel, consisting of a body, two cast-iron 14-inch truck wheels, mounted on a wrought-iron axle, and a cast-iron 5-inch caster wheel, mounted in a wrought-iron fork.

The loading platform consists of a flooring 45 inches above the terreplin, supported by boiler-iron brackets strengthened by T irons riveted along the edges. It is inclosed by a wrought-iron tubing rail. A set of four straps on each side gives access to the platform. These are supported by side pieces and struts bolted to the platform. A slot through the middle of the flooring permits the shot to be lifted by the hoist to its position opposite the breech of the gun, into which it is pushed and rammed by cannoneers standing on the platform. A separate loading tray is placed in the gun to protect the threads.

The carriage permits of the gun being traversed through 320 degrees, and elevated from minus 7 degrees to plus 18 degrees.

The cylinders should be filled with neutral oil before firing.

Pedestal Mount (see Plate XVII).—The pedestal mount or carriage is one of the barbette class well illustrated by the 15-pdr. barbette carriage, model of 1903, which consists of a pedestal, pivot yoke, cradle, traversing and loading mechanism, shield, shield supports, and shoulder rests, with the necessary peep and telescopic sights, firing mechanism, and electrical attachments.

Pedestal.—The pedestal is made of cast steel, and has the general form of the frustum of a cone united at its top to a cylindrical section and at its bottom to a base, in the flange of which are drilled holes for the fourteen foundation bolts and three leveling screws. Two hand-holes covered with water-tight plates are provided for cleaning the interior. The joints of the covers are made water-tight by means of Garlock's gasket packing. There are twelve holes equally spaced for the foundation bolts, and two extra holes drilled so as to enable the use of this pedestal in emplacements of the 15-pounder barbette carriage, model of 1902.

The exterior of the cylindrical part is finished and forms a seat for the traversing worm wheel. Beneath this seat on the front of the pedestal is a boss to which the friction band is secured by a stud bolt. An annular boss is cast in the bottom of the pedestal. This boss is bushed with bronze and forms a bearing for the lower end of the pivot yoke. The upper interior cylindrical part of the pedestal is also bushed with a bronze bearing. These two bearings serve to keep the pivot yoke in a vertical position. The weight of the revolving parts is supported by a ball thrust bearing inserted between the end of the pivot yoke and the bottom of the cylindrical recess formed by the annular boss at the bottom of the base of the pedestal.

Pivot Yoke.—The pivot yoke is of cast steel, and has a cored conical stem from which rise two vertical cheeks. In the cheeks are bronze-lined trunnion beds for the trunnions of the cradle. These beds are fitted with interchangeable dovetailed cap squares bolted to the cheeks. Finished recesses are formed in the outer faces of the cheeks of the pivot yoke into which the shield supports are fitted and bolted. There is an annular projection under the cheeks of the pivot yoke to which is bolted a cover to protect the traversing worm wheel. The cored holes in the stem of the pivot yoke are closed with plugs to prevent the entry of water into the bearings of the pedestal. The rear faces of the cheeks are finished so as to receive a bracket containing the traversing and elevating mechanisms. This bracket is bolted to the rear faces of the cheeks by six bolts. There are four oil holes provided in the pivot yoke for oiling its upper bearings in the pedestal, and an oil pipe leading from a fifth hole to the thrust bearing through the cored hole in the pivot yoke enables that bearing to be flooded with oil.

Cradle.—The cradle, of cast steel, has a cylindrical body bored out to receive the counter-recoil spring, on the upper surface of which are guides, lined with bronze, for the recoil clips of the gun.

Two side pieces extending upward from the cradle body have trunnions which fit in the bronze-lined trunnion beds in the pivot yoke. The outer ends of the trunnions are finished to receive the front-sight brackets.

Pads near the rear end of the cradle, on either side, are finished for the rear-sight brackets and shoulder guards. The right side of the cradle at the rear end has a boss finished with a vertical hole to receive the semi-automatic breech mechanism when used.

At the bottom part of the rear end of the spring cylinder is a slotted lug to which is attached the inner elevating screw.

The counter-recoil spring is a single helical spring, with round cross-section, and at assembled height it is about 12 inches shorter than at free height. It is assembled from the front, and the rear end rests against a flange on the interior of the spring cylinder and the forward end rests against a flange on the front recoil-cylinder head. The counter-recoil spring is coiled between the interior of the spring cylinder and the exterior of the recoil cylinder.

The recoil cylinder is of forged steel, finished all over, and threaded at the ends to receive the front end rear recoil-cylinder heads. There are flexible vulcanized fiber packings making oil-tight the front and rear ends of the recoil cylinder. The piston rod passes through a stuffing box in the front recoil-cylinder head.

The stuffing box consists of a finished bronze follower on the piston rod, screwed into a box in the front recoil-cylinder head, and compressing five rings of Garlock's hydraulic waterproof packing between a flange in the box and a forged-steel gland, divided into halves and retained in position on the follower by a spring-steel ring.

The front cylinder head is provided with filling and drain holes, each to be closed by a bronze washer-head filling and drain plug.

The spring cylinder head is of cast steel and receives the piston-rod pull. It also receives the thrust of the counter-recoil spring at assembled height, when the lug of the gun is disconnected from the rear cylinder-head stud, in mounting and dismounting the recoil system. The instruction plate is mounted on the spring-cylinder head.

The piston rod and piston are in one piece, made of forged steel, finished to receive a bronze piston liner and bored out to receive the counter-recoil buffer. This buffer is made of Tobin bronze, finished so as to be screwed into the rear recoil-cylinder head from the inside.

There are three throttling grooves in the interior of the recoil cylinder.

Recoil and Counter-Recoil Systems.—The action of the carriage is as follows: When fired the gun recoils to the rear about 9 inches in the cradle, carrying with it the recoil cylinder and thereby compressing the counter-recoil spring. A small portion of the energy of recoil is taken up in compressing the counter-recoil spring, but the greater portion of the energy is absorbed by the resistance offered by the liquid being forced through the orifices of the throttling

grooves. The width of the grooves is uniform, but their depths are proportioned so that the areas of the orifices vary with the position of the piston during recoil, and will be such as to give, with the aid of the counter-recoil springs, a constant resistance throughout the length of recoil. The pressure in the cylinder is therefore a uniformly-decreasing one. The counter-recoil buffer is tapered so that the escape of oil during counter recoil through the varying diametral clearances between the buffer and the walls of its hole will offer such resistance as will control the motion of the gun during its return, and finally bring it to rest when the recoil piston reaches the rear end of the cylinder.

Elevating Mechanism.—The elevating mechanism consists of a handwheel actuating through suitable connecting shafts and bevel gears, a double screw with right-hand outer threads and left-hand inner threads. The outer elevating screw is of forged steel and turns in a bronze elevating nut and cap. It receives its rotary motion from the elevating bevel gear by means of two keys sliding in longitudinal grooves cut in the outside of the screw. The inner screw has a left-hand thread and has its upper end attached to the slotted lug on the bottom of the rear end of the spring cylinder. The elevating-screw nut is pivoted on trunnions so as to allow the necessary rotation, corresponding to different angles of elevation. The elevating-screw nut is provided with an elevating-screw nut cap bolted to it by four bolts. The elevating-screw cap has a hole and plug, and the elevating-screw nut has a hole fitted with a plug for draining.

The elevating bevel gear is of bronze, and the pinion is of forged steel. The pinion is keyed onto the elevating intermediate shaft which receives its motion from the handwheel by the elevating handwheel shaft and a set of elevating handwheel shaft gears inclosed in gear covers.

The elevating handwheel shaft has a bearing near the handwheel in a bracket secured to the shoulder rest. The elevating gear bracket cap has a bearing for the lower end of the elevating handwheel shaft and serves as a cap for the trunnions of the elevating-screw nut.

Traversing Mechanism.—The traversing mechanism consists of the traversing worm wheel, traversing worm shaft and worm, one pair of bevel gears, one traversing shaft, and one traversing handwheel. It is all designed, however, so that another handwheel can be placed on the right-hand side if necessary. The traversing worm wheel is

seated on the exterior cylindrical top of the pedestal, and is retained in position by the friction band, a shoulder on the pivot yoke, and a shoulder on the pedestal.

The friction band is made in halves and united by a stud bolt screwed into a boss on the front of the pedestal. By means of a bolt a certain amount of friction, between the friction band and the traversing worm wheel, secures the traversing worm wheel to the pedestal rigidly enough to allow the thrust of the traversing worm shaft to traverse the gun, but it does not secure it so rigidly that the teeth of the traversing worm wheel might be injured by the sudden shock of discharge.

There is a spring between the bolthead and the lug on the friction band so that when the bolt is tightened enough to give sufficient friction to enable the gun to be traversed without slipping, it will yet permit slipping in case undue strain is brought on the teeth of the worm wheel. The spring serves to regulate and keep uniform, during rotation, the pressure on the worm wheel. The traversing worm shaft is assembled with its worm in the traversing-gear case.

A pair of bevel gears, in a cast-iron bevel-gear cover, serve to transmit the motion of the traversing handwheel and traversing handwheel shaft, to the left end of the traversing worm shaft. The traversing handwheel shaft is supported in its proper position by two brackets containing suitable bearings. One bracket is bolted to the elevating-gear bracket and the other is bolted to the shoulder rest.

Shoulder Guard.—A bronze shoulder guard, attached to the left side of the cradle by four bolts, carries the firing mechanism, and protects the gunner on the left side from injury during recoil and counter recoil of the gun.

Shield and Supports.—The shield consists of a 2-inch nickel-steel plate bent to shape, shielding the gun and detachment from the front only. It is pierced with two ports, one for sighting and one for the gun. The shield is supported by two shield supports bolted to the pivot yoke.

The center of gravity of the shield, supports, pivot yoke, gun, and charge is so arranged that it falls through the center of the ball-thrust bearing in the pedestal, thus limiting as much as possible the force necessary to elevate and traverse the gun.

Shoulder Rest.—The carriage is provided with a shoulder rest bolted to the pivot yoke on the left side. It is of cast steel, and the shoulder end has mounted upon it a 2.4-inch rubber tube. The

shoulder rest is finished, near its center, to receive a bracket containing the traversing and elevating shaft bearings.

The right side of the pivot yoke is finished so that a shoulder rest for the right-hand side may be attached, if it is desired to use two sights and two gunners.

Special Mounts.—In addition to the types of carriages described above there are some few special types found in the service. The designs of these carriages, strictly speaking, place them under some one of the classes previously given, but the details of their construction are such as to make it desirable to classify them separately.

The carriages for the 4.72- and 6-inch Q.-F. Armstrong Guns (Plates XI and XV) are examples of such carriages and a description of the former follows:

The mounting consists of:

1. A cradle including hydraulic recoil cylinder, trunnions, bar and drum sights, and other parts and fittings complete.

2. A carriage of steel in the shape of a Y, fitted with trunnion bearings for the cradle, and having a long pin, forming the pivot of the carriage.

3. A circular shield with roof supported from the carriage by means of elastic stays or supports.

4. An elevating bracket, fixed to the carriage carrying the elevating gear, shoulder piece, and firing pistol.

5. A pedestal or socket for receiving the pivot pin of the carriage.

Cradle.—The cradle is a single casting of gun bronze, and comprises the frame through which the gun recoils, the hydraulic recoil cylinder, trunnions, spring box, and reserve oil tank. The trunnions of the cradle are supported by bearings machined in the Y-piece, the cradle moving with the gun when it is elevated or depressed. The hydraulic recoil cylinder is directly underneath the gun; it is provided with a piston and rod, forged in one piece. The piston rod passes through a gland at the rear of the cylinder, and is fitted to a projecting arm on the breech of the gun. The cylinder is also fitted with a valve key, controlling ram, drain hole, and air hole.

The action of the carriage on firing is as follows: The gun slides back within the cradle, the force of the recoil being transmitted by the arm on the gun to the piston, and the resistance offered by the oil (with which the cylinder is filled) to the motion of the piston gradually overcomes the force of the recoil. The valve key is of such

a form as to produce, by varying the size of the opening in the piston during recoil, an approximately uniform pressure in the recoil cylinder. The controlling ram is fitted to regulate the velocity of the gun when returning to the firing position. The spring box is under the front part of the cradle. It contains two spiral springs for the purpose of returning the gun and retaining it in the firing position after recoil. The reserve oil tank is cast on the right side of the cradle and is always in free communication with the recoil cylinder. Any leakage which may occur from the cylinder is filled up from the tank. A suitable filling hole is provided at the top. The cradle is provided with bosses for the sights, and with eyes for dismounting purposes.

Carriage.—The carriage of Y-piece carries the cradle and forms the pivot upon which the gun and mounting revolve. The elastic stays for shield and elevating and training-gear bracket are attached to the sides of the carriage, an undercut groove being arranged for the latter in the casting. At the base of the pivot pin is fitted a hardened-steel ring, forming a path for the hard steel balls, upon which the Y-piece revolves.

Pedestal.—The pedestal consists of a hollow steel casting in the form of a cone; the bottom of the casting forms a socket for the forged-steel pivot on the carriage, and is provided with a bronze bush at the lower end to receive the foot of the pivot. A ball bearing consisting of spherical balls of steel is fitted to take the weight of the pivot and to facilitate the training of the mounting.

Elevating Gear.—The elevating gear is carried by a steel bracket, fixed to the left side of the Y-piece. It is actuated by a handwheel, which is placed in a convenient position to be worked by the man laying the gun. The handwheel drives by means of a pair of miter wheels a worm which works the worm wheel. On the inner end of the shaft carrying this worm wheel a pinion is fixed, which gears with the elevating arc attached to the carriage.

The elevating gear is provided with a frictional driving arrangement, as follows: The boss of the worm wheel is hollow, and contains a series of friction rings, part of which are of steel, and are keyed to and turn with the shaft, while the remaining rings are of manganese bronze, and are keyed to and turn with the worm wheel. These friction rings are placed alternately, and are pressed together by means of a spring-steel washer and a nut on the extreme end of the shaft. By adjusting this nut the rings are pressed together sufficiently to produce the requisite friction to prevent the gun running down at extreme recoil,

but at the same time allows the gun to move slightly when fired without giving motion to the whole of the gear. The nut is to be tightened up if the gun runs down when fired. An adjustable pointer is fitted so that the amount of elevation may be read off the back of the elevating arc, which is graduated for that purpose.

Training Gear.—The training gear is fitted on the left side of the carriage, in a convenient position for being worked by the man at the shoulder piece. It consists of a gun-metal worm wheel, with a hollow boss, by which it is supported in the top of the pedestal, and which also forms a top bearing for the pivot of the mounting. A worm, carried in a gun-metal bracket fixed to the carriage, engages with the worm wheel, the worm wheel is fixed to a steel shaft and is worked by means of toothed gear at the rear, actuated by the handwheel.

A gun-metal friction block, which presses against the boss of the worm wheel, is fitted with a clamping screw in the pedestal. Friction between the block and the worm wheel is caused by the handle, and is sufficient to enable the mounting to be rotated. By slackening the clamping screw the mounting is free to be trained by the shoulder.

Shield.—The mounting is fitted for its own protection, and that of the men working the gun, with an outer circular shield $4\frac{1}{2}$ inches thick, and inner flat vertical shield 3 inches thick of steel plate. The outer shield has side wings 2 inches thick and a flat roof 1 inch thick.

The shield is provided with apertures for laying the gun.

Instructions for Filling the Recoil Cylinder.—Depress the gun and take out the filling and air plugs. Fill through the filling hole in the reserve oil tank until the oil outflows through the air hole; replace the air plug, and fill in until the oil overflows at the filling hole; then replace the filling plug.

DISAPPEARING CARRIAGE

In this type of carriage the gun is raised above the parapet for firing and recoils under cover for loading. Plates I, II, and III show in detail the Disappearing Carriage, Limited Fire, Model of 1901; the details of which are as follows:

The Carriage is designed to mount guns of either the model of 1895 or the model of 1900. It embodies many additions and improvements on the previous models, the principal ones of which are general stiffening of the structure, the turntable being 3 inches deeper; a sighting platform along each side of the carriage, accessible by ladders in front and in rear; sight-laying apparatus, with new 3-inch objective telescopic

sight arranged to be used by a man on the sighting platform, who has under his own immediate control all operations of laying and firing, if desired; electric motor as well as hand appliances for the operations of traversing, elevating, depressing, and retracting the gun; the control of the electric-motor equipment from either the sighting or the working platform; connections for electric firing either by the man at the sight or by the battery commander (in salvo); the addition of a safety appliance for electric firing and of a safety lanyard attachment, which prevents firing before the gun is in battery; a traversing brake near the auxiliary traversing controller; improved lubricating appliances, and new counter-recoil buffers, which permit of sufficient counterweight being used to bring the gun into battery in from five and one-half to seven seconds.

Stops can be so arranged as to permit traversing either 60, 70, 90, or 110 degrees either side of the "front" of the battery, and the piece can be elevated from 5 degrees depression to 10 degrees elevation, stops being arranged to limit the depression to either horizontal or 2.5 degrees depression when the height of the parapet requires it.

When in the execution of mechanical maneuvers it may become necessary to traverse the piece breech to the front, which can be done with gun in battery; the fixed stops and the cams of the traversing controller stops must be removed and care exercised that the electric cable in the pit is not injured by traversing the counterweight against it.

The elevating system is so constructed that the gun is at an angle of about 4 degrees elevation when in the loading position if recoiling to the thirty-third notch with any angle of elevation in battery.

Action of Carriage.—Upon firing the piece the gun-lever axle is moved to the rear by the recoiling energy of the gun, carrying the top carriage with it. The lower ends of the levers move vertically upward, being constrained by the crosshead traveling on the vertical crosshead guides. The trunnions of the gun move downward and to the rear. The energy of recoil is absorbed partly by raising the counterweight and partly by the movement of the masses up the inclined chassis rails, but principally by the resistance of the recoil cylinders; and when the gun comes to rest it has the proper loading angle. After loading, the pawls are tripped, and the excess of the moment of the counterweight over the moment of the gun, enables it to raise the gun to the firing position. If this excess be small, the velocity of counter recoil will be slow; but if more counterweight be added, the velocity will increase and the time required for going into battery decrease.

Principal Parts.—The carriage consists of the following principal

parts, viz.: Base ring, azimuth circle and pointer, traversing roller system, racer, clips and dust guards, chassis and transoms, top carriage and recoil rollers, recoil and counter-recoil system, gun levers, crosshead, tripping gear, counterweight, elevating arm, band and slide, elevation and range scales and pointers; elevating, traversing, and retracting systems; working platform, sighting standards and platforms, sight standard and laying mechanism, safety lanyard attachment; electric safety firing attachments; electric motor equipment for traversing, elevating and depressing, and retracting the gun, conduits, wiring, and illumination; accessories, including ammunition trucks, shot tongs, and implements.

Base Ring.—The base ring, 19 feet in diameter, is made of cast iron, in halves, bolted and keyed together, and is held in position on the foundation by twelve 2.75-inch bolts. Twelve screws for leveling the base ring are set against steel plates through which the foundation bolts pass.

The base ring, in addition to having the lower roller path on its upper surface, has an annular flange near its inner edge forming the pintle for the carriage. This flange has near its top edge a lip inward under which the clips engage, and on its top edge the azimuth circle. The inner edge of the lip is rabbeted to receive the felt and steel inner dust-guard strips. The outer annular flange on the ring projects downward into the platform and upward outside of the traversing rollers. The cavities on each side of the roller path are drained into the pit through passages closed by screw plugs in the inner edge of the ring.

Tapped holes can be found inside of the pintle flange for attaching the traversing stops in any required position.

The base ring is marked "front" and "rear" in raised letters cast on the top surface between bolt holes.

Azimuth Circle and Pointer.—A brass azimuth circle, attached by countersunk screws to the top of the pintle of the base ring, is graduated in degrees, the numbers of which are to be added after the carriage is erected in its emplacement. The top of the racer is cut away on the left side to expose the azimuth circle and the micrometer pointer and the subscale, fastened to the racer. The subscale has slotted holes to give it a lateral motion for adjustment, after which it is fixed in position by two dowels. It is graduated and stamped in decimals of a degree, the least reading being 0.1 of a degree. The micrometer screw, actuating the pointer, is graduated to a least reading of 0.01 of a degree. The subscale and pointer is protected by a hinged bronze cover.

Traversing Roller System.—The racer rests and is traversed upon a circle of twenty-four live, conical, traversing rollers, whose axes are maintained in the radial position by bearings bolted to distance rings. They are of forged steel, solid, with a journal beyond each end and with flanges on their inner, small ends.

The distance rings are cast together, of steel, and made up in six sections, bolted together, and have bolted on their upper surfaces the bronze bearings for the traversing rollers. The bearings are formed with a loop on top by means of which any roller with its bearings can be lifted out of the ring through the holes at the racer joints.

The system is kept concentric with the pintle by the flanges on the rollers in centrifugal contact with the inner edge of the roller path on the base ring. The inner edge of the path on the racer is of a larger diameter so as not to come in contact with the flanges.

Racer.—The racer is made of steel, 17 feet and 10 inches in diameter, cast in halves, bolted and keyed together with the joints on the side of the carriage. On each side of the joints are two openings, with removable cover plates, through which four recoil rollers may be lifted out at a time for cleaning.

It is of box section, and, in addition to having the upper roller path on its under surface, has an annular flange lined with bronze near its inner edge and fitting over the pintle, with 0.04-inch diametral clearance.

Upon its top surface the chassis and transom are bolted, doweled, and keyed, and on its outer wall the working platform and traversing-controller stop brackets are bolted to pads.

Two oil holes on each side near the chassis with connecting grooves provide means for oiling the pintle.

The traversing-roller journals are oiled by removing four oil plugs on each side near the racer. In this case the oil drops into annular grooves on top of the distance rings and must be supplied between each roller, thus requiring traversing 90 degrees.

Two additional oil holes, placed 30 degrees on each side of each joint and closed with 0.75 bronze countersunk screws, are for occasional use.

Clips and Dust Guards.—Two clips in front and one in rear are bolted down on top of the inner edge of the racer and engage under the lip inside of the pintle flange. The rear clip extends still lower in the form of a lug, which strikes the stops, limiting the traversing movement.

A dust guard, of angle iron, in six sections, with handles, is bolted to the top edge of the outer flange on base ring.

Felt, and steel pinching strips, inclosing the roller system dust tight,

are bolted to the top edge of the dust guard outside and the pintle flange inside of the roller paths, the felt being compressed against the opposite racer surfaces. The dust-guard sections, with their felt strips, are easily removed.

Chassis and Transoms.—The chassis of cast iron is bolted, doweled, and keyed to the racer and are united at their front and rear ends by cast-steel transoms, also bolted to the racer. The rear transom carries the elevating slide and gearing. The upper surfaces of the chassis form the recoil-roller path and slope 1 degree and 20 minutes to the front to facilitate the return of the piece to the firing position, thus reducing the necessary preponderance of the counterweight.

The chassis also provide the necessary bearings or supports for all the mechanism and, with the racer, supports for all the minor attachments.

The crosshead guides are machined flush on the inside and near the front end. They extend from below the racer to above the top of the piston-rod lugs.

Stops are machined in rear of the lugs against which the top carriage and recoil rollers come to a rest when entirely in battery.

Top Carriage and Recoil Rollers.—The top carriage, which is similar to that of an ordinary barbette carriage, is made of steel, cast in one piece. It consists of two side frames containing the beds for the gun-lever axles, and two recoil cylinders, all united by transoms. It rests upon two sets of 13 live recoil rollers which are bushed with bronze and run on steel axles set into movable steel cages. The rollers are of forged steel and flanged on both ends to guide the top carriage upon the chassis. They move to the rear with the top carriage at half its speed and travel half as far.

Lugs project from the lower front part of the top carriage, which serve as fulcrums for pinch bars held horizontally and engaging with teeth cast on the chassis rail, by which arrangement the top carriage may be moved forward to the firing position against the stop if for any cause it should fail to come fully into battery. When time permits, the top carriage should always be brought fully into battery (against the stops); but, if desired, the gun may be fired when the top carriage is as much as 3 inches out of battery with perfect safety and with no bad results other than inaccuracy in the elevation of the gun, unless this elevation be given by telescopic sight on gun trunnion, or by quadrant on the gun.

Clips projecting from the lower rear part of the top carriage engage under flanges on the top of the chassis to prevent the carriage from

tipping forward upon striking the stops in returning to the firing position.

The axle beds in the side frames are provided with caps clipped on and secured from lifting off by four studs each, having nuts and check nuts. The caps and beds are lined with bronze half bushings.

Recoil and Counter-recoil System.—Figure 18 shows the general arrangement of the hydraulic brake and its connections in its essential principles and in relative positions of parts for disappearing carriages “in battery.”

The recoil cylinders are lined with cast iron and are 13 inches in interior diameter, with piston rods 4.75 inches in diameter, having pistons and counter-recoil buffer plungers forged solid with them. The

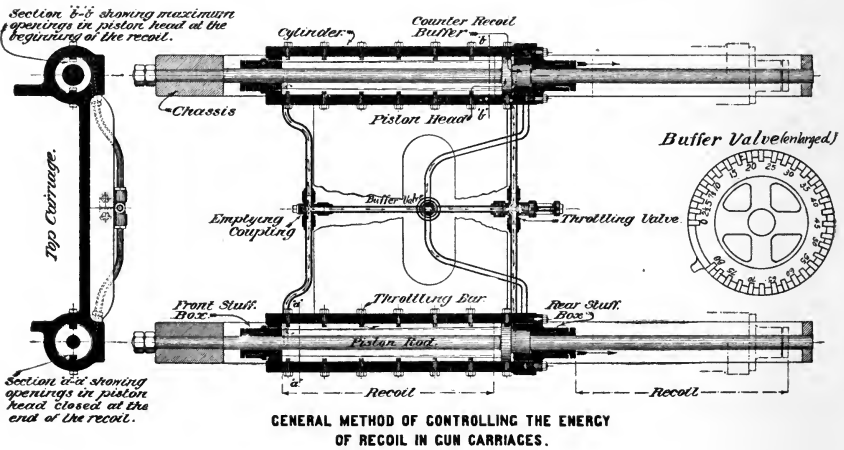

FIG. 18.

rods are secured by nuts and check nuts to upright lugs on the chassis, and extending through the rear cylinder heads, their rear ends are supported by brackets bolted to the chassis. At the ends of the cylinders there are the usual stuffing boxes with glands and followers.

The counter-recoil buffers are formed by annular projections cast on the rear cylinder heads, which fit into the cylinder and are supported by its walls, and which are bushed with bronze inside. In the recesses thus formed fit tapering plungers on the piston rods. When the gun returns to the firing position the liquid caught in the recesses in the cylinder heads can escape only through the small clearance between the plunger and the walls of the recess, thus acting as a hydraulic buffer or dashpot to check the velocity at the end of the return “into

battery." At the front end of the chassis rails counter-recoil stops are provided to prevent the bottoming of the buffer plungers in the annular recesses. Against these stops the top carriage abuts when in the firing position.

Each cylinder has one filling hole near its front lower end.

That portion of the cylinder above the level of the filling holes (about 750 cubic inches in each cylinder) is intended to be empty, this being for the purpose of allowing the oil sufficient space in which to expand when heated by weather or the friction developed in firing, and to provide a space into which the plunger of the counter-recoil buffer may be withdrawn. This withdrawal is accomplished so rapidly in recoil that the oil cannot flow through the small clearances and fill the seat of the buffer without the development of a very high pressure in the cylinder, which would be undesirable.

To secure equal resistance and equal fluid pressure in the two cylinders an equalizing pipe connects their front or pressure ends. In this pipe is an emptying coupling by which the whole recoil system can be emptied of oil. From this coupling a connecting pipe extends back to the throttling valve, and from this valve pipes connect with the rear ends of the cylinders.

Bronze plugs are provided, to be screwed into the cylinders in place of the equalizing and throttling pipes, thus continuing the piece in action should the pipes be destroyed.

During the recoil the pistons remain stationary and the top carriage with its cylinders is drawn over them. Each piston is slotted through its opposite sides and two throttling bars lie in the slots and are bolted the whole length of each cylinder. Their sectional area is such that the orifices for the flow of the liquid vary with the position of the piston during recoil so as to attain the desired resistance in the cylinders.

In any hydraulic brake the resistance is greater as the velocity of the piston in the cylinder is greater and as the openings for the passage of the liquid are less. The velocity of retarded recoil of the top carriage being variable and a constant resistance being desired, the orifices are usually varied in such manner that the relation between the velocity and the area of the orifices is at all points such as to give a nearly constant resistance.

Uniform resistance to the motion of the top carriage is obtained, its motion retarded and finally stopped and the energy of recoil taken up, principally by the resistance which the oil in the cylinders offers to being forced from one side of the piston to the other, through the following openings:

1. The clearance between the walls of the cylinder and the piston, necessary for working movement. This opening is of constant area.

2. The orifices between the throttling bars and their slots in the piston. These openings vary with the profile of the throttling bars, since the slots, which are partly closed by these bars, are of constant area.

3. The opening of the throttling valve which controls the flow through the pipes connecting the front and rear ends of the cylinders. This opening is of constant area during recoil, but can be completely closed or changed to suit different conditions of loading and to correct for any other conditions that would cause a variation in the length of recoil.

The two throttling bars in each cylinder are constructed of constant width having only a sufficient lateral clearance in the slots for working movement, and of varying depth, the profile being so designed that the area of the orifices (the portions of the slots not filled by the bars) for the escape of the oil past the piston increases from beginning of motion up to the point where the velocity of retarded recoil of the top carriage is greatest; beyond this point the velocity of retarded recoil of the top carriage is continually decreasing and the area of the orifice decreases also until it becomes zero at the end of recoil. The orifices have at each point of recoil such a relation to the velocity of retarded recoil of the top carriage at that point as to give merely a constant resistance to the motion of the top carriage. This results in a merely constant fluid pressure in the cylinders.

The areas of the orifices have to be calculated for a particular set of conditions of loading, and any variation in these conditions will change the length of recoil of the top carriage, and consequently the height and inclination of the breech of the gun in the recoil position. As the standard conditions of loading do not always exist, it has been found desirable to provide means for varying the resistance of the hydraulic recoil brake in order that the prescribed length of recoil (bringing the gun into the prescribed loading position) may be obtained under any conditions, standard or not standard—as, for example, when charges other than full service are fired.

For this purpose the equalizing pipes between the front ends of the cylinders are connected with the throttling pipes between their rear ends through the emptying coupling and a throttling valve, providing oil passages from the front or pressure to the rear side of the pistons, which can be completely closed or changed in area. (*This throttling valve can be adjusted to give openings varying by 0.025 square inch from*

zero to 0.55 square inch.) *The graduations of the valve are stamped on the top of the body, there being 11 divisions, numbered 0, 0.05, 0.10, etc. (One complete turn of the valve effects the change of 0.05 square inch in the opening. One-half turn effects a change 0.025 square inch.)* One complete turn of the valve yoke generally changes the length of recoil by the equivalent of 3 or 4 notches on the crosshead rack. This is liable to vary by a notch or more for different carriages or for the same carriage under different conditions.

The setting of the valve best suited to different conditions of loading, full or practice charges, etc., can be determined only by experience in actual firings with each particular carriage. For carriages on which new buffer valves have been attached see how to set valves as described under "BUFFER VALVE." Different carriages may require different settings, and the same carriage may even at different times require different settings for the same conditions of loading if it is in a materially different condition as to cleanness and lubrication of the working parts, etc. It is necessary, therefore, that careful records be kept, not only of the setting of the valve, the conditions of loading and recoil, but also of the elevation of the piece and any abnormal condition of the carriage which might affect the freedom of its operation. These records should be studied in the light of all these circumstances to obtain perfect working. However, the ammunition trucks are so designed that the loading position may vary somewhat without material inconvenience, and it is generally possible after a few firings with a carriage to determine the setting of the valve which will result in the gun coming into a proper loading position for any conditions of loading. *For full charges the valve should, in the lack of experience with the particular carriage, be opened to about 0.15 square inch, but not more.*

A padlock is provided for locking the valve yoke in any position to guard against accidental or unauthorized changes in the position of the valve after it has been set. The valve should habitually be kept locked, but this should not be understood as discouraging examination and manipulation of the valve, which are, on the contrary, highly desirable for the sake of familiarizing the personnel with its construction and operation.

For all charges, the cylinders should be filled to the level of the filling holes, removing for this purpose both plugs so as to permit the air to escape.

A neutral oil, of specific gravity about 0.85 (such as the "hydro-line" at present issued), is used, and with this oil the working pressure in the cylinders is about 1,200 pounds per square inch. A denser

oil would cause a higher pressure in the cylinders and therefore shorten the recoil slightly.

For the purpose of reducing the shock of accidental excessive recoil, recoil buffers, made up of alternate layers of balata and steel plates, are placed on brackets bolted to the rear of the chassis, where they will be struck by the upper ends of the gun levers if the gun is retracted or recoils beyond its proper position.

The notches between the ratchet teeth cut on the front faces of the crosshead clips are numbered from the top, the numbers being opposite the notches on brass strips screwed to the crosshead. When the top pawl teeth, indicated by brass arrows screwed to the pawl levers, engage in the thirty-third notch the gun is in its calculated loading position, *below which it should not be retracted*. By a proper adjustment of the throttling valve the recoil of the gun should not vary much from this position. The ammunition truck will, however, permit the gun to be loaded anywhere between its position when the pawls engage in the twentieth notch and the lowest possible position—gun levers on the balata counter-recoil buffers.

In case the gun recoils far enough for the pawls to engage, but not sufficiently for loading, it may be brought down by the use of the retracting gear.

From the foregoing description of the recoil system it should be evident that should the carriage recoil too freely the proper correction is in a diminution of the opening of the throttling valve, not in an increase of the counterweight. On the other hand, the counterweight alone should be changed to correct or modify the counter-recoil.

The amount of counterweight can be determined by trial. However much of the counterweight furnished be used, it will not materially affect the length of recoil.

On account of the efficient counter-recoil buffers, considerably more counterweight (5,000 or 6,000 pounds or more) can be employed on this carriage than is necessary to bring the gun to the firing position, without injury to the buffer or cylinders or injurious shock to any part of the carriage. This extra counterweight acts to accelerate the counter-recoil and thus the time of going into battery completely is reduced to $5\frac{1}{2}$ to 7 seconds from the instant of tripping.

Gun Levers.—The two levers are made of cast steel connected near their upper ends by a cast-steel yoke firmly bolted, and at a point a little below their middle by the forged-steel gun-lever axle, which is fastened to the lever by bolts passing through its heavy flanges. The gun levers are supported by this axle, the projecting ends of which

serve as trunnions supported by and rotating in the axle beds in the top carriage.

The upper arms of the levers support the gun and from their lower ends the counterweight is suspended by crosshead pins.

The trunnion beds are provided with cap squares clipped on and secured from lifting off by two studs each, having nuts and check nuts. The caps and beds are lined with bronze half bushings.

Crosshead.—The crosshead, of cast steel, is connected by pins to the gun levers and from it the counterweight is suspended by four keyed rods.

Clips formed in one piece with the crosshead are lined with bronze and engage over crosshead guides cast on the inside of the chassis rails. These guides constrain the crosshead to move in a vertical direction.

Ratchet teeth are cut on the front faces of the clips, to be caught by pawls pivoted to the chassis rails, and in this way the counterweight is held up and the gun is prevented from returning to the firing position after recoiling.

Tripping Gear.—After the gun is loaded it is permitted to rise to the firing position by raising the tripping levers until they unlatch, and immediately leaving them in that position.

The action is entirely automatic after the pawls are latched out of engagement and the gun starts into battery. After the crosshead teeth have passed entirely below the pawl teeth and the gun is nearly in battery the pawl levers are released from the latches by the automatic action of dogs on the crosshead, and are returned by the moment of the weight of the tripping levers, to their proper positions ready to engage the crosshead when it again rises. The pawls may be tripped by the use of one or both levers. The levers should not be raised while the gun is in battery, but should the pawls become latched out of engagement at this time, the rising of the crosshead will again release them for engagement.

Counterweight, Bottom Plates, and Suspension Rods.—The bottom plate, of cast steel, and the four rods which suspend it from the crosshead form the cage which carries the lead counterweight. The counterweight is piled in the cage in layers of different thicknesses, each layer consisting of two or more pieces. There are 72 smaller pieces on top provided with rings for easy handling. These weigh in all about 5,967 pounds. By adding or removing some or all of these smaller weights the counterweight can be readily increased or diminished. The total amount of lead counterweight furnished with the

model of 1895 rifle is 98 pieces, weighing approximately 142,011 pounds, and forming a pile, including bottom of cage, 7 feet 10.25 inches high. That furnished with the model of 1900 rifle is 102 pieces, weighing approximately 164,705 pounds, and forming a pile 9 feet high. In some carriages there is an extra layer 3.6 inches thick, the first nine layers being 6.35 inches instead of 6.75 inches thick. The total height and weight are the same.

The amount of lead counterweight sent with each carriage is designed to be 5,000 or 6,000 pounds *in excess of that required to raise the gun to the firing position* under normal conditions. No matter what charge be used, the counterweight used should be such as will raise the gun completely to the firing position in about five and one-half to seven seconds, but should never be such as to cause the top carriage to strike the counter-recoil stops with great shock. In its lowest position the counterweight hangs in a well formed in the concrete platform concentric with the base ring 12 feet 6 inches in diameter and not less than 93 inches in depth, measured from the under side of the base ring. Access to the bottom of the pit is obtained by means of a ladder and a manhole in the right inside platform.

Elevating Arm, Band, and Slide.—The elevating arm of cast steel carries a fixed double-ended pin at its lower end, rotating in bearings in the elevating slide, and has two solid bronze-bushed bearings at its upper end for the elevating-band trunnions.

The band is of cast steel, with inserted trunnions screwed to their conical seats and with teats on their inner end, which enter shallow holes in the gun at accurate distance from the trunnions on each side and in the same horizontal plane with them. The band is tightly clamped around the gun by two heavy bolts. Their inside diameters are for the gun of the model of 1900, 48.5 inches, and that for model of 1895 44.5 inches.

The elevating slide is moved by the elevating-gearing system, in an inclined guideway machined on the rear face of the rear transom, which guideway allows it the movement necessary to change the elevation of the gun from 5 degrees depression to 10 degrees elevation. There is provided a removable stop, to be placed in holes in the right side of the guideway and above the slide, limiting the depression to either 0 or 2.5 degrees, as may be required by the parapet over which the gun is to be fired.

While theory requires, in order that the gun when recoiled to the thirty-third notch shall always return to the same angle for loading, with the breech at the same height, whatever may be the firing angle,

that the elevating slide and its guideway shall be circular and struck with radii, using the center of the trunnion on the elevating band, when the gun is in the loading position, as a center, yet the expenses of manufacture have made it desirable to make the slide and guideway straight. These are so placed, however, as to cause only a slight variation in the height of the breech and in the loading angle.

Range and Elevation Scale and Pointer.—To the elevating slide is bolted a bronze elevating scale carrying straight German silver scales, graduated in degrees and minutes of elevation and in yards of range.

On account of the character of the motion of the parts the distances between the successive degree marks on the elevation scale are not the same, requiring the scale to be graduated by the use of a clinometer supported by a rest placed in the muzzle of the gun, after the gun is mounted upon the carriage, at the time of the shop test.

As the ranges corresponding to different angles of elevation above the horizontal depend upon the height at which the gun is mounted above the sea level, the range scale must be graduated after mounting, the ranges corresponding to the different angles of elevation for the height above sea level, and for the muzzle velocity *normally* used must be calculated from the range tables and formulas and marked upon the scale in the proper place. *This should never be done except under the supervision of the Ordnance Department.*

In smooth contact with the scale and attached to the rear transom by bolts in oblong bolt holes is a range and elevation pointer, having, on account of the oblong bolt holes, a motion to permit any needed adjustments, after which it is to be fixed in position by two dowels.

There has been attached for trial upon the first carriage of this model a circular elevation and range scale which, if found satisfactory, will be substituted for this straight scale upon succeeding carriages. The advantages of such a scale are that it can be placed outside of the chassis, where it is more convenient for reading, and that it can be made of greater length with corresponding increase of the size of the smallest sub-division. It consists of a circular wheel carrying the graduated scale at its outer circumference and mounted upon a shaft which has keyed to its inner end a pinion engaging in a rack bolted to the elevating slide in the place of the straight scale. The up and down motion of this rack rotates the pinion and shaft and the circular wheel carrying the scale. The pointer is similar to that for the straight scale except it is curved.

It is probable that the range scale will be improved by making

each range graduation correct for all muzzle velocities from the minimum now in use to the maximum probably obtainable in the future. These graduation lines will of necessity be curved so that one end will be correct for the minimum velocity, the opposite end for the maximum velocity, and intermediate points for intermediate velocities. A sliding index or pointer will be used to indicate the correct elevations for corresponding velocities.

In use, and knowing approximately the velocity to be given the projectile, the pointer is adjusted across the scale so as to intersect that point on the line which indicates the elevation required for the expected velocity. Should the shot fall 100 yards short, the pointer is readjusted to intersect that point which will indicate the required increase in elevation.

It follows that, with the pointer set to correctly indicate the point in the 6,000-yard line for the velocity used, if the wheel be rotated so that the pointer intersects the 3,000-yard line it indicates the correct elevation for that range for the same velocity.

Elevating System.—Two handwheels are attached to the ends of the elevating shaft, to be manipulated by two men standing on the gun platform, one at each wheel. These wheels actuate through a train of bevel and spur gearing, a forged-steel elevating screw operating the bronze elevating slide nut. This slide nut actuates the elevating slide, to which the lower end of the elevating arm is pivoted, through the medium of two helical springs, interposed to relieve the arm from shock due to the downward thrust when firing with the gun elevated.

Upon this carriage no separate spring buffer stops are provided, as the buffer springs between the slide and nut fulfill the requirements. At the limit of depression of the gun the slide strikes a positive stop and the nut is stopped by the spring; at the limit of elevation the nut strikes a positive stop and the slide is stopped by the spring.

In order to render the power required for elevating and depressing as nearly equal as possible, the downward thrust of the elevating screw in depressing is borne by a ball-thrust bearing placed beneath the elevating-spur gear and inclosed with it on top of the rear transoms. When depressing the gun by raising its breech (during which operation the men at the wheels have to overcome a certain preponderance, due to weight of elevating arm, etc.), the top disk of the ball bearing rotates with the elevating-spur gear upon the rolling balls and the frictional work to be overcome is reduced.

When elevating the gun by lowering its breech the preponderance above mentioned assists instead of opposes the motion. Therefore, to

prevent the slide from running down, due to the weight upon it, during this operation as well as in firing, the top disk is arranged with ratchet teeth to be engaged by pawls, which prevent its rotating in the direction for elevating by locking it to the transom. By this locking device the ball-thrust bearing is thrown out of action *when elevating* and the elevating-spur gear is obliged to turn on a bronze washer interposed between it and the fixed top disk of the ball bearing, thus increasing the frictional resistance over what it would otherwise have been.

Counterbalance Device.—In order to still “further equalize” the power required for elevating and depressing, an attachment has been designed for this carriage, called a “counterbalance device.” This consists of a weight hung by a double wire rope which passes over pulleys and is attached to the elevating slide nut so as to oppose and partially counterbalance the weight of the slide and half the weight of the elevating arm.

The use of too much balance weight will result in an upward thrust on the elevating screw, conducing to serious wear on the under side of the screw bearing.

Traversing System.—For pointing in azimuth by hand power, two crank handles may be attached to the traversing shaft and manipulated by two men standing on the working platform, one at each crank. From this shaft motion is transmitted by two pairs of bevel gears to the vertical shaft in bearings on the chassis and racer, the pinion at the lower end of which engages in the circular traversing rack bolted to the base ring and by its rotation causes the racer and all parts carried thereon to rotate upon the rollers and around the pintle surface.

While the construction of the carriage itself permits it to be traversed 360 degrees, stops are provided which are to be screwed to the inside of the pintle above the traversing rack, limiting the movement in azimuth as may be required by the emplacement in which the gun is mounted.

To prevent excessive shocks to the traversing gearing or other parts, due to striking obstructions or to too sudden application of power, etc., the intermediate bevel gear wheel is not keyed to the shaft, but centered upon and held frictionally by three disks, free to move longitudinally on two feathers made solid on the pinion shaft, and pinched between a solid collar above and an adjusting nut below. The nut is locked by being jacked apart with a set screw at a cut which extends partly across.

The friction surfaces are provided with oil grooves, which together with the spaces between the disks, are to be *kept filled full* with oil

through a hole in the top end of the shaft. The adjusting nut should be set up just enough to rotate the carriage by hand without slipping. It is intended that in rotating by power suddenly applied the disks shall slip at first, and thus pick up the load gradually.

Traversing Brake.—In a convenient position on the racer, outside of the left chassis and near the azimuth pointer and the controller auxiliary handle is the traversing brake. This consists of a vertical guide attached to the racer, in which slides a brake clamp with a toe designed to grip under the lift on the inside of the pintle when pulled up against the latter by the brake screw. This screw is threaded into the upper end of the brake clamp and when screwed down by a clockwise motion (as viewed from above) of the handle, its lower end bears upon a hardened plate upon the racer, and thus draws up the brake clamp and sets the brake. A notched flange on the upper portion of the screw bolt enables the handle to be set at a convenient position, in which it is retained by screwing down the nut above it. This handle engages under a spring catch in its "off" position to keep it out of the way.

Retracting System.—For hauling the gun down by hand two removable crank handles may be attached to the retracting crank shaft and maneuvered by eight men standing on the gun platform, four working on each crank. The retracting crank shaft actuates through a train of three pairs of spur gearing, two drums, to which are fastened by corrugated clamps two wire clamps, which wind upon the drums. A ratchet and pawl prevents the load from overhauling the gearing. From the drums these ropes pass around guide pulleys in rear of the recoil buffers and are hooked to the upper ends of the gun levers. These ropes remain with the carriage, and when not in use are wound upon the drums until the ropes project but a short distance from the guide-pulléy brackets.

For rapid and easy overhauling of the ropes, two small speed cranks are fixed to the crank shaft back of crank handles. To save time these should also be used to wind up the slack of the rope before placing the crank handles on the shaft. In hauling down, care should be exercised that both ropes are under *equal tension*.

After taking up the slack in the ropes and putting some strain on them, they should be vibrated slightly, and if found to be unequally loaded, adjustment should be made at the rope clamps on the drums. After the loop of the rope is placed over the hook on the gun levers, and while winding up the slack, special care should be taken that the rope is guided to the pulleys without any kinks or any slack and that

the coils lie smoothly upon the drums without crossing the ridges between the grooves.

On account of the extra counterweight used to decrease the time of going into battery, the operation of retraction requires the application of considerably more power than would otherwise be the case. Retraction by hand power will, therefore, be found somewhat difficult. This is, however, not expected to be objectionable, as retraction by the electric motor supplied is regarded as the normal practice, retraction by hand being provided for use principally in case of trouble with the electrical plant.

In case retraction by hand is desired to be habitually used, as for example during the drill season, the amount of counterweight may be reduced to about 158,000 pounds for use with the gun of the model of 1900, or to about 135,000 pounds for use with the gun of the model of 1895. With these reductions in the counterweight, the time required for the gun to go into battery will be increased to about twelve or thirteen seconds.

Retracting Gear, Clutch, and Brake.—To permit the most rapid overhauling of the wire ropes possible there has been added a spring-engaging claw clutch for rotating the drum shaft from the drum gear in retracting. With the clutch thrown off, the ropes can be drawn out quickly, revolving the drums and shaft rapidly in the drum gear.

In order to prevent overrunning and injury to the ropes a band brake is added, gripping the hub of the left drum upon lifting a crank handle. The clutch is thrown off by drawing a loop handle on the left side until the feathers are drawn out and permit the handle to be given a quarter turn, which locks the clutch off with the spring compressed.

When enough rope is overhauled the brake handle is raised to stop the shaft, the loop is given a quarter turn back to permit the feathers to enter, and the spring moves the clutch, on its feathers in the drum shaft, to engagement.

Working Platform.—The outside platform of plates and angles is flush with top of racer, is supported on radial cast-steel brackets bolted to it, and covers the recess around the turntable flush with the fixed part of the platform.

The inside platforms, supported by the racer and chassis, cover the sides of the counterweight well. On the right side a manhole and ladder are provided for entering the well.

Sighting Standards and Platforms.—These platforms of plates and angles extend along each side of the carriage, supported in front by brackets bolted to the top of the crosshead guides on the chassis and

in rear by standards bolted to the racer and chassis. The brackets and standards are of steel castings.

A flight of steps is provided at the front and rear end of each platform. Hand rails and a screen to protect the gunner's body from the elevating arm during recoil of the piece are also provided. These platforms furnish not only a station for sighting and pointing and firing (by electrical power), but also a convenient means of access to the gun, retracting hooks, trunnion beds, etc., for oiling or other purposes, e. g., for inserting a new primer.

Sight Standard.—This standard is a steel casting, seated and clamped in a split socket in the top of the left standard. It extends forward as a bracket, forming a pivot and guide for the sight arm which carries the combined bar sight with the new 3-inch telescope. The pivot is at such height that the sight lines may be depressed 6 degrees if necessary, when firing gun at 5 degrees depression, and still pass over the crest of the parapet.

Counter-set screws are provided at the socket for making a slight adjustment in rotation and in fixing the standard, the line of collimation of the telescope and open sights in a vertical plane, parallel to a vertical plane through the axis of gun.

To this standard is also attached the bracket supporting the controller extensions and handles, the firing pistol, and the box protecting the rheostats for adjusting the lights which illuminate the sight graduations.

For use on the right trunnion, the telescope sights in service are the models of 1896 M₁, of 1897, of 1898, and of 1898 M, described in Chapter VII.

Sight-Laying Mechanism.—A pair of bevel gears transmits the rotation of the elevating-wheel shaft to the sight-elevating screw, which, working in a threaded bearing in the sight-elevating slide, causes the latter to move up or down in a guideway formed upon the rear of the left standard near its base. To this slide is pinned the lower end of the sight-elevating arm, which is partly inclosed in the standard, and to the upper end of which is pivoted the rear end of the parallel arm and the lower end of the sight-arm link.

To the upper end of the sight-arm link is pivoted the rear end of the sight arm. The front sight arm and the parallel arm being of the same length between centers of pivot holes and their front ends being pivoted in fixtures attached to the standard, and these pivots being at a distance from each other equal to the length of the sight-arm link, a true parallel motion is secured between these two arms; and the sight-

elevating arm and gearing are so proportioned that each of these arms is kept always at the same angle of elevation as the axis of the gun. The sight-arm link is inclosed in the standard, and the parallel arm is in a bracket, attached to the standard, which protects it but which is open at the top.

The sight-elevating screw is not solid with or keyed to the bevel gear by which it derives rotation from the elevating shaft, but is frictionally held thereto by the pulling down of its cone head into a friction seat in that gear by a nut on the screw, which, through a washer, presses against a bushing, which, in turn, presses against the bottom of the gear. The washer has a feather entering a slot in the screw, to insure its rotation with it. The nut is slit half through transversely and furnished with a set screw to permit jamming it on the threads after the screw is adjusted. After loosening the nut, the sight-elevating screw may be freed from its gear and rotated by the hexagon lower end, and the sight-elevating gearing thus be moved, for adjustment, independently of the gun-elevating mechanism.

The parallel arm has a true upper surface which furnishes a seat for a level for testing horizontality thereof. The parallel arm is, for this reason, also placed at a convenient height for a man standing on the gun platform. After adjusting the parallel arm to be horizontal when the gun is horizontal, the nut on the sight-elevating screw should be screwed up tight against the washer, bushing, and gear, while motion of the screw is prevented by a wrench applied to its lower end. The nut should then be jammed by its set screw.

By these means the bevel gear is firmly held to the sight-elevating screw, and any motion of the elevating slide, being accomplished by a rotation of the elevating shaft, produces through this bevel gear and its mate a rotation of the sight-elevating screw, which, in turn, causes the sight-elevating slide to move in the same direction as the elevating slide. Thus the sight-elevating arm is moved up or down, causing in the parallel arm and sight arm an angular movement the same as the movement produced in the gun itself.

In the final adjustment of the combined telescopic and bar sight the horizontality of the parallel arm may be slightly disarranged.

Lanyard Safety Attachment.—This is to prevent the firing of the piece by a pull, accidental or otherwise, upon the lanyard before the gun has risen to the firing position; that is, before it has been raised to such a height that the projectile will clear the parapet. It consists of an incased reel, attached to the elevating band, upon which a short cable is automatically wound by a spiral spring, and locked, except

when piece is in battery, by a ratchet and pawl. One end of a short lanyard is hooked to the primer and the other to the end of this cable. The long lanyard in the hands of the cannoneer is also hooked to this cable. A pull on the lanyard, when gun is out of battery, cannot unwind the cable, pull the short lanyard, or fire the primer. When gun rises in battery, a cam on the elevating band passing under the pawl lifts it out of engagement with the reel, which can then be unwound, permitting the primer to be fired.

The initial tension of spring should be sufficient only to wind up the cable with lanyards attached. It may be adjusted by loosening the nut on the spring shaft and with wrench on the squared end of shaft (projecting from the center of the case) withdraw the locking pin and wind up or unwind the spring, returning the locking pin to one of the quarter-turn positions and tightening nut.

Electric Safety-Firing Attachments.—The carriage is arranged to permit electric firing either individually (by a key on the sighting platform or one on the working platform) or in salvo (by a key in the battery commander's station). To arrange for firing by whichever of these methods is desired, a double-pole, double-break, double-throw switch in the Signal Corps' outlet box is turned to the proper [indicated] position. This connects with a source of electrical power two of the four wires from this switch to the carriage, namely, either the two wires tapped directly into power mains in the emplacement (for individual or "gun" fire) or the two wires leading back through the battery commander's firing key to the power mains (for battery or salvo fire). The latter two wires are led without any interrupting switch or key to the "safety-firing switch" on the left chassis (connecting with the front lug of the top carriage).

The former two wires are broken at the two firing keys on the carriage in such manner that the closing of either key closes the circuit; they then go to the safety-firing switch. This switch is designed to break the firing circuit automatically as soon as the top carriage has recoiled. The firing circuit cannot be reclosed at this point until the top carriage returns to battery (within 2.5 inches of its prescribed firing position). The circuit is even then not reclosed automatically, but is to be closed by the *intentional act* of a cannoneer after the gun is laid and otherwise ready to fire. Thus the battery commander cannot fire the gun before the gun commander has completed the laying, etc., and is ready.

However, as it may be desirable in firing, piece by piece, to obtain the maximum rapidity of action by firing immediately the gun comes

into battery, the switch is so arranged that it *may be set* to make contact automatically when the top carriage is in battery. Then the piece can be fired by pressure of one of the firing keys. *This must never be so set, however, for battery fire*, as a shot might be lost or someone hurt by the battery commander firing after the gun was in battery but before it was properly laid or before all cannoneers were in safe positions. *This setting for automatic action should never be made except by express order.*

The Safety-Firing Switch is essentially a double-pole, single-brake, single-throw knife switch, the body carrying the two knife blades being pivoted to the chassis and the double blades, or sockets for the knives to make contact with, being fastened to the lug of the top carriage. When the top carriage is in battery the sockets are directly above the knife blades, and if the body is raised by hand until the blades engage in them the circuit will be closed at this point, and the spring grip of the sockets upon the blades will support the weight of the body and keep the contact made until the top carriage moves to the rear and releases the blades, when the body will swing downward about its pivot on account of its own weight.

As long as the top carriage is not in battery it is evident that contact cannot be remade, since the sockets are not within reach of the knife blades. Even when the top carriage returns to battery there is no tendency of the body to rise (against its own weight) and make contact, so that it must be lifted by a man.

The automatic remaking of contact is secured *when ordered* by raising the support which holds the body always in its upper position, in which case the blades will engage in the sockets as the top carriage comes into battery.

Electric Motor Equipment.—The carriage is provided with a complete electric motor equipment. This consists essentially of a motor, with its controller and other adjuncts, for traversing the carriage, and another motor, with its controller and other adjuncts, for either retracting or elevating and depressing, according to whether the maneuver lever is set to throw the idler gear carried by it into mesh with the gear on the retracting or that on the elevating shaft.

The motors are of the completely inclosed type, supported by cast-steel brackets bolted to the inner side of the left chassis.

The traversing motor has a pinion upon its shaft which engages directly with a gear upon the traversing crank shaft. There is no means of throwing this gear out of mesh, and consequently the motor armature rotates when the carriage is traversed by hand.

The elevating and retracting motor shaft extends through a bearing in the opening in the chassis, and in an improved design is supported at its outer end by a bracket bearing. A cast-steel maneuvering lever is arranged to oscillate on the motor shaft and to carry an idler gear on a fixed pin and in mesh with the motor pinion, between its branches. The top end of the lever is guided in and may be pinned, in three different positions, to an arc attached to the chassis over the motor shaft.

With the lever in the forward position the idler is in mesh with a gear on the retracting crank shaft, in which case the motor will retract, and with the lever in the rear position the idler meshes with the gear on the elevating-wheel shaft and the motor elevates or depresses the gun. When pinned in the mid position the idler is free from both gears and the motor armature will not be revolved by elevating or retracting by hand.

This lever also throws the commutation switch so that in retracting two rheostats in multiple enable the motor to do more work than when elevating or depressing the gun.

The lever should never be left unpinned, and should never be shifted when the motor or any part of the gearing is in motion. Care should be taken in shifting that the teeth of the idler are opposite spaces in the gears.

The two controllers, one for the traversing, one for the elevating-retracting motor, are placed side by side on a frame bolted to the working platform immediately in rear of the left standard. By turning the shafts of these controllers by the handles provided, the electrical connections within are changed in such combinations as to start, stop, and give the different speeds of motion provided for. When turned to the off position the connections are so arranged that a short circuit is made from brush to brush, thus closing the circuit through the armatures of the motors while the field magnets remain energized. Forced rotation of the armatures then cause the motors to work as generators, which requires that work to be done by the force which rotates them. *The motors under these circumstances are therefore brakes.*

This brake effect does not become operative in the elevating-retracting motor until the controller reaches the off position, so that if the handle be turned quickly to that position while the gearing is running at full speed the motor armature would be rotated rapidly and the strains due to the brake action would be severe. The traversing motor, however, does operate as a brake to reduce the speed of traversing whenever the controller handle is turned *toward* the off position—that is,

whenever the controller is set to a slower speed than that at which the motor is running. This is due to the fact that this motor has a current of variable voltage supplied to it, the voltage determining the rate at which the motor runs *as a motor*. If the motor be actually running at a higher speed than that for which the controller is set, its counter electromotive force exceeds the impressed voltage, thereby generating a current which tends to reverse the direction of rotation of the generator—that is, to drive it *as a motor*. This, of course, requires work to be done by the force tending to rotate the traversing motor at the higher speed, and as this force is the inertia of the moving carriage, the result is that the speed is slowed down by this braking action. Therefore, when the controller comes to the off position the carriage should have less remaining velocity to be overcome by the brake effect of the motor when short-circuited than would otherwise be the case, and the carriage therefore is brought to rest more promptly and at the same time with less strain. To secure the full effect of this action the controller handle should be turned rather slowly, so that the retarding brake action may be of some duration.

The elevating-retracting controller has wired between it and the motor a commutation switch, automatically set by throwing the maneuver lever, so that when elevating or depressing, the upper rheostat only is inserted, permitting the motor to operate at 4 horsepower, and when retracting the second rheostat is thrown in multiple with the first, thus permitting the motor to operate at 8 horsepower.

Resting upon the squared upper end of the shaft of each controller is a shaft called the "controller extension," which reaches to a convenient height above the sighting platform and has its upper end squared to receive the controller handle and thus permit rotation of the controller shaft, and operation of the motor, from the sighting platform. This controller extension may be lifted without releasing any catch, and the controller handle may be put upon the squared upper end of the controller shaft for operation from the gun platform.

In addition to the above, the traversing controller has its shaft connected by two pairs of bevel gears to a short vertical shaft on the racer near the azimuth pointer. The handle may be placed on this shaft and the traversing controller operated from this point when it is desired to lay the gun to a given azimuth by the scale and pointer (Case III). *Only one set of controller handles is provided* (that is, one handle for each of the two controllers), and are marked to show the direction in which the handle should be moved to produce motion in the direction stated. *The hand of the operator indicates the direction*

of motion and may be regarded as the pointer. (To simplify the action as much as possible the direction of motion of the handle of the traversing controller is the same as the motion of the gun).

The farther the handles are moved from the "off" position the greater is the resulting speed. As any mass acted on by a force requires time to acquire its maximum velocity, so the carriage requires a short time to acquire the velocity corresponding to any position of the handles. It is well, therefore, to move the handles somewhat slowly in changing speed to avoid getting up more speed than is desired. *Too sudden turning of the handle, moreover, imparts a greater acceleration and correspondingly severe strain upon all parts.* It may result in breakage, and is very apt to cause opening of circuit breakers (due to overload), which will mean a short delay to close them, which may be of importance in action or target practice.

There are two circuit breakers on the carriage, one for each motion, placed in an iron box bolted to the under side of the rear projection of the left chassis. They are capable of adjustable setting, and should be set to open at about 40 amperes for the traversing and about 70 amperes for the elevating retracting motor. Any electrician sergeant will understand how to set them. When a circuit breaker opens on account of overload, the handle swings over from the right to the left, the circuit is broken, and no current can pass. To reclose the breaker remake the circuit, and allow the current to pass again—simply move this handle back to the right.

If the carriage were traversed up to the positive stops at high speed with electric power, damage would probably result. To prevent this an automatic traversing controller stop is provided. A cam is bolted to the base ring near the extreme limit of traversing "muzzle right," which, when struck by the "shipper" (an arm fixed to the shaft carried by the racer), presses this shipper gradually outward in such manner that, by suitable gear connections, the traversing controller shaft is gradually turned to the off position. Thus the speed of the carriage is reduced and the traversing is finally stopped. By shifting the cam until the correct position is found the carriage may be traversed at full speed to the stop, and will come to rest very close to the extreme position allowable. *Once set by the Ordnance Department, this cam should not be shifted.* A similar cam actuating another shipper on the same shaft limits the left traversing. *In spite of these safety stops it is recommended to slow the carriage down as it approaches the end of its allowed motion.*

No such safety stops are provided for the elevating, depressing, or

retracting on account of the complication involved and the smaller necessity existing. In these operations safety and proper action will depend upon that proper care in manipulation which all machines should receive. At the same time, should these motions accidentally be continued until the limiting positive stops are struck, it is probable that nothing more serious than opening of the circuit breaker would result.

A detailed description of the electrical equipment furnished by the manufacturers should be studied by those in charge. It will be found to relate more particularly to the electrical features of the equipment, those with which the officer in charge of the post electrical plant and his assistants are principally concerned, while the above notes have dealt with mechanical features and with appliances and operations with which the officer in charge of the armament and the gunner and cannoneers operating the carriage are most directly concerned.

The following data and suggestions relative to operation of the motor equipment, as well as those heretofore mentioned incidentally to the description, are based upon the experience so far had with these equipments, and are subject to revision in the light of more extensive experience, but will be found useful as guides to the proper use and care of the equipment, and as criteria for judging its condition:

(a) There is nothing to prevent the running of both motors simultaneously. If the power supply is inadequate, this will simply result in diminution of speed.

(b) *Hand cranks should be removed from shafts when operating electrically*, as they rotate at considerable speed and might injure cannoneers getting within reach of them.

(c) Especial care should be taken to keep all bearings and gears connected with the system well oiled (oil before each drill, without fail); but the amatures, field coils, and conductors should be kept, as far as possible, free from oil, which injures their insulating material.

(d) Sparking at commutators and other contacts should be promptly investigated by an electrician and corrected if possible.

(e) Care should be taken that the commutator brushes on all machines are set with the proper lead. Generally these are set once for all, and care is only necessary to see they are not shifted.

(f) Avoid injury to machines and conductors by blows from tools, cannoneers' feet, etc.

(g) Do not turn the controller handles on or off suddenly. They may be shifted with considerable rapidity, but all manipulation should be gentle and easy.

(h) Avoid running past the desired setting. It is easier and quicker to stop a little short and perfect the setting by successive small movements.

(i) Very small movements may be obtained by turning the controller handles slightly from the off position and then turning back immediately to the off position.

(j) Avoid running clear up to the limits of allowed movement, especially at the higher speeds.

(k) Always have the circuit breakers on the carriage set to open at a lower current than the corresponding breakers on the switch-board panel. The breakers on the carriage are put there to permit reclosing with the least loss of time, and to avoid the necessity of communicating with the man in charge of the panel and motor-generator set, which will be installed under cover at a distance.

(l) See that all binding posts are tightly set to insure good contacts.

(m) All operations should be performed as frequently as possible to keep all components in proper running order and to familiarize the personnel therewith and enable them to gain that facility of handling without which much of its efficiency and usefulness will be sacrificed.

In regard to the motor-generator set and switch-board panel:

(a) Follow carefully the directions for putting this system into action.

(b) Watch the circuit breakers, and, if either opens, close it promptly in order to avoid delays in the service of the piece.

(c) Measure the speed of the motor-generator set from time to time to insure that it is running properly

(d) Supply as nearly constant voltage to this set as possible, in order that its speed and the voltage supplied by it to the traversing motor may be as calculated. Otherwise, the speeds of the carriage will not be as calculated.

(e) Take frequent reading of the voltage and amperage shown by the instruments on the switch-board, and keep as full record as practicable of these readings with note of attendant circumstances. These records should always show the voltage correspondingly in time to the amperage entered.

(f) The motor-generator set running light (switch to carriage open) should require, on a 110-volt circuit, about 6 amperes. The speed should be 1650 revolutions per minute.

(g) The voltage and current supplied by this set to the traversing motor are variable, being controlled by the traversing controller,

and should range from 0 to 110 volts with current from 12 to 25 amperes.

While starting or accelerating speed, the current may be expected to run up to 40 or 50 amperes, occasionally.

(h) The voltmeter on the switch-board, as installed in the earlier carriages, does not measure this voltage, but the line voltage—that supplied to the motor-generator set and to the elevating-retracting motor. To measure the voltage given out by this set it will be necessary to change the connections of this meter or to connect a portable voltmeter across the terminals of the generator of the set. In later carriages the voltmeter will have a double-throw switch, enabling it to be thrown into either circuit desired. This modification is to be made for the earlier carriages.

(i) The voltage of the current supplied to the elevating and retracting motor is that of the line, generally 110 volts. The amperage should vary between 10 and 20 amperes for elevating and 20 to 30 amperes for depressing (if no counterbalance), and should average 45 to 55 amperes for retracting with 164,500 pounds counterweight and model of 1900 gun (near commencement but after fairly under way) and be about 5 amperes higher near the termination of retraction. For 6,000 pounds less counterweight the current for retracting is about 15 amperes less. There will be a temporary current, considerably higher, while the first resistance to starting from rest is being overcome. With a gun of the model of 1895 the power for elevating and retracting is about as above. With this gun and 142,000 pounds counterweight, retraction requires 30 to 40 amperes, and with 137,000 pounds counterweight about 25 to 35 amperes.

In regard to traversing:

(a) With the gear ratio applied to the earlier carriages the carriage may be traversed at maximum speed at the rate of one revolution in about one to one-and-a-quarter minutes, and at minimum speed corresponding to one revolution in fifty to fifty-five minutes. As the above maximum is unnecessarily rapid and the minimum not as slow as desirable, an increase in the gear ratio is to be made which will give a maximum speed corresponding to one revolution in two minutes (enabling the sight line to follow a vessel traveling about 50 miles per hour at 500 yards range) and a minimum continuous speed of one revolution in seventy minutes (enabling the sight line to follow a vessel traveling about 9 miles per hour at 3,000 yards range). Moving targets with slower angular velocity may be readily followed without appreciable error by successive movements of the controller handle to

the minimum-speed position, bringing it back immediately to the off position. Practice will develop great facility in this respect.

In regard to elevating and depressing:

(a) Care should be taken in these operations not to approach the limits of movement at high rate of speed. By slowing down, the full limits of movement may be attained without risk.

(b) The gun may be elevated from -5 to $+10$ degrees in about thirty-five seconds.

(c) The gun may be depressed from $+10$ to -5 degrees in about thirty-five seconds.

(d) The above times are the results of trials with the model of 1900 gun; for the model of 1895 gun they are about the same.

(e) These times are subject to considerable variation, as they include the time required to get up speed and to slow down. They are only approximate.

In regard to retracting:

(a) The model of 1900 gun with 164,700 pounds, or the model of 1895 with 146,000 pounds, of counterweight can be retracted in about two and three-fourths to three minutes.

(b) With about 5,000 pounds less of counterweight in either case the gun can be retracted in about the same time.

(c) In starting retraction, turn the controller handle slowly, in order that the starting strains and current be not unnecessarily high.

(d) Be careful not to retract so far that the gun levers strike the recoil buffers.

(e) Do not allow the gun to go into battery with the ropes attached. The excessive moment of the heavy counterweight produces an undesirably high velocity of rotation of the gearing and motor armature.

Conduits, Wiring, and Illumination.—Incandescent, 16-candle power lamps of standard form are provided for the general illumination of the carriage; 8-candlepower candelabra lamps are provided for the scales and pointers and throttling valves, and 2-candlepower miniature lamps are furnished with the new bar sight to illuminate the scales and the reticule inside of the telescope. All lamps are shaded so as to illuminate only the parts intended. The azimuth and elevation pointer lamps are lighted by one key; the lamps for the sight are lighted up to a sufficient intensity by small rheostats, all other lamps having each a key.

All electrical conductors for the motor equipment, for the lamps, and for the firing circuits upon the carriage, enter the counterweight well through a duct in the concrete, the opening of which is in the rear

wall of the well a short distance below the base ring. Thence they hang in a flexible cable or bundle, with sufficient slack to permit traversing through the allowed angle, and enter a vertical pipe conduit near the center of rotation. Thence the individual conductors are led to the several points at which their current is to be used.

The wiring system is, as far as possible, inclosed in a conduit system of wrought-iron pipe, fittings, junction boxes, etc., all with interior insulation and outlet insulators at the ends of pipes. The lighting and firing wires only are, at points where armored conduit could not well

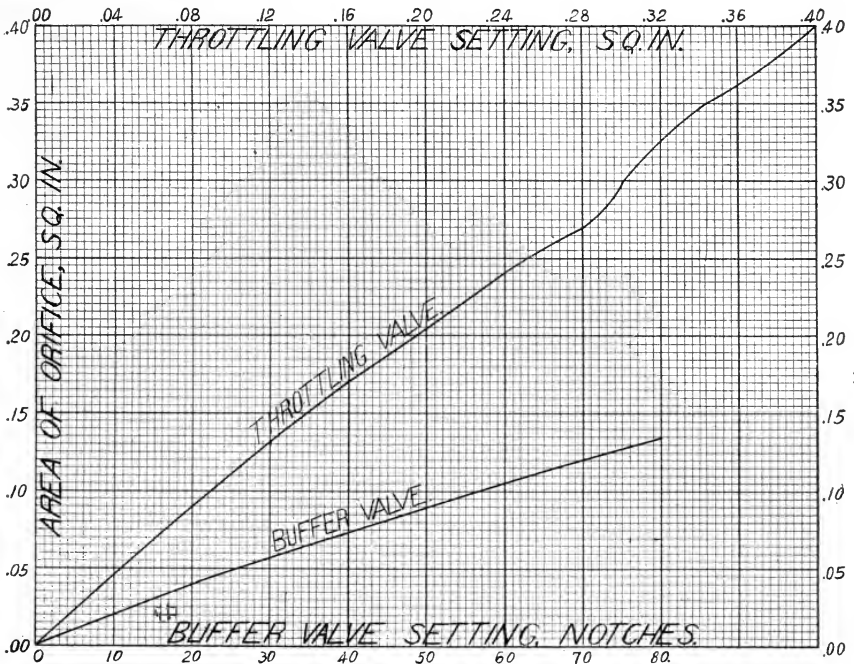
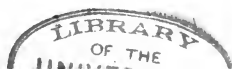

FIG. 19.

be used, made up with thimbles hung on twisted hooks, and so carried to their destination.

The Buffer Valve (Fig. 18).—The corrected setting of the buffer valve is determined by tripping the gun several times and varying the buffer valve settings until a satisfactory counter-recoil is obtained. Noting the setting of the buffer valve, then obtain from the chart shown in Figure 19 the proper setting for the throttling valve. The chart shows curves marked buffer and throttling, plotted to give the areas of orifice due to different settings of these two valves.



Using the buffer-valve setting as an ordinate, enter the chart and obtain the amount that the throttling valve should be closed to obtain the proper recoil corresponding to this buffer-valve setting. This amount will be found on the left-hand vertical scale and will be the horizontal line intersected by the buffer-valve setting-line and the buffer-valve curve. For example, suppose that the emplacement book records show at last target practice that the throttling valve set at .16 gave the proper recoil. In trial after the attachment of the buffer valve, setting the same at 30, the amount of change in the setting of the throttling valve would be obtained from the chart by following up the vertical line marked 30 until it intersected the buffer-valve curve, then following the horizontal line to the left and reading its value and the area of orifice in square inches. This will be found to be approximately .06 square inch. Subtracting this from .16 gives .10 as the proper setting of the throttling valve. It must be remembered that any change in the opening of the buffer valve necessitates a corresponding opposite change in the throttling valve unless it is desired that the length of recoil be changed.

MASKING PARAPET MOUNT

In this type of carriage the gun remains above the parapet for loading and firing, but can be lowered below the level of the crest of the emplacement for concealment. The 15-Pounder R.-F. Gun, Driggs-Seabury, is mounted usually on this type of carriage and is shown in detail in Plate XVI.

The principal parts of the mount are the outer base, the inner base, the counterweight, the counterweight chains, the chain wheels, the operating shaft, the pivot socket and bar, the pivot socket clamping wedge, the pivot yoke, the ball-bearing washer, the horizontal clamp, the vertical clamps, the oscillating slide, the recoil sleeve, the recoil cylinder and piston rod, the shoulder bar, the elevating mechanism, the sight drum and gearing, and the shield and braces.

The outer base is set into a concrete foundation and forms the ultimate support for the entire mechanism. It is cylindrical in shape, with a circular hole in the bottom for the lower part of the inner base, and two flanges, of which the top one is for the holding-down bolts, while the other, by means of connecting ribs, supports the first. The inner top edge is cut away, making a surface inclined 15° to the axis of the base and serving to help center the inner base.

The inner base is, roughly, a cylinder with a broad flange at the

top. At the lower end is a turned surface that fits into the hole in the bottom of the outer base, and 3 inches from the edge of the flange and on the under side is a surface, inclined 15° to the axis, that fits into the corresponding surface of the outer base. On inner surface of the inner base are formed two vertical ways for the pivot-socket bar diametrically opposite to each other, and at the top of these, chain-wheel recesses with supports and holes for the pin and the shaft. Near the chain-wheel recesses, there are two handholes with covers, and the front edge of the flange carries a lug for the operating lever and the ratchet-wheel pawl. The interior is bored to receive the pivot socket, and the upper edge has two holes for the clamp bolts. The two bases are held together by eight bolts.

The counterweight is a cast-iron ring weighted with lead. It is raised and lowered between the two bases, and it has two grooves to correspond to the ways of the inner base, and two shackle plates for attaching the chains.

There are two counterweight chains; they pass over the wheels and are attached by shackles to the counterweight and by eyebolts to the pivot-socket bar.

The chain wheels are assembled to the inner base, one by a pin and the other by the operating shaft; the first is bushed with bronze and the second has a slot for a spline on the shaft. The wheels have sockets for the links of the chain.

The operating shaft carries the right-hand chain wheel, extends to the front through the lug on the inner base, and is squared near the end for the ratchet. The ratchet wheel is assembled to the shaft by a taper pin and the lug carries the ratchet-wheel pawl.

The pivot socket is cylindrical in shape and is raised and lowered in the inner base by a bar, to which the chains are attached, and which passes through the socket. Two bronze collars give a bearing surface on the exterior, while the interior of the upper part is bored out to give two bearing surfaces for the pivot yoke. A web forms the support for the ball-bearing washer. In front and slightly above the upper brass collar is the clamp pad, the lower surface of which makes a slight angle with the collar.

The pivot-socket clamping wedge is shaped to the socket in rear and is fastened to the top of the inner base by two screw bolts passing through slots in the clamp. These slots are at the ends of the clamp, one being open, while the other is closed. Both permit motion of the clamp to right or left without wholly removing the bolts. On the upper portion of the clamp, next the socket, there is an inclined surface

corresponding to that of the clamp pad and terminating horizontally at both ends. The clamp is operated by means of a lug.

The pivot yoke is Y-shaped; the stem seats in the pivot socket and the arms furnish the trunnion beds. It rests on the ball-bearing washer, and those that are made of steel have two bronze collars for the bearing surfaces. Both arms have threaded seats for the vertical clamps and lugs on the inside to prevent the slide from springing under the pressure of the clamps. Four lugs, two on each arm, are bored out for the shield braces, and the seat for the horizontal clamp is cut at the top of the front part of the stem. The cap squares are secured by screw bolts.

The ball-bearing washer is seated on the web of the pivot socket and supports the pivot yoke. It consists of a row of hardened steel balls, inclosed between two steel washers shaped to fit them, and connected by a copper thimble.

The horizontal clamp is assembled to the pivot yoke, and consists of a lever and a wedge. The lever is curved and has, near its inner end, a projection that passes through the wedge and is assembled to the pivot yoke by a set screw or a filister head screw. An eccentric cam on the projection operates the wedge and retains it in place when once set home. The lower part of the wedge is shaped to the interior of the pivot socket.

The two vertical clamps are bent handles terminating at one end in a screw thread. They are assembled to the arms of the pivot yoke and operate by friction against the slide.

The oscillating slide is a casting, made of bronze in the mounts first issued and of steel in those of later design. The bronze slide consists of two cheeks connected by a loop and web; the loop is under the front part of the cheeks and the web is across the front of the loop; a hole for the piston rod is bored through the web. On the inside of each cheek there are two guides for the sleeve, and at the rear end of these are screwed two filling pieces. Near the front there are two trunnions, and directly under these two lugs giving bearing surfaces for the vertical clamps.

Too great elevation is prevented by stops at the rear ends of these lugs. The left trunnion has a projecting axis for the shoulder arm, an elevating rack is screwed to the left cheek of the slide, and a counter-recoil buffer of leather is placed on the inside of the web. In the steel slide the tops of the cheeks are also connected by a strong web and the loop is strengthened by two diagonal braces extending to the rear ends of the cheek. The leather buffer is omitted in the steel slide.

Since manufacture the bronze oscillating slides have been strength-

ened by a transom bolted across the top and two diagonal braces bolted to the sides to and the loop connecting them.

The recoil sleeve screws over the jacket and hoop of the gun and is keyed in position; it is shaped to fit the guides of the slide, and has a loop with a beveled surface in rear, against which abuts a shoulder on the cylinder. A lug in front stops the counter-recoil. The recoil sleeve was made of bronze in mounts of early manufacture, but in later mounts they are of steel, with the guide surfaces faced with bronze.

The cylinder has a smaller diameter in front than in rear, the two portions being joined by an inclined curved surface. On the interior the smaller part is cylindrical and is intended as a seat for the spring.

The travel of the piston is limited to the larger part of the cylinder. Constant resistance is obtained by the passage of the liquid from one side of the piston to the other through varying orifices, depending upon the varying diameters of the interior. These diameters vary with the position of the piston in such a way as to obtain the desired resistance. The piston rod and head form one piece, the latter being of the same diameter as the front of the larger portion of the cylinder. Springs of a circular or rectangular cross-section abut against the piston head and the front end of the cylinder. There is a cylinder head in the rear, and stuffing-box glands front and rear. The forward end of the piston rod is threaded for two nuts. A vent and filling hole are placed in the side of the cylinder.

The shoulder bar is pivoted to the left trunnion, kept in position by a washer and screw bolt in the trunnion, the shoulder-bar guide is elevated and depressed by a worm and rack; the bar is shaped to give a grip for the hand and carries the indicator for the elevation scale, the complete sight drum, the sight, the elevating handwheel and worm, and the shoulder piece.

The elevating mechanism consists of a rack, screwed to the oscillating slide, and a worm, spring, ball-bearing washer, and handwheel assembled on a vertical shaft to lugs on the shoulder-bar.

The sight drum and gearing consists of an indicator drum, with a guard, a cover, a coil spring, a clamp bolt and nut, and a rack. The cover fits inside the drum inclosing the spring, the cover and drum being screwed together. The spring has one end secured to the drum and the other to a bolt which is screwed into the shoulder-bar. An axis and pinion projects from the indicator drum, the former being seated in the shoulder bar and the latter engaging the rack on the shoulder-bar guide. The indicator drum has, on the outer cylindrical surface, a German silver strip on which the ranges are marked. The

whole is assembled to the shoulder bar by the clamp bolt and nut. The guard is screwed to the shoulder bar and has a rectangular cut that permits a view of the graduated strip; there is a small pointer at one side of this opening for indicating ranges.

The shield is a plate so bent that the two parts make an angle of 135° with each other. The gun and the line of sight pass through apertures, and there are holes for the bolts used to assemble the shield to the braces; these latter are four in number and are supported in lugs on the pivot yoke.

The lanyard is a cord wound with brass wire and passing through three guides; one on the breech of the gun, another on the sleeve, and the third on the left cheek of the slide. There is a handle on one end and a button on the other, while a small check nut, held in place by a set screw, prevents too much slack near the breech.

THE DRIGGS-SEABURY 6-POUNDER PARAPET MOUNTS

(See Fig. 16)

The later mounts supplied by this company differ in several details from the earlier ones. Though all are designated on the name plate as model 1898, those of later manufacture are described herein as model 1898 modified.

The principal parts of the model 1898 mount are the axle, the wheels, the pivot socket, and ball-bearing washer, the trail flasks, the trail piece, the spade, the trail wheel and cradle, the trail-traverse roller, the pivot yoke, the horizontal and vertical clamps, the recoil sleeve, the recoil cylinder and piston rod, the counter-recoil spring, the shoulder bar, the shield and braces, the anchorage and the ammunition boxes.

The axle is a square bar of forged steel, terminating at each end in an arm for the hub of the wheel and bent to the front in the center to make room for the pivot socket. The wheels, washers, linchpins and fasteners are similar to those on field carriages for 3.2-inch guns.

The pivot socket is a steel casting, rectangular in shape; the two sides being extended front and rear beyond the ends to form four flanges to which are riveted the trail flasks. In front, at the bottom, a horizontal flange is similarly formed and rests upon the curved part of the axle. The interior is bored to form two cylindrical bearing surfaces for the pivot yoke, one at the top and the other near the bottom, the space between being cored out to prevent contact with the yoke.

In the bottom of the socket a hole is drilled for the pivot bolt, and a shallow circular groove formed with four small drainage holes.

A seat for the horizontal clamp is formed by drilling and partly threading a hole through the right side, and two stops are placed on top in rear to limit the rotation of the pivot yoke. A ball-bearing washer, consisting of a row of hardened steel balls, held between two steel washers by means of a copper thimble, rests on the bottom of the pivot-socket cavity and supports the weight of the pivot yoke and assembled parts.

The two steel trail flasks are riveted to the flanges of the pivot socket and the axle brackets in front and to two transoms and the trail piece in rear. The construction is further stiffened by riveting steel angles to the inside lower edges of the flasks which also serve as supports for the trail-wheel bearings and for the bottom of the trail toolbox. This toolbox is a compartment formed between the trail flasks by the two transoms, and closed by a hinged lid on top. A step, a handle, and the fastenings for the handspike are riveted to the outside of the right flask, and a step, a handle, and the fastenings for the sponge rod to the left flask.

The trail piece is a bronze casting which contains the lunette and seats for the handspike, spade pin, the trail-wheel cradle pin, and the traverse roller. The spade is hinged to lugs on the upper side of the trail piece by a pin, and by this arrangement can either be placed in position for use or rotated over the end of the trail and laid upon the latter out of the way.

The trail-wheel cradle carries the trail wheel at one end and is pivoted to the trail piece at the other. The cradle may be secured in either of two positions by means of a pin, which passes through the hollow axle of the wheel. In the lower position this pin is inserted through bearings on the under side of the trail and in the upper the pin is passed through the flasks. When secured in the lower position the wheel supports the trail, while in the upper it is raised between the flasks and the trail rests on the ground.

The traverse roller is ellipsoidal in shape and is assembled to the trail piece beneath with the axis at right angles to that of the trail wheel. Its function is to permit easy movement of the trail in aiming.

The pivot yoke is Y-shaped, the stem seating on the ball-bearing washer in the pivot socket and the arms forming the trunnion beds. Two bearing surfaces are turned on the stem to fit those in the socket, and its base is drilled and tapped for the pivot bolt.

The upper bearing is slotted for the horizontal clamp and the right

arm is drilled for the vertical clamp. On each arm there are two lugs through which the shield braces pass. The cap squares are secured by screw bolts.

The horizontal clamp consists of a screw bolt, the outer end of which is bent to form a lever handle, a pad, and a button. On the inner side the pad is knurled and shaped to the pivot yoke, while on the outer side it has an undercut groove, open at the top, in which the button is held. Rotation of the pad is prevented by a stud on the lower edge.

The oscillating slide is a bronze casting consisting of two cheeks connected at their lower edges by a web. On the outside of each cheek there is a trunnion and on the inside two guides in which the sleeve works; the right-hand cheek also has seats for the shoulder bar and the vertical clamp bolt. A hole for the piston rod is drilled through the front of the web, and a filling piece is screwed on the rear end of each cheek between the guides to prevent the sleeve and gun running out of the slide in the operation of mounting, or whenever the piston rod is disconnected from the slide.

The vertical clamp consists of a screw bolt and a lever handle, the latter provided with a lug at one end and threaded for the bolt. A circular slot is cut in a flange on the right side of the oscillating slide to form a seat for the head of the bolt. The circular head of this bolt is cut away on the inside top and bottom to the width of the radius of the slot in the slide. The lug thus formed works in the slot and prevents turning of the bolt, while the remaining circular portion of the head is in contact with the inner side of the flange of the slide, and serves to clamp the latter when the bolt is drawn in by screwing on the handle.

The recoil sleeve, which is also a bronze casting, screws over the jacket and hoop of the gun and is keyed in position. It has bearings on each side formed to fit those of the slide and a heavy loop beneath bored out for the insertion of the recoil cylinder and shaped to fit against a shoulder on the latter. An eye in a lug on top affords a convenient attachment for handling the gun in mounting and dismounting.

The recoil cylinder is of bronze and is closed by a stuffingbox in front and a head and stuffingbox in rear. At about the center a circumferential rib or shoulder is formed on the exterior, which abuts against the loop on the sleeve. The interior of this front portion of the cylinder is bored cylindrically and merely affords the additional length required for the counter-recoil spring over that needed for the movement of the piston in recoil. The part of the cylinder in rear of the

exterior shoulder is that in which the piston head works and is bored larger.

The piston and all cross-sections of the cylinder are circular; the oil, therefore, always has an annular opening to pass through while being forced from one side of the piston to the other as the cylinder and piston move relatively to each other. This opening is the annular clearance to the piston (and is equal to the area of cross-section of the cylinder minus the area of cross-section of the piston). This opening is varied by giving the cylinder a different area of cross-section at each point of recoil. The greatest area of cross-section of the cylinder is at the point at which the velocity of retarded recoil is the greatest. The areas are so varied relative to the velocity of retarded recoil that the resistance to recoil (that is, the pull on the piston rod) is nearly constant.

These mounts were designed to use a mixture of glycerin and water in the cylinders, and the earlier mounts as issued were supplied with this mixture. No issues of glycerin are made, however, as the Ordnance Department has found a neutral oil to be superior. This oil, called "hydroline," is now issued and used in these as well as all other hydraulic recoil cylinders.

Through the side of the cylinder near the rear end, a filling hole is drilled, closed with a small screw plug.

The piston head and rod are formed from one piece of steel. The rod extends on both sides of the head, the portion in front, which is longer and larger in diameter, ending in an eye and being threaded for the piston-rod nuts, while the part in rear of the head projects through the rear stuffingbox and serves as a support and guide for the head during recoil. The counter-recoil spring is a coiled spring strung upon the rod in front of the head and abutting against the head and the front end of the cylinder.

The shoulder bar is a straight bronze arm the forward end of which is shaped to slide into an undercut seat on the oscillating slide. A leaf spring on the bar locks it in its seat. The rear end of the bar is fitted with a wooden shoulderpiece suitably padded with a piece of rubber hose. A bronze handle and a guide or deflector to prevent the ejected cases from hitting the gunner are attached to the left side of the shoulderpiece.

The shield consists of a steel plate about $\frac{1}{4}$ inch thick, which is attached to the carriage by the four shield braces passing through lugs on the pivot yoke. The upper part of the shield is bent to the rear, forming an angle of 135 degrees with the lower vertical part, and suitable

apertures are cut out for the gun, the line of slide, and bolts of the braces.

The anchorage consists of one V-rod, two anchor bolts and nuts, two anchor plates, and one axle brace and anchor stirrup.

The brace and stirrup is a steel plate, assembled to and under the ammunition and axle brackets. The stirrup is directly beneath the pivot socket, is braced and reinforced from the rear, and has a hole for the hook of the V-rod. The angle end of the V-rod terminates in a hook through which a pinhole is drilled. The two ends of the rod are permanently connected to the anchor bolts by eyes, and the anchor plates are assembled on the bolts by nuts.

Two ammunition boxes, each holding nine rounds, are carried on brackets on the axle, on either side of the pivot socket. These boxes are rectangular in shape and, except the door, which is of steel, are made of malleable-iron sheets. The interior is fitted with three transoms or partitions, two of malleable iron and one of wood, provided with holes for receiving the ammunition. The door is lined on the inside with felt, is hinged at the bottom, has two steel hangers to support it when open, and is closed by a hasp. Two handles are riveted on each box, and two trunnion bars, one front and one rear, pass through near the bottom and project slightly on either side.

The brackets which support these boxes fit over the axle, are bolted to the brace, and each has two undercut lugs in the front, into which the trunnion bars of the boxes slip, and two slotted lugs in rear. The rear lugs are drilled and tapped for the screw bolts, which serve as pivots for the box holders. These holders are clips, fitted with springs to retain them in place, which swing over the rear trunnion bars of the ammunition boxes and secure them in place.

MORTAR CARRIAGES

The method of mounting mortars is such as to require the classification of their carriages under a special head. A strict interpretation of the definitions of the other classes readily shows that they are neither barbette, disappearing, masking parapet, or casemate, but rather a combination of the two principal classes. The 12-inch B.-L. mortar mounted on spring return carriage is shown in Plate IV and Fig. 11.

The carriage is designed to deliver all-around high-angle fire, of from 45 to 65 degrees elevation. It is prevented from creeping after set in azimuth by a traversing brake which must be released before pointing the piece in azimuth.

With the 800-pound projectile and full charge, the recoil is approximately 19 inches, measured on the piston-rods.

The horizontal piece, when fully counter-recoiled, is 54 inches above the loading platform, and the projectile, in loading, is wheeled directly into the breech recess, the tray of the ammunition trucks forming the loading trays.

It is arranged for either lanyard or electric firing, and in the latter case the pieces may be fired independently or the entire four in a pit at once, from the outlet box, or the battery commander from his station may fire either by pit or by battery.

After loading, the piece must be again elevated to 43 degrees before the electric connection for firing is automatically made.

In lanyard fire, the lanyard is hooked into the stopper of the lanyard attachment in the floor plate, the attachment lanyard giving a direct pull on the primer.

Action of Carriage.—Upon firing, the piece and top carriage rotate to the rear and downward about the fulcrum shaft, compressing the counter-recoil springs and forcing the crossheads and piston downward until the resistance in the recoil cylinders stops the motion, after which the compressed counter-recoil springs immediately return the piece to the loading and firing height. The movement of the crank pins through the arc of a circle causes the recoil cylinders and guides to oscillate about their trunnions.

Principal Parts.—The carriage consists of the following principal parts, viz.: Base ring and floor plates, traversing roller system, racer, top carriage or saddle, recoil system, counter-recoil springs and buffer stops, elevating system, traversing system, azimuth circle and pointer, elevation quadrant, lanyard attachment, electrical attachments, and shot trucks and tongs.

Base Ring.—The base ring is of cast iron in one piece, and is secured in its position by twenty-four 1.75-inch anchor bolts. The outer flange of the base ring, 14 feet in diameter, which contains the bolt holes, rests upon the upper step of the well, whose surface is 24.5 inches below the floor level of the emplacement.

The top surface is turned, forming the lower roller path and a vertical annular flange forms the male part of the pintle. The traversing rack is attached on the inside below the roller path.

Eight brackets, rigidly supporting the azimuth circle castings, are bolted to the outer flange, these brackets and castings, together with the radial angle irons whose outer ends are embedded in the concrete, furnishing the support for the circle of cast iron removable floor

plates. There are sixteen plates, retained in position by countersunk screws.

Traversing Roller System.—The racer rests and is traversed upon a circle of twenty-four live, conical, traversing rollers of forged steel, with a single flange. The rollers are 7.5 inches in maximum diameter, and their axes are held in the radial position by a cast-steel distance ring in six sections, in which their bronze-bushed journals have bearings. The distance ring has oil grooves finished around its top edges, reaching through oil tubes in the racer.

Racer.—The racer is of cast iron in one piece, 13 feet 9.5 inches in diameter. Its lower surface is turned, forming the upper roller path, corresponding to the lower roller path on the base ring. The outside annular flange extends downward, fitting over the pintle with 0.063-inch diametral clearance. It is of cellular structure, and upon its front edge are cast two lugs or brackets, to which the top carriage or saddle is

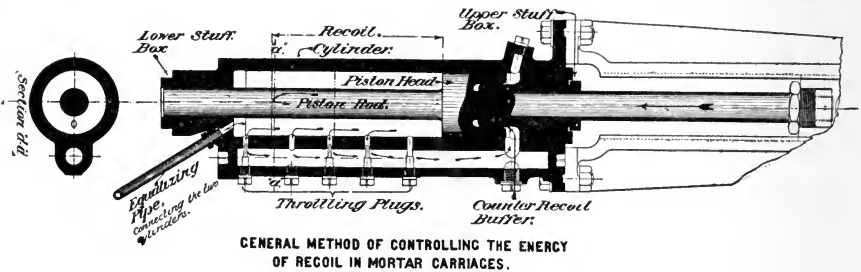

FIG. 20.

pivoted by means of a forged steel fulcrum shaft. On each side of the longitudinal openings are openings and supporting bearings for the recoil cylinders. The reinforce pieces, one on either side of the opening, have been added to the original racers to give additional strength at these points. Three removable oil plugs permit oiling the pintle and traversing rollers.

Top Carriage.—The top carriage or saddle, of cast iron, consists of two arms connected by a heavy web. The upper ends of these arms form the trunnion beds in which the mortar is mounted and carry the crank pins which operate the recoil brake. The saddle is inclined to the rear at an angle of about 41 degrees, the lower ends being held by the fulcrum shaft. Between the fulcrum and the trunnions are placed openings for the spring guide rods and the seat for the cap of the rocking counter-recoil springs.

Recoil System.—Fig. 20 shows the general arrangement of the

hydraulic brake and its connections in its essential principles and in relative positions of parts for mortar carriages "in battery."

The recoil is checked by two hydraulic cylinders with return passages. These cylinders are provided with trunnions and oscillate in brackets bolted to the top of the racer on each side of its central opening, their lower ends extending some distance below the racer.

They are of cast-steel, 7.75 inches interior diameter and are fitted with 3.5-inch forged-steel piston rods working through stuffingboxes at both ends of the cylinders. Each stuffingbox contains six rings of 0.625-inch-square Garlock water-proof hydraulic packing.

About the middle of the rod a piston is formed out of the solid, on which is formed a bronze bushing. The connecting or return passages are formed along one side between the ends of each cylinder, entering the upper end immediately above the head, and five holes 0.7-inch in diameter are bored at proper intervals, connecting the passages with the cylinders. The energy of recoil is taken up by the resistance which the fluid offers to being driven through these holes, which are successively closed by passage of the piston over them. Plugs are provided for closing or partly closing the holes. The upper face of each piston has an annular recess, which, at the end of the counter recoil, passes over the annular projection or buffer on the upper, bronze, cylinder head. The fluid thus imprisoned being able to escape by the clearance only, its resistance gradually checks the movement and consequently the mortar returns gently to the firing position.

Each cylinder has one filling hole, on its rear side, near its upper end.

For all charges the cylinders should be filled to the level of the filling holes, removing for this purpose both plugs, so as to permit the air to escape.

A neutral oil of specific gravity of about 0.85 (such as the hydroline at present issued), is used, and with this oil the working pressure in the cylinders is about 4,000 pounds per square inch and the piston-rod compression about 150,000 pounds. A denser oil would cause a higher pressure in the cylinders and therefore shorten the recoil slightly.

To give the proper recoil the throttling plugs should be arranged in each cylinder, from top to bottom, as follows: First hole closed; second hole half open; third hole quarter open; fourth and fifth holes open.

To facilitate inspections, the tops of the throttling plugs have been stamped with a "C," " $\frac{1}{2}$," " $\frac{1}{4}$," and "0" to indicate whether the holes are closed, half open, quarter open, or open.

The recoil system is at present undergoing certain changes which when completed will result in the return passageway being entirely

closed. In place of this passageway three channels about $2\frac{1}{2}$ inches wide and varying in depth from .02 to .087 inch have been cut the length of the recoil cylinder.

If it is desired to measure the recoil, it can be done on one of the piston rods by making several turns around it with fine twine and tying it tightly just where the piston rod enters the stuffingbox. The height of the twine above the stuffingbox, after firing, will indicate the counter recoil, which will also be the recoil if the mortar has returned to the firing position. If it does not return to the firing position the springs should be compressed as hereafter described.

The lower ends of the hydraulic cylinders are connected by an equalizing pipe, in which is made an emptying coupling, so that the resistance and the pressure in both cylinders shall be equal. The coupling is provided for emptying the cylinders at a convenient point.

Bronze plugs are provided which can be used to replace the equalizing pipes thus continuing the piece in action after their injury. On the top of each cylinder are bolted two guides of cast steel, between which moves a sliding crosshead, into which the upper end of the piston-rod is secured by means of a collar and nut. The crossheads are assembled over the crank pins, of forged steel, which are forced into the saddle, just below the trunnion beds, by hydraulic pressure and riveted.

Counter-Recoil Springs and Buffer Stops.—The saddle is supported at a point about one-third of its length from the fulcrum shaft by five columns of springs. Each column consists of five double-coil helical springs, threaded on a rod of forged steel. These five rods, arranged in a row side by side, are used to give the necessary initial compression to the springs in assembling the carriage, and afterwards serve simply to guide the springs laterally.

The lower ends of these spring columns rest in a springbox, of cast-iron, and the upper ends bear against a spring cap.

The springbox is hung, by means of trunnions, in two brackets, of cast iron, bolted to the upper surface of the racer, which permit it to oscillate during recoil to the different inclinations of the spring columns. The spring cap, performing essentially the same office above as the springbox does below, is a thin rectangular steel casting fitting over the top of the spring columns, and having upon its upper surface a well-rounded knife-edge bearing. During recoil this bearing rocks in a groove running across the lower surface of the saddle web. Both the spring cap and box are perforated to allow the ends of the spring rods to pass freely through them.

As an additional precaution against shock when returning to the firing position, buffer stops are provided. These are made up of alternate layers of balata and steel plates, and are held between the guides under the caps. The cross heads moving between the guides during counter-recoil strike these buffers when the mortar returns to the firing position, and are maintained in pressure contact under the guide caps by the counter-recoil springs.

Elevating System.—A circular rack of cast steel is bolted longitudinally to the mortar on the under side, so that the center from which its pitch line is struck is at the intersection of the axis of the trunnion and bore. This rack engages in a pinion of forged steel mounted on a heavy shaft on the under surface of the saddle web, to which motion is given by gears connecting with a second shaft extending across the upper face of the saddle web and bearing a handwheel at each end. The saddle web is cored out to permit the passage of the rack in elevating.

The mortar is held in the loading and firing positions by means of a hand nut on the handwheel shaft, which locks that shaft by pressing the steel handwheel pinion against an adjoining bushing, which together form a conical friction clutch. To protect the teeth on the elevating gearing from injury, which may be caused by the inertia effects of the handwheel during the change of elevation in recoil, the elevating shaft has keyed to it a friction cone. This cone fits into the bronze elevating gear, which is loose on its shaft and engages the steel pinion on the handwheel shaft. By means of a washer and nut the bronze elevating gear may be forced onto the friction cone with any desired pressure, i. e., with sufficient pressure to prevent slipping during elevating or depressing or an undue amount of slipping during the recoil. The friction between cone and gear will be sufficient if the united effort of two men applied to the handwheels is required to cause a slipping when an attempt is made to depress below the minimum.

An elevation lock is to be applied to lock the mortar in the horizontal position against the elevating stop while loading. It consists of a latch bolt with a lever for withdrawing it, arranged on the top of the carriage, engaging with a strike on the elevating rack. It is operated by the cannoneer at the right elevating handwheel.

Traversing System.—The circular traversing rack on the inside of the base ring has meshing with it a pinion on a vertical shaft which passes down through the racer and having at its upper end a worm-wheel. Motion is given the latter by means of two cranks mounted on a worm shaft. The worm shaft, worm wheel, and the part of the

vertical shaft above the racer are incased in a cast-iron standard, which has oil and drain holes conveniently placed and also so arranged that the worm and the gear rim run in oil.

In order to maintain the piece without further movement until fired, after having been set in azimuth, it is expected that a traversing brake will be applied.

It has been arranged with a pedal in the rear of the cast-iron standard which carries the gearing and so as to be maintained "on" by a coil spring acting to set the brake levers to grip the top and bottom surfaces of the traversing rack, thus retaining the carriage in a fixed position. When about to traverse, the cannoneer at the crank places a foot on the pedal, compressing the spring and permitting free movement.

Azimuth Circle and Pointer.—A brass circular strip in eight sections about 1 inch wide graduated to degrees, is attached to the top side of the azimuth-circle castings which surround the racer. Attached to the racer is a small brass pointer or subscale. This pointer is subdivided to 0.05 of a degree and stamped in hundredths of a degree. After final adjustment it is dowel-pinned to the racer.

An improved azimuth pointer has been tested. It has a deflection scale for wind and moving targets to be used in combination with deflection scales for the drift of the different projectiles used with the piece. Adjustments are quickly made by means of thumb wheels actuating pinions meshing in fixed racks.

The whole is protected by a cast-iron cover which, when raised, exposes an electric light for illuminating the scales.

Elevation Quadrant.—To save time in bringing the mortar to the desired elevation and to avoid inaccuracy in placing the quadrant and holding it against its seat a special elevation quadrant has been designed. This quadrant is similar to the gunner's quadrant, but permanently attached to the right rim-base of the mortar and consists of a bracket with a toothed arc and an arm hinged at the other end. The arm is telescoped and its front bushing carries a bubble, a micrometer, and a toothed sector which is constantly pressed outward by a spiral spring. The teeth of the sector engage in the teeth of the arc which are cut in degrees, from 45 to 75 degrees. The micrometer, which gives a limited movement to the arm, is graduated to a least reading of 1 minute. The cannoneer at the right-hand wheel adjusts the quadrant at the required angle of fire and when the mortar is loaded sets its elevation by the bubble.

Lanyard Attachment.—In using the firing mechanism, model of

1903, at high-angle fire, it is necessary that the direction of lanyard pull shall be approximately that of the axis of the piece and that the lanyard be arranged to not interfere with the loading operations.

A short lanyard is attached to the underside of a stopper in the top of the racer in rear of its central opening and extends below a sheave on the pit ladder and thence upward to the firing mechanism.

While loading, its hook is placed in an eye screw at the lower edge of the breech.

The long lanyard is hooked into the eye on the top of the stopper and the stopper and short lanyard drawn to the rear to fire.

Electrical Attachments.—These consist of the firing circuit inclosed in flexible metallic conduit and with its safety attachments and the illumination circuit also inclosed.

The safety firing switch is designed to prevent firing the mortar electrically until it has been elevated to 43 degrees. It consists of a circuit-breaker attached to the saddle on the right side of the opening for the elevating rack, and a steel cam in the form of an arc of a circle subtending 40 degrees, which is fastened to the right side of the elevating arc. The circuit-breaker holds a plunger, which is constantly pressed outward by a spiral spring, breaking the circuit. On the end of the plunger is a roller which, when the mortar is elevated 43 degrees, moves up an incline on the cam, pressing the plunger and closing the circuit. The plunger is held in this compressed position as the elevation is further increased so that the circuit remains closed at all elevations at which the mortar is fired.

For general illumination, hooded 16-candlepower incandescent lamps are advantageously placed, the usual 8-candlepower candelabra lamps being placed at the azimuth circle and elevation quadrant.

All electrical conductors enter the well through a duct in the concrete, thence they hang in flexible metallic conduit with sufficient slack to permit traversing through the required angle, continuing in a conduit system of wrought-iron pipe, junction-boxes, etc., with interior insulation.

Shot Trucks and Shot Tongs.—The shot trucks (Fig. 11) for this carriage are constructed so as to admit of passing the shell directly from the truck into the mortar. Each truck consists of a light rectangular framework of steel mounted on four rubber-tired wheels and carrying a pan, in which the shell lies horizontally and at the proper height for loading. This shell pan projects to the front and is designed

to enter the breech of the mortar and to supply the place of the usual loading tray. Two straight wooden bars which slip into sockets on each side of the truck serve as handles and the two rear wheels are swiveled to facilitate turning.

Shot tongs are also provided for placing the projectile on the shot trucks.

CHAPTER VI

EXPLOSIVES, PROJECTILES, PRIMERS AND FUSES

Explosives.—Explosives are divided into three classes, namely:

Low Explosives or progressive or propelling explosives, which include those used as propelling agents in guns or mortars.

High Explosives or detonating and disruptive explosives, which are used in shells, torpedoes, mines and for demolitions of all kinds.

Fulminates or detonators or exploders, which are related to high explosives and used to originate explosive reaction in the first two classes.

The three classes are distinguished by the character of their explosive reaction, which places them in three distinct divisions in so far as their action is concerned, namely: 1. Explosion proper: explosion of low order; progressive explosion; combustion. 2. Detonation: explosion of high order. 3. Fulmination: a characteristic type of explosion produced by the fulminates.

Low Explosives.—The low explosives are progressive and consist of the charcoal powders and nitrocellulose powders. The charcoal powders are divided into black charcoal powder and brown charcoal powder.

Black Charcoal Powder has the following ingredients: 75 parts by weight of nitre (saltpetre), 15 parts by weight of charcoal, 10 parts by weight of sulphur.

Nitre is a salt found in nature as an incrustation on the surface of the soil in certain tropical countries, resulting in such instances from the decomposition of organic matter in the presence of moist alkaline earths. The decomposition of organic matter produces ammonia, which, combining with the oxygen, produces nitric acid. The acid, acting on other salts of potassium, produces the nitrate which in solution percolates through the soil and is left after evaporation as an incrustation on the surface.

Nitre is also produced artificially by the nitre-bed process. A finely mixed lot of animal and vegetable matter, together with limestone, old mortar, wood ashes and any alkaline material, is piled in a high, narrow bed on an impervious floor. One side of the bed is exposed

to the prevailing wind, and the opposite side is terraced, the terraces inclining toward the then formed gutters. In these gutters urine from stables is thrown. The temperature is to be kept between 60 and 70 degrees F. The chemical action above described takes place in the body of the heap and the soluble nitrates percolating through the mass of the heap appear after evaporation on the exposed side as an incrustation.

The crude nitre obtained from this source contains the nitrates of magnesium and calcium and the chlorides and sulphates of the alkalis and alkaline earths. Before being used nitre has to be separated from these. This is accomplished by making use of the principle of the relative solubilities in water of the substances at different temperatures. The nitre crystallizes first on cooling, leaving the impurities in solution. The most objectionable impurity of those mentioned is the chlorides, on account of their hygroscopic quality. Nitre should always be freed from them and before being used is always tested to determine if they are present. .

Nitre is distinguished from most other nitrates by the form of its crystals, which are long six-sided prisms; and from most salts other than nitrate by its deflagration when heated on charcoal.

The value of nitre in explosives is due to the fact that it supplies oxygen to the combustible elements present. Five-sixths of its oxygen is available for its combination with any combustible, the nitrogen coming off from its decomposition being given off in the free state. The temperature of its chemical union with any combustible is very high, as the oxygen is supplied in very concentrated form and not mixed with nitrogen as in the case of air. It has been found that the amount of oxygen in a cubic inch of nitre will occupy 3023 cubic inches at atmospheric pressure and temperature of 60 degrees F. The fact that all nitrates used in explosives act as carriers of oxygen, and break up on the application of heat, thus increasing the temperature of the chemical reaction, makes them of special value in their use as an ingredient of explosives.

Carbon or Charcoal is present in nearly all military explosives. Its function in all cases is to combine with oxygen, forming CO or CO₂ or both, the combination producing an elevation of temperature. In explosive mixtures it occurs in the form of pulverized charcoal.

Charcoal for military purposes is obtained by the destructive distillation of wood, such as willow, alder, dogwood and rye straw. The lighter woods are preferable and are usually used. The charring is done in a metallic cylinder placed in a retort over a furnace fire. The

effect of heat is to drive off all the volatile parts of the wood, as wood naphtha, water, etc. Charcoal made by this process is called cylindrical charcoal to distinguish it from the common pit charcoal. After charring, the charcoal should be exposed to the air for about two weeks before grinding up for powder. The reason for this delay after charring is the danger of spontaneous combustion. About 30 per cent. of the weight of wood is obtained in the form of charcoal. Charcoal used in the manufacture of brown powder is made from rye straw and is under-charred. Freshly charred charcoal pulverized and stored over two feet deep will ignite spontaneously. The charcoal used in black powders contains between 75 to 80 per cent. of carbon, 3 to 5 per cent. of hydrogen, 10 to 23 per cent. of oxygen and about 2 per cent. of ash. That used in the manufacture of brown powder contains 45 to 48 per cent. of carbon, 5 per cent. of hydrogen, 45 per cent. of oxygen and the remainder is ash.

Sulphur.—The sulphur used is that commonly found in the volcanic districts of the United States, Mexico and Italy. It is usually found in chemical combination in nature in the sulphides and sulphates. The common ores which produce sulphur are those of iron sulphates (FeS), galena (PbS), zinc-blende (ZnS), black sulphide of antimony (Sb_2S_3) and cinnabar (HgS). The sulphur is obtained from these native ores and from iron and copper pyrites by direct distillation and subsequent refining to free the sulphur from impurities. The value of sulphur as an ingredient of gunpowder is that it reduces the temperature of ignition and produces in the chemical union with oxygen a higher temperature than with carbon, as well as increasing the rate of combustion and pressure of the gases produced.

MANUFACTURE.—As a preliminary step each of the ingredients is purified and then pulverized by grinding. The charcoal is ground in a machine resembling a large coffee mill, and the nitre and sulphur in a mortar mill. The latter consists of a pair of circular-edged rollers traveling around a circular cast-iron bed and revolving about a common horizontal and vertical axis.

The nitre or sulphur is then spread evenly over the bed to a depth of from one to two inches and reduced to a fine powder. After grinding, the pulverized material of each kind is passed through a sifting reel which consists of a frame cylinder covered with wire cloth, 32 meshes to the inch. The reel is revolved slowly until the particles are fine enough for incorporation. The remainder is reground.

The sifted materials are weighed out in the relative proportions given above and placed in bags, each lot weighing 50 pounds. These

bags are then taken to the mixing machine, which consists of a copper drum mounted on a horizontal shaft, the capacity of the drum being about 150 pounds. The shaft of the drum is hollow and through it passes a second shaft which carries a series of arms or fliers, and revolves in a direction opposite to that of the first shaft. The process of mixing takes about five minutes. The mixed material is placed in bags which are laid on their side to prevent the ingredients separating in layers according to their specific gravities. They are handled carefully in transportation without jarring or shaking for this same reason.

The ingredients are now incorporated in the incorporating mill. This is the most important step of the whole process, the object being to bring the ingredients into the closest possible contact so that each particle of the resulting cake will be composed of all the ingredients in their proper proportion.

The mixed ingredients are spread evenly over the bed of the mill, the layer being not more than one-half nor less than one-fourth of an inch thick. If too thick the incorporation is defective, and if too thin or less than one-fourth of an inch in thickness there is danger of an explosion.

After the charge has been spread over the bed it is moistened with distilled water, the quantity used depending on the state of the atmosphere. It is important to secure a uniform moistening, as the nature of the product depends much upon this. The time for incorporation is from three to four hours and the product is called "mill cake." This cake should have a uniform blackish gray color without any white or yellow specks.

These cakes are put in tubs and placed in small magazines where they are exposed to the action of the air so that all workings, i. e., several charges, may contain about the same percentage of moisture—2 to 3 per cent. of water is necessary for good results in the subsequent pressing

So far as the chemical requirements are concerned the process is now completed, and the subsequent operations have for their object physical effects, and depend upon the use to which the powder is to be put. In order that it may have its rate of burning regulated, the size, density and form of the grain must be fixed. To do this the mill cake is now taken to the breaking-down machine, where it is broken up into lumps of uniform size. The breaking-down machine consists essentially of two pairs of grooved cylinders arranged one pair above the other. The mill cake is passed through these rollers, by which it is broken up

into lumps of uniform size. The product after leaving the breaking down machine is called "powdered meal."

Now in order to granulate the powder it is first pressed into solid compact cakes, called "press cakes." This is done in a hydraulic press, which consists of a press box—strong gun-metal box having three of its sides hinged and an hydraulic ram. In filling the press box it is laid on one side and the upper side laid back, the metal plates being held apart in a frame. The powdered meal is now filled in between them, the side is closed down and the box revolves so that it comes under the ram of the hydraulic press. After it is in place pressure is applied and the powdered meal compressed in a hard, compact cake. Pressed cake is then broken up into grains by passing it through the granulating machine. This machine consists of a series of tooth and grooved rollers, the clearance between which and the character of the grooves of teeth being adjusted for the kind of powder desired.

Under the rollers of the granulating machine are arranged three separate screens. The upper one has eight meshes to the inch, the second sixteen and the third is a copper wire cloth. The screens have a slight slant and the powder collected on each is put in a separate bin. The powder caught on the top screen is too large and is reworked; that on the second screen is common powder; that on the third screen is rifle powder; and that which passes through the lower screen is powder dust.

To remove the sharp corners of the grains and to free it from the dust the powder is passed through the dusting machine. This consists of horizontal cylindrical frames covered with canvas having 24 meshes to the inch. Several barrels of the powder are placed in these cylinders and the cylinders revolved at about 40 revolutions to the minute. The dusting process requires about one-half hour. It is sometimes desirable to glaze powder, the object being to protect the grain to some extent from moisture and from the formation of dust in transportation. This is accomplished by placing a small quantity of pulverized graphite with the powder grains in a barrel-like receptacle and revolving the latter for a short time. By this process the graphite adheres to the powder grains and forms a smooth surface.

The final operation in the manufacture of black powder is to remove the excess of moisture by drying. This is done by spreading the powder out over shallow canvas-bottomed frames arranged in tiers over a steam radiator and subjected to a temperature of 130 degrees F. for about eighteen hours. This process causes the production of some

dust, and the powder is redusted. Black powder is packed in hundred-pound packages. For commercial use oak barrels with cedar hoops are used, but that for military purposes is packed in the zinc powder-case described in the DEFINITIONS.

Black Prismatic Powder is made from the ordinary black granulated powder, the cannon powder grain being taken as a base. It is made by reworking the black powder by moistening it with 10 per cent. of water and forming it into prisms to the action of a prism press. This press consists essentially of two sets of powerful stamps operating reciprocally through openings in a heavy mould plate. The mould plate has a series of hexagonal moulds in it and is placed so as to be horizontal in the press. The bottoms of these moulds are formed by the ends of the lower series of stamps, each of which has seven needles projecting upwards through perforations in the stamps. The upper series of stamps has also similar perforations. The powder is placed in a hopper the bottom of which has a sliding charging plate which contains a series of measures corresponding to the moulds of the mould plate. The charging plate with its measures filled with powder slides over the mould plate until the measures are directly over the moulds into which the powder drops. The charging plate then slides back. The press is then put in operation, the upper stamps descend into the moulds and the needles pass up into the perforations of the upper stamps and form the perforations of the prisms. By the reciprocating action of the press when the upper stamps have reached their lowest point and begin to ascend, the lower stamps follow them up until the ends of the lower stamps are flush with the top of the mould plate and the upper end-perforating needles. When this position is reached the lower stamps stop and the upper ones continue upward, leaving prismatic grains free to be pushed off by the edge of the charging plate as it returns carrying a new charge.

Sphero-hexagonal Powder is a black powder made in a similar way as the prismatic powder just described. It receives its name from the form of the grain, which consists of two half spheres with a narrow six-sided hexagonal prism at the diameter.

Brown Charcoal Powder has the following ingredients: 80 parts by weight of nitre, 16 parts by weight of charcoal, 3 parts by weight of sulphur and 1 part by weight of moisture. The charcoal is made of rye straw and is under-charred. The color of the powder, which is a brown or cocoa color, is due to this fact. The method of manufacture and the ingredients are the same as described for the manufacture of black charcoal powder. Brown powder burns more slowly than black

powder, and with lower pressure in the chamber of the gun. The explosion is more uniform and the stresses produced in the bore of the gun are not so great, thus increasing the endurance of the gun.

Brown Prismatic Powder is made in exactly the same way as that described for black prismatic powder, the brown granulated powder being taken as the base.

Nitrocellulose or Smokeless Powder is an explosive compound. It is distinguished from an explosive mixture like the charcoal powders in which the ingredients are mixed mechanically, in that the constituents are brought together through a chemical reaction. The word powder is misleading as applied to modern propellants, in that they are made in a variety of forms which do not bear any resemblance to a powder, but take the shape of tubes, cord, strips, flakes or cubes.

Nitrocellulose is the base of all smokeless powders. Its molecule contains carbon, hydrogen and oxygen, so that when conditions favorable to the combination of these elements are produced, the gaseous oxides of carbon and water vapor are formed.

Any substance whose molecules contain carbon, hydrogen and oxygen in the proportion to give CO , or CO_2 and H_2O may become an explosive. One which is so constituted and at the same time has weak molecular bonds due to the presence of some other element or radical, is an explosive.

The principal ingredients of nitrocellulose powder consist of cellulose, nitric acid, sulphuric acid, ether and alcohol. The manufacture of nitrocellulose powder consists of the following essential steps:

Cleaning.—The cotton waste or cotton rags are brought into the washing house in large bales. These are broken open and put into the washer. This consists of a large iron tank with pipes running through the center. The tank is filled with a solution of caustic soda, and the cotton waste—about 175 pounds of caustic soda to 200 pounds of the cotton waste. The washer is slowly revolved, keeping the mass constantly agitated. The temperature is retained at 120 to 130 degrees F., and the washing continues for four hours, the object being to remove any oil or grease from the waste or rags. After being washed for four hours the product is taken from the washhouse to the centrifugal wringer and wrung as dry as possible, after which it is returned to the washer and washed in clear, pure water. It is then wrung out a second time in the centrifugal wringer and taken to the

picker, which consists of two horizontal toothed cylinders revolving in opposite directions. The cotton waste is then placed on a wooden apron and fed into the picker, which tears it apart, removing all knots and tangles and delivers it in finely shredded strips about an inch long and one-quarter of an inch wide.

Drying.—The cotton from the picker is collected in boxes and taken into the drying house, where it is placed in large wooden bins having perforated bottoms. Hot air at a temperature of 90 to 105 degrees C. is forced up through the bins as the cotton is turned from time to time by hand. The process of drying requires about eight hours, at the end of which time the cotton should not contain more than five-tenths of one per cent. of water.

Nitrating.—The cotton, having been dried, is placed in air-tight cans and taken to the nitrating house. The object of packing it in air-tight cans is to prevent the dry cellulose from absorbing water from the air. The nitrating is done in a centrifugal machine. One can of the dry cotton, containing about 16 pounds, is placed in the nitrating machine with 900 pounds of mixed acids consisting of 50 per cent. sulphuric and 28 per cent. nitric. The mixed acids are drawn from a large tank called the mixed acid tank. The charge is kept in the nitrating machine for about 30 minutes, during which time it is turned over with iron forks. In becoming nitrated the cotton increases in weight about one-half, the 16 pounds of cellulose giving about 24 pounds of nitrocellulose. It will be noted that the process of nitration changes the cotton or cellulose into nitrocellulose or cellulose nitrated. The powder contains about 12.6 per cent. of nitrogen as well as free acids and alkali used in the manufacture, and some unnitrated cellulose. At the end of 30 minutes the drain cocks of the nitrating machine are opened, the machine started, and spent acid forced out by centrifugal action.

Purification.—The rest of the process, which is very essential to the production of stable smokeless powder, consists in removing the impurities left in the nitrocellulose in the manufacture. The free acids and unstable nitro by-products must be removed in order that the nitrocellulose may be kept, even in the dry state, at ordinary temperature without deterioration. Nitrocellulose is taken at once from the nitrating machine and immersed in a large quantity of pure water, and left there for eight hours, two changes of water being made during that time. It is then taken to the centrifugal machine and, while revolved in this, cold water is played upon it with a hose for about ten minutes. The machine is then revolved at its highest speed

and the nitrocellulose wrung as dry as possible. When about 1,000 pounds has been treated in this manner, it is given a definite number known as its "lot number," which it retains throughout its manufacture, and all subsequent operations are recorded in reference to this number. The size of a lot may sometimes vary, depending upon the place of manufacture. The lot is now taken to the purifying tanks, which are large wooden tanks with steam pipes arranged over the bottom. Steam circulates through these pipes and keeps the cellulose and water at the desired temperature. Pure water is put in the tank and one lot put in. The lot is kept in the purifying tanks for two days, the temperature being kept at 80 degrees C., and the water is renewed three times during this period. At each renewal the temperature is increased to 100 degrees C. for 2 hours. The mass is kept agitated by revolving arms set at different angles. From the purifying tanks the nitrocellulose is taken to the centrifugal machine, where it is washed with pure cold water from a hose for ten minutes. It then goes to the pulper.

Pulping.—The pulper is an ordinary pulping machine used in paper mills. It consists of an oval-shaped vat or tank with a horizontal shaft passing across its narrowest dimension. On one end of this shaft is a drum which has on its outer surface a series of parallel knife edges. Directly below the drum is a concentric surface with a second series of knife edges. Pure water circulates slowly throughout the vat, running in at one point and overflowing at the other. From 600 to 1,000 pounds of nitrocellulose from the purifying tank is placed at one time in the pulper. The drum in revolving pulls the cotton down and forces it between the two series of knife edges, cutting it finer and finer until the whole mass is a smooth, even, fine pulp, about the consistency of corn meal. This requires about six hours. The contents of the vat are submitted to an acid test from time to time, to determine if any free acid is being liberated as the pulping proceeds. Should the test show the presence of free acid, sufficient sodium carbonate is added to neutralize the acid.

Poaching.—The poacher consists of a large deep cylindrical vat with a propeller-shaped wheel on a vertical axis near its bottom. Steam pipes are placed over the bottom. The cotton is taken from the pulper and put in the poacher, and subjected to the action of a boiling carbonate of soda solution. It is then rewashed in cold water as in the purifying vats, the process continuing for three days, having twelve changes of water, and two hours boiling at each change. The propeller keeps the mass circulating throughout the entire process. The nitro-

cotton is then taken from the poacher and dumped into a large volume of pure cold water which is contained in a large trough. An endless belt of coarse cotton cloth which, at some distance outside of the trough, passes between two rollers, circulates through the trough. As the belt moves through the mass of suspended cotton a certain quantity adheres to it, and the belt carries this up through the rollers, which squeeze out the surplus water. The cotton is detached from the belt by a scraper, and falls into receptacles placed on the other side of the rollers. The cotton is now in the form of small thin flakes and is called "pyro," and contains about 58 per cent. of water. At this point it is submitted to careful laboratory tests. If this mass was now compressed into blocks it would be in the usual form of gun-cotton.

Dehydrating.—The pyro is now taken to the dehydrating press and the water is extracted by means of alcohol, which is forced through the pyro by air pressure, the alcohol displacing the water. Sufficient alcohol is left in the cotton to accomplish its colloidization, when ether is added in the next operation. About 15 pounds of pyro is placed in the cylinder of the dehydrating press and subjected to a pressure of 200 pounds to the square inch. This forms it into a cylindrical cheese. Not all of the water is forced out by this pressure, so about 14 pounds of alcohol is let into the cylinder. Air is now admitted over the alcohol and subjected to a pressure of 100 pounds to the square inch. This forces the alcohol through the pyro, the liquid flowing out through the pipe below. First water comes out, then a mixture of water and alcohol, and finally alcohol of full strength. A pressure of 3,000 pounds per square inch is now put on the cheese, and more of the alcohol forced out, enough remaining, however, for colloidizing.

Colloidization.—The pyro-cheese, weighing about 17 pounds, is taken from the dehydrating press to the colloidizing machine, which is an ordinary kneading machine. Three of the pyro cheeses are broken up and put into the kneader with about one-half of their weight of ether. The kneader is started and the charge is mixed until all the ether is absorbed, which as a rule requires about two hours. At the end of this time the colloidizing is finished, and the product should be a smooth compact colloid with a clear amber or light-brown color. The colloid is pressed into a cake by hydraulic pressure, and should show a few white spots when finished, which are caused by air bubbles.

Granulation.—The colloid cake is now put through the macaroni press, which is a hydraulic press having small holes in the bottom of

POWDER CHARGES

WEIGHTS OF POWDER CHARGES, MUZZLE VELOCITY, AND PRESSURE FOR RAPID-FIRE AND SEACOAST GUNS, SERVICE AND PRACTICE CHARGES

Weight of charge (lbs.): Smokless—	1-pounder subcaliber tube.	18-pounder subcaliber tube.	6-pounder.	15-pounder, models of 1891 and 1902.	15-pounder, model of 1903.	4-inch D-S.	4.72 inch Armstrong.	6-inch Armstrong.	6-inch O. D., Model of 1897.	5-inch O. D., Model of 1900.	6-inch O. D., Model of 1900, 1903, 1905.	8-inch Rifle.	10-inch Rifle, Models of 1888 and 1895.	10-inch Rifle, Model of 1900.	12-inch Rifle, Models of 1888 and 1895.	12-inch Rifle, Model of 1900.	12-inch M., Models of 1886-90 M.	12-inch M., steel, Model of 1890 M.				
Nitroglycerin	1.25		1.25				40-7.5 45-10.5 50-10.5															
Nitrocellulose	*2.5	*7	1.35	5	6.06	7.5	40-5.5 45-8.2 50-8.2	19	16.4	23	29.74	39.1	80	155	205	275	325	33	62	54		
Cordite								13.3														
Brown prismatic						12.0							135	280		490		75	105	105		
Muzzle velocity (f. s.): Smokeless	2100	750	2400	2600	3000	2300	40-2150 45-2570 50-2600		2600	2600	2600	2600	2200	2250	2250	2250	2250	1050	950	1325	1150	
Cordite								2150														
Brown prismatic						2000							1975	2025		2025		1020	900	1150	1020	
Weight of igniter													1.5	4	4	7	9	1.25	1.25	1.25	1.25	
Maximum permissible pressure (pounds per square inch)	25000	18000	37460	34000	41000	34000	34000	34000	38000	38000	38000	38000	38000	38000	38000	38000	38000	27500	27500	33000	33000	
Weight of bursting charge, A. P. shell											†4.3	†4.3	†11.5	†22.4	†22.4	†39.4	†39.4					

NOTE.—The weights of powder charges are average weights; charges vary with different lots of powder.
* Ounces.
† Gunccotton.
‡ Maximitite or Explosive D.

its cylinder. The colloid is forced by a pressure of 500 pounds through these small holes and falls in a receptacle below in macaroni-like strings. The object of this operation is to free the colloid from air bubbles and to blend it better. The macaroni-like strings are collected and put into the final press, where they are pressed into a cake, known as the powder cake. The powder cake is put through the die press, which is a horizontal press with a cone-shaped cylinder, into the apex of which is fitted the die with needles of the proper size for the perforation. The continuous pressure forces the colloid into the cone and out through the die, the needles making the perforations. The rope-like cylinder of the diameter of the powder grain is carried on rollers along the table on which the press rests, until it reaches a point where it is cut into grains of the proper length by a revolving disc. The die can be changed so that any size grain may be formed.

Drying.—The grains from the die press are collected in cans with woven wire bottoms and are taken to the solvent-recovery house, where hot air is forced up through the grains. This hot air carries off a portion of the solvent, and the grains shrink accordingly. The powder is now taken to the dry house, where it kept from two to four months in a drying temperature from 100 to 105 degrees F.

Lot Number.—A record is kept of each "pyro lot," and several of these lots are allowed to accumulate, after which they are blended and receive a "lot number." The blend lot number is indexed and is that which reaches the service.

Cordite.—This is a British smokeless powder composed of 37 parts guncotton, 58 parts nitro-glycerine, and 5 parts vaseline. This powder gives very high muzzle velocities with low pressures, but the temperature of its explosion is so high as to cause a rapid erosion of the bore. For this reason the percentage of nitroglycerine has gradually been reduced and the result is given in the new powder called "Cordite M. B." which contains 58 parts guncotton, 37 parts nitroglycerine and 5 parts vaseline.

Brown Prismatic Powder may be used in the 8-, 10-, and 12-inch rifles and the 12-inch mortars. As this powder rapidly deteriorates it may be necessary to increase the charge to the capacity of the chamber to obtain the proof velocity. This involves the building up of charges, the operation of which, in the case of this powder, consists of stringing the grains on wires to make the required height of the charge, as shown in the following table:

	Number of Sections in Charge.	Length of Section (Number of Prisms.)		Full Charge.		Maximum Charge.	
		Minimum.	Maximum.	Weight, Pounds.	Prisms in Cross- section.	Weight, Pounds.	Prisms in Cross- section.
8-inch breech-loading rifle.....	2	23	24	135	31	154	34
10-inch breech-loading rifle.....	2	30	31	280	48	320	55
12-inch breech-loading rifle.....	*1	3	18	380	76	450	85
		18	19	110	61	110	61
12-inch breech-loading mortar, cast- iron, hooped.....	1	14	75	61	81	61
12-inch breech-loading mortar.....	1	19	105	61	110	61

* Cone Section.

After the charges are built up the black powder priming charge is placed in position on top of the charge and the serge silk bags slipped down over the form. The charge is then inverted and another priming charge placed on what is now the top. The bag is then sewed up with silk thread; then weighed; and, in the case of mortars, the zone number marked thereon.

For brown prismatic powder either one of two forms of igniter may be used, namely: 1. Seven black prisms in the center of the bottom layer of each section of the cartridge. With this igniter the bottom of the bag next to the vent must be cut when loaded to insure ignition. 2. In this case the bag is made with a double bottom; the outside thickness is of the same cloth as the bag, but the inside thickness is of a lighter cloth such as that used in field and siege cartridges. About 2 ounces of rifle powder for the 8-inch rifle and 3 ounces for the 10- and 12-inch sections are spread between these two bottoms, more thickly toward the middle, the bottom is then quilted in about 1-inch squares to retain the powder in place.

Each lot of powder or cartridge issued is marked for the weight of charge and proof velocity and pressure; these are to be considered the standard for that powder, unless subsequent changes are announced in orders. The propelling charges of smokeless powder for both the reserve supply and target practice are issued in hermetically sealed cartridge storage cases.

No changes in these powder charges are allowable without the express authorization contained in orders or in instructions from the Chief of Ordnance. Changes in charges should always be made with

care, even when, by calculation, the pressures appear to be within the safe limits. All lots of smokeless powder that have been tested in recent years, except those specially noted, have been adjusted to give the prescribed muzzle velocity when fired at the standard temperature of 70 degrees F. When powder is used at any other temperature than that of the standard, correction must be made therefor. See "Powder chart." In some of the earlier tests of lots of smokeless powder, only the temperature of the air, and not that of the powder at the time of firing was recorded.

To avoid irregular and sometimes excessive pressures, the total length of charge of guns should really equal the length of chamber, and should never be less than 9/10 of that length. When reduction of the charge is found necessary care must be taken that the new cartridge made is firm and that the bag is of the necessary diameter and uniform over its length. The requirement as to length of charge is not necessary in the case of mortars.

Smokeless powder may be used in all types of guns. Before building up charges of smokeless powder or before using those that are issued already built up it is necessary that the entire amount of powder to be used is thoroughly blended.

Blending.—The method of blending powder just prior to its use is as follows: A suitable floor space is first covered with paulins around the outer edge of which are placed boards (1x12 inches), supported by brackets to keep them in place and prevent the powder from scattering. All the powder to be used is taken from the cases and bags, and placed in a single pile in the center of the covered space. Ten men, provided with wooden shovels, form 10 circumferential piles by shoveling carefully from the bottom of the large center pile to the tops of the 10 smaller piles until the center pile is exhausted. The powder from the 10 small piles is then shoveled from the bottom of each to the top of the large center pile, each shovelful being scattered over the pile as much as possible during the operation. The operation of shoveling from the center pile to the 10 small piles and back again forms one cycle of the blending process, and to thoroughly blend a lot of powder requires 5 cycles.

Nitroglycerin and nitrocellulose powders must not be blended together. Each charge should always be made up from the same lot of powder.

In blending smokeless powder it should not be done in the direct rays of the sun.

Only powders of the same lot are blended together. Charges for a

given zone, weight of projectile or model of gun, should not be changed for any other zone, weight of projectile or model of gun.

With nitrocellulose and nitroglycerin powder charges, the bag is opened and the powder charge shoveled in. The section is then laid on a table and rolled to get it as compact as possible before beginning to lace it. To avoid bulging in the center, the lacing is commenced at the middle and carried towards each end, in order to keep the section of uniform diameter.

In lacing, place the point of the needle close to and outside the seam or plait, letting the needle come out between it and the expansion plait and pass over the latter; lace from left to right and right to left, taking stitches about one and one-half inches apart. After lacing about 4 inches of the length of the bag, draw the lacing taut and tie the twine, so that if the twine should break in handling, the section cannot lose more than 4 inches.

Cartridge bags for 5 and 6-inch rapid-fire guns have no extension plait.

The dimensions of the sections of cartridges of smokeless powder made up with the average charges of powder are given in the following table:

	Charge. Pounds.	Cartridge (or Section.)		
		Number of Sections.	Diameter, Inches.	Length, Inches.
5-inch rapid-fire gun, model 1897.....	16.4	1	5.25	27.00
5-inch rapid-fire gun, model 1900.....	23.0	1	5.75	34.50
6-inch rapid-fire gun, model 1897.....	29.7	1	6.00	32.00
6-inch rapid-fire gun, models 1900, 1903 and 1905.....	39.1	1	6.90	41.00
8-inch rifle.....	80.0	2	8.25	24.00
10-inch rifle, models 1888 and 1895.....	155.0	2	10.25	30.00
10-inch rifle, model 1900.....	205.0	2	12.00	‡ 33.00
12-inch rifle, models 1888 and 1895.....	275.0	4	* 12.25	18.25
12-inch rifle, model 1900.....	325.0	4	† 14.00	§ 20.25
12-inch mortar, cast-iron, hooped.....	33.0	1	10.75	15.00
12-inch mortar, steel.....	62.0	1	12.00	20.00

* 12.25 to 13.

† 14 to 14.5.

‡ 33 to 35.

§ 20.25 to 21.25.

Igniting Charges.—These charges are composed of black rifle powder. As explained above they are placed in position at each end of the sections of the charge, their function being to properly ignite the less inflammable charge of smokeless powder.

The weight of igniting charges will be found in the table of weights of powder charges, etc., on page 255.

Blank Ammunition.—Blank ammunition is used in firing salutes, for maneuver firings, and for the morning and evening gun, and for instruction purposes.

All firings with blank ammunition, whether with breech or muzzle-loading guns, is under the *personal supervision of a commissioned officer* who is present at the firing and directs it. Whenever more than 1 round is fired from any gun or guns he sees that the chamber of breech-loading guns and the bore of muzzle-loading guns is carefully sponged out with a damp sponge, to extinguish sparks and remove powder residue after each round and before the insertion of another round.

Care must be exercised to see that the sponges are not worn and that they thoroughly fill the chamber or bore. The interval between rounds of blank ammunition should be sufficient to allow thorough sponging of the chamber or bore and examination to ascertain that all sparks have been extinguished.

Guns using metallic ammunition are employed whenever practicable in firing blank ammunition; in their absence breech-loading guns using loose ammunition should preferably be used.

Muzzle loaders are used only when breech loaders are not available. When using muzzle-loading guns a sufficient number should be employed to avoid the necessity of firing the same gun until a reasonable interval has elapsed.

The cartridge bags for muzzle-loading guns or breech-loading guns not using fixed ammunition are of silk, chemically treated to make it as non-inflammable as possible, and the cartridges are made to measure in length at least $1\frac{1}{2}$ times the diameter.

It has been found difficult to tie the open end of the cartridge bags heretofore used for blank charges in such a manner as to prevent that end opening and permitting powder grains to leak out. The cartridge bags now issued have both ends alike. There is an opening left between the circular disk forming the front end of the bag and the body, which should be closed by sewing after the charge has been inserted.

The post ordnance officer before issuing cartridges for blank ammunition firing to organizations sees that the bags are in sound condition and that no powder can escape therefrom, and the bags are inspected further as to their condition in this respect by the commissioned officer in charge of the firing before their use.

Unless *all* the above conditions be fulfilled blank ammunition should

not be fired with breech-loading guns using non-metallic ammunition or with muzzle-loading guns.

Blank metallic ammunition for saluting and maneuver purposes is assembled at posts. For this purpose there are issued saluting cartridge cases, saluting powder in bulk, tight-fitting felt wads, primers, adapters, etc.; also reloading, decapping, and cleaning outfits. The cartridge cases are issued unprimed, with primers in separate moisture-proof tin boxes, and are not primed until just before inserting the powder charge and the wad. Cartridge cases should never be primed after the powder charge has been inserted.

The same care must be exercised in sponging the chamber with guns using metallic ammunition as with guns using non-metallic ammunition.

Saluting cartridge cases for 6-pounder, 15-pounder, 4-inch, 4.72-inch, and 6-inch guns may be distinguished from service cartridge cases by the fact that they are considerably shorter than the service case. Service cases of the above calibers will under no consideration be used in the preparation of blank ammunition. For all other guns using metallic ammunition the service case and the saluting-cartridge case are the same.

Primers will not be removed from the hermetically sealed cases in which they are received until they are to be used. They are made a tight fit in the primer seat of the cartridge case, and should be pressed into place with the inserting press and not hammered in.

In preparing saluting ammunition the following instructions must be observed:

(a) Before assembling, the saluting case should be inspected to see that it is thoroughly clean and dry. The primer will then be inserted with the inserting press; after which the proper weight of loose powder will be poured into the case and shaken down.

(b) A felt wad will next be inserted and pressed down hard until it rests squarely on the powder charge.

(c) The wad will then be made fast to the cartridge case, to prevent its being dislodged in handling, in the following manner: Pour rubberine paint upon the surface of the wad and case until it forms a layer over the surface about a sixteenth of an inch thick. Allow the case to stand from 10 to 20 minutes, until the paint has dried and been partly absorbed by the wad. Then pour in an additional amount of paint around the edges of the wad to entirely seal the joint between the wad and the cartridge case, and also to form a layer on the side of the cartridge case from .02 to .03 of an inch in thickness.

The rubberine paint is very tough and strongly adhesive, and if

used as directed will prevent danger of wads dropping out in handling.

The wads, when issued, are a tight fit in the cartridge case for which they are intended. If, after storage, it is found that any have shrunk so as to fit loosely they should not be used, but a report on their condition made to the proper authority in order that they may be replaced.

If rubberine paint is not available, any other quick-drying paint issued by the Ordnance Department for coating cavities of projectiles may be used instead.

Blank ammunition for saluting purposes and for morning and evening gun should be made up in lots of 25 cartridges (the number of primers contained in a box), but a new lot should not be made up until two or three days before the supply on hand is exhausted.

WEIGHTS OF SALUTING POWDER CHARGES

Gun.	Charge.
1-pounder subcaliber.	5¼ ounces saluting powder.
6-pounder (2.24-inch) rapid-fire gun	1½ pounds saluting powder.
2.95-inch subcaliber tube.	1 pound 6 ounces saluting powder.
3-inch wrought-iron gun, saluting *	1½ pounds saluting powder.
15-pounder (3-inch) rapid-fire gun.	2 pounds saluting powder.
3-inch gun (M. L.)	1 pound mortar or saluting powder.
6-pounder (3.67-inch), bronze.	1 pound mortar or saluting powder.
4-inch rapid-fire gun.	4 pounds saluting powder.
4.72-inch rapid-fire gun, Armstrong	5 pounds saluting powder.
5-inch rapid-fire gun (Ord. Dept.)	5 pounds saluting powder. †
6-inch rapid-fire gun, Armstrong.	5 pounds saluting powder.
6-inch rapid-fire gun (Ord. Dept.)	8 pounds saluting powder. †
8-inch converted rifle.	7 pounds saluting powder.
8-inch smoothbore gun.	7 pounds saluting powder.
10-inch smoothbore gun.	10 pounds saluting powder.
8-inch rifle.	12 pounds saluting powder. †
10-inch rifle.	18 pounds saluting powder. †
12-inch rifle.	30 pounds saluting powder. †
12-inch mortar.	18 pounds saluting powder. †

* This gun uses the standard 6-pounder saluting case.

† Used during maneuvers only if specially authorized.

NOTE.—Smokeless powder will not be used for blank charges.

Blank metallic ammunition should be assembled under the personal supervision of a commissioned officer, who should be held responsible that the ammunition is prepared and the wads secured as prescribed above, and who will mark the cartridge cases with his initials to indicate that the round has been assembled properly, and no blank metallic ammunition on which his initials do not appear will be used. Cases

should be marked in such manner that the marks may be removed after the charges have been fired.

The primer-inserting press issued is made especially for the 15-pounder seacoast gun, bushings being provided for guns of less caliber using fixed ammunition. Each post is furnished with one of these presses and such bushings as may be required, also decapping and cleaning outfits.

Metallic powder barrels of 25 pounds capacity or over should be returned to the depot or arsenal from which shipped; when emptied, care should be taken to store in a dry place.

The table on the opposite page shows the authorized weights of blank charges used in saluting, etc.

High Explosives.—The high explosives are disruptive, and consist of the shell-fillers, those used in torpedoes, mines and for demolition purposes. Those in general use are: Gun cotton, nitroglycerine, picric acid, dynamite, explosive "D," maximitite, trinitrotoluol and blasting gelatine.

The action of explosives of this class is entirely different from that of those of the low order. In this case the explosion is not confined to the surfaces of the substances exploded, but appears to progress radially in all directions throughout the mass from the initial point. The time is extremely short and the effect is to transfer the explosive from the solid or liquid state to the gaseous state in an almost inappreciably brief interval. The gases are increased very rapidly in volume and pressure by the heat of the combination.

Gun Cotton.—This explosive is a nitrocellulose of high nitration or containing more than 12.9 per cent. of nitrogen.

Its manufacture is practically the same as that described for nitrocellulose powders, except that the process is discontinued before colloidization takes place. When made for military purposes the purified pulp is taken from the poacher to a stuff chest by suction. This chest consists of a large vat with an air-tight top. Through the center of the vat passes a vertical shaft upon which are mounted a number of paddles. The purified pulp having been sucked up into the stuff chest is kept agitated by these paddles so that the pulp will be evenly distributed in suspension through the liquid. From the stuff chest the pulp is drawn into the moulding press. This is a hydraulic press made of bronze and containing four moulds. The pulp is run into these moulds and a pressure applied for about four minutes. The mould press blocks are then placed in the mould of the final press and a pressure of from 6,000 to 7,000 pounds is applied.

While in this press they are stamped with the name of the manufacturer, the lot and the year.

The blocks from the final press contain about 15 per cent. water, but before being issued for storage they should be soaked in pure water until they contain about 25 per cent. of water.

Gun cotton is recommended for use (when wet) for mines, torpedoes and demolitions of all kinds. Its great value as a disruptive agent rests upon its great force and in its safety in manufacture, storage and handling. It is less liable to accident or spontaneous explosion than any other explosive now used, and when kept in storage in a wet state it is non-explosive except with a powerful detonator or a small piece of dry gun cotton.

Cold has no effect on dry gun cotton. If wet and exposed to freezing and thawing, the compressed cakes or disks will flake off on the surface; the freezing also causes the mass of the cake or disk to open out and be less compact. Variations of temperature between 32 degrees and 135 degrees F. have no effect on either the physical or chemical condition of gun cotton. Even when dry it is not liable to explode by a blow or friction unless very closely confined and compressed. When wet in any form it cannot be ignited by flame, and a wet disk when thrown into a fire will first dry out on the outer surface and burn there, continuing this progressively until consumed.

Gun cotton when wet explodes more brusquely than when dry, because the water in the pores being incompressible increases the velocity of the explosive wave. It has been found by experiment to detonate wet gun cotton with a dry priming charge of gun cotton, the main charge and priming charge must be in intimate contact, that is, they must not be separated by material of any great thickness.

Owing to its safety in handling and storage it is of great value as an explosive for submarine mines and is used almost exclusively for that purpose when it can be procured.

It is ordinarily packed in a wooden zinc-lined case, the lid of which has an opening with a screw top, in which water is periodically poured, in order to keep the charge thoroughly saturated or up to its wet weight. These cases are weighed quarterly and should they be found to weigh less than their registered gross weight the deficiency is made by adding distilled water.

Dry gun cotton is used as a priming charge for submarine mines and comes packed wet in glass jars. Before being used for this purpose it is necessary to dry the charge, in a warm room, until weighing on two successive days fails to show any loss due to evaporation.

In color gun cotton varies from white to light yellow and is usually issued in the form of compressed cakes or that of the pulp form.

Nitroglycerine consists of glycerine, nitric acid and sulphuric acid.

The process of manufacture is as follows: A large amount of glycerine is nitrated by gradually allowing a small amount of glycerine to enter into the presence of mixed acids in succession. The acids, which consist of two parts by weight of sulphuric acid specific gravity 1.845, to one part of nitric acid specific gravity 1.150, are placed in a lead-lined chamber above which is a tank containing the glycerine, the two being connected by a pipe having a coil with numerous fine holes on the bottom of the acid chamber. A pipe running into the top of the glycerine tank supplies compressed air, which forces the glycerine down into the acids. If the temperature of the acid chamber rises above 86 degrees F. and cannot be controlled by stopping the admission of glycerine the compressed-air pipes leading into this chamber are opened and the acid tanks cooled by the expansion of the air. If the temperature still rises the contents of the chamber are drawn off into the safety tanks. It requires about one hour to charge the apparatus, nitrate and discharge the contents. The nitroglycerine should then contain about 92 parts of glycerine and 189 parts of nitric acid. When the nitration is completed a cock is opened and the contents are drawn off by gravity into the separating tank.

The separating tank is provided with a cock near the top for drawing off the nitroglycerine into the washing tank and three at the bottom leading respectively to a safety tank, a waste acid tank and a second separating tank. It is arranged so that the compressed air can be admitted if heating develops, and should this not be effective the liquid can be drawn off into the safety tank. The nitroglycerine separating from the waste products rises to the top and is drawn off into the washing tank, the waste products being drawn off at the bottom.

In the washing tank the nitroglycerine is kept under pure water, compressed air being forced through the liquid to keep the temperature below 86 degrees F. In a few minutes after the air is shut off the liquids separate, and the nitroglycerine, being the heavier, settles to the bottom and is drawn off through a cock at the bottom of the tank. The liquid is rewashed and then filtered to remove any foreign particles. The final product is allowed to stand in a warm room for several days, during which time a small quantity of water will arise to the top and may be removed by skimming and absorbing.

Nitroglycerine is made from chemically pure ingredients, and should have the appearance of a water-white oily liquid without any odor.

Some commercial nitroglycerines have a yellow color, more or less deep. When free from water it is transparent; the presence of water makes it milky. It has a slightly sweet taste, gives a burning sensation, is very poisonous and a small quantity absorbed through the skin, mouth or nostrils causes a severe headache, followed by giddiness and fainting; and, if sufficient quantity has been taken, produces rigor and unconsciousness.

Pure nitroglycerine freezes at about 4 degrees C., and does not melt from the frozen state until about 11 degrees C. In the frozen state it is less sensitive to shock than in liquid shape but the process of thawing is very dangerous and should never be attempted over a naked flame or by direct contact with the heated metal. The only safe way to thaw nitroglycerine is in a water bath the temperature of which should never be allowed to rise above 50 degrees C. When frozen, nitroglycerine is very liable to explode over a naked flame or hot metal. Liquid nitroglycerine is not sensitive to flame and will extinguish a match plunged into it; an incandescent platinum wire will be cooled down, the nitroglycerine being volatilized. A small quantity of the liquid ignited in the open air will burn quietly, but if the quantity be large and in any way confined an explosion will be sure to occur. It will explode by a shock under certain conditions, as when pinched between two rigid surfaces of metal or rock, and it will be detonated if a bullet is fired into the mass.

In handling nitroglycerine rubber gloves should be used, and all friction and shock avoided. As now manufactured it does not deteriorate very rapidly, and if care is taken to see the vessels or crocks in which it is stored or transported do not leak there should be no danger in handling. Its dangerous qualities are due to creeping and sweating. In storage liquid nitroglycerine is covered with a layer of water. Its chief value is found in the manufacture of dynamite, an accelerator for smokeless powders and for blasting purposes.

Picric Acid.—This is an explosive derived from the nitration of phenol or carbolic acid. Both picric acid and its salts are largely used in detonating and disruptive explosives. Lyddite, melinite, shimose powder and ecrasite consist for the most part of picric acid, in fact, lyddite is simply melted picric acid.

Picric acid has been found by experiment to be too sensitive as a shell filler for armor-piercing shell, although it has been used successfully as a shell filler for field-artillery projectiles. Its process of manufacture is as follows:

Equal quantities by weight of phenol and concentrated sulphuric

acid are mixed in, an iron vessel, stirred and heated by steam at a temperature between 212 and 250 degrees F. From time to time tests are made to see if the mixture formed is soluble in cold water. When this is so the mixture is allowed to cool and twice the quantity of water is added. The nitration then takes place in earthen vessels standing in running water which can be heated by steam pipes. In these receivers 3 parts by weight of nitric acid is placed and 1 part of the mixture described above, is added. The latter is allowed to run in gradually at first, as the reaction is violent. Afterwards it becomes sluggish and then steam is turned on and the temperature of the solution raised to restore the chemical action.

The picric acid formed separates at first into a syrupy liquid, becoming crystallized on cooling. It is separated from the other liquids by a centrifugal machine and is washed in the same machine with pure warm water. The crystals are further purified by re-dissolving in warm water, re-crystallizing and finally drying.

The crystals are long, flat and lemon-colored. It has a bitter taste, is partly soluble in cold water but entirely so in hot water, giving a solution of a bright yellow color. It stains the skin and is used as a yellow dye. If heated suddenly it will explode, and if added to any potassium salt forms a very sensitive explosive and must be handled with great care. The combination of picric acid with metal bases such as lead, iron and potassium makes an exceedingly sensitive compound, and for this reason care must be taken in filling iron shells with picric acid or its derivatives.

Of all the picrates of salts of picric acid there is only one that is suitable for use as an explosive, and that is ammonium picrate, which unlike the metallic picrates, is insensitive to shock.

Dynamite.—This term is used in both a general and special sense. As a general term it includes all mixtures of nitroglycerine with solid substances, in which the latter hold the liquid nitroglycerine in absorption. The solid substance is called the base and may be an explosive or combustible material. In this sense smokeless powders, such as cordite, having nitroglycerine as an accelerator, partake of the nature of dynamite, but the name is used with reference to explosives designed for disruptive purposes only.

In a special sense the term refers to the product obtained by mixing liquid nitroglycerine with a fine, usually white, siliceous earth called kieselguhr. This earth has marked absorbent properties due to its cellular structure, and having once absorbed liquid nitroglycerine holds it tenaciously. Kieselguhr will absorb nitroglycerine to the extent of over

80 per cent. of the weight of the mixture. The amount of nitroglycerine absorbed in any case determines the class of dynamite. That containing 75 per cent., the highest commercial percentage, is called dynamite No. 1; 50 per cent. nitroglycerine, dynamite No. 2; 30 per cent. nitroglycerine, dynamite No. 3. In each case of the classes of dynamite mentioned above a little sodium carbonate is always added to neutralize any free acid that may be formed.

The commercial names for the several classes of dynamite are as follows: Dynamite No. 1, Giant or Atlas powder; Dynamite No. 2, Atlas powder B, Giant powder No. 2, and Rendrock; Dynamite No. 3, Vulcan and Judson powders.

In the manufacture of dynamite the following steps are taken: 1. Kieselguhr is converted into a powder by the action of heat in a furnace. 2. It is then ground between rolls, passed through fine sieves, dried and packed in bags and stored in a drying atmosphere. 3. When the kieselguhr is dried until it contains not more than 5 per cent. of water it is spread over the bottom of a lead-lined trough and nitroglycerine is pored over it and mixed thoroughly. 4. The mixture is then rubbed through sieves, first through one containing 3 meshes to the inch, and then through one containing 7 meshes to the inch. 5. The bulk dynamite is pressed into cylinders about 1 inch in diameter and 8 inches long. These cylinders are called sticks or cartridges, and are carefully wrapped in paraffine paper. Enough of the cartridges to weigh 50 or 100 pounds are packed in sawdust in wooden boxes. In appearance dynamite manufactured in this way has a light brown to reddish-brown color and resembles brown sugar.

Dynamite in the military service is used as a standard explosive for submarine mines and in demolitions. It is more sensitive than gun cotton and requires great care in handling and storage. It is more sensitive when thawed than in its usual or frozen condition.

Due to the fact that it contains nitroglycerine, which is one of the most sensitive explosives, dynamite can be exploded by friction or shock. In storage, in magazines where the temperature is apt to be high it will deteriorate quite rapidly, such deterioration being indicated by its damp, pasty condition or green spots on the paraffine wrappers. In such cases care must be taken not to slide the boxes in moving. It should also be destroyed in the open air when it has reached this state of deterioration.

Explosive "D".—This explosive is a picric acid derivative. It is a compound of picric acid with certain other elements which it has been thought to the best interests of the service to keep secret. It is

used extensively as a shell filler, due to the fact that it is least sensitive to shock of all the explosives considered. It is not fusible, that is, it cannot be melted or liquefied. Shells are filled with it by compression, that is, the explosive is put in the cavity of the shell in small quantities and thoroughly tamped with either a copper or wooden tamper or mallet, until the cavity is completely filled.

The relative force of explosive "D" for actual density of loading as compared with that of gun cotton is practically twice as great. It is perfectly safe in manufacture and free from very injurious effects on the workmen. It is insensitive on impact and stands the maximum shock of discharge safely. It is non-hygroscopic and stable in storage. It resembles powdered sulphur very closely in appearance.

Maximite.—This explosive is also a picric acid compound, the composition of which has been kept secret. It is fusible and a suitable explosive for armor-piercing shell. It differs from explosive "D" in that it is melted when used to fill shells. Also in the requirement that the metal of the shell must be protected with rubberine paint before it is put in. In all other requirements as a service shell filler it is practically similar and equal to explosive "D."

It resembles explosive "D" except that it is much darker, having a light brown or buff appearance.

Trinitrotoluol.—This explosive is rapidly superseding picric acid as a basis for shell fillers. It is slightly less powerful than picric acid but possesses many advantages over it, one of which is that it will not form dangerous combinations with other bodies with which it may come in contact, whereas picric acid in contact with certain metals forms very unstable and dangerous picrates. Trinitrotoluol is not unpleasant to work with, nor does it disfigure like picric acid.

Blasting Gelatine.—This is the most powerful explosive known. It is 17 per cent. greater in strength than dynamite No. 1. It differs from ordinary dynamite in that the usual pressure does not cause the nitroglycerine to exude, and it is not affected by the action of water except on the surface. The ingredients are nitroglycerine and soluble nitrocellulose, about 90 per cent., of the former to 10 per cent. of the latter.

In manufacture the mixing is done in troughs at a temperature of 122 degrees F., with wooden spades, and when the mass is so gelatinized as to make it difficult to work with spades, it is kneaded by hand like bread dough until it has a smooth, even consistency. It is then removed and allowed to cool, when the mass becomes a firm, jelly-like substance, yellow or light brown in color, and soft enough to be cut by a knife.

The finished product is placed in a machine very much like an ordinary sausage-making machine and forced out in a long cable and cut to the desired lengths by a bronze knife. The cylindrical sticks are then wrapped with paraffine paper.

The initial shock required to detonate blasting gelatine is six times greater than that required to detonate ordinary dynamite, and for this reason it is far less sensitive to sympathetic explosion or explosion by influence. When frozen it is more sensitive to shock than dynamite, but freezing does not seem to affect its explosive force. The same care must be exercised in thawing as in the case of ordinary dynamite. A small quantity of it burns in the open air without exploding and it will burn in mass quietly unless some part reaches the exploding temperature, 204 degrees C. It is very stable under the action of heat, but its sensitiveness is increased thereby.

This explosive is far too violent for many purposes, and it has therefore been necessary to incorporate with the gelatine some suitable base, such as sodium nitrate and wood pulp, with a view of regulating the force of explosion. Explosives of this kind are called gelatine dynamites and consist of 65 parts by weight of blasting gelatine to 35 parts by weight of the base described. It has been found that by adding 10 per cent. of camphor to blasting gelatine it will not explode. It cannot be used as a shell filler and is only suitable for purposes of demolition.

Fulminates.—The characteristic feature of fulmination is that it is more brusque than in the other two classes. The explosive blow is not prolonged and it is therefore much sharper than in the case of other explosives. The heat of the first phase of the explosion is also very great, due to the fact that the molecules of the fulminate are endothermic, that is, they increase the temperature, and this in itself tends to increase the sharpness and energy of the blow on the initial molecule. Such a sharp molecular blow is thought to be particularly effective in breaking up the molecular bonds of the disruptive class, and in this way an explosion of the highest order is obtained. The abruptness of the explosion of fulminates and the consequent shortness of blow, combined with the concentration of very great heat at the point of ignition, causes the fulminates, or as they are frequently called, detonators or exploders, to be of great value as originators of detonations and explosions in the first two classes.

Exploders or Detonators.—The essential ingredient of all caps and detonators is fulminate of mercury, which is formed from metallic mercury, nitric acid and alcohol. The quantity of fulminate in any

particular exploder depends upon the kind of explosive used. It may require some other ingredient to be mixed with the fulminate, such as chlorate or nitrate of potassium, sulphide of antimony, etc., to give the character to the initial explosive blow.

The manufacture of fulminate of mercury is as follows: Equal parts by weight of mercury and nitric acid (specific gravity 1.38) are mixed in a glass carboy. The nitric acid dissolves the mercury and when completely dissolved the contents are allowed to cool. The solution is then well shaken to secure uniformity, and emptied into a second carboy, which contains 10 parts of ethyl alcohol, and is there kept at a temperature of 60 degrees F. After a few minutes the reaction begins, the liquid boils and white vapors of nitric and acetic ether, carbonic acid, etc. rise and pass off. The crystals of fulminate of mercury separate in the form of small gray-colored needles in about fifteen minutes afterwards. When the reaction is completed the product is allowed to cool, it is then filtered and washed with pure water until no trace of acid is found. The fulminate is then placed in a drying atmosphere out of the direct rays of the sun and allowed to dry until it contains not more than 15 per cent. of water.

The finished product is usually made up in packages containing 120 grains. When packed it contains 15 per cent. of water and is hermetically sealed to prevent evaporation, as it is much more sensitive to shock and friction in the dry state. When it is necessary to dry it for use in caps and detonators great care must be exercised. The temperature must be kept below 104 degrees F. It should not be kept in stoppered bottles and especially not in bottles having glass stoppers, as the friction of the moving and inserting of the stopper might detonate a particle of the fulminate caught in the neck of the bottle. It is exploded by a moderate blow of a hammer, by heat and by friction.

Fulminate of mercury is used very little except in caps and detonators. Powdered glass and sulphide of antimony are frequently used with it to increase its sensitiveness to percussion.

PROJECTILES

Projectiles used in seacoast cannon are designed primarily to overcome the resistance offered by armor plate to their entrance into the vitals of war vessels, or to carry a bursting charge into a destructive radius. The power of a projectile to accomplish this depends upon the shape of the projectile upon impact, the possibility of its breaking up, and the amount of heat developed upon striking a plate. In the

manufacture of projectiles it is very difficult to make them exactly alike, that is, exactly homogeneous. This variation even extends to projectiles made in the same foundry.

It is generally agreed that the dissipation of energy stored in a projectile when it strikes a target may be accounted for, (1) in heating the target; (2) in heating the projectile; (3) in changing the form of the projectile; (4) in changing the form of the target. From the standpoint of results obtained, all but the last of these are a waste.

The amount of energy in the projectile which, upon impact takes the form of heat, can be approximately estimated. It has been found that the temperature upon impact is sufficiently great to ignite a bursting charge of black powder which requires a heat of 540 degrees F. Again a bright red spot, even on bright days, can be observed at the instant the projectile strikes the plate, which shows that the plate in the immediate vicinity of the impact is heated to a high degree of temperature.

The penetrative effect of a projectile depends upon, (1) its shape; (2) its material; (3) its energy and diameter; (4) the angle at which it strikes the target; (5) whether it is capped or uncapped.

The shape believed to accomplish the best results is that of a cylindrical body with ogival head, the latter having a radius of from two to two and one-half calibers, that is, the radius of the curve forming the head is drawn from the arc of a circle the diameter of which is from two to two and one-half times the diameter of the projectile.

The material best suited for projectiles designed to pierce armor is that which will neither break up on impact nor change its shape. Forged oil-tempered steel of special treatment and composition has been found to come nearest to fulfilling these conditions.

The energy of a projectile necessarily depends upon its weight which, for any given projectile, is a function of its diameter. The best weight for a projectile of given diameter is generally found by obtaining the value of the ratio $\frac{w}{d^3}$, in which w is the weight of the projectile and d the diameter.

The smallest angle of impact (measured from the surface of the plate), at which a projectile will hold or bite, is called the biting angle. See Fig. 8. For plates of different materials, this angle changes. For plates of comparatively soft material, such as wrought iron and low steel, or if the plate is overmatched, the shot will bite at a slightly less angle than in the case of face-hardened steel, owing to the fact that the plate bends slightly on impact. For face-hardened armor the biting angle cannot be mathematically stated. As a general rule it may be

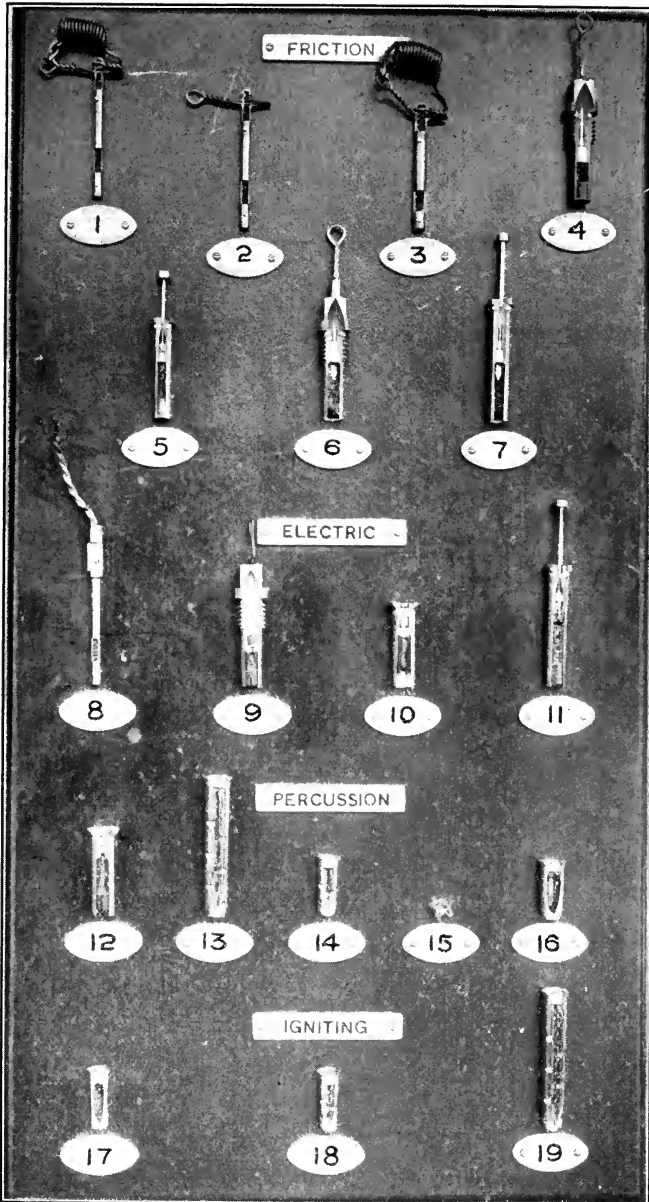

Types of Primers.

- | | |
|---|--|
| 1. Friction Primer, Axial Vent. | 11. Combination Electric and Friction, New Vent. |
| 2. Friction Primer, Radial Vent. | 12. Percussion for use with Armstrong Adapter. |
| 3. Friction Primer, Sub. Cal. Firing. | 13. 110-Grain Percussion Primer. |
| 4. Obturating Friction, Old Model Vent. | 14. 20-Grain Percussion Primer. |
| 5. Obturating Friction, Siege, New Vent. | 15. Percussion Primer, Battery Cup. |
| 6. Drill Primer, Old Model Vent. | 16. 20-Grain Saluting Primer. |
| 7. Drill Primer, New Model Vent. | 17. Igniting Primer. |
| 8. Electric Primer, Axial and Radial Vent. | 18. 20-Grain Igniting Primer. |
| 9. Obturating Electric, Old Model Vent. | 19. 110-Grain Igniting Primer. |
| 10. Electric Primer for use with Armstrong Adapter. | |



LIBRARY
OF THE
UNIVERSITY
OF
CALIFORNIA

defined as that angle at which the component of the energy of the projectile, normal to the plate, is sufficient to smash in the hard face, the projectile at the same time holding together long enough to penetrate. A projectile has its greatest penetration at normal impact and its penetrative power decreases as the angle of impact increases, but not in exact proportion.

All armor-piercing projectiles are now fitted with soft steel caps, which, under favorable angles of impact, increase their penetrative effect when attacking hard-faced armor. The cap as adapted in the service consists of a cylindrical piece of soft steel about half a caliber of the projectile in diameter, bored out to a depth of about two-thirds of its length to fit over the nose or point of the projectile. It weighs

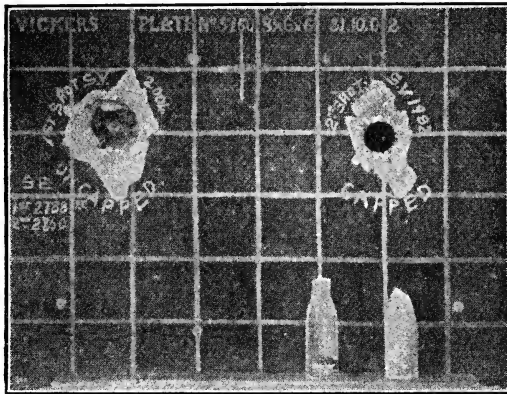

FIG. 21.—Armor Plate after Attack by Capped and Uncapped Projectiles.

ordinarily about $2\frac{1}{2}$ to 5 per cent. of the weight of the projectile. A recess or cavity in the interior, that is, between the nose of the projectile and the cap when assembled, contains a lubricant, usually graphite. The cap is made fast by a small cylindrical groove cut in the nose of the projectile, the cap being forced on under pressure. In the case of cast-iron projectiles used in tests and practice, the nose is cut off, the head bored to receive a threaded portion of the cap which is screwed into place, the object being to make the practice projectile identical in weight and shape to those used in service.

The theory of the action of the cap, which seems most reasonable, is that when the mass consisting of the projectile and cap meets the hard face of the plate, the latter acts as a buffer against the hard and impenetrable surface, and elastically dishes the plate on impact. The cap is strong enough to transmit the stress of impact, and at the same time the projectile proper is not stopped as suddenly as in the case of

one not capped, but continues to advance through the cap, which, being soft, is comparatively easy and when the point reaches the plate it finds the latter already dished practically to its elastic limit. Again, it gives the projectile a most decided advantage in having the tendency of preventing the projectile from breaking up on impact.

Fig. 21 is a photographic view of a 6-inch cemented armor plate against which were fired two shots from a 6-inch gun, at practically the same velocity. The projectiles in both cases were alike, excepting that the first was uncapped while the other was capped, similar to that shown in the view. The striking energies were virtually the same; but the uncapped projectile failed to penetrate and broke up on impact, the nose remaining embedded in the plate. The capped projectile, on the other hand, made a clean hole through the plate and was recovered whole, with the exception of a small piece broken from the point as shown in the illustration.

In the matter of acceleration of penetration, for normal impact against cemented plate, with velocities exceeding 1,800 f. s., the use of the cap will add about one-sixth to the penetrative power of the projectile; at angles of impact greater than 30 degrees the advantage gained by the cap is *nil* or almost so; with velocities less than 1,800 f. s., the cap is practically useless. Recently tests have been made with a new form of cap, and good results obtained. This cap is more pointed and covers the entire ogive, which has given rise to the term "long nose" to projectiles so capped.

SERVICE PROJECTILES

Armor-Piercing Shot are made of forged steel with a small cavity designed primarily to facilitate the tempering and hardening process. The cavity may be filled with a "shell filler" consisting of a high explosive bursting-charge. They are armed with a delayed action fuse, thus permitting of the perforation of armor plate before the bursting charge is ignited. (See Fig. 22).

Armor-Piercing Shell are made of forged or cast-steel with a larger cavity than that of shot. They are designed to carry a large bursting-charge of high explosive and to attack the thinner side armor of battleships or the vertical armor of cruisers. They are also provided with a delayed action fuse.

Deck-Piercing Shell are made of forged or cast-steel with a cavity of about the same dimensions as armor-piercing shell. They are provided with a torpedo detonating pierce fuse.

TYPES OF PROJECTILES FOR U.S. CANNON.

SCALE
1:100

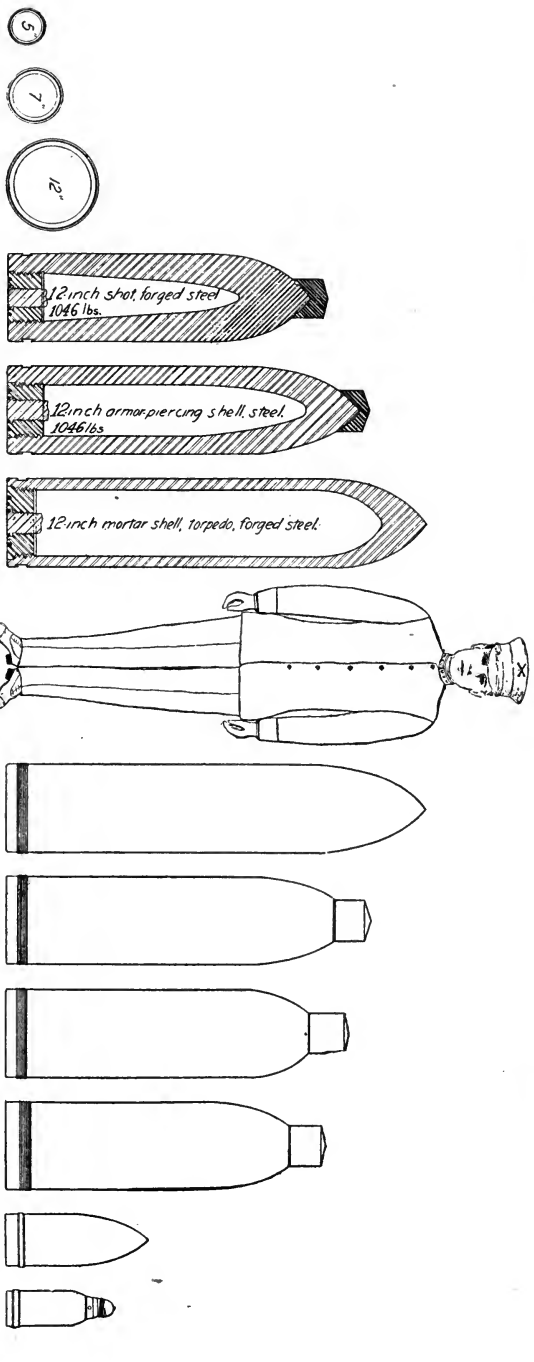

Bases
275

Fig. 22.
12" torpedo shell 12" C.I. shell 12" P shell 12" A.P. shot 7" shell 5" shell

Cast-Iron Shot are used exclusively for tests and service target practice. Their weight and dimensions are identical with the armor-piercing shot.

Torpedo Shell are made of forged steel and are designed to carry a very large bursting charge of high explosive onto the decks of war vessels. They weigh either 800 or 1000 pounds, and are provided with a major-caliber base detonating fuse.

The table on opposite page gives the weights of projectiles and their armor piercing capacity:

PAINTS FOR PROJECTILES

To distinguish the character of metal of which projectiles are made and their armor-piercing qualities, as well as the position and nature of their bursting-charge, conventional colors are prescribed for use on the exterior. The body color of all projectiles is black.

Colors to Distinguish the Character of Metal.

Forged or Wrought Steel—Blue gray.

Cast-Steel—Warm gray.

Cast-Iron—Olive green.

Chilled Iron—Light green.

Brass—Light yellow.

Copper—Light reddish brown.

The colors above named are also used to *indicate the degree of armor-piercing quality* of the projectile, as well as *the position* of its center of gravity, the latter being essential to facilitate the raising and lowering of projectiles with shot tongs.

To indicate the degree of armor-piercing quality, a greater or less portion of the head is painted with the color corresponding to the metal. The band indicating the center of gravity is also of the color corresponding to the metal. It is one-half caliber wide and extends equally above and below the position of the center of gravity. It may also be employed with the smaller calibers of projectiles to indicate the character of the metal.

Colors to Distinguish the Character of the Bursting Charge.

Gun cotton—White.

Explosive "D" or Dunnite—Deep (chrome) yellow.

Maximite—Dark buff.

Rifle or Charcoal Powder—Vermilion.

The bursting-charge color is applied to the base and the cylindrical portion of the body in rear of the copper rotating band. Until the projectile is filled, these portions may remain black.

PENETRATION IN INCHES IN KRUPP CEMENTED ARMOR OF VARIOUS PROJECTILES CAPPED AND UNCAPPED,
NORMAL IMPACT AT THE RANGES GIVEN.

Caliber.	Muzzle.		1000 Yds.		2000 Yds.		3000 Yds.		4000 Yds.		5000 Yds.		6000 Yds.		7000 Yds.		8000 Yds.		9000 Yds.		10000 Yds.		Weights of Projectiles, Pounds.	Velocities at Muzzle, f. s.
	Capped.	Uncapped.	Capped.	Uncapped.	Capped.	Uncapped.	Capped.	Uncapped.	Capped.	Uncapped.	Capped.	Uncapped.	Capped.	Uncapped.	Capped.	Uncapped.	Capped.	Uncapped.	Capped.	Uncapped.	Capped.	Uncapped.		
1.457-inch subcal. tube	0.54	Uncapped.	Capped.	Uncapped.	0.22	Uncapped.	Uncapped.	Uncapped.	Uncapped.	Uncapped.	Uncapped.	Uncapped.	Uncapped.	Uncapped.	Uncapped.	Uncapped.	Uncapped.	Uncapped.	Uncapped.	Uncapped.	Uncapped.	Uncapped.	1.1	2000
2.95-inch subcal. tube.																							18	550, 625 and 700
2.24-inch rifle (6-pdr.)	1.72	Uncapped.	Capped.	Uncapped.	1.12	Uncapped.	Uncapped.	Uncapped.	Uncapped.	Uncapped.	Uncapped.	Uncapped.	Uncapped.	Uncapped.	Uncapped.	Uncapped.	Uncapped.	Uncapped.	Uncapped.	Uncapped.	Uncapped.	Uncapped.	6	2400
3-inch rifle (15-pdr.), 1903.	3.51	Uncapped.	Capped.	Uncapped.	2.22	Uncapped.	Uncapped.	Uncapped.	Uncapped.	Uncapped.	Uncapped.	Uncapped.	Uncapped.	Uncapped.	Uncapped.	Uncapped.	Uncapped.	Uncapped.	Uncapped.	Uncapped.	Uncapped.	Uncapped.	15	2600
4-inch rifle	3.44	Uncapped.	Capped.	Uncapped.	2.66	Uncapped.	Uncapped.	Uncapped.	Uncapped.	Uncapped.	Uncapped.	Uncapped.	Uncapped.	Uncapped.	Uncapped.	Uncapped.	Uncapped.	Uncapped.	Uncapped.	Uncapped.	Uncapped.	Uncapped.	33	2000 to 2300
4.72-inch Armstrong	4.46	Uncapped.	Capped.	Uncapped.	3.39	Uncapped.	Uncapped.	Uncapped.	Uncapped.	Uncapped.	Uncapped.	Uncapped.	Uncapped.	Uncapped.	Uncapped.	Uncapped.	Uncapped.	Uncapped.	Uncapped.	Uncapped.	Uncapped.	Uncapped.	45	2600
5-inch Model 1900	9.22	Uncapped.	Capped.	Uncapped.	7.46	Uncapped.	Uncapped.	Uncapped.	Uncapped.	Uncapped.	Uncapped.	Uncapped.	Uncapped.	Uncapped.	Uncapped.	Uncapped.	Uncapped.	Uncapped.	Uncapped.	Uncapped.	Uncapped.	Uncapped.	58	2600
6-inch Armstrong	7.25	Uncapped.	Capped.	Uncapped.	6.02	Uncapped.	Uncapped.	Uncapped.	Uncapped.	Uncapped.	Uncapped.	Uncapped.	Uncapped.	Uncapped.	Uncapped.	Uncapped.	Uncapped.	Uncapped.	Uncapped.	Uncapped.	Uncapped.	Uncapped.	106	2600
6-inch rifle, Model 1905.	11.11	Uncapped.	Capped.	Uncapped.	7.86	Uncapped.	Uncapped.	Uncapped.	Uncapped.	Uncapped.	Uncapped.	Uncapped.	Uncapped.	Uncapped.	Uncapped.	Uncapped.	Uncapped.	Uncapped.	Uncapped.	Uncapped.	Uncapped.	Uncapped.	106	2600
8-inch rifle, Model 1888	12.06	Uncapped.	Capped.	Uncapped.	10.9	Uncapped.	Uncapped.	Uncapped.	Uncapped.	Uncapped.	Uncapped.	Uncapped.	Uncapped.	Uncapped.	Uncapped.	Uncapped.	Uncapped.	Uncapped.	Uncapped.	Uncapped.	Uncapped.	Uncapped.	316	2200
Mt.	18.02	Uncapped.	Capped.	Uncapped.	14.5	Uncapped.	Uncapped.	Uncapped.	Uncapped.	Uncapped.	Uncapped.	Uncapped.	Uncapped.	Uncapped.	Uncapped.	Uncapped.	Uncapped.	Uncapped.	Uncapped.	Uncapped.	Uncapped.	Uncapped.	604	2250
10-inch rifle, Model 1900	21.94	Uncapped.	Capped.	Uncapped.	20.54	Uncapped.	Uncapped.	Uncapped.	Uncapped.	Uncapped.	Uncapped.	Uncapped.	Uncapped.	Uncapped.	Uncapped.	Uncapped.	Uncapped.	Uncapped.	Uncapped.	Uncapped.	Uncapped.	Uncapped.	1046	2250
10-inch mortar, 1890																							1046	560, 610 and 670, 743
12-inch rifle, 1900																							824	837, 910 and 1050
*12-inch mortar, C.I.																							1046	550, 600, 660, 725, 810, 915 and 1050
Mt.																							824	2150
*12-inch mortar, 1890.																							1046	2300
Mt.																							1046	2300
14-inch rifle, 1906	20.6	Uncapped.	Capped.	Uncapped.	19.5	Uncapped.	Uncapped.	Uncapped.	Uncapped.	Uncapped.	Uncapped.	Uncapped.	Uncapped.	Uncapped.	Uncapped.	Uncapped.	Uncapped.	Uncapped.	Uncapped.	Uncapped.	Uncapped.	Uncapped.	1046	2150
16-inch rifle, 1895																							2400	2300

* Deck steel.

On Armor-Piercing Shot, the whole head, including the soft-metal cap, and the center of gravity band, is painted blue gray. The charge color appears as stated above, if the projectile is a cored shot.

On Armor-Piercing or Deck-Piercing Shell, one-half of the head, measured from the point; and the center of gravity band, is painted blue gray. The charge color appears as stated above.

On Chilled-Iron Shot, one-half of the head, measured from the point; and the center of gravity band, is painted light green. The charge color appears as stated above, if the projectile is a cored shot.

On Cast-Iron Shot, the center of gravity band is painted olive green

On Torpedo Shell, the center of gravity band is painted blue gray. The charge color appears as stated above.

On Shrapnel, the entire body is painted black, with a band of vermilion on the head below the fuse to indicate a front charge, or on the cylindrical portion of the body in rear of the copper rotating band to indicate a base charge. Those used for fixed ammunition are painted all black above the copper band.

On cannister, the entire body is painted black.

Before the paint is applied the surfaces should be cleaned and all grease or oil removed. It should be applied by brush and rubbed on evenly, particularly on parts required to fit the bore closely. Care is necessary that the junction of two colors does not overlap to produce inequalities of thickness. The thickness of the coating generally must be limited to the least amount required to produce the color.

The cavities of cored shot, shell and shrapnel made to contain a bursting-charge of powder are coated with "Turpentine Asphaltum Varnish, best quality." The process consists of thoroughly cleaning the cavity of all greasy matter and pouring in the liquid, then rolling and turning the projectile to insure even distribution, and pouring out the excess. The projectile is then allowed to stand with the fuse hole down for a time sufficient to insure thorough draining of excess. The residue from fuse threads is removed by means of a cloth soaked in benzene and a tap. The fuse hole is left open for the circulation of air until after the coating has hardened.

The "body" of coating can be increased by a second coating after the first has dried, or by thickening the varnish, through evaporation, before applying.

Cored shot or shell which are charged with picric acid compounds are first coated on the interior with paraffin or rubberine paint No. 2, the process consisting of melting the wax and pouring it in as described.

The object of these coatings is to prevent the generation of the

sensitive qualities produced in some explosives when exposed to iron or steel, such qualities causing them to detonate from the slightest friction.

PRIMERS

(See Plate XIX)

Primers are devices used to ignite powder charges in guns. They are classed, according to the method by which the ignition is produced, into friction primers, electric primers, percussion primers and igniting primers. There is also a combination primer so constructed that it may be fired by either of the two methods named above. Primers known as obturating primers, in addition to affording a means of igniting a charge, also act as a gas check and prevent the escape of powder gases through the vent by closing it.

Friction Primers.—Primers of this class consist of those exploded by frictional heat; they are composed essentially of a body of brass or Tobin bronze; a friction pellet, composed of a mixture of sulphide of antimony; chlorate of potash; sulphur; ground glass; and usually a matrix, used to hold the other parts together, such as beeswax or tar; a toothed or serrated wire, to ignite the friction pellet by frictional heat when forced through it; and the priming charge of black powder. It is essential that there shall be no escape of gas, either through or around the primer body on discharge, especially in case of high-power guns, therefore most of the primers of this class, especially those used in seacoast cannon, are made obturating. The friction primers in use are the obturating friction primer for siege and seacoast cannon shown in Fig. 23. The primer illustrated in Fig. 23 was designed for use with old-model vents and are gradually being replaced in the service by the primers for the new-model vent shown in Fig. 29, which is commonly known as the button primer.

In addition to the friction primers above described, the primer shown in Fig. 24, known as the drill primer for new-model vents, has been designed to take the place of the relatively expensive combination electric-friction primer for use in drill, saluting and subcaliber practice. The method of operation of the friction primer consists in pulling the serrated end of the copper wire through the friction composition. The pull on the lanyard draws the serrated wire through the friction composition and ignites it; the flame communicates to the rifle powder and thence through the vent to the powder charge in the gun.

The lanyard should be pulled from a position as near to the rear of the gun as possible. A strong, steady pull from one man with as short

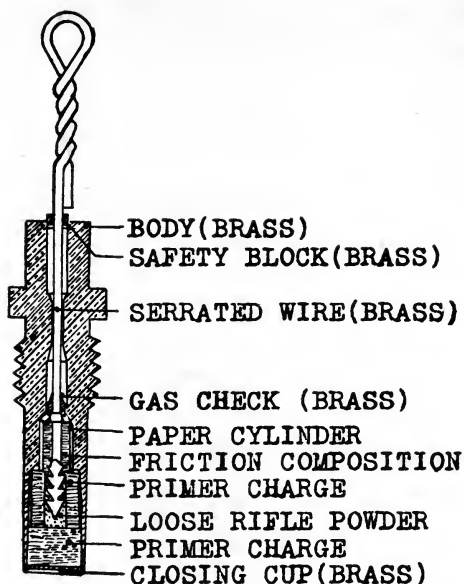

FIG. 23.

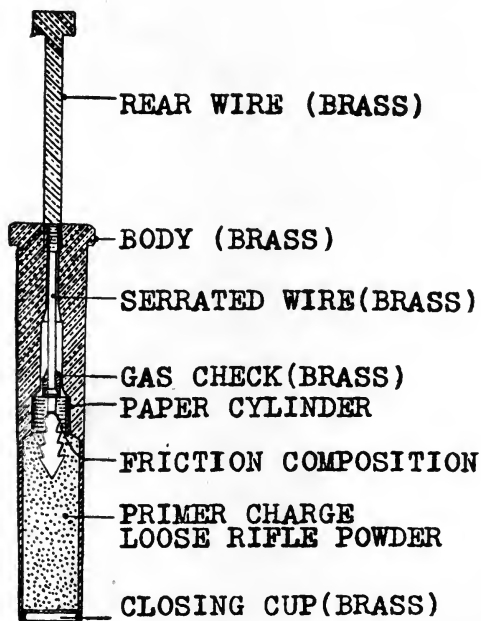

FIG. 24.

a lanyard as practicable should be used. Where a long lanyard is used, the slack causes the force to be applied slowly, increasing the chances for a misfire.

If a primer cannot be fired by one man, it should be rejected and another used. Two men pulling on a lanyard will injure the firing mechanism, in case one is used. When a primer is pulled and fails to fire it should be removed from the vent; the wire should immediately be bent around the primer through an angle of 180 degrees to prevent it from being used again.

The obturating friction primer for new-model vent shown in Fig. 25, was designed to increase the rapidity of fire of all guns, as it is more readily inserted in the gun and after use more easily taken out of the vent. In order to use a primer of this kind it became necessary to add

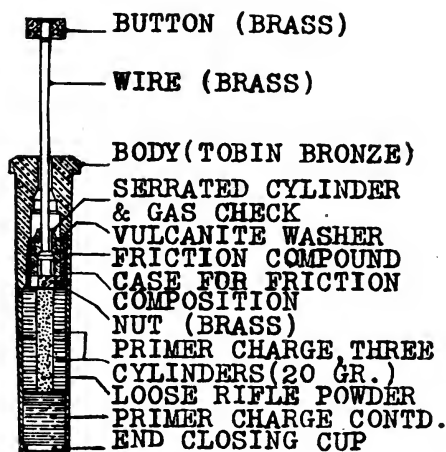

FIG. 25.

a new firing mechanism to the breechblocks of the guns in which it is used. The head of the primer is firmly held by the firing mechanism, so that the primer cannot be blown out at the discharge of the piece. The firing wire is engaged and pulled by a slotted lever actuated by the pull on the lanyard.

This primer consists of a brass body with a brass firing wire passing loosely through the hole in the serrated cylinder, the end of the wire being flush with the end of the cylinder when the nut on the wire bears against the interior shoulder. The friction composition, pressed into the brass case, surrounds the cylinder above the serrations. A vulcanite washer holds the friction composition in place and prevents it from crumbling when the pull is applied. The nut screwed to a bearing

on the case holds the assembled parts in place. Three holes through the nut permit the passage of the flame from the friction composition to the priming charge of powder.

The action of the primer is as follows: When the wire is pulled, ignition of the friction composition is effected. The conical end of the cylinder is pulled to its seat in the body of the primer, and prevents escape of gas to the rear.

One of the late improvements in this primer is its arrangement by which the wire may be moved forward without carrying the cylinder and the friction composition with it, and therefore without danger of firing the primer in case the wire is pushed back after a primer has been taken from a vent in case of a misfire. In the earlier models the teeth were formed on the wire, and it was found when a primer had failed to fire it might be fired accidentally in case the wire was pushed back.

Drill Primer.—This primer is shown in Fig. 24. It is constructed practically the same as the primer just described except that its parts are more cheaply made. It is the only primer issued unassembled. The button wire, body, serrated wire, cylinder of smokeless powder and friction composition are furnished separately. The rifle powder, closing caps and necessary assembling tools are furnished for assembling and disassembling the drill primers.

The serrated wire with the friction composition is first inserted in its seat in the body and the button wire screwed on the end. The body is then filled with 25 grains of loose rifle powder and the end closed with the brass cap. To prevent the displacement of the cap, the end of the primer is sealed with a composition furnished for that purpose.

Drill primer cases are intended to be reloaded as many times as possible, and for this purpose the drill primer kit consists of 30 primer cases, 30 button wires, friction pellets, closing caps, loading tools and a resizing die for priming cases. The drill primer costs approximately five cents, and with proper care a drill primer case will stand about ten firings before becoming unfit for further use. To preserve the cases they should be carefully cleansed with a hot solution of lye immediately after firing, and thoroughly dried before being put away. The resizing die is used for the purpose of readjusting the shape of the primer cases that have become swollen or bent out of shape.

Electric Primers.—Primers of this class consist of those exploded by an electric wire heated to incandescency. The service electric primer consists essentially of the primer body, the lead wire or wires, the platinum wire bridge, the gun cotton primer charge, the primer charge proper and the insulating parts. The essentials of an electric primer

are that it should be simple in construction, thoroughly free from short circuits, sure in its action when the proper current is applied, uniform as to the firing current, and so constructed that the obturation of the gas is complete through and around the primer body. The amount of current usually required to fire an electric primer is, under ordinary conditions, 75/100 of an ampere. The electric primer for axial and radial vents is shown in Fig. 26, and consists of the parts indicated thereon. It is the only two-wire electric primer found in the service. The circuit between the two wires is completed across the platinum

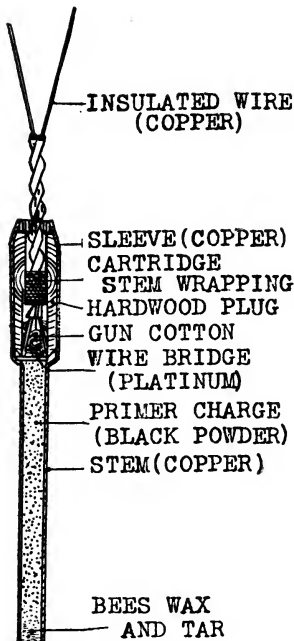

FIG. 26.

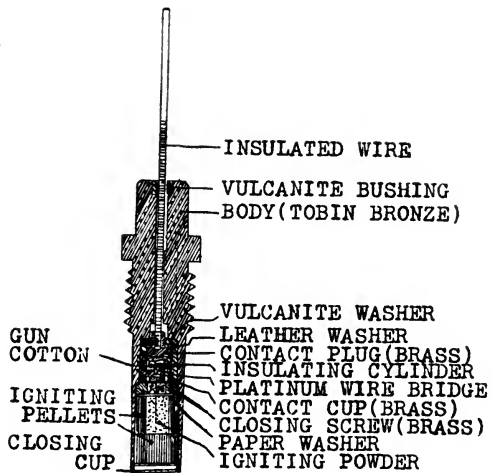

FIG. 27.

bridge and the electric current passing over the circuit heats the wire, igniting the gun cotton surrounding the bridge, which in turn ignites the primer charge.

The electric primer for siege and seacoast cannon with old model vents is shown in Fig. 27, and is used generally in the same cannon as the obturating friction primer shown in Fig. 23. The principal parts are indicated on the cut. The copper wire, insulated throughout its entire length in the primer body, is threaded to the brass contact plug. After these two parts are assembled, the metal of the contact plug is

crimped in around the wire to prevent accidental unscrewing. The vulcanite washer, the lead washer, and the insulating cylinder, insulate the contact plug from the primer body. The front end of the contact plug fits into the counterbore in the rear end of the vulcanite insulating cylinder. The front end of the vulcanite insulating cylinder is counter-bored to the contact cup, which is bored centrally to the hole leading to the primer cavity. The interior of the primer body is threaded as shown for the closing screw. Both the contact plug and the contact cup extend beyond the ends of the insulating cylinder, so that when the closing screw is set up tight all the interior parts referred to are held firmly together.

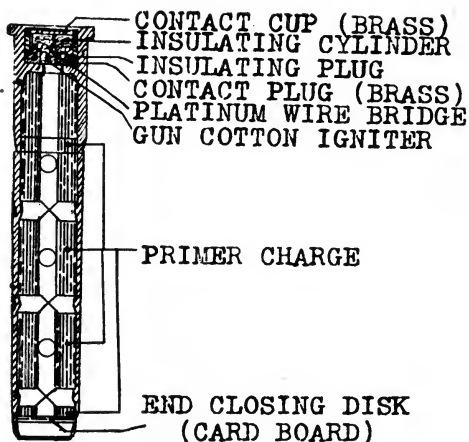

FIG. 28.

A platinum wire bridge of $\frac{2}{1000}$ of an inch in thickness is soldered to the front end of the contact plug to the contact cup. The electrical connection of the primer body is secured through the threads of the closing screw. The platinum wire bridge is surrounded with a small priming charge of dry gun cotton, so that when the bridge is heated by the passage of the electric current the gun cotton is ignited, which in turn ignites the pellets. These pellets are composed of 21 grains of compressed black powder. On the discharge, the pressure of the gas forces the contact plug against the washers and also forces the thin walls of the primer out against the primer seat, thus producing an effective gas check.

The 110-grain electric primer shown in Fig. 28 is designed for use in all guns employing metallic ammunition, and equipped with electric

firing attachments, such as the 3-inch R. F. gun, model of 1902, and all of the Armstrong seacoast guns in the service. The parts are indicated in detail in the cut. The electric element of the primer consists of a wire bridge soldered to the contact disk, which is then pressed to the bottom of the contact cup; the contact cup is then pressed into the insulating cylinder, in which it is made a snug fit; a small quantity of gun cotton is placed around the bridge, after which the insulating plug is assembled in the open end of the contact cup. The contact plug, which is centrally bored for the passage of the flame, and the platinum bridge is assembled with the boss or projection fitting into the end of the

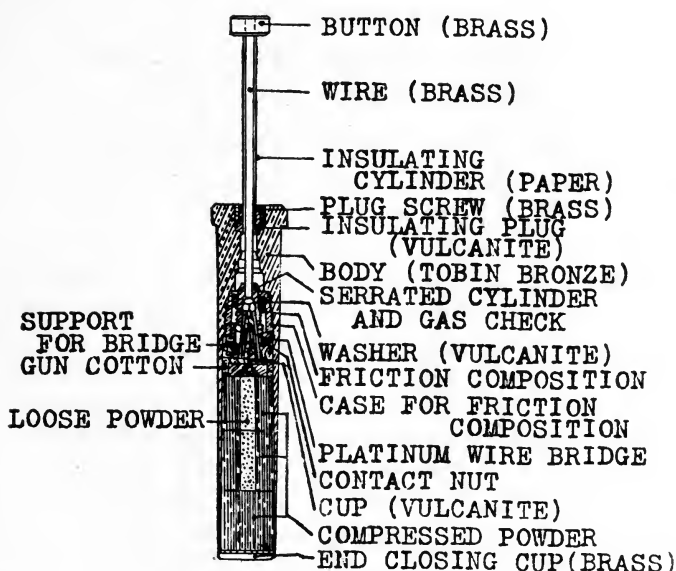

FIG. 29.

insulating plug, the bridge passing out through the central hole and being soldered into a groove in the surface of the contact plug.

The diaphragm separating the recess for the electric element from the black powder cavity is centrally bored to permit ready passage of the flame from the gun-cotton igniter when the primer is fired.

Combination Electric Friction Primer.—Primers of this class consist of those which can be exploded by either a frictional heat or by an electric wire heated to incandescency, or both. The primer shown in Fig. 29, known as the combination electric and friction primer (button primer) has been adopted for use in seacoast cannon provided with

new model vents and will eventually be used in all seacoast cannon except those provided with percussion firing ammunition. Its great advantage is that it is readily inserted and removed from its seat. It provides two methods of firing and permits greater rapidity of fire. Its essential parts are marked in detail in the figure.

The friction composition of this primer consists of the following ingredients: 50 parts by weight of chlorate of potash, 27 parts by weight of sulphide of antimony, 10 parts by weight of sulphur and 13 parts by weight of ground glass. No matrix is used with the composition, the ingredients being thoroughly incorporated and inserted as a finely pulverized powder into the case and pressed into a solid pellet which surrounds the cylindrical part of the serrated cylinder so that the teeth of the latter are not imbedded in the composition but rest on the compressed pellet.

The electric element consists of a paper cylinder which surrounds the wire insulating it from the firing mechanism, the insulating plug insulates it from the primer body. The friction composition pellet, which is a non-conductor of electricity, insulates the serrated cylinder, which is electrically connected with the wire from the walls of the primer body. The support for the platinum wire bridge, when the primer is assembled by screwing the closing screw into the front end of the case, presses tightly against the end of the wire, making the electrical connection at this point. The vulcanite cap insulates the prongs of the support from the closing screw. The platinum wire bridge is soldered to the support and to the closing screw. The case, into the front of which the screw is threaded, screws into the primer body as shown on the drawing. The electric circuit is thus completed between the button and body of the primer across the platinum bridge. The priming charge of gun cotton surrounds the bridge inside the prongs of the support.

The frictional element is operated by pulling the teeth of the serrated cylinder quickly through the pellet of friction composition which is ignited by frictional heat and fires the primer. The electrical element is operated by the passage of the electric current over the bridge, which ignites the gun cotton and in turn fires the primer.

Percussion Primers.—Primers of this class consist of those which can be exploded by a sharp blow or frictional shock. The essential parts of a simple percussion primer are the primer cup, the anvil and the percussion composition. With the exception of the tin-foil covering all metal parts of percussion primers are made of brass. Percussion primers are used in all guns provided with percussion-firing mechanism,

such as the 1-pounder pom-pom, the 1.65 Hotchkiss, the 6-pounder rapid-fire gun, the 4.7 and the 6-inch Armstrong gun, and the 3-inch 15-pounder r. f. gun. The ingredients of the friction composition consist of the following mixture: Chlorate of potash, sulphide of antimony, glass and sulphur. Formerly the composition of all service primers contained a large percentage of fulminate of mercury, but on account of the danger involved in handling these primers in shipment, its use has been discontinued.

To insure the ignition of smokeless powder charges in cartridge cases it is necessary that primers either contain in themselves, in addition to the percussion composition, an auxiliary charge of black powder, or that an auxiliary charge of loose black powder be placed at the rear of the cartridge case to communicate the flame from the percussion primer and thoroughly ignite the smokeless powder.

All percussion primers now used in the service, except the primer known as battery cup, shown in Fig. 30, contains an igniting charge of black powder in addition to the essential elements named above.

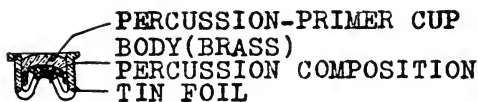

FIG. 30.

The amount of loose black powder required as an igniting charge for smokeless powder to give anywhere like uniform ignition is relatively large, with the result that considerable fouling of the gun occurs when the igniting charge is used. This is at all times objectionable, but is especially so with machine guns. This objection has resulted in the development of two sizes of percussion primers, one known as the 110-grain percussion primer, for use in all cartridge cases from the 1-pounder to the 6-inch Armstrong, and the other known as the 20-grain percussion primer, which is used in the smaller calibers of guns.

The 110-grain percussion primer, shown in Fig. 31, consists of the parts indicated in the cut. The body is $3\frac{1}{4}$ inches long, and is drawn from a disk of cartridge metal. In the rear of the body a recess or pocket for the percussion primer is formed. The percussion primer consists of a cup, a percussion composition and the anvil, is assembled and inserted as a unit into the pocket. A hole is drilled through the diaphragm separating the pocket from the cavity containing the compressed charge to allow passage of the flame from the percussion primer.

The primer charge consists of 110 grains of black powder inserted under a pressure of 36,000 lbs. per square inch. Eight radial holes are drilled through the primer and compressed powder. The powder is pressed into the primer body around a central wire, which is then withdrawn, leaving a longitudinal hole the full length of the primer.

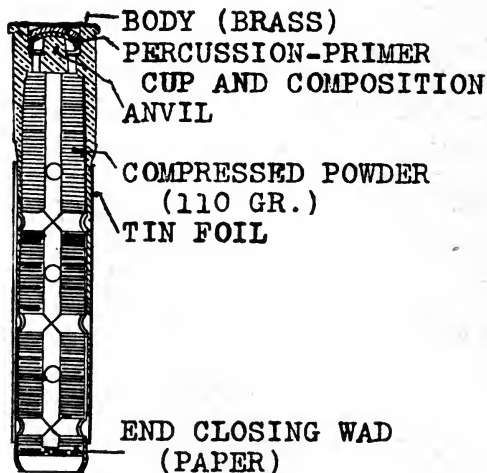

FIG. 31.

This compression of the powder with the longitudinal hole increases the time of burning of the powder charge, and causes the primer to burn with a torchlike rather than an explosive effect, making the ignition of the smokeless powder charge more complete. This primer has been

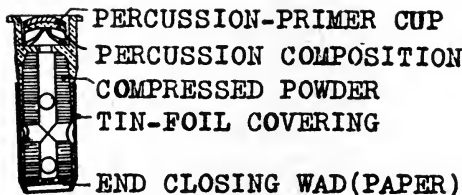
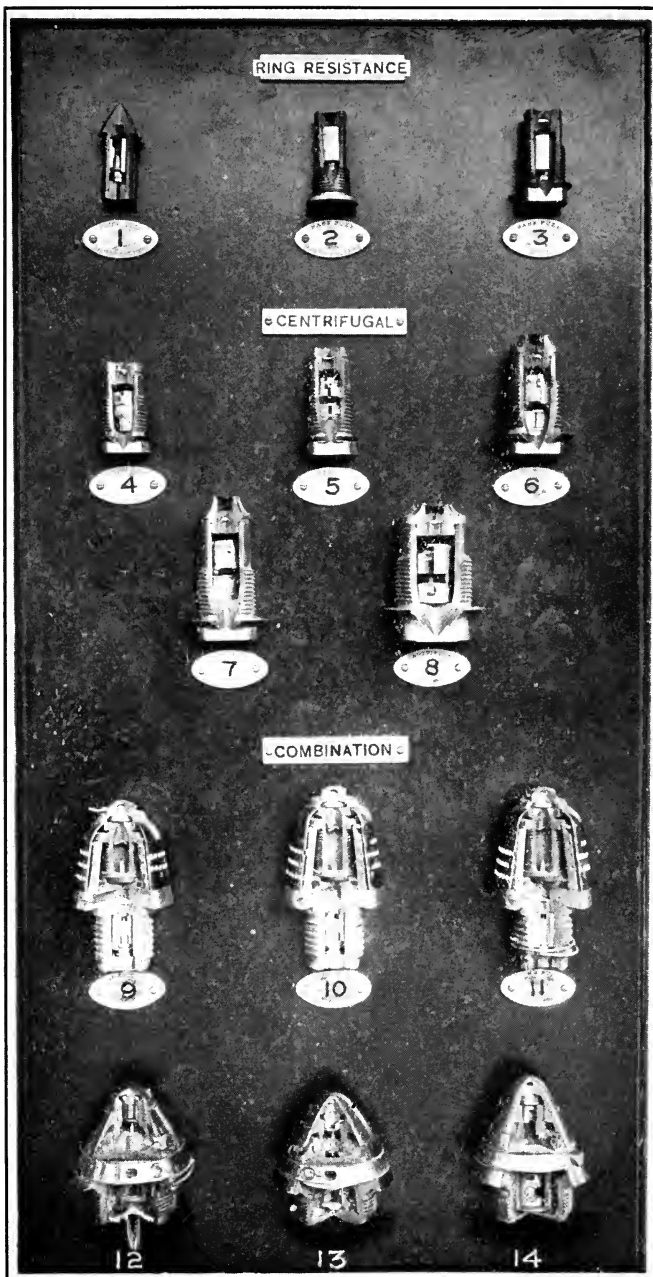

FIG. 32.

adopted for use in all cartridge cases from the 6-pounder to the 6-inch Armstrong inclusive, and requires no rear igniting charge.

The primer is a drive fit in its seat in all cartridge cases in which it is used, and for this reason a special press for the insertion of the primer is provided.

The 20-grain percussion primer shown in Fig. 32 has been adopted



Types of Fuses.

- | | |
|----------------------------------|---------------------------------------|
| 1. Point Fuse, Minor Caliber. | 8. Centrifugal 12 M Fuse. |
| 2. Base Fuse, Minor Caliber. | 9. 15-second F.A. Combination Fuse |
| 3. Base Fuse, C High. | 10. Combination Fuse 28-second High. |
| 4. Centrifugal F Fuse Altered C. | 11. Combination Fuse 28-second Low. |
| 5. Centrifugal F Fuse. | 12. Erhardt Combination Fuse. |
| 6. Centrifugal S Fuse Altered A. | 13. Krupp Combination Fuse. |
| 7. Centrifugal S Fuse. | 14. Combination Fuse, F.A. 21-second. |



LIBRARY
OF THE
UNIVERSITY
OF
CALIFORNIA

for use in cartridge cases for 1-pounder subcaliber tubes, percussion firing, 1-pounder machine guns, and the 1.65 Hotchkiss. Its construction is practically the same as that of the 110-grain percussion primer, the main difference being that the primer charge consists of

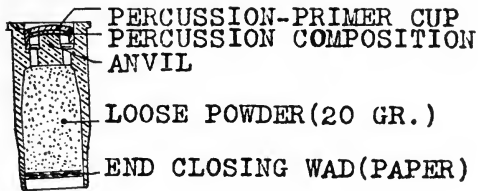

FIG. 33.

only 20 grains of compressed powder inserted under the same pressure as the larger primer.

For saluting purposes the percussion saluting primer, shown in Fig. 33, has been adopted. It is used in all saluting cases for guns designated as using 110-grain percussion primers.

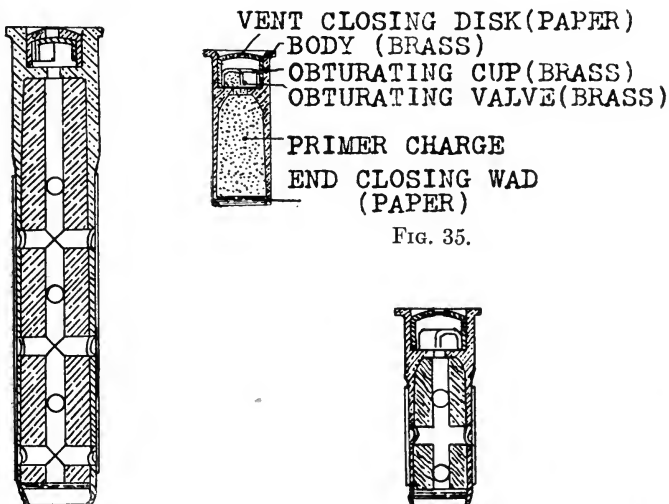

FIG. 35.

FIG. 34.

FIG. 36.

For use in the smaller guns the percussion primer battery cup, shown in Fig. 30, is used in all fixed ammunition.

Igniting Primers.—Primers of this class consist of those which contain no means of ignition within themselves, but require for their ignition an auxiliary friction or electric primer which is inserted in

the vent of the piece in the same manner as for service firing. Igniting primers consist essentially of a brass body, an obturating cup, an obturating valve, a vent-closing disk, an end-closing wad, and a 20-grain primer charge. They are assembled as shown in Figs. 34, 35, and 36. The saluting igniting primer, shown in Fig. 35, is designed for use in cartridge cases for 18-pounder subcaliber guns in firing blank charges of black powder.

The action of the primer is as follows: The flames and gases from the auxiliary primer cut through the vent in the cap and drive the obturating valve, which is normally in the rear of the cup, closing the vent forward, allowing the flames to pass around and enter the primer cavity through the vent in the diaphragm, and thus igniting the primer charge. The pressure of the gases at once react on the obturating valve and drive it to the rear, closing the vent in the obturating cup, at the same time expanding the walls of the cup in the recess, making a gas check at both these points.

The powder charge of this primer consists of 20 grains of loose rifle powder.

The flame from the service primer alone would not be sufficient to ignite properly the smokeless powder charge in the cartridge case, and therefore the igniting primer is used.

The 110-grain igniting primer is identical in form and dimensions with the 110-grain percussion primer, and is designed for use in cartridge cases for subcaliber practice with the 18-pounder subcaliber guns only. Its action is the same as that described for the saluting igniting primer. Its primer charge consists of 110 grains of rifle powder.

The 20-grain igniting primer, shown in Fig. 36, bears the same relation to the 20-grain percussion primer as the 110-grain igniting primer does to the 110-grain percussion primer. It is designed for use in cartridge cases for the 1-pounder subcaliber guns in subcaliber practice, and requires no igniting charge of black powder.

FUSES

(See Plate XX)

Fuses are devices used to ignite or detonate bursting charges contained in projectiles. They are classified: (1) According to their construction, as Ring-Resistance; Centrifugal; Combination; Detonating. (2) According to their use, as Time, Percussion, Combination Time and Percussion. (3) According to their location in the projectile, as Point or Base.

The essential elements common to all fuses of whatever class are safety in handling and transportation; certainty in action when fired; suitability for use in projectiles of different calibers; simplicity in construction; cheapness of manufacture; stability in storage and method of assembly.

Ring-Resistance Fuses are made both for base and point insertion, and consist essentially of a fuse stock or body, firing-pin sleeve, splitting spring, firing pin, percussion primer and fuse cap.

There are two classes of resistance fuses manufactured, the "high resistance" and the "low resistance," so called because the arming resistance of the ring is relatively high or low, that is, the resistance of the spring requires a greater or less shock to arm them. High-resistance fuses are safe under all ordinary conditions of handling and transportation, and may be transported fixed in the projectiles in which it is intended to use them. Low-resistance fuses cannot, on account of the danger of premature arming, be transported inserted in projectiles. They are shipped in hermetically sealed boxes, and, to prevent premature arming of the plunger in handling, the firing-pin sleeve and firing pin are locked together by means of a safety wire passing through them and the body of the fuse. Just before using, this wire must be pulled out, after which the fuse may be screwed into the projectile.

All the fuses of this class issued to the service at present belong to the high-resistance class, the only low-resistance fuses at present issued to the service being the 22-second combination fuse, low resistance, for use in a 7-inch mortar shot. All service fuses are stamped to show the distinguishing letter of designation and place of manufacture. The point fuses have a right-hand thread, which, in connection with the right-hand twist of rifling, has a tendency to tighten in its seat on discharge. For the same reason all base fuses have a left-hand thread.

The arming resistance of ring-resistance fuses is tested in the course of manufacture with a static machine, which gives the weight necessary to force the sleeve over the firing pin against the resistance of the splitting spring. They are also tested by assembling them in shell and dropping the shell upon a steel plate.

Ring-resistance fuses are also percussion in their character, that is, the shock of discharge prepares the fuse for action and the shock of impact causes the fuse to act. A type of ring-resistance point-percussion fuse for minor caliber guns is shown in Fig. 37 (before arming and after arming). The same type of fuse for base percussion is shown in Fig. 38.

The fuse itself is a small affair relatively, but its importance cannot

be overrated. All percussion fuses carry an interior mass called the plunger, whose forward movement, when the shell is retarded, causes the firing pin to strike a percussion primer and explode it. Before firing the fuse must be in a "safe" or "unarmed" condition, in which

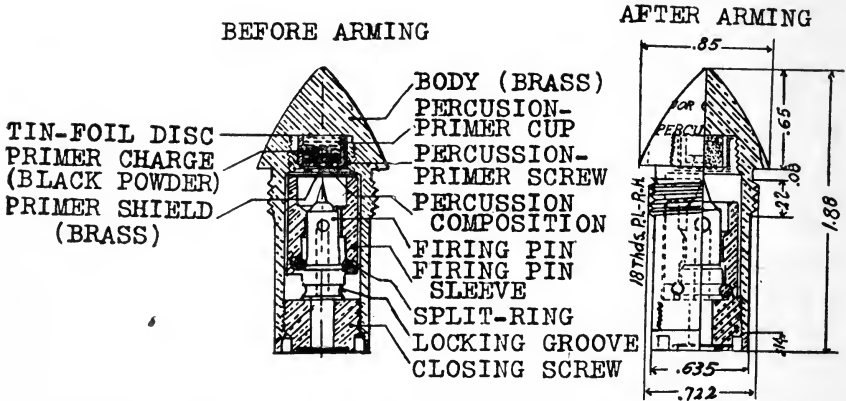

FIG. 37.—Ring Resistance Point Percussion Fuse. For minor calibers.

the pin cannot reach the primer, and during the flight of the projectile it must be in the "ready" or "armed" position. Either or both of the forces exerted on the plunger to give it the longitudinal and angular accelerations communicated to the projectile may be utilized to trans-

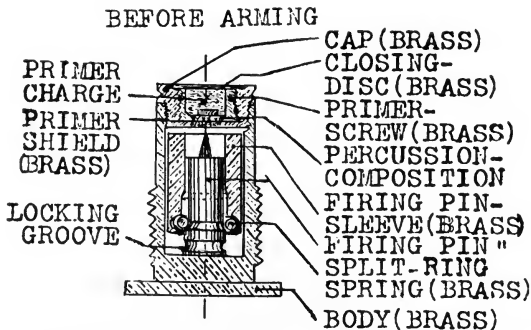

FIG. 38.—Ring Resistance Base Percussion Fuse. For minor calibers.

form the plunger from the "safe" to the "ready" position. The fuse is made principally of hard rolled brass. The body which forms a housing for the parts of the fuse is struck at the head with a radius corresponding to that of the shell in which used. Two slots are formed

in the head for a spanner wrench for insertion and removal of the fuses from the projectiles. The outside of the body is turned and threaded, and the interior, after being bored out for the plunger and primer parts, is threaded for the closing screw. The front end of the plunger cavity is bored out to form a recess for the primer, and is threaded with a left-hand thread in the interior for the primer screw. A hole in the top of the primer screw permits the firing pin to strike the primer on impact, and allows the flame to come from the primer in the rear and ignite the shell charge. The primer screw holds the primer cup in place, which is longer than the recess in the primer screw, so that when the latter is screwed down hard it bears upon the bottom of the primer recess.

The primer cup has two chambers separated by a solid vented partition; the lower chamber holds the percussion composition, which is held in place by the primer shield, which also restrains the firing pin during the flight of the projectile.

In unarmed or safe condition of the fuse, the split ring rests on a conical slope on the firing pin and sustains the firing pin on the sleeve. The resistance of this ring to the expansion necessary to force it over the slope is less than the force required to transmit the maximum acceleration of the projectile to the sleeve, thus insuring the arming of the fuse in the bore of the gun on discharge. The percussion composition of all service fuses consists usually of the following ingredients: Chlorate of potash, sulphide of antimony, sulphur, ground glass and shellac. The ingredients are mixed dry, alcohol being added to absorb the shellac.

The action of the fuse is as follows. When the piece is fired the sleeve moves to the rear, and is locked to the firing pin, the point of the firing pin projecting beyond the sleeve and thus arming the fuse. As the projectile meets the atmospheric retardation the plunger gradually creeps forward until stopped by the primer shield. When the projectile strikes, the firing pin pierces the shield and the thin layer of percussion composition, and ignites the primer charge. This is done by a small portion of the composition being caught between the point of the firing pin and the anvil.

The action of the base percussion fuse and the function of its parts are the same as those for the point percussion, the only essential difference being the position of the primer with reference to the shell charge. In the case of the point fuse the flame from the primer has to pass either through or around the plunger from front to rear, but in the case of the base fuse the flame does not have to cross any intervening space.

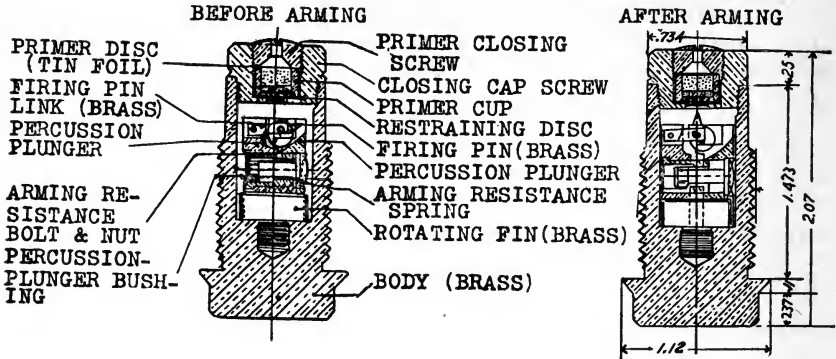

FIG. 39.—Centrifugal Base Fuse *F*.

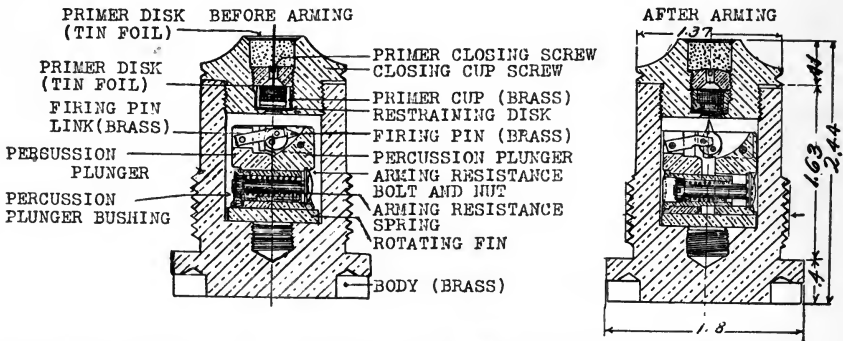

FIG. 40.—Centrifugal Base Percussion Fuse. Medium and major caliber.

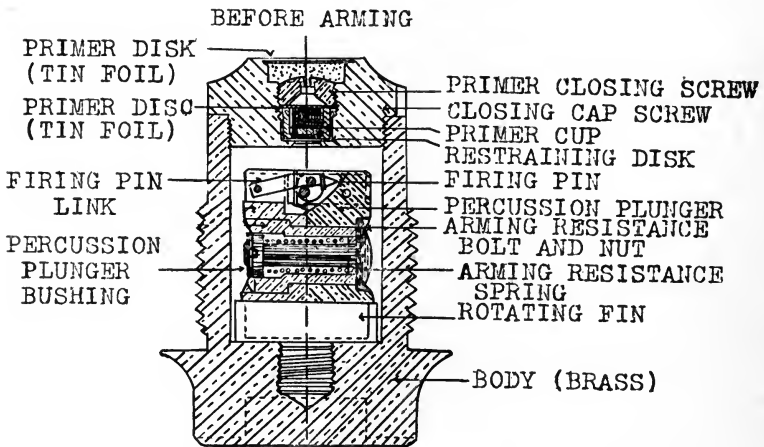

FIG. 41.—Centrifugal Base Fuse, 12M.

Centrifugal Fuses depend for their action on the centrifugal force developed by the rotation of the projectile. The increased rapidity of fire renders it necessary for all fuses to be transported fixed in projectiles, as too much time would be lost under war conditions if fuses had to be unpacked and inserted during an engagement. The requirement also that the projectiles fused shall be handled and transported with absolute safety is a reason which led to the development of the centrifugal fuse.

As has been stated in the case of ring resistance fuses, or any fuse the action of which depends upon the longitudinal stresses developed by the pressure of the powder gases of the gun on discharge, the conditions of safety of handling and certainty of action were imposing ones.

A centrifugal fuse is armed by the centrifugal force developed by the rotation of the projectile, and is safe until the maximum velocity of rotation is nearly attained. The three principal types of centrifugal fuses are shown in Figs. 39, 40 and 41. The fuse body or stock and the primer parts of the centrifugal fuse do not differ materially from the corresponding parts of ring-resistance fuses. The body of the centrifugal plunger is in three parts, nearly semi-cylindrical in shape, which when the fuse is at rest, are held together by the pressure of a spiral spring contained in the cylindrical bushing which is secured to one of the plunger halves. The spring exerts its pressure on the other half of the plunger through a bolt. Pivoted in a recess in one-half of the plunger is the firing pin, which, when the fuse is at rest, is held with its point below the front surface of the plunger by the lever action of the link which is pivoted in the other half. Under the action of centrifugal force developed by the rapid rotation of the projectile the two halves of the plunger separate. This separation causes the rotation of the firing pin, the point of which is then held in advance of the front surface of the plunger, ready, on impact of the projectile, to pierce the brass primer shield and ignite the percussion composition. When the fuse is armed the end of the link rests on the axis of the firing pin, thus affording support to the firing pin when it strikes the percussion primer. The separation of the plunger parts is limited by a nut coming to a bearing on a shoulder on the bushing, so as not to permit the diameter of the expanded plunger to equal the interior diameter of the fuse stock.

A rotation piece is screwed into the head of the fuse stock, and engages in a corresponding slot cut through the bottom of both plunger halves and insures the rotation of the plunger with the shell. The

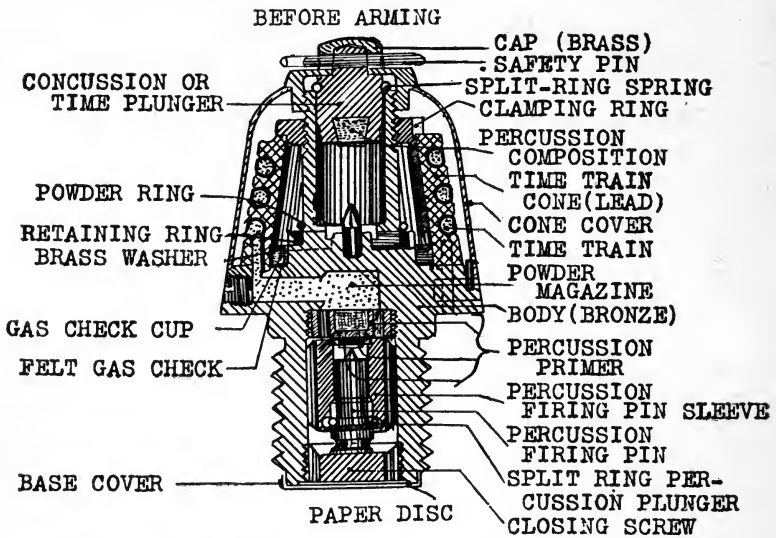

Fig. 42.—Combination Fuse, 15-second (Frankford Arsenal).

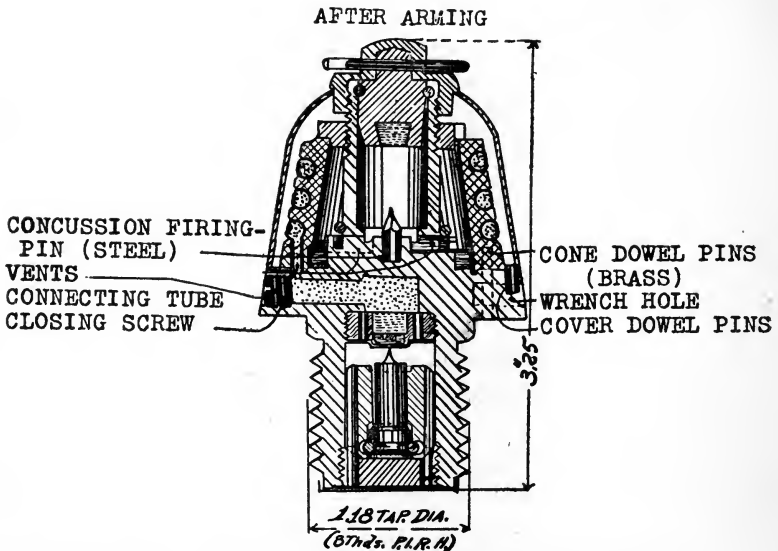

Fig. 43.—Combination Fuse, 15-second (Frankford Arsenal)

strength of the spring is so adjusted that the fuse will not arm until its rapidity of revolution is a certain percentage of that in the shell in which it is used, and that it will certainly arm when the rapidity of revolution approximates that expected in the shell. Should the parts of the plunger be accidentally separated and the fuse armed by a sudden jolt or jar in transportation or handling, the reaction of the spring will immediately bring the plunger to the unarmed position.

Centrifugal plungers are used as base percussion fuses in the small, medium, and large-caliber guns, howitzers and mortars, also as base-detonating fuses in the medium and large caliber as well as the percussion plunger in combination fuses.

The greater simplicity and cheapness of the ring-resistance fuse and its greater certainty of action make it more suitable for use whenever practicable.

Combination Fuses used in the service are point insertion and combine the elements of time and percussion arranged to act independently in one fuse body. Combination fuses contain two plungers and two primers, arming and firing by concussion and percussion, respectively. The concussion plunger arms and fires the percussion primer by shock of discharge in the bore of the gun and ignites the time element. The percussion plunger is armed by the shock of discharge and fires its primer on impact.

There are at present two general classes of combination fuses in the service, differing principally in the details of the time-train elements. In the first class this element consists of a wire-drawn lead tube filled with meal powder wound in a spiral groove around the lead core. In the second class this element consists of two superposed trains of meal powder compressed with heavy pressure in annular grooves in disks of brass.

The first class is shown in Figs. 42 and 43, the second class is represented in Figs. 44, 45 and 46. No more fuses of the first class are to be manufactured, those of the second class having been found far superior in many respects. The combination fuse of the first class cannot be reset, while those of the second class can be reset many times if desired. This fuse is also superior in that it has greater uniformity of action due to the improvement in the time-train feature. The fuses of class one have the time-train element composed of the concussion or time plunger, the firing pin, the cone, the time train, the cone cover, the cap and the clamping nut. The plunger is cylindrical in shape and contains the fulminate primer in a recess in its base. Its upper extremity is pierced to receive a safety pin which retains the

plunger in its safe or unarmed position in handling and transportation. When the safety pin is removed, which is done just before firing, the weight of the plunger rests on the split-ring spring. The action of the latter on discharge is similar to that of the split-ring spring of other ring-resistance fuses already described.

The cone is an alloy of soft metal held in place on the fuse body by a clamping nut and a groove at the bottom, and is prevented from turning by four steel dowel pins. The lip on the bottom of the cone, entering the groove in the body, acts as a gas check to prevent the ignition of the powder in the connecting tube. On the exterior of the cone is a left-handed groove which carries the time train, and this time train communicates at its lower end with the priming charge in the tube and thence with the magazine. The time train is formed of a lead tube filled with meal powder and is wire drawn.

The cone cover is of brass, and is held in place by a cap and prevented from turning by a small pin projecting from the body and fitting in a slot on its lower edge. On the exterior of the cone is a left-handed groove corresponding to that on the time train, and this groove is pierced with holes numbered from 1 to 15 or 1 to 21 or 1 to 28 as the case may be, these numbers corresponding to the number of seconds, the spaces between the holes being divided into 5 equal parts, or fifths of seconds. The percussion element may consist of either the ring-resistance plunger or the centrifugal plunger, depending upon the type of fuse considered.

The action of the fuse is as follows: As a time fuse: A hole is punched through the cover, time train and lead cone, at the point in the cover corresponding to the number of seconds desired. Before loading the safety pin is removed, and this allows the time plunger to rest on the fuse body, where it is held by the split-ring spring. The projectile is then inserted in the gun. By the shock of discharge the split-ring spring is expanded and the plunger forced to the rear, the primer striking the firing pin and exploding. The flame from the primer passes through the four radial holes and ignites the ring of compressed powder. The only vent for these gases is a punched hole, and they ignite the time train at that point. The train burns and ignites the powder in the tube and the magazine. The flame from the magazine passes through the percussion primer and percussion-plunger chamber and ignites the bursting charge in the shell.

As a percussion fuse: The percussion plunger arms by shock of discharge and fires the percussion primer on impact as in other percussion fuses. The percussion plunger is grooved or fluted to permit

ready passage of the flame from the front to the rear. In order to use this fuse in base charge shrapnel an extension piece is necessary, and is screwed in the base of the fuse in place of the bottom-closing screw. The ignition of the pellet of compressed powder in the extension piece transmits the flame through the central tube to the base charge.

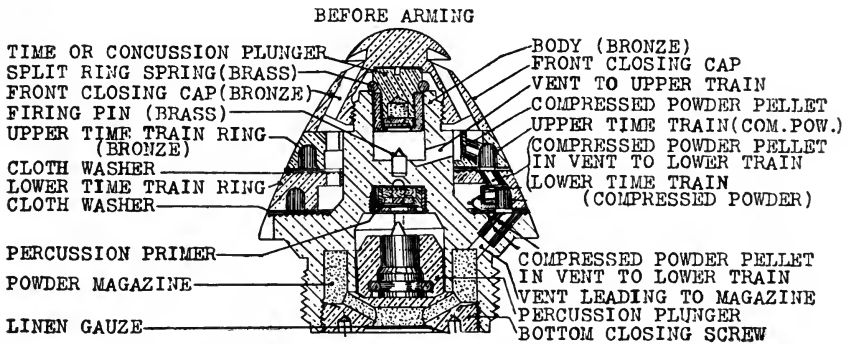

FIG. 44.—Combination Fuse, 21-second, Model of 1907.

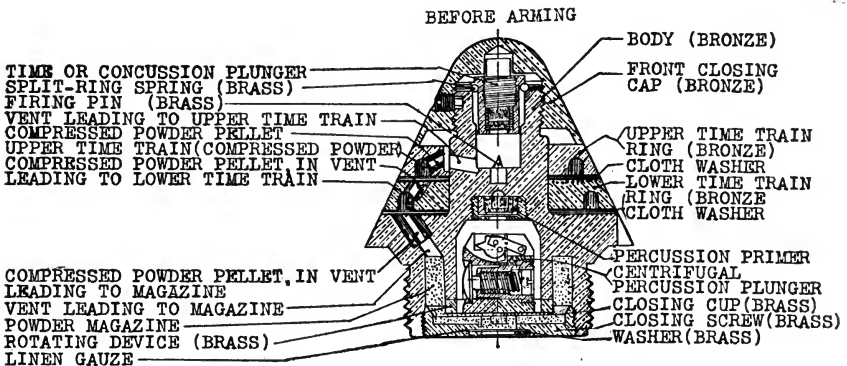

FIG. 45.—Combination Fuse (Centrifugal) 21-second (Frankford Arsenal).

The latest types of combination fuses are those shown in Figs. 44, 45 and 46, and belong to class two. The body of the fuse and the front closing cap are machined from bronze castings. The upper and lower time-train rings are turned from hard rolled rods of Tobin bronze. An annular groove in the shape of a horseshoe is milled in the lower face of each of the time-train rings. Meal powder is compressed in these grooves under a pressure of 70,000 pounds per square inch, forming a time train of necessary length.

The time element of this fuse consists of the following parts: The

time or concussion plunger, the split-ring spring, the firing pin, the vent leading to the upper time train, the compressed powder pellet, lower time train, the compressed powder pellet in the vent leading to the powder magazine.

The upper ring is prevented from rotating by pins which are halved into the fuse body and the inner circumference of the ring. A vent is drilled through the walls of the percussion chamber and is exactly opposite a hole in the inner surface of the upper time train leading to the end of the train from which the direction of burning is anti-clockwise. Another hole is drilled through the upper face of the lower

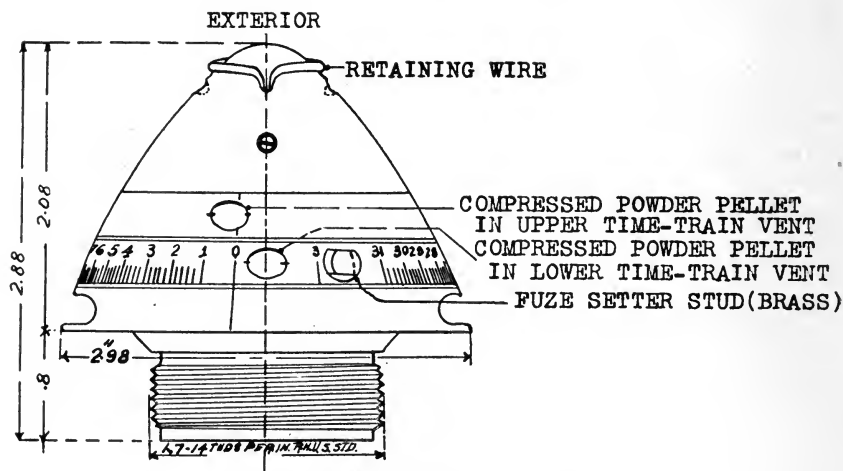

FIG. 46.—Combination Fuse, 21-second, Model of 1907.

time-train ring, to the end of the lower time-train groove from which the direction of burning is clockwise. The lower time-train ring is immovable and is graduated on its outer edge in a clockwise direction from 0 to 21, each full division corresponding to one second of time of burning in flight. These divisions are subdivided into five equal parts corresponding to one-fifth seconds. A fixed pin or stud is provided on the lower or graduated time-train ring, which enters a notch of the corrector ring or fuze setter when set in a fuse. An arrow on the lower side of the fuse stock is the datum line for the fuse settings.

A vent is drilled through the flange of the fuse stock to the powder magazine, and leads to the same end of the lower time train as the vent last described; that is, the end which the direction of burning is clockwise when the fuse is at its "O" setting.

The action of the time feature of the fuse is as follows: Assume first the zero setting as shown in Fig. 46. The time plunger arms and fires the primer which it carries as in the case of the first fuse described. The flame from the primer passes out through the vent drilled through the walls of the concussion plunger chamber and ignites the pellet at the end of the upper time train (see Fig. 44), down through the vent through the upper surface of the lower time train, to the end of the lower time train and thence through the vent to the magazine, the flame from which is transmitted to the base charge in the shrapnel.

It will be seen that for the zero setting of the fuse the origin of both the upper and lower time trains are in juxtaposition. For any other setting, say 12 seconds: The vent through the upper face of the lower time train changes its position with respect to the vent leading to the beginning of the upper time train and the vent leading to the powder magazine, both of which points are fixed by the angle subtended between the 0- and the 12-second settings. For this setting the flame passes out through the vent drilled through the walls of the concussion plunger chamber and burns on the upper time train in an anti-clockwise direction until the vent drilled through the upper surface of the lower time train is reached, where it passes down to the beginning of the lower time train and burns back in a clockwise direction to the position of the vent leading to the powder magazine, whence it is transmitted by the pellet of compressed powder.

If the fuse is set for 21 seconds, the vent through the upper face of the lower time train is opposite the end of the upper time train and the end of the lower time train is opposite the vent leading to the powder magazine. It will be seen that to reach the magazine and burst the shrapnel, the entire length of time train in both rings must be burned.

As the annular grooves in the lower face of each ring for the powder trains do not form complete circles, a solid portion being left between the ends of the grooves, the fuse can be set at the safety point quoted, which is indicated by the letter S, in which position the fuse cannot be exploded.

The fuse is provided with cloth washers glued to the upper surface of the time-train ring and to the upper face of the flange on the fuse stock, the function of these washers being to provide a gas check and prevent a premature action of the fuse. The percussion elements of the fuse consist of the percussion plunger and ordinary percussion primer. The fuse is also provided with a centrifugal percussion plunger

which will take up immediately the rotation of the projectile when a rotating device, which consists of jaws fitted over the corresponding flat surfaces on the plunger, is fastened to the fuse body.

Detonating Fuses are for use in shell containing high explosives. They are made for point and base insertion, the former being used in the field shell, the latter in siege and seacoast projectiles. The detonating fuse differs from the simple percussion fuse heretofore described in having in addition to the percussion elements a detonating element or one which will produce an explosion of high order when burst in a projectile containing a charge of high explosive.

DETONATING FUSES

Official Designation of Fuse.	Weight of Fuse, in Pounds.	Projectiles in which Used.
Minor caliber base detonating	0.195	In 6-pounder and 2.38-inch steel shell. Picric acid bursting charge.
Special "S" base fuse, with 100 grain detonator	0.65	In 3-inch r. f. gun, steel shell tapped in base for this fuse. To be superseded by medium caliber base detonating fuse.
Medium caliber base detonating fuse.	1.5	In all steel projectiles for guns from 2.95 to 7 inches (inclusive) in caliber.
Armor-piercing base detonating fuse (modified)	7.09	In 8-, 10-, and 12-inch rifle A.P. shot and shell adapted to the fuse. To be superseded by major caliber detonating fuse.
Major caliber base detonating fuse . .	2.908	In 8-, 10-, and 12-inch rifle and mortar steel projectiles.

To have sufficient energy to completely detonate a high explosive bursting charge in projectiles the detonating fuse must contain high explosive within itself. The service detonating fuse for seacoast projectiles contains two explosive compounds. The reason for this is as follows: All detonating fuses contain a percussion plunger either of the ring-resistance type or of the centrifugal type, depending upon the projectile in which used, and a percussion primer. This primer consists of the percussion composition and an igniting charge of black powder. The explosion of the primer is of low order and would not of itself detonate the high explosive charge contained in the fuse. To

accomplish this it is necessary to introduce between the percussion primer and the detonating charge an auxiliary high explosive sufficiently sensitive to be fired by the percussion primer and sufficiently powerful to detonate the high explosive charge proper contained in the fuse.

In order to contain these detonating elements it is necessary for the body of the fuse to be increased in length.

The table on the preceding page gives a list of the detonating fuses used in the steel projectiles containing a bursting charge of high explosives.

CHAPTER VII

INSTRUMENTS, DEVICES AND CHARTS

THE various instruments, devices and charts described in this chapter may be classified as follows:

Those used in the Observing Room for finding the position of targets, which include the depression position finders and the azimuth instrument.

Those used in the plotting room for locating and correcting the range and azimuth of targets, together with the necessary signal system incidental thereto, which include the plotting board, the range board, the deflection board, the wind component indicator, the aerescope, the time-interval bell, the time-interval clock, the interrupter, the telephone and telautograph.

Those used in the Meteorological Station for furnishing data to the plotting rooms in connection with the condition of the atmosphere and the direction and velocity of the wind, which include the thermometer, barometer, anemometer and atmosphere board.

Those used on guns and mortars for sighting and laying; also for determining the maximum powder pressure in the chamber, which include the various sights, the gunner's quadrant, and the crusher gauge.

The time-range board is used at the emplacement to provide information for keeping the piece laid continuously for range. The powder chart is, for convenience, placed herein.

Height of tide is received at the plotting rooms from the Tide Station, where the data is procured from a tide indicator, and sent out by means of the telephone or the aerescope.

DEPRESSION POSITION FINDER

Depression position finders are arranged for reading both vertical and horizontal angles, and therefore, may be used as either depression position finders, or as azimuth instruments. Objects, when viewed from an elevation, appear under different angles of depression, according to their distances from the point of observation, and it is this fact that

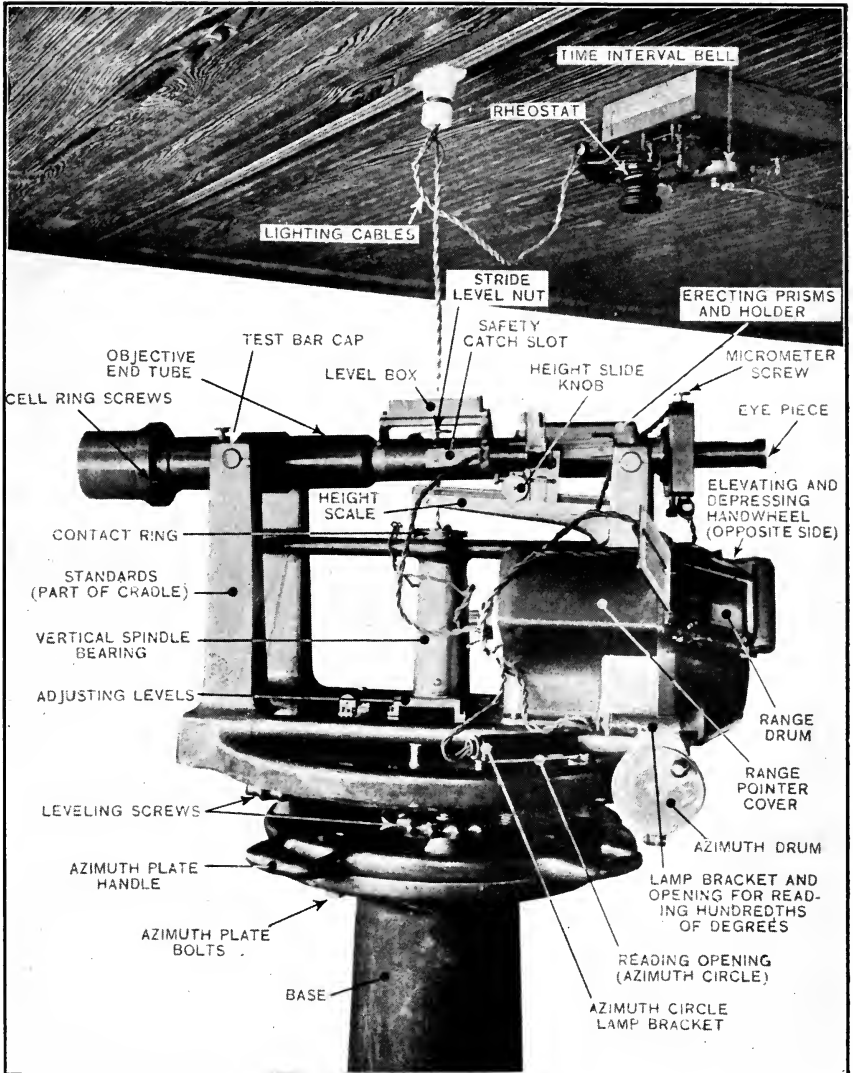

Warner & Swasey D. P. FINDER, Type A-1.



is taken advantage of in the depression position finder when used to measure vertical angles.

In principle, it is based upon the solution by observation of a vertical right angle when given a side and two adjacent angles. The given side, called the base, is the distance above mean low water of the pivot about which the telescope of the instrument is elevated and depressed. The lower angle is constant, and is equal to 90 degrees. The upper angle varies with the distance of the observed object.

The principal parts of the instrument are shown in Plate XXI, and consist of the telescope, the cradle, the height slide, the range drum shaft, the range pointer, the range-pointer bracket and the attachment for correction of the curvature of the earth and normal refraction, the range drum, the vertical spindle, the azimuth circle, the azimuth worm screw, the azimuth drum, the azimuth plate, leveling screws, base, cables, lamp and lamp brackets.

The principal parts of the telescope are the tube, trunnions, the cell ring, the cell, the objective, the prisms, the micrometer box, cross wires, micrometer screw, micrometer slide, the draw tube, the focusing nut and ring, the eyepiece adapter, the eyepiece, the right and left guides, the level and the dew cap. The telescope objective has a 3-inch clear aperture, and is provided with powers 12 and 20. The field of view is 1.85 degrees with both eyepieces. The range drum is graduated every 10 yards, from 1,500 to 12,000.

To Use the Instrument after it has been properly mounted, it should be first put in adjustment, and in doing this, it may be found convenient to take up the different steps in the following order: First, leveling. Second, adjustment of telescope. Third, orientation.

First: To level the instrument, it should be set up so that it is practically level with equal lengths of leveling screws exposed. The cradle can then be brought exactly level by using the leveling screws. The cradle is turned so that the telescope lies parallel with, or directly across two opposite leveling screws. This causes the levels to be parallel with opposite leveling screws. The bubble in each level is then brought to the center by turning both leveling screws either in or out, depending on the way the bubble is to go, a good rule being that the bubble follows the direction in which the left thumb is turned. After centering the bubble with one set of screws, do the same thing with the two other leveling screws, with which the other cross level is parallel. The instrument should then be revolved 180 degrees, and if the bubbles do not remain in the center of the levels, they should be brought there in the manner just described, except that half of the

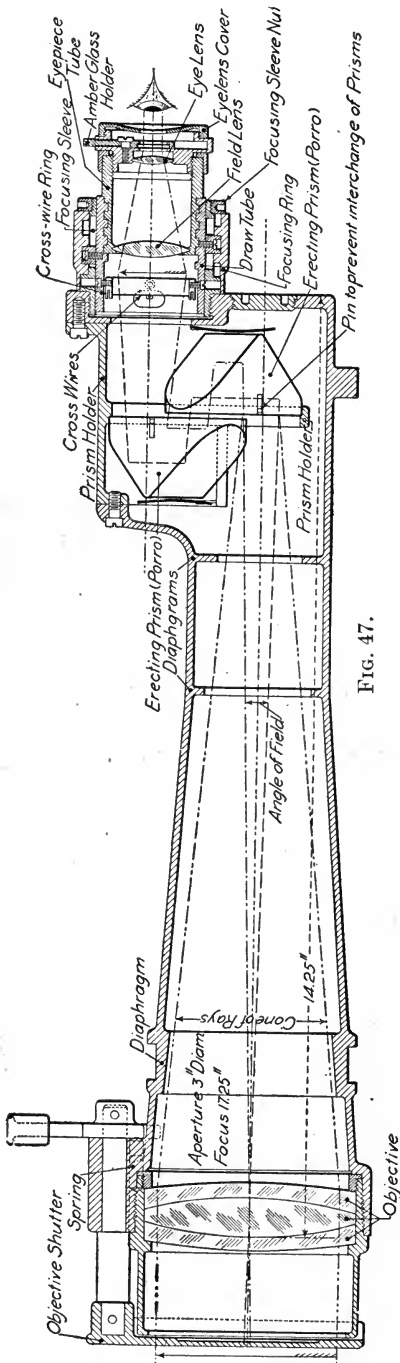

FIG. 47.

error in level should be corrected by the level-adjusting screws, and the other half with the leveling screws. The instrument is again revolved 180 degrees, and the operation repeated until the bubbles of the levels remain in the center of the levels for all positions of the cradle. If the range drum be rotated until the reading is "telescope level," the stride level on the telescope should show the telescope to be horizontal. If such is not the case, the drum should be rotated until this condition is obtained. The screws holding the range drum to the beveled gear loosened, the handle being firmly held, the drum should be rotated until the line corresponds with that on the pointer, then the screws should be set up again. The bubble of the level on the telescope should then remain stationary, while the height slide is moved to any position.

Second: Adjustment of the telescope. The telescope is a delicate piece of apparatus, and requires careful use and adjustment. Its interior mechanism is shown in Fig. 47. To obtain satisfactory results, the telescope should have absolute clearness of vision, which requires that the lenses be kept free from moisture, the erecting prisms should never be removed, nor the objective lens removed from the objective cell or ring. The

two principal and important adjustments of the telescope are the adjustment of the eyepiece, and the adjustment for collimation.

To adjust the eyepiece, the objective should be turned all the way in or all the way out, so that there is no object in the field. This causes a milky background for the cross wires. The eyepiece should then be removed, first to its outer limit for clearness of the cross wires, then to its inner limit. The observer should then try to set the eyepiece at a point midway between these two positions, which position should show the cross wires very distinctly, and with exact clearness.

The eyepiece, when once adjusted, should need no further attention unless the observer is changed. The eyepiece serves to give a distinct and magnified view of the image. Its magnifying power is large, and its focal range of distinct vision is very small, depending upon its magnifying power. With the ordinary field instruments, it is about $1/16$ inch. Both the image, as formed by the objective, and the cross wires, should lie in the focus of the eyepiece; that is, they should be in the same plane. The image is moved back and forth by moving the objective in or out, but the plane of the cross wires is fixed. If the two are brought into the same plane, it is necessary that the image be brought upon the cross wires. The adjustment just described accomplishes this very thing; it brings the focus of the eyepiece on the cross wires so they are most distinct. The objective may then be moved until the image or target also comes into focus. This focusing does not remain the same at all ranges, or for all observers, and must be done with each pointing, if the distances are materially changed. Should the image be not brought into exact coincidence with the cross wires, the cross wires will appear to move slightly on the image as the eye is moved behind the eyepiece. This movement or apparent displacement of the target is what is known as parallax, and can only exist when the cross wires do not lie in the focus of the eyepiece. It is removed by refocusing the objective, which moves the image until there is no perceptible movement of the wire or image as the eye is shifted. In other words, they are practically in coincidence. If the eye were always in the center of the eyepiece, there would be no parallax, and it is for this reason that the eyepiece is covered with a shield with a small hole in the center. Even with this small hole, a slight movement of the eye, if the telescope is not properly adjusted, will cause a perceptible angular error.

This adjustment may be summed up as follows: The eyepiece adjustment is a personal adjustment, and is made once for all for any given observer, but the objective adjustment depends upon the dis-

tances of the object from the instrument, and is made for each pointing; that is, it may have to be changed even for the same observer at different ranges. It may be considered as in perfect focus or adjustment when there is no parallax.

Usually the collimation of the telescope will be correct, but if necessary to adjust it for collimation, the telescope should be leveled, and the intersection of the cross wires brought on the target, some well-defined object being used, and the telescope then reversed. That is, the telescope is turned over, so that what was the original top of the vertical diameter is brought to the bottom. If the intersection of the cross wires is not then on the same part of the target, the dew cap and ring should be removed, and the cross wires brought on to the same line on the target by correcting one-half of the discrepancy by means of the radial screws in the object ring. This operation is repeated until the intersection of the cross wires remains on the target when the telescope is reversed. The telescope is then accurately collimated. The adjustment for parallax should be made before collimation is attempted, as an error in parallax will result in the adjustment for collimation being of no value, even after several attempts have been made by reversing the telescope.

Third: For the proper orientation of an instrument, it is essential that at least three datum points be provided. These datum points are designated D-1, D-2 and D-3, the first being the short-range datum point located between 2,000 and 2,500 yards, the second the midrange datum point located at about 5,000 yards, and the third the long-range datum point at about 9,000 yards. Datum points may be either lighthouses, buoys, tripods of piles, or of any design suitable in shape for clear vision at the ranges specified. If cylindrical in shape, they should be at least one foot in diameter for every 1,000 yards of range from the instrument, and sufficiently high to be readily distinguished at high water. Each datum point should have upon it a reference mark at a known height above mean low water; that is, above the fixed plane of reference of the range-finding instruments. These heights are usually from six to ten feet. The datum points are accurately located, and their azimuth and ranges from the various stations accurately determined, usually from their geodetic position.

Before attempting to orient the instrument, the range drum should be rotated until the reading "telescope level" is opposite the pointer. The stride level on the telescope should then show the telescope to be horizontal. If this is not the case, the drum should be rotated until

that condition is obtained, the screws attaching the range drum to the beveled gear should be loosened, and while the handle is firmly held, the drum should be rotated until the line corresponds with that on the pointer, and the screws should then be set up. The telescope should then be horizontal, and the reading on the range drum should be "telescope level." The instrument should be set for the correct height above mean low water by the height scale. Now direct the telescope on datum point No. 3, the range drum having been set at the range for same, and water-line by means of the micrometer screw. Then direct the instrument on datum point No. 1, or the short range datum point, the range pointer having been set at the range of datum No. 1, and water-line by means of the height slide pinion. Repeat this operation until correct readings are obtained, by water-lining by means of the range crank. Then set the instrument for the range and azimuth of the midrange datum point, the difference between the range reading and the true range as given in the datum chart, should be less than the danger space of the gun considered at that range. If it is correct, no further adjustment should be made. If this difference be appreciably greater than the danger space at the midrange datum point, then datum point No. 2 should be substituted for either No. 1 or No. 3, and the set of adjustments as just described made. Should the vertical wire not be exactly on the datum point when set at the correct azimuth, it should be brought there by turning the azimuth zero set screws. This adjustment, when once made, should be repeated at longer or shorter intervals, depending on the extent of the variation of the tide, and whenever atmospheric conditions have appeared to change considerably.

The adjustment for abnormal refraction should always be made at the long-range datum point, as refraction is greatest at this point. The adjustment for tide can best be made at the short-range datum point. The refraction surface is assumed to be an inverted cone, with its apex at the foot of the vertical base. If the condition of refraction is uniform through the whole 360 degrees, the axis of this cone will be vertical; otherwise, it will be inclined. When the field of fire is for the same water area, it is probable that it will be sufficiently accurate to consider this axis vertical, and but one set of datum points will be required.

Use and Care of the Instrument.—When the observer is about to begin work, his first duty is to verify the level of the instrument. He then adjusts the eyepiece, and focuses the telescope according to the principles laid down. The instrument should then be sighted upon the datum points in the order given, and the orientation verified.

The instrument in itself embodies an automatic means of correcting for the curvature of the earth, and normal refraction, which is ordinarily taken as one-seventh of that of curvature. When the range crank is rotated, it causes the rotation of the range-drum shaft by means of a beveled gear. This rotates the range drum which is secured to the gear, causes rotation of the lower arm of the lever about the lever pivots by means of the worm on the shaft, and the worm segment on the arm, and causes movement of the range pointer by means of the worm on the shaft, and the segment on the pointer arm. The rotation of the lower arm of the lever causes a corresponding movement in the forward arm, which elevates or depresses the telescope by rotating it about its trunnions. The rotation of the pointer arm about its bearings in the pointer bracket is, at its upper end, communicated to the pointer, the direction of the movement being governed by the guides. If large azimuth movements are desired, the worm box crank should be turned to the rear, which releases the cradle so that it will freely revolve on the spindle. When the general direction has been obtained, the worm should be thrown into mesh, and the movement controlled by the azimuth drum, which rotates the worm and revolves the cradle about the spindle and azimuth circle. If desired, a small movement can be obtained by loosening the four azimuth plate bolts and moving the table and all above it, with reference to the base. One of the chief sources of error in tracking is due to the attempt of the observer to follow in azimuth and range at the same time. It has been found that the best results are obtained as follows:

When Using the Vertical Base.—The vessel should be followed in azimuth without attempting to water-line accurately. Keep the horizontal hair a little below the water-line until the first stroke of the time-interval bell, when the target should be accurately water-lined by bi-secting the bow-wave, and kept accurately water-lined until the last stroke of the bell, at the same time maintaining the vertical hair as near as possible on the designated point of the ship. Stop the instrument promptly at the last stroke of the bell to enable the reader to read the range and azimuth as given on the instrument. If the vessel is moving directly away from the observer, water-line on the stern. If the bow-wave, or bone, cannot be seen, water-line on the side of the vessel, endeavoring to take a mean of the wave lines which are made by the vessel going through the water. It is not necessary to water-line at the middle point of the horizontal hair.

It must be remembered in using this system, that while it is important to make accurate azimuth observations, it is far more important to

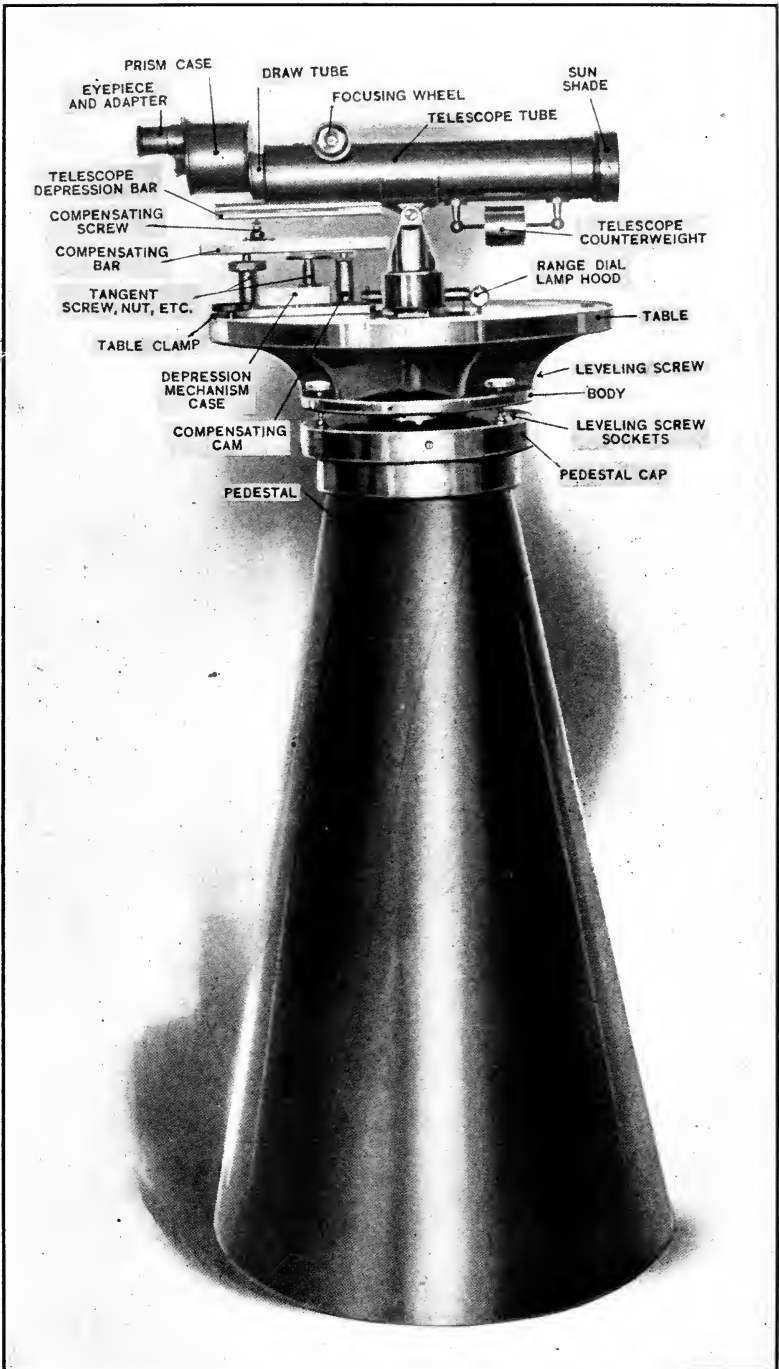

Depression Position Finder, Lewis Type.



LIBRARY
OF THE
UNIVERSITY
OF
CALIFORNIA

water-line accurately, for in the vertical-base system, it depends upon the accuracy used in determining the range. Small errors in azimuth are less liable to occur than large errors in range due to faulty water-lining. In attempting to water-line the side of the vessel, the cross hair is often lost in consequence of the character of the background. The observer, in order to obtain a good background, unconsciously water-lines short; that is, he will see a little water between the hair and the side of the ship. The water passing along the side of the vessel forms a succession of waves, and the observer is liable to water-line over or under, according as his eye catches the crest or the bottom of a trough. It is therefore much better to water-line the bone whenever it can be done.

When Using the Horizontal-Base System.—The vessel should be followed in azimuth, keeping the vertical hair approximately on the designated point until the first stroke of the time interval bell, the horizontal hair being at the same time kept a little below the vessel. Then bring the vertical hair accurately to the designated point, the central line of a funnel or mast, and keep it there until the last stroke of the bell, and then stop the instrument promptly. Observations should be made on the forward military mast whenever the vessel followed has one and it can be seen. In other cases, the observations should be made on the forward funnel unless the range officer designates some other point. It is not well to use the bow of vessels as points of observation, as they are not usually clearly defined, and in the horizontal-base system, the bow may not always be visible from both stations.

Too much stress cannot be put upon accuracy in observations, both in time and azimuth, when using the horizontal-base system, because upon this accuracy depends the accuracy of range. To avoid error, both instruments must be stopped instantly at the last stroke of the bell.

The maximum distance at which the depression position finder can be expected to give sufficiently accurate ranges may be taken as a distance equal to 1,000 yards for every 10 feet of height of the instrument above mean low water. Up to this distance, the maximum allowable error is one-half of one per cent. of the range, and observers should be trained until they can accurately and quickly determine ranges within the allowable error.

Care and Preservation of the Instrument.—Position finders, particularly the telescope, are delicate instruments, and should not be subjected to rough usage, jars or strains. When not in use, the telescope should be covered, protected from dust and moisture. To obtain

satisfactory vision, the glasses should be kept perfectly clean and dry. A piece of chamois skin or a clean linen handkerchief will always answer for cleaning purposes, care being taken that the cleaning cloth does not contain any dirt or grit. The lenses will seldom require cleaning on the inside, but when necessary, they should be unscrewed, and cleaned by a competent person only. The objective glass, erecting prisms, should not be moved from the objective cell and ring and the prism holder, except by an optician, and if they need repair they should be reported to the proper authorities. The cross wires should not be touched. Any dirt should be removed by blowing. The instrument should be regularly oiled at all the marked oil holes and bearings with a high-grade clock oil.

LEWIS DEPRESSION POSITION FINDER, MODEL OF 1907

(Plate XXII)

These instruments are designed to measure ranges and horizontal angles of objects from stations overlooking the sea. Ranges are automatically indicated by a pointer and dial when the telescope is depressed so that the horizontal cross wire coincides with the water-line of the object. Horizontal angles are automatically indicated by dials when the vertical cross wire of the telescope coincides with the object

Ranges are measured in yards, the dials being marked for each 10 yards between the minimum and maximum ranges. Horizontal angles are measured to one hundredths of a degree.

The principal parts are the telescope, the compensator and depression mechanism in the case, the azimuth dials, the 1/100 degree scale, the table, body, pedestal cap and pedestal. The telescope has an achromatic objective with a clear aperture of 3 inches and focus of 25 inches, which affords well-defined flat fields of view of 3 and 2 degrees when the 15- and 25-power eyepieces, respectively, are used.

The range-measuring feature consists in measuring the tangents of angles of depression of the telescope when directed at the water-line of an object on the sea. The range dial is spiral in form and a traversing pointer indicates the range mark to be read for any position of the telescope. The graduations on the range dial are exact for one height of the instrument, due allowance being made for curvature of the water surface and normal atmospheric refraction. This height is designated the initial height and it is usually that height on the height scale which locates the point of the compensating screw in the sliding

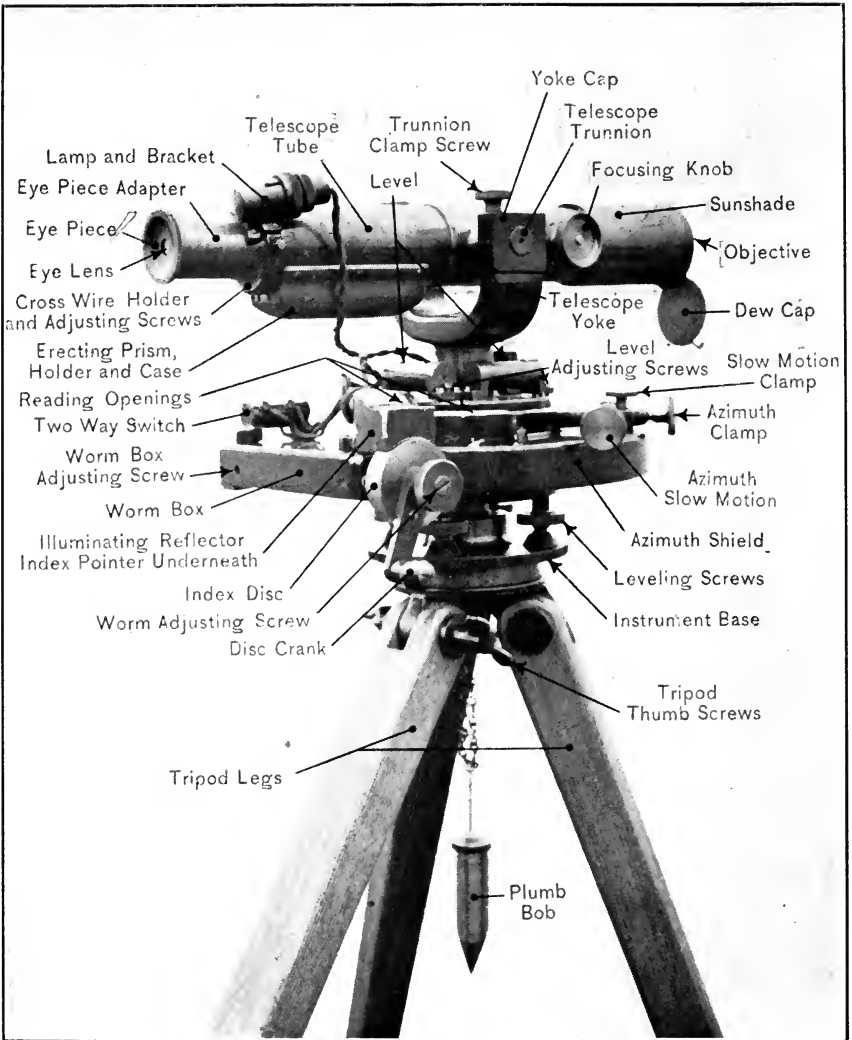

W. & S. Azimuth Instrument.



LIBRARY
OF THE
UNIVERSITY
OF
CALIFORNIA

block at a distance of 7 inches from the axis about which the telescope rotates, measured horizontally along the tangent-screw rail.

When the slide block is set for this initial height the range dial gives exact range readings for all ranges, but when set for greater or less heights only the minimum and maximum ranges will be correctly indicated. All intermediate ranges will be in error to a varying extent. By means of the compensator, automatic compensation is made for these errors, which are caused by the varying effects of curvature of the surface of the sea and atmospheric refraction when the instrument is used at any other than the initial height above sea level. These instruments are made for heights from 25 to 690 feet, they have interchangeable depression mechanisms, height scales and range dials.

Before using the instrument the following adjustments are necessary:

1. To Adjust the Azimuth Mechanism.—When moved or shipped the azimuth mechanism is put out of mesh, so it is first necessary to make this adjustment. On a radial line through the center of the azimuth dials are four screw heads. Counting from the center of the instrument out, the first and fourth are clamping screws, the second is the cover screw, covering the center of the unit-degree dial, which can be removed. The third is the shaft of the cam which moves the unit-degree dial into and out of mesh with a gear on the body of the instrument, inside the table. To adjust, loosen the two clamping screws very slightly, then turn the table until the index mark nearest the center of the instrument registers with any one of the hundreds and tens of degree marks. Next insert a screwdriver in the slot in the center of the unit-degree dial and turn it until zero (0) on this dial registers with zero (0) on the fixed scale. While in this position insert the screwdriver in the slot in the cam and gently turn the same until the unit-degree dial gear meshes with the gear in the body, and clamp in this position. If this adjustment has been properly made the azimuth mechanism will show about one-hundredth of a degree of back lash, when the direction of rotation of the table is reversed, and the table should turn nearly as easily as it did before the gears were meshed. If the turning of the table is very much harder than before, the adjustment should be repeated.

2. To Level.—Follow instructions previously given for leveling.

3. To Orient.—Select some datum point and turn the table by means of the azimuth handwheel until the azimuth of the datum point is indicated on the azimuth dials. Clamp the table to the body of the instrument and insert the large pin wrench in the hole in the side of

the pedestal cap and turn the cap until the vertical cross wire of the telescope coincides with the reference mark on the datum point. The level of the instrument should again be checked and leveled if necessary. The pedestal cap is clamped to the pedestal as soon as the adjustment is secured.

4. To Adjust the Telescope.—The telescope adjustments are given in detail for the W. and S. instruments on page 306, and are not materially different for this instrument.

To Use the Instrument. 1. Set the slide block to the proper height of instrument after deducting the height of tide and clamp same by means of the clamping screw.

2. Next bring the telescope to bear on a datum point about 8,000 yards and turn the operating nut until the range pointer indicates the correct range of the datum point. The horizontal wire will generally be found slightly above or below the water line at the datum point. It is therefore necessary to bring the horizontal wire into coincidence by unclamping the clamp screw on the compensating screw and screwing the latter up or down until the datum point is waterlined. The compensating screw is then clamped to the shaft of the rack gear. Under conditions of normal refraction the instrument is now ready for use. In practice, however, it will be found that when the telescope is directed on a nearer datum point, for example the short range datum (2,500 yards), when the refraction is more than normal, the range will be less than 2,500 yards when the datum point is water-lined. So in order to correct for this abnormal refraction the adjustment must be made on two datum points (3,000 and 8,000 yards) concurrently, until a position of the sliding block is found, which will give correct range indications for the two datum points. Other ranges will be slightly in error, but near enough for all practical purposes.

The rules for adjustment, use and care given above for depression position finders are applicable to a great extent to the azimuth instrument and surveyors transit, the nomenclature of which instruments will be found in Plates XXIII and XXIV.

THE PLOTTING BOARD

The principle upon which all plotting boards are based is the same, and their value lies in the fact that they quickly give by mechanical means the rate of travel of the target, the range and azimuth from the target to the directing point of the battery; as well as the necessary data for use on the Range and Deflection Boards.

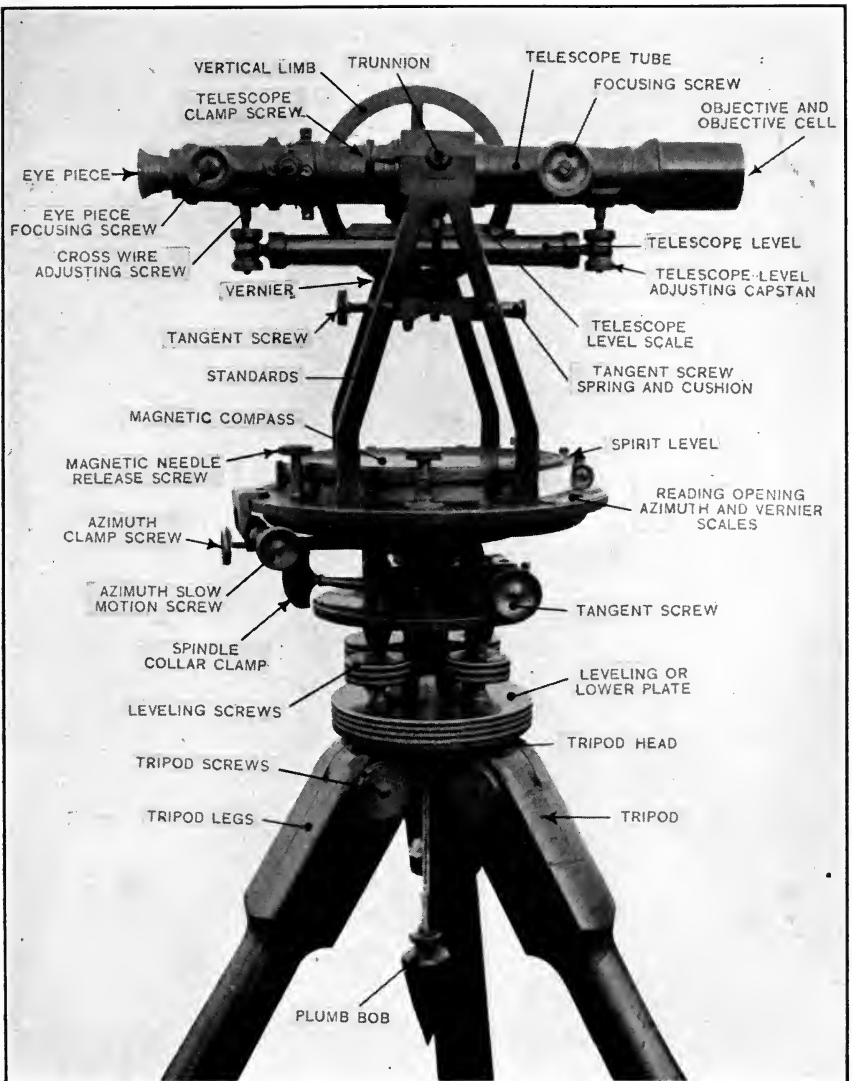

Engineer's Transit, Gurley Model.



LIBRARY
OF THE
UNIVERSITY
OF
CALIFORNIA

The plotting boards used in the coast artillery service are:

Whistler-Hearn Plotting Board, Model of 1904.

Mortar Plotting Board, Model of 1906 Mr.

Submarine Plotting Board, Model of 1906.

Fire Commander's Plotting Board.

The Whistler-Hearn Plotting Board is designated for use with a horizontal base of lengths from 900 to 7,000 yards. The board can be used as a right- or left-hand board. When used as a right-hand board the secondary station is on the right of the primary station (where the board is located), the front being toward the principal field of fire. When used as a left-hand board the secondary station is on the left of the primary station.

The plotting board proper, Plate XXV, consists of a semicircular *table* of well-seasoned lumber approximately two inches thick. The radius of the board is approximately 45 inches and is so made as to allow for expansion and contraction and to prevent warping. The diameter plate is a heavy piece of brass 7 inches wide and $\frac{1}{4}$ -inch thick and is attached to the under side of the board by bolts which pass through slotted holes to allow for expansion and contraction of the board.

The *base-line arm* is made of bronze and extends the whole diameter of the board on its upper surface, and when set at zero it is parallel to the diameter plate. The main *azimuth circle* extends around the curved surface of the table and is greater than a semicircle; it is made of bronze in several pieces and is put together in two layers, the pieces of the upper layer breaking joints with the lower portion, thus forming a complete metallic strip. The middle of the top portion of the circle is counter-sunk to admit the insertion of a piece of zinc upon which the degrees are numbered. The outer edge is notched with V-shaped notches about $\frac{1}{3}$ of an inch deep, each notch corresponding to one degree in azimuth. The entire azimuth circle is bolted at its two extremities to the diameter plate; all measurements therefore made on the board, whether angular or linear, are independent of the table proper, the expansion or contraction of the wood does not in any way effect the accuracy of the board.

The station blocks are mounted on the base-line arm. One block, known as the *primary block*, is attached to the base-line arm and fits over the main pintle center; the other block, known as the *secondary block*, is attached to the base-line arm, but is arranged so that it will move laterally along the base-line arm and may be set for any length of base line on either side of the main center or primary (station) block. Each block is provided with a pivot or center over which the primary arm, secondary arm and auxiliary arm are pivoted.

The *primary arm* is a scale arm or alidade which is pivoted at the main center, carried by the primary block. This arm is made of brass, steel or copper, and is graduated on one edge to the scale of 300 yards to the inch, the graduations representing yards in range, the smallest reading being 10 yards. The *secondary arm* is a similar scale arm and is pivoted at the center on the secondary block; it is likewise graduated for range to the scale of 300 yards to the inch, the smallest reading being 10 yards.

The *auxiliary arm* is a similar arm but without graduations, and is pivoted at the main center or at the same point on the primary block as the primary arm.

The *connecting bar* or *coupler* is a brass piece connecting the outer ends of the secondary and auxiliary arms; its length depends upon the length of the base line for the board considered, that is, the coupler would be equal to the length of the base line in inches at the scale of the board. The primary and auxiliary arms are fitted with an *index box* which slides and may be locked on the azimuth circle. The index box consists of the box proper which moves on the azimuth circle and is fitted with a lock called the *degree lock* by means of which the box may be located and locked at any particular degree. The scale arms pass through the boxes and by means of a rack and pinion may be moved in either direction through an arc of .99 of a degree; the pinion attached to the box is actuated by a dial plate or *index disk* and *knob*. The dial is graduated in one hundred parts and on its outer edge are one hundred teeth; it is arranged so that one revolution of the dial plate carries either arm through .99 of a degree. The dial is held and locked in any desired position by a *dial lock* or *index disk clamp* which fits into the teeth on the circumference of the dial and prevents the movement of the arm when locked.

Over the center of the primary block is mounted the *gun center*, which consists of two slides, the lateral adjusting slide and the longitudinal adjusting slide; the gun arm (See Plate XXVI), the fixed limb, the movable limb, the correction box, the degree tally, and the hundredths dial. The lateral slide has a motion along the base-line arm, it is dovetailed on a *guide piece* attached to the base-line arm, and can be clamped in any position by means of three set screws on the rear side which act against a long gib. The guidepiece is graduated and the *slide* is fitted to a vernier reading to one yard. When this vernier is set at zero the center line of the slide passes through the main center of the board. The longitudinal slide is fitted into the lateral slide so that it may be moved in a direction at right angles to the base-line arm. On the longitudinal slide is a scale and on the lateral slide a vernier by means of

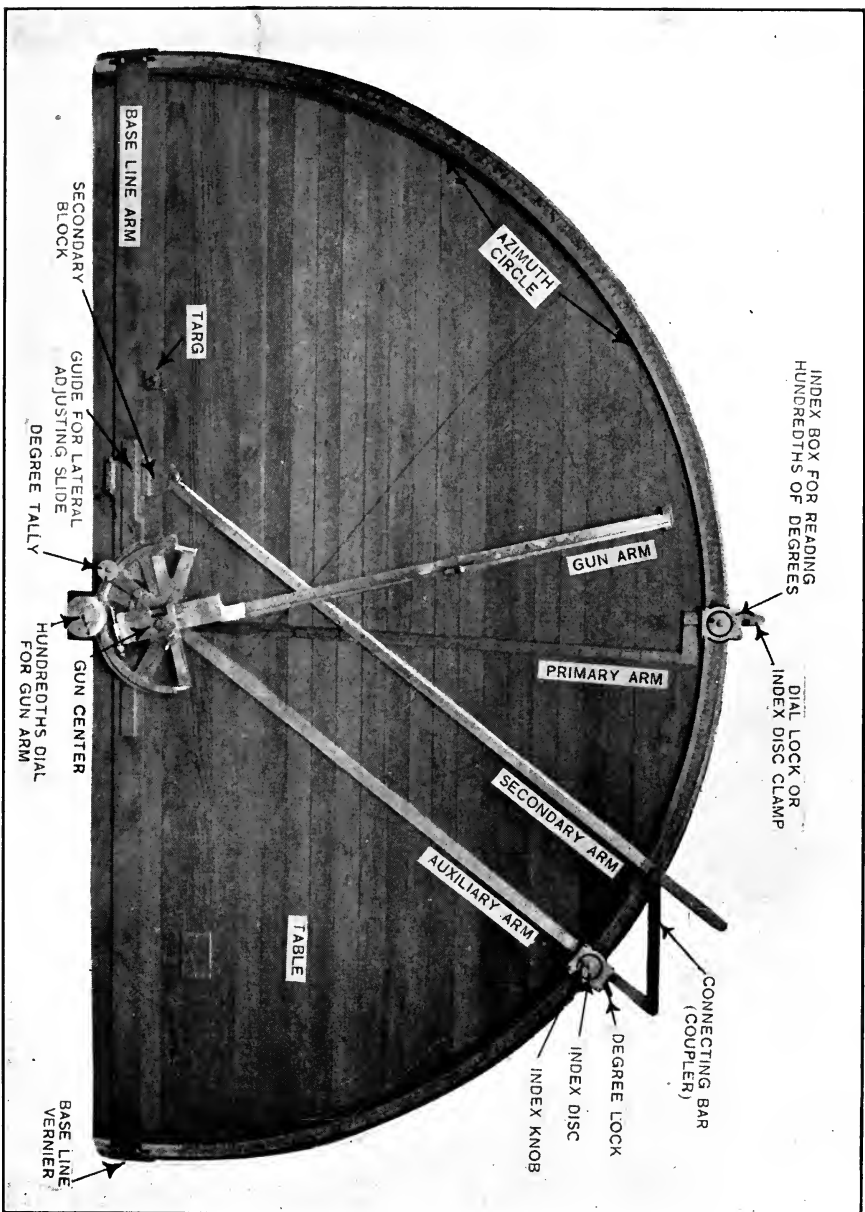

Whistler-Hearn Plotting Board for Guns.



LIBRARY
OF THE
UNIVERSITY
OF
CALIFORNIA

which the slide may be set as desired; the longitudinal slide carries the gun-arm center.

When the vernier on the lateral slide is at zero the gun-arm center is on the base line. When the longitudinal and lateral slide are both set at zero the gun-arm center is directly over the main center of the board or the center at which the primary arm is pivoted. The longitudinal slide is held in position by two set screws which act against short gibs; the lateral and longitudinal slides are provided so that the gun-arm center may be located at such a point on the board with reference to the main center as to correspond to the location of the directing gun or point of a battery, to the scale of the board, and that of the primary station of the battery.

The *gun arm* is made of German silver or aluminium. It is a scale arm or alidade pivoted at the gun center, and is used to determine the range and azimuth of the target from the directing point of a battery. The gun-arm center consists of the gun-arm proper, the fixed limb, the movable limb and the correction box (and, in the first type of board, the travel scale).

The *fixed limb* is a semicircular metallic piece attached to the longitudinal adjusting slide by three screws. This limb carries the degree index of the *gun-arm azimuth circle*, and the *index* or *dial* for reading the fractions of a degree. The gun-arm pintle, about which the azimuth circle and correction box revolve, is attached to this limb.

The *movable limb* is an azimuth circle. It has geared teeth on its outer edge which mesh into the pinion which actuates the mechanism of the hundredths dial. The degrees are graduated on the brass circle, but are numbered on a strip of zinc. This limb is centered on the gun-arm pintle.

The *correction box* is a device for mechanically making the range corrections for atmospheric conditions and travel as determined from the range board, and also for making, mechanically, the deflection corrections as determined from the deflection board. The range corrections are made by sliding the gun arm in or out the required distance which is measured by a range difference scale on the arm. This scale is seen through a reading opening, or window, in the box. The arm is moved in or out by a rack and pinion. The deflection corrections are made by moving the box through a given azimuth angle indicated by a scale on the box. The box is actuated by a worm gear which is attached to the movable limb.

The *degree tally* is a device for indicating the angular travel of the target during a predicting interval, and is on the left of the window

of the gun-arm azimuth circle. Over the face of the dial moves a hand, the reading of which gives the angular travel in degrees. The fractions of a degree are read from the outer graduations of the hundredths dial of the gun arm. The tally scale is marked in reference numbers, running from 0 to 30, the origin, or zero, being 15.

The *travel scale* is a sliding scale on the gun arm used in determining the change in the range of the target during the observing interval on boards where the range board has not been provided with the new travel scales. At the center of this scale is a pointer which is set at the indicated range of the target at the end of an observing interval. At the end of the next observing interval, by turning down the leaf, the change in range for the interval will be indicated by reference numbers. The leaf is held up at all other times by a spring, so as not to interfere with readings of the range scale.

The *gun-arm shoe* is made of bronze, and is used to facilitate the use of the gun arm by obviating the necessity for raising it, and also prevents the bending of the other arms. It slides along the gun arm, and is held in position by a friction spring.

To Set Up the Board.—The trestles should be set up, and the board placed on them in a horizontal position, with the diametrical spider arm of the board resting on the oakum-reinforced pieces of the trestle. Care should be exercised in mounting the board and removing it from its box, as the azimuth circle has been carefully adjusted to the base line arm and primary center, and a blow on the azimuth circle or the base-line arm may destroy the adjustment of the entire board.

The direction and length of the base line having been determined, loosen the screws holding the proper end of the base-line arm, and slip the sliding station block on the base-line arm. The screws on the end of the base-line arm should then be replaced and tightened. The small gib of the sliding block should be slipped into place, and the vernier attached. The small gib in the rear of the secondary station block should be loosened sufficiently to adjust for the correct length of reading for the base line in yards. After this adjustment is made, the gib screw should be carefully tightened. An adjustment of one degree in azimuth in either direction can be given to the base line, but .50 of a degree is the maximum amount necessary to be used.

To make this adjustment, slacken the clamp screws at each end of the base-line arm, and also the screw directly on the end of the primary station block. Set to the correct position by means of the vernier. This caution is given owing to the fact that on account of the length of the base-line arm there is apt to be some spring which might give a false

position with only one reading. Both verniers should be read and should agree. The readings, however, should be in opposite directions. Two supporting plates with two dowel pins in each are placed under each end of the base-line arm to support it and prevent sagging. It is not necessary to remove these in making an adjustment of the base-line arm.

The primary arm for right-handed base line is marked with the initials "P. R." The secondary arm for the same board would be marked "S. R.," and the gun arm "G. R." The auxiliary arm is simply marked "R.," on one side, and "L.," on the other side.

For a left-handed plotting board the primary arm would be marked "P. L.," the secondary arm "S. L." and the gun arm "G. L." The "R" side of the auxiliary arm is up for a right-handed board, and the "L" side is up for a left-handed board. When mounting the scale arms, the primary arms should be placed next to the board being pivoted on the main pintle. The auxiliary arm is pivoted on the same pintle and placed on top of the primary arm. The secondary arm passes over the primary, and is connected to the auxiliary arm by a coupler which has the same length as the base line. The object of the coupler is to keep the secondary arm parallel to the auxiliary arm, and obviate the necessity of having more than one azimuth circle, as the auxiliary arm is pivoted at the center of the main azimuth circle, or at the pintle center of the board.

The azimuth readings from the secondary station being set by means of the index box on the auxiliary arm, the coupler keeping the secondary arm parallel with said arm, must necessarily give the secondary arm the correct direction with reference to the primary, or in other words, set the secondary arm at the same azimuth.

Two index boxes are furnished with each board, one for the auxiliary arm and one for the primary arm. These boxes are marked "Aux. R." and "Prim. L." and the other is marked "Aux. L." and "Prim. R." For a right-handed base line the index boxes marked "Aux. R." is for the auxiliary arm, and the box marked "Prim. R." is for the primary arm. If a left-handed board is used, the box marked "Aux. L." is for the auxiliary arm, and the box marked "Prim. L." is for the primary arm.

To assemble the index boxes, set the pointer at 50, and insert the rack in position according to the corresponding marks *A* or *B*, being careful to see that the teeth of the pinion *O* meshes with the teeth of the rack marked *O*. The rack should be held in position until the index box is placed over the scale arm. Bring the arm on which the index box is to be mounted over one of the places near either end of the base-

line arm, where the azimuth circle is cut out. If a right-handed base line is used, the primary index box is inserted over the azimuth circle at the right-hand end of the base line, and the auxiliary arm is inserted at the left-hand end of the base line, and vice versa for a left-handed base line.

Be sure to hold the rack in position while the scale arm is being inserted under the rack and between the locking plate and the index box. The scale arms must not be lifted too high when assembling the boxes, as the arms may be bent at the pivots. If the rack has been inserted correctly, the pointer of the dial will move clockwise from 0 to 99.

On the outside of each index box, on the locking plate, will be noticed a small brass lip. When the edge of this lip is opposite the center of the notch in the azimuth circle, the locking lever can be pulled out, thus locking the index box to the azimuth circle and permitting an adjustment up to .99 of a degree by moving the index disk on the index box. Above the locking plate is a small latch, and before attempting to turn the index disk, this latch must be pulled out. The movement of this knob is only about one-eighth of an inch, and does not require a heavy strain. After the correct reading has been obtained by setting the disk, this latch is pushed in and locks the disk in position.

To mount the gun-arm center, place it over the tongue of the base-line arm with the dials of the gun-arm center, toward the rear of the board. Insert the lateral adjusting-slide gib according to the corresponding marks on the gib and gun-arm center. Then screw up the gib screw slightly, so that the gun-arm center can slide by the primary or secondary station blocks, but not so tight that the gun arm cannot be moved.

To set the gun-arm center, the fixed limb must be moved to expose the scales on the longitudinal adjusting slide. The fixed limb is secured to the longitudinal adjusting slide by three retaining screws and the gun-arm center pivot. One retaining screw is located in the rear position of the gun-arm azimuth subscale, and is entered by removing the tally subdial. Two screws are also located on either side of the pivot, and are entered from the top of the fixed limb by turning the gun arm to the left. The right end retaining screw near the pivot can be taken out, and similarly by turning the gun arm to the right, the left end retaining screw can be taken out. The fixed limb can then be turned to the right or left about the gun-arm center pivot. The position of the gun-arm center is set according to the distance in yards of the gun in front of, or in rear of the base line. This adjustment is made on the longitudinal adjusting slide, which has two scales on it, of 25-yard divisions, and two verniers attached to enable readings to one yard. The two gib

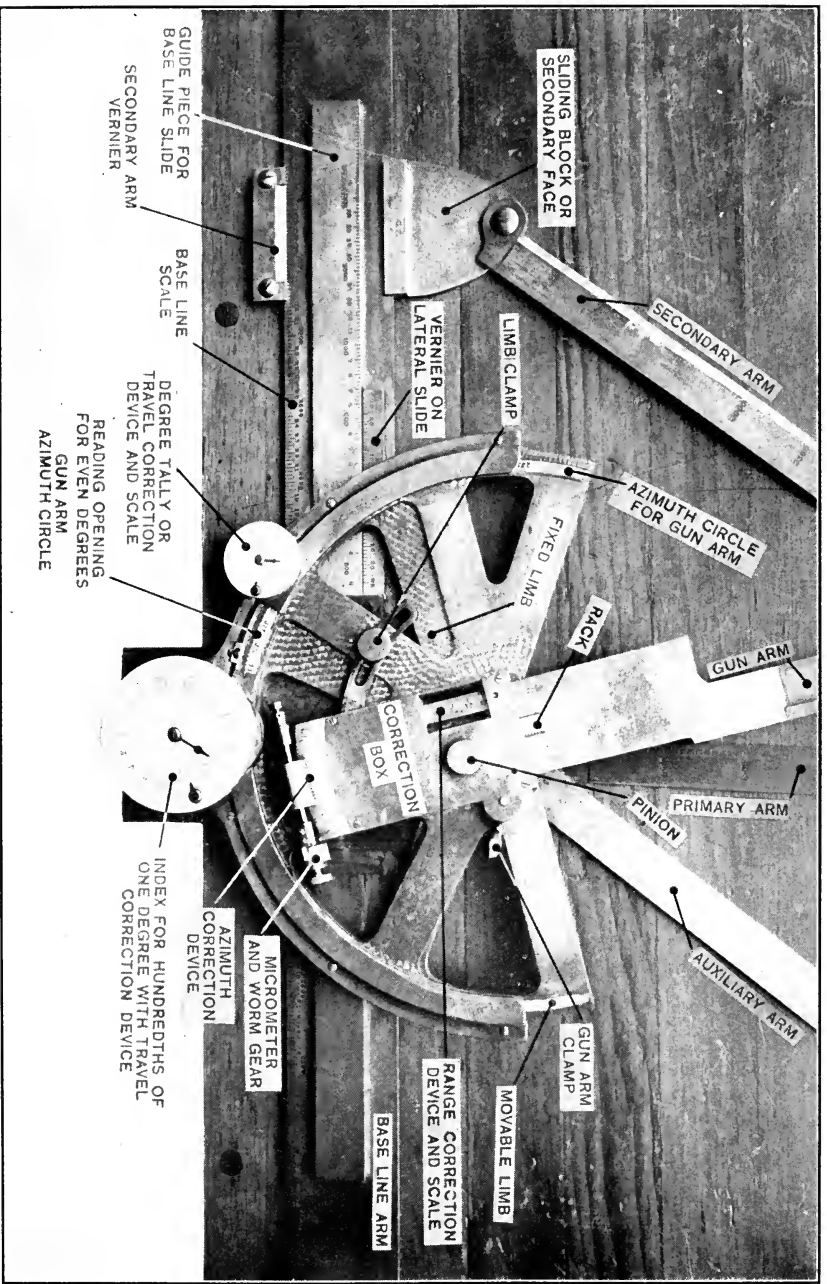

Gun-arm center of Whistler-Hearn Gun Plotting Board.



screws on the left-hand side and under the fixed limb, are then tightened.

The limit of this adjustment is 1,000 yards to the front or to the rear of the base line. The distance in yards to the right or left of the primary station is set on the lateral adjusting slide, which also has a vernier reading to one yard, with two scales each of 25-yard divisions. The limit of this adjustment is 4,000 yards to the right or left of the primary station. The three gib screws on the rear of the lateral adjusting slides are then tightened. After the position of the gun-arm center has been located, the fixed limb should be replaced. The "target" is for the purpose of obtaining an exact reading at the intersection of the edges of the primary and secondary arms. It should be held up against the edge of the secondary arm, and moved along that edge until it touches the primary. This gives the intersection. Care should be taken not to bring it against the edge of the primary arm with too great a force and thus injure the edge of the arm.

To Orient the Board.—The normal line of the board is the radius at right angles to the base-line arm, when the verniers at each end of the base-line arm are set at 0. The center of the center notch in the azimuth circle and the center of the main pintle, establish this normal. As has been stated, the base-line arm may be moved through one degree either way, and to set the proper reading by means of verniers attached to each end.

The 0 of the base-line arm may be given any convenient degree number, depending upon the azimuth of the actual base line. It is convenient to number one 0 with the nearest degree to the back azimuth; that is, 180 degrees plus the azimuth of the base line. For example: Assume that the azimuth of the base line is 312.26 degrees, and that the base line is left-handed. Then the 0 at the left hand of the base line arm would be numbered 312 degrees, and the 0 at the right-hand end would be numbered 132 degrees. To orient the base-line arm to correspond with the actual base, it is necessary to swing the base-line arm clockwise to 0.26 degrees. That is, to set the left end to 312.26 degrees. The other of course would be set at 132.26 degrees. Assume that the azimuth of the base line was 312.90 degrees, then the left end would be numbered 313 degrees, and the right end 133 degrees. To set the base line at 312.90 it would be necessary to swing the base-line arm contraclockwise through 0.10 degrees; in other words, the left-hand end is to be set at 312.90 degrees, and the right-hand end at 133.90 degrees.

To orient the gun-arm center, bring the gun-arm center over the

primary center by placing the zeros of the longitudinal adjusting slide verniers and the lateral adjusting slide verniers coincident with the zeros of their respective scales. See that the 0 of the worm guard is opposite 15 on the azimuth correction scale, and the scale on the micrometer head of the worm is at 0. Bring the primary arm to the normal line of the board, and be sure that the pointer of the index box on the primary arm is set at 0. Place the targ against the reading edge of the primary arm, and bring the gun arm carefully up against the targ. If properly done, the reading edges of the primary and gun arm will now coincide to the normal line of the board. Set the azimuth pointer at the gun-arm azimuth window by means of the adjusting screw to the whole degree of the azimuth of the normal.

Next set the gun-arm azimuth sub-dial indicator to 0 by loosening the screw holding the indicator in place. This will allow an adjustment of $\frac{1}{4}$, $\frac{1}{2}$ or $\frac{3}{4}$ of a degree. If that is not sufficient, the tally sub-dial is removed. The vernier dial face can now be adjusted within the limits of $\frac{1}{4}$ of one degree by loosening the retaining screw and moving the dial until the pointer is at 0.

To test this orientation the gun arm should be moved away from the targ, and brought up to it several times. The gun-arm center is now moved to a position on the board to a corresponding position of the gun arms previously explained. To test the accuracy of the board, take three positions of a target near the center of the board and extremes respectively, each at about a range of 6,000 yards, and calculate trigonometrically and see if the calculations agree with the readings given by the board.

Another simple test of the accuracy of a plotting board is to plot the location of the datum points with a range and azimuth of either station, and then check the range and azimuth as given by the board from the other station. The azimuth and range found should agree with that given on the datum sheet.

Care of the Board.—Too much attention cannot be given to the scale arms, as the accuracy of the board depends upon the reading edges being true, straight edges, and any roughness due to handling of these arms will impair the accuracy of the board. If the scale on the micrometer head of the worm needs adjustment, it should be made by using the spanner wrench and pin wrench furnished for loosening the jam nut. If the worm has any backlash, this will be due either to the fact that the worm is not in close enough mesh, or that the screw at the left-hand of the worm is not adjusted properly. To correct the first, release the two clamp screws on the worm, and move the worm forward to the proper

mesh; then tighten the screws. To correct the second error, release the jam nut by using the small end of the spanner wrench, and then adjust the screw by holding the screw with the small pin wrench, and tighten the jam nut. All the pivot bearings should be oiled regularly, and the board kept free from dust at all times. When not in use, the index box locking levers should be left released.

To Use the Board.—The gun plotting board is used for batteries of the primary armament and of the intermediate armament to include 6-inch batteries provided with a separate base line.

Readings are taken simultaneously at the base-end stations and transmitted to the arm-setters for the primary and secondary arms of the plotting board. The arm-setters lock the index box in the degree notch of the azimuth called to them by the readers over their respective telephones, locking the box in this position with the degree lock. They then set the index disk of the box to the hundredths of degrees as called and lock the index disk with the index clamp. When this operation is completed each arm-setter calls "set," which is a signal for the plotter to move the "targ" along the left edge of the secondary arm until it comes to the intersection of the secondary and primary arms, which point indicates the position of the target.

After the first two readings the plotter moves the gun arm up to this intersection and reads and transmits the range as indicated on the gun arm to the guns. These readings are sent to the guns every 15 seconds and are the corrected ranges for the target being tracked.

The corrections are made as follows: The assistant plotter at the first setting of the gun arm turns the hundredths dial for gun arm until the zero is opposite the pointer and also sets the degree tally so that the number 15 of the degree tally scale is opposite the pointer. At the second setting of the gun arm he calls off the reference number from the degree tally and the hundredths dial of the gun arm. This reference number indicates the angular travel of the target during the observing interval and is used by the deflection computer in the operation of the deflection board. The assistant plotter also sets the wind component indicator to the proper azimuth which is taken from the azimuth circle for the gun arm.

In Case III the assistant plotter calls off the corrected azimuth as shown on the azimuth circle for gun arm and index for hundredths of degree scale.

The range correction device is set at the proper reference number as obtained from the range board by the range-correction computer.

MORTAR PLOTTING BOARD, MODEL OF 1906

(See Plate XXVII.)

This board is similar to the Whistler-Hearn plotting board just described, the principal difference being the mortar arm, and mortar arm center. The two principal parts of the mortar arm, which are shown in detail in Fig. 48, are the range and zone scales.

The range scale gives the range of the object plotted from the mortar, and in conjunction with the mortar-arm center gives its azimuth. The zone scale is in 8 zones, and gives the elevation in degrees and the times of flight in seconds for all ranges from 2,000 to 12,000 yards. The zone scale permits of adjustment for correction. The mortar arm is pivoted to the mortar-arm center by means of the mortar-arm box, and permits of it being raised from the board at any time in a vertical plane. On account of the increased size of the mortar-arm center over the gun-arm center of the regular plotting board, a mortar-center support has been provided. The instructions for adjusting, assembling and orienting the Whistler-Hearn plotting board hold good in the case of this board.

To Use the Board.—The mortar-plotting board is used similarly to that of the gun-plotting board except that the mortar arm is provided with a sliding scale, as shown in Plate XXVII, which is graduated into degrees of elevations and times of flight for each zone. The two arm-setters on hearing the azimuth at the signal for each observation set and lock the primary and secondary arms as previously described for the gun-plotting board. The plotter, as soon as he hears the command "set," marks the position of the target by making a pencil mark on the plotting-board chart at the intersection of the two arms.

The tracking of the target is commenced and four or more positions plotted on the board at 20-second intervals. The plotter then moves the mortar arm up to the last plotted position of the 20-second readings and estimates where the vessel will be, providing the course is continued for two minutes ahead of the time of the last plotted point. He calls out the zone indicated on the mortar arm to the azimuth computer, who operates the mortar deflection board, and who in turn transmits these data to the booths.

The plotter also notes and remembers the time of flight indicated for the range and zone in question. The position of the target is then plotted either every 30 seconds or every minute. For example, it will be assumed that it is plotted every minute. In the cut, Fig. 49, the first four plotted positions at 20-second intervals are indicated by the num-

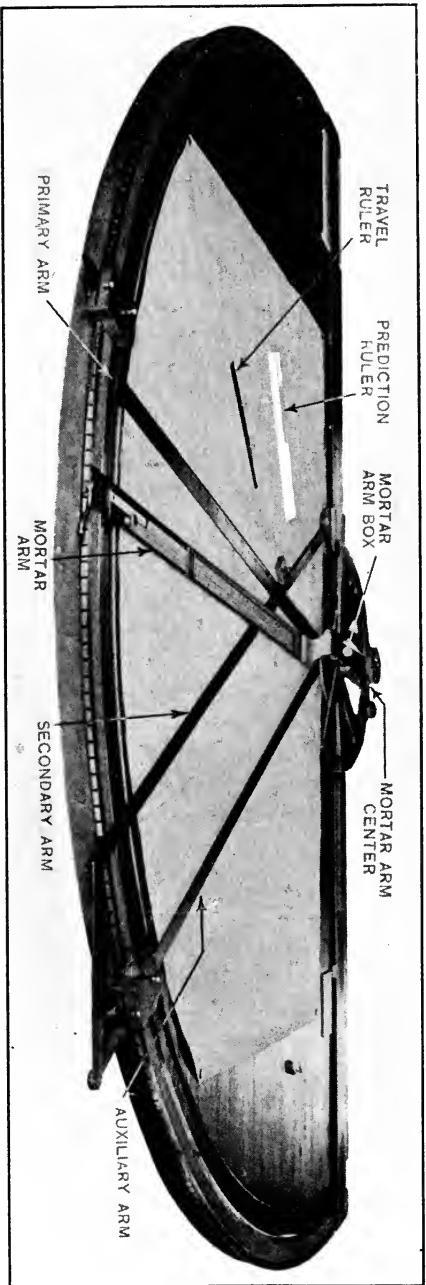

Whistler-Hearn Plotting Board for Mortars.



LIBRARY
OF THE
UNIVERSITY
OF
CALIFORNIA

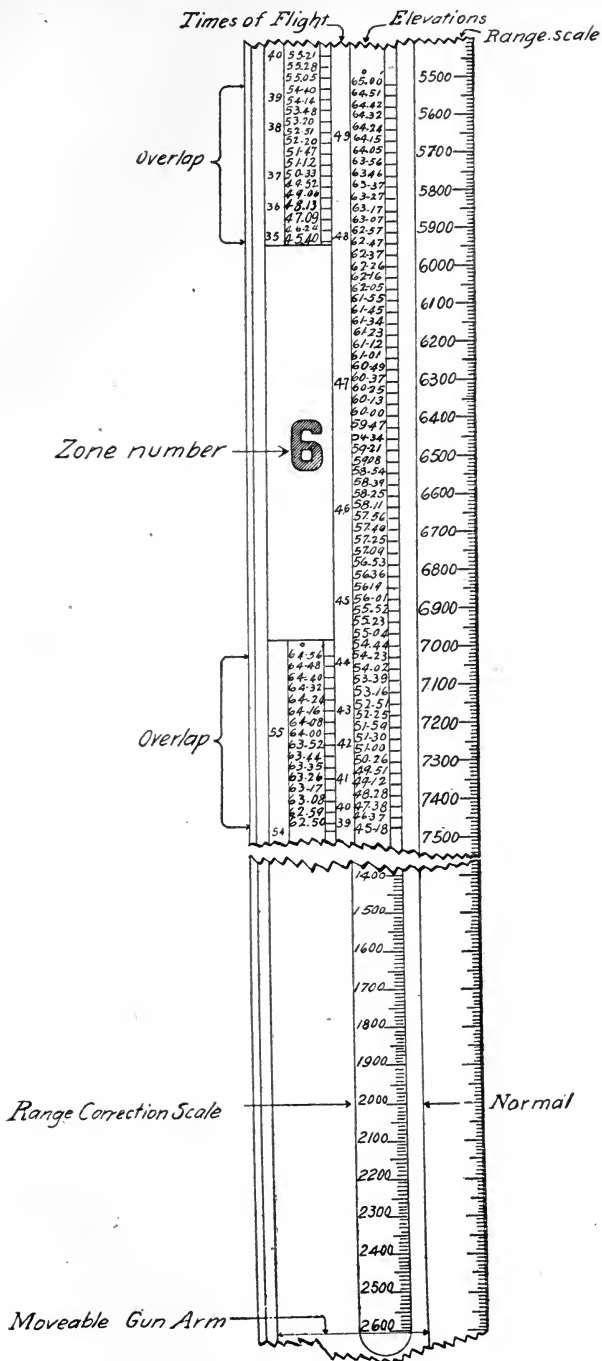

FIG. 48.

bers 1, 2, 3 and 4. The position of the target one minute after the plotted position No. 4 is indicated at 5. When this point is obtained the plotter sets the leg of the predictor nearest to him at position 4 and the next leg to the position 5. The third leg will then indicate the predicted point, and assuming the time of flight to be 50 seconds, the leg of the predictor marked 50 will indicate the set-forward point. When the plotter has obtained these points the mortar arm is brought up to the set-forward point and the elevation read from the arm. No. 1, the assistant plotter, also calls out the azimuth of the set-forward point to No. 4 or the operator of the mortar-deflection board. The plotter then moves the mortar arm up to the predicted point indicated by position 6 and calls out the range to the assistant plotter, who transmits this range

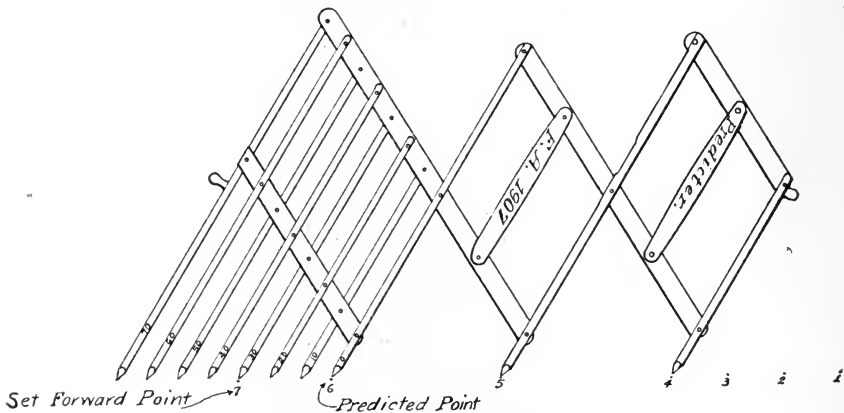
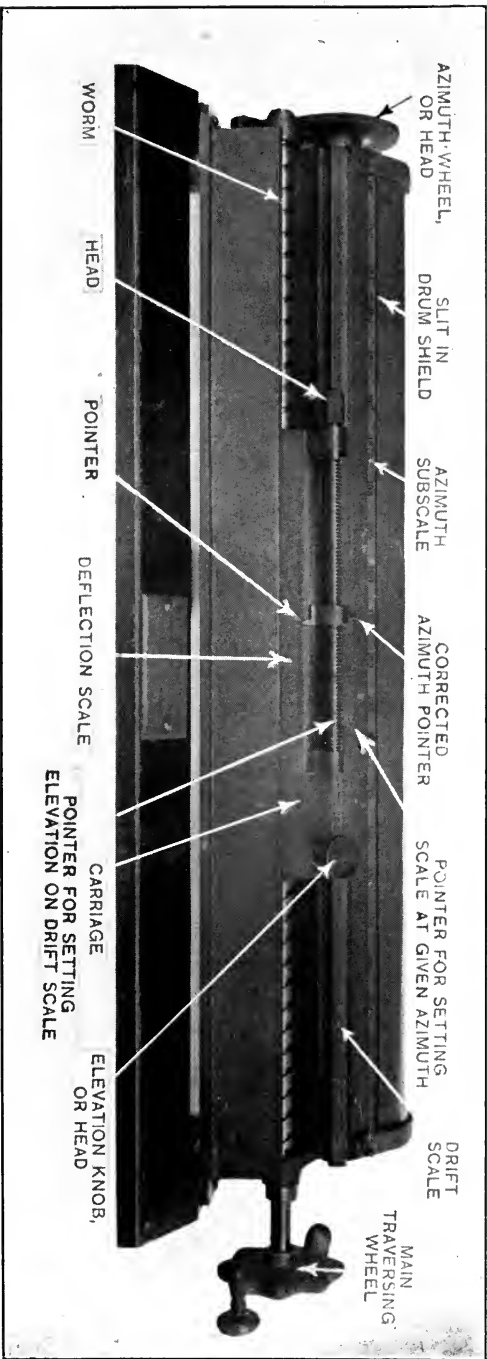

FIG. 49.—Mortar Predictor.

to the battery commander's station to be used in case relocation is necessary. The assistant plotter also transmits to the battery commander's station the azimuth of the predicted point. The range and azimuth as read by the plotter and assistant plotter are the range and azimuth of the directing point of the battery. Should this point not correspond with the position of the battery commander's station, it is necessary for the battery commander to use these data to relocate from the directing point of the battery to the position his instrument occupies. The operator at the deflection board uses the data called to him by the plotter and assistant plotter, as follows:

He first sets the cylinder of the deflection board, shown in Plate XXVIII so that the whole degrees of azimuth as read to him by the assistant plotter appear in the slit of the drum. He then moves the

PLATE XXVIII



Mortar Deflection Board.



LIBRARY
OF THE
UNIVERSITY
OF
CALIFORNIA

pointer, which is carried on the drift-scale slide and used for reading the azimuth subscale, to the hundredth of the azimuth read by the assistant plotter. He next transmits to the booth the elevation called to him by the plotter and at the same time sets the small pointer (elevation pointer) on the deflection scale to the elevation given him by the plotter. In case no arbitrary correction has resulted from the observation of fire, the large pointer on the deflection scale then indicates the corrected azimuth of the set-forward point and No. 4 transmits this azimuth to the booths as soon as he has completed the operations just described. The zone number, elevation, and corrected azimuth are posted from the booths so that the mortars may be laid on the data given. The battery commander relocates from the directing point of the battery for the position of his instrument and sets his instrument at the relocated azimuth as determined from the range and azimuth of the predicted point previously transmitted to the station by the assistant plotter. As the target comes on to the vertical wire of his instrument he signals or closes the switch for firing the mortar or mortars of the pits that have signaled "ready." Should the target not come on to the vertical wire of the battery commander's instrument at the proper time, he withholds the fire and gives instructions to "relay."

ZONES AND VELOCITIES

The number of zones, muzzle velocities corresponding thereto, zone limits, width of zones and overlaps for the 12-inch mortar, cast-iron, steel-hooped, and the 12-inch mortar, steel, are shown in the following table:

No. of Zone.	12-inch Mortar, Cast-iron, Steel-hooped.					12-inch Mortar, Steel.				
	Muzzle Velocity. F. S.	Weight of Projectile. Lbs.	Zone Limits. Yds.	Width of Zone. Yds.	Overlaps. Yds.	Muzzle Velocity. F. S.	Weight of Projectile. Lbs.	Zone Limits. Yds.	Width of Zone. Yds.	Overlaps. Yds.
1	560	1046	2225-3000	775	400	550	1046	2210-2970	760	370
2	610	1046	2600-3480	880	480	600	1046	2600-3431	831	361
3	670	1046	3080-4110	1030	400	660	1046	3070-4030	960	399
4	743	1046	3710-5000	1290	400	725	1046	3631-4800	1169	371
5	837	1046	4600-6240	1640	400	810	1046	4429-5940	1511	420
6	910	1046	5840-7319	1479	594	915	1046	5520-7476	1956	449
7	1050	824	6725-9225	2500	1050	1046	7027-9250	2223	492
8	1300	824	8758- 12019	3261

In target practice with 12-inch mortars the extreme zones in which practice may be held will be the sixth with the cast-iron steel-hooped mortar, and the fifth with the steel mortar, except that with the steel mortar mounted upon the model of 1896 MII carriage or the model of 1896 carriage converted to the model of 1896 MI carriage, practice may be held in all zones.

MORTAR PLOTTING BOARD, MODEL OF 1906 M_I

This is a special plotting board, made for cases where the mortar-arm center is more than 1,000 yards behind the base-line. The maximum distance permitted for the mortar-arm center to be behind the base line arm in this type of board is 2,000 yards. In order to meet this requirement, the lateral adjusting slide of the board has been extended towards the rear, and the base-line arm moved back. The mortar arm has also been changed to correspond with the other changes on this type of board.

SUBMARINE PLOTTING BOARD, MODEL OF 1906

This board is the Whistler-Hearn plotting board, model of 1904, simplified. The board is not provided with a gun arm or gun center. The scale of the board is 100 yards to the inch, or in some cases, 150 yards to the inch, depending upon the mine field to be plotted. The primary arm, secondary arm, base-line arm and base-line verniers are slightly different in construction from the regular plotting board, but the principles of the board are exactly the same.

Due to the fact that the range of the board is necessarily limited, the scale on the arms has been changed to 100 yards to the inch, or 150 yards to the inch. The board, when assembled, adjusted and oriented, has mounted upon the table a chart showing the location of the principal datum points within the mine field, the outline of the entrance to the harbor, the various channels, the depths of water passable by the various types of battle-ships, cruisers and torpedo boats, and also the location of the distribution boxes and the mines comprising the mine field.

To Use the Board.—Readings are taken at the base-end stations of the mine-base line simultaneously, every 15 seconds, and the primary and secondary arms set at the azimuth readings sent is by the readers at the base-end stations; each arm-setter indicating by calling the word "set" when his arm is set at the azimuth called to him by the reader at the primary or secondary instrument.

At this signal the plotter indicates the position of the target at the intersection of the two arms by making a dot with the point of a pencil. The target is tracked in this manner until its position is indicated to be within the predicting distance of any mine of the group over which the vessel will pass; this distance ordinarily is taken as $1\frac{1}{2}$ times the distance traveled by the target during any observing interval. At the last stroke of the time-interval bell which would give such a position the plotter starts a stopwatch, and after the arm-setters have set their arms to the readings sent them, the plotter calls out "arms off," at which command the arm setters move the primary and secondary arms out of the plotter's way.

The plotter then, with the mine-prediction ruler, measures the distance from the last plotted point to the mine, and from the last plotted point to the preceding plotted position of the target, obtaining in the first case the distance the vessel has to travel before crossing the particular mine in question, and in the second, the travel of the target during the predicting interval. He then manipulates the mine-prediction ruler shown in Fig. 50, and obtains the time that it will take the vessel to travel from the last plotted point to the mine.

Previously the plotter has sent word to the casemate the number of the group and the number of the mine in the group that the target, if it continues its course, will pass over or nearest to. At a short interval

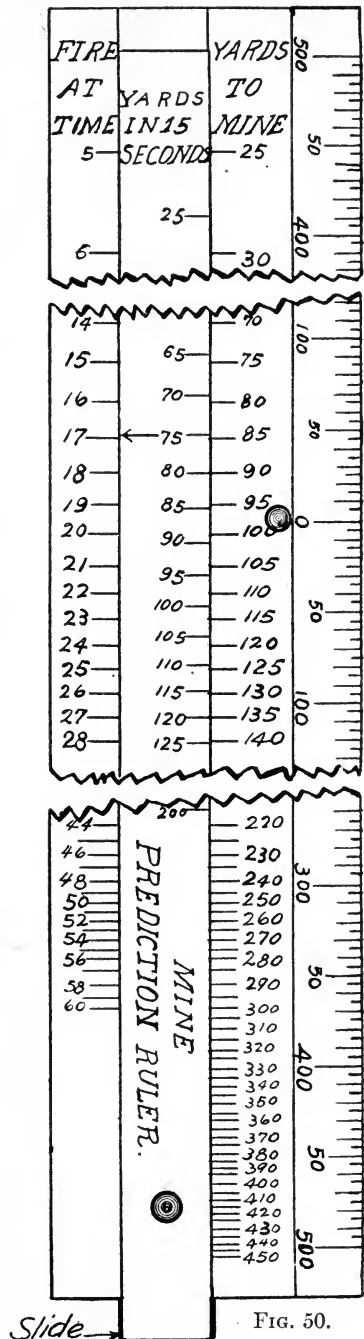

FIG. 50.

before the time required for the vessel to travel from the last plotted point to the mine has expired (say two seconds), which is allowed for transmission of message from the mine primary station to the mining casemate, the plotter calls out "ready, fire." This method of plotting is that used for judgment firing. The mine-plotting board is not provided with the gun center or gun arm. It can be used for either the horizontal or vertical base system, exactly the same way as the gun-plotting board.

FIRE COMMANDER'S PLOTTING BOARD

The Fire Commander's plotting board is the regular Whistler-Hearn plotting board, with a pantograph attachment, as shown in Fig. 51, to

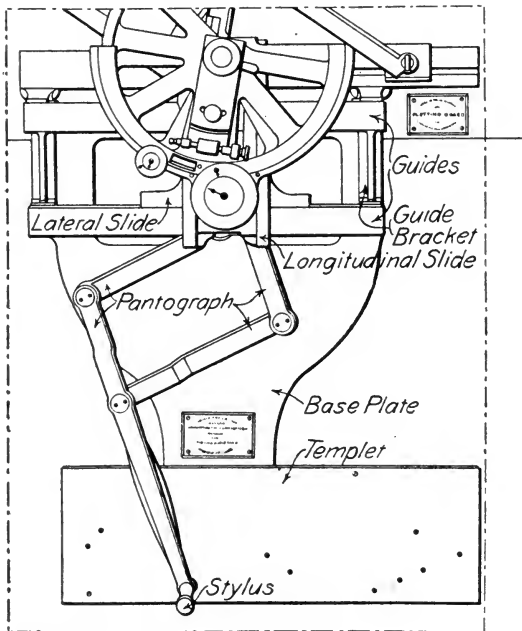

FIG. 51.

enable the Fire Commander to adapt his board to any base line of the fire command.

The scale of the board is 300 yards to the inch. The pantograph arms are so constructed that when pivoted at the pantograph pivot, the stylus moves through a reverse space five times greater than that moved

through by the end connected to the longitudinal slide. Hence, the scale of the templet is five times the scale of the board, or 60 yards to the inch. The holes in the templet represent an accurate reversed plan of the centers of the observation stations, and directing guns of the various batteries of the fire command considered. The names of these stations and batteries are marked directly under their respective holes on the templet. If the pantograph arms are moved so that the stylus can be placed in the hole representing the primary or center pivot of the board, the gun center will be exactly over the primary center of the board. As the line through the two holes on the templet is parallel to the base line, it is obvious that as the stylus is moved forward or backward, right or left, the gun center or its longitudinal ordinate will move reversely backward or forward, and will move reversely the lateral ordinate, left or right, a distance one-fifth of that covered by the reversed corresponding motion of the stylus over the templet. Hence, if the stylus is inserted in any of the holes in the templet, it will place the gun center in a position exactly corresponding to the particular hole used, relative to the base line, and the range and azimuth as read to any plotted point will be the correct range and azimuth of that point from the station or directing gun designated by the marking of the hole in the templet occupied by the stylus. Moving the gun center to the various positions it may occupy does not change the orientation of the gun-azimuth dial, as the movement to obtain the various positions are broken up into components parallel to and normal to the base line.

In making range corrections, the clamping lever should be released and the required adjustment made by moving the range dial. The gun arm is at zero when the range-dial pointer indicates the reference number 2,000.

In making azimuth corrections, release the knurled clamping screw on the azimuth-correction plate. By turning the azimuth-correction worm, the correct adjustment can be made. Read degrees directly from the azimuth-correction plate, and one one-hundredths of degrees from the micrometer drawn on the right-hand end of the worm.

The azimuth-correction plate is at zero when the line on the worm cover coincides with the reference number 15. The micrometer drum should then be at "0." If the micrometer drum needs adjusting, release the clamping nut by the spanner wrench to be found in the drawer. Hold the micrometer down in position with small pin to be found in drawer, and tighten the nut. If the worm works too freely in its bearings, it may be adjusted by the set screw and nut on the left of the worm

bracket. If the worm has any back lash, it may be taken up by releasing the two screws clamping the bracket to the fixed limb, and by setting the bracket closer to the azimuth correction plate.

The small dial to the left of the gun-azimuth dial is called the tally dial, and in conjunction with the tally sub-dial, is used for obtaining angular travel of a target during a predicting interval. The hand scale is a sliding scale and is intersected in an undercut groove on the gun arm. It is used for obtaining change in range of a target during an observing interval.

Should the lateral and longitudinal slides become loose, due to wear, they may be adjusted by the adjusting wedge on each slide. To do this, first take out hexagonal screw attaching the pantograph to the longitudinal slide. Then by releasing the screw on the small end of the adjusting wedge, the screw on the large end may be adjusted until the slide can be moved freely, but without side play. The screw on the small end of the wedge is then tightened, thereby clamping the wedge. It is imperative that the pantograph be disconnected from the longitudinal slide before attempting to adjust either slide, as each must be tested separately, and as there would be danger of bending the stylus end of the pantograph in moving the gun center, if either slide is made too tight.

The assembling, adjustments and orientation of the board are similar in all respects to those of the regular Whistler-Hearn plotting board.

THE RANGE BOARD

The range board is a device by means of which the *range corrections for atmospheric conditions; range corrections for tide; range corrections for travel of target; and range corrections for variation in muzzle velocity* are mechanically added and subtracted.

The total range correction, when determined, is applied to the range-correction scale on the gun arm of the plotting board.

The nomenclature of the board is shown in Plate XXIX, and consists of a *frame* in which a graphic range-correction chart is mounted. In front of the chart is a balanced horizontal *ruler* which can be moved up or down and set opposite any range on the chart. The vertical scale of the chart is marked in both range and time of flight. The ruler is maintained in position by chains secured to it at each end which pass over chain sprockets and are secured to a counterweight which balances the ruler. A clamp, or *clamping screw* on the left of the frame secures the ruler at any desired position.



LIBRARY
OF THE
UNIVERSITY
OF
CALIFORNIA

On the ruler is a scale for the ruler, a bar and a pointer. The scale is fixed in position on the plate of the ruler, while the bar and pointer are arranged to slide horizontally. The scale, bar, and pointer, in connection with the chart, constitute the computing device for mechanically adding algebraically the various corrections. The scale on the ruler and the horizontal scale on the chart is 100 yards to the inch.

The origin of the correction scale of the gun arm on the plotting board is numbered 2,000, in order that the correction to be made thereon shall never be negative. This requires 2,000 to be taken as the origin of the scale on the ruler.

The curves on the chart indicate the magnitude of the corrections to be added or subtracted, and the ruler mechanically performs the addition or subtraction. In each set of curves the horizontal distance from any curve to the normal of the set (which is the heavy vertical line in the center of each set of curves), is equal to the correction in yards of range at the particular range considered, corresponding to the conditions represented by the curve, plotted to the scale of 100 yards to the inch. The curves are drawn for every 2 per cent. variation in the density of the air, for every 10 foot-seconds of muzzle velocity; for every 5 feet of tide, and for every 10 miles of wind. For conditions when the values lie between these least readings, the pointer can be set by the eye closely enough for all practical purposes.

The vertical scale of the chart has a time of flight scale, one second to the inch. Each range number is plotted at a point corresponding to the time of flight for that particular range.

The travel device consists of a travel scale, secured by two supports on the top of the box; the upper ends of the supports pass through the top of the box, are threaded and provided with nuts. To adjust the position of the scale the top edge of each should be about 27 inches above the zero line of the chart. A travel bar is arranged along the travel scale, and carries a trammel or pointer for reading the upper scale, also a trammel or pointer for reading the lower scale; these are so arranged as to slide freely along the travel bar. The pointer for the lower reading is so arranged as to obscure the upper row of graduations on the travel scale.

The normal of the travel scale is 300 and this scale is graduated from the normal to the right with 10-yard divisions to a reading of 100, and to the left with 10-yard divisions to 600, which number is taken as a new origin for graduations on a second scale from 0 to 900. The first-described scale is the travel scale used for determining the travel of the target during the predicting interval; the second scale is a tally scale

used to determine the change in range of the target during the predicting interval.

The travel device is so located that the normal is directly over the normal of the prediction scale on the chart, which is also marked 300. The upper row of graduations on the travel scale correspond to a fifteen-second observing interval and the lower row to a thirty-second observing interval. Near the right-hand end of the travel bar is an index mark, and a string is attached at this point. This string passes over the travel scale, through the hole in the centering stud, and around the hook eye to the eye pin. A rubber band is tied to the lower end of the string to keep it taut as the travel bar is moved back and forth. When the index of the travel bar is set at normal the string should be over the normal of the prediction curves on the chart, that is over the 300-line mark. The travel scale for a 15-second time interval is so graduated that if the string is set for any reference number thereon, it will intersect the horizontal line corresponding to 15-second time of flight at a distance from the normal equal to the travel represented by the number on the scale at which the string is set. The scale for a 30-second time interval is so constructed that under the same conditions the string will intersect the horizontal line corresponding to 15-second time of flight at one-half this distance.

The left end of the travel scale is graduated from right to left in ranges from 0 to 1,600; only the numbers from 1,000 up are marked on the scale without the digit indicating the thousands. This is so that the scale may be adapted to any range, the proper thousand number in any particular case being understood or assumed.

Across the box, near the top of the board, is a bar for curve indicators or pointers, on which are four curve pointers, which admit of sliding back and forth. They are used to mark the particular curve which is to be used in making corrections.

Near the lower edge of the ruler is the bar for the tally indicator, on which the tally indicator slides back and forth. This is used to indicate the amount of the total range correction in the last previous operation of the board.

To avoid the use of two sets of numbers of the same magnitude with plus and minus signs, reference numbers are used for denoting the various curves on the chart. For example: If the wind curves are numbered in both directions from 0, there would be a plus 10-mile wind curve, and a minus 10-mile wind curve, and it would require extreme care to avoid the wrong curve being used, so in using reference numbers, the normal, or 0, is taken as 50, in which

case the reference numbers for a plus and minus 10-mile wind become 40 and 60 respectively, and in this way liability of error is reduced. With the atmosphere curves, it is reasonable to assume that the maximum variation that is ever liable to occur in the value of $\frac{\delta'}{\delta}$ is 16 per cent. The normal of these curves is therefore taken as 16, and the reference numbers run from 0 to 32, and read from left to right. With the wind curves, the board is constructed for a 50-mile plus or minus wind; therefore, the normal is numbered 50, and the reference numbers run from 0 to 100, and read from left to right. The reference numbers for the tide curves represent the actual height of tide in feet, plus or minus, likewise the velocity curves are numbered with the actual velocity to which they correspond. The travel and prediction curves consist of parallel vertical lines. The travel curves consist of the graduations on the travel scale of the travel device, and the prediction curves are the parallel vertical lines on the chart, the horizontal scale of which is 100 yards to the inch. In this set of curves the 300 yards is taken as the normal, and for convenience in computation, the reference numbers of the travel scale read from 100 to 500, from right to left, while the reference numbers of the prediction scale, which is also graduated from 100 to 500, read from left to right.

Adjustment.—Before using the board, it is important to see that the chart has been properly mounted and in the correct position. The 0 line on the print should be on the line with the upper eyelets, and the 300-yard line on the chart should be in line with the two eyelets at the right. The brass eyelets are placed on the left side as well as the right side of the canvas chart mount so that the back side of the canvas chart mount may be used for the chart for one pounder sub-caliber guns.

To Use the Board.—The curve indicators or markers are first set on the proper reference numbers for each set of curves. The tide-curve marker is set to the tide given on the tide dial of the aeroscope indicator, shown in Fig. 53. The marker for the atmosphere curve is set at the reference number indicated on the aeroscope dial, giving the atmosphere density per cent. The velocity curve is set at the velocity obtained from the trial shots, or that assumed for the series of firings. The wind curve is set at the reference number obtained from the wind component indicator, shown in Fig. 52.

The travel bar is moved until the string is at normal (300), and the pointer set at the last three numbers of the first range called off by the plotter. When the second range is called off, the travel bar is moved until the pointer indicates the last three numbers of that range. The

string is now set to indicate the travel during any time of flight. The ruler is then set at the first range called off by the plotter. The scale bar for the ruler is set at normal (2,000). The board is now arranged for making the corrections for the first range called off by the plotter.

The pointer is then set to the curve indicated by the curve marker for tide, and the bar moved until the pointer is on the normal line of the curves. The difference in the reading on the scale on the ruler between 2,000 and the reading shown would indicate the total correction due to tide. In the same manner the corrections are made for atmosphere, velocity, and wind, and finally for travel, which is made as follows: The pointer is set on the string after the latter has been set for a particular travel; the bar is then moved until the pointer is on the normal. The distance through which the index is moved will be that corresponding to the time of flight for the range at which the ruler is set.

If the pointer is again set on the prediction scale at a distance from the normal equal to the travel during the time interval, as indicated by the setting of the string on the travel scale, and the bar is again moved until the pointer is opposite the normal, the index will then have added or subtracted the travel during one time interval. This is necessary in that it requires that there shall be added to or subtracted from the range corrections for any range a correction which is equal to the travel of a target during the time of flight plus the travel during the time interval. In order to do this by one operation the reference numbers of the prediction scale are made to read in the opposite direction from those on the travel scale, as the travel away from the gun requires an additive motion of the bar.

The numbers on the travel scale read from right to left, while the numbers on the prediction scale read from left to right, so that after setting the pointer opposite the string, it will be possible by moving the bar in a direction to make the pointer pass the normal until it is opposite the numerical value of the travel during the time interval to combine the two corrections in one operation.

After these corrections have been made the scale on the ruler, as indicated by the index on the bar, indicates the reading to which the gun arm should be set and thus automatically changes the actual range to that of the corrected range which is sent to the gun. For a better understanding of the board it might be well to explain that if the index of the bar is set at the origin of the scale, 2,000, and the pointer thereon is set on any curve and then the bar is moved to right or left until the pointer is opposite the normal of that particular set of curves it is apparent that

the index will be moved along the scale bar of the ruler a distance to scale equal to the distance between the curve and the normal.

The index will then indicate a number on the scale equal to 2,000, plus or minus the correction corresponding to the curve used. That is, if the trammel is set to the left of the normal, and the bar is moved until the trammel is opposite the normal, the bar will move to the right, and as the scale bar for ruler reads from left to right, the reading of the index will then be greater than 2,000, and therefore the correction is an additive one. For example: If the atmosphere is heavy, it requires an additive range correction, as the projectile would fall short. Therefore the 0 of the atmosphere curve, which represents 16 per cent. increase in the weight of the air, and the 32 curve a 16 per cent. decrease in the weight of the air, and the 16 curve represents standard weight of air. Further, a slight wind would require an additive range correction in order to overcome its retarding effect on the projectile; therefore, the 0 of the wind curve represents a 50-mile per hour head-wind component. The 100-mile wind curve represents a 50-mile per hour rear-wind component, and the reference number 50 represents a 0-wind component for range.

On the side of the board opposite to the regular chart used for guns, is a chart used with sub-caliber tubes, which is constructed 100 yards to the inch. In order to use this chart with the plotting board, the normal of the range-correction scale of the gun arm, and the ruler of the range board is taken as 2,400, and a paper scale, 300 yards to the inch, is pasted on the gun arm showing ranges from 1,400 to 3,500 yards. When the index reading of the range board is beyond the limits of the correction scale on the gun arm, the gun arm may be set by applying the following rule: If the reading be between 2,500 and 3,500, subtract 1,000 from the reading and set the arm accordingly, and add 1,000 to the range. For a reading over 3,500 subtract 2,000 and add 2,000 to the range. To a reading between 500 and 1,500, add 1,000 and subtract 1,000 from the range. To readings less than 500, add 2,000 and subtract 2,000 from the range.

The range-correction computer sets the range-correction scale on the gun-arm center to the reading obtained from the scale on the ruler.

The range boards issued prior to December, 1906, have curves constructed to give the corrections for the *actual* range. Those issued after December, 1906, have curves constructed to give the corrections for the corrected ranges instead of the actual ranges.

THE DEFLECTION BOARD (GUN)

The deflection board is a machine by means of which the *corrections for travel in azimuth during the observing interval, corrections for travel in azimuth during the time of flight, corrections for wind, and corrections for drift*, are mechanically computed.

In Case III the total azimuth corrections obtained are applied to the azimuth correction device on the plotting board.

In Cases I and II the total deflection correction is sent to the guns and set off on the deflection scales of the telescopic sights.

The nomenclature of the board is shown in Plate XXX, and consists of a *base*, upon which slides a *movable frame* called the *platen*. This frame slides on a *rod*, to which it is attached by means of two *trammels*. On the left-hand trammel there is a set screw by means of which the platen may be locked to the rod. The rod in turn is attached to the base by two brackets. In the left bracket is a threaded sleeve which can be turned by a milled head screw or *worm wheel* near it, which gives a slow motion to the rod and consequently to the platen.

Attached to the base at the lower side are three scales, namely, the *deflection scale*, the *travel scale*, and the *azimuth correction scale*. On the latest type of boards, the travel scale is not provided, and is no longer needed for use on the board. The first two scales are fixed on the base, and the other is movable.

On the left-hand side and attached to the base, is the *wind arm* and the *wind arc*. Attached to the platen is the *platen (travel) scale*, over which moves a *travel arm*. The platen scale can be given two positions on the platen; one corresponding to a time interval of 15 seconds, and one corresponding to a time interval of 20 seconds.

The *T square* moves over all and slides on the rod. On the face of the T square is a range scale, called the *T-square scale*. Attached to the left side of the platen is a piece of metal called the *leaf*. The curved edge of the leaf has a *drift curve*, which is used for setting the platen for drift. On the leaf is a range scale which is used in setting the platen for wind and drift, this is called the *leaf-range scale*.

The platen scale represents the travel in azimuth; its graduations represent degrees and hundredths on a scale of half of a degree to the inch. It is numbered from left to right and the number at the origin is 15 degrees. This is a reference number to correspond to the azimuth degree-tally dial on the plotting board. The deflection scale indicates the deflection to be set off on the sight in Cases I and II, the scale being

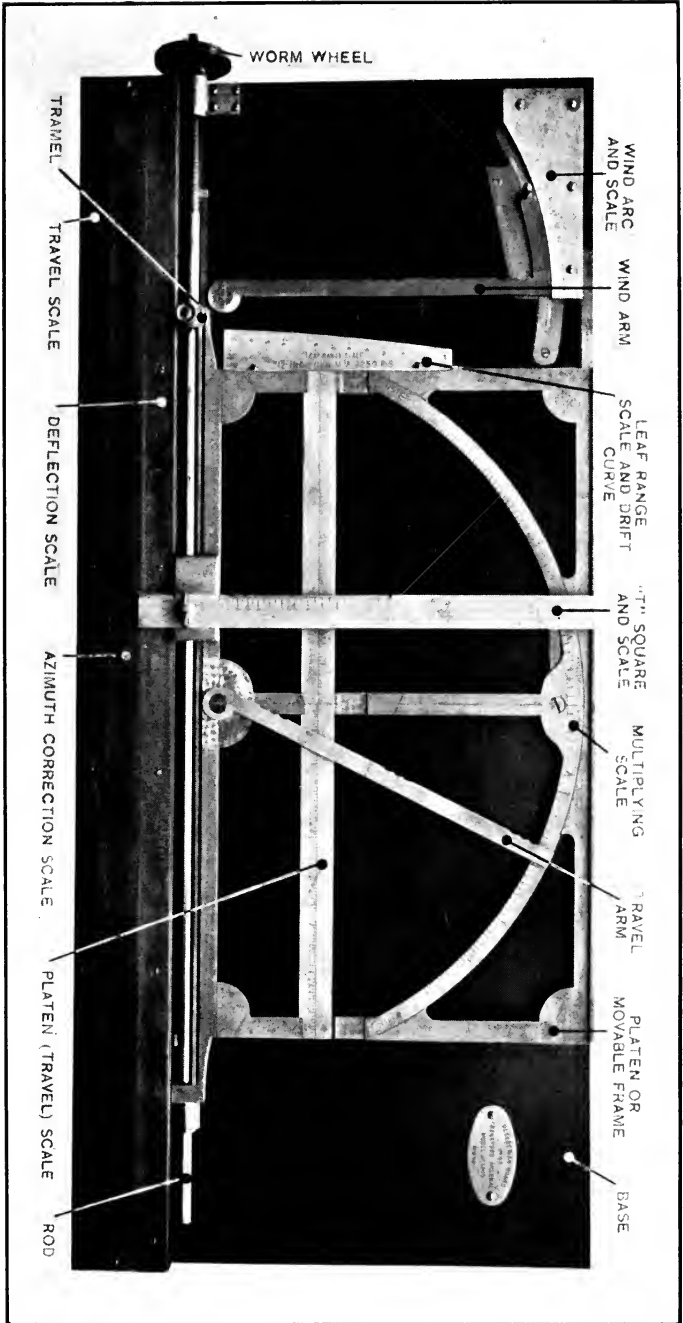

Gun Deflection Board.



LIBRARY
OF THE
UNIVERSITY
OF
CALIFORNIA

constructed to $\frac{1}{2}$ of a degree per inch; it is numbered from left to right with 3 degrees in the center; this is also a reference number, made to correspond with a similar reference number on the deflection scale of the sight.

The azimuth correction scale indicates the correction to be applied to the gun arm on the plotting board when Case III is used; the scale is constructed to $\frac{1}{2}$ of a degree per inch, and is numbered from left to right with 15 degrees in the center, this being a reference number made to correspond with the numbering on the azimuth correction device on the gun arm of the plotting board.

The wind arc is graduated for wind components taken from the wind component indicator. The origin (0 wind) is number 50, and when the wind arm is set on this number it is perpendicular to the deflection scale, and there is no wind correction so far as the deflection corrections are concerned. The reference number 0 corresponds to a left wind component of 50 miles per hour, while the reference number 100 corresponds to a right wind component of 50 miles per hour.

The wind arm is set to the proper reference number by the arrow index. The T-square scale is graduated in yards of range plotted really to a scale of times of flight. The origin for the time scale of the board is the center of motion of the travel arm. The leaf-range scale is used to set the platen for drift; its principal function is to set the platen for a deviating wind component.

To Use the Board.—(1) The wind arm is set to the proper reference number, corresponding to the deflection component as taken from the wind-component indicator. (2) The platen is set so that the point of the drift curve corresponding to the range will be accurately over the right edge of the wind arm. (3) The travel arm (right edge), when used, is set for the travel-reference number as received from the tally on the plotting board. (4) Set the azimuth-correction scale so that the travel-reference number is under the normal of the deflection scale. Then set the T square so that the point of the scale corresponding to the range as called off from the plotting board, will be accurately over the edge of the travel arm. The beveled edge of the T square then indicates on the deflection scale, the deflection to be used on the sight in Cases I and II, and is called out and transmitted to the guns by telephone and telautograph. The beveled edge of the T square also indicates on the azimuth-correction scale, the correction to be applied to the gun arm center of the plotting board, when Case III is used.

When using Case III, and when the time required to lay the guns is greater than one observing interval, it is necessary to use a multiplying

scale, which can be attached to the semicircular brass on the platen. These scales are intended for use with either 15- or 20-second intervals. When the multiple scale is used, instead of setting the azimuth-correction scale to the same reading as that of the travel arm for travel, it should be set to the reading of the multiple scale used, in which case the operations will then be the same as described above.

For use during sub-caliber practice, a special leaf scale and scale arm for the T square are used, which, when in place, permit of the same operations of the board as in the regular drill.

MORTAR DEFLECTION BOARD

The mortar deflection board is shown in Plate XXVIII.

It consists of a cylinder on which are numbered, consecutively and horizontally across the cylinder, azimuths from 1 to 21 degrees, from 11 to 31 degrees, etc., the last series running from 351 to 0 degrees and then to 11 degrees.

The subdivisions of degrees to five one-hundredths (0.05) of a degree are indicated on the azimuth subscale. The cylinder is revolved by turning the azimuth wheel or head and any desired series of azimuths brought into the slit in the drum shield.

On the carriage immediately below the azimuth subscale is the drift scale mounted on the drift-scale slide. The carriage is moved by turning the main traversing wheel. This carriage has on it a pointer for setting to any azimuth on the subscale.

The elevation knob operates a carriage carrying the two pointers for setting the elevation on the drift scale and for indicating the corrected azimuth on the subscale. The "pointer" may be set for any arbitrary correction on the deflection scale by turning the milled head screw.

The operation of the board is as follows:

The operator (No. 4) sets the small pointer to the elevation called out by the plotter; he then brings the proper degrees on the cylinder into the slit in the drum shield and sets the pointer for the subscale to azimuth of the set-forward point as called out by the assistant plotter.

The corrected azimuth of the set-forward point is then indicated by the corrected azimuth pointer.

The pointer for the deflection scale should be set at normal or 3 degrees unless it is desired to make some arbitrary correction as the result of the observation of fire.

THE WIND-COMPONENT INDICATOR

The wind-component indicator is an instrument used to determine, mechanically, the two components of the wind; that is, the component of the wind which affects the range, and that component which affects

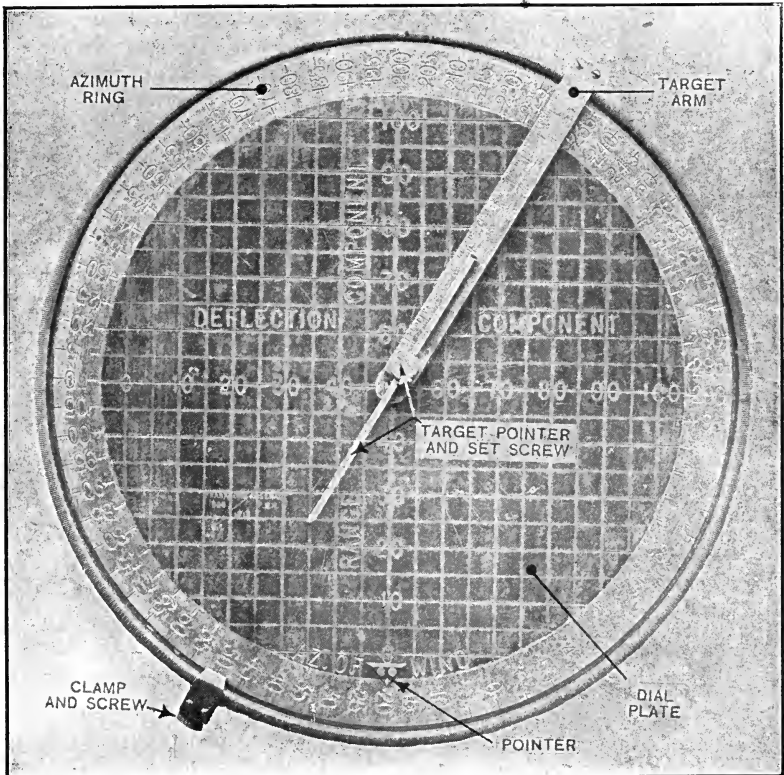

FIG. 52.—Wind Component Indicator.

the deflection correction. The component affecting the range is used on the range board. That which affects the deflection is used on the deflection board.

The instrument is shown in Fig. 52, and consists of a *dial plate*, on the face of which are reference numbers for the range and deflection components, marked with their corresponding lines. The reference numbers read from 0 on the left to 100 on the right, and from 0 at the bottom to 100 at the top, with 50 in the center. The dial is intended

to be held in a vertical position by means of the arm which is fastened to the back of the dial in such a manner that the dial itself will not turn, and in this way the figures on it will always be right side up. It is usually mounted convenient to the plotting board, and where it can be seen by the range and deflection computers.

Around the dial is a movable *azimuth ring* graduated and numbered clockwise for every 5 degrees, which can be set so that the azimuth of wind *pointer*, on the bottom of the dial, points to any required degree. It can be clamped to the dial in this position by a clamp screw immediately behind the azimuth of wind pointer.

The *target arm* is mounted about an axle so that it may be rotated, and embraces both the dial and ring. It is also bent in such a way as to allow it to pass over the azimuth-ring clamp screw. It also has a clamp screw by means of which it can be clamped at any desired azimuth.

The *target pointer* passes through a slot in the squared projection near the base end of the target arm, and is set to indicate any velocity of the wind from 0 to 50 miles per hour, as shown from the indicator of the aeroscope. It also has a *set screw* by means of which it can be secured at any velocity.

To Use the Board.—The operator (generally the assistant plotter) first sets the target pointer on the target arm to the velocity of the wind, as indicated on the aeroscope, or received over the telephone from the meteorological station. The azimuth ring is then set so that the pointer at the bottom of the dial plate will show the azimuth of the wind as obtained from the same source. The target arm is then set so that its (graduated) edge shows the azimuth of the target on the azimuth ring, as indicated by the gun arm of the plotting board, and it is necessary that this target arm be moved to the azimuth of the target whenever a reading is taken. The position of the point of the target pointer on the dial plate then indicates the two components of the wind which are to be used for correction purposes on the range and deflection boards. If the velocity of the wind or its direction should change, the component indicator should be reset and new components determined.

Taking Fig. 52 as an illustration, the range component as indicated is the reference number 25, while the deflection component as indicated is the reference number 35.

AEROSCOPE

The aeroscope is a step-by-step dial telegraph used for sending data from the meteorological and tide stations to the several primary stations of a battle command.

The apparatus consists of the meteorological controller, shown in Plate XXXI, which is mounted in the meteorological station, the tide controller mounted in the tide station, and the meteorological and tide indicators, shown in Fig. 53, which are mounted in the various primary stations.

The mechanism of the indicator consists of a wheel which is rotated in either direction by the action of electromagnets operated by the making and breaking keys of the controller. The shaft on which the wheel of the indicator rotates carries a pointer, which, by its position on a suitably graduated dial, indicates the proper data.

TIME-INTERVAL CLOCK

The time-interval clock is shown in Plate XXXII, it is installed in each primary station of a battery, fire or mine command. It is used to operate the time-interval bells in the stations and emplacements. The bells for any command ring in unison at either 15- or 30-second intervals. (Some of the first clocks installed ring bells on 15- and 20-second intervals).

The clock is spring-actuated and is provided with an arrangement of hands which is the reverse of those of clocks in common use, the second hand being mounted centrally and sweeping over the whole face of the clock, while the hour hand and minute hands are mounted at the point usually chosen for the second hand. It has three small wheels mounted on a shaft, two of which are notched so as to cause steel pawls to drop down and make three electrical contacts one second apart, which give the three distinct strokes to the bell. The interval depends upon the pawl and wheel used. The pawls are lowered to the wheels by means of a rod, the position being indicated on the face of the clock. To facilitate setting the bells at the primary station, secondary station and battery in step, a starting and stopping button is provided; this button is connected to a light spring which acts on the escapement wheel, stopping and starting the same.

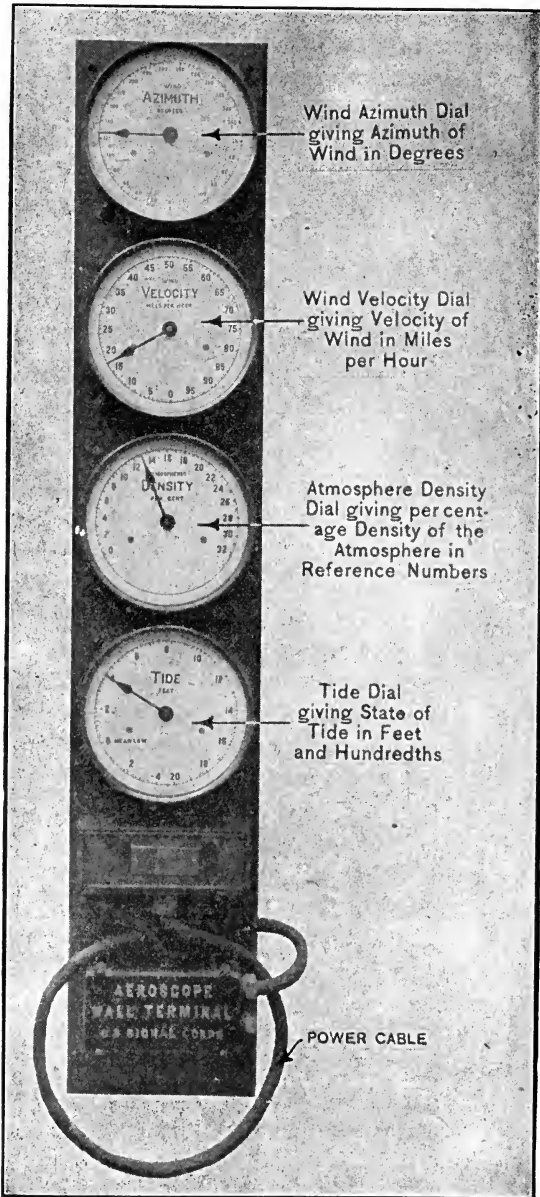

FIG. 53.—Aeroscope Indicator.

THE INTERRUPTER

The interrupter is shown in Plate XXXII. It is a form of buzzer arranged to provide comparatively 'slow interruptions of the time-interval bell circuit. The coil of the interrupter is in shunt across the signal circuit and its armature is provided with an auxiliary break, which causes the armature of the single stroke bells to vibrate in unison with it.

Interrupters are mounted on brackets in the primary base-end stations.

THE TELAUTOGRAPH

The telautograph is shown in Plate XXXII. It is an electro-mechanical instrument which transmits and simultaneously reproduces handwriting or sketches at a distance.

In the coast artillery service these instruments are used to transmit data from the plotting rooms of the primary stations to the gun emplacements and mortar emplacements.

The telautograph equipment for a battery consists of a transmitter mounted in the plotting room, a receiver mounted within view of a transmitter, as a " pilot " or guide receiver, and several receivers, usually two, mounted in moisture-proof cases and installed on the gun carriages at the battery or in an emplacement booth. The instruments are connected to the line wires in series, the line currents passing through all the receivers in turn, and all receivers write the same message simultaneously. Three line wires are used, one called the " right line," which operates the mechanism of the right side, and one called the " left line," which operates the mechanism of the left side. The third wire carries the current which actuates the pen-lifters and relays; this is called the " pen-lifter line."

The instruments require 110 volts direct current and each uses about one ampere during actual operation. This power is obtained from a storage battery over separate power leads and is independent of the emplacement lights or motors.

Messages written on the transmitter are reproduced upon the pilot receiver and similarly on all the outlying receivers, the pens moving in unison with the transmitter pencil. The method of switching the power on and off at the transmitter operates the paper shifting magnet in all the receivers.

THE TELEPHONE

In addition to using the telephone properly it is important that the operator should have sufficient knowledge of the theory and general construction of the types of telephones used in the seacoast service to correct minor defects or at least determine where the troubles lie in order to make intelligent report to those charged with their repair.

Anyone can use a telephone, with but little practice, but to do so accurately and with such certainty necessary in coast artillery work requires careful instruction and constant training.

The standard telephone system now used in fire-control work is technically known as the composite, common and local battery system. The several types of instruments are shown in Plate XXXII and the diagram of their circuits is shown in Fig. 54.

The theory of the telephone may be briefly stated as follows:

The act of speaking produces sound waves of varying intensity which fall upon the drum of the ear and are recognized by the auditory nerves as speech. If these sound waves instead of falling upon the ear drum, strike against a thin diaphragm such as that found in the transmitters of the ordinary telephones, these vibrations become electrical and are capable of being reproduced at the other end of the line, that is, in the receiver of the distant telephone.

Referring to the diagram, Fig. 54, when the receiver r is removed from the hook h current comes to the line through the retardation coil C , over the line a , through the induction coil S , through contact of the hook switch v , through the connection n , through the transmitter t , through the connection e and back over d through the retardation coil and to the other pole of the battery.

Changes in resistance of the transmitter due to the sound waves of the voice striking the diaphragm cause corresponding changes in the current on the line, and a change of potential (pressure) at the terminals of the retardation coil inductively affects the coil T of the induction coil, this induced current passes through the receiver r and the operator hears himself speak; the current also goes through the transmitter, the condenser and back to coil T . The same effect as that produced in the home receiver is produced in all receivers on the line, the current in the distant induction coil being altered by change of potential at the retardation coil.

The condenser k is introduced into the circuit to strengthen the transmission and produce clearness of speech. Changes in the transmitter

resistance produce corresponding changes in potential between the transmitter terminals, through l to e on one side of the condenser and through the receiver and coil T to f on the other side. The condenser will there-

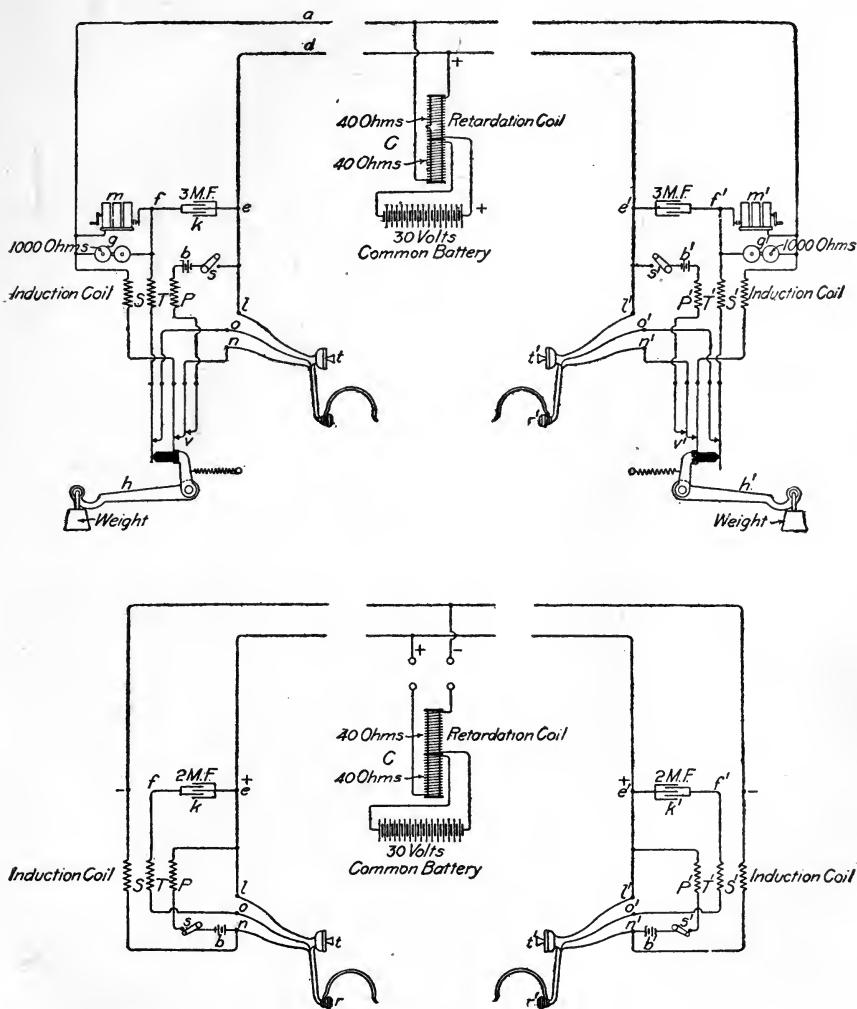

FIG. 54.

fore be charged and discharged through the coil T , producing current ripples which will inductively affect the coil T , and tend to amplify corresponding changes of current in T .

In case of failure of the common battery the switches at S and S' are closed, putting the local battery circuit through the primary coil P , which then acts inductively on S as a secondary and the induced current passes to the line through the distant coil S' , and acts inductively on the coil T and the receiver circuit.

The magneto m and the ringer g are in parallel on one side of the line a , with the condenser k between them and the other line d . The magneto is connected to the line through the condenser because the heavy generator windings of comparatively low resistance would otherwise tend to cause the armature to "stick" when the crank is turned. This "sticking" is due to the direct current on the line which would pass through the armature of the magneto.

OPERATION

Selection of Operators.—The operator should be of a non-excitable disposition, so as to speak slowly and distinctly at all times. He should articulate well and *never speak too loud*. No person should be selected as operator until he has been tried on a line that is not working very well, for a test of the suitability of his voice for the work. Too much stress cannot be laid on the necessity for care in the selection of telephone operators.

If each operator takes an interest in the instrument he uses and applies proper care, the efficiency of the system will be increased twofold. The talking sets should be hung in their proper places at the completion of drill; hook retaining springs attached; cords kept clear of possible interference; and a prompt report made of any defect found.

To Open Station.—Care must be taken in this ordinary operation in order to detect any evident trouble before the work begins and thus avoid interruption. The following simple rules should be observed:

(a) Look over the connections to see if none is loose. These are the two connections to line and the three where the head set is attached at terminal block, the battery terminals, if local battery is used.

(b) Release the retaining spring and *see that the hook goes all the way up* or till good contacts are made at v .

(c) Put the head set on and close the two-way switches to CB and then to LB . In both cases a distinct click should be heard. Leaving the switch on the common battery, lower and raise the hook switch when the same click should be heard. Experience will teach the operator how loud this click should be. A slight scratching in the transmitter should be heard in the receiver.

(d) Hold hook down and ring the station and wait for a reply (unless the phones are connected through a central), in which case no ringing is necessary.

(e) Place the mouth near the mouthpiece of the transmitter and call the other station by name. Wait for a verbal answer to the call before sending any message. A little delay at this stage may result in a material gain of time.

Using the Phone.—Although a simple operation, too much care cannot be taken to do this properly.

(a) *Never shout*, as this causes a rattling of the diaphragm with a consequent jumbling of the sounds.

(b) *Place the mouth at a distance of from one to two inches from the transmitter and speak slowly and distinctly*, not slurring over words or syllables, but enunciating clearly each sound. The distance of the mouth from the receiver is determined by practice and depends on the character and carrying power of the voice.

It is not desirable that the air expelled from the mouth in the act of speaking strike the diaphragm, as this may set up vibrations different from those due to the sound wave and cause confusion.

To prevent this the voice should be directed to one side of the transmitter, or the mouth may be placed at the side of and touching the transmitter opening and the voice directed across it.

(c) Unless absolutely necessary, do not use any unusual words, adhering to those heard every day about the guns.

(d) Endeavor to complete every sentence without break or change. For this reason every *important* message should be written and the operator should read it before beginning to transmit it.

(e) Send numerals singly, thus 4370 is sent four, three, seven, zero. The use of the letter O for a zero may sound like the numeral four. Mistakes due to this are known to have occurred.

Enunciate clearly and speak slowly, as each word stands by itself; the adjacent words do not, as in a message, help to determine one not understood. If it is necessary to repeat, use more care as to *distinctness* and *do not yell*.

If necessary, a numeral not understood may be accentuated by counting up to it and emphasizing it. Thus if the 4 is not understood in 7 6 4 9 begin to count one, two, three, **FOUR**.

(f) In receiving, close attention is necessary; the senders should be interrupted only when absolutely necessary and the part to be repeated clearly indicated.

If the sender begins to speak too loud, the receiver must caution him

to speak lower and continue to do so until the best pitch of voice is obtained.

All unnecessary conversation must be absolutely prohibited if satisfactory results are desired.

To Close Station.—Repeat to the other stations what has been ordered, then hang up the head set on the hook and open the switch in the local circuit if it has been used. If the head set is not to be hung on the hook see that the retaining spring is made fast to insure the breaking of the contact at *v*, Fig. 54:

TESTING

Remarks.—Experience is the best guide in quickly locating and correcting faults in the telephone, but a familiarity with the parts of the phone and what each is supposed to do, together with a few rules of procedure, coupled with a primary knowledge of electrical principles, will enable a novice to locate trouble even though he cannot cure it.

General Principles.—It is evident that the field of the trouble can always be narrowed down considerably by disconnecting the phone from the line. If, on so doing, the trouble disappears it must have been in the line. In any case of trouble look carefully, but rapidly over the whole phone, as the cause is sometimes quite evident to the eye, particularly if it is a disconnected wire or a loose joint. Failing to see the trouble, proceed with the operator's test.

The troubles generally lie under five heads, as given below. Each case is analyzed and the possible sources of troubles enumerated, with the tests for determining which exists. The term *indicated* is used advisedly in the tests because in obscure troubles the symptoms may be deceptive.

A. BELL IS NOT RUNG BY ITS OWN MAGNETO

Analysis—

1. Short circuit on line, or
2. Mechanical trouble in the bell, or
3. Short circuit *in* the phone, or
4. Open circuit *in* the phone, or
5. Magneto does not generate.

Operator's Test.—With the receiver on the hook turn the magneto handle briskly two or three times. If the bell does not ring and the

magneto turns hard, *i. e.*, with more difficulty than when the phone is in good order 1. (*Short circuit on line*), or, 3. (*Short circuit in phone*) is indicated and the operator proceeds as follows, trying to ring after each step:

• Inspect and see that the ends of the line and ground wires do not touch any other part after passing through the binding posts.

Disconnect the line wires, if the bell rings now, 1 (*Short circuit on line*) is clearly indicated and should be reported, but if it does not ring and still turns hard, report that 3 (*Short circuit in phone*) is indicated.

If the handle does *not turn hard* the operator takes up 2 (*Mechanical trouble in the bell*) and sees that the striker is not bound by the metallic cap over it, also that the armature can be moved by hand and that the striker will touch the gongs when the armature is so moved. The first trouble may be remedied, the others should be reported.

Proceed next to 4 (*Open circuit in the phone*) and, opening the magneto box, see if contact is made between shaft and spring when the handle is turned. The last may fail because the shaft is caught at some place, as where it enters the box, or the collar on the shaft may have slipped or the springs may be bent. The spring may be held against the end of the shaft with a pencil, during a test, to insure good contact. A spark seen at this contact indicates poor contact. If the operator cannot easily correct these faults he should report as nearly as practicable what trouble he has found.

B. BELL IS NOT RUNG BY DISTANT MAGNETO

Analysis—

1. Home phone out of order, or
2. Distant phone out of order, or,
3. Line out of order.
4. Condenser circuit open.

Operator's and Expert's Test

(a) Test for 1 (*Home phone out of order*) by detaching the line and turning the handle, and proceed as under A.

(b) Test for 2 (*Distant phone out of order*) at the distant phone in a manner entirely similar to 1 (*Home phone out of order*).

C. CAN HEAR BUT CANNOT BE HEARD

Analysis—

1. Local circuit at fault.
 - (a) Battery, (b) connections or wiring, (c) transmitter, (d) primary coil, or
2. Distant receiver out of order, or
3. Home secondary coil short-circuited.

Operator's Test.—Disconnect line wires and connect binding posts with a piece of wire, thus short-circuiting the phone. Place the receiver to the ear and scratch gently with the finger nail on the inside of the transmitter mouthpiece. If this is distinctly heard the local circuit and receiver are all right.

If no sound results put the receiver to the ear, lower and raise hook, also open and close the two-way switch. If a distant click is heard for each of these, *the local circuit is all right*, but the *transmitter may not be in good order*, and a report should be so made.

If no sound results, make sure that the switch contact is good, on *CB* and *LB*, that the pivot is not loose, that contacts at *v* are good, that the connections at battery terminals are good.

(*Distant receiver out of order*). The operator at the distant phone should try the tests above given for home circuit. If these give no sound in his receiver he should try another receiver, if one is available. He may try a new cord or substitute pieces of wire for it.

D. CAN NEITHER HEAR NOR BE HEARD

Analysis—This indicates general trouble.—

1. In the phones, or
2. In the line.

Operator's Test.—Go over the phone carefully, looking for poor contacts as where an insulated wire is put in the binding posts; binding posts not screwed down tight; ends of wires passing through post and touching other parts; contacts at cells and condition of cells as noted before. Disconnect the line wires and test out phones as indicated. If there are fuses in the line see that they are not burned out. If no trouble is found to exist when the line is disconnected report line out of order.

MERCURIAL THERMOMETER

The temperature of the air is measured by means of a mercurial thermometer. This instrument consists of a glass tube having a very small bore, terminating in a bulb, and containing mercury.

It is founded on the principle that changes of temperature in bodies are accompanied by proportional changes in their volumes or dimensions. When the temperature rises, the mercury in the bulb expands more than the glass and rises in the tube; when the temperature decreases the mercury contracting more than the glass descends again towards the bulb. The changes in temperature, to which the thermometer is exposed, will therefore be shown by the rising and falling of the mercury in the tube.

In order to have an intelligent measure of these changes the thermometer is provided with a fixed scale. The two fixed temperatures—one of melting ice, usually called the freezing point; and the other that of boiling water under standard pressure, or rather the temperature of the steam above the surface of boiling water—have been adopted as the fixed or starting points for the graduations of thermometers. The intervals between these two fixed points are divided into spaces called degrees, and for coast artillery work these are divided into sub-spaces, called hundredths of degrees.

The Fahrenheit thermometer is marked 32 degrees at the point of melting ice and 212 degrees at the point of boiling water, the space between these two graduations being divided into 180 equal parts. The graduations being divided into 180 equal parts. The graduations extend downward to zero, and usually 10 or 20 degrees below zero.

The Fahrenheit scale is generally used in connection with coast artillery work, but readings made on the centigrade thermometer are readily converted. The freezing point on the centigrade is marked zero and the boiling point 100. It is therefore necessary, in order to convert Fahrenheit readings to centigrade, to subtract 32 degrees and multiply the remainder by $\frac{5}{9}$; or, to convert centigrade to Fahrenheit readings, multiply by $\frac{9}{5}$ and add 32 degrees. Mercurial thermometers can be relied upon down to temperatures near the point of freezing mercury, or as low as minus 38 degrees.

THE BAROMETER

The density of the air is measured by means of the barometer and thermometer. The barometer depends for its action upon the principle that air has weight. As is generally known, the weight of air will uphold a column of water the vertical height of which depends upon the height above the sea level at which the experiment is conducted.

In the coast artillery service the mercurial barometer is used principally to test the adjustment of the aneroid barometer. The latter, being quicker in its action, is used in connection with the thermometer to determine the reference number on the atmosphere board, to be applied on the atmosphere density per cent. indicator of the aeroscope.

Mercurial Barometer.—This barometer consists of a glass tube about a yard in length closed at the top and open at the bottom, which is partially filled with mercury. The tube is suspended vertically, as shown in Plate XXXI. The lower end of the tube dips into a cistern, which consists of a brass casing, including three wooden pieces fastened together by four screws in the form of a circle. The lower portion of the cistern has a leather sack, called the cistern sack, which can be raised or lowered by means of an adjusting screw. It is used to bring the surface of mercury in the cistern to a certain level before a reading is taken.

In preparing the instrument for use the top is first completely filled with mercury. As soon as it is free to do so the column of mercury in the tube sinks until it stands at a height of about 30 inches, or such that the pressure of the column exactly balances that of the atmosphere. A graduated scale of metal is attached to the glass and affords the means of reading the height of the column of mercury.

To read the barometer first read the attached thermometer to the nearest half degree and record it. Tap the barometer sharply with the finger to free the mercury from the tube. By means of the adjusting screw lower the mercury in the cistern below and then raise it until the surface exactly touches the ivory point. When the mercury is perfectly clean the proper adjustment can be made by causing the ivory point to exactly coincide with its reflected image in the mercury below. But usually after the mercury has been in use for a short time a slight film of oxide forms on its upper surface and it is necessary to determine the contact by immersing the ivory point in the mercury until a slight dimple is formed, and then slightly lower the screw until the dimple is about to disappear.

Adjust the vernier by means of the side mill-headed screw to the top

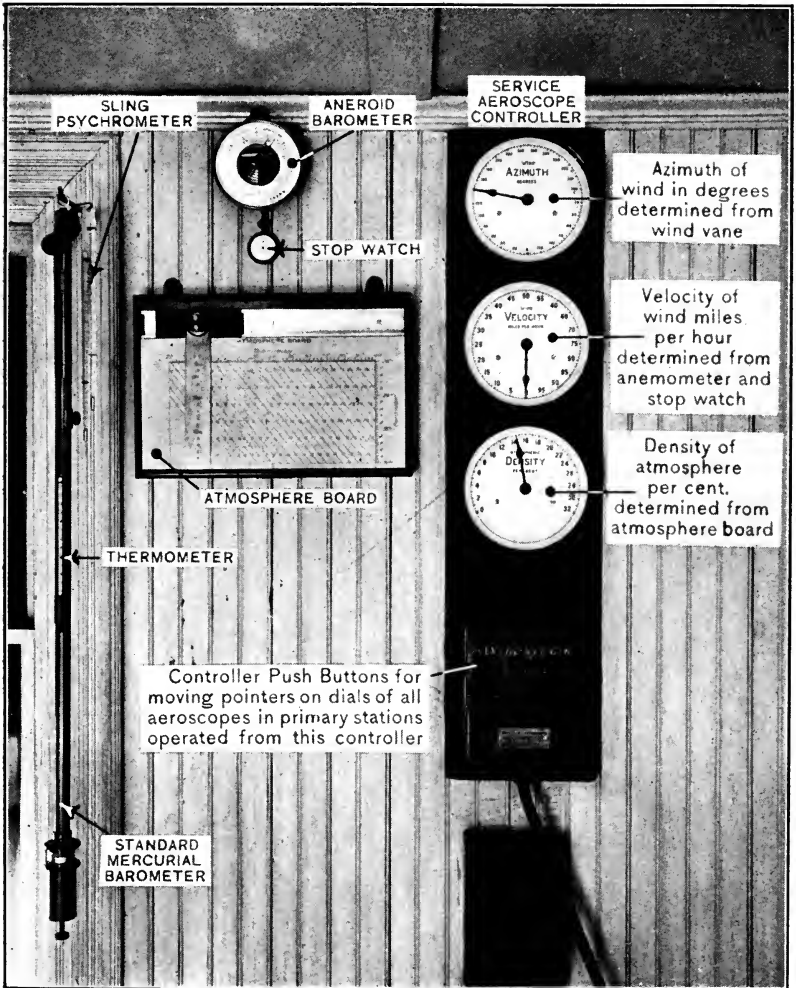

Equipment of Meteorological Station.



LIBRARY
OF THE
UNIVERSITY
OF
CALIFORNIA

of column of mercury until the zero line of the vernier and the bottom of the hind part of the vernier in rear of the mercurial column exactly coincides with the top of the meniscus, that is, tangent to the convex surface of the mercury in the tube. Read the barometer scale to inches and tenths between the zero point and the lowest line of the vernier. Find the number of the line on the vernier which coincides most nearly with the line on the barometer scale. (See Fig. 55.) This number will be the hundredths of an inch of the barometer reading. Add to this the inches and tenths and the result will be the barometer reading in

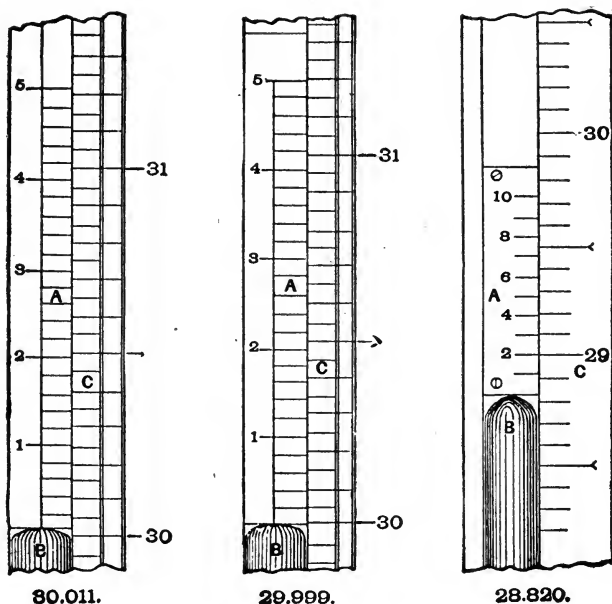

FIG. 55.

inches, tenths and hundredths. Where a line on the vernier does not exactly coincide with the line on the barometer scale the observer will after practice be able to estimate the reading to thousandths of an inch. Be careful in making the adjustments of a barometer suspended from one end only so as not to move the barometer from its vertical position.

Aneroid Barometer.—The aneroid barometer, shown in Plate XXXI, consists of a cylindrical metal box exhausted of air, having a lid of thin corrugated metal. The lid, which is highly elastic, yields to every change of atmospheric pressure and delicate springs and levers transmit

its motions to an index that moves over a graduated scale whose divisions are marked on the dial after comparison with the mercurial barometer.

All aneroids should be frequently and carefully tested with standard mercurial instruments at known altitudes in order to determine the proper correction for instrumental error. The best aneroids are now marked compensated and are practically free from errors arising from changes of temperature in the instrument itself.

One of the chief differences between the aneroid and the mercurial barometer is the fact that the aneroid acts more rapidly under rapid changes of pressure than does the mercurial barometer, and care should be taken to avoid errors due to the sluggishness of the mercurial barometer.

Aneroids are usually graduated to indicate a fall of pressure to twenty inches, which would correspond to a height of a little over 11,000 feet.

THE ANEMOMETER

The velocity of the wind is determined by an instrument called the anemometer. The type in use at seacoast fortifications is known as the Robinson type, and consists of a vertical spindle having at its upper end four horizontal arms at right angles to one another, bearing at their extremities hollow hemispherical aluminum cups whose circular rims are in the vertical plane passing through the respective arms and the common axis of rotation. The convex side of each cup faces the direction of rotation. Therefore two opposite cups have their convex surfaces facing in opposite directions. The pressure of the wind against the cup whose concave side receives the wind is greater than against the cup whose convex side receives it at the same time. Consequently, whatever the direction of the wind, the cups are caused to rotate in the same direction, each cup moving with its convex side forward.

On the lower portion of the vertical spindle there is a worm gearing into a worm wheel, and on the arbor of this wheel another worm gears into a pinion and the pinion in turn gears into the teeth on the circumferences of the dials driven by them. The mechanism is arranged to close an electric circuit at the expiration of a certain number of revolutions of the cups. In the type in use the contact is so arranged that it is closed once every 25 revolutions of the spindle, which corresponds to $\frac{1}{20}$ of a mile travel of wind, with certain corrections as the velocity rises.

The connections and general arrangement of the anemometer are shown in Fig. 56.

The rapidity with which the air moves past any given point of the earth's surface is called the velocity of the air or wind at that point. On account of the friction of the moving air in contact with the surface of the earth the movement of the air is retarded near the surface. It is estimated that the effect of this friction decreases from 20 to 50 per cent. for the first 100 feet above the earth, and gradually diminishes until its effect is nil at an elevation of 10,000 feet. For this reason anemometers are installed at the highest available point in fortifications.

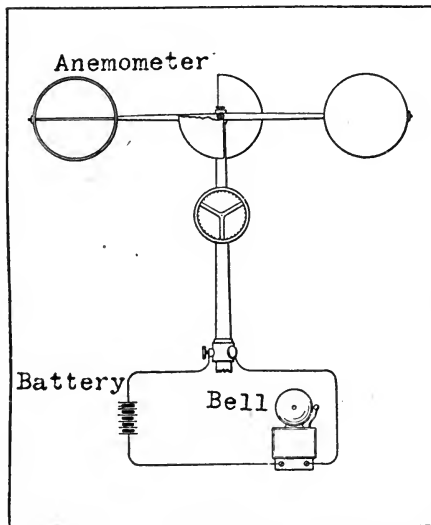

FIG. 56.

Method of Using the Instrument.—As previously stated, the approximate velocity of the wind in miles per hour is equal to 180 divided by the time between the closing of the contacts of the anemometer. An anemometer stop watch reading to $\frac{1}{5}$ second and marked on its face in red figures at the points corresponding to 40, 30, 20, 10 and 5 miles per hour is used in connection with the anemometer in determining the velocity of the wind. At the first closing of the contact which clicks a sounder or rings a bell the stop watch is started, and at the next closing of the circuit which gives the same signal the watch is stopped. The velocity of the wind in miles per hour is indicated as above stated in red figures upon the dial of the watch, or in case the anemometer stop watch is not at hand the velocity may be obtained from the following table:

Seconds Interval Between Strokes of Bell or Sounder.	Velocity of Wind, Miles per Hour.	Seconds Interval Between Strokes of Bell or Sounder.	Velocity of Wind, Miles per Hour.
2½	53	12	14
3	45	14	12
3½	40	16	11
4	36	18	9.5
5	30	20	8
6	26	25	6.5
7	23	30	5.5
8	20	35	5
9	18	40	4.5
10	16	60	3.0

THE ATMOSPHERE BOARD

The atmosphere board is used to determine the atmosphere reference numbers to be recorded on the density dial of the aeroscope indicator. It is shown in Fig. 57.

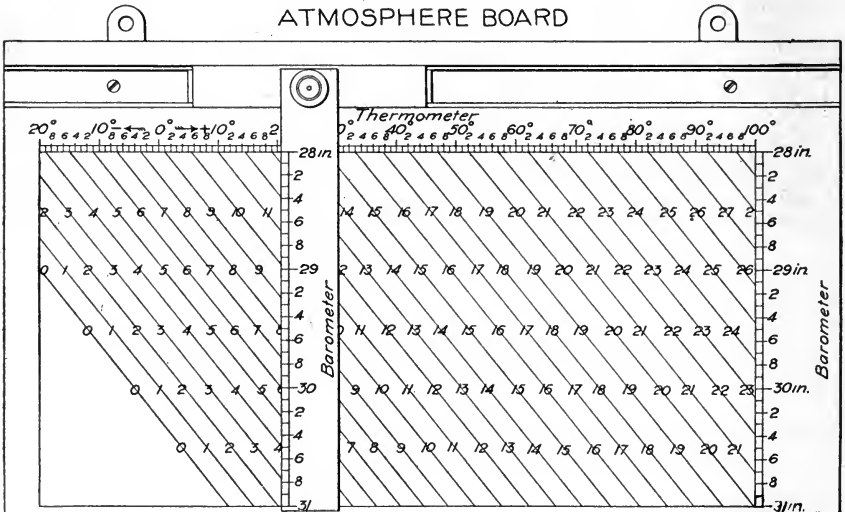
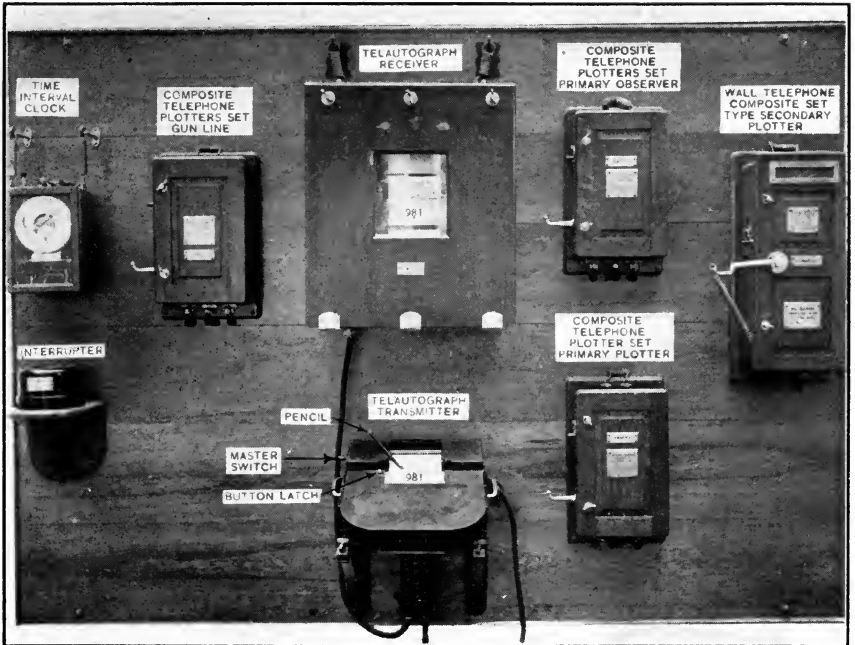

FIG. 57.

The board consists of a frame upon which a graphic table is mounted. Along the top edge of the frame a T-square fits into a groove which runs the length of the board. The arguments of the table are barometer and

PLATE XXXII



Instrument Panel, Fire-Control Equipment for Primary Station.



LIBRARY
OF THE
UNIVERSITY
OF
CALIFORNIA

thermometer readings. The thermometer graduations are horizontal and extend along the top of the table while the barometer graduations are vertical and extend along the right side of the table, and for convenience of reading, are also placed along the left edge of the T-square. The reference numbers are indicated on diagonal lines as shown in Fig. 57.

To Use the Chart.—Assuming that the thermometer shows a temperature of 20.10 degrees and the barometer a pressure of 29.50 inches, the ruler of the T-square is moved until its left edge is made to coincide with the reading of 20.10 degrees. The atmosphere reference number will then be the nearest diagonal line cutting the barometer graduations on the ruler at 29.50. An inspection of Fig. 57 will show this diagonal line to be numbered 8. Therefore the reference number for the thermometer and barometer readings taken would be 8. This number would then be indicated on the density dial of the aeroscope.

SIGHTS

Sights for seacoast cannon are of two general classes, namely: Open Sights, and Telescopic Sights.

OPEN SIGHTS.

2.24-inch 6-pounder, Wheeled Mount.—Open tangent (front and rear) sights, affixed to the gun in the ordinary manner, are issued with these guns.

The front sight consists of a bracket and a cross-wire frame; the latter carries two wires and is assembled in the socket of the former by a stud and set screw.

The rear sight consists of a bracket, an operating knob, a pinion with a sleeve, a standard, a cross arm and screw, and a cross-wire frame. The bracket is slotted for the standard and, at right angles, for the pinion and sleeve. The sleeve and the knob are assembled to the pinion and are held in place by the pinion wheel and a spring that abuts against a shoulder on the knob and a collar fastened at the outer end of the pinion.

The sleeve is assembled to the bracket by a set screw, and has a serrated surface that fits a corresponding surface on the knob, thus preventing rotation of the latter. The knob is ordinarily held against the sleeve by the spring, but may be moved along the pinion and then

rotated, a spline on the pinion and a corresponding groove in the knob causing them to rotate together.

The standard is shaped to the slot in the bracket, has the ranges marked on its surface, and carries a rack that engages the pinion. The cross arm is assembled to the standard by a stud and pin, is shaped to receive the base of the cross-wire frame, has two bearings for the cross-arm, and is graduated to mark deflections.

The cross-wire frame carries four wires arranged to give a small square aperture in the center. The lower part of the frame has a zero line, is made to fit into the cross arm and is threaded for the screw. This last is fixed in position, and when rotated causes the cross-wire frame to move to the right or left.

2.24 inch 6-pounder Barbette Mount (Driggs-Seabury), Model of 1898. The open sights for this gun, with the exception of minor and unimportant details, are the same as those given for the 4-inch Driggs-Schroeder gun.

Three-inch, 15-pounder.—The open sights for these guns are the bar and drum pattern, shown in Plate XV.

Four-inch Barbette Carriage (Driggs-Schroeder).—The open sight for these guns consists of a front sight screwed into its seat and held by a set screw. The head of this sight is a hoop, the single cross wires and sighting point projecting from the top of the hoop for rough aiming. The rear sight is a general pattern of bar sights moving in a sight box bolted to the face of the breech. The right part of the rear face of the bar has a vertical rack cut in it throughout the length, in which works a small pinion controlled by a small hand wheel. The shaft of the hand wheel carries a ratchet which normally engages in a pinion-fixed ratchet in the wall of the sight box, being held in place by a spring. The bar is graduated in yards for range, full charges, and set at a vertical latent angle to give an automatic correction for drift. To correct for wind or speed of target the head of the sight carries a cross bar actuated by a worm, the cross bar being graduated in minutes.

4.72-and 6-inch Armstrong Q.F. Guns.—The sights are of the bar and drum pattern, shown in Plate XV, and consist of a carrier, which is fixed to two bosses on the mounting by means of two T-headed bolts; a sight bar with rack and front and rear sights; a worm wheel, pinion and drum with graduated crown metal ring attached to the circumference. The ring is graduated in yards. The drum is fixed to the spindle by means of three screws, so as to be readily moved round for adjustment.

In order to adjust the ring, slack the screws, run the sight by means of the worm gear to the "point blank" position, then move the ring

around till the zero point is in line with the pointer, then tighten the screws.

The sight bar is fitted to take the electric night sights. The crosshead on the sight bar gives 2 degrees deflection, right and left, and is fitted with a screwed deflection window of H form, with a horizontal wire stretched across.

The fore sight is furnished with an upright blade, terminating with a spherical bead.

Five-inch Barbette Carriage (Model of 1896).—Sights for this carriage consists of a bead front sight and a small ring set in a window for a rear sight. The front sight is inserted in the front-sight bracket and the bead is protected by a ring. The rear-sight window is set in a crosshead, giving 2 degrees deflection right or left, the smallest graduation being 10 minutes. The crosshead is on the upper end of a stem curved so that in elevating the rear sight moves through the arc of a circle, the center of which is the bead of the front sight. Rack teeth are cut in the front face of the stem and are engaged by a worm operated by a small hand wheel in the rear of the sight bracket. This bracket carries a drum graduated in yards and arranged to be easily adjusted so as to bring its zero to the pointer when the sight is brought to the "point blank" position.

For 8-, 10-, and 12-inch B. L. Rifles.—All of these guns are fitted for axial sights and are issued with screw holes filled with brass plugs. The axial sights are only issued for guns mounted on barbette carriages. These sights consist of a simple notched rear sight without any means of elevation or deflection, and a point front sight.

TELESCOPIC SIGHTS

Three-inch (15-pounder) R. F. Gun on Masking Parapet Mount.—The sights furnished with this mount are the telescopic sight, model of 1899, Type A, as shown in Fig. 58, and the night sights.

The telescopic sight differs materially from all previous models. Instead of being pivoted to a trunnion casting by which it may be adjusted in its seat or bracket and which permits elevation to be given, the telescope tube consists of a substantial bronze casting provided on its under side with two lugs. These lugs are about 4 inches apart and rest on and inclose the ends of a flat-machined seat on the shoulder bar. The sight is secured in place by two thumbscrews, one on the left side of each lug, which bear against the undercut side of the seat. There are no levels and no movement of the telescope with reference to its seat is

possible. The telescope is used simply as a more effective open sight, elevation being given by movement of the shoulder bar.

The interior and exterior deflection scales and the micrometer head on the deflection screw are practically the same as in the model of 1898, with the exception of the graduation. Both scales are graduated to 2 degrees 30 minutes on each side of zero, the smallest division on the interior scale being 6 minutes and on the exterior scale 30 minutes.

One revolution of the micrometer head is equal to 1 degree. The 6-minute readings on the outer scale are obtained from the ten divisions on the micrometer head.

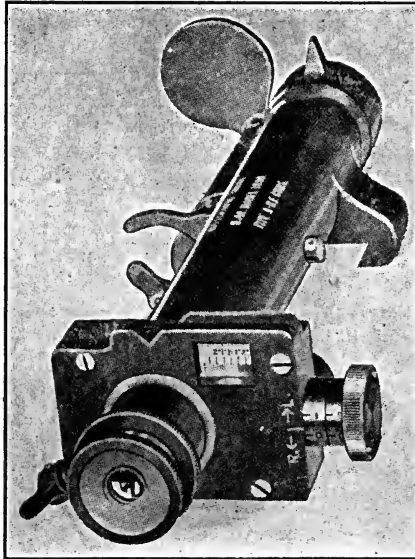

FIG. 58.—Telescopic Sight, Type "A," M. 1899, for R.-F. Guns.

The telescope is provided with a set of open sights to serve as a finder. The object glass is protected by a heavy bronze disk attached to a spindle about $3\frac{1}{4}$ inches long, which passes through a projection on the left side of the telescope tube parallel with the axis. The rear end of the spindle is fitted with a short lever arm by which the disk can be rotated to uncover the objective.

Data for Telescope

Field of eyepiece	26 $\frac{1}{4}$ °
Power of telescope	3 $\frac{1}{2}$
Field of view	7 $\frac{1}{2}$ °
Diameter of objective	1 $\frac{1}{8}$ inches

As in the case of the model of 1898 the telescope is non-inverting, but the erect image is obtained by the use of an erecting eyepiece instead of prisms. This eyepiece consists of three plano-convex lenses mounted in a brass tube which is screwed into the main tube from the rear. A capstan-headed screw on the right side of the main tube screws into a collar in the inner tube and determines the position of the latter. The sliding diaphragm containing the cross hairs is placed in rear of this eyepiece.

Two-inch Telescopic Sight, Model of 1902.—This sight is shown in detail in Fig. 59. Its general description is as follows:

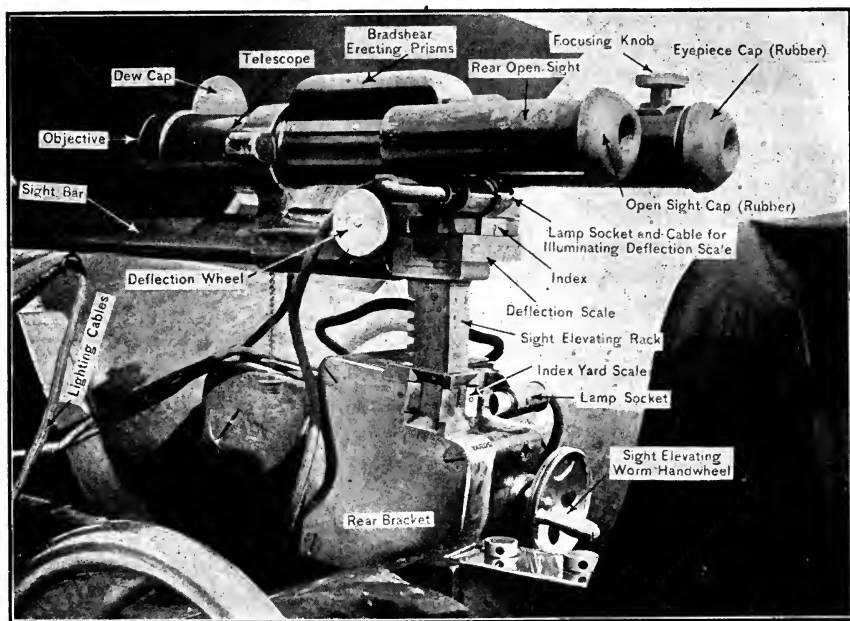

FIG. 59.—Combination Open and Telescopic Sight, 2-inch, M. 1902. For R.-F. Guns.

The sight is attached to the cradle by means of a front and rear bracket. The front sight bracket is securely keyed to an extension of the left trunnion of the cradle, and locked by a screw. *It is not intended to be removed except when necessary to protect it from injury in dismantling the shield or cradle.* The rear-sight bracket is attached to the elevating rack bracket by means of two 0.75-inch conical head screws and one 0.75-inch headless screw. It is further secured by a horizontal spline and a vertical key. The front-sight bracket is bored vertically at the

upper end to receive the sight post. A keyway is provided in the bracket and a key in the sight post to prevent the latter turning in the bracket, and the sight post is provided with a nut and locking pin at its lower end. At its upper end the sight post is hinged to the sight pivot by means of a bronze hinge pin 0.81 inch in diameter, screwed into one of the prongs of the sight post and secured by a taper pin. *This hinge pin forms the axis of rotation of the sight bar in elevation and should never be removed from the sight post.*

The upper end of the sight pivot forms a seat for the sight-bar head, which is drilled to slip over it and is secured by a nut with a taper pin so as to be free to revolve around the axis of the pivot. *The sight pivot, therefore, forms the axis of rotation of the sight bar in azimuth and should never be removed from the sight bar except when absolutely necessary for cleaning purposes.*

Rear-sight Bracket.—The rear sight bracket is a steel forging which, with its cover, a bronze casting, is milled out in such a way as to form bearings for the mechanism necessary to elevate and depress the sight. About half of these bearings are in the steel bracket and half in the cover. Near the top the sight bracket is bored to a depth of 1.752 inches and a diameter of 2.35 inches. The center of this bore is further drilled to a depth of 0.66 inch and a diameter of 0.625 inch, the object being to form a bearing for the sight-elevating pinion and wormwheel. This part, which is of bronze, in one piece, is drilled 0.625 inch diameter on the pinion end. The gear cover is milled to a diameter of 2.35 inches in line with the bore of the sight bracket, but in the gear cover a projection 0.623 inch in diameter and 0.877 inch long at the center of the bore is not cut away and forms the left-hand bearing of the sight-elevating pinion and wormwheel.

A horizontal slot 0.8 inch wide and 1.9 inches deep is cut through the rear-sight bracket near its middle part. Two bronze bushings suitably fitted into this slot form bearings for the sight-elevating worm which gears into the worm wheel above described. A spline on the gear cover also fits into this slot and helps to keep the gear cover in position. The sight-elevating worm shaft has a hand wheel at each end.

A slot on the proper radius is cut in the gear cover for the sight-elevating rack. At the upper end of this slot, at the rear, and on the left-hand side the gear cover is cut away to make the graduations on the sight-elevating rack visible.

Sight Holder.—The sight holder, of bronze, is riveted to the rear end of the sight bar and forms an extension of it. Directly above the sight bar is the seat for the telescope, consisting of two hinged ring clamps,

the forward one of which is provided with a slot to take the spline of the telescope. An extension of the sight holder to the left is bored and tapped to receive the peep-sight tube, consisting of a bronze tube with an interior diameter of 0.812 inch. The peep-sight plate is drilled at the center 0.125 inch in diameter, forming the peep. It rests against a shoulder of the tube, being held in position by a ring screwed into the end of the tube. It is held and adjusted laterally by three screws through the walls of the tube bearing against its edges.

Front Sight.—The front sight consists of a ring carrying two German silver cross wires and attached to a stem fitted with a bayonet joint, by which it is attached to the sight-bar head.

Telescope.—The telescope consists of a brass tube about 16 inches long and 1.78 inches in exterior diameter, except at the forward end, where the tube is enlarged to an exterior diameter of 2.25 inches, and at the two bearing surfaces, where the exterior diameter is 1.875 inches.

The object glass, 1.75 inches in diameter, held in a brass ring with a knurled head, is screwed into the front end of the tube.

The eyepiece consists of two lenses held in brass rings screwed into the ends of a brass tube 2.65 inches long, which slides in the rear end of the main tube of the telescope. This short tube is slotted out at the top and is provided with a rack placed at the side of the slot. The rack engages with a pinion provided with a knurled head and having its bearing in the main tube of the telescope. By turning the knurled head the eyepiece is adjusted for focus.

Horizontal and vertical cross lines are etched upon the forward lens of the eyepiece and scales for horizontal and vertical deflection.

The horizontal scale is graduated to 0.05 degree and numbered to 0.2 degree. The vertical scale is graduated to 0.001 of the range and numbered to 0.004 of the range.

The distance between the centers of the bearing surfaces of the telescope is 6 inches. The forward bearing surface is provided with shoulders to prevent longitudinal motion in the telescope carrier and a spline to prevent rotation. Between the two bearing surfaces the top of the main tube is slotted out to permit the placing of a set of Brashear erecting prisms. These are held in an adjustable brass frame and are covered by a cap which is screwed to the main tube by six screws.

Both the object glass and eyepiece are protected by swinging covers.

For night illumination a small tube for the lamp enters the main tube on the right-hand side just forward of the front bearing. Just forward of this a mirror is provided, which, by means of a knurled head,

can be swung in or out of the center line of the telescope. Arrows on the knurled head and on the telescope indicate when the mirror is in the axis of the telescope.

Two-inch Telescopic Sight (Model of 1906).—This sight is designed for use on the 15-pounder R.F. gun, model of 1903. It consists of a telescope, sight bracket, cradle, with the open-sight attachments consisting of the sight shank, deflection worm box and head of shank, range drum, gear case cover and cover for range box drum, elevating worm, the fulcrum, the yoke, deflection scale, elevating-gear shaft and necessary lighting cables.

The sight bracket is bolted to the carriage at its lower end. The cradle is assembled at the forward end of the front-sight bracket by means of the fulcrum, the fulcrum axis for bearings in the two sides of the front sight bracket permitting rotation for elevation and deflection, and the fulcrum is a short vertical shaft on its outside to which the forward end of the cradle is assembled so as to allow rotation in azimuth. At the rear end the cradle is assembled to the sight shank by means of the sight-shank head and the deflection worm. The latter is seated in the sight-shank head, which thus forms the deflection-worm box and meshes into a worm segment cut in the cradle. The front and rear faces of the deflection box and the head of the sight shank are arcs of circles having their common center on the axis of the vertical shaft fulcrum.

The elevation of the sight and the rotation of the range drum are accomplished by the elevating gear, consisting of the elevating worm, elevating-gear shaft with its worm gear and spur gear, the latter two being in one piece. The elevating worm engages the worm gear and the spur gear engages the sight-shank rack. The piece on which these two gears are mounted is cut on a square section of the elevating-gear shaft, which is also the range-drum shaft, the range drum being mounted and held in place by the friction of a washer bearing against the drum and the friction of the drum on a shoulder of the shaft. A German silver ribbon spring about eleven feet long is secured at one end to the elevating-gear shaft and is wound several times around the shaft, and has the other end secured to the gear-case cover.

By rotating the elevating worm the elevating-gear shaft is moved, adding to or releasing the tension on the spring, at the same time depressing or elevating the cradle by means of the sight shank also rotating the range drum. The object of the spring is to equalize the force required to depress or elevate the cradle. A range pointer is attached to the cover, which is bolted to the sight bracket. The elevation scale is of German silver dovetailed into the rear face of the sight shank, and

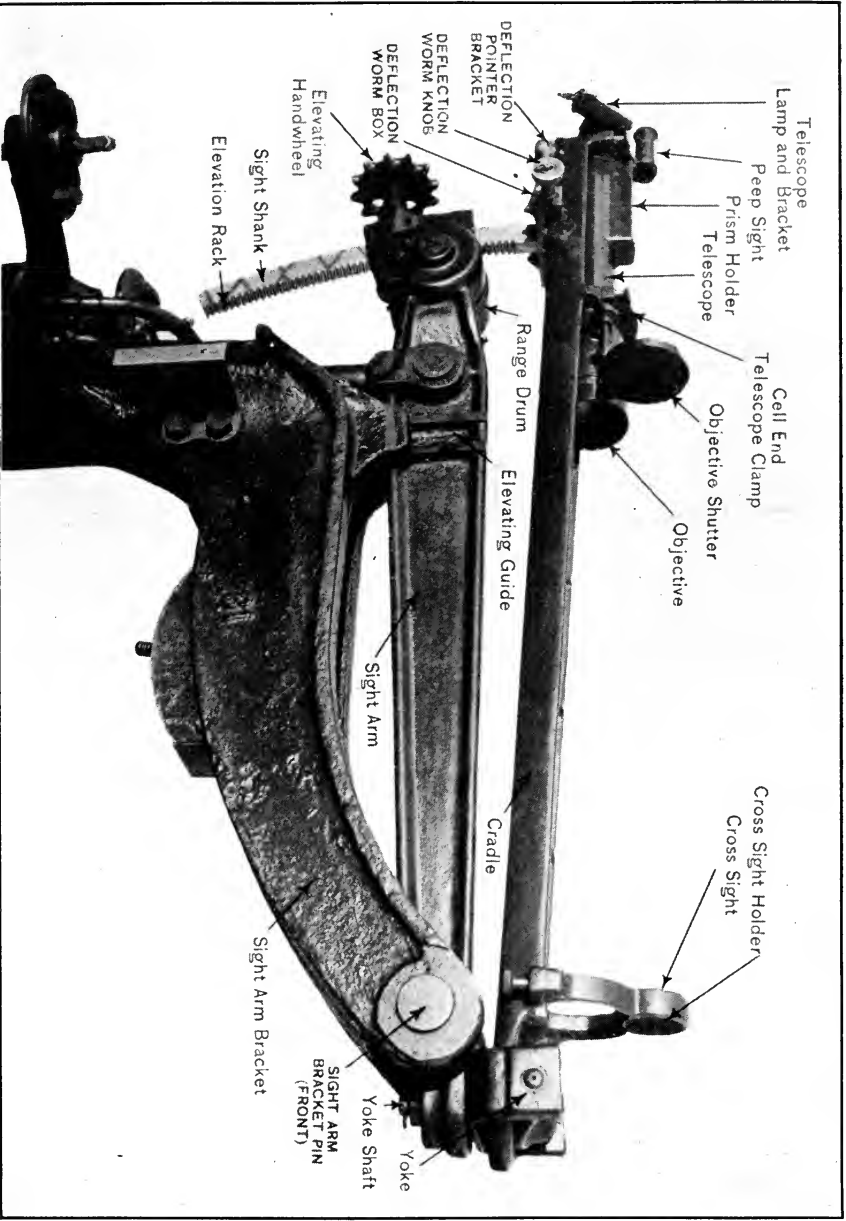

3-inch Telescopic Sight, M. 1904. Cradle, Sight Arm, Bracket, etc.



LIBRARY
OF THE
UNIVERSITY
OF
CALIFORNIA

reads from zero to 16 degrees, the least reading being 6 minutes, or .10 of a degree.

The range pointer is a piece of German silver dovetailed into the gear-case cover just opposite the lamp bracket and the range-drum elevation scale. The deflection scale, of German silver, is dovetailed into the rear end of the cradle. The numbers on the scale are reference numbers, three (3) representing the original or central position of the scale. The interval between whole numbers is equal to one degree of arc. The lowest reading of the scale is 6 minutes, or .10 of a degree.

The deflection scale index is cut on a German silver plate, secured to a lug projecting from the rear of the sight shank. The principal parts of

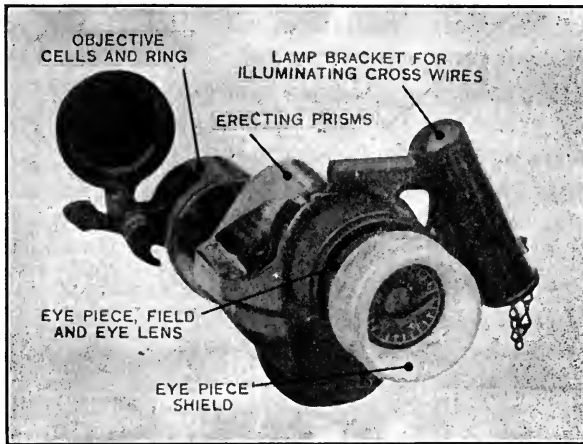

FIG. 59A.—2-inch Telescopic Sight, M. 1906, for 3-inch R.-F. Guns.

the telescope are the tube, the objective, the Porro erecting-prisms, the draw tube, cross-wire holder, the focusing sleeve, the focusing ring and the eyepiece.

The telescope is shown in Fig. 59A. The telescope is secured in position on four accurately bored projections on the cradle by the front and rear telescope clamps, each of which is machine-finished to proper bearing on the upper portion of the telescope to secure proper alignment of the optical axis and to insure the vertical wires being held vertically. The telescope has a 2-inch aperture. The magnifying power of the eyepiece is 8 and the sight has a field of $4\frac{1}{2}$ degrees.

Three-inch Telescopic Sight (Model of 1904).—This sight is shown in Plate XXXIII and is designed for use either on barbette or disappearing carriages.

Sights for Barbette Carriages.—The principal parts are the telescope, the sight bracket, the cradle, the open sights, the sight shank with deflection-worm box and head of sight shank, the range drum, the gear-case cover and cover for range drum, the elevating worm, the fulcrum, the yoke, the cables and electric lamps, the deflection scale, the elevation scale, the deflection worm and the elevating gear shaft.

The sight bracket is bolted to the carriage by means of the feet. The cradle is assembled at the forward end to the sight bracket by means of the yoke and fulcrum. The yoke shaft seats in the sight bracket and is keyed in place; the fulcrum axes have bearings in the two sides of the yoke permitting rotation for elevation and depression, and the fulcrum has a short vertical shaft on its under side to which the forward end of the cradle is assembled so as to allow rotation in azimuth only. At the rear end the sight shank is assembled between the sight bracket and the gear-case cover, being held in place by the gear-case cover and the elevating gearing. The cradle is assembled to the sight shank by means of its head (which is also the deflection-worm box) and the deflection worm, the latter being seated in the box and meshing into a worm segment cut in the cradle. The front and rear faces of the deflection box and head of sight shank are arcs of circles having their common center on the axis of the vertical shaft of the fulcrum, and the front and rear faces of the sight shank and its seat are arcs of circles having their common center on the central line of the fulcrum axes.

The elevation of the sight and the rotation of the range drum are accomplished by the elevating gearing, consisting of the elevating worm and the elevating-gear shaft with its worm gear and spur gear, the latter two being on one piece. The elevating worm engages the worm gear and the spur gear engages the sight-shank rack. The piece on which these two gears are cut is mounted on a squared section of the elevating-gear shaft, which is also the range-drum shaft. The range drum is also mounted on this shaft and is held in place by the friction of a nut on a washer bearing against the drum and the friction of the drum on a shoulder of the shaft. A ribbon spring 11 feet long and of German silver is secured at one end to the elevating-gear shaft, is wound several times around the shaft, and has the other end secured to the gear-case cover. The cover is bolted to the sight bracket. By rotating the elevating worm, the elevating-gear shaft is turned, adding to or releasing tension on the spring, depressing or elevating the cradle by means of the sight shank and rotating the range drum. The spring serves to equalize the force required to depress and elevate the cradle. The gear-case cover and the bracket serve to protect the elevating gearing, the

spring, and the range drum. The range-scale pointer is attached to the cover.

The elevation scale is of German silver, is dovetailed into the rear face of the sight shank, and reads to 6 minutes from zero to 16 degrees. The pointer is on a piece of German silver dovetailed into the sight bracket just opposite the lamp bracket for range drum and elevation scale.

Deflection is obtained by rotating the deflection worm which is seated in the deflection-worm box and meshes into a worm segment cut into the cradle where the box is seated.

The deflection scale, of German silver, is secured to the rear end of the cradle and reads to 0.05 of a degree, which equals 3 minutes, over an arc of 4 degrees, beginning with 1 degree on the right. The 3-degree mark gives no deflection. The pointer plate is secured to a bracket which is screwed to the under side of the sight shank head. This bracket has, at the rear end, the deflection lamp bracket and a lug that works in a groove in the end of the cradle.

The open sight consists of a peep sight in rear and a cross sight in front, the former mounted on the eye and telescope clamp, and the latter on the cross-sight holder. It is for use in picking up an object quickly.

Each sight is provided with three small electric lamps of about 2 candlepower; those originally furnished with the first 405 sights have a voltage of 3.75 to 4.75, and an amperage from 0.75 to 1, while those that will be used for replacements and for sights to be manufactured have the voltage from 5.5 to 6.5, with an amperage from 1.25 to 1.35. One of these lamps illuminates the cross wires, giving bright lines in a dark field, and the other two illuminate the scale pointers and adjacent parts of the scales. They are connected with the electric circuit by the cables and plug connections. The lamp that illuminates the cross wires is placed in a holder that is screwed to the eye end of the telescope tube on the right-hand side. Two small mirrors deflect the rays of light through two elongated openings cut through the telescope tube 90 degrees apart. These openings are so arranged that the light from each mirror is thrown upon the full length of the wire opposite.

The principal parts of the telescope are the telescope tube, the objective, the Porro erecting prisms, the draw tube, the cross-wire ring, the adjusting sleeve, the adjusting ring, and the eyepiece.

The telescope tube is the principal piece to which the other parts are assembled. The objective is triple, is seated in a cell that screws into the forward end of the telescope tube, and gives a 3-inch clear aperture. The Porro erecting prisms are two in number, secured in place by a bronze frame. There are no cemented surfaces, as in the Brashear-

Hastings prisms used in former types, which reduces the chance of injury, renders replacement easier, and facilitates cleaning.

The cross wires are secured to a ring by four clamps, and are at right angles to each other. The cross-wire ring is carried in a holder which is secured to the draw tube by screws. The draw tube is assembled to the focusing sleeve so as to allow longitudinal motion of the former when the focusing ring is rotated, and to force rotation of the tube when the focusing sleeve is rotated. The sleeve is screwed into the rear end of the telescope tube by a thread of tight fit, so that it is difficult to rotate. The focusing ring is seated on the focusing sleeve by a threaded surface, its motion being limited by the telescope tube in front and the focusing sleeve nut in rear. When turned, it transmits to the draw tube and reticule its longitudinal motion only.

The eyepiece consists of the eyepiece tube, the field lens, the eye lens in its holder, and the eye-lens cover. The eyepiece tube is screwed into the draw tube and carries the field lens and the eye lens with its holder, the cover being screwed to the latter. There is an amber glass shade in a holder that is pivoted so that it may be used or not, as desired, and which is provided to protect the eye from a glare of light. The eyepiece serves to magnify the image at the cross wires and to concentrate the rays of light in the eye.

The front end of the telescope is provided with a movable shutter for the protection of the objective.

The clear aperture of the telescope is 3 inches, the focal length is 17.25 inches, the magnifying powers of the two eyepieces are 12 and 20 diameters and the fields are 3.6 degrees for the 12-power eyepiece and 2.6 degrees for the 20-power.

The image is direct, the erecting being secured by the Porro prisms, each of which twice totally deflects the rays of light at an angle of 90 degrees so that it emerges parallel to the entering ray and in the original direction. The paths of two rays of light are shown in Fig. 47, giving an illustration of the erecting process, in which, however, the 90-degree angles are not all projected as 90 degrees, because of the relative positions of the prisms. The eyepiece of power 12 should generally be used, as the higher power so magnifies the particles in the atmosphere as to cause blurring on any but a dark day.

The telescope is secured in position by six accurately bored projections, four on the cradle and one on each clamp. A locating lug on the front clamp fits into a recess on the telescope, thus bringing the vertical wire plumb.

For those carriages in which the gun is carried in a cradle, the sight

bracket is bolted by means of the feet to seats which form parts of the gun cradle, and when the sight is properly assembled to the carriage and the elevation and deflection readings are zero, the optical axis of the telescope and the axis of the bore of the gun will remain parallel at all elevations. Therefore, if the sight be set at the elevation required for the range of the object to be fired at, and then be laid upon it, the gun will automatically receive the same elevation. Since the deflection movement of the sight is independent of the gun, and deflection necessary may be given without affecting the elevation.

The sight brackets for barbette carriages are lefts and rights.

SIGHTS FOR DISAPPEARING CARRIAGES

The sights for disappearing carriages differ from those for barbette in that they are all alike for the same type of carriage (the range drums all being on the left side); a sight arm is substituted for the sight bracket, and a different method of attachment is used.

The sight arm differs from the sight bracket in shape, has an elevation guide, and the feet of the sight bracket are replaced by seats for two pins.

Disappearing carriages, after model of 1901, are supplied with two sight standards, one right and one left. The elevating mechanism for the gun may be operated by a handwheel assembled to the left end of the elevating shaft, which is supported by a bracket attached to the left sight standard. This shaft connects through bevel gearing with an inclined shaft (passing through the sight standard), the upper end of which connects by bevel gearing with a third shaft that carries a maneuvering handwheel. The middle portion of the inclined shaft is threaded, and carries a nut to which is attached a sight-elevating arm, the upper end of which is a swivel fork. The top of the sight arm ends in a horizontal flange surmounted by a cylindrical axis, upon which is centered a sight-arm bracket, with a flange resting upon the flange of the sight standard. This bracket has a small motion in azimuth and can be set in its proper position by lugs and adjusting screws, then clamped by screw bolts passing through its flange and into that of the sight standard. The bracket has two arms extending forward, and the sight arm is assembled between them by a pin passing through the front ends of the two arms of the bracket and the front seat in the sight arm. The sight-elevating arm passes through the bottom of the bracket and is assembled to the sight arm by a pin passing through the sight arm and the fork of the sight-elevating arm. The sight-arm bracket has two guide ways,

between which travels the elevation guide of the sight arm. The elevating shaft operates the elevating screw, on which travels a slide to which the elevating arm is pivoted at one end, the other end being pivoted to a band on the breech of the gun. The inclined shaft is in two pieces, joined by a coupling, so that the gun and telescope can be set independently and the connection can afterwards be made.

The relations of the pitches of threads, the number of teeth in gears and pinions, the angles of the elevating screw and the inclined shaft, and the lengths of parts are of such that, if the optical axis of the telescope and the axis of the bore of the gun be set parallel at zero elevation and deflection, they will so remain at any elevation. Rotating either hand-wheel elevates or depresses the gun and the sight arm at the same time and through equal angles. Therefore the principles of operating the sight are the same as already described for barbette carriages.

The right sight is mounted similarly to the left, except that it has no connection with the elevating mechanism of the carriage, the rear of the sight arm being assembled by a pin passing through it and two lugs on the sight-arm bracket. This sight can be used only for following an object in azimuth, since the sight arm remains stationary.

SIGHTS OF NEARLY SAME DESIGN AS MODEL OF 1904

There are in service 26 sights, numbered from 1 to 26, both inclusive, which are nearly the same as those described above. The differences are due to substituting in the latter Porro double reflecting prisms for the Brashear-Hastings erecting prisms used in the former.

The telescopes of these sights are differently shaped from the model of 1904, being practically symmetrical about the axis; they are longer by about $3\frac{1}{2}$ inches, the peep sight is directly over the eyepiece, the rear clamp is differently shaped, the sides upon which the shutter and clamps are hinged have been reversed, the adjusting arrangements for the cross-wire ring are different, and the diameters of bearings on the telescopes and cradles for seating the telescope are $\frac{3}{8}$ inch smaller than on the model of 1904.

METHOD OF ASSEMBLING SIGHTS AND LOCATING POINTERS

For Barbette Carriages.—In assembling the brackets for the barbette carriages, great care should be taken to see that the seats are level in both directions, and that burrs, paint, and rust are removed from them and the feet of the brackets. A small obstruction of this kind will throw the

sight shank out of plumb. In setting up the bolts, all should be brought to a firm bearing before any are set up tight.

Neither the elevation nor the deflection pointer is marked by the manufacturer of the sights, since there is no adjustment for either on the carriage. The elevation pointer should be cut at the works of the builder of the carriage to allow for any possible inaccuracy in the seats and the deflection pointer should be put on at the emplacement after the gun is mounted.

After the sight is assembled to the carriage and while the gun is at zero elevation the sight should be accurately leveled and the pointer cut exactly opposite the zero of the elevation scale.

The position of the deflection pointer may be determined by setting up two screens at right angles to the axis of the gun, one more distant from it than the other, and measuring the horizontal distance on each screen between the points in which the line of sight and the axis of the bore intersect it. When these two distances are equal, the vertical planes through the line of sight and the axis of the bore are parallel and the pointer should be cut exactly opposite the 3-degree mark on the deflection scale.

For Disappearing Carriages.—The elevation pointer should be cut at the emplacement, and both sights should have the work done while mounted on the left sight standard. The gun and the sight should be leveled accurately and independently, and the pointer should then be cut exactly opposite the zero elevation scale, the set screw of the coupling having been previously seated and the coupling clamped. The elevating mechanism of the carriage should be so marked by the builder that it can be assembled with all parts in correct relation without leveling.

The deflection pointer is cut by the manufacturer of the sight, but the vertical planes of the line of sight and the axis of the bore of the gun should be brought parallel at the emplacement, using some method such as outlined for barbette sights and rotating the sight-arm bracket with the deflection pointer set at the 3-degree mark. When the sight is in the correct position, the bracket should be clamped and a light line cut so as to extend over both the flange on the bracket and that on the sight standard. The sight for each side of a carriage should be set on its own sight standard.

The range drum for all sights must be graduated after the height of the emplacement above sea level is known.

Adjustments.—The cross wires are rendered distinct by screwing the eyepiece in or out, and this adjustment has no other object. If the telescope is frequently used by the same observer, the eyepiece can be reset

at the correct position by using the graduations on the outer rim in connection with the pointer on the focusing-sleeve nut. After bringing the cross wires into distinct vision by adjusting the eyepiece, the wires may be brought into the focal plane by turning the focusing ring until the object appears distinctly and does not seem to shift when the eye is moved from side to side of the eyepiece. This adjustment is impossible if the object is too close to the telescope. 100 yards is usually sufficient.

The cross wires may be adjusted to bring them into vertical and horizontal planes by removing the focusing-sleeve nut, unscrewing the focusing ring until spanner holes appear in the focusing-sleeve, placing a spanner wrench in the holes and tapping the handle of the wrench with a very light hammer. This adjustment should be made with the telescope in the cradle and trained on a plumb line, and only those thoroughly familiar with the instrument should attempt it.

The adjustment of the cross wires of the sights numbered from 1 to 26 is made by unscrewing the focusing-sleeve nut and the focusing ring until access is given to the capstan-head adjusting screws that secure the cross-wire ring. These screws should be loosened the adjustment made and the screws again set up.

To adjust the tension of the range-drum spring, run the sight-shank rack out of mesh, turn the balanced handwheel to the right to relieve tension or to the left to increase tension and re-engage the rack. When the cradle and telescope are in place and the elevation is 8 degrees, the force required to rotate the handwheel should be the same for both directions. This adjustment must never be made after the drum is graduated, and *the cradle must first be disengaged from the head of the sight shank.*

Care and Preservation.—Telescopic sights are necessarily delicate instruments and must not be subjected to rough usage, jars, or strains. When not in use, the telescope should be kept in its leather case and should be stored in a dry place. It should be occasionally examined to insure its not being corroded by tannic acid from the case and all traces of dust or moisture should be removed before putting it away.

To obtain satisfactory vision, the glasses should be kept perfectly clear and dry. In case moisture collects on the glasses, place the telescope in a gentle warmth; this is usually sufficient to remove it. A piece of chamois skin or a clean linen handkerchief will answer for cleaning purposes, care being taken that the cleaning material does not contain any dirt or grit. The glasses will seldom require cleaning on the inside; but, when necessary, they should be unscrewed, and by a competent

person only. *The object glass must always be kept screwed home, except when removed for cleaning.*

The erecting prisms should not be removed, except by an optician, and if they need repair, report should be made to the proper authority. Removal is apt to disturb the adjustment, and finger marks or lint will cause difficulty.

The cross wires are unprotected when the eyepiece is removed, and great care must be exercised not to touch them, as they are very delicate. No attempt should be made to clean them, except by blowing.

The sight bracket (or arm) and cradle should never be removed from the carriage unless the carriage is dismounted. When not in use these parts should be kept covered by hoods provided for the purpose. All bright parts should be kept thoroughly oiled, special care being given to the worm box, sight shank, and bearings for the telescope, which are of steel. Care should be taken not to remove the oil in putting on the hood. The oil should be wiped off before use. The hood should be removed and the sight brackets (or arms), etc., examined at least once in every two weeks, and the cradle should be removed in elevation and deflection so that as much as possible of the sight shank and worm box can be inspected.

Special care should be taken in the use of the three small electric lamps, as they are fragile. The resistance should be carefully regulated, since a small increase in voltage will burn them out. It is desirable to first throw in a comparatively large resistance and then adjust until the proper illumination is obtained. Each lamp should seat in its receptacle not less than one and one-half turns.

The Scott Telescopic Sight.—The telescopic sights in service are the model of 1896 M_r, the model of 1897, the model of 1898, and the model of 1898 M. See Plate XXXIV.

These sights consist of a telescope mounted on an adjustable frame on which are trunnions and a projecting lug by which the sight and its frame are attached to either a gun or gun carriage by means of a bracket or sight holder.

For attaching the sight to a gun a trunnion bracket is fastened to the right trunnion in which the sight frame is placed and secured so as to hold the telescope during the shock of discharge.

For attaching the sight to a barbette carriage a sight bracket is fastened to the rear part of the right chassis. The upper end of this bracket has a vertical face, to which is attached the sight bracket which holds the sight and its frame.

Disappearing carriages are provided with sight standards attached to

either the right or left chassis rail. On the upper part of the standard are two lugs, slotted to receive the sight holder. The outsides of these slots are closed with caps, in each of which is a clamping screw for securing the sight holder when adjusted to a convenient height for the gunner. The upper end of the sight holder is arranged to receive the sight and its frame.

A catch band is placed on the models of 1898 and 1898 M sights, to which the end of the retainer is secured. With the models of 1896 M1 and 1897 sights the end of the retainer is secured to the lower bar of the sight frame.

The line passing through the centers of the trunnions is called the axis of revolution of the sight or the axis of the sight trunnion, and is parallel to the optical axis of the telescope at zero elevation.

The sight bracket, which is the same for all models of sights, is provided with two V's and a leveling screw. The sight trunnion is seated in the V's and the leveling lug between them bears against the leveling screw. The latter, working against the lug, levels the sight.

The overbalancing of the sight and the method of suspension to the bracket enable the sight to be used for reverse laying. The undercut in the cross level exposes the bubble for adjustment.

A strap fastened loosely to the frame is used for carrying the sight.

For each sight there is provided a leather case in which the sight is carried and kept.

Telescopic Sight, Model of 1896 M1, consists of a telescope carried by an adjustable frame, as above described. The telescope is supported by having its forward end pivoted and secured to the frame, while the other end has a sliding motion along the elevation arc, through contact with the vernier piece. The telescope is an ordinary non-inverting one, provided with an achromatic objective composed of two lenses in contact and a Ramsden eyepiece to magnify the image formed by the objective.

The non-inverting telescope is obtained by inserting the Hastings-Brashear compound erecting prism between the sliding diaphragm and the objective. This compound prism consists of two prisms having angles of 30° , 60° , and 90° , laid with their 30° angle toward each other on a parallel-sided glass plate, and on the other side of this plate is laid a third prism having a true 90° angle. Successive reflections at the surfaces of these three prisms erect the image without any lateral displacement of the rays of light other than that necessary for the purpose, and without lengthening the telescope tube, or diminishing the field of view. This compound prism is mounted in a frame provided with two sets of screws by means of

PLATE XXXIV

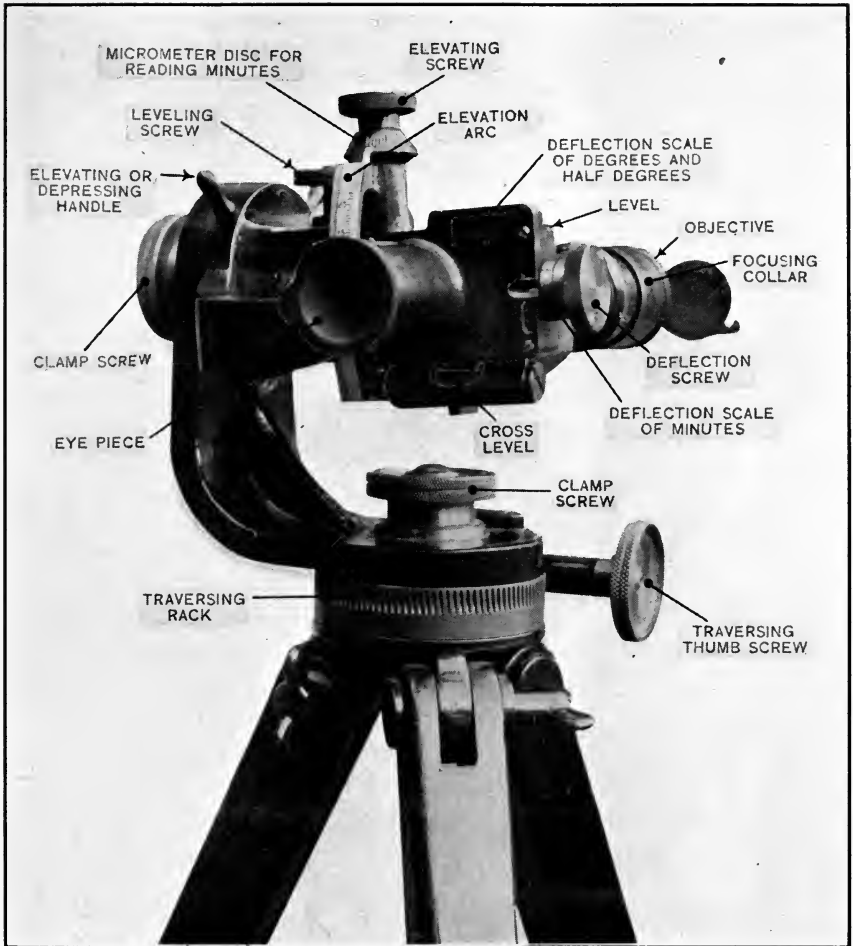

Telescopic Sight, M. 1898 MII. Mounted on Hagood Tripod Mount.



LIBRARY
OF THE
UNIVERSITY
OF
CALIFORNIA

which it is adjusted after being assembled in the telescope. Just forward of the sliding diaphragm the telescope tube is cut away on top to admit the prism and its frame. Two screws passing through flanges on the latter secure it to the tube and determine its position. A roof-shaped plate screwed to the telescope tube protects the prism from dust or mechanical injury.

Mechanism of the Telescope.—Within the telescope is a sliding diaphragm or frame carrying a vertical platinum cross wire 0.001 inch in diameter; also a thin glass reticule, a horizontal and a vertical scale; also a horizontal line which takes the place of the horizontal cross wire in telescopic sights of other models. The vertical wire indicates deflection, and the intersection of the wire and horizontal line is laid on the object sighted. Lateral motion is given the diaphragm by a deflection screw on the right side of the telescope. The movement of the vertical wire is a little more than 2° on each side of the zero of the deflection scale, and the scale itself is graduated to 0.05° to indicate this movement. On this scale the degree marks are numbered, the half degrees being indicated by the number 50. The vertical scale reads to $0^\circ 3' 26''$, equal to .001 of the range. It is intended to assist in estimating distances, errors of range, etc.

The telescope is properly focused when the plane of the cross wires is in the position of distinct vision and the image of the object is in the same plane as the cross wires. To accomplish this condition both the eyepiece and the objective are given the necessary motions within the telescope tube.

The motion of the eyepiece is given by screwing or unscrewing it in its housing, and that of the objective by a focusing screw collar back of the sunshade.

In sighting, the intersection of the cross wires is brought to bear on the image of the object sighted; and this process is precisely the same as bringing the intersection of the cross wires on to a material object in the same plane as the cross wires, and, provided the focusing is correct for each observer, there can be no variation in the sighting.

The elevation arc, the center of which is on the horizontal axis of the telescope, is graduated from -7° to $+22^\circ$, but owing to the space occupied by the vernier these limits for practical purposes are -7° and $+16^\circ$.

The vernier reads to $2'$. It is fastened to the vernier piece on the telescope forward of the deflection screw and is provided with

two set screws, one at each end, for the purpose of securing it to this piece, as well as for purposes of adjustment.

The rocking-worm spindle is a distinct feature of this sight; and the change was made to provide for a constant pressure of the worm spindle in the worm rack, and to prevent uneven wear of the latter.

The line of sight at zero deflection is the optical axis of the telescope.

A level is attached to the left side of the telescope. Its axis is parallel to that of the sight trunnions, or axis of revolution of the sight. This level enables the sight to be used as a quadrant in its own bracket.

Open sights on top of the telescope are provided to enable the gunner to quickly bring an object into the field of the telescope.

The angle of elevation is given by turning a milled-head micrometer screw which actuates a worm spindle; and the latter engaging in the worm rack cut in a projection on the right side of the telescope gives the desired angular motion to the telescope about its horizontal axis. For one complete turn of this micrometer screw the telescope is elevated or depressed 1° .

Any backlash between the worm spindle and the worm rack is overcome by means of a spring pressing upward against the bottom side of the telescope.

The micrometer screw which actuates the worm spindle is graduated to minutes. It is provided on top with two small screws which secure the collar on which the graduations are made. Unscrewing them, the collar can be turned and the vernier and micrometer readings made to agree.

To obtain a correct angle of elevation it is essential that the elevation arc should be truly vertical for all angles of elevation of the gun, and for any inclination the gun trunnions might have to the horizontal. This is accomplished by means of a cross level, fastened to the under side of the frame, parallel to the horizontal axis of the telescope, and perpendicular to the axis of revolution of the sight. The cross level is provided with two openings, one on the top and one on the bottom, to permit of easy observation in direct and reverse laying.

Telescopic Sight, Model of 1897, differs from model of 1896 M1 in having a slightly larger field of view ($5^{\circ} 12'$); a larger objective (1.2 inches), and a power of nine.

The glass reticule and vertical scale are omitted, and the engraved

horizontal line is replaced by a horizontal platinum wire of .001 inch diameter.

Deflection is given by moving the sliding diaphragm along a graduated horn deflection scale placed below the diaphragm. The movement permitted is about $2^{\circ} 15'$ on each side of the zero of the scale, the latter being graduated to indicate the movement. The degree marks only are numbered, and the value of the smallest division, $3'$, is indicated by the symbol $\frac{1}{20}$ directly under the zero hole of the scale. The vertical crosswire indicates the amount of deflection.

Telescopic Sight, Model of 1898, is a new design, similar to the earlier models described, in its method of attachment to the sight bracket, but differing from them in general construction and in the more important details.

The sight consists of two principal parts, the trunnion casting and the telescope, which is pivoted to the casting at its forward end.

The trunnion casting is made of phosphor-bronze on account of its great hardness, elasticity, and the resistance to corrosion. This casting comprises the trunnions, the leveling lug, the bearing for the horizontal axis of the telescope, and the elevation arc with the bearing for the elevating-worm spindle.

To provide for interchangeability, the dimensions of the trunnions and leveling lug are made the same as in the other telescopic sights.

The bearing of the horizontal axis of the telescope is drilled through the trunnion casting near the forward trunnion. The elevation arc and the bearing for the elevating-worm spindle constitute one piece. This latter bearing is practically dustproof, being closed entirely in rear, and having only sufficient opening in front for the worm rack to engage.

The elevation arc is graduated as in the other sights.

The fundamental line of all the telescopic sights is the axis of revolution defined by the trunnions, and since the elevation arc and the bearing for the horizontal axis of the telescope form, as they do, a part of the casting which contains the axis of revolution, it follows that such a construction is all that can be desired.

The telescope is attached to the trunnion casting by its horizontal axis and the worm rack. The horizontal axis, or pivot of the telescope, projects through the trunnion casting. Within the bearing for this pivot is an annular groove which contains a spiral spring, one end of which bears against the trunnion casting and the other against the telescope. This spring serves to overcome any backlash in the worm rack when the telescope is moved in altitude, and being placed under

considerable strain in fitting it in its groove, the pressure it exerts against the telescope in every position is practically uniform.

The worm rack on the left side of the telescope projects into the opening in the trunnion casting and engages with the elevating-worm spindle.

The telescope can be run out and disengaged entirely from the worm spindle without affecting the adjustment of the telescope.

The micrometer screw on the elevating-worm spindle is graduated to 1', and its adjustments are made as in the other sights.

The vernier is attached to a vernier piece on the left side of the telescope, and is adjusted by means of two screws working into the vernier piece, one at each end, and against two shoulder pieces bearing against the vernier. This adjustment differs from that in the other sights in that a given turn of an adjusting screw produces an opposite movement in the vernier.

The vernier reads to 2'.

The telescopic level is fastened to the right side of the telescope.

The level is a minute one, the bubble moving .1 of an inch for 1' of elevation.

For giving deflection, a set of platinum cross wires, one vertical and one horizontal, and two scales, one inside and one outside, are provided. The vertical cross wire is attached to a sliding diaphragm actuated by the deflection screw on the right side of the telescope. In giving deflection, this vertical wire moves along the interior horn scale, and indicates the reading. In addition, this diaphragm has a pointer, which at the same time moves along the outside silver scale, giving the reading without looking into the telescope. The telescope is cut away at this place to make room for the outside scale, and to reveal the pointer. In order that the pointer should give a correct reading, the screw actuating the fixed diaphragm is accurately cut, and the backlash is overcome by two spiral springs working against the sliding diaphragm.

The horizontal cross wire is attached to a fixed diaphragm placed behind the sliding one. For the purpose of adjustment, this diaphragm can be given a slight motion in a vertical direction and secured in the correct position.

The interior horn scale is graduated to $2^{\circ} 30'$ on each side of the zero. The smallest division is 3'. This scale is held and adjusted as in the other telescopic sights; on the scale is engraved R←FIRE→L, indicating the direction of motion for the vertical cross wire in order to direct the gun to the left or right of the object sighted.

The cross wires and the fixed and sliding diaphragms are exposed to view by unscrewing the four screws holding the cap, which contains the socket for the eyepiece.

The outside scale is graduated to degrees and half degrees, the 3' readings being obtained from the micrometer-deflection screw. The inscription R←FIRE→L is also engraved on this scale.

The micrometer-deflection screw which actuates the sliding diaphragm is graduated on its collar, with two series of figures from 0 to 9 in opposite directions. Each division equals 3', and a complete turn of the screw moves the sliding diaphragm 30'. One series of figures gives the correct reading when the deflection movement is for firing to the left and the other series for the contrary movement.

On the telescope near the graduated collar is engraved $\begin{matrix} L \\ \updownarrow \\ R \end{matrix}$, indicating the direction of rotation of the micrometer deflection screw for firing to the left or right of the object sighted.

The cross level is attached to the under side of the telescope and is provided with an opening at the top for direct laying and one at the bottom for reverse laying. The level tube fits in a larger tube cast with the telescope, and for the purpose of adjustment is provided with four radial set screws which fit in a flare at one end of the level tube and bear against the outside tubes.

The level is a 3' one, the bubble moving a tenth of an inch for a change of inclination of 3'.

The telescope attached to this sight was especially designed to give a large field of view, an erect image, and the maximum amount of light the eye will receive under the most unfavorable conditions.

The field of view of a telescope depends on its power and the field of the eyepiece. Ordinarily the field of an eyepiece rarely exceeds 40°, but in this case, besides making the eyepiece achromatic, the field was increased to nearly 50°. An increase of this amount in the field of the eyepiece is always accompanied by lack of perfect definition at the margin of the field. By dividing the field of the eyepiece by the power of the telescope, its field of view is obtained. In this telescope the field of the eyepiece is 48°, and the power is 8, consequently the field of the telescope is 6°.

The power of 8 was selected as sufficient for proper magnification of the deflection scale, and any power above 8 would have correspondingly diminished the field of view.

The erect image is formed by the insertion of a Hastings-Brashear erecting prism between the eyepiece and the objective. The opening

for the insertion of the prism and its frame is made in the under side of the telescope tube.

The eye receives the maximum amount of light through a telescope of this character, when the diameter of the pencil of light emerging from the eyepiece is equal to that of the pupil of the eye. The diameter of the emerging pencil is equal to the diameter of the objective divided by the power of the telescope. To fulfill this condition the diameter of the objective is made 1.25 inches; the diameter of the emerging pencil of light is therefore nearly $\frac{1}{6}$ inch. Except at night, when the pupil of the eye may dilate to $\frac{1}{4}$ inch, the telescope is adapted to all conditions of light.

The loss of light in the telescope is due to absorption in the lenses and prism, and when these are made of the best glass and the surfaces carefully prepared, the loss of light is reduced to a minimum.

The objective is focused by a focusing collar back of the sunshade.

The eyepiece is focused by screwing or unscrewing it in its bearing, which forms part of the cap covering the deflection scale and cross wires.

The sunshade with the dew cap is retained in place by a small set screw which permits the sunshade to be pulled in or out, and rotated about the telescope.

The telescope tube is made of thick brass, so that it may be handled without danger of bending or the sight losing its adjustments.

Use of the Sight.—There is a tendency, among those making a first acquaintance with the telescopic sight, to think it a very complicated instrument, having little in common with the ordinary sights, and that to learn how to use it is a difficult matter. As a matter of fact it is simply a sight in the form of a telescope; and every rule learned about elevation, etc., is precisely the same as with the ordinary sights, only of easier application, the operations being mechanical; besides the telescope and its elevating gear, there is only the means of attaching it to the gun, which a little information will make quite clear.

The advantages gained by the use of the telescopic sight are:

Increased accuracy of fire due to—

a. Power of vision.

b. Elimination of personal error.

(a) *Power of vision.*—Objects, indistinct to the naked eye, in some lights almost invisible, can be seen clearly, and accurately aimed at, even at the extreme range of effective fire.

A short-sighted man can see and aim just as well as a man with good eyes.

A particular part of the object can be aimed at, instead of an indistinct whole, and no part of the object is obscured, as so often happens with the ordinary front sight.

(b) *Elimination of personal error.*—A fine cross wire has to be brought mechanically on to the object—a much easier thing than aiming exactly with a full sight, and everyone must aim the same providing the focusing is correct.

Before using a sight, the case containing it should be slung over the gunner's shoulder, and the sight should not be removed until the gunner has reached the sighting platform. While the sight is in the case, the cover should be kept fastened.

In removing a sight from its case, take hold of the strap fastened to the frame or to the telescope.

See that the objective is screwed home. Neglect of this precaution may give rise to a large error, since the optical center of the objective may not coincide with the axis of the screw, and a change in the position of the optical center involves at once a change in the line of sight.

The focusing screw collar has slightly more movement than is necessary for solar focus, and the telescope is first focused by focusing the eyepiece, which is done by screwing the eyepiece until the cross wires, with every roughness on them, are distinctly visible. On account of the coarseness of the cross wires, this is not a very sensitive method of focusing the eyepiece, and final focusing may be necessary after the objective is focused. The objective is focused by directing the telescope on a distant object and turning the focusing collar until, on shifting the eye over the eyepiece, the intersection of the cross wires remains on the same point of the object (or, in other words, there is no parallax). The distant object selected for this purpose should possess sharp outlines. Telegraph wires, signposts, or buildings are excellent for the purpose. The general landscape, possessing, as it does, soft outlines, should not be used.

When the objective is focused, should the image not be clearly defined, then the eyepiece is not correctly focused, and it must be screwed until the definition is satisfactory.

An objective once focused is correct for all observers, but the eyepiece requires focusing for each individual.

Unless disturbed, an objective once focused will remain so indefinitely.

The Sight as used in Gun Laying

The sight is now ready for use in gun laying.

To set the sight for deflection, take hold of it with the left hand, and, looking into the telescope, move the deflection screw with the thumb and forefinger of the right hand until the required deflection is obtained.

Right deflection corrects for deviation in firing where the shots fall to the left of the target, and left deflection the contrary.

To avoid confusion, the model of 1897 sight has engraved on the body of the telescope, and beside the deflection screw controlling the sliding diaphragm, the expression "Drift correction," and an arrowhead to indicate the direction of motion to make the correction.

The inscription, "Drift correction," was placed on the sight as a guide in the movement of the cross wires to correct for various deviating causes. It must not be understood that the sight corrects for drift only.

In the model of 1898 sight and model of 1898 M sight, the inside and outside deflection scales, and the telescope near the micrometer, deflection screws have engraved on them the direction of the movement of the vertical cross wire in order to direct the gun to the left or right of the object sighted.

Should the shot fall to the right of the target, to make the correction the vertical cross wire is moved the proper amount in the direction indicated by the arrowhead pointing toward the letter L. Looking into the telescope, this motion is to the right.

Should the shot fall to the left of the target, the movement of the vertical cross wire is in the contrary direction and as indicated by the arrowhead pointing toward the letter R.

It is readily seen that the sliding diaphragm moves to the right to correct for drift, or for a similar deviating cause.

These sights correct for drift, wind, and speed of target.

To set the sight for elevation, turn the micrometer screw controlling the elevating-worm spindle until the required elevation is obtained.

Since the worm rack is not apt to wear uniformly, it is preferable to depend entirely on the vernier for the 2' readings, and to use the graduations on the collar of the elevating screw for the odd minute.

Let the angle of elevation required be $2^{\circ} 35'$. To set the sight, turn the elevating screw until the arrow on the vernier points to $2^{\circ} 30'$, now turn the same screw until the second graduation from

the arrow on the vernier is brought into line with the graduation on the elevation arc just in front of it. The reading is now $2^{\circ} 34'$, and to obtain the required elevation, turn the micrometer screw through the extra minute indicated on the graduated collar.

The sight is now ready to be placed in its bracket on the gun trunnion, and in seating it be very careful to bring the leveling lug to bear *gently* against the leveling screw. If this one precaution is heeded, the sight will ordinarily never lose its adjustments.

The sight is leveled by turning the leveling screw until the bubble in the cross level comes to its center.

Looking along the telescope, or through the open sights, or along the axis of the sight trunnions, the gun carriage is quickly traversed until the target is brought into the field of view.

If the target appears below the intersection of the cross wires, depression is required; if above the intersection of the cross wires, the gun must be elevated. If the target is seen to the right of the cross wires, the gun carriage must be traversed "muzzle right"; if to the left, "muzzle left."

With barbette carriages, owing to the slight preponderance of the breech of the gun, it is preferable in order to overcome any backlash in the elevating gearing that depression should be the last operation.

The intersection of the cross wires having been brought on that part of the target aimed at, look at the cross level, and if the bubble is still in the center, the gun is correctly laid. If the bubble is not in the center of the cross level, the gun is not correctly laid, and the sight must be releveled and the operation of laying repeated until the condition obtains that when the sight is directed on the target the bubble shall be in the center of the cross level. In sighting a gun mounted on a seacoast carriage, the axis of the gun trunnions being horizontal, the bubble will remain in the center of the cross level during the entire operation of laying. The last act of the gunner before firing, should be to see whether or not the bubble is in the center of the cross level.

The telescopic level enables the gunner to use the quadrant angle of elevation, in which case the sight is first set for deflection only, and the gun is aligned with the telescope at a convenient angle of elevation. The gun having been aligned on the target, the sight is set for the required quadrant angle of elevation, and the gun elevated or depressed until the bubble in the telescopic level comes to its center.

Using the sight as a quadrant has the advantage of eliminating

any error due to refraction, which is likely to be present where the site of the gun is at an elevation above the target.

A correction must be applied to the angle of elevation to obtain the quadrant angle, depending on the height of the gun site above the target. Both angles are alike when the gun and target are on the same level.

For reverse laying, the sight is reversed in its bracket and leveled, the cross level being exposed on its under side to render the bubble visible.

When the sight is placed in the bracket on the sight standard of a disappearing or barbette carriage, it is leveled as before; but in this position it can only be used for giving direction, and accordingly is set for deflection only, the elevation of the gun being given by the elevation arc.

Tests and Adjustments of the Sights.—The principles involved in the construction of telescopic sights require:

1. That the line of sight at zero deflection and elevation and the axis of the telescopic level should be parallel to the axis of revolution.

2. That the axis of the cross level should be perpendicular to the elevation arc and to the axis of revolution.

3. That the sight trunnions should be of equal diameter.

4. That the sliding diaphragm carrying the cross wires should move in setting the sight for deflection parallel to the axis of the cross level.

In addition to the above, the following tests are prescribed for each sight:

A test of the elevation arc and deflection scale for accuracy.

A test of each level for sensitiveness.

A test of the telescope for definition, field of view, and power.

Before making any tests of a sight, see that the objective and the eyepiece lenses are clean, and that the objective is screwed home.

1. Test for parallelism of the line of sight at zero deflection and elevation to the axis of the telescopic level and to the axis of revolution of the sight:

To make this test, it is desirable to have a stand on which to place the sight, a striding level to level the trunnions, and an engineer's Y level.

To make the examination, place the trunnions on the stand, level them with the striding level, make the cross level read zero, and then, by means of the elevation micrometer screw, make the telescopic

level read zero. This will bring the axis of the level and the axis of the revolution into parallel planes, which are horizontal.

Then see if the vernier reads zero on the arc. If it does not, either make it do so by means of the proper adjusting screws or note the error.

The vernier is adjusted by means of two set screws, one at either end of the vernier, so arranged that, by unscrewing one of the screws and screwing up the other, the vernier can be adjusted in the required direction.

To make the zero of the micrometer divisions on the milled head screw for elevating agree with the zero of the vernier, loosen the two small screws on top of the brass head, then turn the collar carrying the divisions into the proper position, and tighten the two small screws.

Next, focus the telescope of the sight on a distant object, set up the engineer's Y level, focus it on a distant object, adjust it carefully to indicate a level line, and make sure that there is no parallax in the eyepiece of either telescope. That being done, and the telescope of the level being collimated on the telescope of the sight, with the object glasses 2 or 3 inches apart, look into the telescope of the level and see if its horizontal wire coincides with the horizontal pointer or horizontal cross wire in the sight. If there is any error, note its amount.

In the model of 1896 M₁ sight, this error can be corrected by adjusting horizontally the line on the glass reticule, the latter being adjustable after loosening the two screws which secure it and its frame in a vertically adjustable frame which in turn is held by two screws.

To remove the eyepiece cap so as to render the reticule and frames accessible first remove the four screws at the right of the eyepiece which secure the split housing for the deflection knob, when two other screws will be exposed which must also be removed in addition to the two screws at the left of the eyepiece, when the cap can be removed by drawing it directly toward the operator.

In the model of 1897 sight this error can be corrected by the adjusting screws of the erecting prism, tilting the line of collimation sufficiently to compensate for the error; these sights are, however, being fitted as rapidly as possible with a vertically adjustable diaphragm, to which the horizontal wire is attached similar to the model of 1898 sight, and when so equipped the erecting prism should not be disturbed. This diaphragm has a small screw and opposing spring, by means of which, after loosening the three screws which hold it in place, the diaphragm can be adjusted very minutely and clamped securely as before.

In the model of 1898 and 1898 M sights, the error is corrected by moving in the direction required the diaphragm carrying the horizontal wire. These sights are being equipped with the fine adjustment above described.

This test shows whether or not the line of collimation of the telescope is parallel to the axis of revolution in the horizontal plane. It yet remains to be seen whether it is parallel in the vertical plane. For that purpose revolve the sight on its trunnions through an angle of 90° , so as to bring the cross level vertical, and then having again brought the engineer's level into position, look through it into the telescope of the gun sight, and notice whether or not the horizontal wire of the level cuts the extreme tip of the horizontal pointer or the intersection of the cross wires when the deflection scale reads zero. If they do, all is well; if not, by means of the deflection screw, move the horizontal pointer or cross wires until its extreme tip or their intersection touches exactly the horizontal wire of the engineer's level. The eye end is closed by a cap, held by four screws which must be unscrewed. When this is done, the deflection scale will be exposed, and it will be seen that it is held in place by two small screws. Loosen these screws, shift the scale so as to make its zero coincide accurately with the pointer or cross wire; tighten the screws so as to clamp the scale firmly, and replace the cap which carries the eyepiece. If these operations are properly performed, the deflection scale will be brought into perfect adjustment, but it should be again tested with the engineer's level to make sure that such is the case.

To determine whether the axis of the telescopic level is parallel to the axis of the sight trunnions or axis of revolution, revolve the sight through a small angle about its trunnions, the level and trunnions both being horizontal; if the parallelism is present, the bubble will remain in the center of the level; if not, the instrument maker only can correct it.

2. Test to determine whether the axis of the cross level is perpendicular to the elevation arc, and to the axis of revolution of the sight:

Place the sight in its bracket with the axis of the V bearings approximately horizontal, and level the cross level. Suspend a plumb line of sufficient length to subtend the elevation arc about 15 yards from the sight, and move the sight until the intersection of the cross wires bears accurately on the top of the line. Now move the telescope in altitude until it is sighted on the bottom of the line. If the intersection of the cross wires bears accurately on the bottom of the line, the axis on the cross level is in a plane perpendicular to the eleva-

tion arc. If not, adjust the cross level in the model of 1896 M₁ and model of 1897 sights, as follows:

Unscrew, by half a turn at a time, each of the two screws of the level, just sufficiently to admit of a piece of paper being inserted underneath the proper screw end of the level.

The paper must be rectangular, having a piece cut out of it in order that it may envelop the screw on three sides. One thickness of foolscap paper raises the level about 1'.

If the pointer was to the right, raise the level on the left side; if to the left, on the right side, by means of the piece of paper put underneath.

Finally, screw the screws home equally, and with moderate force. Reapply the test, and if found correct make a scratch across the heads of the screws to the metal of the sight. If not correct, the operation must be repeated.

To make the adjustment in the model of 1898 sight, unscrew the screw cap on the right end of the cross-level casting. This will expose the level tube with four adjusting set screws. The position of these screws will at once suggest the correct ones to adjust to make the correction.

To complete the test, the experiment must be repeated with the axis of the V bearings at the maximum elevation the experiment will permit.

If, then, the intersection of the cross wires follows the plumb line the axis of the cross level is truly at right angles to the axis of revolution and to the elevation arc. If not, then in the model of 1896 M₁ and model of 1897 sights the adjustment must be made by unscrewing the two screws holding the cross level and forcing sidewise one end of the level sufficient to correct for the error, and then tightening the screws. If there is not sufficient play in the screw holes to make the correction, the sight should be returned to the maker. In the model of 1898 the correction is made by adjusting the set screws of the level tube so as to move it sidewise.

Repeat the preceding experiment for test of the adjustments made.

3. Test for equality in the diameters of the sight trunnions:

Use a Brown & Sharpe micrometer, measuring each diameter with the utmost care. With skill the measurement can be made to one five-thousandth (0.0002) part of an inch, and if the trunnions differ by more than that they should be returned to the maker for correction.

The striding level will answer the purpose even better than the micrometer calipers.

4. Test for the horizontal movement of the sliding diaphragm when the sight is leveled:

This test can be made in conjunction with the test for the parallelism of the axis of revolution and the line of sight at zero deflection and elevation. The telescope of the sight being adjusted and its line of sight at zero deflection and elevation horizontal, and the telescope of the Y level being horizontal and collimated on that of the sight, when the horizontal pointer or cross wires should coincide with the horizontal wire of the Y level. Move the sliding diaphragm carrying the pointers or cross wires, when, if the sight is in adjustment, the coincidence should remain undisturbed during the deflection of the pointers or cross wires. If the horizontal pointer or cross wire rises above or falls below the horizontal wire in the level, the sight is not in adjustment, and the defect can only be remedied by the maker.

5. To test the vertical arc, the most convenient plan will be to fasten the instrument on a stand with the vertical arc lying horizontally, and point the telescope on some distant object, in such a direction that the vernier is near one extremity of the arc. Read the arc, and then point on another distant object so situated as to bring the vernier nearly to the other extremity of the arc, and read the arc again. The difference of these two readings will be the angular distance between the objects. Then remove the gun sight, set an ordinary theodolite in its place, and measure the angle between the same objects with it. If all is right, the arc as measured by the theodolite should be the same as that indicated by the gun sight. In making this test care must be taken to place the center of the theodolite as nearly as possible in the position which was occupied by the horizontal axis of the telescope of the gun sight. The vertical limb of the transit may be used for the same purpose when there are facilities for doing so. If it is thought best, collimated telescopes can be used instead of distant objects.

6. To determine the value of the horizontal scale of the gun sight, set up a theodolite in such a position that its telescope collimates on the telescope of the gun sight, and measure on the limb of the theodolite any convenient number of the divisions of the horizontal scale of the gun sight. Dividing the arc thus measured by the number of divisions will give the value of each single division. When using collimated telescopes, always take the precaution to focus each one on a distant object before collimating.

7. Examine the telescope by measuring its aperture in inches, its focal distance in inches, and its magnifying power. The best method of determining the magnifying power is by means of a double-image dynameter, but it is not necessary to employ such an elaborate apparatus in the present case. It will suffice to take the clear aperture of the objective between the points of a pair of dividers and prick it down on a piece of paper. Then, with the same pair of dividers and a magnifying glass, take the diameter of the pencil of light emerging from the eyepiece, and find how many times that is contained in the clear aperture of the objective by using the last opening of the dividers to step the distance between dots laid down when the objective was measured. The result will be the magnifying power. Finally, examine the definition of the telescope, and note whether or not it is satisfactory.

An accurate determination of the focal distance of the telescope is not necessary. The telescope being focused on a distant object, it will suffice to measure the distance from the front of its objective to the pointers, and then deduct two-thirds of the thickness of the object glass.

For determining the field of view the following method is suggested:

When the telescope of the sight and transit instrument are collimated on each other, the diameter of the field of view can be determined by pointing the transit first on one end of the diameter and then on the other, reading the angles and taking the difference.

8. A test to determine the sensitiveness of the telescopic level: Bring the bubble to one end of its run by means of the elevation micrometer screw on the telescope and note the reading on the arc of elevation. Then, by means of the elevating screw, bring the bubble to the other end of its run, and again read the arc of elevation. The difference of these two readings is the amount of arc corresponding to the distance traversed by the bubble in passing from one end of its run to the other. This should be at the rate of not less than 1 inch for 10' of elevation. There seems to be no convenient way of testing the sensitiveness of the horizontal level, except by taking it off, fastening it on the telescope, and then testing it in the same way as the telescopic level.

The preceding tests and adjustments, on which the efficiency of the sights depends, are carefully made during manufacture, and unless a sight is tampered with, or subjected to rough treatment, it is most unlikely to ever lose its adjustments. In manufacture the adjustments are all made with a limiting error of 1'.

In service it is desirable that the sights should frequently be

tested, and where there are facilities the methods laid down should be followed.

The adjustments must not, however, be made except by an officer authorized to do so by the Chief of Ordnance, and if a sight is found by trial to be out of adjustment the fact should be reported to proper authority.

At a fortification where the facilities are few for making the preceding tests, the following methods are outlined for the guidance of the officer conducting them:

The test for the equality of the sight trunnions, the accuracy of the elevation arc and deflection scale, the sensitiveness of the levels, and the horizontal motion of the sliding diaphragm can be dispensed with, since the sights before issue to the service have been tested for these requirements, and from the construction of the sight, it is obvious that these requirements can always be obtained.

A bracket mounted accurately on a horizontal gun trunnion will answer all the purposes of an efficient support for the sight during these tests.

1. Test for the parallelism between the line of sight at zero deflection and elevation, and the axis of revolution:

Test each sight independently by setting it at zero deflection and elevation, and laying it on a mark about 3,000 yards distant, and revolving the sight about its axis of revolution. If the line of sight is parallel to the axis of revolution, the tip of the pointer or the intersection of the cross wires will remain exactly on the same distant mark. If not, deflect the sliding diaphragm and elevate or depress the telescope until the tip of the pointer, or the intersection of the cross wires, remains exactly on the distant mark. Note the errors in elevation and deflection. If the error in elevation or deflection exceeds 1' the sight must be readjusted. Select that sight which has the minimum errors as the standard sight.

2. Test for parallelism between the axis of the telescopic level and the axis of revolution of the sight:

With all the sights set at the true line of sight for zero deflection and elevation, elevate or depress the gun until the telescopic level reads zero. Revolve the sight about its axis of revolution through an angle of about 5° . If the axis of the telescopic level is parallel to the axis of revolution, the bubble should not leave the center of the level.

3. Test for the cross level being at right angles to the axis of revolution of the sight:

Level the cross level of each sight. Elevate the gun through an angle about 20° , when the bubble should remain stationary in the center of the cross level.

4. Test for the cross level being at right angles to the vertical arc:

Lay on a distant mark with the sight set at zero deflection and elevation. Elevate the gun through an angle of about 15° . Now depress the telescope until the intersection of the cross wires cuts the point aimed at. If it does not do so the level is not at right angles to the arc, and the arc is not vertical.

Select the sights that have fulfilled the preceding tests satisfactorily and set each one at 10° elevation and zero deflection, and lay each one carefully on a distant mark.

The sights should be interchangeable to within 1', and this test will verify all the preceding tests except 2. If the sights show a disagreement in elevation which cannot be accounted for in the preceding tests, then set each sight at the zero elevation, and if the disagreement still holds, it is due to the trunnions not being of the same diameter and the trunnions must have been injured.

After a sight has been in use for some time the micrometer of the elevating worm may be found not to agree with the vernier. This is due to a slight wear of the worm rack, and when the vernier and micrometer are made to agree at zero, it will sometimes be found that, owing to uneven wearing of the rack, they cannot be made to agree at other angles of elevation. When the difference is considerable the sight should be provided with a new rack.

THE GUNNER'S QUADRANT

This instrument (Fig. 60) is used on all kinds of guns and mortars, either to give the elevation directly or to verify the angles obtained by ordinary sights. On the 12-inch mortars two seats for the feet of the quadrant are squared off on the upper side of the piece in rear of the trunnions; with other pieces, the quadrant should be applied to surfaces perpendicular or parallel to the axis of the bore. There are three models in service—1892, 1897, and 1898.

The quadrant is composed of two main parts—the body, carrying the graduated arc, and the movable arm, carrying the index and the level. The movable arm also carries a graduation in minutes from 0 to 60, and the level, which is capable of a longitudinal movement along the arm, carries a second index for reading this scale.

Degrees are read upon the graduated arm of the body, minutes by the sliding level, and scale on the movable arm.

The graduated arc is provided on the inside with a toothed circular rack, each tooth of which corresponds to a degree mark. The movable arm is hollow and holds a spindle which carries on its end a small toothed sector. A spiral spring contained inside the hollow arm constantly urges the spindle and sector outward, thereby engaging the teeth of the sector with those of the graduated arc and holding the arm in any position it may be placed. To move the arm it is necessary

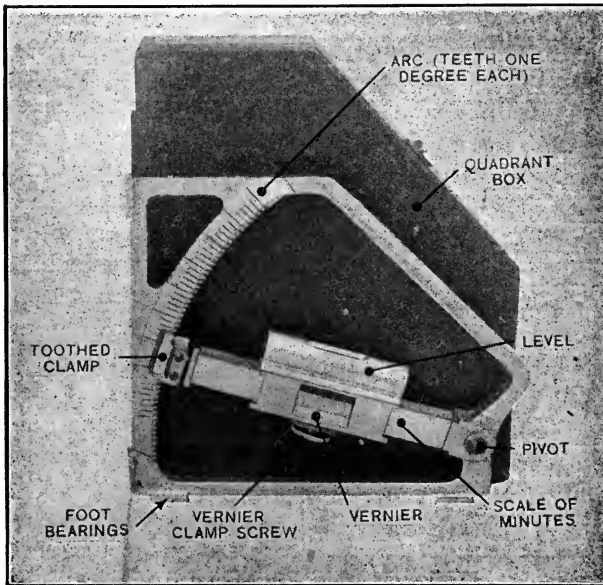

FIG. 60.—Gunner's Quadrant.

to press back the sector against the action of the spiral spring until its teeth clear those of the graduated arc; the arm may now be moved to a new position, and when the pressure is removed from the sector its teeth will again engage with those of the graduated arc.

The principle by which the scale of the movable arm is constructed to read to minutes is as follows:

The movable arm is a portion of the arc of a circle.

The level is a chord of this circle, and the angle between any two of its positions will, therefore, be that subtended by the arc over which the index moves.

To Use the Quadrant.—It should be remembered that a correction must be made to the angle of elevation used with the sight to obtain the quadrant angle of elevation, and that this correction depends on the difference in height above sea level of the axis of the trunnions and the target.

$$QE = SE + \text{the angular elevation of the target,}$$

or when target is below the level of the gun, as is the usual case:

$$QE = SE - \text{the angular depression of the target.}$$

For Angles of Elevation.—Set the quadrant at the required quadrant elevation by placing the index mark of the sector of the movable arm opposite the required degree mark on the graduated arc of the body, and by sliding the level along the arm until its index is opposite the required minute division of the scale of the movable arm. All elevations below 45° (both degrees and minutes) are read from the scales on one side of the quadrant, and those above 45° from the scales on the other side of the quadrant.

Place the quadrant on its seats or on surfaces parallel or perpendicular to the axis of the bore, always being careful to keep the side of the graduated arc in use to the left, looking in the direction of the target, and keep the arrow showing the line of fire pointing in the direction of the target. Elevate the piece until the bubble of the level comes to rest at the center. This will be the elevation required.

For Angles of Depression.—Proceed as above, except that the side of the graduated arc in use should be kept to the right, looking in the direction of the target, and the arrow showing "direction of fire" should point away from the target.

It will thus be seen that any elevation or depression in degrees and minutes from 0 to 90° , within the limits imposed by the method of mounting, can be given by this quadrant. It will be noticed that it is graduated on one side from 0 to 44° and on the other from 45° to 89° . The extra degree on both sides will be given by the sliding level. It will also be noticed that if 45° be given on the one side by moving the arm to 44° and the index on the level to 60', and the quadrant be then placed to give readings above 45° without changing the arm or level, it will still record 45° ; for the position of the level to give a reading of 60' above 44° is also the position to give a reading of 0' above 45° , and the main index will be found to stand at 45° on the opposite side of the graduated arc.

Model of 1898.—The method of setting this quadrant for a given reading is the same as in the other models, using the graduation on either side of frame. Its use is simplified in that it is only necessary after having set it for a given angle of elevation or depression to place it on its seat on the gun with the arrow marked "Line of fire, elevation," or "Line of fire, depression," as the case may be, pointing toward the target.

CRUSHER GAUGE

The crusher gauge for seacoast cannon is used for determining the maximum pressure exerted in the bore of the gun during service firing. Pressures are required to be taken not only at proof firings and tests

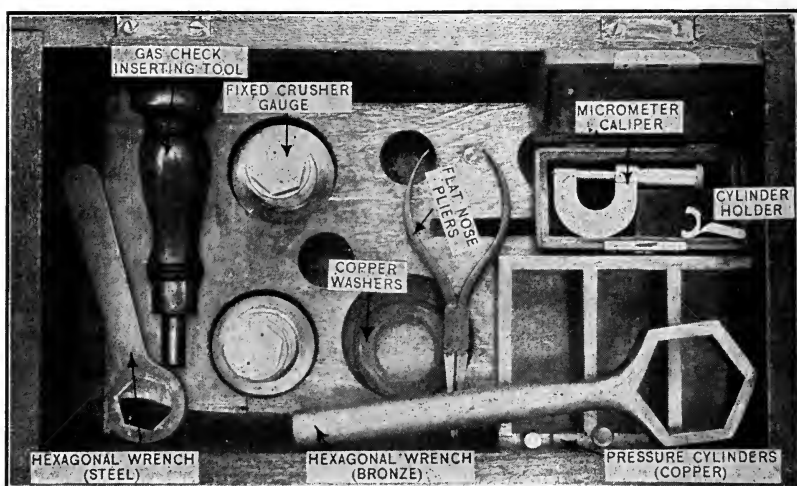

Fig. 61.—Crusher Gauge Outfit.

of powder and ammunition, but also in service target practice. There are three standard outfits of crusher gauges, namely, those for large-caliber guns, those for intermediate, and those for small-caliber guns.

The outfit used for large-caliber guns is shown in Fig. 61, and is designed for use in all cannon above 6 inches in caliber.

The gauge is inserted in the mushroom head of the breechblock in each gun, two crusher gauges being used. A blank plug similar in external appearance to the crusher gauge is furnished to protect the gun when the regular gauge is not in its seat. This may be seen by referring to Plate X.

To Prepare Crusher Gauge for Use, the closing cap is removed by holding the housing fast with the housing wrench in the left hand and unscrewing the closing cap with the closing-cap wrench in the right hand. In the medium-caliber crusher gauge outfit the teat wrench, the tee, and reamer wrench are used in place of the housing and closing-cap wrenches respectively. The piston is pushed out with the gas-check inserting tool. The piston and the interior of the crusher gauge should then be thoroughly cleaned with oil and cotton waste and freed from moisture. It should also be determined that the piston enters the bore freely at both ends. The parts of the crusher gauge being in order, put a drop of oil on each end of the piston and insert piston in the bore. Take the pressure cylinder which is to be used in recording the pressure and enter it in the cylinder holder until it is held in the middle of its length. Then insert pressure cylinder in the crusher gauge with the fingers so that it rests on end in the center of the piston. Place the washer on top of the housing and screw in the closing cap, setting it up tightly by means of the wrenches. The gas check is then placed in the bore above the piston, bottom of the cap next to the piston, and with the gas-check inserting tool set it down on the piston until there is no play between piston head and pressure cylinder underneath, which should now remain firmly held between piston head and closing cap. The crusher gauge is now ready for insertion in the gun.

After firing dip the crusher gauge into a bucket of water to remove fouling and then wipe dry. Unscrew the closing cap, using the wrenches as above described; shake pressure cylinder and cylinder holder out of the gauge and push the piston and gas check out with the gas-check inserting tool. Remove the cylinder holder from the pressure cylinder, wipe the latter clean, and place it in the properly numbered hole in the chest, or measure it immediately if time is available. The piston and interior of crusher gauge should then be cleaned and oiled as previously described before again being inserted in the gun. A new pressure cylinder and generally a new gas check will be required for each round. The washers should be carefully inspected for cracks or unusual hardening of the metal before being used.

Pressure Cylinders.—Two sizes of pressure cylinders are furnished, the larger being designated the cannon-pressure cylinder, and the smaller, the small-arms pressure cylinder; the latter being used in minor-caliber crusher-gauge outfits. These cylinders are made from copper rods, about 99 per cent pure copper. The rod is drawn once after annealing and every precaution in composition and treatment is taken to make the metal homogeneous.

These cylinders are subjected to initial compressions of from 2,000 to 7,000 pounds per square inch less than the standard maximum powder pressure expected in the guns in which they are used, the object being to reject all pressure cylinders which do not come within certain prescribed limits of variation in set (shortening) due to this compression, and to eliminate abnormal results by reducing the amount of set produced by the powder pressure. These cylinders are made up in lots of several thousand and tarage tables are prepared for the various lots. Pressure cylinders are measured by the micrometer before and after firing, and the amount of compression is the difference between these readings. In making these measurements care should be taken to secure a light but firm contact of the measuring surfaces at the ends of the pressure cylinder. They should not be squeezed. After the set in inches is obtained by subtracting the length "after firing" from the length "before firing" and obtaining the set in inches from the pressure-record pamphlet, the tarage table should be entered and the corresponding pressure obtained.

TIME-RANGE BOARD

The time-range board is a device to provide information for keeping the piece laid continuously for range, so that if an observation is lost or the rate of change in range received from the plotting room indicates an error, the range setter may look at the board and set the range on the range scale, on the carriage of the gun, in accordance with the data indicated thereon. It is placed on the emplacement wall (when actually in use) at a point where it can be plainly seen by the range setter. It is operated by the range keeper, on data received from the plotting room.

The board is shown in Fig. 62. It consists of an oblong frame containing a thousands scale, with two reading openings. This scale is numbered from 11 to 1 on the left-hand end, and from 2 to 12 on the right-hand end. It is operated by moving a knob in the slot on the upper portion of the board.

A hundreds scale running the length of the board is marked on its outer surface just under the reading openings of the thousands scale. The hundreds scale is graduated so that readings 300 yards greater or less than the number indicated in the reading openings of the thousands scale may be obtained.

Below the hundreds scale and extending the length of the board

there is a plug rack with holes which divide the hundreds scale into ten-yard divisions.

A prediction scale graduated from 0 to 350 yards in both directions slides in a groove underneath the plug rack of the board.

To Use the Board.—The first corrected range received from the plotting room is indicated on the board by the operator. The left-hand reading opening is used when the range is increasing, and the right-hand reading opening is used when the range is decreasing.

For example: Assume the first corrected range to be 5,430 yards, target moving out. The thousands scale is moved until the figure 5 appears in the left-hand reading opening. The zero of the prediction scale is then moved directly under the third hole from the right of figure 4 on the hundreds scale and a plug inserted. At the next reading sent to the gun and called out, say 5,580, the zero of the prediction scale is moved until it is directly under the eighth hole to the right of figure 5 on the scale for hundreds and a plug inserted. The prediction scale is then read between plugs, that is from zero of the prediction scale back to the first plug inserted. The reading will be found to be 150, in other words the range to the target is uniformly increasing at the rate of 150 yards every 15 seconds, or every predicting interval. Therefore the range for one prediction ahead will be indicated under the reading 150 to the right of zero on the predic-

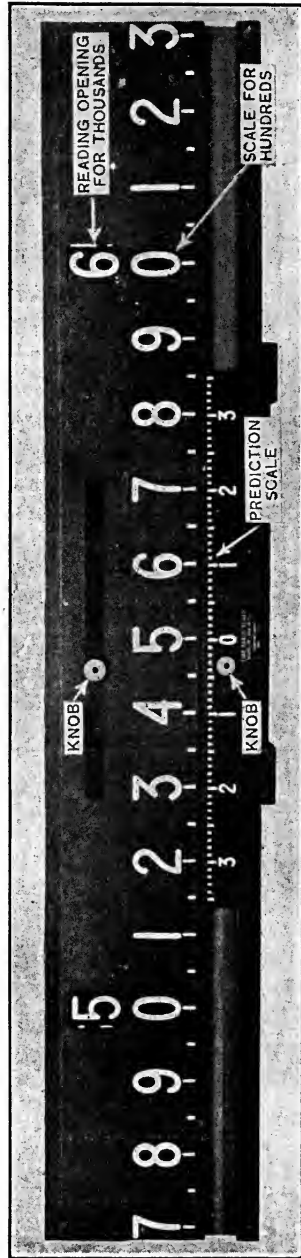

FIG. 62.—Time Range Board.

tion scale, or as 5,730. A plug is therefore inserted in the third hole to the right of 7 on the scale for hundreds. The operation above given is repeated as each range is received and the rear plugs taken out.

The board is used in a similar manner in the case of a target coming toward the battery or when the range is decreasing; for example, suppose the first range received to be 6,600 and the second 6,500. A plug is inserted under the 6 of the scale for hundreds and when the second range is called out the zero of the prediction scale is set directly under 5 of the scale for hundreds as shown on plate and a plug inserted. The reading between plugs (from zero to right) will be found to be 100 and as the range is decreasing a plug should be inserted above 1 (100) to the left of zero on the prediction scale or directly under 4 of the hundreds scale; the combined reading of the board will then be 6,400.

POWDER CHART

The powder chart is used to determine the velocity to be expected from a given charge of powder considered as a function of the temperature of the powder. It is shown in Fig. 63.

The chart consists of a board upon which the chart is mounted; along the top edge of the board a T square fits into a groove which runs the length of the board. Along the top edge of the chart a velocity scale is marked, with graduations to represent 10 foot-seconds to the inch. The scale reads from left to right with the normal velocity of the gun placed in the middle and designated by a vertical line extending the width of the chart. A convenient length for the chart is 20 inches, which allows for a variation of 100 foot-seconds on each side of the normal.

Across the face of the chart is drawn a temperature-velocity curve plotted to rectangular co-ordinates. The ordinates are the temperatures and the abscissæ are the corresponding variations from the normal muzzle velocity.

The left edge of the T square is graduated in degrees Fahrenheit, beginning at -10 degrees at the bottom and ending at 100 degrees at the top. A convenient scale is 10 degrees to the inch, which requires a chart about 13 inches wide.

A horizontal line extends across the chart so that it will pass through the 70° mark on the T square; this line designates the normal temperature.

To Use the Chart.—For powder tested to give the normal velocity of the chart at 70° F., the T-square is set so that the actual temperature as indicated on the scale of the T square lies on the temperature velocity curve, and the velocity that may be expected from such powder will be indicated on the velocity scale at the top of the chart, at the intersection of the left edge of the T square and this scale.

For powder tested and adjusted to give the normal velocity at any other temperature than 70°, the T square is set for the temperature at which the powder was tested and the velocity read as in the first

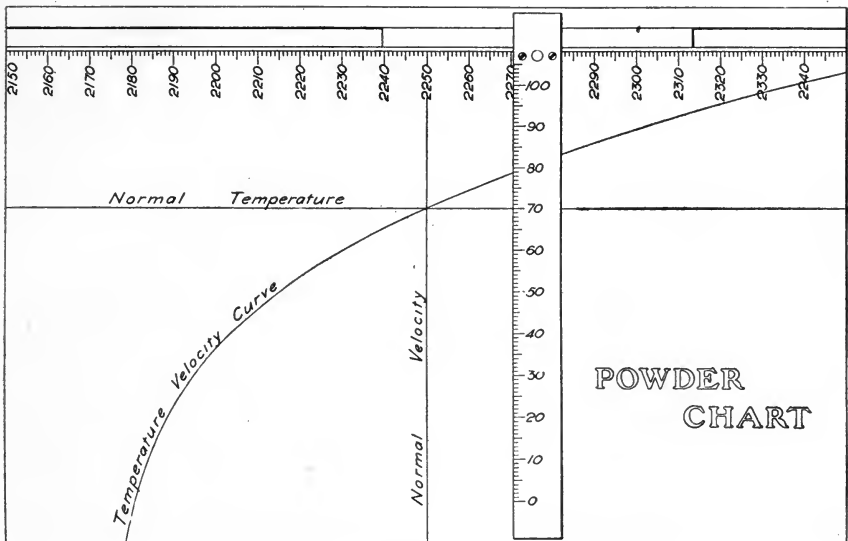

FIG. 63.

case. The T square is then set for the actual temperature of the powder and another velocity determined. The difference between the first velocity obtained and the velocity obtained from the temperature setting will give the algebraic difference to be added to the normal velocity for the gun in question, and the same will be the velocity to be expected from the charge used.

For example: Assume that the normal velocity is 2,250 f.s. The velocity obtained by setting the T square at the test temperature was 2,240 f.s. The velocity for temperature setting, or the actual temperature of the powder in question, say, is 2,280 f.s. The difference would then be +40 f.s.; or, this added algebraically to the normal velocity would give 2,290 f.s. as the probable velocity to be expected from the powder in question.

CHAPTER VIII

SEARCHLIGHTS

IN developing the maximum efficiency of searchlights, when acting in conjunction with fixed defenses, the following requirements are suggested by a recognized expert on searchlight defense.*

They should be located with consideration to their ability to search effectually the approaches of the battle area, with a view to the early discovery and identification of the enemy. For this purpose advanced roving lights on portable or disappearing towers should be placed some 4,000 yards in front of the outside line of the primary armament, where practicable, and observers placed still further to the front and in telephonic communication with the battle commander. The purpose of this is obvious when it is remembered that the effective range of the primary armament is 12,000 yards, while that of the 60-inch light is approximately 8,000 yards, as shown in the accompanying table.

The second consideration is their ability to illuminate continuously with minimum interference, a number of targets simultaneously in any part or parts of the battle area. This can be accomplished by so disposing the lights that as the target passes in through successive zones of the battle area it can be picked up and covered by searchlights assigned to each zone before it is out of reach of the lights of the preceding zone. Further to prevent interference, the lights should be placed on the flanks of all stations and guns pertaining to their respective zones.

The third consideration concerns the ability of the lights to illuminate landing positions and points from which the fortifications could be readily attacked from the flanks or rear by raiding parties of the enemy. This condition may be overcome by a judicious employment of the outermost roving lights, or other lights in special positions, and when

* Namely, Major W. C. Davis, C. A. C., U. S. A., from whose article, published in the Journal of the U. S. Artillery, May-June, 1909, most of the information in regard to the tactical use of searchlights is drawn.

necessary, supplemented by portable lights, controlled by the coast artillery supports, along the land front.

The fourth consideration is their ability to cover mine fields and channels leading to inner harbors against the operation of torpedo boats and other craft. This condition is met by having a number of 36-inch lights, on sights from 15 to 25 feet above high water, with beams held fixed or nearly so, across the channel, or covering the mine field and its approaches. Where channels are narrow, diverging lenses can be used. The 36-inch projector is effective under good weather conditions up to 3,000 yards, using a concentrated beam (angular divergence about $2\frac{1}{2}$ degrees). At this range the beam has a diameter of approximately 120 yards. At 2,000 yards and at 1,500 yards the same intensity of illumination can be obtained (as with the concentrated beam at 3,000 yards) by employing lenses giving 12 to 40 degrees' divergence. Such lenses should be employed, in good weather, to increase the time required by a vessel to traverse the beam.

Another consideration of importance in connection with the searchlight defense is the providing of relieving lights to replace lights temporarily or permanently disabled. This can be accomplished either by having duplicate lights installed whenever practicable, or by assigning one light to another's relief.

The effective protection of advanced searchlights from capture or destruction by the enemy must also be considered. In this connection no searchlight should be advanced so far to the front, or otherwise sited, that an armored ship can attack it effectively without exposing herself to destruction from the high-power guns of the fortifications. At night a searchlight is a very difficult target to hit, and when properly made and emplaced can only be put out of action by a direct hit on the projector. It is believed this is not likely to occur until the vessel has advanced to close range, say about 2,500 yards, where its secondary armament can be used to full advantage. Should the enemy, under these conditions, succeed in obtaining the range, so that the projector should appear to be endangered, the light should be suddenly occulted—leaving no target for him to fire at, and probably leading him to the false conclusion that the projector had been destroyed or disabled. Under such conditions the advanced light has served its purpose, for it has revealed the enemy, who should now be covered by a searchlight further to the rear. If the advanced light, as previously suggested, is placed not more than 4,000 yards in front of the first line of primary armament, the ship, when she has closed to within 2,500 yards from the light, would be less than 6,500 yards from the primary

armament of the defense—a situation which she should not be able to maintain for any appreciable time.

All advanced searchlights should be protected from torpedo boats and small craft by a suitable force of coast artillery supports, supplemented by a few field guns. In the daytime these lights should be run under cover and their position concealed from the enemy.

TYPES OF PROJECTORS

The number of searchlights necessary for the proper illumination of the water area covered by any particular fort depends upon the size of the area in question and the importance attached to its defense. Two types of projectors have been adopted in the U. S. Coast Artillery service, namely the 36-inch and the 60-inch. Both of these types are provided with parabolic reflectors. The beam proceeding from them, even when the arc is most perfectly in focus, is not a cylinder, but the frustrum of a cone; the 36-inch light having an angular divergence of $2\frac{1}{2}$ degrees, and the 60-inch light a divergence of from $2\frac{1}{2}$ to 3 degrees, from the projector outward. The approximate diameter of the beam at various ranges is shown in the following table:

Range, yards	1000	2000	3000	4000	5000	6000	7000	8000
36-inch } diam. of beam (yds.)	40	80	120	160	200	240	280	320
60-inch }	50	100	150	200	250	300	350	400

From this table it will be seen that the illuminating power of the beam follows the quadric law, varying inversely with the square of the distance.

In passing through the air the elements of the beam encounter various impurities, such as particles of moisture, dust, carbon, etc., which absorb, reflect, and refract rays of the light, causing the beam to fall off rapidly in intensity and giving rise to a considerable amount of diffused light. Due to this cause the beam, as it passes through the air, is visible; its distinctness varying inversely with the clearness of the atmosphere, and directly with the darkness of the night.

The diffused light above referred to, radiating at right angles from the beam, lights up with considerable brightness objects two or three hundred yards from the beam, and when the beam is held just above the water, gives rise to the "reflected ray" or beam, so often observed and mentioned in the coast artillery service. The clearer the atmosphere and the brighter the direct beam from the searchlight, the less

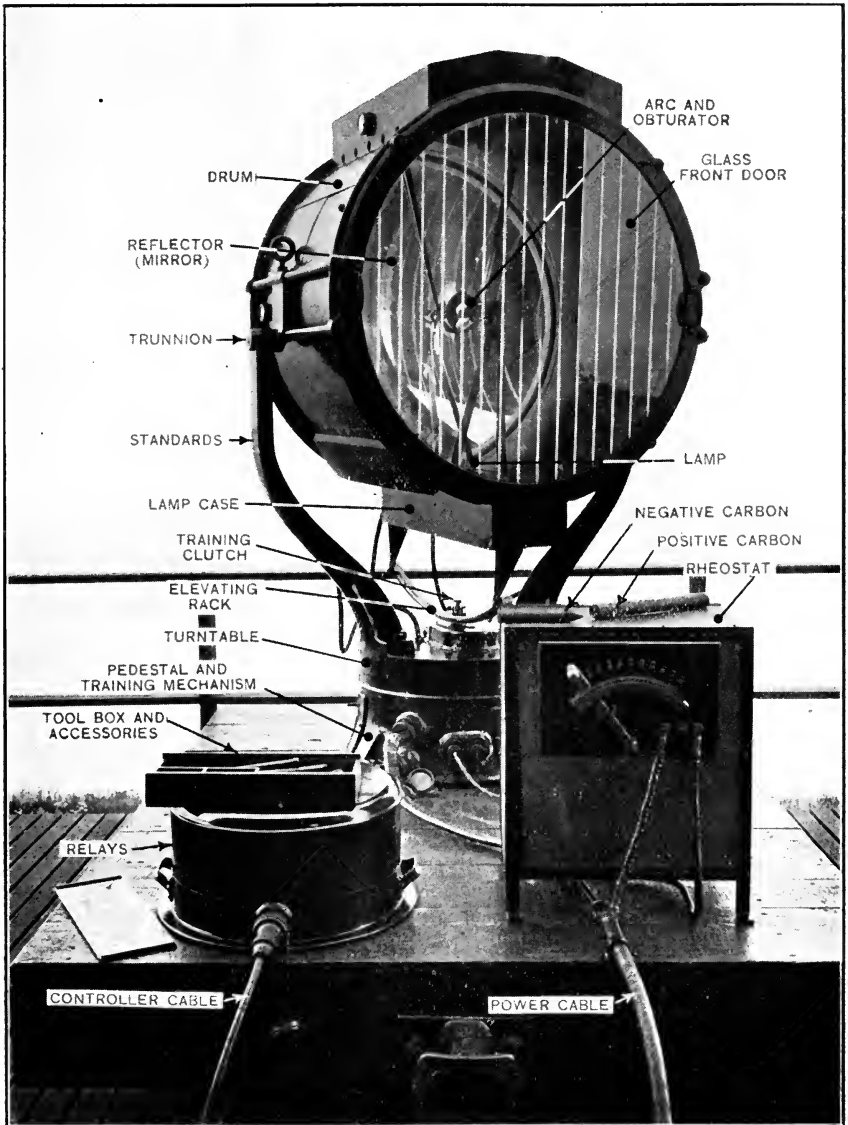

36-inch Searchlight (Projector). Showing movable truck, and apparatus for electrical control.



luminous becomes the "reflected beam"; but in no case does the "reflected beam" ever approach the brightness of the direct beam; and a target passing through the "reflected beam" is never seen as clearly, other conditions being the same, as it would appear in the direct beam of the light.

The atmospheric conditions affecting the penetration of the searchlight beam are the same as those affecting sunlight; that is, fog, mist, snow, rain, smoke, etc., reduce the effective range of the beam in proportion to their respective densities.

No definite rule can be made as to the exact range at which a target in a searchlight beam should be visible, the range varying with respect to the condition of the air; the intensity of the light; the color and shape of the target; the position of the observer with respect to the target and light; the ability of the observer; the suitability of the telescope; and the character of the background.

Atmospheric conditions are at their best when the air is free from moisture and smoke, and when the moon and stars are entirely obscured by clouds. The beam then has great penetration and the law of contrast brings the target out into clear relief.

The intensity of the light depends directly upon the candle power. The average intensities of the German projectors, using 125 to 150 amperes, are 61,000,000 and 180,000,000 standard candle-power, respectively; that is, the 60-inch projector has three times the candle-power of the 36-inch projector.

When a searchlight beam impinges on a ship a portion of the light is absorbed, while the balance is reflected in various directions, according to the well-known law that the angle of reflection is equal to the angle of incidence. The percentage of light absorbed depends upon the color and kind of paint and the character of the reflecting surface. Thus a dark-colored ship is less conspicuous than one painted white, and a ship the lines of which are irregular and broken is not as conspicuous as one having a smooth outline.

All stations and guns using the same type of illuminating light should be on the same side of the light and the light should be controlled from that side. The projector, for efficient service, should not be less than 150 yards from the flank of the nearest battery or position finder that the searchlight is to serve. That within any practicably attainable range in elevation (other conditions remaining constant) the greater the difference in level between the observer and the searchlight, the better the illumination of the target—always excepting the case where the observer or the projector is so near the water as to be

interfered with by the curvature of the earth. It may be stated that the two greatest objections to the high-siting of searchlights in the U. S. Coast Artillery service, are: (1) That it may give too great a "searchlight dead space," so called when the beam is projected so as to strike the water at a certain range, inside of which vessels may pass under the beam unilluminated and unobserved. (2) High-sited searchlights are of no value whatever in harbors where high fog prevails—where the water underneath may be perfectly open for navigation.

The ability of the observer usually depends upon the amount of practice he receives at night. A good illustration of the influence of training is seen in pilots of boats at night or where fog is prevalent. The acuteness of vision by which a pilot will discern landmarks at night or through a fog seems wonderful to a landsman, who, standing by his side, is unable to see anything.

Experience teaches that the best telescope for night work is one with a large objective and low magnifying power.

Channels whose hilly shores are rough and irregular, or are heavily wooded, offer special difficulties for observers, as do also the shadows thrown on the water by high hills or mountains. These difficulties are apparent in the daytime and at night are even more in evidence. Under such conditions, a small dark-painted craft, like a torpedo boat, stealing in close to the shore, is a most difficult object to detect.

APPROXIMATE RANGES

The following table summarizes the approximate ranges at which targets should be visible in good weather, and under other favorable conditions.

Color of ship.	Vessel seen, but outline obscure.		Form clear enough for horizontal tracking.		Target can be water-lined.	
	36"	60"	36"	60"	36"	60"
White.....	8000	12000	5500	8000	4500	6500
"War paint".....	6000	9000	4500	6500	4000	6000
Black.....	5000	7000	4000	5500	3500	4500

The service of searchlights is officially defined in the U. S. Coast Artillery Drill Regulations.

COMPONENTS OF SEARCHLIGHTS

In addition to their tactical classification searchlights are classified with reference to the size of their mirrors or reflectors. The two standard sizes found in the U. S. Coast Artillery service are, as previously stated, the 36- and 60-inch. The standard 36-inch light, with apparatus for electrical control, etc., is shown in Plate XXXV.

The principal parts of a searchlight are the lamp, mirror, drum, lamp box, glass front door, standards, pedestal, turntable, training mechanism.

(a) **Lamp.**—The lamp of the latest type of searchlight in service is shown in Plate XXXVI, and its mechanism is as follows:

- A*, negative carbon holder;
- B*, positive carbon holder;
- C*, clamping screws for carbon clamps;
- D*, vertical adjusting screw for positive carbon clamp;
- E*, horizontal adjusting screw for positive carbon clamp;
- F*, negative carbon support;
- G*, positive carbon support;
- H*, lamp frame;
- K*, main lamp contact shoes;
- L*, hand feed screw;
- M*, focus nut for focusing screw;
- N*, stud of lamp switch for cutting out feeding magnet;
- O*, ratchet and pawl;
- P*, feeding magnet armature;
- Q*, contact of circuit breaker;
- R*, adjusting screw for ratchet arm;
- S*, starting magnet;
- T*, feeding magnet;
- U*, adjusting spring for feeding magnet.

The lamp is for producing the light, starting and feeding the arc, and is operated through its mechanical arrangement by the electric magnets named in the nomenclature. The circuits of the lamp are shown in Figs. 64 and 65. The current is brought to the searchlight by the power cables and enters the pedestal, going directly to the main switch of the lamp; from there it is taken by leads to the contact rings attached to the turntable.

There are two circuits—the series circuit, which includes the arc,

and the feed-magnet circuit in shunt with it. The series circuit is from the positive contact shoe to the series magnet, thence through the positive carbon holder to the arc, back through the negative carbon holder to the negative contact shoe, and after passing through the series

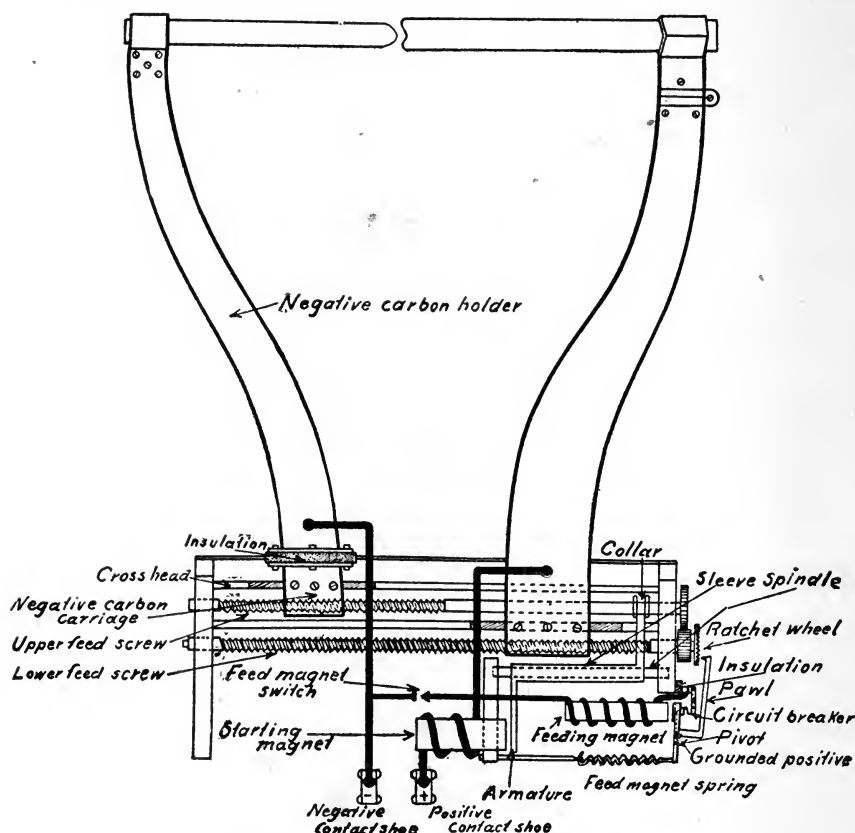

FIG. 64.—Circuits and Lamp Mechanism

magnet the circuit is connected to the frame, the frame being a part of the circuit. The feed magnet circuit is from the circuit-breaker spring (positive) to the other circuit-breaker contact, then to the feed magnet and through the main switch to negative line.

The Action of the Lamp is as Follows: When the circuit is closed the resistance in the air gap prevents any current from flowing in the arc circuit, and the voltage across the carbons will be practically that of the source of power. This difference of potential or pressure causes sufficient current to pass in the shunt circuit, so that the feed magnet

attracts its armature and thus draws the pawl into the ratchet while turning it through a small angle. The act of drawing the armature breaks the shunt circuit at the circuit-breaker contact, and the attraction ceasing, the spring returns the armature to its initial position. The

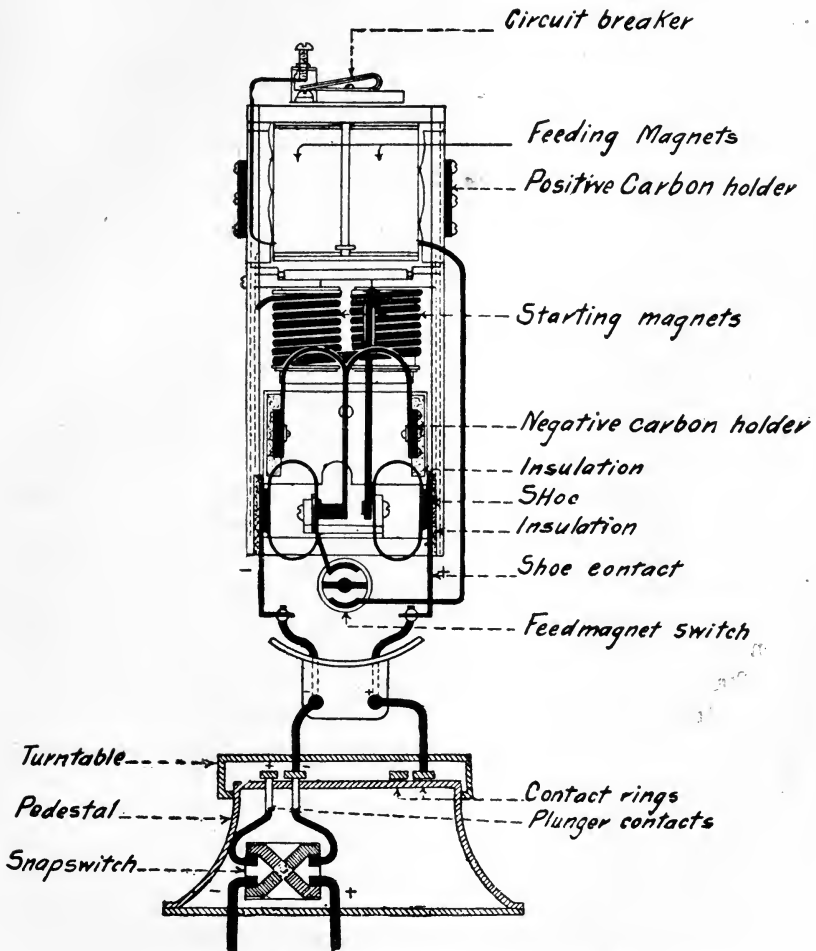

FIG. 65.—Circuit Breaker, etc., Searchlight Lamp Mechanism.

voltage across the arc is not changed since the first movement of the ratchet, so the operation will be repeated and continue until the carbons touch each other. When the carbons touch a large flow of current makes the starting magnet attract its armature, which operates to pull the

carbons apart, forming the arc. It takes a short time for the crater to burn properly, and until this is done the arc will not have the proper length. As soon as this is attained the feeding magnet will keep the carbons the proper distance apart, since it acts when the proper voltage across the arc is exceeded, this adjustment being made by the spring attached to the feed magnet armature.

The attractive power of the magnet depends upon the current passing around the core, which necessarily is proportional to the difference of voltage across the arc and the resistance of the magnet winding. The feed spring is arranged to resist an opposing force equal to the force of attraction, so that whenever this force is exceeded which indicates that the voltage across the arc has been exceeded and that the carbons are too far apart, the current will flow around the feed magnet and the feeding magnetism will commence to operate, feeding the carbons closer together and maintaining the proper arc.

(b). **The Arc.**—If two pieces of carbon are joined by wires to the terminals of a battery of sufficient electro-motive force, or to a generator of electric current as just described, and are then brought into contact for a moment and drawn apart a short distance, as is done with the lamp of a searchlight, a kind of electric flame called the electric arc or voltaic arc is produced between the points of the carbons, and a brilliant light is given off by the white-hot points of carbon electrodes. Before contact of the carbons is made the difference of potential or pressure between the points is insufficient to cause a spark to leap across even 1/10,000 of an inch of air space, but when the carbons are made to touch by the feeding mechanism of the lamp a current is established. On separating the carbons the spark at parting volatilizes a small quantity of carbon upon the points. This carbon vapor, being a fairly good conductor, allows the current to continue to flow across the gap, provided it is not too wide, and as the carbon vapor has a high resistance it becomes intensely heated by the passage of this current, and the carbon points become highly heated, giving off a white light. The temperature of the arc at this point is estimated to be 6,000 degrees C. The greater part of the light is given off from the points of the carbons themselves, though their temperature is not as high as the arc, due to the principle that solid matter is a better radiator than gaseous. The volatilizing from the positive electrode or carbon causes it to become hollowed out or cup-shaped, forming the crater. Due to the gap between the two carbons being small, particles of the volatilized carbon are deposited on the negative carbon, and this tends

to point it. The amount of light emitted from the crater depends upon the amount of current and the carbons used; that is, their size, or the incandescent area exposed.

The normal current for the 36-inch light is 130 amperes, while the normal voltage across the arc is 60; for the 60-inch light the normal current is 200 amperes, and the normal voltage across the arc is 65. For any particular light it may be found that better practical results are obtained by slight variations in the values given, as it has been found in practice that nearly every light has its individual factor. An arc may be made and maintained by either direct or alternating current, but for searchlight purposes an arc from pure carbon electrodes supplied with direct current has been found to be the best, and is the method used in coast defense.

(c) **The Mirror.**—The reflector is a parabolic mirror and its object is to project the light reflected from the arc in parallel rays to the target. As is known, the angle made by a reflected ray of light with the normal and the reflecting surface is equal to that made by the incident ray, so by the use of a parabolic reflecting surface, when the light is in focus the reflected rays are parallel.

The mirror is so mounted in a brass frame that it is securely protected against concussion, and provision is made for expansion due to heat. The mirror should always be kept dry to prevent spotting or frost due to moisture, and prior to its use should be cleaned by dusting with a soft brush or with a piece of chamois skin after it has been carefully shaken out to prevent the presence of grit, which would result in scratching the mirror. It must be remembered that the presence of dirt or dust will greatly reduce the amount of reflected light. It has been found from observation that the direct rays of the sun damage reflectors to a considerable extent, therefore they should not be exposed unnecessarily.

(d) **The Drum.**—The drum and lamp box are together a casing for the lamp and reflector. The drum is pivoted on trunnions that bear on standards which are bolted to the turntable. It can be given vertical motion on the trunnions or a horizontal motion on the rollers, or both together, such being necessary for training the beam. The lamp rests on guides fastened to the lamp box, so arranged as to be moved forward or backward by turning the focusing screw, the head of which is shown in the cut referred to.

(e) **Lamp Box.**—The lamp box is shown in detail in Plate XXXVI, and is used to carry the lamp and feeding mechanism, and carries the contacts for transmitting the current to the lamp proper.

(f) **Glass Front Door.**—The glass front door is provided for the protection of the lamp and mirror. It is made up of a circular frame carrying strips of glass about two inches wide of varying lengths depending upon the diameter of the projector considered.

(g) **Standards.**—The light is provided with two standards or upright arms, which are bolted to the turntable at the lower extremity and carry the trunnions at the top, supporting and carrying the drum and its contents and give the light the necessary motions for training.

(h) **Turntable.**—A turntable attached to the horizontal training motor through a gear train is used to give the beam horizontal motion.

(k) **Pedestal.**—The pedestal is that part of the light beneath the turntable carriage. On its interior surface the training motors are arranged to give both the horizontal and vertical motions of the beam.

(l) **Training Mechanism.**—Training normally is by means of an electrically controlled mechanism, but there is an auxiliary mechanism, so that in case the electric control fails the training may be done by hand at the light.

The electric control consists of two training motors located in the pedestal and connected electrically with the controller located in the station from which the light is operated. The vertical training motor through a gear train transmits a vertical motion to the beam, and the horizontal training motor through a gear train drives a pinion which engages with the pinion on the turntable, giving the beam horizontal motion.

ESSENTIALS OF EFFECTIVENESS

The essentials of an effective searchlight, aside from its tactical location, may be stated as follows:

- a. A proper power supply.
- b. Good arc, which necessarily means good carbons.
- c. The proper focusing of the beam.
- d. Careful operation of the training mechanism.
- e. A good operator of the searchlight controller.

The first depends upon the installation and is beyond the control of those ordinarily charged with the care and operation of searchlights. The second is within the power of those charged with the care and operation of the searchlight, and the steps necessary to obtain a good arc may be summarized as follows:

1. Begin with a new set of carbons.

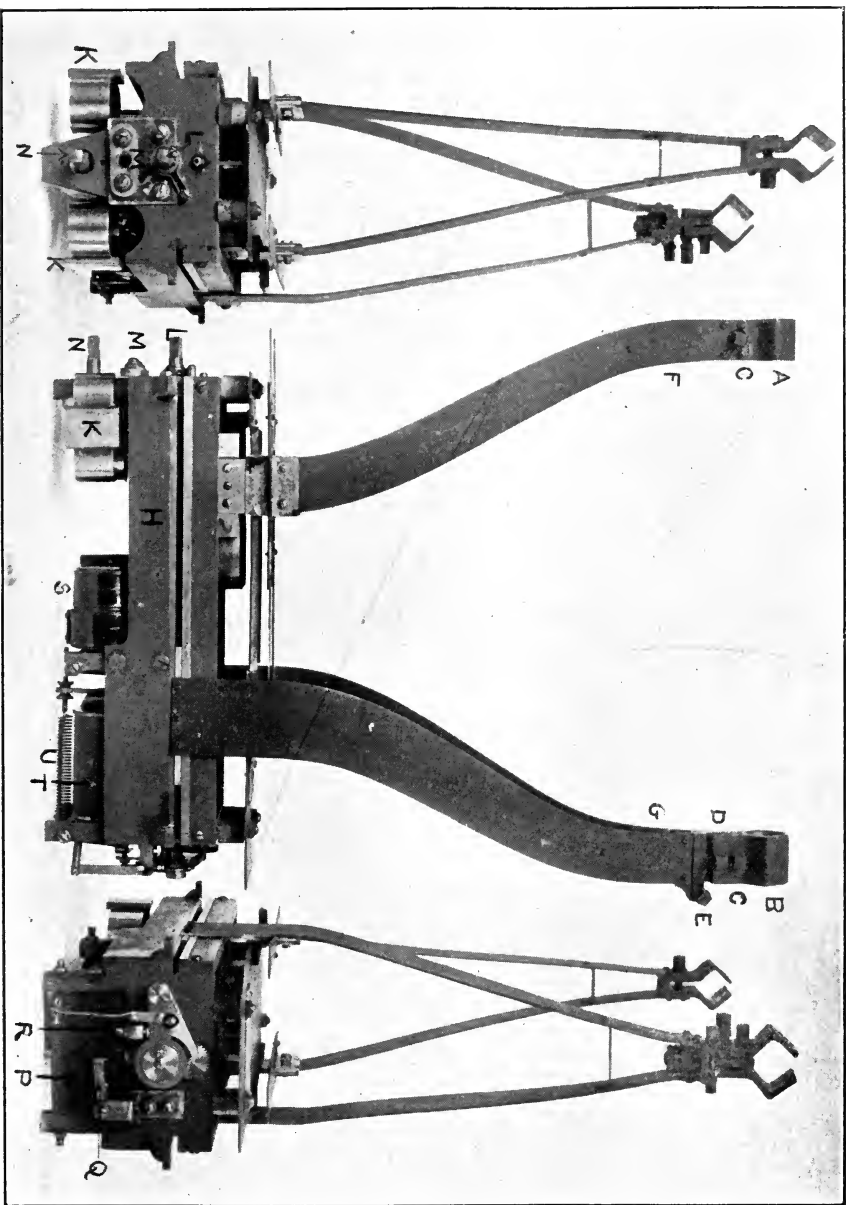

Lamp Mechanism of Searchlight.



LIBRARY
OF THE
UNIVERSITY
OF
CALIFORNIA

2. Secure them in their holders with the negative carbon—that is, the smaller one—nearest the mirror.

3. See that they are in alignment—that is, that the axis of the positive carbon is approximately in prolongation with that of the negative. Should they not be properly aligned, adjust them by means of the adjusting screws indicated in Plate XXXVI.

Make sure that the carbons are clamped securely, so that when the drum is elevated they will not be thrown out of alignment, or drop back and spread the arc, giving it abnormal length. The carbons should have about $\frac{3}{4}$ of an inch play between the tips when separated. Then bring the carbon tips approximately in the focus of the beam by means of the focusing screw. The drum is marked, that is, the finder in the drum is marked to indicate this position. If the start is made with carbons that have been used before and the crater is not evenly formed, part should be broken off and reamed out before the start is made.

5. Feed the carbons together by turning the feed screw until they nearly touch and turn the current on.

6. Keep the current as near normal as possible, as this assists the crater in forming properly.

7. After the lamp has been operated long enough for all parts to reach their normal temperature and the arc has become normal, run the carbons apart slowly and note the voltmeter reading at the first stroke of the magnet. If the voltage is above the normal voltage as given across the arc for the lamp in question, loosen the feed spring U shown in Plate XXXVI, until proper adjustment is made. Should the voltage be below the normal, tighten the same screw. It is necessary that this adjustment be made when the lamp is in the horizontal position.

8. Focus the lamp by bringing the arc directly on the cross wires of the ground-glass finder and note if the rays leave the mirror parallel.

CHAPTER IX

SUBMARINE MINES, SMALL BOATS, ETC.

IN case of heavy fog, or at night when an attack is unexpected, or even when expected, the possible failure of searchlights makes it imperative to provide some final means of defense. An adequate submarine defense has been developed in the U. S. Coast Artillery service, and consists of a submarine mine containing an explosive charge, a firing device, and the necessary arrangement for testing and signaling. The whole is inclosed in a water-tight case, and is intended to be submerged in the waterway or entrance to important harbors, and naval bases.

A submarine mine is not a torpedo, although frequently referred to as such. The device just described, when submerged the proper depth under water, and anchored in position, is a submarine mine, while a torpedo consists of a case containing a charge of explosive, a firing device, and a device for propelling it through the water. The submarine mine is fixed in position, and its functions are purely defensive, while the torpedo is both defensive and offensive.

Submarine mines are of two distinct classes with regard to their use in respect to position, and are classified as buoyant and ground mines. The buoyant mine is one that floats in position, and has such an excess of buoyancy that if it were not anchored in position as shown in Fig. 66, it would float on the surface. These mines are designed to be submerged and held in position by anchors. A ground mine consists of a case containing an explosive and a firing device, and is heavier than the amount of water it displaces, and therefore, requires no anchor, and sinks to the bottom.

Mechanical and Electrical Types.—Submarine mines are further classified as mechanical or electrical, depending upon their means of firing.

A mechanical mine is a non-controllable mine, and may be either electrical or purely mechanical. They carry their own firing apparatus, and when once planted, are equally dangerous to our own and to the enemy's vessels. They are non-controllable to such an extent, and such

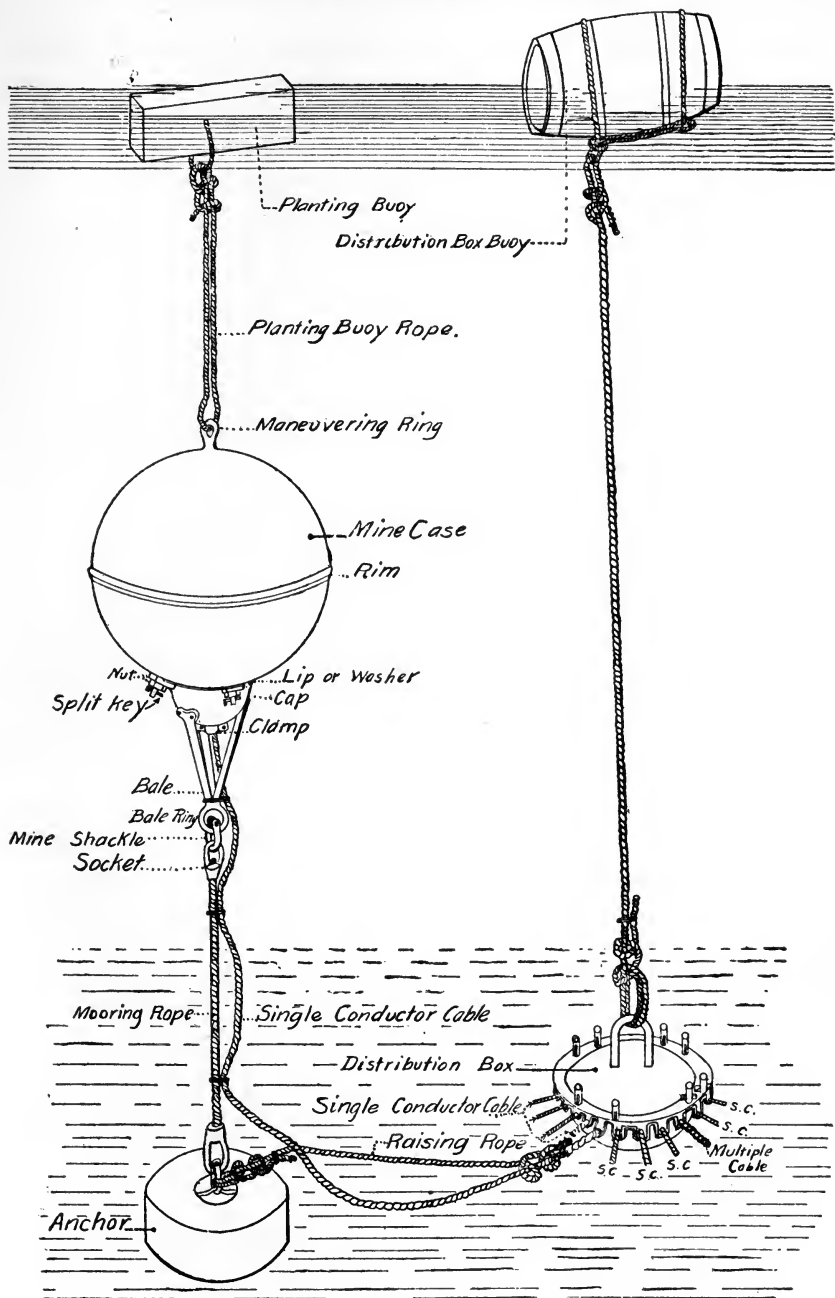

FIG. 66.

a menace to the commerce of friendly nations and non-combatants that their use in modern warfare is rapidly being dispensed with.

The electrical mine adopted in our system and in most modern systems, is controllable and can be made perfectly safe or equally dangerous by the manipulation of the electrical features. The electrical mine is arranged so that it may be fired at the will of the operator; on contact with an enemy's vessel, or after a contact and a signal has been given.

To properly protect the entrance to a harbor or naval base, it is thought that at least three lines of submarine mines are essential. The exact location of these different lines of mines involves considerations with reference to the other defenses of the harbor considered. Their location must also depend upon the width and depth of the channel, the swiftness of the current, conditions of tide, bottom, and difficulties of planting.

A mine field must be properly protected by shore batteries in order to become effective. Mine-fields which are susceptible to raids by the enemy may be considered as not fulfilling their proper function, as their protection would require the explosion of mines when tampered with, which is not the proper function of a submarine mine defense. The proper protection for the mine fields is that of rapid-fire shore batteries, submarine boats and torpedo boats, in order that raiding parties of the enemy may be met in the same manner in which such tours are ordinarily carried out.

The ideal location of a mine field would be that which would require the vessels of a hostile fleet to be held in the zone of most effective fire of the heavy guns. This zone lies between 4,000 and 8,000 yards from the main defenses of a harbor, and is beyond the interior limit of effective mortar fire. It can readily be seen, therefore, that any mine field which would break up the formation of an enemy's fleet in this effective zone, in addition to the possibilities of the total destruction of the vessels themselves by the mines, would result in the fleet being exposed to the destructive fire of the heavy batteries where that fire is most effective. In the location of mine fields it is also essential that the outer line be sufficiently extended so that in case of fog, thick weather, and darkness, the presence of the enemy will be made known before it is too late to prevent an effective run-by.

The essential elements of a mine command consist of the fire-control system, the rapid-fire batteries, the mining casemate, the loading room, a storehouse for mine material, sufficient cable tanks for the storage of submarine mine cable, the searchlight system, the magazine and

explosives, as well as a means to transport and handle this material, the necessary boats for carrying out the duties of putting the mines in position, the repair of the mine fields, and some means for the test, care and preservation of the above elements.

The Fire-Control System.—The fire-control stations of a mine command are provided with range finders, and in the mine primary station a telescope, a plotting board, a prediction ruler, time-interval bell, stop watch, and the necessary telephones to the post switchboard, mining casemate, searchlights, loading room, and rapid-fire gun batteries. The operation of the apparatus is similar to that of the other fire-control stations. The use of the plotting board has been fully explained under the heading "Submarine Plotting Board."

The Mining Casemate.—This is usually a substantial building either of masonry or frame, one story high, and about 30×60 feet in dimensions. It is located in such manner as to protect it from attack from the land front as well as fire delivered from the entrance to the harbor.

The equipment of the mining casemate is necessarily kept a secret. Its purpose, however, is to explode the mines at the proper instant, and to control and test them after they are planted.

The Loading Room.—The duties of the loading room include the mechanical and electrical operations necessary for preparing the mines for planting. Such operations are divided as follows:

1. Making turk's-heads:
 - (a) Single-conductor cable.
 - (b) Multiple cable.
2. Making telegraph joints.
3. Making okonite joints:
 - (a) Uniting two single-conductor cables.
 - (b) Uniting multiple cable and seven-branch cables.
 - (c) Uniting multiple cable and mine cables.
 - (d) Uniting mine cable to loading wire.
4. Preparing compound plug for buoyant mine.
5. Loading and testing compound plugs.
6. Loading mines.
7. Assembling a group of mines.
8. Attaching mooring sockets to cable.
 - (a) Preparing mooring ropes—rule for lengths.
9. Insulating exposed cable ends.

The loading room is in charge of a non-commissioned officer (Chief Loader), who is selected for his knowledge of the subject. In performing

his duties he should keep the detachment busy at such parts of the work as the several details are best fitted to perform, exercising care that no accident occurs from carelessness or neglect; to make the necessary electrical tests; to keep himself informed as to the general progress of the work so that no part may fall behind and create unnecessary delay; and finally to allow no unauthorized persons in the building.

Making a Turk's-Head.—In submarine telegraph cables the armor is jointed by a long running splice with the iron wires, similar to the splicing of a rope to run through a block. In case of necessity, the same device may be employed in the mine service, but the method of turk's-heads is greatly to be preferred when junction boxes are at hand—and it must be exclusively used in connecting the cable to the mines.

To make a turk's-head (Fig. 67 *a*), one private equipped with a navy

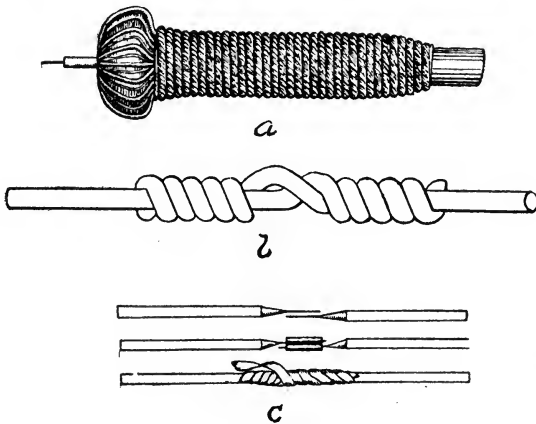

FIG. 67.

knife, cutting pliers, hammer, turk's-head collar (large or small), and about 14 feet of marline is required.

If the object be to splice a single-conductor cable, or to unite a multiple cable to several cables, the turk's-head will be made first; but if it be desired to attach the cable to a mine or mine buoy, the free end will first be passed through the clamping hole of the mine cap. In either case, the turk's-head will be made in the following manner:

Trim the end square; at 15 inches from it place a wrapping of four or five turns of marline overlapping each other round the cable, and finally secured by a square knot, to form a stop for the collar; slip on the collar, flat side first until it rests against the stop of marline; unwrap the jute covering, and bend it back regularly over the collar; do the

same with the iron wires and the interior hemp serving; cut off the iron wires with the pliers, removing about 4 inches from one, and 6 inches from the next, alternately; trim off about 4 inches from the jute and hemp wrapping; bend the iron wires separately to closely fit the collar (making two right angles with the pliers) and arrange the ends smoothly along the cable; engage the end of a strand of marline under one of the wires near the collar, and wrap it regularly and closely around the cable, until a point about one inch beyond the end of the jute and hemp is reached; then, secure the free end of marline with two half hitches. About 12 feet of it are required. Where time is important the wrapping of marline may be reduced to a couple of half hitches (near collar) drawn tight.

In case no collars are at hand, a wrapping of marline of similar form may be substituted.

If the object be to splice one cable to another, the turk's-heads are placed in their clamps in a single junction box, the cores are jointed, and the parts of the junction box are bolted together, great care being observed not to injure the exposed parts of the cores coiled inside, and to see that the wrappings of the turk's-head are so firmly clamped that no motion is possible.

If a multiple cable is to be connected to single-conductor cables, a distribution box will be used. The turk's-heads will first be secured; then the cores will be united; lastly, the box will be bolted or keyed together.

If the cable is to be jointed to a mine or mine buoy, the turk's-head is first drawn up until the swell is in contact with the cap, and the clamps are then bolted fast. It is essential that the clamps shall take a firm hold; and if the iron jaws touch, it is sufficient proof that there is not enough marline wrapping. Afterwards the cores are jointed, and the cap is immediately screwed to its seat. Care must be taken to avoid any unnecessary bending or twisting of the cores, and no pulling whatever must be allowed.

Telegraph Joint.—(see Fig. 67*b*). The ends of the wires to be jointed are bared and brightened for about $1\frac{1}{2}$ inches, the bared ends are laid across each other at an angle of about 45 degrees, the point of crossing being about one-third the distance from the insulation of the ends. With a pair of pliers, grasp the two wires firmly at the crossing; then wind closely and tightly the free end of each wire around the short bared part of the other, shifting the pliers, if necessary, after wrapping one end and before beginning on the other, so that the two wrappings begin as close together as possible. The two windings

should run in opposite directions. The end of each wire at the end of the wrapping is trimmed or hammered down so as to leave no projecting sharp points. When completed in the manner described the joint should not give in either direction. To insulate the joint a piece of rubber tape, 2 inches long, is cut from the roll, the cut running in a diagonal direction across the strip. Beginning well back on the insulation the tape is applied under strong tension, each turn overlapping the preceding one by about one-third of its width. This winding is continued forward and backward, sometimes in a straight and sometimes in a diagonal direction, until the strip is used up and a substantial insulation is secured. The end of the rubber tape is secured by firm pressure continued for several seconds; a little rubber cement may be used to insure adhesion. This joint is used in connecting the fuses.

Okonite Joint.—This joint is now prescribed for use in uniting all conductors of cables placed under water or exposed to dampness. The following is prescribed as the method of making the okonite joint:

The ends are bared and cleaned, then beveled like a sharpened lead pencil (see Fig. 67 *c*), using a very sharp navy knife; roughen the beveled part and half an inch of the insulation with the knife or file and wipe clean with gasoline.

The wires may be joined in three ways:

1. By using a brass jointer, in which case about $\frac{3}{4}$ inch of the ends of the conductor is bared; the wire is secured by compressing the longer diameter. Smooth off any rough edges with a file.

2. By a telegraph joint, in which case about 4 inches of the ends of the conductor should be bared.

3. By the following method: bare about 4 inches of the ends of the conductors, separate the wires of each for about 2 inches, cut out the center wire, and spread out the others radially; then put the two ends together as in splicing a rope, each wire opposite the space between two in the other end; bend the wires of one end through the spaces of the other and wrap them closely and regularly around it; then do the same with the other end. If carefully done, the joint will be of smaller diameter than the telegraph joint.

In either method, work the wrapping tightly with the pliers and be careful to have no protruding ends. The joints, unless sleeves are used, should show about 2 inches of bare wire when wound. With sleeve only a little bare wire should show on either end of the sleeve. Be careful not to touch the beveled insulation with the fingers, and handle the bare wire as little as possible.

Now cover the bevels and joints with a thin coat of okonite rubber

cement, allowing the solvent to evaporate thoroughly; cut a two and one-half inch piece of okonite tape with diagonal ends and, beginning at the beveled insulation, cover the joint by applying the tape under such tension that its width is about two-thirds its normal value.

The layers of tape should overlap and should be stretched as applied, not before beginning the joint.

Repeat the above with a piece of tape about eight inches long, beginning well back on the insulation.

If tinfoil be on hand, cover with this and then with Manson tape; heat in the edge of a torch or alcohol flame, turning so as to expose the entire joint until the Manson tape becomes slightly pasty; the time will be about one minute; take off the tape and tinfoil and re-cover with two layers of Manson tape.

Gasoline or alcohol on a piece of waste answers well for heating joints in a boat.

The object of heating is to convert the tape into one compact mass which offers the same resistance as the original insulation of the wire.

The joints may be made without the rubber cement, but it requires much more care in heating to get proper vulcanization.

Loading Mines.—The mine cases are carried from the storeroom to the loading room on the platform cars provided, and placed on the loading skids with the caps up. The caps are removed and placed nearby, washers, nuts, and keys being placed near them. All screw threads are then thoroughly cleaned by use of kerosene and the necessary cleaning brushes. The mine case itself should be wiped out, and, if it has been in the water previously, dried out. The explosive detail then brings the explosive from the magazine to the loading room and it is inserted in the mine case through the loading hole. If dynamite is the explosive used, a loading funnel should be placed in the loading hole before any of the cartridges are inserted in the mine case. Care should also be taken that the cartridges are not broken, and that canvas is placed on the floor around and underneath the mine case. Only one box of explosive for each mine being loaded is allowed in the loading room at any one time. When the proper amount of explosive has been placed in the mine case the screw threads are thoroughly cleaned with button brushes and then coated with rubberine or other waterproof material. The compound plugs, having been assembled, are then screwed home with the socket wrench, a loading washer being first placed between the plug and the mine case. Sufficient force should be used in screwing the compound plug home to insure making

the joint water-tight. The end of the lever inserted in the openings of the socket wrench should be tapped several times with a mallet to insure tightening. The mine cases are then put in the testing tank, and, if time is available, allowed to remain there for at least twenty-four hours before the test is made to determine whether the circuits have been correctly made and the joints made water-tight. This test can either be made by running or by extending the milliammeter lead from the mining casemate to the loading room and taking a reading of each mine, as is done after planting; or, the test may be made by using a portable voltmeter and four dry cells. The test should show the resistance of the loaded mine to be between 2,200 and 2,400 ohms.

Duties on the Water.—Time will usually be of the utmost importance when a channel is to be mined, and success will very largely depend upon the officer in charge of the harbor mine defense in so arranging the work as to avoid delays and keep everyone constantly and actively employed. For the work on the water specially constructed boats known as "mine planters" are fitted up for quickly placing the mines in position. In addition to a mine planter it is necessary to have at least four small boats. One of these, known as the distribution-box boat, is equipped with a gasoline engine, and should be provided with its own power for hoisting the distribution box and at least a 500-pound anchor. The other three boats are the ordinary yawl boats. Assuming that a group of mines has been loaded, assembled and placed on the planting wharf, the duties on the water would be carried out in some such order as given below:

The chart showing the approved scheme of mine defense is first consulted and the locations of the distribution boxes noted. These positions are also marked on the mine plotting board. The mine planter, with the necessary buoys and anchors, proceeds to the mine field, and from some prearranged signals from the base-end stations drops anchors with the keg buoys attached at the positions of the distribution boxes as indicated on the mine plotting board. The mine field is next laid out.

It is next necessary to take soundings along the line of mines in order to determine the lengths the mooring ropes and the lengths the single conductor cables should be cut. If automatic anchors are used such information as may be required about the depth of water can usually be obtained from charts, but such information is not sufficiently accurate for planting with the ordinary anchors.

The soundings are made either with the launch from the mine planter or the distribution-box boat assisted by the yawl boats. The

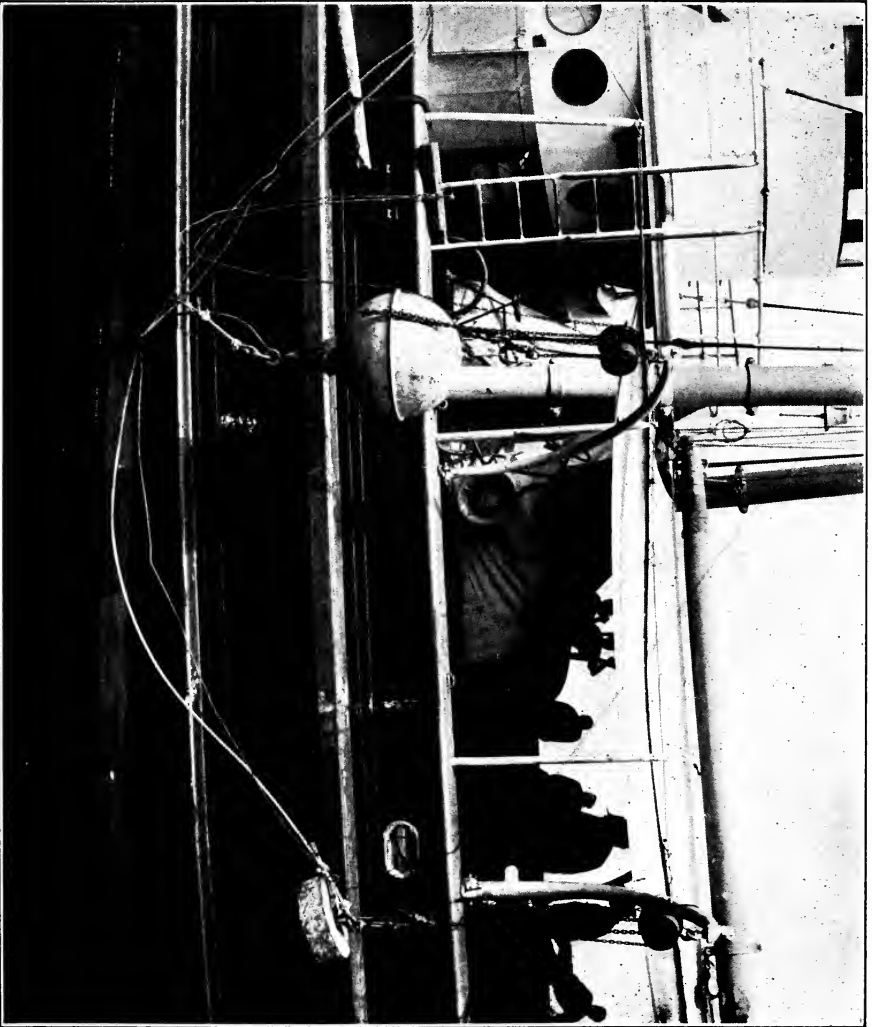

Mine Planter with Mines Assembled Ready for Planting.



LIBRARY
OF THE
UNIVERSITY
OF
CALIFORNIA

launch moves along the line of mines and takes soundings at the proper intervals, these readings being recorded in a blank book showing the number of the mine and the time of day. It is necessary that the tide station be manned during this time and the operator in charge instructed to keep a record of the time of day and the tide readings taken at least every fifteen minutes.

The planter then lays the multiple cable from the shore terminal to the distribution box for each group. The multiple cable is cut and the end passed to the distribution-box boat, usually by a heaving line. The men in the distribution-box boat make a turk's-head upon the end of the multiple cable and finally put it in the proper slot in the distribution box. As a precautionary measure for recovery of the distribution box should it be pulled overboard during the operations of planting, it is well to buoy the multiple cable about 100 yards in rear of the distribution box. As soon as the end of the cable has been put in the slot, the conductors of the multiple cable are spread out preparatory to identification.

In numbering the conductors at the mining-casemate end, or shore end, they are numbered clock-wise, commencing with the marked numbers. At the distribution box they are numbered contra-clock-wise, commencing with these same numbers, for communicating with the casemate, the central conductor, is the one to which the boat telephone is attached.

After the ends have been numbered and communication established with the casemate, the casemate electrician then directs the distribution-box boat to prepare the ends of the cable for test. When this has been done word is sent to the casemate electrician, who makes the prescribed test of the cable to determine any leaks. The ends are next tested to determine if they have been properly numbered.

While these operations have been going on the mines have been taken aboard the planter and arranged for planting, as shown in Plate XXXVII. This is done by the detail on each side of the planter preparing the mines on its side for planting.

The mine planter then moves out towards the mine field, passing as close to the distribution-box boat as precautions for safety will permit—passing it on the starboard; that is, having the distribution-box boat to port. The heaving line is thrown well forward of the distribution-box boat, caught or picked up by the party in the boat and secured at once to a cleat, and after the mine is dropped pulled in and inserted in the proper slot for the mine in question. A temporary joint is then made between it and the proper conductor of the multiple

cable and the casemate electrician asked if the mine tests out satisfactorily.

If the casemate electrician informs the boat party that the mine tests all right the joint is made permanent.

After the last mine is planted the telephone is first put on the single conductor and the casemate electrician informed that the boat party is ready to make a joint for the last mine planted. When the last joint has been made the distribution box is closed and a buoy rope, attached to a buoy, is made fast to its lid. The anchor of the distribution-box boat is raised and the distribution box then lowered.

CARE AND PRESERVATION OF EQUIPMENT

One of the important duties that the personnel of mine companies are called upon to perform is the care and preservation of the armament, material and equipment, comprising and pertaining to the mine defense, which consists of the following:

At Fire-Control Stations.—Position-finding instruments, plotting boards, prediction rulers, azimuth instruments, telephones, time-interval clock and bell, controller for searchlight and the necessary charts.

At Mining Casemate.—Storage battery, oil engine, generator, power panel, operating boards, casemate transformers, motor generators, and telephones.

At Loading Room.—Telephones, traveling cranes and triplex block, vises, and such tools and material as may be in the loading room for use or purposes of instruction.

At Cable Tanks.—19-, 7-, and 1-conductor cable, traveling cranes, triplex blocks, and apparatus pertaining to water supply.

At Boathouse.—Submarine-mine yawls, oars, boathooks, oar-locks, ropes and tackle for raising and lowering boats.

At Storehouse.—Mine cases, compound plugs, circuit closers, anchors, anchor shackles, mine shackles, mooring sockets, mooring cable, distribution boxes, junction boxes, ropes, small tools and appliances, traveling cranes and triplex blocks.

Paints and oils should be kept separate from other stores, either in different buildings or some other convenient place. The floor where such stores are kept must be covered with sand two or three inches thick, and the same renewed at intervals. Kerosene oil must be kept apart from other oils and paint.

At Magazine.—Explosives. Primers and fuses are kept in a separate room of the magazine or some other convenient place.

At Searchlight Shelter. Searchlight, rheostat, switchboard, telephone and necessary appliances. If the searchlight does not receive its power from a central plant, add generating set to the above.

At Rapid-Fire Gun Batteries.—Guns, carriages and necessary equipment and appliances.

SUPPLIES, TOOLS, ETC., AND THEIR USE.

The supplies necessary for cleaning mine material are: Kerosene, gasoline, benzene, alcohol, pomade, sandpaper, emery cloth, crocus cloth, and cotton waste.

The tools used in cleaning mine material are: steel scrapers, wire brushes, paint brushes, button brushes, chamois skin, and soft cloth.

The supplies necessary for preserving mine material are: cosmic-dense, white and red lead, beef tallow, varnish, raw linseed oil, lard oil, and sperm oil.

Cosmic-dense is applied to bright parts of oil engines, generators, and motor-generators, when out of commission. It is also applied to brass screw threads, parts of triplex blocks and trolley systems, as well as to all tools that are liable to rust. It should be renewed three times a year.

White lead is used for painting mines, and in lead tallow mixture.

Red lead is used for the first coat on mines when taken from the water and after rust has been removed; also for first coat on oil engines. The mixture for first coat consists of 100 pounds red lead to 5 gallons raw linseed oil. One gallon of paint to each ten mines.

Beef tallow (rendered) is used in white lead-tallow mixture for smearing the screw threads of mine cases, steel screw threads of compound plugs, bolts, nuts, washers, and all surfaces of flat joints. The mixture consists of one part white lead, to four parts beef tallow. The mixture is melted and applied to surfaces while hot.

Raw linseed oil is used in paint mixtures. For priming coat: 5 gallons to each 100 pounds of red lead. For painting mine cases neutral gray; $2\frac{1}{2}$ gallons to each 100 pounds white lead, $2\frac{1}{2}$ gallons turpentine, 1 gallon liquid dryer, and 1 pound lampblack.

Asphaltum varnish is used for painting anchors, distribution boxes, fuse cans and plug proper of compound plugs, junction boxes, shackles, sister hooks, and iron work of operating boards and power panels.

Lard oil is used for preserving copper or brass parts and screw threads.

Sperm oil is used on the iron and steel work of electrical instruments, and on tools to keep them free from rust.

No oil should be used on electrical contacts.

Care of the Storage Battery.—Take daily readings of the pilot cell, making record of specific gravity, voltage, and temperature of the cell. See that the battery is given regular weekly charge at normal rate. Examine the plates with battery lamp for sulphate (white deposit on the negative plate), buckling, blistering, or anything unusual in their appearance. Always keep electrolyte at proper height in each cell (one-half inch from top). Comply carefully with the special instructions issued regarding the care of the storage battery.

Care of Dynamos and Motor Generators.—See that all surfaces are free from rust, dust or dirt. See that oil holes or oilers are kept filled; that all connections are tight; that there are no loose nuts or contacts; that brushes are in good condition, *i.e.*, bear evenly and are not chipped or covered with foreign material; that when brushes are worn they are replaced in due time with new ones.

The commutator should be smooth, free from grit, and clean throughout; slight inequalities should be removed by running the generator with the brushes off and allowing a block of wood properly beveled and covered with *very fine* sandpaper (not emery paper) to bear evenly on the rough surface. The machine should be protected with rubber or canvas paulins whenever possible.

Care of Power Panels or Operating Boards.—All connections should be examined to see that they are tight, contacts and switches clean, dry, and free from dust, oil or gum of any description. Switches adjusted so that they are not loose nor wobbly; when thrown they should make or break the circuit evenly and without unnecessary sparking. No verdigris should be allowed anywhere.

Care of Electric Lights.—Lights should be kept clean at all times. Switches should not be permitted to spark badly without being replaced. Burnt-out or dim lamps should be replaced immediately. An extra supply of fuses should be on hand to replace any that may be blown out. Only fuses or fuse wire should be used for this purpose.

Care of the Oil Engine.—All bearings should be kept smooth and well lubricated. Oil cups kept constantly filled.

Before the engine is started care should be taken to see that the water tank is clean and free from mud or sediment, and that it is full of clean water, the water to be above level of top pipe. Oil tank full

of kerosene oil. Under no circumstances should gasoline oil be used in the engine. Before starting see that the two cocks which supply water to the vaporizer valve box water jacket are fully open; also the cock on main water pipe from bottom of the tank. The spray nozzle and vaporizer must be kept free from carbon. The piston must be clean and well oiled; the khotal lamps clean, free from soot and always filled. A small bottle of wood alcohol should be at hand for starting up lamps, also asbestos wicks in cups under burners.

In frosty weather the water must be drained out of the cooling tank, circulating pipes and water jacket, in order to prevent damage from freezing.

Care of Machinery Being Placed Out of Commission.—All bearing surfaces are carefully cleaned and covered with white lead and lard oil (white tallow mixture); all small loose parts are removed, covered with cosmic, wrapped in burlap and put in a small box, when practicable. The box should be plainly marked and stored under cover. The machine if not already under cover should be housed or protected in some way.

Storage of Mines.—Mines should be cleaned and painted, the screw threads covered with the lead-tallow mixture and the holes fitted with wooden plugs which have been thoroughly greased. They are then stored on racks or skids in the storeroom. Mine cases should not be stored in contact with each other where it can be avoided.

Small Boats.—A small boat may be defined as any small open vessel moved by oars. Those used in connection with submarine mine work may be either cutters, gigs or yawls, usually the latter.

The curved piece of timber to which the sides of a boat are united in the fore end is called the *stem*. The bending or rounded part forward is called the *bow* or *proW*. The middle portion is called *amidships*. The after or rear end is called the *stern*. *Fore* implies the portion forward; *aft* or *abaft* means toward the stern. The longitudinal timber, or series of timber scarfed together, extending from stem to stern along the bottom is called the *keel*. That part of the bottom which is broadest and most nearly flat is called the *bilge*. The width of a boat is expressed as the *beam*.

When the boats are constructed of planks running fore-and-aft, their edges meeting but not overlapping, they are called *carvel-built*. When the planks run fore-and-aft and their edges overlap, they are called *clinker-built*. When the planks run in a diagonally opposite direction from the outside layer, they are called *diagonal-built*. The seats on which the crew sit are called *thwarts*. When two men pull on one oar it is said to be *double-banked*. Boats are called *single-* or *double-*

banked, if they have one or two men to a thwart. The space abaft the after thwart is called the *stern-sheets*.

The notches for the oars are called *rowlocks*; if wooden pins are set in the rails they are called *thole-pins*; if metal forks or stirrups are used they are called *oarlocks*. Purchases made with two blocks and a length of rope (used for hoisting boats) are called *boat-falls*. A line made fast to a ring-bolt in the stem is called the *painter*.

The upper rail of a boat is called the *gunwale*. The piece of wood or metal filling across the head of a boat's rudder is called the *yoke*; lines attached to it are called *yoke-lines*. The bottom boards of a boat are called *floorings* or *gratings*. A small keg used for carrying fresh water is called a *boat-breaker*.

The signal used to order boats to return is called *boat-recall*.

Boat Drill.—The small-boat detachments place in their respective boats the necessary oars, oarlocks, life preservers, buckets, and heaving lines.

The men are numbered in each detachment as follows:

Nos. 1–3–5 on starboard oars, No. 1 on bow oar;

Nos. 2–4–6 on port oars, No. 2 on bow oar;

No. 7 in bow to man boathook or heaving line.

Non-commissioned officer at rudder.

No. 1 enters boat and makes ready to cast off bridles when boat is lowered. All being in readiness, the boats are lowered at once by the remaining members of the crew at the command: *Lower*.

When the bridles have been cast off, the No. 1 of each boat mans the boathook, and holds boat alongside the ladder until the remaining members of the crew take their seats.

Shove Off.—At this command, No. 7, the bowman, shoves the boat clear, being careful to clear the piling in leaving the boathouse or mooring.

Up Oars.—The crew simultaneously seize and raise their oars to the vertical position. The oars being held directly in front of them, the blades fore-and-aft, and the handles clear of the bottom of the boat. The oars are held by both hands.

Let Fall.—The oars are lowered quickly into the oarlocks, brought level with gunwale, blades brought horizontal, and all trimmed on the aft oars.

1. *Give Way Together.* 2. *Give Way.*—At the first command, the men reach well forward, blades nearly vertical, and get ready for the stroke. At the second command they dip their oars at the same

time as the stroke oar, and commence rowing, keeping stroke with the men directly in front of them, and all lifting their blades to the height of the gunwale on the return. Oars must not splash under any consideration.

In Bows.—In case no extra man is in the bow to man the boat-hook, this command is given when making a landing alongside of a vessel, or a wharf. The bow oarsmen finish their stroke, then "toss" their oars into the boat, and lay them with blade to the bow. No. 1 then takes the boat hook and stands ready to fend off and hold the landing. When the boat has sufficient headway to carry it properly to the landing, the command is given.

Way Enough.—This command is given while the oars are in the water; the stroke is finished, and the men toss their oars all together, and lay them in the boat. The oars are put next to the rail, blades towards the bow. The oarsmen remain seated until given further command.

1. *Stand by to lay on oars.* 2. *Oars.*—This command is given if it is desired to stop rowing temporarily. At the second command, given while the oars are in the water, they finish their stroke, and bring their oars level with the gunwale, blades horizontal, trimmed on after oars.

1. *Trail.* 2. *Oars.*—This command is used in passing under bridges or wharfs where the room is insufficient to toss oars. The second command is given while the oars are in the water; the stroke is finished, the oars thrown out of the oarlocks, and are allowed to trail astern. To bring the oars back inboard the command: *Oars*, is given.

1. *Give Way, Starboard; Back-port.* 2. *Give Way.*—This command is used to turn the boat short around to the port.

1. *Give Way, Port, Back-starboard.* 2. *Give Way.*—Same as preceding command, to turn the boat to starboard.

After either command, when the boat has the desired direction, the command is given: 1. *Give way together.* 2. *Give way.*

Hold Water.—This command is given when it is desired to stop the boat's headway. The blades of the oars are held vertically in the water. To resume rowing the command: *Oars*, is given and the crew takes the position given under the command: *Let fall*.

Stern All.—This command is given when it is desired to move the boat astern. The crew back water, keeping stroke as in the regular way. To resume rowing in the regular direction, the command: *Oars*, is given.

1. *Stand by to Toss.* 2. *Toss.*—This command is given near the

end of a stroke. The oars are raised quickly to the vertical position as in *up oars*.

If it is desired to put the oars in the boat, the command: *Boat, Oars*, is given, at which the oars are lowered towards the bow, and laid in the boat as previously described.

CHAPTER X

SEACOAST ENGINEERING

SEACOAST engineering may be divided into two general classes. The first comprehends the location, arrangement and construction of emplacements for seacoast armament; while the second appertains to the: (1) Location and measurement of horizontal base lines. (2) Triangulation in connection with the location of horizontal base lines, gun centers, and directing points of batteries. (3) The determination of the true azimuth. (4) The location of pintle centers, and orientation of gun and mortar azimuth circles. (5) Leveling. (6) Principles of hydrographic surveying.

The first division is a function of the National Defense Board and the Corps of Engineers. In this connection fortifications are situated so as to be a reasonable strategic distance outside or in front of the point to be defended, with a view to preventing the ships of the enemy from lying within effective bombarding range of such points without being liable to injury from the armament of such fortifications.

Consideration is given to the location of gun batteries: (1) With a view to their efficiency under conditions described above. (2) With a view of compelling the enemy to pass them in a clear waterway. (3) With a view of restricting the front of the enemy, if practicable, and at the same time have a convergent fire upon him. (4) With a view of having the batteries at such a distance apart as to prevent the concentration of the enemy's fire upon them and still allow for mutual support. (5) With a view of not masking or limiting the field of each other's fire and at the same time not permitting the enemy's fire to enfilade nor take them in reverse. (6) With a view to the protection of their flanks and rear so that they cannot be cut off by small landing parties. (7) With a view to their concealment, so that their location, height, and azimuth will not be discovered by the assailants.

Consideration is given to the location of mortar batteries: (1) With a view to their command of dead angles which cannot be reached by rifle fire. (2) With a view, if practicable, of placing the channel in a

single zone. (3) With a view, if practicable, of covering all anchorages in the inner harbor.

All landing points are, when practicable, covered by rapid-fire guns.

BASE LINES, ETC.

Location and Measurement of Horizontal Base Lines.—In determining the location of a horizontal base line the following conditions should be fulfilled as far as practicable. (1) Its length should be as long as possible and 2,000 yards when practicable. (2) An uninterrupted view of the whole field of fire, or that portion of the field of fire which the base line is to serve, should be obtainable. (3) Both base ends should be in such position that they will not be exposed unnecessarily to the fire of attacking vessels. (4) Both base ends should be readily accessible and the stations located so that they are invisible from the field of fire. (5) Base lines crossing water areas should be so located that the communication cables can be protected from raiding parties and are not unnecessarily exposed to anchorage areas. (6) The direction, length and general location of a base line should be such that the lines of sight converging from its ends upon the target at different parts of the field of fire shall intersect at favorable angles, and thus furnish ranges and azimuths to the guns with a minimum of error. (7) The base ends should be so located that observation from the stations will not be interfered with by smoke from the batteries.

After the location of the base line has been agreed upon the first step is to mark the base ends, which is ordinarily done by sinking a stone post in the earth two or three feet and extending a few inches above the surface of the ground and by indicating on the top of such post a center. This is usually done by drilling a quarter or half inch hole in the stone and putting in a copper plug, the center of the copper plug being marked by the intersection of two of its diameters.

The actual measurement of a base line is made with steel tapes usually of one-hundred foot lengths. A sufficient number of marking stakes should be erected between the two ends of the base line before the measuring commences. These consist of pieces of scantling about 3 or 4 inches in cross section or even less, sharpened at one end, and sufficiently long to project about one and one-half feet above the surface when driven firmly in the earth. The upper end should be capped with a strip of zinc or tin. The stakes are aligned from the initial point by setting a transit up, sighting on the opposite end of the

base line and then clamping the instrument in the direction of the proposed line. The marking stakes are then brought into line and driven to approximately the same level. The height of the upper surface of each stake above the assumed datum level should be determined by using the Y level and leveling rod.

The accuracy required for base lines used in artillery work is taken as 1 in 50,000, that is, a permissible error of one foot in 50,000 feet. In order to obtain this degree of accuracy the temperature of the tape at the time of measurement, to the nearest degree, must be taken; the slope determined by stretching over stakes whose elevation above a given datum are known, and the pull on the tape measured by spring balances. The work should be done in cloudy weather and with little wind.

The actual measurement of the base line is conducted as follows: The tape is stretched over two stakes by two assistants, one in rear of the rear stake and one in front of the forward stake. The spring balance is attached at the forward end, and in stretching care must be taken not to bring a strain on either stake. The rear end graduation is made to coincide exactly with the initial point or a scratch on the zinc cap of the marking stake which indicates the forward end of the previous tape length. A pull of from 10 to 15 pounds is applied and when the tape is sufficiently stretched the forward end is marked. The thermometer should be carried about the height of the tape when stretched and in such position as not to be affected by the heat of the body. A reading should be taken as each stake is marked. The process is repeated from one marking stake to the other until the end of the base line is reached. An accurate record of the data should be made. The tape should never be dragged on the ground on account of possible injury thereto and the variation which would be caused in the temperature of the same. The line should be measured at least twice and any discrepancy at the last stake being measured by a finely graduated scale.

For the accuracy desired in artillery base lines the tape should not be stretched by hand, as it is impossible to hold the tape graduation steady at a given point or to apply a steady pull. Any device which can be placed firmly in position and which involves the principle of the lever or the screw should be used to get a steady pull on the tape.

The base line having been found to consist of a certain number of tape lengths, it is necessary to know the horizontal distances between the ends of tape lengths before the length of the base line can be calculated. These will differ among themselves on account of the

difference in slope, temperature, etc. It is, therefore, necessary to know the distance between the end marks of the tape under one set of conditions as to temperature, tension and sag, in order that its length under any other conditions may be calculated.

If these data cannot be obtained from the maker, recourse may be had to the National Bureau of Standards, Treasury Department, where the determination for tapes up to 300 feet in length is made free of charge. This information will usually be given in the following form: Its graduated length, say 75 feet, is the true distance between its end graduations when the tape is subjected to a certain stated pull (P), at a certain stated temperature (T), and when supported at points a certain stated distance (D) apart. If the tape is supported throughout its entire length as when lying on a level surface, $d_0 = 0$.

These are called standard conditions, and will usually differ in one or more particulars from those actually existing or employed at the time the base line is measured. Each measured tape length therefore must receive corrections in order to obtain its actual length under the actual conditions. The number of these corrections are in general as follows: Correction of slope or difference of level; correction for temperature; correction for sag and correction for pull or stretch of metal.

It is thought that a clearer understanding of the method of making these corrections will be obtained by taking the following example:

DATA FOR STEEL TAPE

Horizontal distance between its end graduations is 75 feet = 900' when the tape is at 62° F.; pull 10 lbs.; and when supported at its middle point ($d_0 = 450'$).

$$\phi = 0.0562;$$

$$E = 28,200,000;$$

$$W = 0.0368 \text{ lbs.};$$

$$S = 0.0024 \text{ sq.in.}$$

$$\log \phi = 4.79239 - 10;$$

$$\log E = 7.45025;$$

$$\log W = 6.83251 - 10;$$

$$\log S = 7.38021 - 10.$$

PROBLEM

Measuring "base line," making all necessary corrections, i.e., slope, temperature, sag and pull.

The following instruments and accessories are used in the field work:

- Transit and tripod (complete).
- Y level " " "
- Leveling-rod.
- 75 ft. steel tape.
- Spring balances.
- Devices for applying pull on tape (front and rear).
- Stakes (2" x 4", zinc-capped) (6).
- Malls (2).
- Thermometer (1).
- Penknife (to mark on zinc cap).

DATA

$$L = 75 \text{ ft.} = 900'$$

$$n = 5$$

$$P = 13 \text{ lbs.}$$

<i>Levels.</i>	<i>Temperatures.</i>
1. 3.478'	84° 1st tape length
2. 3.264'	82° 2d " "
3. 3.785'	86° 3d " "
4. 3.795'	86° 4th " "
5. 3.104'	87° 5th " "
6. 3.098'	<u>5)425°</u>
	85° = mean temperature.

1. CORRECTION FOR SLOPE:

3.478'	3.785'
<u>3.264'</u>	<u>3.264'</u>
0.214' = 2.568'' = h_1 .	0.521' = 6.252'' = h_2 .
3.795'	3.795'
<u>3.785'</u>	<u>3.104'</u>
0.010' = .120'' = h_3 .	0.691' = 8.292'' = h_4 .
3.104'	
<u>3.098'</u>	
0.006' = .072'' = h_5 .	
log 2.568'' = .4095950	
2	
<u>log (2.568)² = .8181900 = 6.59462 = h_1^2.</u>	

$$\log 6.252'' = .796019$$

2

$$\log (6.252)^2 = 1.592038 = 39.088 = h_2^2$$

$$h_3^2 = (.120)^2 = .0144$$

$$\log 8.292 = .9186593$$

2

$$\log (8.292)^2 = 1.8373186 = 68.7573 = h_4^2$$

$$h_5^2 = (.072)^2 = .005184$$

$$C_l = -\frac{\Sigma h^2}{2h}$$

$$h_1^2 = 6.59462$$

$$h_2^2 = 39.08800$$

$$h_3^2 = .01440$$

$$C_l = -\frac{114.459504 \square''}{1800''} = -.063588''$$

$$h_4^2 = 68.75730$$

$$h_5^2 = .005184$$

$$\Sigma h^2 = 114.459504 \square''$$

2. Correction for Temperature:

$$C_t = a(T'_m - T_0)nL = 0.0000062(85^\circ - 62^\circ)5 \times 900 \\ = +0.6417''.$$

3. Correction for Sag:

$$C_s = \frac{L}{24} \left(\frac{w}{PP_0} \right)^2 (P^2 d_0^2 - L^2 P_0^2);$$

$$C_s = \frac{900}{24} \left(\frac{.00068}{13 \times 10} \right)^2 ((13)^2 \times (450)^2 - (900)^2 (10)^2);$$

$$= C_s = \frac{900}{24} \left(\frac{(.00068)^2}{16900} \right) (-46,777,500).$$

$$\log 900 = 2.9542425$$

$$\log .00068^2 \begin{cases} = 6.8325089 \\ = 6.8325089 \end{cases}$$

$$\log 46,777,500 = 7.6700370w$$

$$4.2892973w$$

$$\log (24 \times 16900) = 5.6080979$$

$$\log C_s = 8.6811994w \quad \therefore C_s = -.047995''.$$

$$\text{Total } C_s = -.047995'' \times 5 = 0.239975''.$$

4. *Correction for Pull.*

$$C_p = \frac{(P - P_0)L}{ES} = \frac{(13 - 10)900}{28,200,000 \times .0024} = \frac{2700}{67680}$$

$$= C_p = +0.03989.$$

$$\text{Total } C_p = +0.03989 \times 5 = .19945''$$

SUMMARY OF CORRECTIONS

$C_l = -0.063588''$	$C_t = +0.64170''$
$C_s = -0.239975''$	$C_p = +0.19945''$
$-0.303563''$	$+0.84115''$
	$-0.303563''$
	$+0.537587''$

Standard length of tape = 900''.

$900'' \times 5'' = 4500''$ = length of base line under standard conditions.
 $4500'' + .54'' = 4500.54''$ = length of base line under local conditions at
 time of measurement.

In feet = 375.0448'.

Triangulation in Connection with the Location of Horizontal Base Lines, Gun Centers, and Directing Points of Batteries.—The triangulation stations should, when practicable, be located so that the angles will each be greater than 30 degrees and less than 120 degrees. The transit (see Plate XXIV) should have at least two verniers and the least count should not be greater than 20 seconds. The plate of the ordinary engineers transit given shows in detail its principal parts.

Before using the instrument it should be put in thorough adjustment, as every transit is liable to and in general possesses errors of both eccentricity and graduation. If the center of motion of the vernier plate does not coincide accurately with the center of the graduated plate, then as the limb is turned, the vernier will have an eccentric motion with reference to the limb manifestly resulting in errors of measurement. In order to eliminate these errors two verniers are used whose zeros are as nearly 180 degrees apart as possible, or three 120 degrees apart. The mean of the readings of these verniers is free from errors of eccentricity. An eccentricity of centers of 1-1000 inch would cause a maximum error of 1' 08'' on a six-inch limb with but one vernier. It is not unusual for an instrument to have an eccentricity of several times this amount.

Errors of graduation are in the main periodic in character, and are

due to errors in the dividing engine in which the circles are graduated. The result is a progressive closing of the intervals between successive graduations in certain portions of the limb, followed by a corresponding extension. Such errors are eliminated or minimized by reading each angle on several different portions of the limb—a process which is shortened by the use of two or three verniers.

Accidental errors, as they are called, must also be eliminated as far as possible. Such errors are brought to light in subsequent measurements of an angle on the same part of the limb of an instrument with fine readings giving discordant results. They are due to many and often unknown causes—such as the difficulty of exactly duplicating a setting of the transit on a given signal pole or target—and are sought to be eliminated by making more than one reading of the angle on each of the selected portions of the limb.

The errors just mentioned are errors found on the most perfectly adjusted instrument. The following adjustments must be carefully made, frequently tested and rectified:

The adjustment of the plate levels especially must be carefully made. These levels indicate when the vertical axis of the instrument is truly vertical. If this is not so, then the telescope when turned upon its trunnions will not move in a vertical plane, and hence the horizontal angle between two distant stations at different altitudes will not be correctly measured. When the telescope is provided with an attached level we have a very accurate means of testing or rectifying errors of this kind.

Even when the axis is truly vertical the two standards may be of different lengths due to lack of perfect adjustment, unequal expansion or contraction, etc., thus causing the telescope to again revolve in an oblique plane, and introduce errors similar to those just referred to. Unlike the last, however, these errors may be eliminated by reading the same angle an equal number of times with telescope direct and then telescope inverted. To measure an angle with telescope inverted, “tumble” or “transit” the telescope, leaving the trunnions in the same beds, and then turn the vernier plate 180 degrees, or until the telescope points to one of the stations.

The adopted methods of reading angles in triangulation work for coast artillery is that known as the “repeating method.” By this method the limb is clamped in any position and left undisturbed while pointings are made to all visible stations in succession around the horizon, and both verniers read for each pointing. Angles are then found by taking the difference between the proper mean reading.

More in detail, the method is as follows: Suppose a transit be set up over the station marked at *B* (Fig. 68), and accurately leveled. Clamp the vernier plate a little in advance and approximately at zero, but without reference to any particular setting. Turn the telescope on signal at the station *A*, clamp the limb and do not unclamp it until the set of readings about to be described is completed. Secure accurate bisection of the signal by the vernier tangent screw. Read and record both verniers. Unclamp the vernier,

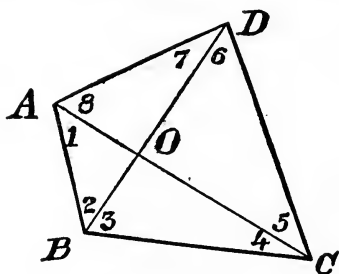

FIG. 68.

point and read in the same manner on *D* and then on *C*. After recording the last reading see if the signal remains accurately bisected. If not, perfect the bisection, record the new reading, and from this signal as a starting point, proceed around to the left, sighting on the signals successively as before, but in inversed order. These pointings should be entered in the notebook as *D*, meaning telescope direct. Invert the telescope, turn on *A*, and proceed to the other signals and back again as before, recording the pointings as *I*, meaning telescope inverted.

These four pointings on all the signals constitute a set, and in any set the four pointings on any one signal are evidently read by the verniers at very nearly the same point of the limb. The use of opposite verniers eliminates errors of eccentricity. Inverting the telescope eliminates errors of adjustment in the line of collimation and standards. A multiplication of the pointings tends to reduce accidental errors.

It should be observed that the transit is level and accurately above the station before beginning each set. If, while observing, the levels show a change, they should not be disturbed until the set is finished; when, if a change is considerable, the entire set of readings should be rejected. The stability of the instrument on its tripod or other support should receive careful attention.

The successive pointings should be made as rapidly as consistent with accuracy, thus giving them a greater certainty of having them made all under the same conditions, by reducing the time by which unequal temperature affects on the instrument, or changes in illumination of the signal, may occur.

When the sun is not obscured, especially in summer, heated air currents are apt to render the image of the signal so unsteady as to make a

pointing to it very uncertain. To obtain an accurate bisection of a distant signal, we must have steadiness of air and good definition. It will contribute to accuracy if the transit is shielded artificially from the direct rays of the sun when the weather is not cloudy.

In a wind when the transit is mounted on a tripod, it will often be found difficult to center it over a station by means of a plumb bob. Advantage may be taken of the method of inclosing the line and bob in a gas or sewer pipe of small bore, supported on the bottom on strips or blocks of wood of just sufficient height to permit seeing that the bob is properly centered under the pipe.

After these various sets of readings are taken the accurate adjustment of the triangle should be made.

The Determination of the True Azimuth.—The azimuth of a line is the horizontal angle between the line and a true south line running from one of its extremities, the angle always being measured from the south point as an origin towards the right; that is, in the same direction as the increasing graduations on a watch. If the direction of the line be between north and east, its azimuth will be between 180 and 270 degrees; if between east and south its azimuth will be between 270 and 360. The method of determining the true azimuth of a base line in coast artillery work is that known as the determination by stellar observation, or observations on Polaris.

For example, suppose in Fig. 69 that OT is the base line in question, with the transit accurately centered over the point O and a signal or target at the other; Z , the zenith or point directly overhead as pointed out by a plumb line; HH , the horizon. Planes passing through ZA will cut the sphere in circles all of which intersect the horizon at right angles and pass through the zenith. These are called vertical circles. One of these, ZPN , will pass through the point P where the axis of the earth pierces the surface of the earth called the pole. The projection of the arc ZPN on the surface of the earth gives the true meridian, NOS , and N the north point of the horizon. The arc PN or the altitude of the pole above the horizon is always the latitude of O , the observers' station, say 37 degrees; the remainder of the quadrant PZ is called the co-latitude and is equal to 53 degrees.

The line of sight of a transit in perfect adjustment placed at O and pointed at N will, when revolved on the trunnions, pass successively through P and Z . If there were a star permanently located at any point in this arc, as at P , the determination of the azimuth OT or the base line would consist simply in measuring with the transit the horizontal angle between two objects P and T at unequal heights, in other

words the angle NOT , which is the azimuth of OT reckoned from the north. Increasing this by 180 degrees we will have the true azimuth, SOT .

It happens, however, that there is no star exactly at the pole P , but Polaris indicated as S , is about one and a fourth degrees from the pole, and is the nearest star which, in the absence of clouds, can be seen readily with the naked eye even in full moonlight.

So if S is the star, the angle TOB between the star and the line is measured with the transit. After deducting the angle BON between

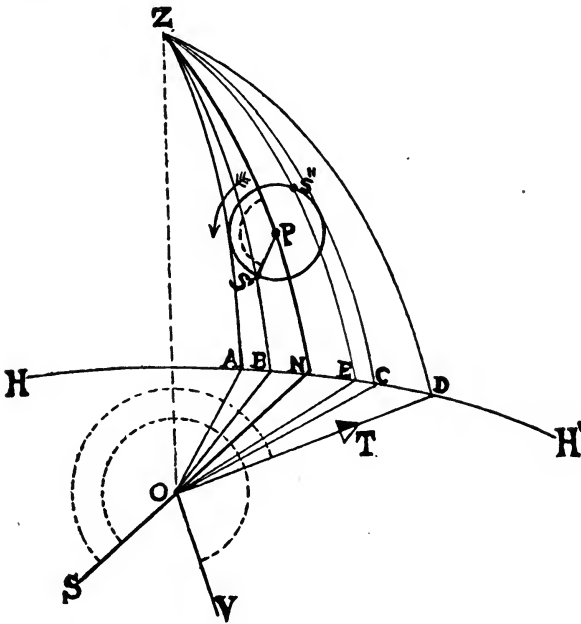

FIG. 69.

the star and the meridian we have the angle NOT , which as before is the azimuth of the base line from the north.

To an observer facing the north Polaris appears to move in a circle around the pole once in 24 hours in the direction of the arrow indicated on the cut, with a radius of one and a fourth degrees from the pole. (To give some idea of the extent of one and one-fourth degrees on the sphere, it may be remembered that it is one-quarter the distance between the pointers in the Dipper, or the length occupied by two full moons and a half placed side by side.)

The same is true of all other stars, each within its own radius, and

this affords a means of both finding Polaris at any hour and locating the pole approximately. The line joining the pointers passes very near to Polaris and the line joining Polaris and the star at the bend of the handle of the Dipper passes over the pole one and a fourth degrees from Polaris.

TO DETERMINE THE TRUE AZIMUTH

The mean sun, by whose motion ordinary timepieces are regulated, moves daily around the pole in a circle, with a longer radius but in the same direction as Polaris. Polaris, however, moves a little faster in an angular sense than the sun, completing the circuit 3.94 minutes sooner. Once a year, therefore, the star Polaris will overtake the sun, and the date upon which this occurs is given in the table following:

TABLE A

CIVIL DATES (OR EPOCHS) WHEN POLARIS PASSES THE MEAN SUN

Year.	Epoch. April.	Year.	Epoch. April.	Year.	Epoch. April.	Year.	Epoch. April.
1901	13 0	1909	13 8	1917	14 6	1925	15 3
1902	13 4	1910	14 2	1918	15 0	1926	15 6
1903	13 7	1911	14 5	1919	15 3	1927	15 9
1904	13 1	1912	13 9	1920	14 7	1928	15 3
1905	13 4	1913	14 2	1921	15 0	1929	15 6
1906	13 8	1914	14 6	1922	15 3	1930	15 9
1907	14 1	1915	14 9	1923	15 6	1931	16 2
1908	13 5	1916	14 3	1924	15 0	1932	15 6

By the use of this table the position of Polaris in its daily path at any instant during the ensuing year can be determined. In other words, it would be ahead of the sun by 3.94 minutes times the number of days and fraction of a day in the interval. The position of the sun itself is known by the use of the corrected watch time. For example, suppose Polaris to pass the mean sun on April 14.1. The civil day beginning at midnight, this date is really 2:24 A.M., April 14th. What is its position in its circular path on June 24th at 4:30 P.M.? The interval to the nearest tenth is 71.6 days, and 71.6 multiplied by 3.94 equals 4 hours and 42 minutes, which is the time Polaris is ahead of the sun. The sun is, as stated, $4\frac{1}{2}$ hours from the meridian. Therefore, Polaris is 9 hours and 12 minutes from the meridian, or, in circular measure, 138 degrees from the same. It is in the first half of its daily path, or at

some such point as S prime, in Fig. 69, and the hour angle is indicated by the angle in the figure ZPS prime, which is equal to 138 degrees. In the spherical triangle ZPS prime we have known the side ZP , which is equal to the CO -latitude of the station, or 53 degrees; the side S prime, equal to the constant, equal to 1 degree and 13 minutes, and the angle at P , equal to 138 degrees. The angle at Z may therefore be computed, and it is the angular distance of Polaris west of the meridian at 4:30 P.M., June 24th, which is the same as the angle BON on the surface of the earth. By varying the hour angle at P from zero to 360 degrees, a table of azimuths of Polaris at any latitude can be constructed for each hour of the 24. The table for latitude 40 degrees north is given below:

TABLE B

ANGULAR DISTANCE OF POLARIS FROM THE MERIDIAN FOR DIFFERENT HOUR-ANGLES (H) IN APRIL, 1900, LATITUDE 40° (CALLED THE AZIMUTH OF POLARIS)

H , hours	0	1	2	3	4	5	6	7	8	9	10	11	12
	—	—	—	—	—	—	—	—	—	—	—	—	—
Az. minutes of arc . .	0	25	49	69	84	93	96	92	82	67	47	24	0
	+	+	+	+	+	+	+	+	+	+	+	+	+
H , hours	24	23	22	21	20	19	18	17	16	15	14	13	12

TABLE C

FACTOR FOR YEAR AND LATITUDE

Lat.	1900	1910	1920	1930
20°	0 82	0 78	0 75	0 72
30°	0 88	0 85	0 81	0 77
40°	1 00	0 96	0 92	0 87
50°	1 10	1 14	1 09	1 04

The problem of determining the true azimuth of a base line consists in measuring at any convenient time the horizontal angle between Polaris and the line to be established and then applying thereto the angular distance of Polaris from the meridian; that is, the angular distance at the moment of observation. The solution of the following problem illustrates the method followed:

Find the azimuth of the base line NO , Fig. 69, the latitude of station being 37 degrees, longitude 70 degrees west. The angle between Polaris and the artificial star was 200 degrees. The time of sighting on star by the watch was 10 P.M., July 26, 1904. The watch was 30 seconds fast.

Solution.—The transit is adjusted beforehand and by daylight, and set up at the point O . A post is sunk firmly in the earth at the point T , and on a separate surface are nailed two strips pointing in the direction of the distant station where the observation is to be made, or at the point O . Between these two stripes a small box opened at the rear is placed and a bullseye lantern is put in with its lens against the front wall of the box. In the top over the lantern a hole is cut for the escape of the smoke, and in the front face at the height of the lens a small circular hole is cut through the box so that the light is visible from the point of observation. This hole should be made very small so that the light will have the appearance of a star when sighted upon with the transit. First with the telescope direct read on star and then on the signal or artificial star. Invert the telescope and read on signal and then on the star. For greater accuracy a second set of readings may be taken. As assumed in the problem, the angle between Polaris and the artificial star was found to be 200 degrees. The solution of the rest of the problem is therefore as follows:

Corrected watch time = $9^{\text{h}}59^{\text{m}}30^{\text{s}}$ standard time.

Local time = $9^{\text{h}}59^{\text{m}}30^{\text{s}} + 20^{\text{m}}$.

$15)5^{\circ} = 20$ minutes.

Therefore corrected time of observation = $10^{\text{h}}19^{\text{m}}30^{\text{s}}$, July 26, 1904.

Interval between epochs =

April	17.9
May	31.
June	30.
July	25.93

104.83 days

$3.94^{\text{m}} \times 104.83 = 412.99^{\text{m}} = 6^{\text{h}}52^{\text{m}}59.4^{\text{s}} =$ time Polaris is in advance of the sun.

The sun is $10^{\text{h}}19^{\text{m}}30^{\text{s}}$ from the meridian.

Therefore Polaris is $17^{\text{h}}12^{\text{m}}29^{\text{s}}$ from the meridian = hour angle.

From Table B

Azimuth Polaris = 92.83' +.

Correcting (from Table C) for year and latitude.

	1900	1904	1910
37°	.964	.949	.927

$$92.83' \times .949 = 88.096' = 1^\circ 28.1' 5''$$

Azimuth from N = 201° 28' 5''.

" " S = 21° 28' 5''.

LOCATION OF PINTLE CENTERS

The center of the true or pintle surface of the ring is the point required. This point may be obtained after the base ring has been set and before the racer has been put in position, or even after the gun and carriage have been mounted. For example, suppose the racer not to be in position, and that the carriage has not been mounted. A tripod made of pieces of scantling is placed at the center of the pit with legs properly braced to prevent motion, or built up by a box from the center of the pit at the bottom until the upper surface is nearly at the level where it is intended to locate the center of the base ring. Nail on the top of this pile a piece of dressed pine 4×4 feet square for use in making marks with a pencil or sharp pointed instrument. The diameter of the base ring may be found from the official drawings, or it may be measured very closely with a steel tape. With the marking point of a trammel set as nearly as possible to the radius, and with the caliper point bearing at the particular height against the pintle surface, strike an arc across the cap. Do the same at three other points around the ring 90 degrees apart, taking care that the caliper point is always at the same height. If these four arcs all pass through a given point this is the center sought. If not, the distance between the points of the trammel should be altered until two opposite arcs slightly overlap and the two points of intersection come on the cap. Over this point a suitable signal with pointed end may be erected, held in a vertical position by wire guys fitted with turnbuckles, and of sufficient length to be seen from two or more triangulation stations. This will usually require the signal to project above the parapet, necessitating a length of from 15 to 20 feet, according to the caliber of the gun. Sections of gas-pipe fitted together make a good signal, and one having but little flexure. By this signal the pintle center is located by triangulation.

If a trammel is not at hand and one cannot be improvised, the following devices, or others which may suggest themselves, may be employed.

In Fig. 70, AB is a straightedge of scantling (supported, if necessary, at intermediate points to avoid sag) laid as nearly as practicable over the center, and ab marked or scratched on the cap. AB is bisected by a steel tape, and the point e located, at which a perpendicular to ab is erected in the ordinary manner. The straightedge is then transferred to a position CD , estimated as perpendicular to the former, and the point f determined as was e . The intersection of the perpendiculars at e and f is the center.

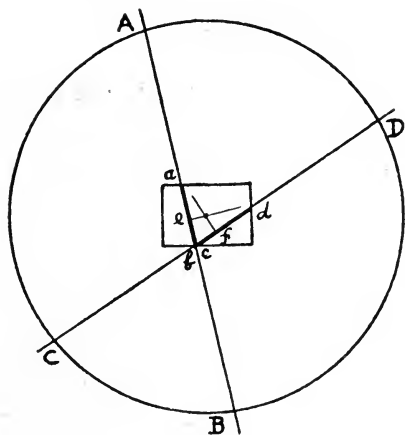

FIG. 70.

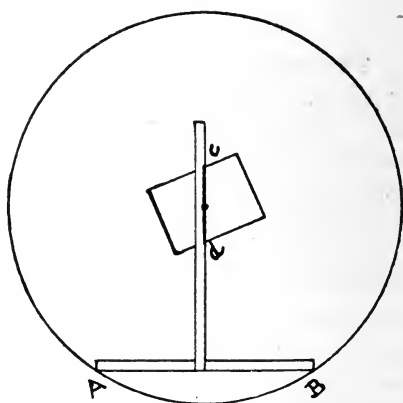

FIG. 71.

It may be well to mark the points A and B permanently on the straightedge by means of solid stops which will bear against the pintle surface; these stops being a little nearer together than the pintle diameter. The point e may then be marked on the edge once for all.

Where the base ring is made in two parts, the line connecting the joints is evidently a diameter of the ring, and the straightedge carefully adjusted along this diameter, and accurately bisected, gives the center.

In Fig. 71, $Abcd$ represents a scantling T square with the pieces halved into each other, supported as may be necessary, and the inner edge cd bisecting AB at right angles, as shown by a "square." The line cd is marked on the cap, and the T square transferred to a position estimated as perpendicular to the former. The intersection of the two lines cd gives the center.

In emplacements for an A. R. F. disappearing carriage, it will be most convenient to use the inner base ring. The central blocking will be very low. In emplacements for non-disappearing carriages (commonly called barbette) the diameter of the pintle surface is so small, and the center so readily found and tested, that no remark is necessary.

It will be remembered that for the best results each angle of a triangle should be directly measured in order that a suitable adjustment may be made. In emplacements for disappearing guns, however, whether L. F. or A. R. F., the pintle center cannot be *conveniently* occupied by a transit (even though the point be carried upward by a plumb line), on account of the diameter of the emplacement, and the height of the parapet, over which, in the general case, it would be necessary to obtain a clear view.

In barbette emplacements the transit may be very conveniently set over the pintle-center so as to give a free view over the parapet. This point is therefore a very advantageous observation station, and should be always occupied, both as an aid to its own accurate location in the triangulation scheme, and also in the location of reference points in the field of fire for purposes of orientation.

With mortar emplacements, where the racers have not been put in position, the same methods are applicable as in the case of emplacements for disappearing guns. It will, however, usually be found necessary to locate trigonometrically, not the individual mortar centers, but a single directing point for the battery (which may well be on the parapet), or at most the centers of the individual pits. In the latter case the center of the rectangle of the four base rings may be easily marked on the floor of each pit with quite sufficient accuracy, and signals erected at these points as before described. It will not be convenient to occupy such pit stations with a transit; but the directing point of the battery should always be occupied.

In all these cases the verticality of the signal throughout its whole extent should be secured and tested by a transit, immediately before any triangulation work.

To Find the Center of Motion.—When the carriage and gun have been mounted over a base ring properly leveled, the center of motion of the gun, when turned in azimuth, will practically coincide with the center of the pintle surface, and may be found with either barbette or disappearing mounts as follows: With the gun in the firing position and at about the limit of its play in azimuth, locate two points of the "line of metal" (or highest element) on each portion of the contour of the gun. Snap a chalk line between these points. This chalk mark on the gun lies

directly over the center of the pintle surface. Set up a transit on the parapet at a distance of 50 yards or thereabouts, and depress the gun until the chalk mark is visible throughout its whole extent. (It may be found desirable to raise the transit on blocks one or two feet.) Traverse both gun and transit until by trial the intersection of the cross wires will run accurately along the whole mark as the telescope is elevated and depressed. The transit is now pointing along a diameter of the pintle surface, and must not be disturbed in azimuth. Traverse the gun approximately 90° , bring it to 0° elevation, and then move along the chalk mark a pencil, wire, or flat-headed nail inverted, until its base is accurately on the line of sight of the transit. The point thus determined is evidently on two diameters of the pintle surface—one indicated by the chalk mark, and one by the line of sight of the transit. It is therefore at the center—which supposition should be tested by traversing the gun through a considerable arc to the right and left. Scratch the chalk mark at the exact point by the pencil or nail. Over this point a small target may be set up and securely fastened to the gun, as a signal for triangulation purposes, and the pintle center located trigonometrically thereby. The pattern shown in Fig. 72 has been found to answer perfectly. *AB* is a half-inch board about 3 by 8 or 10 inches, fastened by brads to two cross shoes, whose lower surfaces are hollowed out to fit the curvature of the gun hoops. Through a hole in the middle of the board passes a small post *P*, of the proper diameter for a signal, extending 10 or 12 inches above, suitably braced, and a fraction of an inch below. Into the middle of its lower end is driven an iron or steel point so that when the shoes are placed on the gun, this point will just touch the gun or very nearly so. Openings are cut in the board and it is cut away at the sides to allow of properly placing the pin over the point on the chalk mark. The whole may be securely bound in place by twine or straps attached to the parts of the carriage, and will be immovable in any ordinary wind.

The above method of finding the center of motion applies strictly only to barbette and the later models of disappearing mounts, where the point in question falls either on the body of the piece or the trunnion hoop—surfaces which are level when the gun is at zero degrees elevation. In the disappearing model of 1894, however, the point falls on the sloping surface of one of the chase hoops. In observing this point during the triangulation, the post *P* must be vertical. Therefore, when the piece is traversed 90 degrees in order to locate the pencil or nail as before described, the gun should not be set at zero, but at such elevation that the post will be vertical when in position. This may be accom-

plished by placing the target of Fig. 72 on the hoop in question and testing the verticality of the post by the vertical motion of the transit, altering the elevation of the gun until the desired result is obtained. The elevation of the gun should not be changed during the subsequent triangulation.

On account of irregularities in the contour of a gun, it will be found best, in marking the line of metal, to snap the chalk line on each portion of the surface separately, i.e., on the body, on the trunnion band, etc.

The line of metal may be found as follows: Clear the vent, close the breech and place in the muzzle an open bore sight having white cross

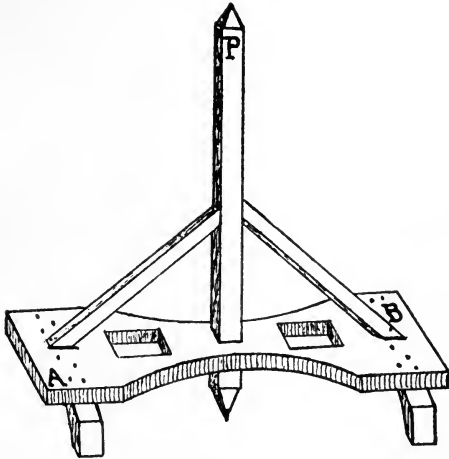

FIG. 72.

threads, i.e., fine white cord or fine wire wrapped with white insulating material.

Set up a transit on the parapet as before, point into the muzzle and by elevating and traversing both gun and transit, bring the cross wires of the transit, the cross threads in the muzzle, and the axis of the vent in line. Depress the gun, and with the vertical wire of the transit, locate by a pencil or other sharp point several points of the line of metal and snap a chalk line as before.

With mortars, the problem of location of the directing point of the battery or of the centers of the different pits, is evidently the same as before the mortars were mounted.

Orientation of Gun and Mortar Azimuth Circles.—These circles, when received from the arsenals, have the degree marks cut on them, but the proper numbering of the marks is necessarily postponed until

the circles are in position. A brass subscale, whose least reading is five one-hundredths, is screwed to the racer—the screw holes being slotted to permit of lateral movement and adjustment of the scale. The complete orientation of a circle consists in the proper numbering of the degree marks, and the proper setting of the subscale, so that when the gun points to the true South the reading shall be 0° , or when pointing to any object whose azimuth is known, the reading shall be that azimuth.

1. **Guns.**—In order to do this, and as a check from time to time in the future, the azimuth from the pintle-center of one or more points in the field of fire should be accurately determined. These points may be either natural or artificial, but must be clearly visible through the bore of the gun. For example, the tip of a lighthouse or other tower, a spire, the vertical edge of a structure, a certain pile of a distant wharf,

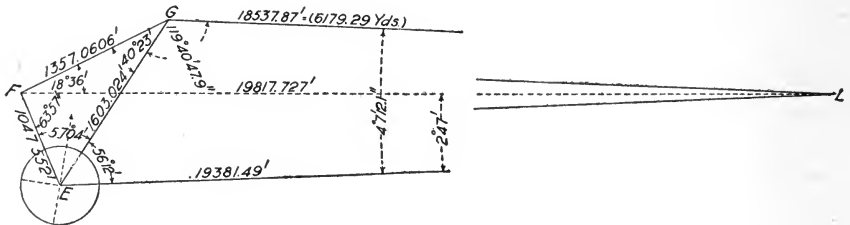

FIG. 73.

or a pile or other target specially erected, a paint-mark on a vertical rock cliff, or a flagstaff, would all answer. The azimuth of such points from the guns should be found at the same time that the gun pintles are located. For example, in case the pintle centers have been occupied by a transit as on barbette mounts, the azimuth from the gun of any object in the field of fire may be directly determined at the same time by measuring the angle between one of the base ends (or other established point) and the object in question. As this, however, does not of itself give the *range* to such points, it is usual to determine both their range and azimuth by triangulation. Thus in Fig. 73, if EF is a line whose azimuth and length are known, G the gun center, and L the reference point in question, then the distance and azimuth of L from G may be found by sighting from E and F on each of the other three points. If G and L can also be used as observing stations, it will add to the accuracy of the determination. A complete solution of the following problem illustrates the method:

PROBLEM.—To determine the azimuth and range of “lighthouse” from Gun No. 2, Battery ———. Same to be used as datum point for orientation of gun.

Method.—The pintle center was located as previously described. The following observations were then made:

Station at	On.	Reading.	Angle.	Remarks.
E	F	3° 50'	57° 04'	One end of base line. Gun No. 2, Battery ———.
	G	60° 54'	56° 12'	
	L	117° 06'	113° 16'	Point on Lighthouse.
F	G	23° 15'	18° 36'	
	L	41° 51'		
	E	105° 48'	63° 57'	
			82° 33'	

See diagram, Fig. 73.

The following table shows the solution:

TABLE OF DATA

From	To	Azimuth.	Range, Yards.
E	F	145° 47' 23"	349.184
F	E	325° 47' 23"	349.184
E	L	259° 03' 23"	6460.496
L	E	79° 03' 23"	6460.496
L	F	81° 50' 23"	6605.909
F	L	261° 50' 23"	6605.909
L	G	*83° 10' 35.1"	6179.29
G	L	†263° 10' 35.1"	6179.29
G	E	22° 51' 23"	534.341
E	G	202° 51' 23"	534.341
G	F	63° 14' 23"	452.354
F	G	243° 14' 23"	452.354

* By proof method 83° 10' 39.8".

† By proof method 255° 10' 39.8".

Solution for Azimuth and Range (only).

$$\angle FGE = 180^\circ - (18^\circ 36' + 63^\circ 57') = 40^\circ 23'.$$

$$\sin 82^\circ 33' : \sin 40^\circ 23' :: EG : EF.$$

$$\therefore EG = \frac{EF \sin 82^\circ 33'}{\sin 40^\circ 23'}.$$

$$\log EF = 3.0201844$$

(in ft.)

$$\log \sin 82^\circ 33' = 9.99632$$

$$13.0165044$$

$$\log \sin 40^\circ 23' = 9.811505$$

$$\log EG = 3.2049994$$

$$\therefore EG = 1603.024 \text{ ft.} = 534.341 \text{ yards.}$$

$$\angle ELF = 180^\circ - (63^\circ 57' + 57^\circ 04' + 56^\circ 12') = 2^\circ 47'.$$

$$\sin 63^\circ 57' : \sin 2^\circ 47' :: EL : EF.$$

$$\therefore EL = \frac{EF \sin 63^\circ 57'}{\sin 2^\circ 47'}$$

$$\log EF = 3.0201844$$

$$\log \sin 63^\circ 57' = 9.953475$$

$$12.9736594$$

$$\log \sin 2^\circ 47' = 8.68627$$

$$\log EL = 4.2873894$$

$$\therefore EL = 19381.49 \text{ ft.} = 6460.496 \text{ yards.}$$

$$G + L = 180^\circ - 56^\circ 12' = 123^\circ 48'.$$

$$\tan \frac{1}{2}(G - L) = \frac{19381.491 - 1603.024}{19381.491 + 1603.024} \cot \frac{1}{2} 56^\circ 12'.$$

$$19381.491$$

$$19381.491$$

$$1603.024$$

$$1603.024$$

$$(1) \quad 17778.467 \qquad (2) \quad 20984.515$$

$$\log (1) = 4.24990073$$

$$\log \cot 28^\circ 06' = .27250$$

$$4.52240073$$

$$\log (2) = 4.3218972$$

$$\log \tan \frac{1}{2}(G - L) = .20050353$$

$$\therefore \tan \frac{1}{2}(G - L) = 57^\circ 46' 47.9''.$$

$$\frac{1}{2}(G + L) = 61^\circ 54'$$

$$\frac{1}{2}(G - L) = 57^\circ 46' 47.9''$$

$$G = 119^\circ 40' 47.9''$$

$$L = 4^\circ 07' 12.1''$$

$$\text{Az. } EF(\text{given}) = 145^\circ 47' 23''$$

$$+ \angle FEL = 113^\circ 16'$$

$$\text{Az. } EL = 259^\circ 03' 23''$$

$$\begin{aligned} \text{Az. } LE &= 79^\circ 03' 23'' \\ + \angle ELG &= 4^\circ 07' 12.1'' \end{aligned}$$

$$\text{Az. } LG = 83^\circ 10' 35.1''$$

$$\text{Az. } GL = 263^\circ 10' 35.1'' = (\text{gun azimuth})$$

$$\text{Sin } 119^\circ 40' 47.9'' : \text{sin } 56^\circ 12' : 19381.491 : GL.$$

$$\therefore GL = \frac{19381.491 \sin 56^\circ 12'}{\sin 119^\circ 40' 47.9''}$$

$$\log 19381.491 = 4.2873894$$

$$\log \sin 56^\circ 12' = 9.919595$$

$$\hline 14.2069844$$

$$\log \sin 119^\circ 40' 47.9'' = 9.938924$$

$$\hline \log GL = 4.2680604$$

$$\therefore GL = 18537.87 \text{ ft.} = 6179.29 \text{ yards} = \text{range.}$$

Solution for finding other sides of quadrilateral and as a check on foregoing solution.

$$\text{Sin } 57^\circ 04' : \text{sin } 40^\circ 23' : FG : EF.$$

$$\therefore FG = \frac{EF \sin 57^\circ 04'}{\sin 40^\circ 23'}$$

$$\log EF = 3.0201844$$

$$\log \sin 57^\circ 04' = 9.92392$$

$$\hline 12.9441044$$

$$\log \sin 40^\circ 23' = 9.811505$$

$$\log FG = 3.1325994$$

$$\therefore FG = 1357.0606 \text{ ft.} = 452.354 \text{ yards.}$$

$$\text{sin } G : \text{sin } F : FL : GL.$$

$$\therefore FL = \frac{GL \sin G}{\sin F}$$

$$\log \sin 19^\circ 56.2' = 9.53273$$

$$\log GL = 4.26806$$

$$\hline 13.80079$$

$$\log \sin 18^\circ 36' = 9.50374$$

$$\hline \log FL = 4.29705$$

$$\therefore FL = 19817.727 \text{ ft.} = 6605.909 \text{ yards.}$$

Proof of Solution for \angle 's G and L .

$$\begin{aligned} \tan x &= \frac{a}{b} = \frac{19817.729}{1357.0606} \\ \tan \frac{1}{2}(G-L) &= \tan (x-45^\circ) \tan \frac{1}{2}(G+L). \\ \log a &= 4.29705 \\ \log b &= 3.132599 \\ \log \tan x &= 1.164451 \\ \therefore x &= 86^\circ 04.95' \\ (x-45^\circ) &= 41^\circ 04.95' \\ \log \tan 41^\circ 04.95' &= 9.940427 \\ \log \tan \frac{1}{2}(G+L) &= .78580 \\ \log \tan \frac{1}{2}(G-L) &= .726227 \\ \therefore \frac{1}{2}(G-L) &= 79^\circ 21.72' \\ \frac{1}{2}(G+L) &= 80^\circ 42' \\ \therefore G &= 160^\circ 03.72' = 160^\circ 03' 43.2'' \\ L &= 1^\circ 20.28' = 1^\circ 20' 16.8'' \end{aligned}$$

Having located at least two such reference points, place bore sights in the breech and muzzle of the gun, the sights having black cross threads, and turn the gun on one of the points as L , whose azimuth from G is, for example, 263.17° . Loosen the clamp screws of the subscale and slip the scale to the right or left until its .17 division lies directly over some graduation line of the circle—the zero of the scale thus being .17 to the left of this line. By alternate movements of the screws, set them moderately well home, taking care that the subscale does not move. By means of a steel punch stamp this line 263. As the gun now lies the circle reading is 263.17 degrees, as it evidently should when directed on a point whose azimuth is 263.17 degrees. Proceed around the circle *to the left*, stamping the lines successively 262, 261, etc. Turn the gun on another reference point for verification. If a discrepancy be found to exist the computation of the azimuths of the points should be re-examined. If no error be found, the triangulation should be repeated. When substantial verification has been obtained, the screws should be set fully home, but without inserting dowels, as these prevent subsequent adjustment of the scale.

Whether the telescopic sight may be substituted in this operation for the bore sights is a matter of calculation and judgment. For example, suppose a sight accurately adjusted to parallelism with the axis of the bore and distant therefrom 4 feet when on the sight standard.

If this sight be directed on a reference point 1,000 yards distant, the gun will point $4\frac{1}{2}$ minutes to the right or left, and hence the subscale, if set accordingly, will always be $4\frac{1}{2}$ minutes in error. When firing by Case III this will cause a deviation error of about 13 yards at a range of 10,000 yards. If the sight be nearer the axis, or if it be adjusted to intersect the axis of the bore at 6,000 yards; or if the reference point be more distant or the range less than 10,000 yards, the error will be less.

Mortars.—Since a view of the field of fire from mortar-pits is impossible unless high trestles or blocking be erected, the use of distant reference points in orienting the circles will in general be impossible. There should, whenever practicable, be at least one permanent point established on the parapet (this may be a cross cut in the concrete), whose azimuth from some visible point is known. From this point a line of known azimuths may be run to a point near the crest of the parapet, over which a transit may be set up, and by elevating the mortars a view through the bore of each obtained. The remainder of the operation is the same as in case of guns. It may be found that a single position of the transit will answer for more than one pit.

Leveling.—The principal leveling problems which need be considered in connection with seacoast works are the determination of the height of gun trunnions, and the trunnions of D. P. F. instruments, above mean low water.

At each post will be found one or more permanent marks, called "bench marks," whose location and height above mean low water have been determined and recorded. These data may be obtained either from the artillery engineer of the post, or from the office of the district engineer. The height of any given point above such bench mark is then obtained by leveling, and to this height is added the height of the bench. The result is the height of the given point above mean low water.

The instruments required are the engineer's Y level and the leveling rod. The adjustments of the former should be carefully made, and to provide a stable rest for the latter during the work, an iron pin may be carried along and driven in the ground as required.

The difference of level between a bench and any other desired point may be found as follows: Set up the Y level in any convenient position, from which the leveling rod, when held on the bench, will be clearly visible. The rod should be balanced by hand in a vertical position. Read the rod. This reading is called a back sight, and is evidently the height of the axis of the telescope above the bench. Pace the

distance from bench to instrument when possible; if not, carefully estimate the same. Send the rod forward in the general direction required, a distance equal to the last, determined by pacing or estimation. Drive the pin in the ground, and rest the rod vertically on the same. Turn the instrument and read the rod, noting that the bubble is level. This reading is called a foresight, and is evidently the height of the axis of the telescope above the pin.

The back sight, diminished by the fore sight, is therefore the difference of level between the bench and pin. If the difference be positive, the pin is higher than the bench; if negative, it is lower. It will be noted in the foregoing that the instrument has not been changed in position between the back and foresights. It has simply been turned in azimuth, and its level corrected when necessary.

Now carry the instrument forward in the general direction required, set up and read on the rod in its last position. This is another back-sight; and in general any reading on the rod held over a point whose height is known, or which may be calculated from previous readings, is called a back sight, while a reading on a point whose height is as yet unknown, is called a fore sight.

Continue in this manner, taking a back and fore sight at each position of the instrument, the last fore sight being taken on the rod when resting on the point whose height is required. Then, the sum of the back sights, diminished by the sum of the fore sights, gives the elevation of the final point above the bench.

For manifest reasons a cloudy day is best suited for this work, and to secure stability of both instrument and rod, one should be selected when there is but little wind.

For any one position of the instrument, the two sights—back and fore—should be of about equal length. This eliminates errors due to imperfect adjustment of the instrument. For example, if, when the bubble is in the middle of its tube, the line of sight is inclined upwards by a small angle, then it has this same inclination to the horizontal on both back and fore sights; and if the lengths of the sights are equal, the two rod readings will be equally in excess of their proper values, the error disappearing when their difference is taken. This precaution will also eliminate in a considerable degree the effects of unequal refraction which occur, especially in summer, if the sights vary greatly in length. It also eliminates the effect of the earth's curvature, which, at a distance of one-half mile from the bench, amounts to 2 inches, at one mile to 8 inches, at two miles to 2 feet 8 inches, etc., increasing as the square of the distance.

When it is impossible to make the back and foresights of equal length, the inequality should be balanced off at the next or some subsequent setting of the instrument, by making the two sights unequal by the same amount in the opposite direction.

On ground which is nearly level the maximum length of sight permissible depends on the state of the atmosphere. The length should not be so great that the image of the target in the telescope appears to "tremble" or "dance," due to currents of air of unequal density between the instrument and target. In the general case from 100 to 200 yards is all that should be attempted for the best results. On sloping ground the sights will necessarily be short.

When the height of the trunnions of a D. P. F. instrument is required, a scantling or board straightedge 4 to 6 inches in width may be placed on edge across the azimuth table, which has been properly leveled, taking care that it is of sufficient length to project through a window, door, or the sighting slit, clear of the tower and stairways. In order to obtain an exit through the sighting slit, it may be necessary to lay the straightedge on small blocks placed on the azimuth table. In any case it should be suitably supported to prevent flexure, and its horizontality secured and tested by a carpenter's or machinist's level. Note the height of the axis of the trunnions above its datum edge, and by means of a steel tape, measure the height of the latter above some staple point on the ground or concrete foundation. With the Y level and leveling rod, find the height of this point above the bench mark as before described. We thus have all the data for finding the height of the D.P.F. instrument trunnions above mean low water.

Sometimes it may be found convenient to mark the level of the datum edge on the outer surface or some auxiliary portion of the tower, and then find the height of this mark above some point on the ground by the ordinary principles of surveying. A line of levels to the bench will then give the information desired.

In the case of guns, a knowledge of the heights of their trunnions when in a firing position is necessary in calculating the quadrant elevations. It will often be found practicable to run a line of levels direct from the bench mark to the gun, the last position of the instrument being on the parapet and the rod resting on the cap square. Deducting the radius of the cap square from the difference of level thus found, we have the height of the trunnions. This will often involve zigzagging up the exterior of the parapet, or running a line of levels up a ramp, but may frequently be accomplished by running the line over a gradual

slope to a point at some distance and at such an elevation that a suitable view of the rod held on a cap square may be obtained.

In some cases it will be more convenient to run a line of levels to a point in rear of the guns, and thence by easy stages to a point on the loading platform; the height of the trunnions above the same being found from the authorized drawings or by steel tape and straightedge. This operation may be reversed if desired.

Sometimes it will be practicable to set up the Y level, either with or without its tripod, at a point on the superior slope, and read the rod held on a cap square; thus obtaining the height of the instrument above the cap square. This horizontal line of sight may be transferred to a D. P. F. station or other structure, or to a tree or flagstaff, the height above the ground of the point thus marked being measured by a steel tape. Knowing the radius of the cap square and running a line of levels to the bench, we have all the data for finding the height of the gun trunnions above mean low water.

Example.—Determine height of trunnions of 8" B. L. R. (barbette), above mean low water.

Station.	Back Sight (Feet)	Front Sight (Feet)	Remarks.
B.M. XIV.	8.923	Above mean low water.
1	3.429	4.124	
2	3.852	0.886	
3	8.201	0.611	
4	11.422	0.726	
5	9.654	0.974	
	45.481	7.321	
	7.321		
	38.160 =	Height of gun trunnions above mean low water.	

HYDROGRAPHIC SURVEYING

In some of our harbors it becomes desirable to determine from time to time the changes which may have occurred in the depth or position of one or more of the channels, the depths in certain areas outside the channel, changes in the three and four-fathom contours, etc. The following indicates in outline the methods to be followed in making such a survey.

In general terms, soundings are made from a tug, launch or open

boat at various points over the area in question, the position of the boat at the moment of making the sounding being determined by triangulation either from the shore or the boat. The position may then be plotted on the chart, and the corresponding depth of water, reduced to mean low water, marked thereon. It will be seen, therefore, that such a survey contemplates the previous determination and accurate location on the chart, of several points on shore which are to be used as points of reference. In other words, it contemplates a shore base line, and a certain amount of triangulation.

Soundings are made at regular intervals, determined either by time or distance, on straight lines over which the boat is caused to pass, the lines being parallel or approximately so, and normal to the general trend of the shore. These lines should not be farther apart than from 75 to 150 yards, and may be as much nearer as the progress of the work shows to be necessary, according to nature of bottom and accuracy desired. On each line soundings should be taken at distances apart not greater than the interval between the lines.

If the survey is of considerable importance, a second system of lines may be run at right angles to the first and the accuracy of the work checked by the arrangement of interpolated soundings where the lines cross.

The keeping of the boat on the line is much facilitated by the use of "ranges," that is by two signals placed on the line. The boat is then so steered as to keep on the range thus pointed out. The signals may consist of two poles set on shore at a suitable distance apart, or one pole on shore and a buoy. The range should be marked for each line to be run. When buoys are to be used for the above or any other purpose, their positions must be determined and plotted on the chart—in short, they are to be considered simply as additional points in the land triangulation scheme. The same is, of course, true of any signals used to indicate a range.

A suitable buoy for the purpose may be made of any light wood, 6 to 12 inches in diameter at top, from 3 to 5 or 6 feet long, tapering toward the bottom. A through hole bored in the direction of its length permits the insertion and wedging of a flagstaff. To the lower end of this staff, projecting below the end of the float, is attached the buoy rope. Rocks may be used as anchors. Buoys, of course, swing somewhat with the tide, and are therefore not as reliable as points on land.

CHAPTER XI

CORDAGE

Yarn is formed by twisting together several fibers of hemp or other material used. A number of yarns or threads twisted or spun together form a *strand*, and three or four of these strands form a rope.

Rope is cord more than one inch in circumference, made up of hemp or other fibrous material or of steel or other metallic wire.

Hawser is a term applied to large ropes.

Ropes are ordinarily composed of three strands laid up right-handed, so that when a strand is followed away from the observer the rotation will be clockwise or laid up with the sun. Hawser-laid, plain-laid or right-hand rope is laid up in this manner. (Pl. 38, Fig. 1.)

Shroud-laid Rope contains four strands, usually laid up right-handed round a smaller rope called a heart or core. (Pl. 38, Fig. 2.)

Cable-laid Rope contains three right-handed ropes of three strands each, laid up left-handed into one. (Pl. 38, Fig. 3.)

Wire Rope contains a number of wires twisted into strands, three to six of which are laid up round a wire or hemp core. It is about three times as strong as hemp rope, but lacks elasticity and is difficult to handle. It is used principally for permanent standing rigging.

The size of a rope is expressed in inches and fractions thereof, and is measured on the circumference.

Rope is either *tarred* or *untarred*; the latter is usually called white. It is more suitable for tackles than tarred, as there is less waste of power due to stiffness. Tarred rope is more desirable if exposed to moisture.

Hawser-laid rope should be coiled with the sun; cable-laid rope against the sun. To allow a free circulation of air large ropes should be coiled and stored on skids. Small ropes may be hung on pins or hooks. Rope should not be coiled wet. Coiled rope should be uncoiled at least once a year and stretched out in the sun for a few days.

Spun Yarn is made by twisting together loosely two or more tarred yarns.

Marlin is two-stranded, right-handed. It is made of spun yarn tightly twisted. It is harder and smoother than spun yarn.

Hambroline is two-stranded, right-handed; **roundline** three-stranded, right-handed. Both are made of fine left-handed yarns.

Houseline is three-stranded, left-handed. It is made of finer dressed hemp and has a smoother appearance than spun yarn.

Hemp Fiber is obtained from the hemp plant. **Manila fiber** is obtained from a species of plantain. **Coir fiber** is obtained from the outer husk of the cocoanut.

Right-handed rope is coiled clockwise. In uncoiling a new hemp rope pass the end which is at the core through the coil to the opposite side and coil it down against its lay to get the turns out without kinking. Wire ropes should be coiled like a figure 8, which enables their being uncoiled without kinking.

To stretch a rope, lay it out its full length along the ground, make fast one end to a swivel-hook block secured to a holdfast which is clear of the ground; connect the other end with the drum of a capstan or winch. As soon as the capstan is worked sufficiently to make the rope taut it will begin to unlay and spin the block around, thus taking the twist out of the rope. When the required strain has been attained the rope should be left taut for an hour or more and then coiled up. In this way it may be tested for strength as well as stretched. (Pl. 38, Fig. 4.)

The Safe Load which can be put on a rope is very much less than the *breaking weight*. It should not exceed one-third of the standard breaking weight, and when using a worn rope or with live loads it is necessary to use a larger factor of safety. Should any doubt exist as to the condition of the rope a portion of it should be actually strained to its breaking point, and the proper factor of safety applied to the remainder, or the whole rope that is to be used tested with a ten per cent greater pull than the proposed working load to be put on it.

The breaking weight of hemp rope, hawser-laid, 3-inch, 3-strand, tarred, is 3 tons per fathom (6 feet) of length. Same rope *white* $4\frac{1}{2}$ tons. Manila rope hawser-laid tarred $4\frac{1}{2}$ tons. Same rope *white* $4\frac{3}{4}$ tons. Coir rope hawser-laid white 7 tons. Steel wire rope 17 tons.

The strength of other sizes, from 1 to 4 inches, can be calculated from this on the principle that the strength varies with the square of the circumference of the rope. Larger sizes than 4-inch are not quite as strong in proportion to their size.

The strength of a chain, when the links are not longer than 5 times the diameter of the iron is: Mean breaking weight in tons = 24 times square of diameter of iron in inches.

The Bight of a rope is any part not an end. **A bight** is a loop formed by bending or doubling the rope.

The Jaws are the open grooves between the strands. A rope is said to be *long-jawed* or *short-jawed* as it is loosely or tightly layed up.

The Running End of a rope is the free end; and the rest of the rope is the *standing* part or end.

Standing Rigging comprises stationary ropes such as guys for sheers, stays for derricks, etc. Guys are made fast to natural or artificial holdfasts. (Pl. 40, Fig. 38.)

Running Rigging comprises ropes running through blocks. (Pl. 39, Fig. 54.)

Whipping is the securing of the end of a rope with twine to prevent it fraying out or unlaying. The method is shown in Plate 38, Figs. 5, 6 and 7.

Worming is filling up the jaws of a rope by laying spun yarn or marlin along them to make a smooth surface for parceling or worming. Pl. 38, Fig. 8a shows the method.

Parceling is wrapping, with the lay of the rope, narrow strips of tarred canvas round it to secure it from injury by water; also to prevent the rope from being chafed or cut when brought against a rough surface or sharp edge. For this latter purpose old rope or canvas suffices. Pl. 38, Fig. 8b, shows the method.

Serving is the laying on tightly of spun yarn or other material in turns round and against the lay of the rope. A serving board or mallet is used to draw the service tight. (Pl. 38, Fig. 8d.) The method is shown in Pl. 38, Fig. 8c.

Splicing is joining two ends of a rope together, or joining an end to any part of it, by interweaving the strands in a regular manner. There are three kinds of splices.

SPLICES

The Short Splice is used to connect two ends of rope not intended to run through blocks.

To make the short splice, unlay for a convenient length the ends of the two ropes to be joined, whip the strands of both ropes with fine twine; having placed each of the strands of one rope opposite to and in the interval between the corresponding strands of the other exactly as shown in Pl. 38, Fig. 9: draw them close together, now hold the end of one rope (the left) and the three strands which come from the opposite rope firmly in the left hand, or if the rope be large tie the strands down with marlin. Take the middle free strand and pass it over the strand of

PLATE XXXVIII

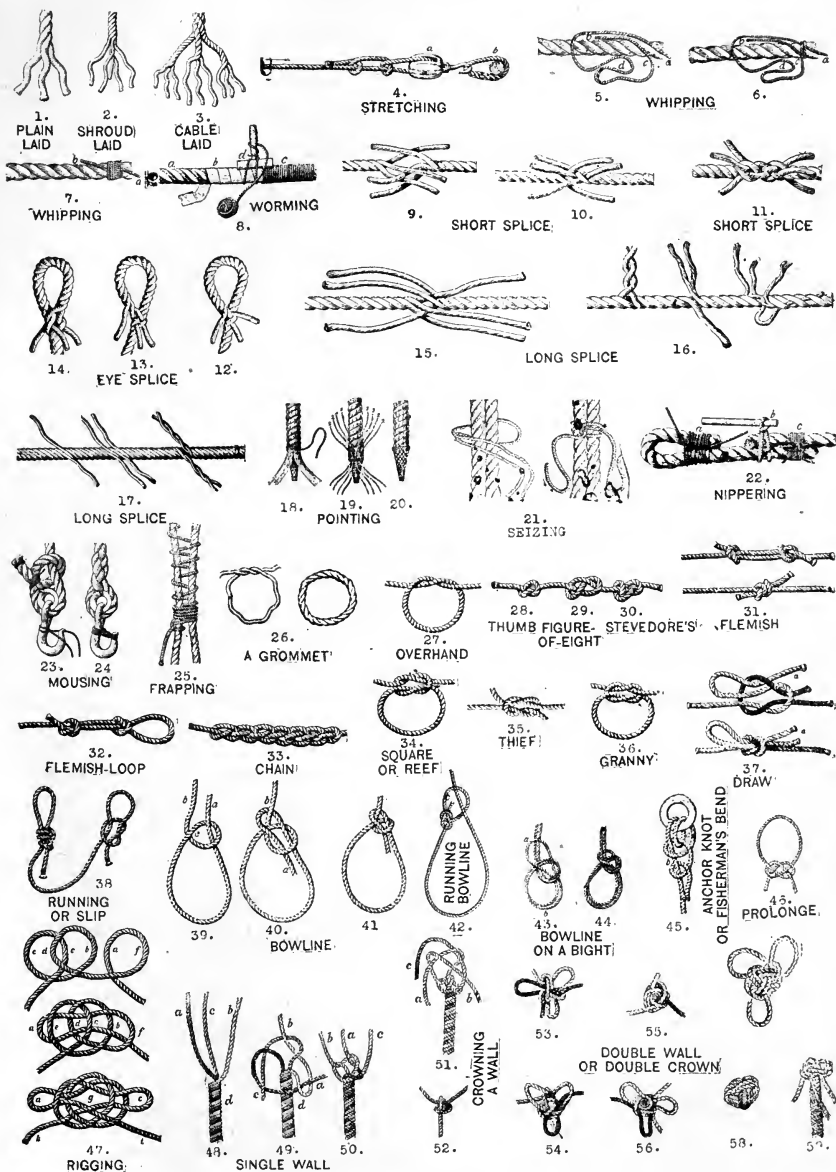

Cordage, etc.

the other rope next to the left of it, then tuck under the second and out between the second and third strands from it, then haul the splice taut. It should now be identical with Pl. 38, Fig. 10. Now pass each of the other strands in the same manner, first those of one rope and then those of the other, the splice assuming the appearance of Pl. 38, Fig. 11. Continue this same operation until the strands are used up—though three tucks of the strands of each rope are usually sufficient. After the ends have been tucked through once, a neater finish may be obtained by dividing the strands, passing one half of each for the second tuck as described above and cutting off the unused half; for the third tuck repeat the halving of each strand. Finish by hauling the strands well through and flatten by beating with a marlinspike or mallet, and cut the ends of strands off close to the rope and whip the joints with twine.

Grease may be rubbed in the strands when necessary to make them flexible.

A tapering pin called a *fid*, if of wood, and a *marlinspike* if of iron, should be used to open the span between strands sufficient for the opposite strand to be pulled through in each case.

The Eye Splice is used to form an eye or loop in a rope. It is made in a manner similar to that of the short splice. The strands are unlaidd as far as may be judged necessary to make three tucks. (Pl. 38, Fig. 12.) The ends of the center and left strand are tucked through the corresponding spaces between the strands of the standing part at a point which will make an eye of the required size. (Pl. 38, Fig. 13.) The splice is then turned over and the remaining strand is tucked under and pointed to the left as indicated in Pl. 38, Fig. 14. The tucking over and under is then continued as explained for the short splice.

The Long Splice is made to join ropes intended to run through a block. To make a long splice unlay the ends of the two ropes to be joined to a distance three or four times as great as for a short splice and place them together. Unlay one strand for a considerable distance and fill up the interval as it is unlaidd with the opposite strand of the other rope following it up closely as shown in Pl. 38, Fig. 15. Twist these two ends together as shown in Pl. 38, Fig. 16, then do the same with two more strands, untwisting the strands in the opposite direction from that of the first. The two remaining strands are twisted together in the place where they were first crossed. Open these last two strands and divide each in two, then make an overhand knot with the opposite halves and lead the ends *over* the next strand and *under* the second in the same manner that the strands were passed for the short splice. Trim off the two halves. Do the same with the others that are placed

together, dividing, knotting and passing them in the same manner. Before trimming off any of the half strands the rope at the splice should be well stretched. Sometimes the whole strands are knotted, then divided and the half strands passed as described.

The long splice is from 15 to 40 per cent. weaker at the splice than the rest of the rope.

Wire Rope is spliced in a somewhat similar manner (Pl. 38, Fig. 17). This rope is usually six-stranded with a hemp core. The three alternate strands of each of the parts to be spliced are first unlaidd to a distance of about nine feet and then cut; the hemp core is also removed the same distance; the rope being first tightly bound with wire at this point. The remaining strands are then unlaidd and the two ropes placed together as for a long splice so that the cut strands abut.

No. 1 cut strand of one rope is then unlaidd and the corresponding strand of the other rope is laidd up in its place until all but nine inches of the latter has been laidd up. No. 2 strand of the first rope is then unlaidd and its place is filled in a similar manner by the corresponding strand of the other rope up to about two feet from where the first two strands met, and then each strand is cut about nine inches from where they meet. In this manner all the strands are laidd in, first those on one side and then those on the other, the distances between the points where the different ends meet being about two feet, and the whole splice taking up about ten feet. The projecting ends of the strands are then laidd into the middle of the rope at these places, the rope being partially untwisted to enable this to be done, and enough of the core being removed to make room for the ends. The rope is then twisted back and well hammered down with wooden mallets, and when the splice has been properly made it cannot be detected after the rope has been running for a day or two.

An Eye Splice in wire is made in a similar manner to that in rope, but in view of the difficulty and delay involved in splicing wire rope, the parts are often fastened together by means of screw clamps or clips which are quickly and easily applied and give as strong a connection as a splice.

Pointing is the operation of tapering the end of a rope so that it will enter a hole or block more easily. (Pl. 38, Fig. 18, 19, and 20.)

Seizing a rope is to lash two parts of it together, or to lash two ropes together, by means of spun yarn, seizing stuff, or marlin, as shown in Pl. 38, Fig. 22, c.

Round Seizing is when the seizing material is wound round both ropes without passing between them as shown in Pl. 38, Fig. 21.

Racking Seizing is when the seizing material is wound round the ropes in figures of eight, as shown in Pl. 38, Fig. 22, *a*.

Nippering is the binding together of two ropes as parts of a block and fall, to prevent them from slipping when the running end is cast loose. It is done by seizing or passing a loop around them once or twice and passing a spike in the bight and twisting it as shown in Pl. 38, Fig. 22, *b*.

Mousing a hook is to seize the point and back to strengthen and prevent it from disengaging itself from anything to which it may be hooked. Pl. 38, Figs. 23 and 24 show the method; it is secured by a square knot.

Frapping is used to draw two ropes and hold them while taking up slack. Pl. 38, Fig. 25, shows the method.

Inside Clinch is used for fastening a stiff rope to a ring or other object. It is made by passing the ends through the ring or round the object, leading it round the standing part and through the bight, forming a circle; a seizing is then put on the circle (sometimes two seizings are put on), and the clinch will appear as in Pl. 38, Fig. 23.

A Strap or Sling is usually made of rope the ends of which are either spliced or tied together. It is passed round the object to be moved, the hook of the tackle being passed through both bights, as shown in Pl. 39, Fig. 42, *c*, or through one bight after it has been passed through the other one.

A Stopper is a short piece of rope, or a gasket used to keep any weight suspended or to take the strain off a rope.

Lashing is the binding, or making fast, of one object to another by means of ropes.

Cleats are used to prevent lashing from slipping, made by cutting lengthwise, diagonally, a piece of 6×6 inch scantling 2 feet long.

Anti-twisters are contrivances employed for preventing the main tackle and guys of sheers and derricks from twisting. They are made by placing a handspike or smooth picket at right angles between the returns as close to the moving block (or block that rotates) as possible, the handspike being kept in place by lashing or drag-rope at one end, held by two men or made fast to a fixed object. Another method is to lash a handspike or capstan bar across the movable or rotating block, with a rope attached to either end of the handspike and held or made fast as before.

A Leading Block is used when a weight is to be raised and force cannot be applied in the direction in which it would be most effective. A single block is made fast at some point so as to lead the fall in the

direction in which it is intended that the weight shall be hauled upon. The rope is passed around the sheave of this block and can then be hauled in the most convenient direction.

KNOTS

Overhand Knot.—Pl. 38, Fig. 27, shows the method of tying. When drawn up tight it is called a Thumb-knot.

Pl. 38, Fig. 28.—Thumb-knot, used to prevent the end of a rope from unlaying, also used as a stopper to prevent the end of a rope from slipping through a ring or eye.

Pl. 38, Fig. 29.—Figure-of-eight knot.

Pl. 38, Fig. 30.—Stevedore's knot.

Pl. 38, Fig. 31.—Flemish knot.

Pl. 38, Fig. 32.—Flemish loop.

Pl. 38, Fig. 33.—Chain knot.

Pl. 38, Fig. 34.—Square or reef knot.

Pl. 38, Fig. 35.—Thief knot.

Pl. 38, Fig. 36.—Granny knot.

Pl. 38, Fig. 37.—Draw knot. It is untied by pulling at the end, *a*.

Pl. 38, Fig. 38.—Running or slip knot.

Pl. 38, Figs. 39, 40 and 41.—A bowline knot.

Pl. 38, Fig. 42.—Running bowline.

Pl. 38, Figs. 43 and 44.—Bowline on a bight.

Pl. 38, Fig. 45.—Anchor knot or fisherman's bend.

Pl. 38, Fig. 46.—Prolonge knot.

Pl. 38, Fig. 47.—Rigging knot. Used to attach guys to a derrick or mast. The opening is placed over the top of the derrick and the four guys are attached to the ends of the rope *h* and *i*, and to the loops *a* and *c*.

Pl. 38, Fig. 48, 49, and 50.—Single wall knot.

Pl. 38, Figs. 51 and 52.—Crowning a wall knot. Fig. 52 shows the crown at the top, i.e., looking down the rope.

Pl. 38, Figs. 53 to 59.—Double wall and double crown.

Pl. 39, Figs. 1, 2, and 3.—Single and double diamond knot.

Pl. 39, Figs. 4 to 7.—Matthew Walker's knot.

Pl. 39, Figs. 8 to 11.—Turk's-head. The method used to insure it from slipping is shown in Pl. 39, Fig. 12; weave the ends as shown in the diamond or the wall knot.

Pl. 39, Figs. 13 and 14.—Single bend, sheet-bend, single becket or

weaver's knot. Used for joining two ropes of different sizes or a rope to another one at an eye.

Pl. 39, Fig. 15.—Double bend or double becket.

Pl. 39, Figs. 16 and 17.—Carrick bend, used for joining a hawser or chain.

Pl. 39, Fig. 18.—Hawser bend.

HITCHES

Pl. 39, Fig. 19.—Half hitch. Made by passing the running end, *a*, of a rope round the rope or spar to which it is to be attached, then round the standing part, *b*, and bringing it up to the bight *c*. It may also be seized to the standing part at *d*. A safe rule to adopt in all cases where a knot is likely to jam or become untied is to lash the free end to the standing part as shown in Pl. 39, Fig. 38.

Pl. 39, Fig. 20.—Two half hitches. Round turn and two half hitches. Same as two half hitches except that a complete turn is first taken round the spar or other object to which the rope is to be attached.

Pl. 39, Fig. 21.—Rolling hitch. Used to haul a spar or other object in the direction of its length.

Pl. 39, Figs. 22 to 25.—Clove hitch, sometimes used to fasten a small boat to a pile or a heaving line to a cable. In the latter case one or two half hitches should be taken round the cable with the free end.

Pl. 39, Figs. 26 and 27.—Magnus hitch, or mooring knot. Used to fasten a mooring rope to a pile.

Pl. 39, Fig. 28 and 29.—Timber hitch. Used to secure a rope temporarily to a spar to lift or haul it.

Pl. 39, Fig. 30.—Marlinspike hitch or lever hitch. Used to draw a seizing tight.

Pl. 39, Fig. 31.—Stopper hitch.

Pl. 39, Fig. 32.—Telegraph hitch. Used to haul a smooth spar in the direction of its length.

Pl. 39, Fig. 33.—Blackwall hitch.

Pl. 39, Fig. 34.—Midshipman's hitch.

Pl. 39, Figs. 35 to 38.—Cat's paw.

Pl. 39, Figs. 39 and 40.—Sheep shank. Used to shorten a rope without cutting it.

STRAPS, ETC.

Pl. 39, Figs. 41 and 42.—Selvagee made by planting two pickets or pins at a distance apart equal to the intended length; wind rope yarn round them until the selvagee is thick enough for the purpose intended and then bind it together with the same yarn, half-hitched round it at intervals of about an inch. The method of applying to a rope is shown in Pl. 39, Fig. 42.

Pl. 39, Figs. 43 to 46.—Gasket. Is made of rope unstranded and plaited.

Pl. 39, Figs. 47 and 48.—Sheer lashing, is used to bind together the legs of sheers in such a way that the lashing will not slip when the weight is suspended from it. The legs are crossed at the end near where the lashing is to be, but with a less angle between them than the legs will have when the sheers will be in position, so that the spreading of the legs will tighten the lashing. Begin with a clove hitch round one leg, then pass as many turns round both legs as may be necessary, ending with two or three frapping turns round the lashing itself and then fast n the end by two half hitches round one leg.

Pl. 39, Figs. 49 and 50.—Barrel or cask sling.

BLOCKS AND TACKLES

Pl. 39, Fig. 51.—A block consists of four parts: the shell or outside framework; the sheave or grooved pulley on which the rope runs; the pin or axle on which the sheave turns; and the strap (when used), made of rope or iron, which encircles the shell and supports the hook and eye of the block.

A mortised block is made of a single block of wood mortised (cut) to receive one or more sheaves.

Pl. 39, Fig. 52.—Heavy blocks for artillery purposes are generally made of an iron or steel shell, with single, double, treble or fourfold brass sheaves.

The size of a block is expressed by the length of the shell in inches. A running block is attached to the object to be raised. A standing block is fixed to the support or holdfast. A leading block is a single standing block used when power cannot be applied directly.

Pl. 39, Fig. 53.—Snatch block, a single sheave block having an opening in one side to insert the bight of a fall.

PLATE XXXIX

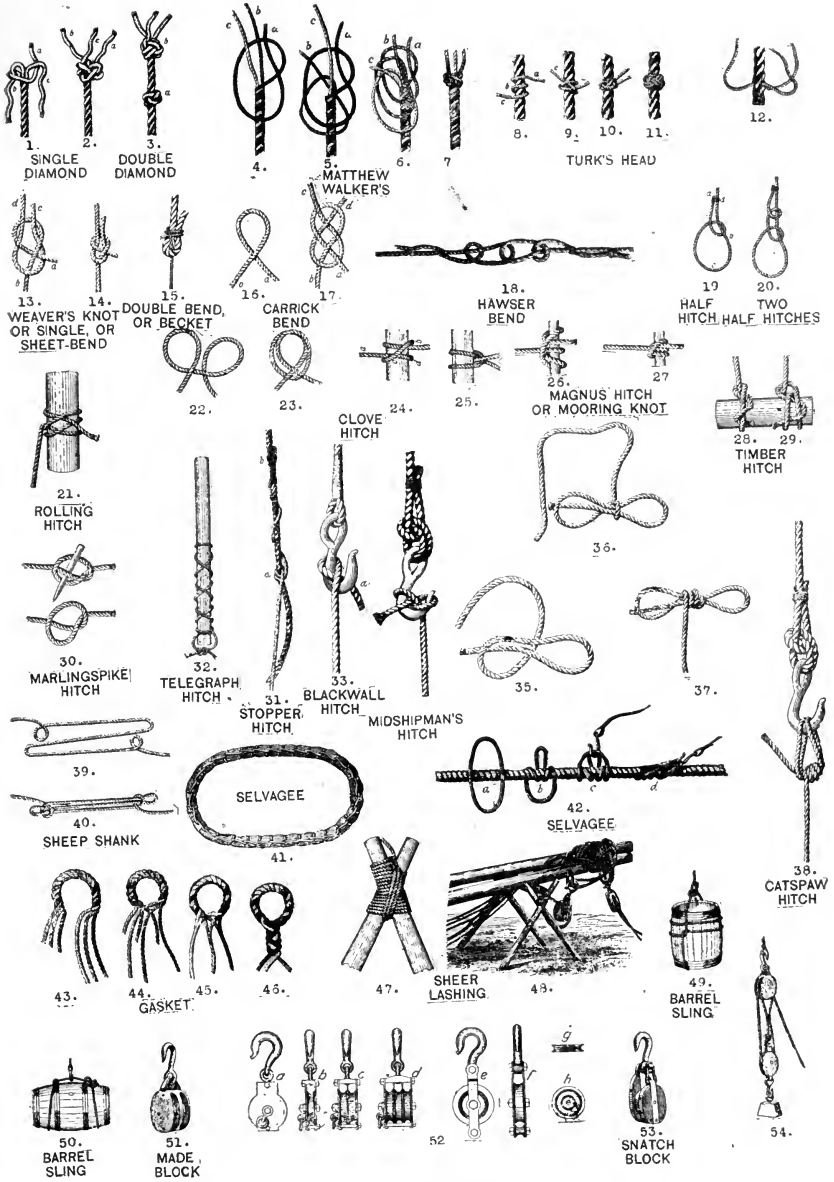

Cordage, etc.



Tackle is a purchase formed by rigging a rope through one or more blocks working together.

Purchase, a tackle of any kind for gaining power.

Simple tackle, consists of one or more blocks rove with a single rope, or fall. (Pl. 39, Fig. 54.)

Standing parts, are parts of the rope of a tackle between the fasts and a sheave.

Running parts, are between the sheaves.

The fall is the part to which the hauling power is applied.

Pl. 40, Figs. 2, 3, and 4.—Whip. The simplest form of tackle; it is made by a rope rove through a single block.

Pl. 40, Fig. 5.—Whip upon whip, so called where the block of one whip is attached to the fall of another.

Pl. 40, Fig. 12.—Gun tackle is made by reeving a rope through two single blocks and making the standing end fast to the upper block.

Pl. 40, Fig. 14.—Luff tackle is made by reeving a rope through a single and a double block. Inverted it is called a watch or tail tackle.

Luff upon luff. A luff tackle upon the fall of another luff tackle is so called.

Gin tackle consists usually of a double and a treble block, but may consist of a single and a double block.

Pl. 40, Fig. 17.—Single Burton consists of two single blocks with the fall reeved as shown in the figure.

Pl. 40, Fig. 18.—Double Burton, a single Burton with an additional whip attached to its fall, the standing part of which is also attached to the weight to be raised.

Pl. 40, Fig. 19.—Spanish Burton, a gun tackle with a whip attached to its fall.

Pl. 40, Fig. 20.—Double Spanish Burton, a luff tackle with a whip attached to its fall in the same manner as a Spanish Burton.

POWER OF TACKLE

The actual power of any tackle may be approximately calculated from the theoretical power. In obtaining the latter it is assumed the rope or cord used is perfectly flexible, not elastic, and that the blocks have no friction. It is obviously impossible to find such a condition in practice. By the power of a tackle is meant the ratio of the force exerted by it to that applied to the fall. This should, more strictly speaking, be termed force, and not power, as force is that which is gained by a tackle.

If a weight W , equal to P pounds, is suspended from one end of a perfectly flexible and inextensible cord passing over any number of frictionless pulleys, a pull equal to P pounds will have to be exerted at the other end of the cord to support this weight, and every intermediate portion of the cord will have a pull upon it equal to P pounds, which is exerted in the direction of the cord. See Pl. 40, Fig. 1. This is the fundamental principle of the theoretical power of any tackle.

The theoretical powers of the various tackles illustrated in Pl. 40, Figs. 1 to 20 inclusive, are shown on the figures themselves. A simple rule of obtaining the gaining power of any tackle is that the force applied multiplied by the number of moving parts is equal to the power gained. For example, Pl. 40, Fig. 15, shows one standing part (i.e., the part attached from the hook of the upper block to the sheave of the lower block), and four running parts; accordingly the power gained for hoisting is four. The tackle inverted would give a power of five, for the reason in that case the upper part moves, increasing the number of running parts by one.

LEVERS

The three orders of levers are shown in Pl. 40, Figs. 22 to 29, called respectively lever of the first class, second class, and third class. The classification depends entirely on the position of the fulcrum or prop. The fundamental equation of these classes of levers, under the supposition that the lever is straight and that the weight W and force F act at right-angles to it, is as follows: lever arm L is equal to the weight W times its lever arm Cl or the counter-lever arm; or $F = \frac{W \times Cl}{L}$.

When levers are such that the weight and force do not act at right angles to the lever, the perpendicular distances from the fulcrum to the lines of application of the force and weight, as shown in Pl. 40, Figs. 24, 26, and 27, are taken as the lever and counter-lever arms. Taking such distances, the above formula holds good, but it must be remembered that in using a lever of this kind the lever arm and the counter-lever arm do not usually remain constant, but change in might as the lever is moved and the direction of the applied force changes with respect to the lever, see Pl. 40, Fig. 28.

The gaining power or mechanical advantage of a simple lever is equal to $\frac{L}{Cl}$ and that of a double compound lever is equal to

PLATE XL

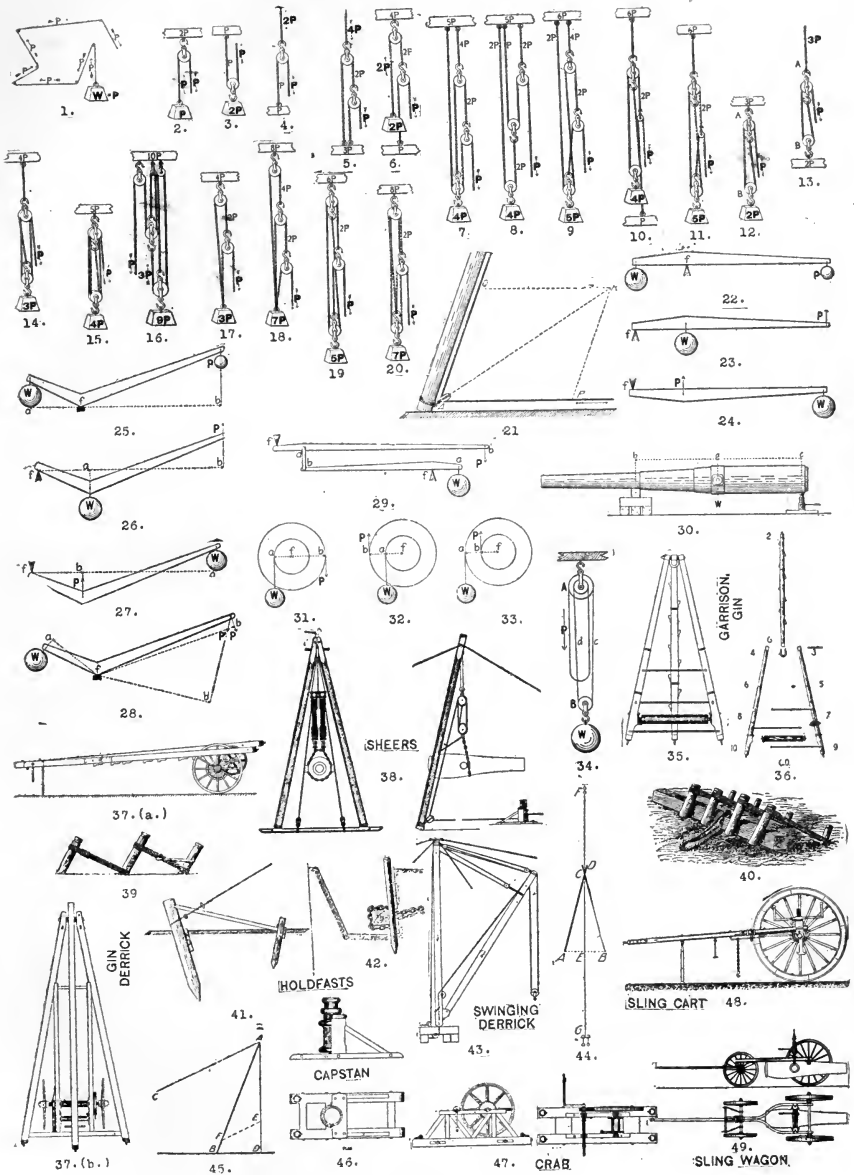

Cordage, etc.

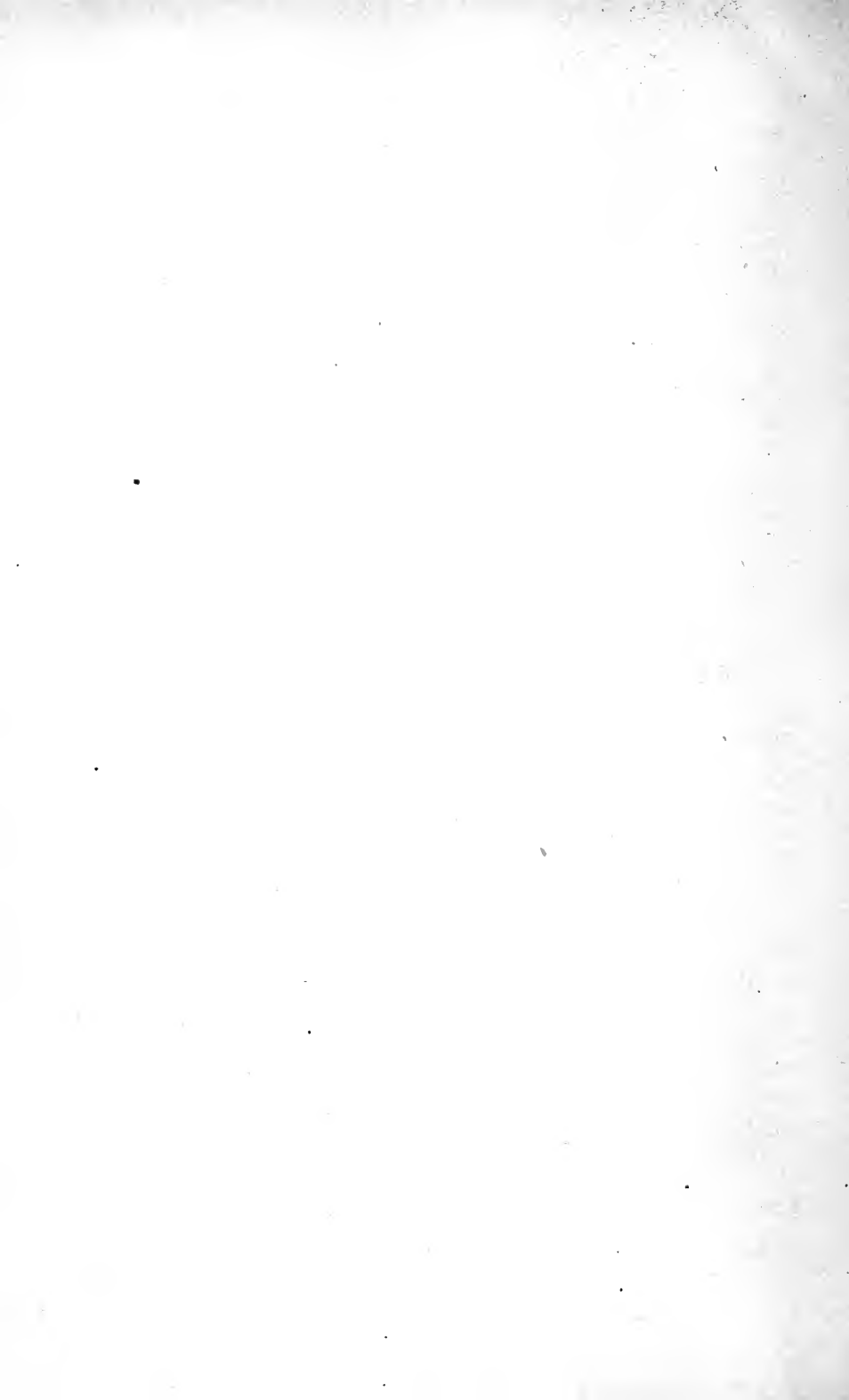

$\frac{L}{Cl} \times \frac{L'}{Cl'}$ in which L and L' , Cl and Cl' pertain to the corresponding parts of the two levers, see Pl. 40, Fig. 29.

An example of the lever of the second class is shown by the gun represented in Pl. 40, Fig. 30. The gun is resting on two supports, the blocking in front of the trunnions representing the fulcrum and the jack under the breech representing the applied force; the weight supported by the jack as well as that supported by the blocking can readily be determined as follows: $W=30$ tons, L or ac in the figure = 227 inches, cl or $ab=112$ inches, therefore the applied force or the weight supported by the jack = $\frac{30 \times 112}{227} = 14 +$ tons, and the weight supported by the blocking equals $\frac{30 \times 115}{227} = 15 +$ tons.

REVOLVING LEVERS

The three classes of revolving levers are shown in Pl. 40, Figs. 31, 32, and 33. The principle of these levers is exactly the same as that enumerated in the foregoing cases. The lengths of the lever and counter-lever arms are in this case the respective radii of the two circles. This variety of levers is exemplified in the windlass of a gin, Pl. 40, Fig. 35; the capstan, Pl. 40, Fig. 46; and the crab, Pl. 40, Fig. 47.

DIFFERENTIAL PULLEY

The differential pulley embodies the principles of the revolving lever, combined with that of a single movable block. It consists essentially of two iron pulleys of unequal diameter mounted upon a common axle and rigidly attached to each other; an endless chain passes round the larger pulley A (Pl. 40, Fig. 34), down round the movable pulley B and up round the smaller pulley mounted on the same axle with A . The upper pulleys are sprocket wheels in order to prevent the slipping of the chain. Weight is suspended from the lower pulley and the force is applied to the chain at P . An example of the power gained by the tackle, neglecting friction, is as follows: If the radius of the larger pulley is 6 inches, and the small pulley 5 inches, the power of the tackle will be 12, and if W equals 1200 lbs., F would equal 100 lbs., or $2 \cdot \frac{6}{6-5} = 12$.

GINS, ETC.

The mechanical appliances employed in fortifications for raising weights are **Gins, Sheers, Derricks** and **Cranes**. In each case the weight is raised by means of a tackle, either alone or in combination with a **Capstan, Crab**, or the **Drum** of a hoisting engine. To raise excessive weights the **Hydraulic Jack** is used in combination with suitable crib work built up of wooden blocks.

A **Gin** is represented in Pl. 40, Fig. 35. The two poles supporting the *windlass* are called *legs*, while the third is called the *pry-pole*, and is joined with the others at the head by a *bolt* which also supports a *clevis* to which the upper block of the tackle is hooked. The windlass is turned by two metal *handspikes* which fit into brass sockets at each end. Two *pawls* acting on *ratchets* at the ends of the windlass keep it from turning backward.

Shoes consisting of wooden blocks are placed under the lower ends of the two legs and pry-pole called the *feet*, to keep them from sinking into the ground. That part included between the legs and pry-pole after the gin is raised, is called the *inside*; the *right* and *left* sides are the corresponding right and left sides of a man standing behind the gin and facing it.

The tackle for hoisting is usually a double and treble block with fall led to the windlass over which it is wound two or more times to keep it from slipping, the slack of the rope being taken up by hand as the windlass revolves. The feet should be as nearly as possible at equal distances from each other and on the same level, in order that the weight may be evenly distributed on the three supports. This is essential when the maximum weight for which the gin is designed is to be raised. A garrison gin, if perfectly sound, is capable of sustaining a weight of 17,000 lbs.

The detachment required to put the gin together and handle it with facility is composed of one chief of detachment, one gunner and ten privates. The post of the chief is in rear of the gin, but he goes wherever his presence is necessary. The gunner is on the left side near the head. The odd numbers are on the right, and the even numbers on the left side and facing the gin. Pl. 40, Fig. 36, shows their relative positions. The chief of detachment superintends the placing of the windlass, and the gunner the putting together of the head; assisted by the most expert privates, he reeves the fall, slings the gun or weight to be raised and attends to all knottings and lashings.

The fall is either reeved on the ground and the upper block then

hoisted up to its position by means of a rope passing over the clevis; or after the gin is only partly raised the upper block is hooked to the clevis and the lower block to the middle brace, where it is held in the proper position for reeving. The fall is then reeved by the gunner passing the end of the fall through the left sheave of the upper block from without to within, after which it is passed through the sheave of the lower block from within to without, then up and through the upper sheave of the upper block in the same direction as the first time and the end then made fast to the lower block. With a treble upper block it is preferable to pass the rope through the middle sheave first, as it will then lead better.

Usually the gin is raised, after being put together, by raising the head and bringing up the foot of the pry-pole towards the foot of the leg. To raise the gin, Nos. 1 and 2 take hold of the pry-pole; Nos. 9 and 10 each hold down the foot of a leg to keep it from slipping; Nos. 3 and 4 remain at the head, and Nos. 5, 6, 7 and 8 apply themselves to the legs on their respective sides. The gunner commands, *Heave*, and the gin is raised; shoes being placed under the pry-pole and each leg.

To move the gin after it has been raised, Nos. 1 and 2 apply themselves to the pry-pole; Nos. 9 and 10 each place a handspike under the windlass from without and near the legs and assisted by Nos. 7 and 8 from within, they lift and move the gin in the direction indicated.

The gin is lowered and dismantled by the reverse operations prescribed in the foregoing.

A Gin Derrick is represented in Pl. 40, Fig. 37 (*a* and *b*). It is a light gin equipped with a gearing for operating the windlass. It is operated like other gins except that the power is applied to the wheels instead of to the handspikes.

Sheers are represented in Pl. 40, Fig. 38. They are composed of two legs of suitable size. The upper end is called the head, the lower end the heel and the part where they are lashed together (as shown in Pl. 39, Fig. 48) the cross. A gin may be used as sheers by removing the pry-pole, replacing it by a short block of wood of equal thickness, and attaching the guy ropes. Sheers are used for lifting heavy weights over a wall, and for loading and unloading guns, etc.

The following table gives the approximate size and length of spars required.

Weight to be Raised.	Mean Diameter.	Length.
3 to 5 tons	11 to 13 inches	30 to 40 feet
5 to 12 "	13 to 16 "	40 to 50 "
12 to 25 "	16 to 20 "	50 to 60 "

In some sheers the legs are connected by a bolt through the head, as shown in Pl. 40, Fig. 38, instead of being lashed together as in Pl. 39, Fig. 47.

The materials necessary to equip a pair of sheers are:

Gun Tackle.—Two single and two double blocks.

Main Tackle.—One double, one treble and one snatch block.

Cordage.—Main tackle fall, 100 fathoms (a fathom is a measure of 6 feet) of 3- to 5-inch manila rope; guys, 100 fathoms of 3- to 6-inch manila rope; head lashing, 10 fathoms of 3- to 4-inch manila rope; heel lashing (two each), 10 fathoms of 3- to 4-inch manila rope; contingencies, 50 fathoms of 3- to 4-inch manila rope.

Straps.—Main tackle, one fathom long, of 6-inch manila rope; snatch block, one fathom long, of 4-inch manila rope; guys (two), each one fathom long, of 4-inch manila rope; holdfasts (six), each one fathom long, of 4-inch manila rope; contingencies (six), each a half fathom long, of 4-inch manila rope.

Spun-yarn for mousing, stoppering, etc., one ball of 100 fathoms. Two cleats, to be spiked to the heels about 6 inches from the bottom. Stakes for holdfasts and heel posts; two shoes for heels or one long shoe joining the two heels as in Pl. 40, Fig. 38.

TO RIG THE SHEERS

To rig the sheers, Pl. 39, Fig. 48, lay the heads of the spars on a trestle about three feet high, so that they cross at about twice their thickness from the upper ends, with the heels in the proper positions and the distance from the cross to each heel exactly the same. Make the sheer lashing, as previously described; or, if a very heavy weight is to be raised, as follows:

Take a good piece of 3- or 4-inch rope, well stretched, middle it and make fast to one of the legs below the cross; with one end pass the requisite number of racking seizing turns (Pl. 38, Fig. 21) round both spars, hauling each one taut, and hitch the end to the upper end of the sheer-leg; with the other end pass round-seizing turns round both spars, filling up the spaces between the ropes of the first turns, as far up as the first rope, and pass frapping turns round all the parts of the lashing between the sheers; finish with a square knot and seize the ends with spun yarn. If necessary tighten up the lashing with wedges.

A guy strap having the splice in the center, so that the splice cannot come into either bight, is then laid between the spars above the cross

and equally divided, each end led round the spar farthest away from the guy for which it is intended, the ends brought back round both spars, for the upper guy block to be hooked to, or the guy rope itself is attached to the guy strap. The other guy strap is put on in the same manner, the strain on each guy thus tending to bind the spars together.

The main tackle sling is then put on over the cross from front to rear, passing over the guy straps and under the bights for the headblocks (Pl. 39, Fig. 48.) The upper block of the main tackle is then hooked through both bights of the main sling and the hook moused.

Sink or lash the shoes in proper positions. They must be on the same level, and, in bad ground, prevented from sinking or slipping by placing planks, brushwood or timber underneath, securing them by pickets. Pickets are then driven as holdfasts for the foot ropes; for the lighter sheers, two for each foot, one in front and one in rear of the shoes, so as to be just inside the heels of the legs when they are on the ground and a few feet to the front and rear of the shoes. For the heavier sheers four are required for each foot. Make a clove-hitch with the middle of a foot rope round each leg below the cleats and lead the ends to opposite holdfasts where they are made fast.

Put down the holdfasts for the rear and front guys. The kind of holdfasts to be used will depend upon the strain on them, the nature of the ground, etc. Those shown in Pl. 40, Figs. 39, 40, 41, or some modification of them, will generally be used, but sometimes the holdfast for the rear guy will have to be sunk in the ground as in Pl. 40, Fig. 42, to obtain a firm hold. Care must be taken to have both holdfasts on the line *FG* (Pl. 40, Fig. 44) perpendicular to the line joining the heels of the sheers at its middle point.

Hook the upper blocks of the guy tackles to a bowline in the end of the guys, or to the guy straps, and the lower blocks to the holdfast straps, and mouse all the hooks. Ordinarily the fore guy can be worked without a tackle, belaying it over the holdfasts, first taking a round turn over the next one to the sheers, but if the sheers have to be inclined to the rear with the weight on them, the front guy should also be provided with a tackle, and be as carefully secured as the rear guy.

If the sheers are not too heavy they may be raised by lifting the head and hauling on the proper guy tackle, slacking the heel lashings as required, and tending the opposite guy carefully to prevent the sheers from falling over after passing the vertical.

If the sheers are too heavy to raise in this way, form a crutch by lashing together two poles, or the legs of a gin, near their upper ends, the feet of the crutch being slightly in rear of the heels of the sheers and

temporarily secured to prevent them from slipping. Lay the rear guy over the crutch and raise the crutch by means of two light guy ropes until it is inclined at an angle of about 45 degrees to the front. Haul on the rear sheer guy, allowing the crutch to rise as the sheers rise. After the sheers are raised high enough so that the crutch ceases to act it is lowered by means of its guy ropes. In general, the inclination or *rake* of the sheers should not exceed 20 degrees, or four-elevenths of their height. In this position the pull on the guy will not exceed one-half the weight. An allowance of 7 or 8 degrees in the rake should be made for the stretch of the guys.

After the sheers are raised hook the snatch block to a strap placed below the cleat on one of the legs, or to a holdfast placed in a convenient position.

Pl. 40, Fig. 44, represents in plan the position of the sheers, holdfast, etc

AD, BC are the legs of the sheers.

F, the front guy holdfast.

G, the rear guy holdfast.

E, the center of the line AB at right angles to FG.

AC = BC.

The splay $AB = \frac{1}{3} CE$.

EF and EG = at least 2 AC.

DERRICKS AND CRANES

Derricks are of two kinds, standing and swinging.

A Standing Derrick (Pl. 40, Fig. 21) consists of a single spar and is used when a direct lift or slight lateral movement is required. The spar rests on a shoe and is supported in a vertical or slightly inclined position by three or four guys attached to the head, making equal angles with each other and secured at distances, from the foot of the derrick, of at least twice the length of the derrick. The strap for supporting the hoisting tackle rests in a groove cut in the top of the spar. The guy blocks are lashed to the head of the derrick, the lashing passing over the strap for the hoisting tackle, binding it to the spar. Foot tackles are used to prevent the derrick from slipping and a snatch block, lashed with a cleat, is secured at the foot through which to lead the fall from the hoisting tackle. The top of the spar can be moved a limited distance by slacking or hauling in on the proper guys, and in this way the weight moved laterally.

A Swinging Derrick, as shown in Pl. 40, Fig. 43, consists of two spars, i.e., an upright called the mast, and a swinging spar attached to the mast near its base, called a boom. With this derrick a weight cannot only be raised and lowered, but swung in a circle, of which the base of the mast is the center, and also moved in and out from the mast a distance limited by the length of the boom. The mast is held in a vertical position by three or four guy ropes. Wire ropes fastened to a collar on the top of the mast are usually used when the derrick is to remain erected for some time. The method of supporting the boom, etc., is shown in Pl. 40, Fig. 43, the fall being led to the drum of a hoisting engine or to a capstan or crab. For steadying the weight and moving it laterally, two smaller guy ropes are usually fastened to the weight or to the block supporting it.

A Temporary Swinging Derrick may be rigged up by lashing the guys and fastening the lower end of the boom to the mast by a rope sling, and lashing the necessary blocks to the upper end of the boom and mast to support the boom and the weight.

For steadying the weight and moving it laterally two smaller guy ropes are usually fastened to the weight or to the block supporting it.

The same precautions should be taken in erecting a derrick and handling a weight with it as in operating with sheers.

To ascertain the pull on the guys and thrust on the spars of sheers and derricks.—Construct on paper or on the ground a diagram similar to Pl. 40, Fig. 45.

AD to represent a vertical line.

AB the inclination of the sheers when supporting the weight.

AC the inclination of the guys.

With a scale of equal parts (as large as can be conveniently used) lay off on the line AD, from A, a distance equal to the number of units of weight; through the point E thus found draw EF parallel to AC until it cuts AB at F. Then the distance EF measured by the same scale will represent the pull on the guy and AF the thrust on the spars. If there are two spars the thrust on each one will evidently be one-half of this, or rather a little more than one-half, depending on the angle which they make with each other.

It must be borne in mind that the thrust on the sheers is not only that due to the weight lifted, but in addition to this the amount of pull on the end of the fall required to support this weight (see Pl. 40, Figs. 12, 13, and 14).

A Crane differs but slightly from a derrick and is used for the same

purpose, being usually supported by braces and tie rods, when necessary, instead of by guys.

Light cranes are used in many of the gun emplacements to lift projectiles up to the loading platform and, in case of the larger barbette non-disappearing carriages, from this platform to the breech of the gun.

A Capstan (Pl. 40, Fig. 46), is a machine used as a strong purchase for heaving or hoisting. When so employed it is held in position by strong ropes or chains attached to holdfasts. The rope is passed two or three times round the barrel of the capstan, the free end coming off above the turns, and the standing part being attached to the weight to be moved. The capstan bars are inserted in mortises in the head of the capstan, and the free end of the rope is held and taken in by two men seated on the ground.

Twelve men, three at each bar, are all that can be advantageously employed. When additional power is required, the bars are swifited, that is, the outer ends of the bars are joined by a rope lashed to each bar for additional men to take hold of. In some cases horse power is used.

A Crab (Pl. 40, Fig. 47) is used for the same purpose as a capstan; but with this machine the force it applied to two winches and power is gained by the operation of smaller cog wheels upon larger ones; it being a compound revolving lever.

The Sling-cart is used for moving guns, or other heavy objects, short distances. There are two kinds: The garrison sling-cart (Pl. 40, Fig. 48), for the heaviest weights, is attached by its pole to a limber, and may be drawn by horses; the hand sling-cart is designed for moving lighter weights by hand.

With the hand sling-cart the weight is raised sufficiently from the ground to transport it by first attaching a sling of the proper length to the weight to be moved and then raising the pole of the cart enough to permit the hook on the rear of the axle being hooked into this sling. The pole in this case is used as a lever, the axle and wheels being the fulcrum, and the weight is raised by lowering the end of the pole. It may be used for transporting any weight up to 6,000 pounds.

With the garrison sling-cart the weight is raised by first attaching it to a sling, and then applying the sling to the hooks forming the lower part of a powerful screw passing up through the axle of the cart. Above the axle is the butt of the screw, provided with long handles by means of which the screw is run up, thus raising the weight.

This sling-cart is capable of supporting 20,000 pounds; but as with such heavy weights it is difficult to turn the handles of the screw to

raise it; the cart has been modified by substituting a hydraulic jack for the screw.

A Sling-wagon (Pl. 40, Fig. 49) is also provided for moving guns or heavy material. In this the weight is raised by means of a hydraulic jack, and supported by pins through the vertical bars, which support the weight.

THE HYDRAULIC JACK

This is a lifting apparatus operated by means of a liquid acting against a piston to raise it, the pressure on the liquid being produced by a force pump. There are two kinds of Dudgeon's hydraulic jacks, the base and the horizontal, the principle and method of operation being the same in both. There are also three sizes supplied by the Ordnance Department capable of lifting 15, 20 and 30 tons respectively. Both larger and smaller jacks than these are also manufactured, and can be obtained where needed.

A sectional view of the horizontal jack is shown in Fig. 74, with the names of the different parts.

Instructions for using.—Fill the jack, when the ram is quite down, through the screw-hole in the head, within half an inch from the top, with alcohol 1 part, water 2 parts and add a tablespoonful of sperm oil.

Never fill with water, kerosene or wood alcohol. Water is dangerous on account of its liability to freeze and to rust the jack when not in use. Kerosene destroys the packings, and wood alcohol corrodes the metal surfaces and destroys the packings.

Heavy oils and glycerin soften the packings and gum clog the valve ports.

The screw in the head is not intended to fit tightly, as an air passage is cut in it.

Be careful that no dirt gets into the reservoir in filling.

Occasionally clean it out and refill it, as the liquid becomes thick and the jack will not then work well.

Always keep the ram quite down when not in use.

In using, place the head or the claw under the weight to be raised. Put in the lever with the projection downward. Work it until the weight is at the required height, or the number of inches the jack runs out. Sometimes it happens that another stroke of the lever will raise the weight too high; then raise the lever and push it down slowly, by which a stroke will be missed.

In most jacks there is a tell-tale hole in the cylinder which lets the liquid out when the ram is raised beyond the safety point.

To lower the weight with the old-style jacks, push the lever to the bottom of the stroke, take it out, and insert it with the projection upward and with a slight pressure of the hand the weight will be

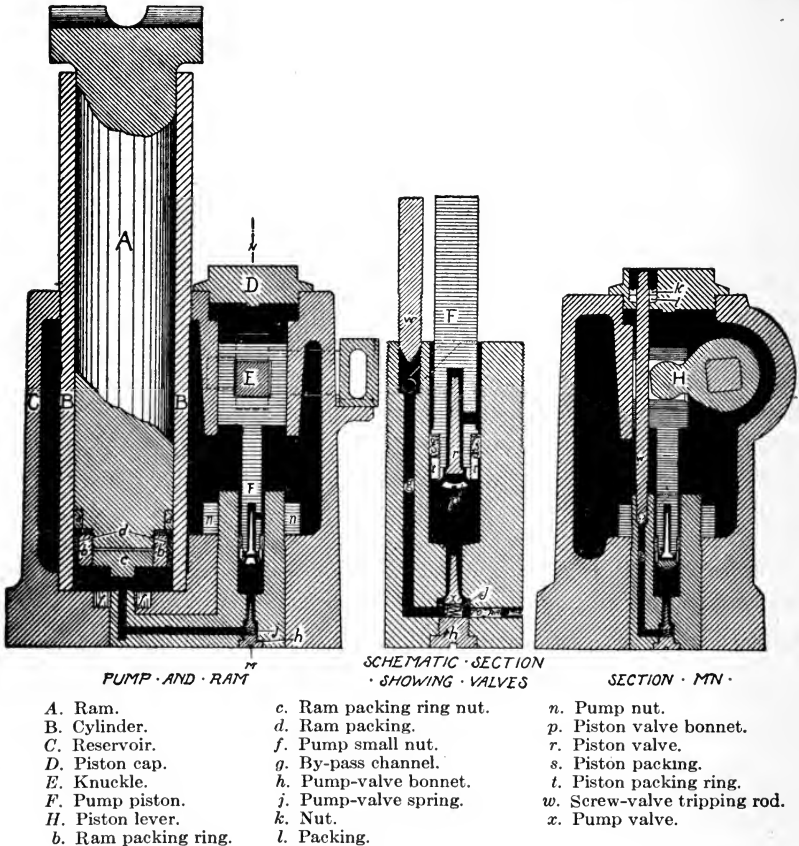

FIG. 74.

lowered as slowly as required, or stopped at any point. Do not push the lever down quickly, but slowly, tapping it a little with the hand.

If the valve should stick on its seat (in which case the jack will not work), strike the lever a few sharp blows up and down, jarring the valve and removing the difficulty.

With the latest improved jacks, that have the screw valve *w*; to raise the weight, screw this valve down tight on its seat with the wheel

before beginning to pump. To lower, unscrew the same; two full turns are sufficient to lower as fast as required. It can be lowered fast or slowly by unscrewing the valve from its seat any distance up to two turns, and can be checked by screwing the valve back to its seat.

These jacks may be used equally well in horizontal or upright positions except that care must be exercised not to leave them too long in a horizontal position, as there is then a leakage of the liquid through the vent, and the pump, *F*, must always be submerged in order that it may work.

A jack not in use should be kept filled and pumped up under pressure at least once a month.

TO REPAIR JACKS

Instructions for Repairing Jacks.—Trouble with hydraulic jacks is most frequently caused by rust or by foreign substances within the jack and good care is essential to keep a jack in order. Without this, it is useless to expect it to give satisfaction. Rust and sand or grit will soon injure the valves, packings, and polished surfaces of the cylinder and pump, and these are the vulnerable parts of all hydraulic appliances.

The packing and the valves are very simple, and the following directions will give all the information necessary to keep them in order:

If the filling flows over the top of the cylinder or through the cylinder vent, the ram packing leaks. Remove the ram from the cylinder, and if the packing is only worn, place a strip of very thin tin under it. If it is broken or torn, unscrew the packing rings, put on a new packing, and replace the rings. If the packing is too large, or if the ram does not run down easily, take off a very little from the outside of the packing with a clean file or rasp. Be careful not to take off too much, for a new packing must be reasonably tight, as it will soon wear smooth. Fit a new packing tight enough to require the weight of two men to force down the ram, for if the packing is made too slack, it will soon leak. The bottom packing seldom gives trouble, and should last for years. If, however, it becomes necessary to renew it, it should be done by driving it from the upper end of the cylinder to the bottom.

If the piston packing becomes worn, unscrew the head, draw out the piston, renew the packings, and file off the edges to fit the pump.

To remove the piston of the horizontal jack, unscrew the cap, turn back the socket until the arm is disengaged, and draw out the piston.

If the valves or valve seats become worn or scratched, unscrew the

valve bonnets and regrind the valves with oil and very fine flour of emery. Be careful not to grind the valves too much, and to wash the valves and seat perfectly free from emery before replacing the valves.

The piston valve of the horizontal jack is reached by removing the piston, as before described, and the pump valve by unscrewing the pump-valve bonnet in the bottom of the cistern.

If the ram does not rise when pumping, examine the piston valve; if the lever rises when the hand is removed, examine the pump valve.

CHAPTER XII

MAGAZINE RIFLE

THE U. S. magazine rifle, model of 1903, caliber .30, is shown in Fig. 75. It is equipped with a rear sight, model of 1905, a knife bayonet, model of 1905, and gun sling, model of 1907. The appendages of the rifle consist of front sight cover; the oiler and thong case (carried in the butt of the stock), consisting of an oiler and dropper, thong and brush complete. The accessories of the rifle consist of a brass cleaning rod and screw driver. A kit of tools is issued to each company or troop and to each regimental or post ordnance officer for use in repairing the rifle and bayonet.

The rifle proper consists of 89 component parts. The bayonet proper consists of 12 component parts.

The total weight of the arm, including bayonet, oiler and thong case, is 9.69 pounds. The bayonet weighs 1 pound.

The total length of the gun, without bayonet, is 43.212 inches. The total length of bayonet, is 20.56 inches. The total length of gun and bayonet (when attached) is 58.96 inches.

The caliber is .30 of an inch. The rifling consists of four plain grooves, 0.004 inch deep; the grooves are three times the width of the lands. The twist of rifling is uniform, one turn in 10 inches.

The rifle is stamped with the Ordnance escutcheon, together with the initials of the place of manufacture and the month and year; this stamp is on the top in rear of the front sight stud. Those manufactured prior to 1906 are stamped with the year but without the month.

The magazine holds five cartridges. The trigger pull is equal to from 3 to 4½ pounds, measured at middle point of bow of the trigger.

The computed maximum range is 5,465 yards, with a time of flight of 31.36 seconds. Elevation 45 degrees. Initial velocity, 2,700 feet per second. Powder pressure in chamber, about 49,000 pounds per square inch.

POINTS IN HANDLING

If it is desired to carry the piece cocked, with a cartridge in the chamber, the bolt mechanism should be secured by turning the safety lock fully to the right. If this is not done the rifle may be discharged upon turning the safety lock fully to the ready position.

Under no circumstances should the firing pin be let down by hand on a cartridge in the chamber.

To obtain positive ejection, and to insure the bolt catching the top cartridge in magazine, when loading from the magazine, the bolt must be drawn fully to the rear in opening it.

The piece is habitually carried locked; that is, with the safety lock at the "safe." It is always locked after executing *cease firing*.

To prevent accidents, the chamber is opened and the magazine examined when troops are first formed and again just before they are dismissed. When rifles are not in use, as, for instance, when they are in gun racks, etc., the trigger should be pulled to relieve the strain on the spring.

The *cut off* is kept turned "off" except when actually using cartridges.

When the bolt is closed, or slightly forward, the *cut off* may be turned up or down, as desired. When the bolt is in its rear-most position, to pass from loading from the magazine to single loading, it is necessary to force the top cartridge or follower below the reach of the bolt, to push the bolt slightly forward and to turn the cut off down, showing "off."

In aiming the rifle, care should be exercised that the fingers do not cover the gas

escape hole just above and to the rear of the grasping groove on the right side of the piece.

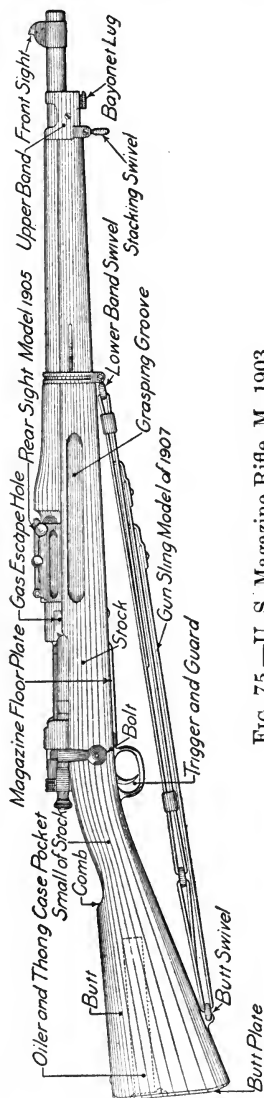

FIG. 75.—U. S. Magazine Rifle, M. 1903.

In case of a misfire it is unsafe to draw back the bolt immediately, as it may be a case of hang fire. In such cases the piece should be cocked by drawing back the cocking piece.

The bayonet is not fixed except for instruction, in bayonet exercise, on guard, or when needed for purposes of defense or offense.

Experimental firing and laboratory experiments show that, all other conditions being identical, the muzzle velocity of ammunition loaded with smokeless powder will be increased by exposure to a higher atmospheric temperature, and decreased by a lower.

Variations in the barometric pressure and the percentage of humidity of the air will also cause variations in the velocity; consequently the elevation for any range will vary slightly with these conditions. Moreover, the velocity of 78 feet stamped upon the bandoleers may vary, in different issues of ammunition, 20 feet on either side of the standards. The muzzle velocity obtained in different rifles also varies with the same ammunition.

In adjusting the sight for elevation at any range, it must be borne in mind that in addition to the allowance made for variations in the velocity of the ammunition, allowance must also be made for the effect of differences in light, the amount of front sight seen, the effect of mirage on the target, the effect of heat developed in the gun in firing, the condition of the bore as to cleanliness, the personal equation of the firer, the peculiarities of individual guns, etc.

The graduations of the rear sight are correct only for the particular conditions existing when they were experimentally determined, consequently, in adjusting the sight for elevation at any range, allowance must be made for whatever change in the elevation the difference between the former and the present conditions produces.

DISMOUNTING AND ASSEMBLING

Figure 76 shows the bolt and magazine mechanism. They can be dismounted without removing the stock. The latter should never be done, except for making repairs, and then only by some selected and instructed man.

To Dismount the Bolt Mechanism, place the cut off at the center notch; cock the arm and turn the safety lock to a vertical position; grasp the piece as shown in Fig. 77, raise the bolt handle and draw out the bolt.

Hold the bolt in the left hand as shown in Fig. 78, press sleeve lock

in with the thumb of right hand to unlock sleeve from bolt and unscrew sleeve by turning to the left.

Hold the sleeve between the forefinger and thumb of the left hand, draw cocking piece back with the middle finger and thumb of the right

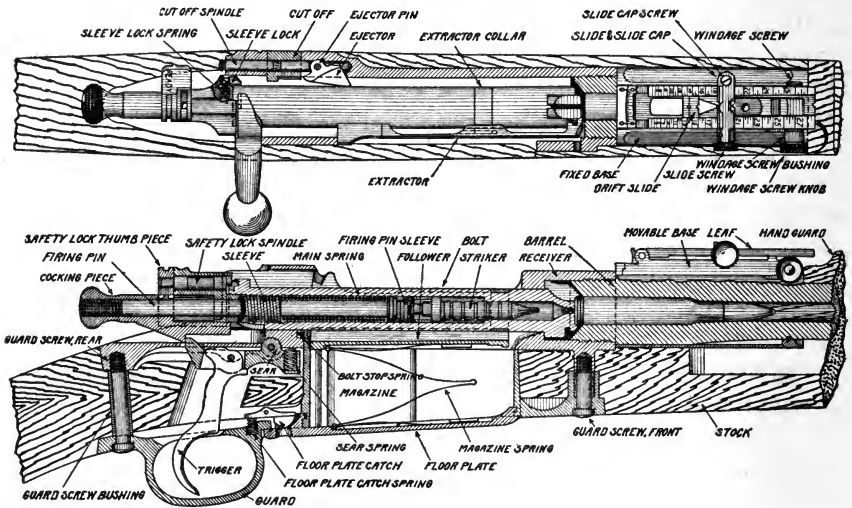

FIG. 76.

hand, turn safety lock down to the left with the forefinger of the right hand, in order to allow the cocking piece to move forward in sleeve, thus partially relieving the tension of mainspring; with the cocking piece against the body, draw back the firing-pin sleeve with the fore-

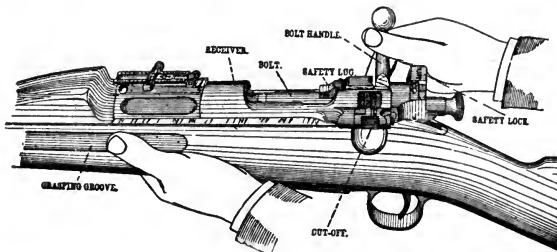

FIG. 77.

finger and thumb of the right hand and hold it in the position shown in Fig. 79, while removing the striker with the left hand; remove firing-pin sleeve and mainspring; pull firing pin out of sleeve; turn the extractor to the right, forcing its tongue out of its groove in the front

of the bolt, and force the extractor forward as shown in Fig. 80, until it is off the bolt.

To Assemble Bolt Mechanism, with the left hand grasp the rear of the bolt, handle up; with the thumb and forefinger of the right hand

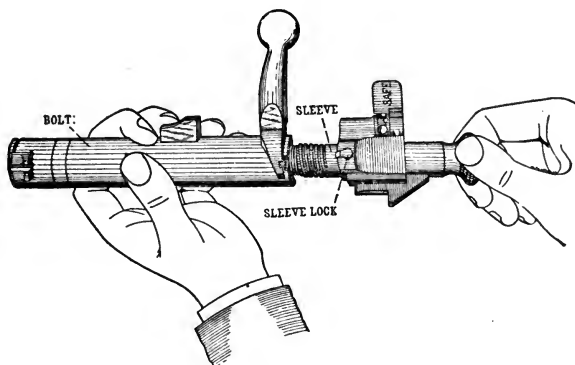

FIG. 78.

turn the extractor collar until its lug is on a line with the safety lug on the bolt; take the extractor in the right hand and insert the lug on the collar in the undercut in the extractor by pushing the extractor to the rear until its tongue comes in contact with the rim on the face of

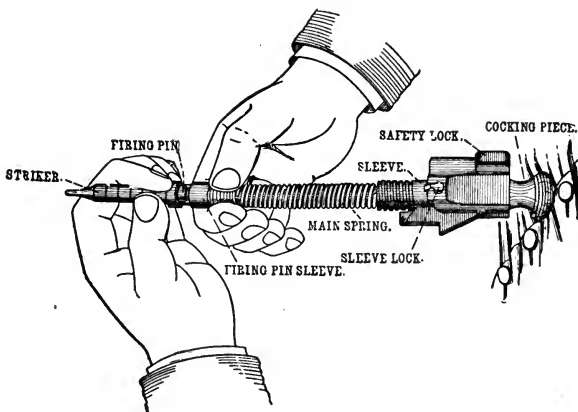

FIG. 79.

the bolt (a slight pressure with the left thumb on the top of the rear part of the extractor assists in this operation); turn the extractor to the right until it is over the right lug; take the bolt in the right hand

and press the hook of the extractor (Fig. 81) against the butt plate or some rigid object, until the tongue on the extractor enters its groove in the bolt.

With the safety lock turned down to the left to permit the firing pin to enter the sleeve as far as possible, assemble the sleeve and firing

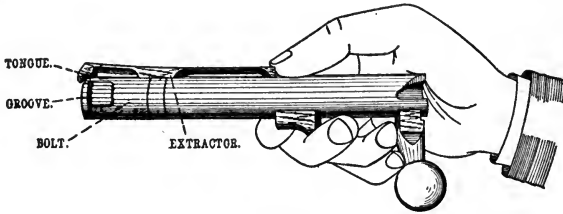

FIG. 80.

pin; place the cocking piece against the body and put on mainspring, firing-pin sleeve, and striker (Fig. 79); hold the cocking piece between the thumb and forefinger of the left hand, and by pressing the striker point against some substance, not hard enough to injure it, force the cocking piece back until the safety lock can be turned to the vertical position with the right hand; insert the firing pin in the bolt and screw

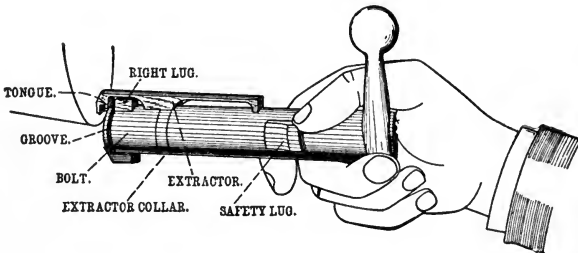

FIG. 81.

up the sleeve (by turning it to the right) until the sleeve lock enters its notch on the bolt.

See that the cut off is at the center notch; hold the piece under the floor plate with the fingers of the left hand, the thumb extending over the left side of the receiver; take bolt in right hand with safety lock in a vertical position and safety lug up; press rear end of follower down with the left thumb and push bolt into the receiver; lower bolt handle; turn safety lock and cut off down to the left with right hand.

To Dismount Magazine Mechanism, with the bullet end of a cartridge press on the floor plate catch (through the hole in the floor plate), at

the same time drawing the bullet to the rear; this releases the floor plate.

Raise the rear end of the first limb of the magazine spring high enough to clear the lug on the floor plate and draw it out of its mortise; proceed in the same manner to remove the follower.

To assemble magazine spring and follower to floor plate, reverse operation of dismounting.

Insert the follower and magazine spring in the magazine, place the tenon on the front end of the floor plate in its recess in the magazine, then place the lug on the rear end of the floor plate in its slot in the guard, and press the rear end of the floor plate forward and inward at the same time, forcing the floor plate into its seat in the guard.

CLEANING AND CARE

As the bore of the rifle is manufactured with great care in order that a high degree of accuracy may be obtained, it should be attentively cared for. The residuum from smokeless powder tends to corrode the bore and should therefore be removed as soon after firing as practicable. The following method has been practiced with good results: Using the cleaning rod and small patches of cloth (preferably canton flannel), clean the bore thoroughly with the patches soaked in a saturated solution of soda and water. Then thoroughly dry the bore and remove the soda solution by the use of dry patches, and finally oil the bore with patches soaked in cosmic oil. Twenty-four hours after this first cleaning, the bore should be again cleaned as described above, as it has been found that the powder gases are probably forced into the texture of the steel and will, if the second cleaning is not resorted to, cause rusting no matter how thoroughly the bore may have been cleaned at first. If, however, a cleaning rod is not at hand, the barrel should be cleaned as thoroughly as possible by means of the thong brush and rags, and oiled as explained above.

To clean or oil the bore with rags, the thong brush is unscrewed, the rag placed in the rag slot of the thong tip and drawn from the muzzle toward the breech.

As neither the ramrod nor jointed cleaning rod is issued with this rifle, the brass cleaning rod should be carried into the field whenever practicable.

If gas escapes at the base of the cartridge, it will probably enter the well of the bolt through the striker hole. In this case the bolt

mechanism must be dismantled and the parts and well of the bolt thoroughly cleaned.

Before assembling the bolt mechanism, the firing pin, the barrel of the sleeve, the body of the striker, the well of bolt, and all cams should be lightly oiled.

Many of the parts can generally be cleaned with dry rags. All parts after cleaning should be wiped with an oiled rag.

The best method of applying oil is to rub with a piece of cotton cloth upon which a few drops of oil have been placed, thereby avoiding the use of an unnecessary amount of oil. This method will, even in the absence of the oiler, serve for the cams and bearings, which should be kept continually oiled.

Any part that may appear to move hard can generally be freed by the use of a little oil. Sperm oil only should be used for lubricating metallic bearing and contact surfaces.

For the chamber and bore, only cosmoline or cosmic should be used. This should also be applied to all metallic surfaces, to prevent rusting when arms are stored or when not used for an appreciable length of time.

The stock and hand guard may be coated with raw linseed oil and polished by rubbing with the hand.

GUN SLING

The gun sling, model of 1907, is made of four parts, the long strap, the short strap and two keepers. To assemble it, the plain end of the long strap is passed through the larger keeper, then through the metal loop of the short strap, passing from the undressed to the dressed side of the latter, then back through the larger keeper, forming the arm loop, dressed side out. The same end is then passed through the smaller keeper, through the lower band-sling swivel—called the upper sling swivel, from the butt toward the muzzle, and back through the smaller keeper, the arm loop being completed by engaging the claw of the long strap in the proper holes in the other end of same. The size of the arm loop is adjusted to suit the individual who is to fire the piece, the loop being drawn through the upper swivel until the claw comes well up toward the upper swivel. The claw end of the short strap is then passed through the lower swivel from muzzle to butt and brought up and engaged in the proper holes in the long strap, drawing the sling taut. This gives the parade position of the sling. To adjust it for firing or

carrying, the claw of the short strap is disengaged and re-engaged in the proper holes of the short strap, no change being necessary in the adjustment of the arm loop.

AMMUNITION

Ammunition for this arm is assembled in clips to facilitate loading. Ammunition issued is as follows:

The Caliber .30 Ball Cartridge is shown in Fig. 82. It consists of a case, primer, charge of smokeless powder, and bullet. The case is of cartridge brass. It has a conical body joined by a sharper cone, called the shoulder, to the neck, which is the seat of the bullet and very nearly cylindrical. The front end of the case is called the mouth and the rear



FIG. 82.

end the head. The latter is grooved to provide for extraction of the cartridge from the chamber of the rifle, and is provided with a primer pocket and vent. The initials of the place of manufacture, the number of the month, and the year of its fabrication are stamped on the head of the case.

The primer consists of the cup, percussion composition, disc of shellaced paper, and anvil. The cup is of gilding metal and contains .48 grain of non-fulminate composition composed of tersulphide of antimony, potassium chlorate, sulphur and ground glass. A disc of shellaced paper covers the composition to protect it from moisture and to prevent electrolytic action. The anvil is of brass and is assembled over the paper. After the primer is assembled to the case a drop of shellac is placed on the head of the primer to make the joint waterproof.

The charge is of pyrocellulose composition very similar to the powders used as propelling charges in seacoast guns. The grains are cylindrical, single, perforated and graphited. The normal charge weighs from 48 to 50 grains, varying with the lot of powder used.

The bullet has a core of lead and tin composition inclosed in a jacket of cupro nickel. It weighs 150 grains, and the point is much

sharper and offers less resistance to the air than that of any previous model. The sides of the bullet are smooth and its base flat. The portion inclosed in the neck of the case is covered with a lubricant of japan, wax and graphite. A pressure of at least 75 pounds is required to seat the bullet in the case, resulting in the case being waterproof.

The standard muzzle velocity of this ammunition in the rifle is 2,700 feet per second. The instrumental velocity measured at 78 feet from the muzzle is 2,640 feet per second, with an allowed mean variation of 20 feet per second on either side of the standard. The cartridge complete weighs 392 grains, its weight varying slightly with variation in the weight of the powder charge. Five cartridges are packed in a clip, a drawing of which is shown in Fig. 83. The clip for dummy

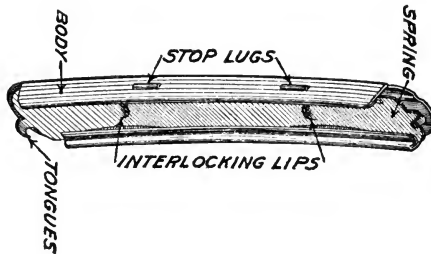

FIG. 83.

cartridges has square instead of round ends and the tongues on the spring are omitted.

Sixty ball cartridges in twelve clips are packed in a bandoleer which is made of olive drab cloth and contains six pockets, each holding two clips. It weighs, with cartridges, 3.88 pounds. Each bandoleer is stamped with the number and kind of cartridges it contains, the place of manufacture, the instrumental velocity and the date of loading.

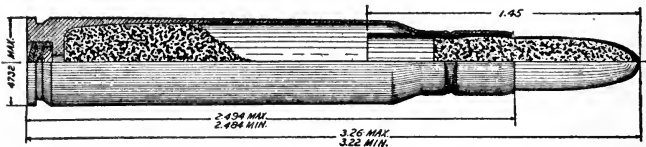

FIG. 84.

The Blank Cartridge is shown in Fig. 84. It differs from the ball cartridge in the charge of powder, in the bullet, and in the fact that the case is tinned. The bullet is of paper, hollow, and contains a charge of

5 grains of "E.C." smokeless powder, which insures the breaking up of the bullet on leaving the bore. This charge is retained in the bullet by a drop of shellac. A coating of paraffin on the outside of the bullet prevents the absorption of moisture by the paper. The propelling charge is 10 grains of "E.C." powder. The cartridge is made 0.1 inch shorter than the ball cartridge. This is a measure of protection against the accidental assembling by the machine of a ball cartridge in a clip of blank ones.

The Dummy Cartridge is shown in Fig. 85. It is tinned and provided with six longitudinal corrugations, also three circular holes in the

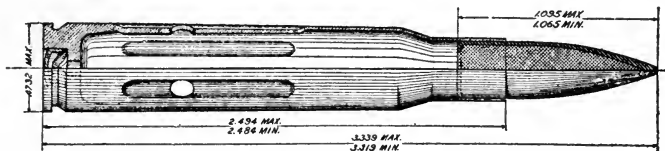

FIG. 85.

corrugated portion. The tinning, corrugations, and holes afford unmistakable means for distinguishing the dummy from the ball cartridge, both by sight and touch. The bullet is the same as in the ball cartridge. The dummy primer has cup and anvil, but no percussion composition.

The Guard Cartridge is shown in Fig. 86. It differs from the ball cartridge in the charge of powder and in the fact that second-class

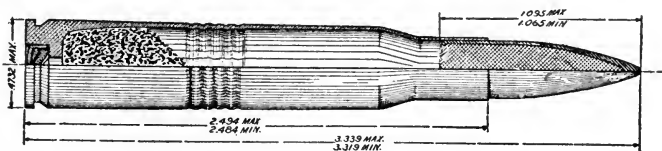

FIG. 86.

bullets having slight imperfections are used. Five cannelures encircle the body of the case at about the middle, affording means for distinguishing it from the ball cartridge by either sight or touch.

The charge consists of about 9.1 grains bullseye powder; or 16.7 grains DuPont Rifle Smokeless No. 1, giving a muzzle velocity of 1,200 feet per second. This cartridge gives good results at 100 yards and has sufficient accuracy for use at 150 and 200 yards. The range of 100 yards requires a sight elevation of 450 yards, and ranges of 200 and 300 yards require elevations of 650 and 850 yards, respectively.

CHAPTER XIII

POINTS FOR COAST ARTILLERISTS

It is the object of these points to facilitate the study of the Drill Regulations. They are given merely as suggestions of methods for obtaining practical results as well as uniformity of commands during drill or action.

BATTLE COMMANDERS

The general principles governing battle-command combat involve the best means to pursue in order to destroy the enemy with the greatest dispatch and the least confusion on the one hand, and economy of ammunition and the preservation of the life of the guns by the prevention of useless fire, on the other.

No attempt should be made to develop a regular routine of drill. Each battle commander should conduct his drills according to the development of the particular problem in hand, and rules as to the procedure of particular batteries or fire commands should be applied with reference to the development of this problem.

"General defense plans" authorized for use as suitable commands during battle-command drill or action, are undoubtedly effective, since they lead to a proper general understanding of fire control as it is to be applied under normal conditions of combat. They unquestionably tend to perfect organization among the several tactical units, but they are not intended to be accepted as the only means through which a battle command may be fought, as they are necessarily theoretical in that their practical utility has never been demonstrated in action.

It should be borne in mind that the "normal" time for an attack from the sea would be at night or in rainy or misty weather when great difficulty is to be anticipated in locating particular ships of a column or line, as, for instance, "the first and last battle ship of a column" or "the ships in order in line from right to left."

Battle commanders should study to maintain control of their commands even after they have passed the several subdivisions into

the hands of fire or battery commanders. Experience with one of the most important battle commands on the Atlantic seaboard under assimilated service conditions indicates that the ideal battle command drill is that in which the several subdivisions are not committed to any general line of action but are retained under the personal control of the battle commander until the action has developed to a point where the battle commander may safely eliminate certain targets or ships from the general action by their assignment to particular batteries or units.

Should the topographical or marine features of a harbor prevent the assailants from attacking in any formation but that of column, the concentration of fire on the leading ship by say 75 per cent. of the primary armament (keeping the others in reserve) by the command, "Fire at ships in order in column," meaning, as it does, that the fire is to be concentrated on the leading ship until it is out of action and then changed to the next and so on, would seem to be logical, thoroughly simple and practical. The moral effect of the quick destruction of the leading ship would be severe on the personnel of the remaining vessels and inspiring to those ashore. Again, the destruction of the first ship would place her directly in the path of the others and possibly block their further approach.

At this point the battle commander's action would be guided by his newly acquired knowledge of the destructiveness of his armament. There are no data available on which to found an absolutely sure estimate as to the number of guns that can with certainty be counted on to injure the fighting efficiency of a ship or sink her. Accordingly, if the battle commander found at this stage of the combat that two batteries would have been sufficient to destroy the ship with dispatch, the moment for the distribution of the heretofore concentrated stream of fire would be at hand, and the second or decisive stage of the action developed.

Should the fleet press the action, the fort or forts should remain in action under the direction of the battle commander in accordance with the principles already enunciated, namely that he should keep under his personal control all the elements of his command until the action has developed to the stage where he can safely assign ships or subdivisions of the fleet to fire or battery commanders, and thus, as before explained, eliminate them from the general action.

On the other hand, should the military features of the harbor permit the approach of the assailants in line or line of columns, a subdivision of the fleet should receive concentrated action of say 50 per cent. of the primary armament in the outer defense zone. The destruction of any

of the ships fired upon at the longer ranges would have the same encouraging result on the defenders and a demoralizing effect on the assailants. From this stage the action would follow the same general lines as are laid down above.

In order that the battle commander may accomplish the tactical changes indicated, it is essential that the artillery discipline and artillery drill be, through continued practice, so perfected that in actual combat the excitement will not disturb the system of command nor cause any unit to be carried away to the extent that it would commence independent action without waiting orders from the battle commander.

To attain such a state of excellence in artillery drill it is most important that the larger elements of the command, that is, fire and battle commands, be not only frequently but habitually drilled and exercised.

BATTLE-COMMAND DRILL

Battle commanders are liable to endeavor to work their commands too fast during drill. They should constantly keep the fact in mind that they have under their control a military machine of vast dimensions, and in order that it may run smoothly each part must necessarily work without needless pressure and in perfect unison. Undue haste should be studiously avoided.

Floods of orders tend to clog the parts rather than facilitate their action. Absolute silence in all stations should be insisted upon. Smoking should be strictly prohibited.

For practice in deliberation as well as brevity, battle commanders should personally dictate to their recorders all orders they desire to have transmitted. They should constantly endeavor to word their communications with such brevity of language as to make their transcription comparatively easy.

All general orders to fire commanders should be given as soon after the stations are opened as practicable.

The words "right," "left," "in front of," or "in back of," should not be used in describing targets, etc. The words, "north," "south," "east," and "west," can always be used with ease and by their use the likelihood of error is greatly reduced.

Unless there is some special reason for so doing, battle commanders should not specify the kind of projectile to be used, as this is a proper function of the battery commanders.

As soon as reports have been received, such as: "F. C. Two, In order,"

"F. C. Five, In order," etc., the battle commander may begin the drill by designating the target or targets; or if at night by directing fire and mine commanders to search certain areas with their searchlights and report any suspicious vessels to him, using his own searchlight as a roving light.

The following scheme for the drill of a battle command consisting of four gun fire-commands, one mortar fire-command and one mine command is given as an example and may be modified in accordance with the strength of armament. It calls for Fire Commander's Action in one Fire Command; Restricted Fire in one Fire Command; Unrestricted Fire in one Fire Command; Battery Commander's Action in one Fire Command; One Fire Command in Reserve, and Mine Command in Action.

"F. C. One; Target in Battle Beam; Fire Commander's Action."

"F. C. Two; Prepare for Action as Reserve."

"F. C. Three; Target in Number Three Beam; Each Battery Fire Five Shots at Two-Minute Interval."

"F. C. Four; * Fire at Target in Battle Beam when it arrives in seventh zone."

"F. C. Five; † When target representing protected cruiser is identified begin Battery Commander's Action."

"Mine C. Protect Mine Field."

By interchanging the above commands a very complete battle command drill can be executed.

FIRE COMMANDERS

The general principles and rules enumerated in connection with battle commanders are applicable in every way to the drill or action of fire commands, and should be studied with a view to their application and development.

Fire commanders should remember that at forts where the horizontal-base system is generally used apparent delay is frequently caused in identifying targets by the secondary observer, whose position at the other end of a long base line often makes it much more difficult for him to find the target than the primary observer and gun pointer. In order to overcome this delay, at forts where the vertical-base system can also

* F.C. Four, assumed to be mortars.

† F.C. Five, assumed to be 10-inch batteries.

be used, fire commanders can facilitate action by issuing a general order directing that as soon as the primary observer has found the target, report be sent to him ("Dix, Target"*) and the vertical-base system used until such time as secondary locates the target.

The establishment of uniformity in commands during fire-command drill or action is necessary, as it simplifies communications and instantly gives subordinates unmistakable information as to the wishes of the fire commander.

The following commands, covering the general drill of fire commands, are authorized. They are particularly recommended on account of their studied brevity and simplicity. Fire commanders should insist that officers and men charged with the transmission of communications use the exact words of the text during all drills and exercises.

In case recorders are not available at battery primary stations, or battery commander's stations, should the fire commander desire that a message or order to a battery commander be written down upon its receipt, he should first send the following:

"Dix (or, All Batteries), Prepare to write message."

When suitable preparation has been made, announcement of readiness should be made to the F. C., as follows:

"Dix, Ready."

As soon as the batteries of a fire-command are in order, or need repairs that cannot be made immediately, the following message should be sent to F. C. by each:

"Dix, In order," or "Dix, T. I. Bell not ringing," or "Dix, Telephone to guns out of order," etc., etc.

In case report of difficulty is received the F. C. should direct the electrician sergeant detailed to his command to make such repairs as may be needed.

The next order in sequence would be:

"All Batteries (or, Dix), Target; Steamer coming in, one funnel, white band, main ship channel, west of Norton's Point Light."

When target has been identified it should be followed and F. C. notified as follows:

"Dix, Target."

In case the target cannot be found after suitable effort F. C. is notified as follows:

"Dix, Describe."

In this case the F. C. may send further particulars of description.

* The word "Dix" is used to designate the name of a battery.

In case the F. C. desires a battery to take another target, the following order is sent:

“Dix, Change Target. Target; Tug, towing two barges, coming in, range about 10,000 yards.”

In case a battery, after having identified a target, tracks same until it is out of range, the following message is sent to F. C.

“Dix, Target out of range.”

To indicate that a vessel is no longer to be fired upon, or is assumed to have been destroyed, the following message is sent:

“Target out of action.”

To place the control of a battery in the hands of the battery commander, the following command is proper: “Dix (or, All Batteries), Battery Commander's Action.”

RESTRICTED FIRE

To restrict the fire during a fire command drill or action, the following commands are proper:

“Dix (or, All Batteries), Fire one shot: Commence Firing.” (This restricts to one shot from one gun.)

“Dix (or, All Batteries), Fire one (or more) rounds; Commence Firing.” (A round consists of one shot from each gun of a battery.)

“Dix (or, All Batteries), Fire at two-minute interval; Commence Firing.” (This means that one round is to be fired every two minutes by the battery or batteries designated, until “Cease Firing” is given.)

“Dix (or, All Batteries), Fire five shots, at two (three, etc.) minute interval; Commence Firing.”

“Dix (or, All Batteries), Fire five rounds when in range (or at 9,000 yards).”

“Dix (or, All Batteries), Fire at Salvo Point No. 1 (or No. 2, etc.). (This requires the battery commander (or all battery commanders) to fire a round at each target or vessel of a fleet as they pass the designated salvo point.

UNRESTRICTED FIRE

The following commands for unrestricted fire are proper:

“Dix (or, All Batteries), Fire at ships in order in column; Commence Firing.” (This requires the battery commander—or all battery commanders—to concentrate fire on the first vessel in the column until it is out of action and then to change to the second vessel and so on.)

“Dix (or, All Batteries), Fire at ships in order in line from right to left; Commence Firing.” (This requires the battery commander—or all battery commanders—to concentrate fire on the vessel on the right of the enemy’s line, until it is out of action and then change to the next and so on.)

“Dix (or, All Batteries), Target under fire; Commence Firing.” (This requires the concentration of fire on a target or vessel already being fired upon by another battery or batteries.)

“Dix (or, All Batteries), Fire at target; Commence Firing.”

At the conclusion of all series of shots fired, battery commanders should report as follows:

“Dix, Series completed.”

In restricted fire, in case “cease firing” is given before the number of shots specified have been fired, battery commanders after stopping the fire should report:

“Dix (so many) shots fired.”

In case the command, “Commence Firing,” is again given, battery commanders should proceed to complete the series.

For the purpose of finding the comparative accuracy of ranges, fire commanders may send the following order:

“All batteries: Send range of target to F. C. at next bell.”

In case a party of the enemy is discovered to have gained access to a fort unobserved, and provided the artillery personnel are not actually engaged in action or the chances of artillery action are remote, fire commanders would send the following order:

“Prepare for land defense.”

At this command all men of the designated unit or units take their small arms and independently rush to their positions previously designated and prepare for land defense.

During artillery practice for batteries the fire commander is responsible to the district commander for the efficiency of his batteries at practice. His active duties in connection with battery practice are limited to the preparations necessary for the highest efficiency, and to the observance of safety precautions on the day of the practice.

When a battery commander desires to fire he requests authority from the fire commander to begin; the latter gives the authority if the range is safe, and the battery commander gives the command “Commence Firing” as soon thereafter as practicable.

If an interruption of the fire is necessary the fire commander commands “Cease Firing.” Firing is resumed after an interruption in the same manner as the original firing was begun.

The necessary precautions for safety are laid down in the drill regulations. The additional precautions to be observed during night practice are as follows:

a. The dates of the practice shall be published so as to reach without fail shipping and fishing interests.

b. The field of fire shall be patrolled before dark with a view of determining whether or not vessels are anchored therein and of warning approaching vessels.

c. Signal boats shall be located so as to observe any vessel approaching the range during the firing and to signal the battery firing by rocket or other means.

d. At least one searchlight shall be held on the towing tug and one on the target during the firing.

e. The day and hour of firing shall be selected with a view to having the practice at an hour when there is least likelihood of a vessel crossing the range.

If in the opinion of the fire commander the deflection error of any mortar shot is such as to imperil the safety of the field of fire, he commands "Cease Firing" and investigates the cause of error, indorsing results of his investigations on the report of the practice.

When troops are ordered for artillery practice away from their home stations they shall be accompanied by the fire commander of the fire command to which they belong. This fire commander shall require the troops of his command to be drilled carefully before the practice begins at the pieces with which such practice is to be held. He shall order and supervise subcaliber practice with each piece before service takes place. He shall assure himself before the practice begins that each gun and fire-control section is instructed sufficiently in the use of the equipment furnished to derive the fullest possible benefit from the practice.

The following rules are suggested to be followed by safety officers in charge of the target practice:

Vessels short of first point of fall should be considered in dangerous position if within 10 degrees from either side of line of fire measured from gun.

For all rounds where ricochet is expected, vessels beyond first point of fall should be considered in dangerous position if within 45 degrees from line of fire to the right, or if within $22\frac{1}{2}$ degrees from line of fire to the left, measured in both cases from first point of fall of projectile.

Any angle of elevation under 9 degrees may be expected to give a ricochet.

For angles of elevation less than 9 degrees the total range, including ricochets, may be expected to be at least as great as that given by 9 degrees, and if near 9 degrees probably greater.

Based upon the above assumptions, the following have been determined to be the required clear angles to the right, measured from the gun, for vessels, beyond the point of first fall of projectile, but within ricochet range. These assume firings to be with high-power guns and full charges:

When first point of fall is about 1,500 yards from gun the clear angle from the gun should be about 40 degrees. When first point of fall is about 4,000 yards the clear angle should be about 30 degrees.

Where first point of fall is about 8,000 yards the clear angle should be about 6 degrees for an 8-inch gun or less, about 11 degrees for a 10-inch gun, and about 17 degrees for a 12-inch gun.

The clear angle to the left should in all cases be about one-half the corresponding one to the right.

If the conditions of water are such that the targets could be towed at ranges of 11,000 yards there would apparently be no danger from ricochet at that range.

SEARCHLIGHT COMMANDS

At night the following searchlight commands are prescribed in connection with battle, fire and mine lights:

To put occulted light into action the command would be:

“No. 1, In action.”

To take a light out of action:

“Battle (or, No. 1, etc.), Out.”

To have a designated light search its area, or any sector of its area:

“Battle (or, No. 1, etc.), Search right (or middle or left).”

For a light to search its entire area:

“Battle (or, No. 1, etc.), Search.”

If the light is covering a target the command is “Uncover and Search.”

To have a light follow a target found in its area:

“Mine (or Battle, etc.), Follow.”

To have a light cover a target already illuminated by another light:

“Battle, Cover No. 1,” or, “Mine, Cover Battle.”

To change a light from one target to another:

“No. 1, Uncover and cover Battle.”

To have a light uncover and search:

"No. 4 (or, Battle, etc.), Uncover and Search."

The command "Elevate" means for the controller operator to raise the beam 30 degrees from the horizontal.

The command "Focus" indicates to the operator at the light that the beam requires adjusting.

The command "Spread" means to diverge the beam.

The command "Contract" means to contract the beam.

Other commands used are: "Raise," "Lower," "Raise slightly," "Lower Slightly," "Right," "Left," "Halt."

To indicate a target to a battery at night, the command would be:

"Dix (or, All batteries), Target in Battle (or, No. 4, or Mine) beam."

COMMUNICATION OFFICER

No service in the Coast Artillery is more important than the accurate transmission and receipt of artillery communications.

Communication officers should point out to their assistants the importance of the duty which rests upon them. They should personally instruct their subordinates in the proper method of transmitting, receiving and retransmitting orders and communications.

They should request, through their respective superiors, that men detailed to this important service at the several stations in the chain of communication be selected with reference to the following rules, viz.:

1. General intelligence.
2. Knowledge of artillery terms and orders.
3. Natural coolness and ability to remember a message long enough to transmit it properly.
4. Experience in the use of the telephone.
5. Ability to speak in a modulated but distinct tone of voice.
6. Familiarity with the English language sufficient to enable the proper pronunciation of words.
7. Complete absence of any impediment of speech or foreign accent.

Communication officers of fire commands are charged with the inspection of the equipment of the station and the proper adjustment of all instruments therein.

When the station is in readiness, the communication officer reports to the commander: "Sir, Station in order."

He receives all reports from batteries and transmits them to the fire commander as received. After all batteries in the command

have reported and upon intimation from the fire commander, he reports to the battle commander, as follows:

"F. C. 2, In order." (Or reports defects that cannot be repaired.)

He communicates all orders from the fire commander to the telephone operators on the lines over which the message is to be transmitted and receives all messages sent over such lines.

When a communication is to one particular battery he can facilitate its prompt and accurate delivery by personally transmitting it direct by the use of the cut-off jack-set.

When telephone operators have transmitted their messages word for word to the batteries to which their lines are connected and know they have been received correctly, they report to the communication officer, as follows:

"Dix, Message delivered." "Richmond, Message delivered," etc.

The expression "O K" is used by a communication officer to announce that a communication transmitted to him is understood. To announce that he has concluded a message the letter "X" may be used. For example, the communication officer calls the operators in communication with Batteries Dix and Richmond; the operators answer, "Dix," "Richmond." The communication officer then says:

"Target, Side-wheel steamboat coming in. X."

The letter "X" in this instance implies "end of message." It has been found that where telephone operators are in booths they are apt to lose time in delivering messages by not knowing just when the message is complete. Accordingly the use of "X" at the end of each message delivered to them signifies the end.

At the end of the drill or exercise the communication officer, upon intimation of the fire commander, sends the following message: "All Batteries, Close Stations."

While the above points are for the use of communication officers detailed to fire commands, they are applicable to those at battle command stations as well.

BATTERY COMMANDERS

To battery commanders the words of the great artillerist, Napoleon, apply with peculiar emphasis: "There are no poor regiments, there are some poor colonels." In other words, a good battery commander will always have an efficient battery.

Battery commanders should strive to obtain such a standard of

discipline that the battery would be able to conduct subcaliber or service target practice in the same orderly manner as they would the ordinary routine drill. That is, the drills should approach the conditions of actual service to such a realistic extent that the difference would not be apparent to the enlisted personnel.

The battery commander is responsible for the excellence of the gunnery of his command. This excellence is judged by the accuracy and rapidity with which the battery can hit the target. In this, every person who actually participates in the firing has a personal liability; the battery commander, the range officer, the emplacement officers, each individual member of the fire-control section and the gun detachments. Only by the united efforts of all persons concerned, working in complete harmony with each other, can the best results be expected. A failure in the slightest detail on the part of any one participating may materially reduce the accuracy and rapidity of hitting, and thus defeat the efforts of the others to attain the highest possible excellence. Success in practice, if properly carried out, under as nearly as possible service conditions, is by far the best evidence of the state of training of a company.

Battery commanders are responsible for the team work of their respective companies, without which it is practically impossible to obtain results. They should employ a system of checks in order that errors may be located.

By personal inspections they should know positively that the military machine over which they exercise command is in proper order and ready at all times for immediate action.

Before artillery practice battery commanders should satisfy themselves that all the material for the practice is ready for service. In this connection the instructions contained in Coast Artillery memorandum No. 6, W. D. 1909, have been copied without material alterations, as follows:

“. . . It is believed that target practice is a problem capable of definite solution, within the limits of accuracy allowed by the gun and the ammunition; but the solution is arrived at only when all the variants or sources of error, viz., ununiformity in material and methods, are eliminated.”

The final objective of target practice is to develop ability to *hit*. To hit, or to throw the projectile accurately in practice or in service, we must have for successive shots, uniformity in the several factors that enter into the problem of gun fire, viz.:

(1) Gun and carriage (action of).

- (2) Projectile.
- (3) Powder.
- (4) Position-finding service (operation of).
- (5) Personnel (work of).

The target-practice problem, then, reduces itself to an elimination of the variants affecting these factors.

1. **Gun and Carriage.**—Careful inspection and adjustment will be made of the following:

(a) *Base Rings to be Tested for Level.*—Place a clinometer on its rest in the bore of the gun. Traverse the gun through the field of fire, recording variations in level of the base ring as indicated by the clinometer for azimuths varying by 5° . Calculate, for mid-range, the range corrections which should be applied for variations in level, and combine these corrections with the corrections for gun displacement; modify the figures painted on the base ring or on the steps of the loading platform so that they will represent the total correction due to gun displacement and variations in level.

In using the clinometer and its rest the bore of the gun should be thoroughly cleaned and any burrs on the ends of the lands should be removed to facilitate the insertion of the adaptors. The adjustment of the clinometer itself should be tested. In giving the gun elevation the last movement of the elevating wheel should always be in the same direction. It will be found that the direction of this motion should be against preponderance—that is, in the direction of depression.

(b) *Sight Standards.*—Place bore sights in the gun, and with the telescopic sight on its standard, point the gun so that the line of collimation of the sight and the line through the axis of the bore intersect at some well-defined object at or beyond mid-range. For 8-inch, 10-inch, and 12-inch guns this adjustment should be made on an object at about 6,000 yards from the gun. The sight itself should be in adjustment and the vertical wire should be in the center of the deflection scale.

(c) *Quadrant Elevation Scales to be tested for Adjustment by the Clinometer at 0, 5, and 10 degrees.*—The elevating pinion shaft projecting through the chassis rail carries one or two disks, depending upon the model of the carriage. There are two scales on the disk (or disks), one the quadrant elevation scale, the other the range scale. The quadrant elevation scale should be tested by the clinometer and the results compared with the calibration record of the battery, bearing in mind that the index for this scale may have been adjusted as a result of the calibration firing so as not to give the actual quadrant elevation. In the graduation of the range scale allowance has been made for the

curvature of the earth and the height of the gun trunnions. The relation between the graduations of the range scale and the quadrant elevation scale is unalterable. This should be checked by the battery commander, and he should also verify the computations upon which these graduations are based and the accuracy of graduations themselves.

Wear of the elevating gearing will result in inaccuracies at certain parts of the quadrant-elevation scale. The index should be adjusted so as to be correct for mid-range or for the approximate range at which trial and record shots will be fired. In making this adjustment, as in the case of testing for base-ring level, the last movement of the elevating wheel should always be in the same direction, viz., in the direction of depression. It is to be noted that this corresponds to a target coming toward the battery, which will be in the condition to be expected in the important part of any actual engagement. With the target going away from the battery it will be found impracticable to have the last motion in laying the gun to be that of depression, because the gun must be laid continuously. If all adjustments involving the elevating mechanism are made with the last motion that of depression, the carriage will be in the best adjustment for firing at a target approaching the battery. It is well, therefore, at target practice, to arrange that the target shall *approach the battery* during the firing of the record shots.

(d) *Elevating Mechanism*.—Examine the hand-wheel shaft and bearings, all racks and pinions, elevating-rack slide and its bearing; clean thoroughly and oil all bearing parts. Oil that has accumulated, sand and grit should be removed. The elevating mechanism should work easily and smoothly for both elevation and depression.

(e) *Friction Device of Elevating Mechanism (if this device is not in proper adjustment it should be removed by an ordnance machinist and examined)*.—Examine and adjust the friction clutch. The gun jumps when it is fired. It may be said that correction for jump is included in correction made as a result of trial shots; this correction, however, will not apply unless the jump is *uniform*. The proper adjustment of the friction clutch will tend to make the amount of the jump *uniform* for successive shots. If the gun were in a vise there would be no jump. We can conceive that if the friction device were so tight as to allow no movement in the elevating device when the gun is fired, and if this device as a whole were rigid, there would be no jump. The rigidity of the mount in respect to elevation and depression is, therefore, dependent to a degree on the friction surfaces of the elevating gearing. Jump should decrease with increased friction.

In making the adjustment, *care must be taken not to cause the friction surfaces to bear too tight*, otherwise the gearing will be endangered.

The main object is to secure *uniformity* in the action of this device. The bearings of the elevating shaft should be kept clean and properly lubricated. The friction surfaces should be kept clean, smooth, and dry. They should not under any circumstances be oiled. Frequently at drill elevate or depress to the limit and turn the friction surfaces on each other. According to the Ordnance Department pamphlet the elevating arm for 12-inch carriages, model of 1896, should be held by friction surfaces only so tight as will prevent the elevating arm sliding down.

(f) *Traversing Mechanism*.—Examine the crank shaft and the bearings, all racks and pinions; clean thoroughly and oil all bearing parts of the traversing mechanism. Clean traversing rollers and their paths, and oil all bearing surfaces as often as necessary. Different sections of the dust guards should be removed each month of the outdoor season.

(g) *Recoil Cylinders (to be cleaned and filled, periodically, as required by Ordnance Department pamphlet for the carriage considered)*.—The follower should not be so tight as to cause undue friction, nor so loose as to allow leakage. (See C. A. D. R. instructions for packing stuffing boxes and adjusting followers.) The adjustment of glands and followers must be uniform for the two cylinders. Examine the cylinders just before firing to see that they are full.

(h) *Recoil and Counter-Recoil System*.—Clean crossheads and guides, recoil rollers, upper and lower roller paths, and lubricate all bearings. For firing; rollers, paths and piston rods should be bright and *slightly* lubricated with thin oil. Keep grease cups full and so adjusted that they function properly at all times. The gun should be tripped frequently and time of going into battery recorded with a view to observing whether or not the action of the carriage is uniform. Equalizing pipes must be clean and free from “settlings” or solid matter, so as to allow a free circulation of oil. Throttling valves should be properly set by reference to records as to action of the carriage with settings at previous times, or as judgment and experience may dictate. The setting of the valve depends principally upon the temperature of the oil in the cylinders at the time of firing. The records of previous firings, therefore, should show the setting of the valve, the amount of recoil, temperature of the oil in the cylinders, and the time elapsing between successive shots. It should be noted whether or not with the same setting the recoil increases with shots fired at short intervals.

(i) *Breechblocks and Obturators*.—Once a month breechblocks should be dismantled and all parts carefully cleaned. Cable and breech contacts will be freed of all grease and dirt. Dummy pressure plugs will be unscrewed occasionally and threads of pressure-plug recesses examined. Prior to practice cylinders for pressure plugs will be measured, and gun commanders will be instructed in the preparation of the plugs and their use during practice.

Adjust the obturator so that a slight effort will be required to turn the mushroom head. See that the gas-check pad is serviceable.

(j) *Firing Attachments*.—Examine firing attachment. Take it apart occasionally and clean it; oil its bearing parts so that it functions easily. Men should be instructed to insert the primer by pushing on the body of the primer and *not* on the button wire. The slide must be lowered completely down. If a primer fails, its button wire should be bent back over the body of the primer, so that the primer will not, by mistake, be inserted again during the firing. In bending the wire back care should be taken to put as little strain as possible on the button wire in the direction of the axis of the primer body, to avoid the possibility of igniting friction composition in the primer.

See that the safety lanyard is in working order, if this is used; and test all lanyards to see that they are *strong* and *serviceable*.

(k) *Azimuth Subscales (Mortars)*.—Check up the data upon which orientation of mortars is based and verify the setting of azimuth subscales before practice. (See Method of orienting, in chapter X, also in D. R.) Having once verified the orientation data, setting of azimuth subscales can be readily checked by a transit on the parapet or in rear of the pit. By means of bore sights direct the vertical wire of the transit on the axis of the bore and, if necessary, move the subscale so that it indicates the correct azimuth reading. The subscale should be doweled in position when correctly set. Station for the transit should be located at a point near the battery from which all mortars are visible and correct data for this point determined. The orientation of the B. C. instrument and instruments in P. F. system must agree with that of the mortars. An azimuth instrument may be used for this adjustment if a transit is not available.

(l) *Quadrants (Mortars)*.—Test and adjust all quadrants. Expansion and contraction due to sun and shade make it difficult to keep quadrants in adjustment. They should be tested with the clinometer as short a time before firing as possible. As the clinometer does not read to 45° and the quadrant does not read below 45° , an old-style quadrant may be placed on the surfaces prepared for it at the breech

and its zero determined by the clinometer. Having adjusted this quadrant the attached quadrant should be compared with it at elevations differing by 5° between 45° and 70° .

(m) Adjust sights to remove parallax and for clear definition. (See Adjustment of telescopes.)

(n) *Ammunition Trucks* (See Fig. 87).—Oil axles. Have trays clean and smooth. Trucks for disappearing carriages should be



FIG. 87.—Emplacement Booth, Equipment, and Ammunition Truck.

adjusted approximately for proper height of breech in loading position just before practice. Tray-elevating and depressing mechanism must be lubricated and should be frequently operated.

IN GENERAL.

The bore and chamber, breechblock, and all parts of the carriage, such as traversing rollers and their paths, and crosshead guides, will be carefully freed of grease and dirt; only bearing surfaces should be lubricated.

Uniformity in the action of the gun and carriage will be attained by lubrication of bearing surfaces and by adjustment of the working parts of the gun and carriage to insure smooth operation of the whole

as a machine. Guns should be tripped and retracted frequently. Just before target practice this should be done several times a day. The action of guns and carriages in firing should be observed, and a careful inspection should be made of them before and immediately after firing, notation being made of any change in adjustment as well as of any defects in material that the firing has caused.

2. **Projectiles.**—The weights of all projectiles to be used in a practice will be adjusted as nearly as possible to standard-range table weights. This may be done by filling the cavities of the projectiles with sand. A difference in weight of less than 2 pounds may be neglected, but anything greater than this should be taken into account.

Remove all loose paint from projectiles, making their surfaces *smooth*; polish the bourrelets.

The rotating bands will be carefully cleaned and all oil and grit removed from the grooves. Burrs on rotating bands or bourrelets will be removed.

Rotating bands of projectiles will be calipered and the projectiles classified in groups so that all projectiles for trial shots and all for record shots will, if possible, have rotating bands of the same diameter. In order that this work may have any value it must be done *most carefully*.

Variations in diameters of rotating bands cause variations in velocities. The grouping of projectiles, therefore, according to diameters of rotating bands will permit of uniform projectiles being used for trial and for record shots, and differences in velocities between the projectiles used for trial and those used for record shots, due to ununiform rotating bands, can be allowed for.

It has been determined by careful experiment that the variation of $+0.025$ of an inch in the diameter of a rotating band of a 6-inch projectile has given an increase of 30 f. s. in velocity. The Ordnance Department specifications allow a variation of ± 0.003 of an inch in diameter of rotating bands.

At all practices keep records as to differences in diameters of rotating bands of projectiles for trial shots and corresponding range variations. If all other variants have been eliminated in the trial shots, the information to be obtained from these records will be of assistance to battery commanders in making allowances for velocity due to differences in rotating bands.

The Ordnance Department last year conducted experiments with projectiles with narrow rotating bands at a battery the guns of which had been fired 200 times. The projectiles with narrow bands fell very

erratically. Projectiles with similar bands fired from new guns gave normal results. The Ordnance Department has issued projectiles with broad rotating bands for use at some of the batteries whose guns are known to be considerably worn. (The guns of two such batteries have been fired 200 times, and the third 118 times.) It is hoped that these broad-banded projectiles will increase the accuracy of guns that have been fired a great number of times.

NOTE.—Firing with broad-banded projectiles of the new design has been recently conducted. The results of this firing were most satisfactory; the dispersion of shots in calibration firing was small, and in the record firing 100 per cent. of hits was made.

3. **Powder.**—Powder for heavy guns (except those using fixed ammunition) will be blended as described in chapter VI. After blending the sections of charges will be carefully made up. Each section should be as *stiff and rigid* as possible, and of uniform cross-section and length. This can be attained by care in relacing and by a process of kneading or rolling after lacing. Weights of powder charges will be verified by an officer. The following illustration indicates very conclusively the advantage of careful blending.:

Last year several practices were held at a battery of 12-inch rifles on disappearing carriages, with International Lot No. 9, 1907, powder. This powder was carefully blended and behaved with great uniformity at all practices. The powder appeared to be weak, however, and on this account the Ordnance Department sent four charges of the same lot to be tested for initial velocity. Two charges slightly under normal weight gave the following results:

First shot	I. V. 2,153 f. s.
Second shot	I. V. 2,206 f. s.
Variation	53 f. s.

Two charges slightly over normal weight gave—

First shot	I. V. 2,369 f. s.
Second shot	I. V. 2,320 f. s.
Variation	49 f. s.

These charges were tested as shipped from the arsenal and were *not blended*.

Five charges of the same lot of powder were blended and shipped for test. These charges were blended with 16 other charges which

were used in practice. The results obtained with the five blended charges were as follows:

First shot	I. V. 2,198 f. s.
Second shot	I. V. 2,202 f. s.
Third shot	I. V. 2,212 f. s.
Fourth shot	I. V. 2,203 f. s.
Fifth shot	I. V. 2,215 f. s.
Maximum variation	17 f. s.

The Ordnance Department specifications for powder allow a variation of 1 per cent. either way from normal velocity. For a powder with normal muzzle velocity of 2,250, it will be seen that the total allowable variation is 45 f. s.

4. **Position-Finding Service.**—Communications will be inspected and all instruments in the position-finding service will be put in a condition of minimum error. Check all data upon which the position-finding system is based by examination of all available records and calculations of involved triangulations, if necessary.

(a) *Depression Position Finder.*—Test position finder for adjustment and orientation. Instruct observer in the proper use of instrument to avoid errors due to lost motion. Where targets entering the harbor move across the field of fire in the same direction during their entire course, azimuth-reading instruments should be adjusted by bringing the vertical wire on the orientation point always in the same direction, which direction should be that of the target in entering the harbor. Where lost motion exists which cannot be eliminated, its effect should be carefully ascertained and corrected for by the reader, especially when the direction of motion of the target which is being followed is opposite to that used in adjusting the instrument on the orientation point. It is very important that the observer should be instructed to *stop the instrument on the last stroke of the bell*, and in order to do this he must keep the vertical wire exactly on the designated point of the target during the last two or three seconds of the interval. Similarly the horizontal wire, in using the instrument for determining ranges, must be stopped on the water line on exactly the last stroke of the bell. Observers should be trained to give particular attention to either the vertical or the horizontal wire during the last seconds of each observing interval, depending upon whether the azimuth or the range of the target is changing most rapidly. If the azimuth is changing more rapidly than the range, the last two or three seconds should be devoted

exclusively to the setting of the vertical wire. If the range is changing more rapidly than the azimuth, the last two or three seconds of each interval should be devoted exclusively to the setting of the horizontal wire.

(b) *Plotting Board*.—Check orientation of base line and numbering of the degrees on the azimuth circle. Verify the setting of the gun center. See that the *locks* and all mechanical devices are in adjustment. To avoid errors due to lost motion in setting arms, both arm setters and the plotter should be instructed to cause the last motion of arms to be always in the same direction. The proper operation of these arms requires skill and care. A determination of maximum and minimum errors that result from various methods of setting arms, at different positions on the board, will impress upon the plotting detachment the importance of *uniformity* in the setting of arms. The calculated and plotted ranges (the latter by the method of setting arms selected as being most accurate) should not differ by more than 10 yards at mid-range. When the course of the target is plotted it should show uniform intervals, either equal or uniformly increasing or decreasing, depending upon its speed. If the interval suddenly changes the plotter reports the fact to the range officer. The latter immediately looks for the trouble and takes steps to eliminate it.

(c) *Range Board*.—The ruler should be parallel to the range lines. There should be no lateral motion of the ruler. The string should be properly centered. Some trouble has been experienced in the use of range boards due to the fact that with the old type of range charts the velocity curves did not cover the low velocities developed in practice. Some officers constructed additional curves in pencil and some selected arbitrarily a curve on the chart and made an additional range correction on the range arm. The latter method is inaccurate when trial shots and record shots are fired at different ranges and should not be used. It is not expected that these difficulties will arise this year, since the Ordnance Department has issued the latest revised range charts with velocity curves from 2,100 f. s. to 2,400 f. s., to all heavy gun batteries. If, however, velocities fall below the curves on the range board, additional curves in pencil should be constructed.

The following directions in the use of range boards should be observed where they apply:

On range boards issued prior to December 26, 1906, the curves are constructed to give corrections for the *actual* range. Therefore, it is necessary that the operator of the board should keep the ruler set at the *actual* range and not the corrected range. A setting to within

100 yards of the actual range is sufficiently accurate. The operator should be drilled in obtaining approximately the actual ranges from the corrected ranges read by the plotter from the gun arm of the plotting board.

On range boards issued December 26, 1906, and subsequently, the curves are constructed to give the correction for the *corrected* ranges, to that ranges read from the gun arm of the plotting board should be used in setting the ruler. The first corrected range can be obtained only by using the actual range in setting the ruler, hence it is only an approximation. The *second corrected range* obtained by setting the ruler at the first corrected range will be sufficiently accurate to use for firing. *It is necessary to obtain the second corrected range in firing at a stationary target as well as at a moving target.*

(d) *Deflection Board.*—See that the proper leaf-range scale and T-square range scale are attached and that the board is otherwise in adjustment.

Examine *time-interval clock, interrupter, and bell*, and all *telephones and switches*, to see that they are in good working order and properly adjusted. See that all screws are tight.

5. **Personnel.**—Substitutes should be trained for all the important positions in order that unexpected vacancies may be filled. All men operating telephones or other instruments will be put through the proper operators' tests, and drilled with a view to eliminating personal errors. *Too great attention cannot be given to the minutest details.* Each day the drill should be conducted as in target practice, or as if the boat for drill represented the enemy. At least once a week a simulated target practice should be conducted at each post. Time-out will be given occasionally as in practice. Any errors that are brought out in these simulated practices will be investigated and eliminated. Such records should be kept as will permit of careful checking of the work of each individual of the personnel throughout the system. The training of the personnel should be progressive; from the individual to the detachment, and then to the battery. The work of the battery as a unit requires co-ordination of the work of the various detachments. The individual training of gun pointers should be given attention.

The range officer is responsible for the accuracy of the data transmitted from the plotting room to the guns. He in turn should hold the plotter responsible for errors that pass him undetected. As a check against errors in deflection the gun pointer should be taught to associate the value of deflections sent to him with the angular travel of the target, which is uniform, or increasing or decreasing at a uniform rate. It is

thought that a gun pointer can be readily trained to detect errors in deflections when the fact is impressed upon him that their values should be uniform or increasing or decreasing at a uniform rate.

Dummy projectiles (see Fig. 88) should be rammed with the same energy as would be employed in practice. Ramming a very few projectiles during the drill will be of more value than going through the motions any number of times. Uniform ramming is of the greatest importance. If the projectile is not well rammed the powder gas will

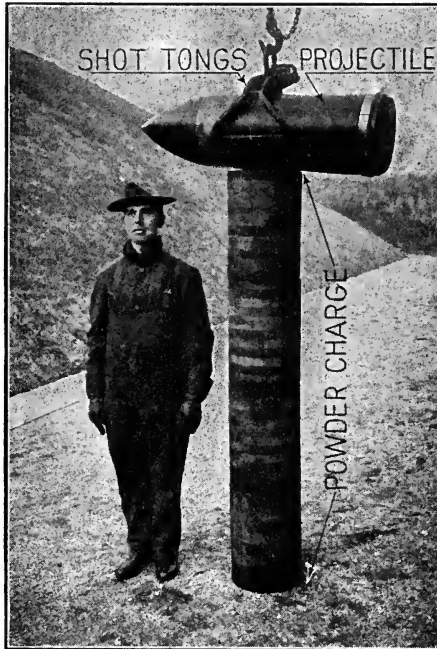

FIG. 88.—Complete Dummy Charge for 12-inch Gun.

escape around the rotating band, and there will be a loss in velocity. Projectiles should be rammed with all force possible.

It has been determined by test that the variation of a few tenths of an inch in the seating of a projectile will give a variation of 70 f. s. in muzzle velocity, due to the fact, apparently, that powder gases escape around the rotating band. The velocity in the case of the projectile not being home is less than when the projectile is rammed well home. (See Fig. 89.)

The following, bearing on the training of the personnel, is taken

from a report of an officer of the Coast Artillery Corps, who has secured uniformly good results in practice:

"The adjustment of the gun and carriage and the preparation of

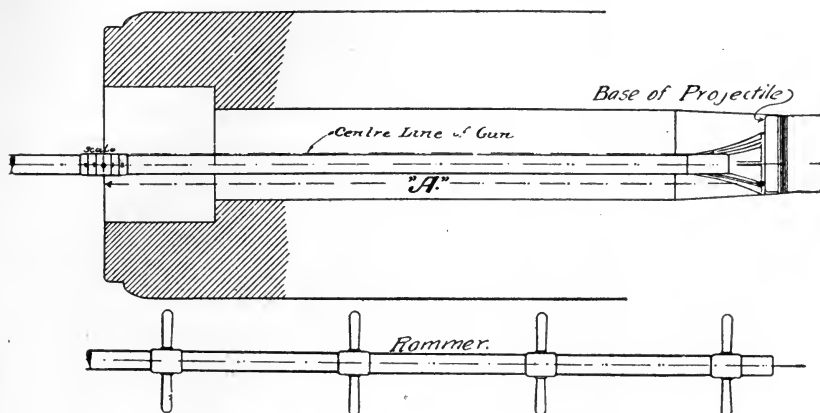

"A" for

Cal.	1895	1898 ^{1/2} M.	1895 M.	1895 R. 1898 M.	1896-90 M.	1886.	1900
8-inch	73.25						
10-inch	84.832	92.14	86.332				
12-inch	100.28	108.88 M.	102.23				109.35
12" Mortar				42.205	37.375	37.125	

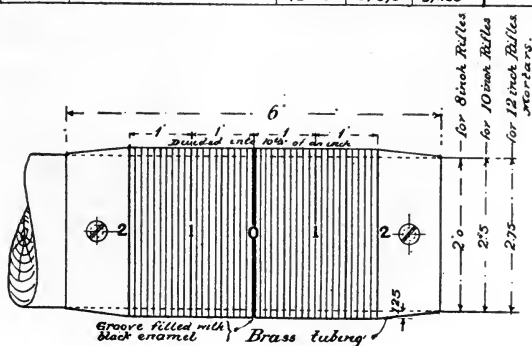

*Scale on Rammer,
to indicate proper travel of Projectile
for 8" - 10" - 12" Rifle and 12" Mortar.*

FIG. 89.

the ammunition, etc., is done before firing, when there is ample time for verification, but the accuracy of the work of the personnel is practically beyond the control of the battery commander after firing once begins. This must be provided for by thorough training. In this

training the methods of work used by each member of the range detachment including the range keeper and gun pointer should be definitely prescribed The sequence in which each member of the detachment performs the details of his work should be prescribed, also as far as possible the mental process he uses. The drill should then be continued until the work of each member becomes mechanical and thus, by force of habit, reduce to a minimum the errors that may occur when working under conditions of excitement or fatigue.

“In developing the work of the range detachment, I worked at each position in the detachment until I was thoroughly familiar with the details of the work at each position. I noted the routine in which each step of the work could best be done, and where errors were likely to occur. I also noted where irregularities, such as the loss of one or more observations, an error in reading the range or azimuth, etc., were likely to occur and prescribed exactly what should be done in each case, and by whom the correction of an error should be made. I then prescribed in detail the methods to be used at each position and required that they be strictly followed.

“If observations are lost, the plotter should so inform the guns. In case of errors in the observations or in the setting of the arms, he should report “lost” to the guns, unless it can be at once corrected. In both cases the range keeper, having noted the rate of change in range from previous data, should be able to set the disk at approximately the correct range and continue to do so for several observations. In transmitting the deflection to the guns the plotter should not attempt to detect errors therein, as he is fully occupied with his other work.

“The correctness of the work of the range detachment should be continually verified at all drills. If errors occur, they should be traced to the members of the detachment making them and the cause for same determined and corrected. The rate of change in the corrected range at which the range disk will be set will be uniform or gradually increasing or decreasing, depending upon the course and speed of the target. A record of the actual settings of the range disk will indicate in a general way the accuracy of the work of the range detachment as a whole.

“The following method is useful in verifying the work of each member of the range section except the observers and readers:

“Prepare data corresponding to the track of a target having both change in range and angular travel. This should be sufficient to cover about one-half hour of tracking. With the plotting board, range board,

etc., determine the following for each observation and tabulate same in convenient form:

“Number of observation.

“If vertical base is used: Azimuth of the target from B'; range of the target from B'.

“If horizontal base is used: Azimuth of the target from B'; azimuth of the target from B''.

“Corrected range sent to the guns.

“Angular travel.

“Total range correction as applied on range correction scale.

“Deflection.

“Corrected range (corrected for gun displacement) for each gun of the battery except the directing gun.

“The azimuth of the target from B' and B'' or the azimuth and range from B', if a vertical base is used, as given in above data, should be transmitted from the proper observing station to the plotting room at the usual observing intervals. The work of the range section and gun detachment should proceed in the usual manner. A record of the work of each member of the detachment, corresponding to that noted above, should be made and should include the actual settings of the range disk of each gun and the actual setting of each sight for deflection. A comparison with the prepared data will show all errors. To test the plotter as to the detection of errors in observations, reading, etc., incorrect azimuths or ranges should occasionally be transmitted from the observing room. The plotter should detect these and call “lost” to the guns. Occasionally the data for one or more observations should be regarded as lost and not sent to the plotting room. The range keeper should have kept the range disk set at the proper range from data previously sent, as above explained. The records of the actual setting of the range disk will show with what accuracy this has been done.

“Occasionally an incorrect range or deflection should be sent from the plotting room to the guns for the purpose of testing the range keepers and gun pointers.

“The above method can be used to advantage when there are no targets in the field of fire or it is foggy.”

Variations in Muzzle Velocity.—The battery commander should know what variation in muzzle velocity can be attributed to certain conditions which may exist in a practice. Variation in range due to a given variation in muzzle velocity and atmospheric conditions can be taken from the range board. Variations in muzzle velocity due to

variations in weights of charges, diameters of rotating bands, length of travel of a projectile in the bore, and to improper seating of projectiles in the gun cannot be taken from range tables; and variations in range due to variations in weights of projectiles cannot be taken *directly* from these tables. The following formulæ are reasonably accurate for small variations in weights of projectiles and powder charges and variation of travel of shot in the bore:

Variation in velocity due to variation in weight of projectile:

$$\Delta V = -\frac{7}{16} \frac{\Delta w}{w} V, \text{ in this formula } w = \text{weight of projectile.}$$

Variation in velocity due to variation in weight of charge:

$$\Delta V = \frac{6}{5} \frac{\Delta \omega}{\omega} V, \text{ in which } \omega = \text{weight of charge.}$$

In these formulæ weights of projectiles and powder charges are to be taken in pounds and length of travel in inches. The effect of the length of travel alone can usually be neglected, though some battery commanders may be interested in accounting for it.

To illustrate the effect of only two variables, let us take the following simple example:

The 12-inch rifle, model 1888, fires three trial shots at a range of 6,000 yards at a fixed target. The normal velocity is 2,520. Weight of projectile, normal, 1,046 pounds. Weight of charge, normal, 275 pounds. The projectile for the first trial shot weighs 1,058 pounds. The projectile for the second shot weighs the same. The third projectile has normal weight (1,046 pounds).

The charge for the first shot weighs 275 pounds. The charge for the second shot weighs 275 pounds. The weight of the charge for the third shot is 276 pounds.

Assuming that there are no other variations in projectiles and powder, in the work of the personnel, or in the operation of the gun and carriage, what would be the difference in range between the 1st and 3d trial shots?

By the formulæ above, we find that the variation in velocity due to +12 pounds difference in weight of projectiles is -11.29 f. s., and that the variation in velocity due to variation of +1 pound in weight of powder charge is +9.8 f. s.

Therefore, we have—

No. of Shot.	Weight of Projectile. Pounds.	Weight of Charge. Pounds.	Variation in Muzzle Velocity. f. s.	Range Variation. Yards.	Range Attained. Yards.
1.....	1058	275	-11.29	-50.8	5,949.2
2.....	1058	275	-11.29	-50.8	5,949.2
3.....	1046	276	+ 9.81	+45.1	6,045.1

The difference in range between first and third trial shots, therefore, would be 95.9 yards.

This shows the effect of the combination of only two varying factors. A systematic elimination of *all* variables which may be said to be in the hands of the battery commander is necessary if the problem is to be solved with any certainty. It is possible that in practices where good results have been obtained there have been compensating variations. Success in these cases has been due to good luck, not good management. Good practice on the average will result only from methodical and painstaking work at all times.

Accuracy of Fire and Practice.—Battery commanders should distinguish between accuracy of fire of a gun and accuracy of practice of a gun. Accuracy of fire is determined by the grouping of shots around the center of impact of the group. Accuracy of practice is determined by the distance of the center of impact from the center of the target. In order to have a measure of *accuracy* of fire, and of practice, battery commanders should know the probable errors of the guns of their batteries with the ammunition used in practice. All shots of the group of shots from which the probable error is determined should be fired at the same elevation and under identical conditions *as nearly as possible*.

In order to have available information as to probable errors of their guns, data will be collected from trial and calibration shots from the guns of each battery. For this purpose, district commanders have issued a number of blank probable error cards of the type shown on page 522, sufficient for carrying out the instructions indicated.

An officer taking command of a battery should be materially assisted by these cards, which will indicate the accuracy of fire of the guns of his battery as mounted and with ammunition used from year to year. He can also, by a proper combination of the several results, draw conclusions as to the *mean* results to be expected from his battery by the following process:

It is desirable, of course, to find the probable error at each range at which firing takes place and thus acquire data for a curve of errors as a function of the range. It is thought best, to begin with, to select 4,000, 6,000, and 8,000 yards as the points to determine the curve and to reduce probable errors to these ranges as follows:

Superimpose the centers of impacts of all groups of shots fired at odd times and at different ranges between 3,000 and 5,000 yards at a point having a mid-range of 4,000 yards; all groups between 5,000 yards and 7,000 yards at 6,000 yards; all groups from 7,000 yards to 9,000 yards at 8,000 yards.

This can be done in the following manner:

Say, for instance, we have six groups of shots between 5,000 and 7,000 yards, each group fired at a different range. Superimpose the centers of impacts of all groups at a mid-range of 6,000 yards, and correct the dispersion of each shot of each group by finding the equivalent of the actual dispersion in yards, in velocity, and in turn determine the dispersion at 6,000 yards which this variation in velocity would cause. In this way each shot of each group will be reduced to the dispersion it should have at 6,000 yards. In other words, the errors from center of impact of a group of shots at any range between 5,000 yards and 7,000 yards will be reduced to what they would be at 6,000 yards through *velocity*. Having treated all groups in this manner, then the probable error will be determined from the total number of shots fired between 5,000 and 7,000 yards as if they all belonged to one group. In this plan we assume that velocity variation is the principal source of error. This contemplates careful adjustments and preparation of material.

Knowing what is the best that his guns, as mounted and with ammunition used in practice, will do, the battery commander will then be able to correct for observed errors with intelligence, and can compare the accuracy of practice which he has obtained with the accuracy of fire obtainable from his guns. Now, the probable error of any gun which is obtained as indicated above is defined as such that just half the shots fired will in the long run have an error equal to or less than this probable error. The mean error multiplied by 0.845

is the probable error. The total width of the 50 per cent. zone, which is compared to the target zone to determine expectation of hits, is twice the probable error or 1.69 times the mean error. Ballistics, Part I, by Captain Alston Hamilton, will indicate method of determining expectation of hits.

It is desired in practice to place the center of impact of a group of shots in the center of the target zone. Therefore, in comparing the 50 per cent. zone with the target zone to determine expectation of hits, it should be considered that the point aimed at is one-fourth the width of the danger space beyond the water line of the target. This is necessary because with the present target the target zone is made up of the danger space beyond the target and one-half the danger space short of the target.

Calibration.—Calibration has been conducted from various batteries from time to time. It is the intention to continue this firing as funds will allow, the batteries in service being calibrated first. Full advantage should be taken of the information obtained from calibration firing. The purpose of this firing is to enable such adjustment of the range scales of the guns of a battery that all guns when set at the same range reading will attain the same range. When mean errors from calibration firing have been comparatively small and calibration data reliable, elevation scales of the guns of a battery should be adjusted to correct for differences in ranging of the guns.

In adjusting the scales of guns as a result of calibration firing, a gun of the battery should be taken as the standard gun, and all guns should be adjusted to this one. The gun first selected as a standard will always be the standard gun of the battery. It is desirable, in the first adjustment, that the standard gun should be the one whose center of impact is nearest the target, and that its range scale be not shifted. The range scales of the remaining guns of a battery should be adjusted so that these guns when set with the same range scale reading as the standard gun will attain the same range as that gun.

Complete record of data obtained in calibration firing and adjustments made as a result of this firing will be kept in battery emplacement books, in order that the battery commander may have information as to differences in the shooting of guns and the setting of indices to secure uniformity in ranging of the guns of the battery.

The method outlined above appears to be the best from a consideration of the information at present available. If as a result of calibration firing in the future a better method is determined upon,

proper instructions will be furnished to all concerned. Battery commanders having suggestions to make with reference to the method of calibrating guns should submit them in brief, concise form, with reports of calibration firing to the Chief of Coast Artillery.

After the calibration adjustment is made, then the center of impact of a group of shots from the battery may be adjusted to the center of the target zone, for any practice, by means of trial shots from any gun of the battery.

There is given below extract from the proceedings of the board which conducted calibration firing in 1908. This firing was very carefully conducted. It is thought the report will be of interest to the service and useful to officers who have not had experience in calibration firing. This was the most complete report of calibration firing submitted in 1908.

The arrangements for and details followed in the conduct of the firing were as follows:

The Station.—A lighthouse 5,950 yards from the battery was used as an observing station.

A wooden platform was constructed on the lower braces of the tower and the range rakes mounted on the rail and securely fixed in position with the middle point, reference number 50, on the target. The azimuth instruments and the camera were mounted on the lower platform of the lighthouse; thus a solid platform was obtained, so that the movements around the instruments did not disturb their adjustment.

Local conditions made it necessary to locate the target 400 yards from the station instead of 200 yards, as called for in the instructions.

The Target.—The target, a standard pyramidal target, was anchored in position by four 500-pound mine anchors. . . .

At the time the target was anchored it was found impracticable to lay off the distance of 400 yards, owing to the fact that a strong wind was blowing with the tide coming in. The target was anchored accurately for range as determined by an azimuth instrument mounted on the station; the distance by computation was found to be 525 yards. Observations made daily on the target showed no material movement of the target in range or direction.

Range Rakes.—New range rakes were made, the points being placed one-half inch apart, the value of each point being 6 yards. The crosspiece was made so that it could be adjusted for various distances from observer to target. Reference numbers stamped on the rakes

were used to avoid confusion, the numbers increasing from 0 on the left to 100 on the right.

The crossarms were adjusted by a member of the board just before the firing and the range rakes bolted in position with the meridian line on the target. The rear sight was 43.75 inches from the cross-arm, making each point 6 yards. The range observations were very satisfactory. The officers charged with the work were interested, and the results demonstrated that the range rake is satisfactory when used in an intelligent manner. The azimuth instrument observations were used as a check on the range rakes, and as such gave very satisfactory results. It is believed, however, that the longer time taken to turn an azimuth instrument on to the splash gives the splash time to spread out, thus causing greater variations in separate readings. The value of having at least one azimuth instrument was demonstrated, however, on the first shot, which struck 546 yards short; that is 246 yards off the range rakes. This splash was caught by both azimuth instruments.

The board procured a Panorama Kodak No. 1, Eastman Kodak Company, from the War College for the purpose of observing the fall of the shots.

An observer at the lighthouse caught every shot.

A table about 4 feet high was lashed to the rail of the lower balcony of the lighthouse and the camera was leveled on this and the central position of the lens was accurately directed on the target so that the latter would appear in the same position on each negative. The camera was then fixed in this position.

If there were any imperfections in the camera lens, this arrangement insured that the fall of the shots would be measured under identical positions of the lens, and the comparative values of the overs and shorts would not be affected.

The observation by range rakes, azimuth instrument, and camera are tabulated on opposite page, and columns 1, 2, and 3 give comparative results of the three independent methods.

The differences are tabulated in columns 6 and 7.

It will be seen that the maximum difference is but 8.67 yards.

Column 5 gives the width of splash, as shown by the camera, the average width being about 26 yards.

[All measurements are reduced to yards.]

No.	Range Rakes.	Azimuth Instrument.	Camera, Inside of Splash.	Camera Outside of Splash.	Width of Splash.	Difference, Azimuth Instrument and Range Rake.	Difference, Camera and Range Rake.
1	Off rk.	546.80	483.33	503.33	20.00		
2	114.00	112.50	116.67	143.33	26.66	1.50	2.67
3	168.00	164.08	166.67	196.67	30.00	3.92	1.33
4	168.00	167.16	176.67	200.00	22.33	0.84	8.67
5	291.60	290.56	290.00	320.00	30.00	1.04	1.60
6	168.00	171.84	173.00	196.67	23.67	3.84	5.00
7	102.00	101.56	103.33	126.00	22.34	0.44	1.33
8	114.00	111.00	106.67	143.33	36.60	3.00	7.33
9	84.00	82.76	83.33	108.33	25.00	1.24	0.67
10	192.00	193.78	200.00	223.00	23.00	1.78	8.00
11	150.00	148.36	146.67	176.67	30.00	1.64	3.33
12	126.00	128.08	121.67	150.00	28.33	2.08	4.33
13	192.00	187.05	200.00	216.00	16.00	4.95	8.00
14	129.60	128.08	133.33	156.67	23.34	1.52	3.73
15	225.60	220.28	220.00	256.67	36.67	5.32	5.60
16	156.00	159.36	163.33	190.67	27.34	3.36	7.33
17	78.00	71.56	76.67	100.00	23.33	6.44	1.33
18	144.00	140.56	150.00	173.33	23.33	3.44	6.00

Close agreement of the range rakes and azimuth instrument with the photographic record shows excellent judgment and uniform carefulness on the part of the observers.

From the well-known construction of the panoramic camera and its action, it is readily seen that these negatives give the exact relative locations of target and splash.

The range rake and azimuth instrument observers cannot avoid taking varying parts of the successive splashes, and so may make errors as great as 20 yards.

The camera record can be measured at leisure and checked as often as may be desired.

The range-rake observations were taken as the official records.

Powder.—The powder supplied for this firing was Nitro Cel. International, Lot. 9, 1907. V. 2,250 f. s., P. 36,500, W. 257, Proj. 1046.

Owing to the damp condition of the magazine this powder had been stored in a powder-storage magazine, from the date of its receipt, April 15, 1908, until it was brought to the fort, in June, 1908, and placed in the submarine mine storeroom, where it was served to the guns as needed in the firing.

This powder gave very satisfactory results as to uniformity, but the probable V. appears to have been only 2,150 f. s., while the maximum pressure recorded was only 32,377 pounds. It is believed, however, that the pressure was higher than this.

Projectiles.—The projectiles supplied for this firing were those having the old-style cap, i. e., caps longer and of greater diameter than the later ones.

Owing to age and frequent handling the rotating bands were more or less deformed.

The maximum variation in seating the projectile was 0.228 inch on No. 1 gun and 0.3 inch on No. 2 gun. This variation was too great and was due to the use of untrained men for the service of the piece.

Crusher Gauges.—Four crusher gauges were supplied; these were handled by an ordnance machinist detailed for that purpose and supervised by an officer, the results being examined and checked by a member of the board. Cylinders compressed to 32,000 pounds were used for the first shot, but as the pressure of only 32,377 pounds was recorded, cylinders compressed to 28,000 pounds were used for the remaining shots. Even with these no compression was recorded on the seventh, ninth, and tenth shots. These records are not considered reliable; it is believed that the pressures were higher and more uniform.

Density of Loading.—The density of loading varied to some extent.

Results and Records.—Plotting of shots from range rakes and azimuth instrument observations may be briefly tabulated as follows:

No. 1 GUN—RANGE, 5980 YARDS

Shot.	Pressure. Pounds.	Struck Short. Yards.
First.....	32,377	546
Second.....	31,925	168
Third.....	28,092	291.6
Fourth.....	*	102
Fifth.....	*	84
Sixth.....	30,035	150
Seventh.....	29,295.5	192
Eighth.....	29,046	225.6
Ninth.....	28,092	78

Maximum variation in seating of projectile, 0.228 inch.

Maximum variation in distance to third section, 2.144 inches.

* Not recorded.

No. 2 GUN—RANGE, 5950 YARDS

Shot.	Pressure. Pounds.	Struck Short. Yards.
First.....	32,356	114
Second.....	28,092	168
Third.....	29,665	168
Fourth.....	29,572	114
Fifth.....	*	192
Sixth.....	29,757	126
Seventh.....	31,330	129.6
Eighth.....	28,092	156
Ninth.....	29,017.5	144

* Not recorded.

Maximum variation in seating projectile, 0.3 inch.

Maximum variation in distance to third section, 1.856 inches.

Comments and Conclusions.—Lateral dispersion of fire is known to be small for all modern rifled guns, as the deflections obtained in this practice show. The necessary correction for such dispersion is so easily determined and so readily applied in practice that it may be omitted from this report.

A careful study of the results and due consideration of the conditions and circumstances of the firing indicate to the board the following conclusions:

1. That whatever erosion or other imperfection may have existed in the guns themselves, the effects of such imperfections were of least importance in producing inaccuracy of fire when compared with the mount.

2. That the chief source of inaccuracy was the mount; it being the opinion of the board that with each of the carriages used the "jump" of the gun was an important element, probably negative in value and variable in amount.

3. That blending should be required at all times.

The board believes that the method of blending, while accurate, is not suitable to service conditions. The board, however, is of the opinion that all powder should be blended, whether in practice or in service. Under war conditions powders from various sources will be found at every post, all manufactured under the same specifications of the Ordnance Department, but varying slightly in velocity, rate of burning, etc.

Velocity for Trial Shots.—Such velocity should be assumed for the trial shots as will bring these shots as near as possible to the target.

On account of the fact that a great many powders have fallen off in velocity and are considerably under the velocity tabulated in general orders, as determined by tests of the Ordnance Department, it may be necessary for battery commanders to base their assumption as to the muzzle velocity of their powder for trial shots on previous experience obtained with this powder either by themselves or others in the service. For this reason there is available a tabulation showing the mean results obtained with the various lots of powder in use throughout the service.

Determination of Range Errors of Trial Shots.— . . . All officers should strive to eliminate these errors in the observation of trial shots. The greatest care must be exercised by range observers on the tug in observing splashes, and there should be a thorough understanding by the officers on the tug and those on shore as to the method of signaling to be used. Range rakes will be inspected by the officer in charge of range observers before the practice. These rakes will be graduated in mils. The tug will be anchored opposite to and as nearly as possible at right angles to the line joining gun and target. The position of tug and target immediately before and after each shot will be observed by the position finders of the battery firing and these positions plotted on the plotting board in order that mils can be correctly converted into yards when they are signaled in.

If the first trial shot should fall too great a distance from the target to permit of its accurate observation by the range party, the battery commander should change the elevation, provided he believes that the error was due to faulty assumption as to muzzle velocity, so that the remaining shots will fall near the target. If this is done properly the battery commander should then have the benefit of at least two good trial shots. Having fired the trial shots, if these are normal and the errors are small, the general practice is to take the mean of the errors of these shots in making corrections for velocity for record shots. If one or more shots are erratic, it may be the erratic shot or shots should be thrown out, although this depends on the circumstances. The problem must be solved on its merits in each case by the battery commander and no definite rules can be laid down. With the present target such assumption as to velocity for record shots should be made as will place the center of impact one-fourth the width of the danger space beyond the water line of the target.

Adjustment of Center of Impact.—To aim at a point one-fourth the danger space proper beyond the target is equivalent to aiming at a point on the target $7\frac{1}{2}$ feet above the water line. As the present target is 30 feet high (see Fig. 90) and therefore the point to be aimed at is $7\frac{1}{2}$ feet

above the water line, if we make correction for plus $7\frac{1}{2}$ feet in the same way as the correction is made for plus tide we accomplish the desired result. It will be seen that when the trial shots are fired at one range and their center of impact is adjusted for one-fourth the width of the danger space beyond the target for that range, this fixed correction will not be the true one when the record shots are fired at different ranges. An officer of the Coast Artillery Corps has suggested, in order that the proper correction may be made at *all* ranges, that a curve be constructed on the range chart for $7\frac{1}{2}$ feet of tide. This curve may be put on the range chart in pencil and can be placed conveniently to the left of the travel scale, using the left vertical line of travel scale for the normal of the curve. It should be understood that this correc-

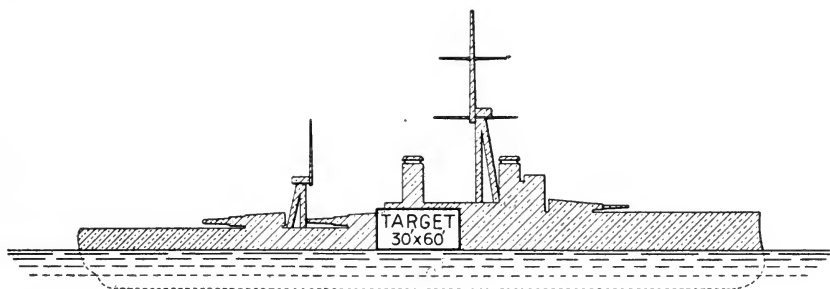

FIG. 90.

tion for placing the center of impact in the center of the target zone is in addition to the other corrections now provided for on the range board.

Observation of Fire.—The question of the observation of fire has received considerable thought and the policy in regard thereto was outlined in a memorandum from the office of the Chief of Coast Artillery, dated June 1, 1908. This memorandum pointed to the conclusion that corrections based on observation of fire were inadvisable in the case of batteries equipped with a separate position-finding system, viz., the 8-inch, 10-inch, and 12-inch rifles, and the more important 6-inch batteries, in view of the fact that observations of overs and shorts have been found to be unreliable. It was stated in this memorandum as the opinion of the Chief of Coast Artillery that it was not thought advisable for battery commanders to apply corrections based on observations of fire until they had assured themselves, through the observation of a number of shots, that there was a constant error in the ranges for which the guns were laid. It is believed that the number of shots upon which any correction is based should be not less than three.

Therefore, if the battery commander by observation *determines* the fact that three or more shots have fallen uniformly short or over, he should then make an arbitrary correction to cause the remaining shots to fall in the center of the danger space. Correction should not be made when the fall of the shots is within the mean error as determined by the trial shots. Observation of fire with heavy-gun batteries is the last step in the solution of the target-practice problem. In this problem we must start with the gun and eliminate all source of error there first. Having done this, then if the shot does not strike the target we know that the manipulation of the gun has been faulty; that is, errors have arisen in the range finding and the proper application of the data determined by the position-finding system to the guns. We may say, therefore, that observation of fire is a means of correcting errors in the position-finding service or the manipulation of the gun; and to employ it intelligently we must assume that the errors we are correcting for are *constant*. It will be appreciated that the most difficult step in observation of fire is the correct *determination* of the range errors. This is practically impossible excepting at very short ranges. On high sites observation of fire is more feasible; even on these sites the errors of shots can be correctly estimated only at short ranges. When errors can be determined by observation any correction made as a result thereof will be made by the battery commander and not by the gun pointers.

At a test with 3-inch guns, it developed that observation of fire was unreliable except at very short ranges for the ordinary height of battery. Range errors short of the target could be fairly well estimated, but it was practically impossible to estimate reliably the errors of the shots that fell beyond the target. As a result of this test in which a great number of rounds were fired, the following conclusions on the proper method of making corrections from observation of fire with rapid-fire batteries were arrived at:

That range corrections based on observation of fire should be made only by the battery commander.

That deflection corrections with rapid-fire guns should be made by gun pointers. The training of gun pointers is, therefore, of great importance.

That velocity corrections as a result of trial shots with rapid-fire guns may be applied by shifting the range scale or the pointer, or by correcting the ranges determined by the range finder, before these ranges are posted."

VALUE IN YARDS OF POINTS OF DEFLECTION

During subcaliber and service practice, battery commanders should record and study deflections. In this connection the following table will be found beneficial.

Hundredths of degrees.....	5	10	15	20	25	30	35	40	45	50
Minutes.....	3	6	9	12	15	18	21	24	27	30
Points.....	1	2	3	4	5	6	7	8	9	10
RANGES	VAL UE I N Y ARD S									
1,000.....	1	2	3	4	5	6	7	8	9	10
2,000.....	2	4	6	8	10	12	14	16	18	20
3,000.....	3	6	9	12	15	18	21	24	27	30
4,000.....	3	6	9	12	15	18	21	24	27	30
5,000.....	4	8	12	16	20	24	28	32	36	40
6,000.....	5	10	15	20	25	30	35	40	45	50
7,000.....	6	12	18	24	30	36	42	48	54	60
8,000.....	7	14	21	28	35	42	49	56	63	70
9,000.....	8	16	24	32	40	48	56	64	72	80
10,000.....	9	18	27	36	45	54	63	72	81	90
11,000.....	10	20	30	40	50	60	70	80	90	100
12,000.....	10	20	30	40	50	60	70	80	90	100

NOTE.—This table is not exactly accurate, the value of one point at 1,000 yards is exactly 0.87426 yards, but as the error is less than one yard it may be used safely for all firings under Case II. The value of one point may therefore be taken as .001 of the range, or equal to one mil.

All ballistic corrections which battery commanders may desire to make should be sent through the primary station. They should see that an accurate record is kept of all shots fired.

In battle and fire-command drills after receiving the order announcing the kind of fire, battery commanders state the kind of projectile to be used, the character of fire and command, "Commence firing."

At target practice they see that all reports are properly and promptly transmitted.

During drills men temporarily disengaged should be required to remain silent and alert. No talking or smoking should be permitted at emplacements or stations under any circumstances.

No person should be allowed on the parapet during drill or practice.

Battery commanders should remain constantly at their proper stations unless called away for some urgent reason, in which event they leave word where they can be found.

The possibility of gun pointers or others being disabled should be provided for and their successors named in advance.

The following are the proper commands for battery commanders:

To load and fire:

"No. 1 (or, No. 2), With dummy projectile; Fire one shot, Commence Firing."

"No. 1 (or, No. 2), With A. P. Shot, Fire one shot, Commence Firing."

"No. 1 (or, No. 2), With dummy projectile, Commence Firing."

"With dummy projectile, Fire one round, Commence Firing."

"With A. P. Shot, Commence Firing."

"With Subcaliber ammunition (or, C. I. Shot, or, Dummy Projectile, etc.), Commence Firing."

During battery drill battery commanders designate targets in the same manner as prescribed for fire commanders.

EMPLACEMENT OFFICERS

Emplacement officers should be so familiar with the entire mechanism of guns and carriages as to be able, if necessary, to take the place of any enlisted man in the gun section.

They should be perfectly capable of making any repairs of a minor nature that may be necessary during drill or action. They should have a practical working knowledge of breechblocks, firing mechanisms, the recoil system and stuffing boxes, as well as sights and the various equipment incidental to guns and mortars.

No emplacement officer is capable of doing the work which the position requires unless he has a practical working knowledge of each position on the gun.

Emplacement officers should take every opportunity to teach enlisted men the theory of the work, that is, the theory of pointing and laying guns; the meaning of Case I, Case II, and Case III; as well as the part each of them plays in the logical chain of events which begins at the target, thence to the primary and secondary stations, thence to the guns and back to the target again.

A close study of the illustrations found herein of the several types of guns, mortars and various equipment connected therewith, will be found a great help in their studies.

Emplacement officers are responsible to the battery commander that all parts of the guns and carriages are in perfect working order

and that all necessary adjustments are properly made. They are responsible for safety during drill and action. They should see that their men work with calmness and speed, keeping constantly in mind that proper seating of the projectile, careful handling of powder, proper locking of the breech, proper swabbing of the powder chamber after each shot, are all matters of vast importance—each of which takes precedence over speed.

Emplacement officers see that the ammunition specified is used, that the artillery discipline during drill or action is constantly maintained, that men disengaged stand at ease, that in moving from place to place the men do so at double time, and that all orders are instantly obeyed.

RANGE OFFICERS

Range officers should be perfectly capable of operating and adjusting every instrument in the fire-control stations. This knowledge should be such that in case minor repairs are necessary they can make them.

Upon arrival at the station the range officer should see that each man examines and properly adjusts the instrument to which he is assigned and that the proper reports are made to the Plotter. The reports, when no defects are found, are as follows: "B Prime, In Order." "B Second, In Order." "Deflection Board, In Order." "Range Board, In Order." "Telautograph, In Order." "F. C. Intelligence, In Order." "B. C. Line, In Order." "Gun Line, In Order." "Secondary Intelligence, In Order."

The Plotter, after having received the above reports (or reports of any repairs necessary), and after making the adjustments of the equipment to which he is assigned, reports to the range officer: "Sir, Plotting Room, In Order" (or reports such defects as cannot be readily corrected).

The Observer, after satisfying himself that the observing room equipment is in order and that the position-finding instrument is in proper adjustment, reports to the range officer: "Sir, Observing Room, In Order."

After the range officer has satisfied himself by personal inspection that everything is in readiness, including Secondary Station, he reports to the battery commander: "Sir, Fire Control Stations, In Order" (or reports any defects that cannot be readily corrected).

Upon orders being received from the battery commander designating a target, the range officer commands:

“Target (repeating the battery commander’s description verbatim; and adding any other information that may facilitate identification).”

After the target has been identified by the primary and secondary observers and the gun pointer (or, if vertical base system is used, by the primary observer and gun pointer), the range officer commands:

“Horizontal (or, Vertical) Base, Track.”

He then reports to the battery commander over the B. C. line:

“Target.”

Upon orders being received from the battery commander to change target, etc., the range officer commands:

“Cease Tracking. Change Target. Target (repeating description, etc.).”

At the end of the drill or exercise, the range officer commands:

“Close Station.”

In the case of battle or fire-command drill or action, he transmits the following message from the battery commander to the fire commander:

“Dix, In Order.” (Or, reports repairs which the battery commander deems necessary.)

When a target is assigned by the fire commander and after it has been properly identified, the range officer sends the following message to the fire commander:

“Dix, Target.”

The range officer receives directly from the fire commander, and executes, orders as to the assignment of targets; and when direct communication between the fire commander and the battery commander is impracticable, he receives directly, and executes, other orders pertaining to the fire action of the battery. He is responsible, however, for the prompt and accurate transmission to the battery commander of all orders received by him directly from the fire commander.

TUG OFFICER AND TUG OBSERVER

An experienced officer not belonging to the company firing, preferably a district staff officer, is in charge of the tug during service practice.

The tug officer determines the overs and shorts for all shots except the record practice of guns below 4.7 inches in caliber. He is assisted by an officer or a non-commissioned officer equipped with a camera or a range rake. (For description, see DEFINITIONS.) For trial shots

both observers obtain the overs and shorts in mils. For record shots of mortar batteries and of gun batteries above 4-inch the assistant observer uses the camera, if available; otherwise the range rake. When both observers are using range rakes, the results of the observations on the tug shall not be called or spoken aloud, but shall be recorded without comment by the observer as soon as made. The observer shall sight on the edge of the splash nearest the gun. The average of the deviations determined by the observers when both are using range rakes shall be recorded as the deviation normal to the line joining the tug and target. When record is obtained with the camera the range-rake observation shall be discarded and, under direction of the fire commander, the camera record reduced to yards. The records are submitted to the fire commander on the proper form, who may discard the deviations reported by any observer upon satisfactory representation by the officer in charge of the range party on the tug that the observation was probably erroneous. The points of attachment of the towline to the targets and the point of the towline at the position occupied by the observers on the tug shall be marked by tying cloth around the towline or by other suitable means. Immediately after the practice and while still wet the towline shall be detached from the tug and targets, stretched, and measured accurately between the points marked, under the supervision of the officer in charge of the tug, and the result of this measurement shall be entered on the proper form as the length of the towline. No allowance shall be made for sag.

Tug officers are responsible that the following material is on the tug whenever it goes out for target practice.

One copy of current Coast Artillery Instruction Memorandum; one copy of Tug Service; six forms No. 823; one red streamer; three range rakes; 600 yards of towing line; 300 yards of anchor rope; 3 buoys; all the target anchors available; paint pot and brush, for marking out subcaliber hits; two pairs of field glasses; one army signal code card; two red wig-wag flags; one measuring tape; two cameras; one memorandum pad.

Each launch should be equipped with a red streamer, a red signal flag, and a copy of Tug Service.

Each tug should be equipped with wireless telegraph apparatus in order to communicate with the officer in charge of the firing as well as to promptly inform the battery commander of the range deflections of trial shots.

Tug officers are responsible for the efficiency of the tug detail, which should consist of the necessary number of men to handle targets,

to watch shore signals, to read or send wig-wag signals, and to use the cameras.

The actual maneuvering of targets from tug will be under the supervision of the master of the tug.

All personnel detailed for tug service should provide themselves with lunches.

Each fixed target should be anchored with two heavy anchors and buoyed; a rectangular target always broadside to the battery.

As far as practicable targets should be planted the day before firing.

A fixed target should, whenever practicable, be left down as a marker on the selected course for practice at a moving target.

In anchoring the tug to observe splashes or hits for fixed target, always take position to left of target (as viewed from the battery) on a line perpendicular to line of fire, about 200 yards when rectangular target is used, 300 yards for service gun practice, and 500 yards for mortar practice (subcaliber and service). Always anchor tug for trial shots. For description of targets, see Pyramidal and Material Targets, in the DEFINITIONS.

The nearest towed target, to the tug, for gun fire will always be 200 yards, and for mortars 500 yards.

Towline will always be stretched and measured wet, immediately after returning from practice under the direct supervision of the senior tug observer; the measured length being noted on report.

The senior tug officer will report to the Umpire and Fire Commander, before going out, for written instructions and a harbor chart with positions of targets, courses, etc., indicated thereon. This chart, with report, will be returned to the Umpire immediately after the return of the tug party to post.

The charted course for a moving target may often serve as a general guide only, or unexpected developments may change plans ashore. Consequently it may often happen that the tug will have to be run on course by signals from the signal station ashore. A constant lookout will be maintained for such signals, and they must be promptly and accurately obeyed.

Before leaving for day's work, the senior tug officer will set his watch on post time.

SHORE TUG SIGNALS

A flag will be designated on shore for the purpose of displaying the firing signal, and will be used for no other purpose. The firing signal

staff will be located in the immediate vicinity of the battery firing, preferably near the center.

A long red streamer will be displayed from the firing signal staff and one on the tug. In no case will firing be permitted unless the red streamer is displayed both ashore and afloat. As a rule, the first signal will be displayed on shore, the tug displaying its streamer as soon as the range is clear. In case of danger to tug or to any other boats near the field of fire, the tug will lower streamer, shore station

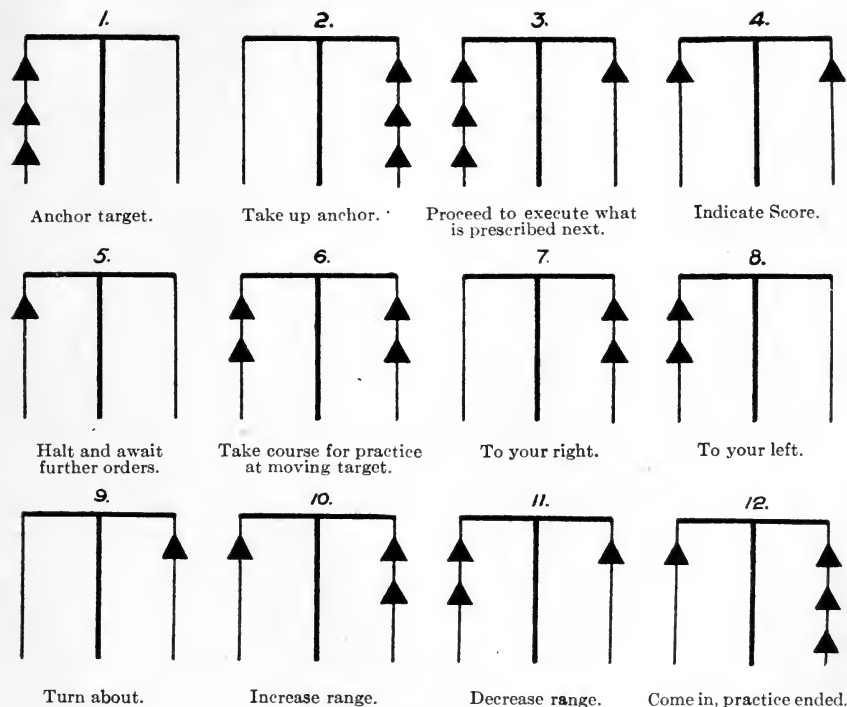

FIG. 91.

immediately responding. The whistle signal of "D" 222 will also be given from the tug.

During subcaliber mortar firing, on account of the difficulty of catching mortar splashes, the red streamer will be run down and up several times as a warning immediately after each shot is fired.

The "Maneuver" signal staff will be located in the immediate vicinity of the Fire Commander's station.

The accompanying diagram (Fig. 91) represents the various

maneuver signals as they would appear when viewed from the tug. Owing to their lightness and uniformity of dimensions four ordinary megaphones may be used, when available, in forming signals until cones or disks are supplied.

REMARKS ON MANEUVER AND SOUND SIGNALS

The tug should drop target anchors as promptly as possible after Signal No. 1 is shown on shore. If the tug is not fitted with appliances for tripping anchors at word of command drop a marking buoy at once.

(a) The tug will acknowledge all maneuver signals by one long blast followed by two toots in quick succession.

(b) The shore signal will be lowered as soon as the tug acknowledges. If signal is one that puts tug in motion, it will continue in the direction indicated until some other signal is displayed on shore.

(c) Signal up and down several times, means go slow, to be acknowledged by the tug as soon as made out, after original acknowledgment.

(d) Signal No. 3.—This means proceed to next step indicated in tug officer's orders.

(e) Signal No. 4.—The following designations are used:

Hit. "H" [122] 1 toot, 2 toots, 2 toots.

Over. "O" [21] 2 toots, 1 toot.

Short. "S" [212] 2 toots, 1 toot, 2 toots.

To indicate the number of hits at subcaliber gun practice; acknowledge Signal No. 4. After marking, Signal "H," considerable pause, followed by one toot for each hit. If no hits, signal "H" only.

To indicate the result of a trial shot at service gun practice, and mortar practice (subcaliber and service) acknowledge Signal No. 4, long pause, toot "S" or "O" as the case may be, considerable pause followed by one toot for each division of the range rake. If there is no deviation signal "O" only. In the case of shot off the rake, after "S" or "O," give one long blast, marked pause, and one toot for every five divisions of estimated deviation.

Make a distinct pause between toots in a series indicating hits or mils so that successive puffs of steam can be clearly distinguished.

(f) Halt (No. 5) repeated means a probable intermission or delay of half an hour for each repetition.

(g) Signals Nos. 7 and 8.—If at a halt move in direction perpendicular to line joining tug and Fire Commander's station, rights or

lefts being determined as tug observer faces this station. If in motion bear off in direction indicated (as tug observer faces bow) by one point (about 11 degrees). To make a considerable change in direction repeat necessary number of times.

(h) Signal No. 9.—Tug will make a turn of 180 degrees to right. If once repeated turn to left. (In either case, as observer faces bow.)

(i) Signals Nos. 10 and 11.—Move directly away from or towards Fire Commander's station as the case may be.

SOUND SIGNALS

Tug will use following conventional sound signals:

"D" 222 (2 toots, 2 toots, 2 toots), Danger to tug or to boats in the vicinity.

"W" 1121 (1 toot, 1 toot, 2 toots, 1 toot), Something wrong on board, am having trouble.

"K" 2121 (2 toots, 1 toot, 2 toots, 1 toot), All right now, am ready to resume work.

"X" 2122 (2 toots, 1 toot, 2 toots, 2 toots), Have executed what was ordered last (used generally after a movement requiring some time to execute, has been completed as directed by Signal No. 3).

WIG-WAG SIGNALS

(a) The shore flagman will be posted near the maneuver signal staff.

(b) The tug's call letter is "T". The shore station's call letter is "F."

(c) The tug will never be called unless Signal No. 5 is first displayed. If tug wishes to call shore, the tug will always do so from a halt. In the latter case, in addition to the usual wig-wag call, the tug will toot "F" (2221) 2 toots, 2 toots, 2 toots, 1 toot.

(d) Tug will acknowledge wig-wag call in the same manner as prescribed in the case of maneuver signals, this in addition to the flagman's acknowledgment.

(e) The tug flagman should be posted well up on the upper deck with the sky as a background, and a red flag should be used.

Whenever practicable, the shore flagman, also, should use a sky background.

NIGHT SIGNALS

For maneuvering at night, the Battle Commander's searchlight is used to indicate the number of disks or cones used for each of the maneuver signals.

The beam is first directed over the smokestack of the tug and then swung in arcs of about 30 degrees to the right or left, as seen from the tug. When both right and left are required, the right arcs are made first. For example, maneuver signal No. 3 would be one swing to the tug observer's right and three to his left; signal No. 6, would be two swings to tug observer's right and two to his left.

WIRELESS COMMUNICATION

When wireless communication is used, the maneuver signals are communicated by number, prefixed by the letter M. For example, the maneuver signal indicating "Take up anchor," would be sent "M2."

OBSERVERS

Observers are trained out of drill hours, to observe fixed objects, the distance of which are accurately known, until they can quickly determine ranges with accuracy. Officers in immediate command of observers test their proficiency in the following manner: After the observer has properly adjusted the instrument (as explained in Chapter VII), the range and azimuth scales are covered.

The officer then indicates the object (the range and azimuth of which is accurately known), and commands: "Take," at the same time starting his stop-watch. As soon as the observer has completed the observation, he reports, "Now."

The officer then stops the watch and personally reads the range and azimuth from the scales of the instrument, making a record of the readings as well as the time between "take" and "now." Several points are located in a like manner and the operation repeated until three observations have been made on each point.

Observers should carefully study the methods of water-lining, (See Depression Position Finder, Chapter VII). They should continually follow the target, keeping the vertical cross-wire a shade in front of the point upon which it is desired to have the instrument

point at the third stroke of the time-interval bell, so that when the traversing of the instrument is stopped on the third stroke of the bell the wire will be accurately on the center of the target, or point upon which it is desired to aim.

Observers should be familiar with every part of their instrument and capable of its perfect adjustment and care.

GUN POINTERS

Gun pointers should practice at every opportunity, what may be termed "continual aim." The difficulty of keeping the gun pointed or trained directly at the required point on the target can only be overcome by practice on the part of the gun pointer (and the traversing detail if the gun is not operated by electricity).

In vertical-base tracking they should keep the horizontal cross-wire of the sight constantly on the water line of the target, as explained in the article on position finders (see Chapter VII), and the vertical cross-wire slightly forward of the point it is desired to hit.

Care should be exercised in firing service charges, to give the command "Fire" (when not firing electrically) when the vertical cross-wire is a shade in advance of the point it is intended to hit, for the reason that there is an appreciable interval of time between the instant the command "Fire" is given and the instant the projectile leaves the muzzle, caused by the slow ignition of smokeless powder as well as the time incidental to the pulling of the lanyard. This interval is calculated at from one-sixteenth to one and one-quarter seconds, hence with a rapidly moving target a slight percentage of accuracy is lost.

When the gun is fired electrically the percentage of time lost is, of course, reduced to the interval consumed by the ignition of the powder.

In order that accurate results may be obtained gun pointers should be careful to fire the gun at the last stroke of the time interval bell following the range setter's announcement "Range Set," as the calculations are based on the projectile leaving the muzzle at that instant.

RANGE SETTERS

The principal duty of the range setter is the accurate setting of the range drum. He is responsible for the proper elevation or range of the

piece. In case an observation is lost he sets the gun at the range called to him by the operator at the time-range board.

In setting for elevation, the effects of backlash are practically eliminated if the graduation is always approached from the same direction—that direction which depresses the piece being the best.

METEOROLOGICAL OBSERVERS

The meteorological observer is responsible for the care and adjustments of all instruments and equipment installed at the meteorological station.

Upon his arrival at the station he reports his presence to the battle commander's station. He then adjusts the mercurial barometer by means of the adjusting screw which lowers the mercury in the cistern and then raises it until the surface exactly touches the ivory point. He then tests the aneroid barometer by carefully comparing its reading with the mercurial barometer in order to determine the proper correction to be applied for instrumental error and then notes the corrections to be made if any. He then connects the electrical device of the anemometer, adjusts the stop-watch device, if it is used in the station. He notes whether the wind-vane works freely. He tests and synchronizes the aeroscope. After satisfying himself that everything is in readiness he reports to the battle commander's station:

“Meteorological Station, In Order.”

He then immediately records on the aeroscope the azimuth of the wind as determined by the wind vane, and its velocity, as determined from ten readings of the anemometer; then reads the barometer and thermometer and records on the aeroscope the atmosphere per-cent. as determined from the atmosphere board.

The direction and velocity of the wind should be recorded at least every twenty minutes or oftener if necessary. Any sudden change either in direction or velocity of the wind of any considerable magnitude should be recorded and reported at once. The relative weight of the air should be recorded whenever it changes more than 1 per cent. He keeps a complete record of all messages.

Meteorological observers should study carefully the description, etc., of instruments appertaining to the station which appears in another part of this book.

TIDE OBSERVERS •

The tide observer is responsible for the care and adjustment of all equipment installed at the tide station.

Upon arrival at the station he first tests and synchronizes the aroscope, and sees that the tide-gauge is in proper order. After satisfying himself that everything is in order he reports to the battle commander's station:

“Tide Station, In Order.” •

He then records the height of tide on the aroscope and thereafter reports the tide for every half foot.

CAMP SANITATION

Deaths from sickness have outnumbered those of violence in all our wars. In the Philippines, in the eighteen months following July 1, 1898, 36 officers and 489 men were killed in action or died of wounds, while 16 officers and 693 men died of disease.

Coast artillery camps are practically permanent and have the advantage of being pitched near tide or salt water. They have more or less permanent drainage and are usually adjacent to permanent military hospitals. All these features facilitate proper sanitation. They do not necessarily conduce to the health of troops, however, unless their features are developed by the constant efforts of the officers in immediate control of troops. The importance of such officers making every effort to compel soldiers to comply with the laws of sanitation is emphasized when it is remembered that the whole military fabric rests upon the physical character of the individuals composing it.

Coast artillery camps should be as widespread as tactical considerations and convenience to the batteries will permit.

The health of all camps depends fundamentally upon: (1) food, (2) water supply, (3) disposal of excreta, (4) absence of flies and other germ-carrying insects, and (5) personal cleanliness.

Field cooking is of the utmost importance to the health and contentment of a command. It is useless to expect men, however well equipped, to keep the field with vigor if they cannot subsist on the food supplied. Officers should personally inspect each meal and satisfy

themselves that the food is properly cooked and served in the proper proportion.

Civilian cooks of militia companies should be informed when employed that they will be required to *submit to daily inspection as to the cleanliness of their persons, underclothing, etc.* The cleanliness of these cooks should be a charge of the company officers, for it is a well-known fact that civilian cooks and their assistants are usually the most unkempt individuals in the camp, while, by reason of their occupation, they should be the cleanest and neatest in appearance.

The water supply should be given careful study, and under-drainage procured if possible. Proper drainage is an important element in connection with the health of troops.

Constant endeavor should be made to prevent flies from carrying contagion from the sinks to the food. Burning a little mineral oil in the sinks and metal garbage cans helps keep down the flies. Garbage cans should, when practicable, be placed in a shaded place. Tightly fitting covers are absolutely necessary. Lime when issued should be sprinkled freely about the cans, and after emptying, lime should cover the bottom of each can. All refuse should be burned and particular care exercised to keep the camp clear of horse manure, which is a rapid breeder of flies.

Company kitchens should be the special care of the officers of each company, who should visit them frequently and insist upon absolute cleanliness of every part thereof. They should be well screened with wire netting. All food should be kept constantly covered, and when no ice is provided the meat ration should be cooked as soon as received. When ice is issued or provided the meat ration should not be allowed to remain uncooked for over five hours after issue.

The only practical way of ridding kitchens and mess shacks of flies is to starve them, and this can only be accomplished by keeping the shacks barren of food particles. Orders should be issued prohibiting the throwing of food of any character on the ground, and severe punishment follow any infraction of the order. Mess tables should be cleaned or washed of all crumbs and refuse immediately after each meal and the ground about the mess tables raked and cleaned of all crumbs, etc.

The latrines should be kept scrupulously clean and well supplied with paper and lime. They should be under the charge of an enlisted man held responsible for their condition during his tour of duty. This detail should be indeterminate in duration, that is, any man found or reported breaking any of the rules governing the latrines should

be assigned immediately to the work of keeping them clean, such assignment continuing until some other man is found to have transgressed the rules.

Tents should be ditched as soon as they are pitched. No circumstance, even that of extreme fatigue, should be allowed as an excuse for omitting this important part of the proper pitching of tents. The ditch should be dug around each tent and should be shallow; the earth taken out being banked on the inner side, so that the wall of the tent will fall over the mound. The ditch should empty into a company ditch arranged for a careful system of drainage.

Tent walls should be raised for several hours each day and all bedding and other contents exposed to the sun. If board floors are used, the boards should be loose and removed frequently and the ground beneath them cleaned and aired. In the case of conical tents they should be unfastened daily and folded loosely about the center pole so that the ground or flooring is exposed to the sun.

When practicable tents should be pitched at such a distance apart as to have adjacent to each an equal unoccupied area, so that their position can be changed from one site to the other once each week.

The Conical Wall Tent contains a floor space of 212 square feet; air space, 1450 feet; allowance, 20 foot soldiers, comfortable for about half that number. When cots are used 6 men can be accommodated.

The Wall Tent contains a floor space of 81 square feet; air space, 500 feet; usually used for one or two officers.

The Common Tent contains a floor space of 57 square feet; air space, 250 feet; allowance 6 foot soldiers, comfortable for half that number.

Mosquito netting is a required sanitary precaution against malaria where the anopheles mosquito is found and is still more important against yellow fever within the habitat of the *stegomyia fasciata*. In such regions its careful use should be enforced as a matter of routine discipline.

Men should be required to keep the hair short and the teeth clean; to bathe daily the head, feet, armpits, groins, anus, and genitals.

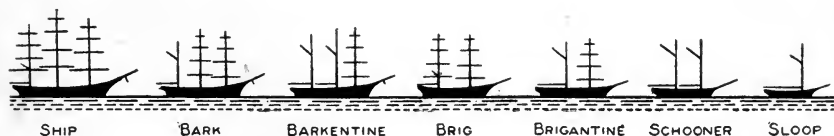



BATTLESHIP



PROTECTED CRUISER

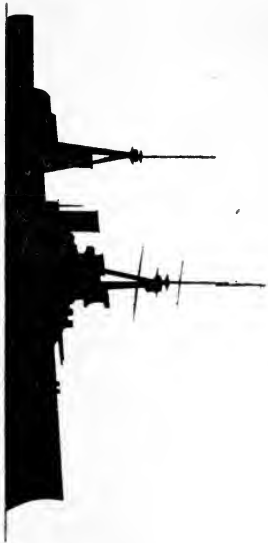

CRUISER-BATTLESHIP



TORPEDO BOAT DESTROYER



TORPEDO BOAT



ARMORED CRUISER



SUBMARINE BOAT
(emerged)

INDEX

(Numbers refer to pages.)

- "A" row, 1, 79.
- Abatis, 1.
- Abbreviations, 63.
- Absolute deviation, 1.
- Accumulator room, 1.
- Accuracy of D. P. F., 311.
 - of fire and practice, 100, 521.
- Adjutant, 1.
- Administrative organization, 76.
- Aeroscope, 1, 343, 344.
- Aiming, 1, 99.
- Air spaces, 1.
- All-round-fire, 1, 188.
- Ammunition, 1, 245, 491.
 - hoist, 1.
 - recess, 1.
 - shoes, 2.
 - truck, 2, 510.
- Anemometer, 2, 356.
- Aneroid barometer, 2, 355.
- Angles, etc., 106.
 - acute, 106.
 - biting, 95.
 - clear, 502.
 - equilateral, 106.
 - isoscceles, 106.
 - obtuse, 106.
 - of departure, 2, 96.
 - of depression, 96.
 - of elevation, 22, 502.
 - of fall, 2, 96, 502.
 - of impact, 2, 95.
 - of incidence, 2, 95.
 - of jump, 2, 95.
 - of position, 2, 96.
 - quadrant, 2, 95, 96, 395.
 - right, 106.
 - scalene, 106.
 - striking, 2, 95, 96, 274.
- Angular elevation or depression, 2, 95,
 - 96, 395.
- Angular velocity, 2.
- Approaches, 2.
- Apron, 2.
- Arbitrary correction, 531.
 - deflection board, 340.
 - rapid-fire guns, 531.
- Arc, 2.
- Area, 2.
- Armament, 2, 107.
 - intermediate, 32, 133.
 - primary, 45, 108.
 - secondary, 52, 155.
- Armor, 2.
 - belt, 2.
 - piercing projectiles, 3, 274.
- Armstrong guns, 3.
 - 4.72-inch, 153.
 - 6-inch, 133.
- Artillery, 3.
 - garrison, 5.
- Artillery district, 3.
 - adjutant, 3.
 - commander, 3.
 - commander's flag, 26.
 - engineer, 21.
 - ordnance officer, 4.
 - quartermaster, 4.
- Assembling breech mechanism:
 - 12-inch gun, see 10-in. G.
 - 12-inch mortar, 118.
 - 10-inch gun, 124, 130.
 - 8-inch gun, see 10-in. G.
 - 6-inch gun, 142, 147.
 - 5-inch gun, 152.
 - 3-inch gun, 159, 162.
 - 2.24-inch gun, 167, 171, 176.
- Assistant plotter, 78.
- Attacks from sea, 68.
 - night, 74.
- Atmosphere board, 5, 358.
- Automatic firing, 5.
 - machine guns, 5.
- Auxiliary:
 - horizontal base system, 5.
 - power plant, 5.

- Axial vent, 5.
 Axis, 5.
 of gun, 5.
 of trunnions, 5.
 Azimuth:
 correction scale, 317
 determination of, 440.
 difference, 5.
 instrument, 5, 314.
 of a point, 5.
 of wind, 62, 98, 341.
 setter, 5.

 "B" row, 5, 79.
 Backlash, 5.
 Bale, 5.
 Ballistic board, 5.
 corrections, 533.
 coefficient, 97.
 formulas, 101, 104.
 symbols, 101.
 tables, 5.
 Ballistics, 6, 79.
 exterior, 79, 93.
 interior, 79, 89.
 Bandoleer, 6.
 Banjo, 112.
 Banquette, 6.
 tread, 6.
 Bar and drum sight, 6, 133, 360.
 Barbette, 6.
 carriages, 12, 188.
 Barometer, 6.
 aneroid, 355.
 mercurial, 354.
 Base-end stations, 6.
 Base:
 fuse, 6, 290.
 line, 6, 432.
 ring test, 506.
 Battery, 6.
 commander, 6, 504.
 commander's action, 499, 534.
 commander's station, 7.
 commander's walk, 7.
 emplacement book, 7.
 field of fire, 7.
 fire control, 25.
 in commission, 31.
 in service, 31.
 location of, 431.
 manning table, 7.
 out of commission, 40.
 out of service, 40.
 parade, 7.

 Battery, subcaliber practice, 186, 534.
 target practice, 504, 533.
 Battle:
 area, 7.
 chart, 7.
 command, 8, 496.
 command drill, 496.
 commander, 8, 496.
 commander's station, 8.
 flag, 8.
 ships, 8.
 tactics, 9.
 Berm, 9.
 Bevel gear, 106.
 wheel, 9.
 Biting angle, 95.
 Bivouac, 9.
 Black charcoal powder, 245.
 prismatic powder, 250.
 Blank ammunition, 260, 492.
 Blank charges:
 weight of, 262.
 Blast slope, 9.
 Blasting gelatine, 9, 269.
 Blending powder, 9, 258, 512.
 room, 9.
 Blind shell, 9.
 Blocks and tackles, 470.
 Boat drill, 428.
 Boat telephone, 9, 423.
 Bomb, 9.
 proof, 9.
 Book, emplacement, 22.
 Booth, 9, 510.
 Bore, 9, 82, 510.
 bottom of, 9.
 length of, 9, Chap. V.
 plug, 9.
 sighting, 9, 454, 506.
 Bound, 9.
 Bourrelet, 9, 511.
 Brackets, 9.
 Breech, 9.
 block, 10, 82, 509.
 bushing, 10, 79.
 detail, 10.
 face of, 10.
 plate, 84.
 recess, 10, 80.
 reinforce, 10, 80.
 Breech mechanisms, 10, 82.
 Driggs-Schroeder, 173.
 Drop-block system, 164.
 Interrupted screw, 82, 120.
 Interrupted thread, 169.

- Breech Mortar, 112, 113.
 Stockett, 126.
 6-in. Q. F. Armstrong, 133.
 6-in. R. F. G., M. 1897 Mr, 136.
 6-in. R. F. G., M. 1903, 143.
 5-in. R. F. G., M. 1897, 149.
 4.72-in. Q. F. Armstrong, 153.
 3-in. D.-S. G., M. 1898, 155.
 3-in. R. F. G., M. 1902, 160.
 2.24-in. D.-S., M. 1898, 164.
 2.24-in. D.-S., M. 1900, 168.
 2.24-in. Am. Ord., 173.
- Brown charcoal powder, 250.
 prismatic powder, 10, 251, 256.
- Brown & Sharpe micrometer, 389.
- Buffer valve, 227.
- Building-up charges, 10, 257, 258, 512.
- Built-up cannon, 10, 80, 86.
- Buoy, 10.
- Bursting charge, 10, Chap. V.
- Butt, 10.
- Button-drill primer, 10, 282.
- "C" row, 10, 79.
- Cake powder, 10, 248, 249.
- Caliber, 10.
- Calibration, 10, 524.
- Call to arms, 11.
- Cam wheel, 106.
- Cam lever grip, 106.
- Camera, 526.
- Camp sanitation, 545.
- Cannister, 11, 278.
- Cannon, 11 (see Guns).
 ball, 11.
 powder, 11.
- Cannonade, 11.
- Cannoneer, 11.
- Canopy, 11.
- Cap-square, 11, 111.
- Capital, 11.
- Capped projectile, 11, 272.
- Carriages, 11, 187.
 A. R. F., 188.
 barbette, 12, 188.
 barbette proper, 188.
 casemate, 12, 188.
 coast, 12, 187.
 disappearing, 12, 188, 199.
 fixed, 12, 187.
 L. F., 188.
 masking mount, 12, 188, 228.
 mortar, 188, 236.
 movable, 12, 169.
 pedestal mount, 188, 192.
- Carriages, parapet mount, 232.
 rapid-fire gun, 12, 160.
 recoil cylinders of, 204, 238.
 special, 188, 197.
 wheeled, 168.
- Cartridge, 12.
 bags, 12, 259.
 extractor, 12.
 for small arms, 491.
 room, 12.
- Case, 12.
- Case I, 12, 99.
 II, 12, 100.
 III, 12, 100.
- Casemate, 12.
 battery, 12.
 carriages, 188.
 electrician, 12, 78.
 officer, 13.
- Casernes, 13.
- Cast-iron shot, 13, 276.
- Castramentation, 13.
- Cathead, 13.
- Center of gravity, 13, 94.
 band, 13, 276.
 of cannon, 13.
 of impact, 13, 523, 530.
 pintle, 13, 188, 445.
- Centering slope, 13, 82.
- Centigrade scale, 353.
- Centrifugal force, 13, 295.
 fuses, 13, 295.
- Chamber, 13.
 powder, 44, 82.
 shot, 54, 82.
- Charcoal powder, 245.
- Charge, 13, 520.
- Charts, 13, 304.
 battle, 7.
 difference, 20.
 harbor, 30.
 powder, 45, 400.
 symbol, 56.
- Chase, 13, 82.
- Chassis, 13, 203.
- Chief-loader, 13, 78.
 of ammunition service, 14.
 of coast artillery, 14.
 of coast artillery's flag, 14.
 planter, 14, 78.
- Chronograph, 14.
- Chronometer, 14.
- Circle, 14, 106.
- Circuit-closer, 14.
- Circumference, 14.

- Civilian cooks, 546.
 Cleaner, 14.
 Clear angle, 502.
 Clinometer, 14, 506.
 rest, 14.
 Coast Artillery:
 board, 14.
 chief of, 14.
 company, 14.
 corps, 66, 76.
 fort, 15.
 garrison, 15.
 material, 15.
 memorandum, 505, 537.
 posts, 15.
 reserves, 15, 66, 76, 77, 494.
 supports, 15, 66, 76.
 Coast defense, 15.
 officer, 15.
 principles of, 66.
 ships, 15.
 theory of, 66.
 Coast Guard, 15.
 Coefficient, of efficiency, 90.
 of form, 98.
 of useful effect, 90.
 Collar, 15.
 Collimation, 33, 308.
 Colors, 15.
 of coast artillery corps, 15.
 on projectiles, 16, 276.
 Combination electric friction primer, 16,
 285.
 Combination fuse, 16, 297.
 Command:
 administrative, 76.
 appropriate to grade, 77.
 tactical, 76.
 Commands:
 of battery commander, 534.
 of battle commander, 497.
 of fire commander, 498.
 searchlight, 502.
 Commissary sergeant, 16.
 Common electric primer, 16, 282.
 friction primer, 16, 279.
 Communication officer, 16, 503.
 Communications, 17, 348, 503, 515, 541.
 Composite artillery type telephone, 17,
 346.
 Computer, 17.
 Concentric, 17.
 Conduits, wiring and illumination of car-
 riages, 226.
 Cone, 106.
 of dispersion, 17, 522.
 of spread, 17, 522.
 Conical, 17, 106.
 Console, 17, 106.
 Construction of batteries, 431.
 Contact firing, 17.
 Converted gun, 17.
 Cordage, 17, 460.
 Cordite, 256.
 Cored shot, 17.
 Corps of engineers, 431.
 Corrected range, 17.
 Corridor, 17.
 wall, 17.
 Counter, attack, 17.
 recoil, 17.
 recoil springs, 240.
 recoil systems, 194, 204, 240, 508.
 Countermining, 17.
 Counterscarp, 17.
 Counterweight, 17, 209.
 well, 18.
 Cover post, 18.
 Cradle, 18.
 Crane, 18.
 Critical dimension, 18, 91.
 Crest:
 exterior, 24.
 interior, 32.
 Cross-fire, 18.
 Crosshead guides, 203.
 Crow's nest, 18.
 Cruiser, 18.
 Cruiser battleship, 18.
 Crusher gauge, 18, 90, 396, 528.
 Curvature of earth, 18, 95, 96, 313.
 Curve, 18.
 of trajectory, 95, 96.
 Curves, range board, 333, 514.
 Cut-off jack set, 18, 504.
 Cylindrical, 19, 106.
 Cylindro-conical, 19, 106.
 "D" row, 19, 79.
 Danger, range, 19.
 space, 19.
 Data line, 19.
 Datum point, 19, 308.
 Defense, of coast line, 66.
 land, 73.
 of harbors, 66.
 plans, 28, 494.
 zones, 62.
 Definitions, 1.
 Reflection, 19.

- Deflection board (gun), 19, 338, 515.
 board (mortar), 340.
 computer, 78.
 corrections, 338, 340, 505, 515, 532.
 scale, 19.
 value in yards, 533.
- Delayed automatic firing, 19.
- Delivery table, 19.
- Density of air, 97.
 of loading, 19, 93, 517, 528.
- Department artillery officer, 19.
 commander, 19.
 commander's flag, 19.
- Depression position finder, 19, 304, 513.
 description of W. & S., 304.
 description of Lewis, 312.
 system, 304.
- Derricks, 476.
- Determining true azimuth, 440.
- Detonation, 20.
- Detonating fuses, 302.
- Deviation, 20.
 absolute, 20.
 at target, 20, 525.
 mean lateral, 20.
 mean longitudinal, 20.
 range, 20.
- Device, obturating, 35, 115.
- Diameter, 20.
- Difference chart, 20.
- Direct fire, 20.
- Directing, gun, 20, 437.
 point, 20, 437.
- Disappearing carriage, 20, 199.
- Dismounting breechblock:
 12-in. gun (see 10-in. gun).
 12-in. mortar, 117.
 10-in. gun, 124, 129.
 8-in. gun, 82.
 6-in. gun, 142, 147.
 5-in. gun, 152.
 3-in. gun, 159, 162, 163.
 2.24-in. gun, 167, 172, 175.
- Displacement, 20.
 gun, 29.
 of any point, 20.
 of ships, 20.
- Distribution box, 20, 422.
- District, (see Artillery district).
 artillery engineer, 21.
 commander, 4.
 drill, 21.
- Ditch, 21.
- Double:
 primary station, 21.
- Double secondary station, 21.
- Drift, 21.
 corrections, 338.
- Driggs-Schroeder R.-F. gun, 21, 155.
- Driggs-Seabury R.-F. gun, 21, 155, 163,
 168, 232.
- Drill, 494.
 primer, 21, 282.
 regulations, 494.
- Dry gun cotton, 263.
- Dummy charge, 516.
 projectile, 510, 516.
- Dunnite, 21.
- Dynamite, 21, 267.
- Earthworks, 21.
- Ecrasite, 21, 266.
- Eight-inch gun, 21, 132.
- Elasticity, 21, 87.
- Electric ballistic machine, 14.
 controllers, 223.
 firer, 21.
 motors, 219, 223.
 mines, 21, 414.
 primer, 21, 282.
 safety firing attachment, 218.
- Electrical:
 elevating and depressing, 226.
 retracting, 226.
 traversing, 225.
- Electrician:
 casemate, 78.
 detachment, 21.
 master, 78.
 sergeant, 22, 78.
- Elements of trajectory, 93, 95, 96.
- Elevating system, 200-507.
 friction device, 507.
- Elevation, 22, 502.
 quadrant, 47, 395.
 setter, 22.
 sight, 54, 359.
- Elliptical, 22.
- Elongated projectiles, 22, 274.
- Emergency position finder, 22.
 station, 22.
 system, 22.
- Emplacement, 22.
 book, 22.
 booth, 510.
 officer, 22, 534.
- Encampment, 545.
- Endurance of cannon, 23.
- Energy of projectile, 23, 104, 272.
 of recoil, 23.

- Enfilade fire, 23.
 Engineer, 23, 78.
 Engineer corps, 431.
 Engineering, seacoast, 431.
 Engineer's transit, 314.
 Equalizing pipes, 23, 204, 238.
 Erosion of the bore, 23, 109, 112.
 Estuary, 23.
 Exploder, 23.
 Exploders or detonators, 270.
 Explosive, 23.
 compound, 24, 251.
 "D", 24, 268.
 house, 24.
 mixture, 24, 251.
 Explosives, 245.
 atlas powder, 268.
 black charcoal powder, 245.
 black prismatic powder, 250.
 blasting gelatine, 269.
 brown charcoal powder, 250.
 brown prismatic powder, 251, 256.
 charcoal powder, 245.
 cordite, 256.
 dynamite, 267.
 ecrasite, 266.
 fulminates, 245, 270.
 giant powder, 268.
 guncotton, 263.
 high, 245, 263.
 Judson powder, 268.
 low, 245.
 lyddite, 266.
 maximite, 269.
 melinite, 266.
 melting, 266.
 nitrocellulose powder, 251.
 nitroglycerine, 265.
 picric acid, 266.
 rendrock, 268.
 shimose, 266.
 smokeless, 251.
 sphero-hexagonal, 55, 250.
 thawing, 266.
 trinitrotoluol, 269.
 vulcan powder, 268.
 Exterior crest, 24.
 slope, 24.
 Extreme range, 24.

 Face of breech, 24.
 of muzzle, 24.
 of rimbase, 24.
 of trunnion, 24.
 Fahrenheit scale, 353.

 Field, combat, 73.
 of fire, 24.
 safety of, 500.
 Fifteen-pounder, 24, 155, 162.
 Fillet, 24.
 Final velocity, 24.
 Fire, 24.
 accuracy of, 100.
 all-round, 1, 188.
 aréa, 24.
 in field combat, 74.
 limited, 33, 188.
 observation of, 531.
 orders of, 499.
 rate of, 49.
 restricted, 499.
 unrestricted, 499.
 Firearm, 26.
 Fire command, 25, 497.
 grouping batteries of, 431.
 target practice (service), 497.
 Fire commander, 25, 497, 518.
 appropriate rank of, 78.
 assignment of, 25.
 commands of, 497.
 duties of, 25.
 Fire commanders, 497.
 action, 498.
 plotting board, 330.
 station, 25.
 supervision of target practice, 500.
 Fire control, 25.
 apparatus and instruments, 304.
 installation, 26.
 range officer, 537.
 system, 26.
 Fire left, 26.
 right, 26.
 Fired standard primer, 26, 282.
 Firing attachment, 218, 509.
 interval, 26.
 machine, 26.
 mechanism, 174, 176, 183.
 switch, safety, 219.
 First-class gunner, 30, 78.
 First sergeant, 78.
 Five-inch gun, 26, 148.
 Fixed ammunition, 26, 261, 491.
 armament, 26.
 defenses, 26.
 light, 26.
 mount, 26, 188.
 Flag:
 battle, 8.
 garrison, 28.

- Flag of admiral of the navy, 26.
 of artillery district commander, 26.
 of assistant secretary of the navy, 26.
 of assistant secretary of war, 26.
 of chief of coast artillery, 26.
 of department commander, 27.
 of post commander, 27.
 of president of the U. S., 27.
 of rear-admiral of the navy, 27.
 of the secretary of the navy, 27.
 of the secretary of war, 27.
 of the U. S., 27.
 of vice-admiral of the navy, 27.
 post, 44.
 storm, 55.
 submarine boat signal, 56.
- Flags, 27.
- Flagship, 27.
- Flanking fire, 27.
- Floating defenses, 27.
- Focussing telescope, 306.
- Foot-ton, 27.
- Force of gravity, 93.
- Forcing, 27.
 cone, 27, 82.
- Formulas, ballistic, 101.
- Fort commander, 27.
 record book, 27.
- Fortified point, 28.
- Fosse, 28.
- Four-inch gun, 28, 155.
- Four point seventy-two-inch gun, 3, 153.
- Friction, 28.
 clutch, 213.
 primer, 28, 279.
- From battery, 28.
- Front pintle, 28, 188, 445.
- Frontal attack, 68.
 fire, 28.
- Frustrum, 28.
- Fulcrum, 28.
- Fulminate, 28, 270.
- Fuses, 28, 290.
 base, 290
 combination, 297.
 detonating, 302.
 point, 290.
- Gabion, 28.
- Gallery, 28.
- Galvanometer, 28.
- Garrison, 28.
 coast artillery, 15.
 flag, 28.
 gin, 28.
- Gas-check pad, 28, 84.
 seat, 82.
 adjustment of, 183.
- Gear wheel, 28, 106.
- General defense plans, 28, 494.
 principles, 66.
- Geometrical magnitudes, etc., 106.
- Gins, 472.
- Glacis, 29.
- Gravemetric density, 29.
- Gravity, 29, 94.
- Graze, 29.
- Grooves, 29, 87.
- Grouping batteries, 431.
- Guard room, 29.
- Gun, 29, 79.
 16-inch, 108.
 14-inch, 109.
 12-inch, 110, 111, 112.
 10-inch, 120.
 8-inch, 80, 132.
 6-inch, 133, 136.
 5-inch, 148.
 4.72-inch, 153.
 4-inch, 155.
 3-inch, 155, 162.
 2.24-inch, 163, 164, 168, 172
 1-pounder, 184.
 6-pounder, 163, 164, 168, 172.
 15-pounder, 155, 162.
 arm, 317.
 automatic, 5.
 boat, 29.
 carriage, 29.
 center, location of, 437.
 commander, 29, 78.
 commander's range scale, 29.
 company, 29.
 construction, 79, 107.
 cotton, 29, 263.
 deflection board, 338.
 differences, 29.
 displacement, 29.
 lift, 29.
 machine, 5, 34.
 platform, 29.
 plotting board, 315.
 pointer, 29, 78, 543.
 powder, 30, 245.
 section, 30.
 semi-automatic, 53.
 sling, 490.
 sub-caliber, 184.
 wire-wound type, 107.
- Gunner, 30, 78.

- Gunner's quadrant, 30, 393.
 Gunnery, 30, 79.
 specialists, 30.

 Hang fire, 30.
 Harbor, charts, 30.
 defense, 66.
 Height of D. P. F., 311.
 High-angle fire, 30.
 Hitches, 468.
 Hoist, 30.
 ammunition, 1.
 powder, 45.
 room, 30.
 shot, 1.
 Homogeneous, 30.
 Hoop, 30, 79.
 Horizontal, 30.
 angle, 31.
 base-line measurement, 432.
 base system, 31, 311.
 plane, 31.
 position finder, 31, 304, 312.
 range, 31.
 velocity, 31.
 Hostilities, 31.
 Howitzer, 31.
 Hydraulic jack, 31, 479.
 Hydrographic surveying, 458.
 Hygrometer, 31.
 Hypothetical targets, 31.

 Identification of target, 31, 503.
 Igniter, 31.
 charge, 31, 259.
 Igniting primer, 31, 289.
 Illuminating light, 31, 402.
 Illumination, conduits and wiring, 226.
 In battery, 31.
 In commission, 31.
 Independent action, 499.
 Indication of target, 31, 503.
 Indicator:
 aeroscope, 343, 344.
 tide, 304.
 wind component, 341.
 Infantry, 73.
 Inflammation, 31.
 Initial pressure, 31.
 of rotation, 32.
 of translation, 32.
 velocity, 32.
 Inner defense zone, 62.
 In service, 31.

 Inside of a beam, 32.
 Instruments, 304.
 Intelligence line, 32, 535.
 Interior crest, 32.
 slope, 32.
 wall, 32.
 Intermediate armament, 32, 133.
 Interruption, 345, 515.

 Jacket, 32, 79.
 Judgment firing, 32.
 Jump, angle of, 32, 95, 507.
 Junction box, 32, 423.

 Kentledge, 33.
 Knots, 467.
 Laffin & Rand firing machine, 33.

 Land attack, 73, 74, 75, 500.
 defense, 73, 500.
 front, 33.
 Landings, 70.
 Lands, 33, 88.
 Lanyard, 33, 217.
 Large caliber guns, 33, 107.
 Lateral, 33.
 Latrine, 33.
 Laying, 33, 99.
 Least dimension, 33, 91.
 Le Boulenger chronograph, 33.
 Length of the bore, 33.
 Leveling, 455.
 Levers, 472.
 Limited fire, 33, 188.
 Limits of fire, 33, 62.
 Line, 33.
 of collimation, 33, 308.
 of defense, 33.
 of departure, 33, 95, 102.
 of direction, 34, 95.
 of impact, 34, 95.
 of metal, 447.
 of shot, 34, 95.
 of sight, 34, 95.
 Litmus, 34.
 paper test, 34.
 Loading:
 density of, 19, 93, 517, 528.
 mines, 421.
 platform, 34.
 position, 34.
 projectiles, 378.
 room, 34, 417, 424.
 tray, 34.

- Location:
 of batteries, 431.
 of horizontal base lines, 432.
 of pintle centers, 438.
 of target, 34.
 "Long nose" projectiles, 274.
 Long roll, 34.
 Longitudinal, 34.
 Lot number, 256.
 Lug, 34.
 Lyddite, 34, 266.
- Machine gun, 34.
 mounts, 34.
- Machinery, care of, 424, 481.
- Magazine rifle, 483.
- Magazines, 35, 525, 527.
- Main bore, 35, 82.
- Maneuver signals, 539, 540.
- Maneuvering rings, 35.
- Manning parties, 35.
 tables, 35.
- Mark one, 35, 110.
- Marine obstructions, 35.
- Masking mount, 35, 228.
- Master electrician, 35, 78.
 gunner, 35, 78.
- Material target, 35.
- Maul, 35.
- Maximite, 35, 269.
- Maximum, 36.
 ordinate, 36, 95.
 pressure, 36.
 range, 36, 107.
- Mean lateral deviation, 36.
 longitudinal deviation, 36.
- Measure of uniformity, 36.
- Mechanic, 36, 78.
- Mechanics, 36, 106.
- Medium caliber guns, 36, 107, 133.
- Melinite, 36, 266.
- Melting explosives, 36, 266.
- Mensuration, 36.
- Mercurial barometer, 36, 35
 thermometer, 58, 354.
- Meteorological message, 36.
 observer, 36, 78, 544.
 station, 37, 544.
- Methods of pointing, 99.
- Micrometer, 37.
 caliper or gauge, 37, 396.
- Military crest, 37.
- Mine (submarine), 37, 414.
 field, 37.
 material, care of, 424.
- Mine, planter, 38, 422.
 plotting board, 328.
 prediction ruler, 329.
- Mine command, 37.
 boat drill for, 428.
 fire-command system, 417.
- Mine commander, 37, 414.
- Mine company, 37, 424.
- Mine-field lights, 37.
 officer, 38.
- Mining casemate, 38, 417.
- Minus correction, 38, 384.
 deflection, 38, 384.
- Misfire, 38.
- Miter wheel, 38.
- Moat, 38.
- Mobile, army, 67, 76.
 torpedo, 38, 414.
- Monitors, 38.
- Mortar, 38, 112, 119, 120.
 arm, 325.
 battery, 38.
 breech mechanism, 114.
 carriage, 236.
 cast-iron, 112.
 company, 38.
 deflection board, 340.
 pit, 38, 112.
 plotting board, 324.
 predicter, 326.
 steel, 119.
 velocities, 327.
 wire-wound type, 107.
 zones, 62, 327.
- Motor generator, 224.
- Motors, 223.
- Mount (see Carriage), 38.
- Mounting cannon, 38.
- Movable armament, 39, 168.
 carriage, 39, 188.
- Multiplying scale, 338.
- Mushroom head, 39.
- Musician, 78.
- Muzzle, 39.
- Muzzle velocity, 39, 519.
 probable, for trial shots, 519.
 variations in, 519.
- Naval attack, 68.
- Night, attacks, 74.
 signals, 542.
- Nitrocellulose powder, 39, 251.
- Nitroglycerine, 39, 265.
- Non-commissioned officers, 39, 78.
- Nose, 39.

- Object glass, 39, 306.
 Oblique fire, 39.
 Observation, firing, 39.
 of fire, 531.
 telescope, 39.
 Observations with D. P. F., 310, 311.
 Observer, 39, 78, 535, 542.
 1st and 2d class, 78.
 meteorological, 78, 544.
 tide, 78, 545.
 tug, 536.
 Observing interval, 39.
 room, 39.
 station, 39.
 Obturating primer, 39, 274.
 Obturator, 39, 115, 509.
 head, 39.
 Occult light, 39.
 Offensive return, 39.
 Officers, points for, 494.
 Ogive, 40, 272.
 Oil room, 40.
 Oils, 40, 425.
 Okonite joint, 420.
 Omniscope, 40.
 One-pounder, 40, 184.
 Open sight, 40, 359.
 bar and drum, 6, 133, 360, 363.
 2.24-inch (6-pounder), 359.
 3-inch (15-pounder), 360.
 4-inch, 360.
 4.72-inch, 360.
 5-inch, 361.
 6-inch, 360.
 8-, 10-, and 12-inch, 361.
 Opposite angles, 40.
 Orderly, 78.
 Orders, 496.
 of fire, 40, 499.
 Ordnance, 40.
 machinist, 40.
 officer, 40.
 sergeant, 40.
 Organization and personnel, 76.
 Orientation, 40, 449.
 table, 40.
 Out of commission, 40.
 Out of service, 40.
 Outer defense zone, 62.
 Outposts, 40.
 Outside of the beam, 40.
 Overs and shorts, 527.

 Paint mixtures, etc., 425.
 Paints, oils, etc., 425.

 Paints on projectiles, 41, 276.
 Pantograph, 41.
 Parade slope or wall, 41.
 Parados, 41.
 Parallax, 41, 307.
 Parallel, 41.
 Parapet, 41, 533.
 Patrol boats, 41.
 Pawl, 41, 106.
 Pedestal mount, 192.
 Penetration of projectiles, 41, 109, 272, 273, 277.
 Percussion cap, 42, 287.
 fuse, 42, 291.
 primer, 42, 286.
 Periscope, 42.
 Permanent fortifications, 431.
 Perpendicular, 42.
 Personnel, 42, 76, 77, 515.
 Picket boats, 42.
 Picric acid, 42, 266.
 Piece (see Gun), 42.
 Pintle centers, location of, 188, 445.
 Pipe, equalizing, 23, 204, 238.
 Pit, 42.
 commander, 42.
 mortar, 112.
 Plan of land defense, 73.
 Plane, 42.
 of departure, 42, 95, 98.
 of direction, 42, 95, 98.
 of sight, 42, 95, 98.
 Plans, general defense, 28, 494.
 Planter, 42, 422.
 Planting mines, 422.
 section, 42.
 Platen scale, 338.
 Plotter, 42, 78, 535.
 Plotting board, 42, 314, 514.
 fire commander's, 328.
 gun, 315.
 mortar, 324.
 submarine, 328.
 Plotting room, 43.
 Plunging fire, 43.
 Plus correction, 43, 384.
 deflection, 43, 384.
 Point, 43.
 directing, 20, 437.
 fuse, 43, 290.
 of fall, 43, 93, 95, 96, 502.
 of impact, 43, 95.
 Pointing, 43, 99.
 Points for artillerists, 494.
 Polaris, 442.

- Position, angle, 43.
finder, 43, 304.
- Position-finding system, 43, 310, 311, 513.
- Post:
adjutant, 43.
artillery engineer, 43.
commander, 44.
commander's flag, 44.
commissary sergeant, 44.
flag, 44.
non-commissioned staff, 44.
ordnance officer, 44.
quartermaster, 44.
quartermaster sergeant, 44.
telephone switchboard, 44.
- Powder (see Explosives), 44, 512, 527.
blast, 44.
blending of, 258.
cases, 44.
chamber, 44, 82.
charges, table of, 255.
chart, 45.
chute, 45.
hoist, 45.
hoist well, 45.
magazine, 45.
power expansive force, 90.
room, 45.
section, 259.
test, litmus, 34, 104.
- Powder charge:
preparation of, 9, 258, 512, 517.
sections of, 259.
table of, 255.
weights of, 104, 259.
- Power and light equipment, 45.
room, 45.
section, 45.
station or plant, 45.
- Practice (see Target practice).
- Practice, accuracy of, 100.
- Predicted firing, 45.
point, 45.
time, 45.
- Predicting interval, 45.
- Predictor, 45.
- Preponderance, 45.
- Preparation of charges, 9, 258, 512, 517.
of paints, 425.
- Pressure cylinders, 45, 397.
- Pressure gauge, 45, 397.
- Primary arm-setter, 78.
armament, 45, 108.
station, 45.
- Primer, 46, 279.
- Priming charges, 46, 259.
- Principles of coast defense, 66.
- Prismatic powder, 46, 250, 251.
- Probability factors, 46.
of error, 46, 522.
- Probable error card, 522.
muzzle velocity, 519.
zone, 46, 522.
- Profile board, 46.
- Progressive powder, 46, 245.
- Projectile, 46, 93.
in the gun, 89.
in its flight, 93.
- Projectiles, 271, 511, 528.
armor piercing, 274.
capped, 273.
cast-iron, 276.
deck piercing, 274.
dummy, 510, 516.
energy of, 272.
filled and fused, 268, 278.
long nosed, 274.
painting of, 276.
penetration of, 41, 109, 272, 273, 277.
seating of, 516.
storage of, 278.
travel of, 59, 517.
- Projector, 46.
- Proof, of gunpowder, 46.
plug, 46, 396.
- Property officer, 46.
- Protractor, 47.
- Pyramidal target, 47.
- Quadrant, 47, 393, 509.
angle of departure, 47, 96.
elevation, 47, 395.
elevation scale test, 506.
- Quartermaster, 47.
sergeant, 47, 78.
- Quick-firing guns, 47, 133, 153.
- Quickness of burning, 47.
- Rack, 47.
- Radial vent, 47.
- Radius, 47.
- Rake (see Range rake).
- Rammer, 47, 517.
- Ramp, 47.
- Rampart, 47.
- Range, 47.
azimuth table, 48.
board, 48, 332, 514.
correction computer, 78.

- Range, corrections, 332, 514, 532.
 danger, 501.
 deviation, 48, 527.
 difference, 48.
 finder, 48, 304.
 finding system, 304.
 keeper, 48, 78.
 of a shot, 49.
 of ballistic tables, 48, 96.
 officer, 48, 515, 518, 535.
 rake, 48, 525.
 scale, 49.
 searchlight, 406.
 setter, 49, 78, 534.
 station, 518
 table, 49.
 Rapid-fire gun, 49, 142.
 carriage, 49, 192.
 Rate of fire, 49.
 Rated men, 78.
 Ratings, 49, 78.
 Reader, 49, 78.
 Rear slope, 49.
 Receiving table, 49.
 Recoil, 49.
 cylinders, 49, 189, 199, 508.
 systems, 194, 204, 238, 508.
 Reconnaissance, 49.
 in force, 49.
 Record practice, 505.
 Recorder, 49, 78, 498.
 Records of firings, 50, 528.
 Rectangular target, 50.
 Redoubt, 50.
 Reference numbers, 50.
 Reflected ray or beam, 404.
 Regulations, 50.
 Reinforce, 50.
 Relay, 50.
 Relocation of target, 50.
 Remaining velocity, 50.
 Reserve table, 50.
 Reserves, coast artillery, 15, 76, 77, 494.
 Resistance of the air, 50, 93.
 Restricted fire, 50, 499.
 Retardation, 50.
 Retractor, 50.
 Reverse fire, 50.
 Ricochet, 50, 501.
 Rifle (see also Gun), 50.
 Rifling, 51, 82, 87.
 twist of, 60, 87.
 Rimbases, 51.
 Ring resistance fuse, 51, 291.
 Roadstead, 51.
 Rocket, 51.
 Ropes, 460.
 Rotating band, 51, 82, 511.
 Rotation, 51.
 Rotation of projectile, 51.
 Round, 51.
 Roving light, 51.
 Row, 51.
 Rubber impression of bore, 51.
 Run by, 69.
 Safety-firing switch, 219.
 Safety lanyard, 51, 217.
 Safety officer, 501, 536.
 Salvo, 51.
 fire, 51, 499.
 point, 51.
 table, 51.
 Sanitation, 545.
 Scarp, 51.
 Scout ships, 51.
 Screw box, 51.
 Seacoast engineering, 431.
 Searchlight, 51, 402.
 arc, 410.
 area, 52, 402.
 carbons, 413.
 classification of, 407.
 commands, 502.
 effective ranges, 406.
 essentials of effectiveness, 412.
 lamp mechanism, 408.
 mirror, 411.
 nomenclature, 407.
 observer, 52.
 officer, 52.
 operator, 52, 78.
 range, 52, 406.
 tactical location, 402.
 types of, 404.
 tower, 52.
 watcher, 78, 406.
 Seat of the charge, 52, 517.
 Secondary armament, 52, 155.
 arm-setter, 78.
 or auxiliary power plant, 52.
 station, 52.
 Second-class gunner, 78.
 Sector of explosion, 53.
 Segment, 53.
 Self-contained horizontal position finder,
 53.
 Semi-automatic guns, 53.
 Separate observing room, 53.
 plotting room, 53.

- Sergeant-major, 53, 78.
 Service, charge, 53, 255.
 practice, 505.
 Serving table, 53.
 Serving the vent, 53.
 Set-back point, 53.
 Set-forward point, 53.
 Set-forward ruler, 53.
 Shears, 53, 474.
 Shell, 53, 274.
 armor piercing, 274.
 deck piercing, 274.
 filler, 54.
 room, 54.
 torpedo, 59, 275, 276.
 tracer, 54.
 Shimose powder, 54, 266.
 Shore signals, 538.
 Shot, 54, 274, 276.
 armor piercing, 274.
 cast-iron, 274.
 chamber, 54, 82.
 gallery, 54.
 hoist, 54.
 hoist well, 54.
 penetration of, 109, 277.
 room, 54.
 tongs, 54, 516.
 trucks, 192, 510.
 Shrapnel, 54, 278.
 Sights, 54, 168, 359.
 deflection, 54.
 elevation, 54.
 standard, 54, 506.
 telescopic, 57, 168, 361.
 Signal rocket, 54.
 station, 54.
 Signals, at target practice, 538.
 Signs, 65.
 Six-inch gun, 54, 133, 136.
 Six-pounder, 54, 163.
 Small arms, 483.
 ammunition, 491.
 boats, 54, 427.
 caliber guns, 54, 155.
 landing parties, 75.
 Smokeless powder, 54, 251.
 Smooth-bore cannon, 54.
 Sound, signals, 540, 541.
 travel, 55.
 Sources of error, 505.
 Special mounts, 197.
 Specific gravity, 55.
 Sphero-hexagonal powder, 55, 250.
 Splices, 462.
 Spline, 55, 106.
 Sponge, 55.
 Sprocket wheel, 55, 106.
 Spur ring, 55.
 wheel, 55, 106.
 Staff officers, 55, 77, 78.
 Stand fast, 55.
 Standards, 55, 506.
 Star gauge, 55.
 Storage magazine, 55.
 Storehouse, 55, 424.
 Storeroom, 55, 421.
 Storm flag, 55.
 Strategy, 55.
 Strength, 55.
 Striking, angle, 55, 95, 274.
 energy, 55.
 velocity, 55, 102.
 Subcaliber:
 ammunition, 255.
 gun, 184, 187.
 platform, 55.
 practice, 186.
 quadrant scale, 56.
 tube, 56, 184.
 Submarine:
 boat, 56.
 signal flag, 56.
 defense equipment, 56, 417.
 defenses, 56, 414.
 mine, 56, 414.
 plotting board, 328.
 Substitutes, 515.
 Superior slope, 56.
 Supplementary station, 56.
 Supports, coast artillery, 15, 66, 76.
 Surface, 56.
 Surveyor's transit, 56, 314.
 Swell of muzzle, 56.
 Switchboard panel, 224.
 Symbol charts, 56.
 Table of:
 angular distance of Polaris, 443.
 blank ammunition, 263.
 built-up charges, 257.
 civil dates or epochs, 442.
 deflections, 533.
 detonating fuses, 302.
 diameters of searchlight beams, 404.
 dimensions of powder sections, 259.
 effective searchlight ranges, 406.
 factor of year and latitude, 443.
 interchangeability of subcaliber guns,
 185.

- Table of, longitudinal deviations, 527.
 mortar zones and velocities, 327.
 muzzle velocities and pressures, 105,
 255.
 penetration, 277.
 powder charges, 255.
 triangulation data, 451.
 velocities and temperatures, 105,
 255.
 wind velocity, miles per hour, 358.
- Tackles, 57.
- Tactical:
 chain, 57.
 command, 57.
 divisions, 76.
 organization, 76.
 responsibility, 57.
- Tactics, 57.
- Take cover, 57.
- Tangent, 57, 106.
- Tangent of an arc, 57, 106.
- Tangential force, 57.
- Targ, 57, 321.
- Target, 57, 525.
 hypothetical, 31.
 identification of, 31, 503.
 indication of, 31, 503.
 material, 35.
 pyramidal, 47.
 vessel tracking, 57, 304.
- Target practice, 505.
 arbitrary deflection correction, 531.
- Team work, 505.
- Telautograph, 57, 345.
- Telephone, 57, 346, 515.
 operator, 78, 348, 503, 515, 541
- Telegraph joint, 419.
- Telescope, adjustment of, 306.
 leveling, 305.
 orientation of, 308.
- Telescopic sights, 57, 168, 361.
 adjustments, 373, 385.
 adjustments at forts, 392.
 care of, 374.
 for disappearing carriage, 371.
 for rapid-fire guns, 362.
 method of assembling, 372.
 Scott, 375.
 use in gun laying, 384.
- Ten-inch gun, 57, 120.
- Tents, 547.
- Terrain, 57.
- Thawing explosives, 58, 266.
- Theater of operations, 58.
- Thermometers, 58, 353.
- Theoretical range, 58.
- Theory, and principles, 66.
 of probability, 58.
- Three-inch gun, 58, 155.
- Throttling bar, 58, 194, 204, 238.
- Tide gauge, 58.
 indicator, 58.
 observer, 545.
 station, 58, 545.
- Time, fuse, 58, 297.
 interval bell, 58, 343, 513.
 interval clock, 343, 515.
 interval recorder, 58, 357.
 of flight scale, 58, 332, 514.
 range board, 58, 398.
- Tool room, 59.
- Torpedo, 59.
 boat destroyers, 59.
 boats, 59.
 detonating Pierce fuse, 59, 302.
 shell, 59, 275, 276.
- Towing target, 59, 536.
- Tracer, shell, 54
- Tracking, 59, 323.
- Trajectory, 59, 93, 95, 96.
 rigidity of, 96.
- Transit instrument, 59, 314.
- Travel of projectile, 59, 517.
 of target, 59.
- Traverse, 59.
 slope or wall, 59.
- Traversing, speed of, 225.
- Traversing indicator, 60.
 mechanism, 187, 508.
- Tray, 60.
- Trial shots, 60, 520, 529, 530.
- Triangulation of base lines, etc., 437.
- Trinitrotoluol, 60, 269.
- Tripping, 60.
- Trolley, 60.
- Truck:
 ammunition, 60.
 platform, 60.
 recess, 60.
- Trunnion, 60.
 band, 60.
 hoop, 80.
 sight bracket, 60.
- T-square scale, 338.
- Tube, 60, 82.
- Tug observer, 60, 536.
 officer, 60, 536.
 signals, 538.
- Turk's head, 418.
- Twelve-inch, gun 60, 110.

- Twelve-inch mortar, 60, 119.
 Twist of rifling, 60, 87, Chap. V.
 Union jack, 60.
 Unit, 61.
 Unrestricted fire, 61, 499.
 Velocity, 61, 105.
 corrections, 532.
 initial, 105.
 instrumental, 93.
 muzzle, 91, 93, 327.
 normal, 105.
 of combustion, 61.
 of rotation, 61.
 striking, 55, 102.
 table, 105.
 translation, 61, 93.
 trial shots, 529.
 variations in, 519.
 Vent, 61.
 Ventilators, 61.
 Vernier, 61.
 Vertex of angle, 61.
 Vertical, 61.
 angle, 61.
 base system, 61, 310.
 plane, 61.
 Vessel chart, 61.
 Vessel, symbols, 547.
 tracking, 61, 323.
 Vickers-Maxim gun, 61.
 Watchers, searchlight, 78, 406.
 Water front, 61.
 Weights:
 of guns, Chap. V.
 of powder charges, 259, 520.
 of projectiles, Chap. V., 520.
 Wheeled mounts, 61, 168.
 Wig-wag signals, 541.
 Winch, 61.
 Wind, component indicator, 62, 341.
 effect of, 98.
 vane, 62, 544.
 Wireless communications, 542.
 operator, 78.
 stations, 62.
 Wiring system of carriage, 227.
 Worm wheel, 62, 106.
 Xylol, 62.
 Zero, 62.
 Zone energy, 62.
 mort, 62.
 of fire, 62.
 Zones and velocities of mortars, 62, 327.



901325

2

U. C. BERKELEY LIBRARIES



C049728565

