

EX LIBRIS

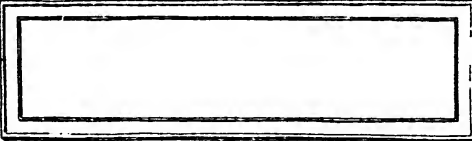

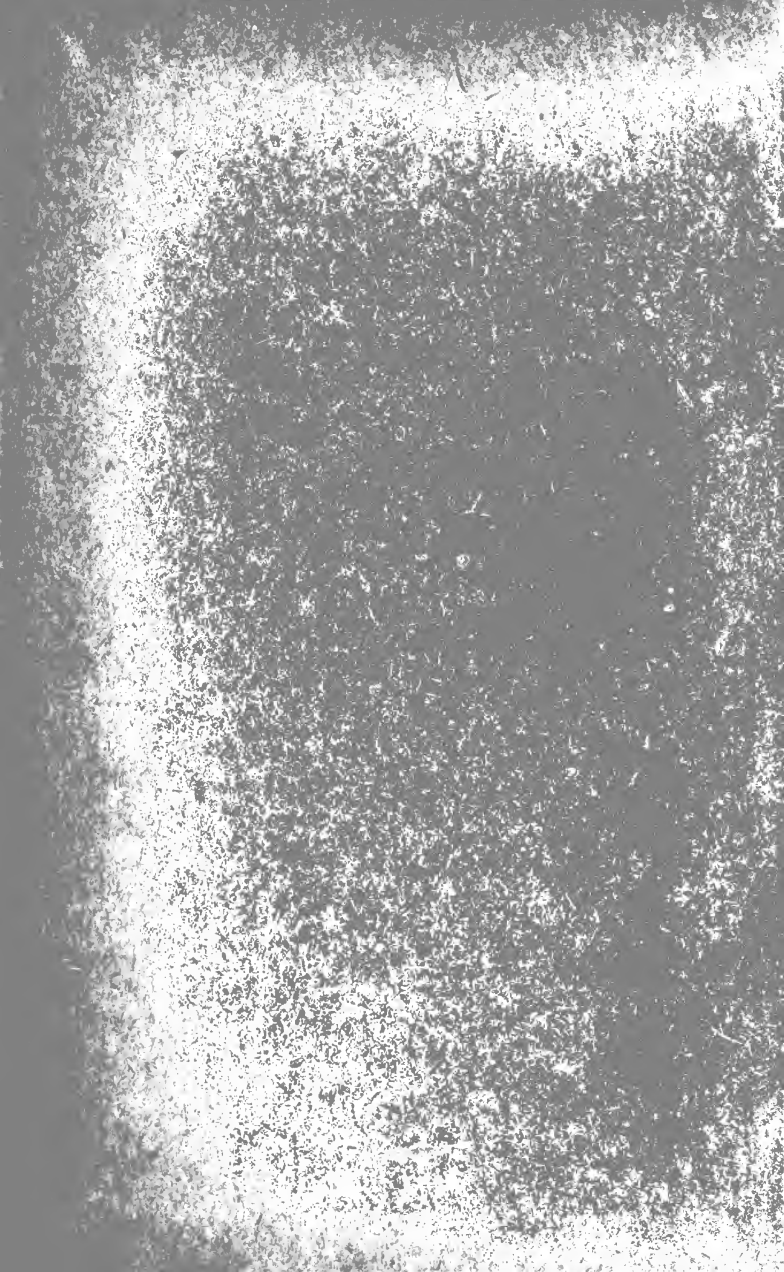



SHELTER AND CLOTHING



THE MACMILLAN COMPANY
NEW YORK · BOSTON · CHICAGO · DALLAS
ATLANTA · SAN FRANCISCO

MACMILLAN & CO., LIMITED
LONDON · BOMBAY · CALCUTTA
MELBOURNE

THE MACMILLAN CO. OF CANADA, LTD.
TORONTO





ELLEN H. RICHARDS

(1842-1911)

For forty years leader in the Home Economics Movement

SHELTER AND CLOTHING

A TEXTBOOK OF THE HOUSEHOLD ARTS

BY

HELEN KINNE

PROFESSOR OF HOUSEHOLD ARTS EDUCATION

AND

ANNA M. COOLEY, B.S.

ASSISTANT PROFESSOR OF HOUSEHOLD ARTS EDUCATION
TEACHERS COLLEGE, COLUMBIA UNIVERSITY

New York

THE MACMILLAN COMPANY

1913

All rights reserved

TX 145
K 5 / 5

THE
MATH
BOOK

COPYRIGHT, 1918,
By THE MACMILLAN COMPANY.
Set up and electrotyped. Published July, 1913.

Norwood Press
J. S. Cushing Co. — Berwick & Smith Co.
Norwood, Mass., U.S.A.

PREFACE

THIS book and the companion volume, *Foods and Household Management* by the same authors, are intended for the girl pursuing any type of high school or normal school course, as well as for the home maker. They cover the course in household arts for the general high school.

The authors feel that household arts in high schools should not be confined to problems in cooking and sewing. They are only a part of the study of home making. The questions of home organization, management, care, repair, home sanitation, and decoration, are also important, and should find a place in the household arts course of study in every high school.

The question of what to include in a general textbook has been a difficult one for the authors to answer because of the scope of the field of household arts. It has been planned so as to give the most helpful suggestions in relation to each subject.

This book deals with the home, its ideals in organization, its sanitation, decoration, and furnishing; also with the questions of textiles, sewing, and dressmaking. *Foods and Household Management* treats of the study of foods, their manufacture, composition, preparation, and serving, and the home problems of management, accounts, buying, housewifery, care and repair of household furnishings.

The authors wish to express thanks to those who have read and criticized the manuscript: Professor Warner, of Teachers College, for the chapters on home decoration and domestic architecture; Miss Laura I. Baldt and Miss Helen Donovan, of Teachers College, for the parts on sewing, garment making,

and dressmaking; Professor Fales, of Teachers College, and Miss Grace Nagle, for criticism of the chapter on history of costume; Mrs. William Buchner, for the chapter on the importance of dress; Mrs. Ellen Beers McGowan, of Teachers College, and Miss Charlotte Waite, of Kalamazoo Vocational School, Michigan, for reading parts in relation to textiles; Professor Vulté, of Teachers College, for criticism of the chapter on house sanitation; Mrs. Evelyn Tobey, for the chapter on millinery; the students of the costume design class at Teachers College, for the sketches in the chapters on dress.

SUGGESTIONS TO TEACHERS

THIS book is arranged topically. It is not, however, absolutely necessary to present the subjects in the order outlined. The class discussions and exercises in relation to home ideals, house sanitation, and decoration may be followed in sequence, while the study in textiles, sewing, and dressmaking may run parallel if desired. Most teachers prefer to outline their courses in Household Arts for the year in some such way, adapting the subjects to the needs of the girls, and arranging the topics so that there is sequence in the work presented during the four years of the high school course. Such teachers should be familiar with all the subjects offered in both volumes of this series, *Shelter and Clothing* and *Foods and Household Management*, and should select for daily study those parts that bear on the work of the school course for each year and each division of the year. Suggestions for courses of study in relation to textiles, sewing, dressmaking, and management can be found in "Domestic Art in Woman's Education," by Anna M. Cooley, published by Charles Scribner's Sons, New York, which is a book for teachers, dealing with the methods of teaching these subjects; and for courses in foods, nutrition, and sanitation in "Methods of Teaching Domestic Science," by Helen Kinne, published by the American Book Company.

Teachers may assign exercises for home work according to the amount of time each consumes. Many of them are arranged to test the initiative of the pupil. They are also intended to indicate to the teacher possible methods of accomplishing some of the work. Exhibits, excursions, written exercises, use of

stereoscope, stereopticon lectures by class, charts of textile and house-furnishing subjects, sketches, use of bulletin board, are all helpful and interesting to girls.

This volume presupposes a knowledge of sewing and other phases of the work of the average elementary school and does not present the elementary stitches and processes. Of the problems suggested for practice, choice may be made, or others substituted. It is wise early in the high school course to review the hand-sewing processes rather than to devote the entire time to machine work.

The drafting introduced is intended to give freedom and not to bind the girl to a set of letters committed to memory. The main aim in introducing it at all for the average high school girl is to enable her to change commercial patterns and to use them more freely.

In addition to the books on methods of teaching the household arts suggested above, the following bibliography may be of assistance to teachers in preparing subject matter: —

The Art of Right Living — Ellen H. Richards.

The House — Isabel Bevier.

House Sanitation — Marion Talbot.

A Color Notation — A. H. Munsell.

The Theory and Practice of Teaching Art — A. W. Dow. (New edition.)

The School Arts Book. Published by the School Arts Publishing Company, Boston, Mass.

The Household Arts Review. Published three times a year by the Household Arts Club, of Teachers College.

Homes and Their Decoration — Lillie H. French.

Art and Economy in Home Decoration — Mabel Priestman.

Chats on Old Furniture — Arthur Hayden.

The Oriental Rug Book — Ripley.

A Sewing Course — Mary Schenck Woolman.

- Textiles and Clothing — K. Watson.
Embroidery Up to Date. — Butterick Publishing Company.
Lace, Its Origin and History — Goldenberg.
Textiles — Dooley.
Household Textiles — Charlotte M. Gibbs.
A Study of Textiles — Woolman and McGowan.
Textile Fibers — Matthews.
Spinning Woolen and Worsted — W. S. McLaren.
The Story of the Cotton Plant — F. Wilkinson.
The Structure of the Wool Fiber — F. H. Bowman.
Ten Centuries of Toilette — A. Robida.
History of Fashion in France — A. Challamel.
Millinery. Current Magazines. McCall's, beginning in January, 1913.
Dressmaking. Current Magazines. Series L'Art de la Mode. January, 1913.

CONTENTS

PART I

THE HOME

CHAPTER I

THE HOME

	PAGE
The Aims of a Home—Ideals in Establishing—Education in the Home—The Mistress of the Home—Entertainment in the Home	1

CHAPTER II

THE HOUSE

The House and its Surroundings—Apartments and Single Houses—Domestic Architecture—Exposure of the House	15
---	----

CHAPTER III

HOUSE PLANS AND CONSTRUCTION

Arrangement of Rooms—The Cellar and Foundation—The Upper Structure	30
--	----

CHAPTER IV

HEATING, VENTILATING, AND LIGHTING

Stoves—Furnaces—Steam and Hot Water Apparatus—Ventilating Apparatus—Candles—Lamps—Gas and Electric Lighting	37
---	----

CHAPTER V

WATER SUPPLY AND DISPOSAL OF WASTE

	PAGE
Sources of Water — Contamination of Water — Filtration — Disposal of Refuse — Drainage and Plumbing	45

CHAPTER VI

DECORATION OF THE HOME

Guiding Principles in Home Decoration and Furnishing — The Walls and their Covering — Floors and Floor Coverings — Woodwork	55
---	----

CHAPTER VII

FURNISHING OF THE HOME

Furniture — Draperies — Curtains — Pictures and Bric-a-brac — The Furnishing of Bedroom, Bathroom, Dining Room, Halls, and Kitchen	73
--	----

PART II

TEXTILES AND CLOTHING

• *TEXTILE MATERIALS AND HOW THEY ARE MADE*

CHAPTER VIII

COTTON

Reason for Study of Textiles — Cotton Varieties — Growth — Culture in the United States — Ginning — Baling — By-products — Manufacture of Thread and Cloth — Common Cotton Materials Every Girl should Know — Cotton Industry in the United States	97
--	----

CHAPTER IX

FLAX

Its Growth — Varieties — Culture — By-products — Manufacture of Yarn and Cloth — Common Linen Materials — Uses of Linen Yarn — Linen Industry in the United States — Other Vegetable Fibers	131
---	-----

CONTENTS

xiii

CHAPTER X

WOOL

PAGE

Varieties — Growth — Culture — Woolens — Worsteds — Remanufactured Wools — Manufacture and Furnishings of Wool Fabrics — Uses of Woolen Yarn — Common Woolen and Worsted Materials — Wool Industry in the United States	148
---	-----

CHAPTER XI

SILK

Its Culture — Growth — Varieties — Manufacture of Thread — Cloth — Silk Dyeing and Finishing — Other Uses — Other Silk Fibers — Silk Industry in the United States — Common Silk Materials	171
--	-----

CHAPTER XII

COMPARISON OF WOOL, COTTON, SILK, AND FLAX

Microscopical and Chemical Differences — Varying Characteristics and Properties — Methods of Adulteration of our Common Materials and Ways of testing Them — Chemical Tests for Identification of Fibers — Other Tests for Fibers	188
---	-----

SEWING AND GARMENT MAKING

CHAPTER XIII

UNDERGARMENTS

Hand vs. Machine Work — Ethics of Purchase of Underwear — Sewing Machines and their Use — Materials for Underwear — Decoration of Underwear	200
---	-----

CHAPTER XIV

PATTERNS

Altering — Interpreting — Testing — Drafting — Commercial Patterns and their Use	217
--	-----

CHAPTER XV

DRAFTING

	PAGE
Drafts for Kimono Night Dress, Drawers, Shirt Waist, Corset Cover, Chemise, Night Dress developed from Shirt Waist Draft — Foundation Skirt Draft for Division into Four, Five, Six, or Other Gored Divisions	226

CHAPTER XVI

CUTTING AND MAKING GARMENTS

Undergarments and Other Garments — Suggested Problems in Sewing	244
---	-----

CHAPTER XVII

EMBROIDERY

Suggestions for Study of its History — A Few Useful Stitches and how to make Them — Some Suggestions for applying the Stitches in Combinations	257
--	-----

DRESS

CHAPTER XVIII

HISTORY OF COSTUME

Egyptian Costume — Greek — Roman — French Costume — Early Middle Ages — Fourteenth Century — Sixteenth Century — The Renaissance — Eighteenth Century Costume — Period of French Revolution — Restoration Period, 1815–30 — Modern Needs	274
--	-----

CHAPTER XIX

COSTUME DESIGN

The Importance of Artistic Dress — Its Requirements — Principles of Design — Unity — Lines, Silhouette and in Design — Dark and Light "Value" — Value in Color — Color Harmony and Emphasis — Lines and Colors for Different Figures — Fashion — Simplicity in Dress — Appropriateness — Use of Jewelry	288
---	-----

CONTENTS

XV

CHAPTER XX

THE HYGIENE OF CLOTHING

	PAGE
Its Importance in Relation to Health — Uses of Clothing — Selection of Shoes in Relation to Health — Corsets — Hats and Hair — Underwear	303

CHAPTER XXI

THE ECONOMICS OF DRESS

Economics of Selection of Materials — Allowance and Dress Budget — Budgets for Wardrobe costing \$65 — One averaging \$125 per Year	311
---	-----

CHAPTER XXII

CARE AND REPAIR OF CLOTHING

A Few Suggestions for Daily Use — Care between Seasons — Care of Colored Clothes before Laundering — Renovating and Cleaning — Dyeing — Renovating Laces, Silks, Velvets, Hat Materials — Removal of Common Spots — Mending and Remodeling	319
--	-----

CHAPTER XXIII

THE CONSTRUCTION OF DRESSES

The Dresses a High School Girl should be able to Make — Construction of Middy Blouse, Lingerie Waist, Tailored Skirt, Gymnasium Suit, Tailored Shirt Waist, Norfolk Jacket Waist, and Simple One-piece Dresses	332
--	-----

CHAPTER XXIV

MILLINERY

Selection of Hats — The Making and Covering of a Buckram Frame — Lining a Hat — Making of Wire Frame — Straw Sewing — Bow Making — Suggestions for Trimming	348
---	-----



SHELTER AND CLOTHING

PART I

CHAPTER I

THE HOME

UPON the privacy and sanctity of the home rests the strength of American democracy. The English and German nations are noted for the deep-rooted attachment of their people to the home and for their skill as home makers. They have fought through centuries for the preservation of their home ideals, and have realized the nobility of the profession of home making. The words "house" and "home" are often confused. The home expresses the family life which is lived within the house. The house is the place where the home maker surrounds herself with artistic and harmonious furnishings and where she tries to work out the ideals and standards of living that will create the real home atmosphere and bring about the development of all of the members of the family. The material things of the home express the real spirit of the family and exert an untold influence on its moral and intellectual life. The home should stand for rest, for peace, for comfort, health, and inspiration, for the true spiritual development of each member of the family. There should be unity, with a chance for each individual to express himself; a democracy in the best sense of the term.

A house may have had every thought and care expended upon its furnishing and equipment, every device for convenience and comfort, and yet fail to be a home. The home

atmosphere is created by the ideals of the family or of her who is to lead in its administration and management. It is her artistic sensibility that brings about this atmosphere, a something that cannot be bought, but that is the result of thought and training. Each real home should be an institution of society so managed that the best and most efficient citizens may be given to the community. Every girl, then, in preparation for home building should consider carefully this aim. The home is the place where the members of the family retire apart from the world and where children receive training that will help them to meet the problems of life outside the home. The household machinery should be so arranged that there is time left for the higher life of the home and for child training, as the main aim is the production of happy, healthy, useful human beings. The home makers of the ideal home are not so worried and overtaxed that there is little time left for the family and the real joys of family life. The true aim cannot be achieved if more thought is given to the care of the house than to the physical, spiritual, and mental development of the children — character building is the aim of home making. In the ideal home the father unites with the mother in the aims to be attained. The home should satisfy the many-sided needs of all the members of the family, and it should be a place of refuge which each delights to seek, where the troubles and worries of life are shared and the burdens carried together. It is the character and ideals of those within the home that will make this ideal a possible achievement, not the mere formal walls and living together of a group of people.

Each home has an individuality that is strongly its own, and expresses to the world the ideals and standards of life of those within. As long as there are men and women and life lasts, there will be homes. The girl should so prepare

herself for home administration with a view to improving present conditions of home life that her home will minister to all that is good and beautiful and best in the personal health and happiness of the lives of her family and not to dissatisfaction, unrest, overelaborateness, expensive living, discord, and unhappiness. The home, when it is rightly developed with all things in proportion, works entirely for good and is uplifting. The family should not be a disorganized group with no regard for privacy, individual rights, or the good of others. If this condition exists, the home is based on wrong ideals. No community is better than the average home in its midst, and no institution outside of the home—church, state, or school—can compensate for the neglect of home training. Professor Giddings defines the home as “the place of development of the social, individual, economic, and cultural.”

Ideals in establishing a home. — Much thought, therefore, must be given, by those who expect to establish the right kind of home, to working out the ideals upon which the life of the home is to be based. These standards of life must be clear, in order that they may be the guiding principles that direct the activity of the home. Order, contentment, hospitality, godliness have been called the house blessings. The home maker must early realize that “man does not live by bread alone,” and the other needs must be as carefully considered as food, clothing, and shelter.

A home based on the right principles will be *simple*. There will be simplicity of living, honesty in the expression of what is offered in the home. No ostentation or living beyond one's means; simplicity in entertainment in offering freely of what one has to friends, without apology or explanation; simple furnishings, simple, healthful food, simple, artistic clothing, all help to simplify life and give the home makers

more time for the family joys and intercourse. It sometimes requires much courage and independence of thought and action to achieve this ideal when one's neighbors give elaborate dinners which are paid for with difficulty, seek the excitement of moving-picture and vaudeville shows when they can scarcely be afforded, and neglect the allurements of woods and fields and streams, which offer more healthful and simpler pleasures. Modern life has brought much that is complex, but a well-organized home with right ideals will be run so as to plan the spending of the family income to the best advantage of all and to consider the spiritual as well as the material needs of the family. Simplicity of living will add much to the independence and freedom of the group.

A home with right ideals will be *harmonious*. The members will be kind, loving, and forgiving as well as thoughtful of one another. The religious life of the family will have expression in the acts of kindness to one another and altruistic expression outside the home. No home is well planned which omits to place as one of its foundation rocks the thought of relationship and responsibility to the Creator. Godliness is the crowning blessing of the home.

Cleanliness and orderliness should be fixed ideals, for upon them the health and comfort of the whole family depend. Mrs. Richards used to speak of the beauty of cleanliness as the most costly of all beauty. Cleanliness in the preparation and handling of foods, cleanliness in the care of clothing, rooms, and furnishings leads to happiness and a more healthful family life. Sanitary science demands that thought be given to the care of the household furnishings in order that disease may be prevented. Simplicity in furnishings will help the housewife to achieve this aim. It is her duty to her family to see that refuse is quickly removed

and the house kept free from dirt and dust, that the plumbing is in order, that the heating fulfills the requirements of the family. The best investment made by the family is that which goes to promote the health of the family. Upon orderliness in the household depends much of the family pleasure. In the ideal home, the housewife will be so systematic in her management that there will be little friction in the machinery of administration. A time and place for everything will help. Simplicity, orderliness, cleanliness, honesty, godliness, will lead to harmony in the life of the home.

The home maker in planning must strive for standards that will develop all sides of the individual and fulfill the needs of all the members of the family. Health of mind should be sought as well as health of body. Consideration should be given to questions of entertainment, to the savings which give a feeling of security, and to opportunities for the exercise of altruism in various forms of charitable and religious expression. Home makers have a wonderful duty to perform in the education of their children so that all sides of their natures may be fully developed.

No one can estimate the influence of a home that is so organized that the life of all its members is centered there. From it inspiration, cheer, and comfort radiate to guide and help those who enjoy its life daily. The friends who come and go carry with them the memory of the inspiration and refreshment offered. There is no element so vital in character building as the influence of a well-ordered, godly home where parents have united in the thoughtful training of their children.

Education in the home. — The aim in the establishment of most homes is the training and education of children in order that most efficient individuals may be given to the

community. It is the duty of parents to give their children every possible chance and so to educate them that they understand fully the meaning of right living, a training that will take into consideration all phases of education.

Physical education. — Because of the rapidity of modern life, time must be given for careful, deliberate training by parents in the right use of the bodily machinery, if effective citizens are to be produced. Parents should teach their children so to live that the demands of this machinery are recognized.

Food is of primary consideration for it produces the force to run the machine. Unless the food is of the proper kind and of sufficient amount the machinery will not run well. Knowledge in relation to foods and their nutritive values is the power that will aid young home makers in supplying proper nourishment for the home table and in training their children to think carefully about the choice of foods eaten: Self-control in selection of food should be a part of early training. Food, moreover, should be taken only at regular intervals in order that the digestive organs may have time to manufacture the necessary secretions. Attention and thought are given by few parents to the consideration of the habit of drinking sufficient *water* of the right kind. Water should be safe and children should be trained to realize that a sufficient amount must be taken in order that the blood stream may be diluted and carry to the tissues the necessary food in solution in that stream. Sufficient water is an absolute necessity, in order too that the useless material of the body may be carried away.

Thought must be given also to daily *exercise* so that the supply of food material to all the tissues of the body is kept up through proper circulation. *Fresh air* is free for all and an absolute necessity. Children should be trained to think

about the ventilation of rooms in which they live, eat, and sleep in order that the proper amount of fresh air may be supplied. Windows should be opened at night both at the top and bottom for circulation of air, and all rooms thoroughly aired every day. Remember that heated air rises. *Sleep* is a requirement of all in order that the cells of the body may have time to recuperate and be ready for the work of the next day. Growing children should be taught the necessity of sleeping from eight to ten hours according to their age.

Cleanliness of the person should be as carefully considered as proper food. The bath, as well as the bodily functions, will be taught by the mother who wishes to produce healthy, happy human beings. Selection of clothing is equally important, for the body must be properly protected, if it is to perform its necessary work. Physical welfare is also promoted by systematic *work*, something which must be done each day; and every wise mother trains each of her children so that he feels a responsibility to produce something daily according to his age and capacity. The home is thus helping to train in foresight and responsibility. Physical well-being is also sustained through opportunity for relaxation, pleasure, and amusement. This is essential in order that normal people may be produced. A good book, a concert, a walk with a congenial companion, the family party, also minister to the complete physical development of the individuals of the home. They give rest to the overworked nerves and should be so chosen and planned that they really afford rest rather than excitement. Much of this physical education and training may be learned in the school and based on the scientific studies, but it remains for the mother to bring home to the child through daily attention and thought the necessity for this important phase of education.

Religious education is not now as much as in years past a part of home training. The home is the natural place for the fostering of religious ideals. The school and church may offer instruction — all of which may be valuable, if it is carefully and systematically planned — but the wise mother will still supplement at home and offer the personal instruction and guidance which cannot fail to help to build character and be a guiding influence through life after the child has left the home. In the ideal home both father and mother will unite in this training. Reverence for God should early be inculcated. This should lead to direct instruction in reverence and respect for elders, parents, and teachers, which is so often lacking in the youth of to-day.

Intellectual and æsthetic education. — While much intellectual and æsthetic training is given outside the home, in our schools, and through outside agencies such as lectures and clubs, the ideal home, which stands for culture and training of its young, will be a clearing house for knowledge gained outside. It will furnish side lights which will be broadening and enlightening. All education is not found in books. Contact with people of culture offers inspiration and a fund of information. Discussions at home, with parents and friends, of subjects under consideration in school are of much value. Good books, magazines, pictures, and music, all aid in the cultivation of æsthetic and intellectual ideals. The selection of furnishings, the discussion of art subjects, such as pictures, color, sculpture, architecture, should supplement the instruction given in the school and find a place in homes where the parents are anxious to secure the full all-round development of their children.

“Man does not live unto himself alone.” Children should be taught early in life that each must have an aim. There is a goal to attain, and life is not merely the achieving of

daily pleasure, but there should be an aim aside from such personal gratification. Each individual should be taught to feel his social obligations and his duties to the community in which he lives. The development of a social consciousness in the minds of the children is a part of the duty of parents. The children of the home are to be the coming statesmen and leaders of the people, the directors of savings banks and insurance companies, the trustees and directors of school boards, hospitals, and churches, the ministers, missionaries, doctors, lawyers, and tradespeople of the world. Children should be trained to act together to appreciate the necessity of thought for others, to be ready and willing to lend a hand in work for civic or other betterment. Parents can do much by interesting children early in organizations that are working for such good; respect for government depends largely on the ideals set up in the home. Clubs (which have an altruistic aim) started in the family circle and composed of the children's friends are of value in that they begin to call attention to the duty of man to his neighbor and to the improvement of the community in which he lives.

Ideals of honor, thoughtfulness, self-control, responsibility, discipline, foresight, self-sacrifice, love, reverence, and order should be early inculcated by parents who are training their children wisely. There is nothing that so destroys the harmony of home life and makes for discord as selfishness, disregard for the feelings and property of others, rudeness, and impatience.

The mistress of the home. — Most girls look forward to the time when they will be the mistresses of their own homes. The responsibilities of home management and administration are very great and not to be entered into lightly, but with much thought and preparation in order that the

home maker may guide and direct wisely the lives of those given to her care. Home making is a profession, and women should be educated to fill this position as men are trained to occupy positions in office, factory, or court. The home maker must fill many niches in her home and at the same time have the ability to direct with force and initiative all the business of the household. Training for home making will give woman this power, for she will understand the physical, religious, intellectual, and æsthetic needs of her family and will be able to minister to them. The knowledge and ability gained through training in home making will enable woman to run her household in a business-like way, and as she begins to understand the sciences and learns to use them, real joy and pleasure will be hers in the performance of the daily duties of her profession. Girls of to-day have a wonderful opportunity in the schools to receive much of scientific training for the profession of home making.

Besides training there are many characteristics which the ideal mistress should possess in order that her home making may be a success. *Health* should be placed first. The girl of to-day who expects to be the home maker and mother of to-morrow must obey the laws of Nature and each day consider thoughtfully the cultivation of physical strength and energy. There is nothing which is communicated so quickly in a home as the exuberance of spirit which comes from perfect health. Depression and lack of cheer often pervade the home in which the mistress is low spirited because of ill health. *Sympathy* and *tact* in dealing with servants and family help to keep the machinery running well. *Foresight* in management will prevent many a catastrophe. Foresight enables the home maker also to plan the routine work of the house in a systematic way. *Self-control* should be practiced at all times. It enables the mistress to "keep

her head," to remain calm and cool; to rise above the disturbance of petty things, and consequently to direct others more sanely. *Good common sense*, a rare virtue, helps many a woman to weigh carefully the relative importance of household duties. A brisk walk, even though some duties must be neglected for its sake, will help her to regain spirits or freshen her for a difficult task. The ideal mistress is in control and is not controlled by things. She keeps constantly in mind the fact that the house was made for man to live in and be happy in. A rest may add to that happiness in a way an immaculately ordered room may not. At the same time the home maker must weigh the relative importance of duties, for a neglect of details and order will also lead to unhappiness.

The ideal home maker is thoughtful, cordial, polite, and hospitable. She remembers the birthdays and other anniversaries of the family and friends. She is ready with notes of cheer and condolence and is anxious to offer protection to those who need her sympathy and help. She is cheery and optimistic and her manner expresses these charms. She is neat and tidy in appearance at all times, in her room, in negligee, at the breakfast or noonday meal. Her working clothes are neat and adapted to her duties. No lace-befrilled kimonos or dressing sacques are seen for dish washing or other household duties. She has time to change her gown before the evening meal when the family is united. If she prepares this meal, she arranges her work so that time is available for a little rest and opportunity for change of clothing which, while adapted to her work, shows thought and consideration for the home-coming members of the family.

The ideal home maker will find time each day for rest and inspiration. It may be only half an hour, but she needs at least this for reading and reflection. She will feel the

need of spiritual help and guidance from her Bible or other source of comfort. The newspaper should be followed daily, but not allowed to exclude such literature for study as time and inclination direct. As time permits, it is wise for her to interest herself in clubs and reading circles in order that her vision may extend beyond the duties of daily routine and there may be gained a new thought or idea that will benefit the whole family circle.

The mistress of the home expresses her ideals also in the furnishings of her home. They will be simple and in accordance with ideals of beauty and harmony. Some one has said that the home should be so furnished that it will neither oppress nor embarrass those who are invited within. Ruskin said: "If you have sense and feeling, determine what sort of a house will be fit for you; determine to work for it, to get it, and to die in it, if the Lord will. I mean one that you can entirely enjoy and manage, but which you will not be proud of, except as you make it charming in its modesty."

Entertainment in the home. — Human beings must associate in a more or less intimate degree. This is a natural and right desire. In the modest home parents should so plan in the expenditure of their income that some of the portion reserved for pleasure is used in simple entertainment within the home, of guests and friends of both children and parents. Simplicity in entertainment, genuine hospitality to the passing stranger should be a possibility in every real home, where husband and children have only to request, knowing that the mistress of the home will arrange if possible to offer a welcome to the friend for dinner or luncheon or to stay the night. Friendships come naturally and spontaneously to young people in their school and business associations, in their summer travels and vacations. Parents should respect this expression of individual selection and

guide during childhood in the wise choice of friends. The natural desire follows to entertain under the home roof those preferred and selected, and this should be a possibility. There should be no thirst for display and ostentation in entertainment, but the simple entertainment of those the family delights to have within its circle. The fact that social entertainment on a large scale bores and wearies is proof enough of its inability to satisfy what is a natural desire for human associations, but simple entertainment and hospitality brings about right companionship which enriches and develops. There is a wider intercourse between men that the home does not satisfy, but this is reserved for club, for church, for association outside the home from which are selected those to whom one is drawn and to whom the entertainment within the home is later offered.

The ideal home maker will thus train her family in right living, for in this way only can effective citizens be given to the community. This is the obligation of every girl who enters upon home making. Mrs. Ellen Richards outlines some of the characteristics of right living. Aim to keep them in mind in starting a home.

QUOTATIONS FROM MRS. RICHARDS' WRITINGS.¹

There is no noble life without a noble aim.

The watchword of the future is the welfare and security of the child.

Love of home and of what the home stands for converts the drudgery of daily routine into a high order of social service.

The economy of right uses depends largely upon the home

¹ Written for the Mary Lowell Stone Home Economics Exhibit.

maker and brings the return in health, happiness, and efficiency.

Home Economics stands for the ideal home life of to-day unhampered by the traditions of the past.

Home Economics stands for the utilization of the resources of modern science to improve the home life.

Home Economics stands for the freedom of the home from the dominance of things and their due subordination to ideals.

Home Economics stands for that simplicity in material surroundings which will free the spirit for the more important and permanent interests of the home and of society.

EXERCISES

1. What is meant by unity in the home?
2. How can the true "home atmosphere" be established?
3. What is the aim of home making?
4. What is meant by basing home making upon right ideals?
5. Who was Mrs. Ellen Richards? What did she contribute to the Home Economics movement? Try to arrange to celebrate her birthday.
6. What are some of the characteristics of a well-ordered home?
7. What education should a home provide?
8. What physical education should the home foster?
9. If you were a home maker, what religious training do you think should be given in the home? What intellectual and æsthetic training?
10. Name some characteristics which the ideal home mistress should possess.

CHAPTER II

THE HOUSE

WHEN we go house hunting what an event it is and how dreaded! Yet it should be a happy occasion. How different a matter it was in the early days of our country when most well-to-do people built a new homestead for the new family! There are still those who have the satisfaction of planning and building their own houses, or who may remodel some older house in a small town or in the country. But most city dwellers must rent an apartment or flat, or a small house in the suburban town. There are, however, many good schemes for helping those with moderate incomes to buy houses in the suburbs.

What we look for in a house. — No matter what the type of house, whether primitive as the Eskimo's hut, or as complete as modern science and art can create, it should meet a few apparently simple needs. Protection from the elements, from cold and heat, from rain and snow and damp, from intruders who might interfere with the family safety or possessions; water at hand; some way of getting rid of waste; space for the family, for all their occupations and belongings; room for a guest: these were sought by even the cave dwellers. And we have not passed beyond these simple needs. Our enemies are of a different kind, but the daily paper shows that we must pay for safety locks; and while wild animals no longer prowl about, we find it almost impossible to keep out rats and mice and harmful insects. The "house" fly is now called a "typhoid" fly, and not

permitted even as a casual visitor. To all these needs we have added what the cave man did not seek for, since his life was largely out of doors. We must have air and sun within doors. Doctors are now talking about house diseases. Tuberculosis is one of these, and the fight against it must be made, in part, just here. It is for sun and air that we have to pay large rents in town; and it is partly to secure



Courtesy of "The House Beautiful."

FIG. 1. — A house in the Italian style.

these in our large dwellings that tenement-house commissions exist, to protect those who cannot protect themselves. Then, too, there must be protection against fire, not only by the fire department but in the house itself. Modern nerves, moreover, demand quiet. We may want our own victrola, but we do not care to hear our neighbor's, and walls and floors must be built to keep out sounds. We call these simple needs. They would seem to be human rights, but even now in this twentieth century how many houses rank 100 per cent in all these; in warmth and coolness at proper seasons; perfect dryness, ventilation, and lighting; safety from fire and intruders; and room for each member of the family to be by himself, and to keep an open door to guests?

Yet, we cannot be as well nor as happy nor as useful as we should, until these are achieved. Every woman must know how to find these things and must learn to demand them, and we must all work together until healthful conditions are possible for all.

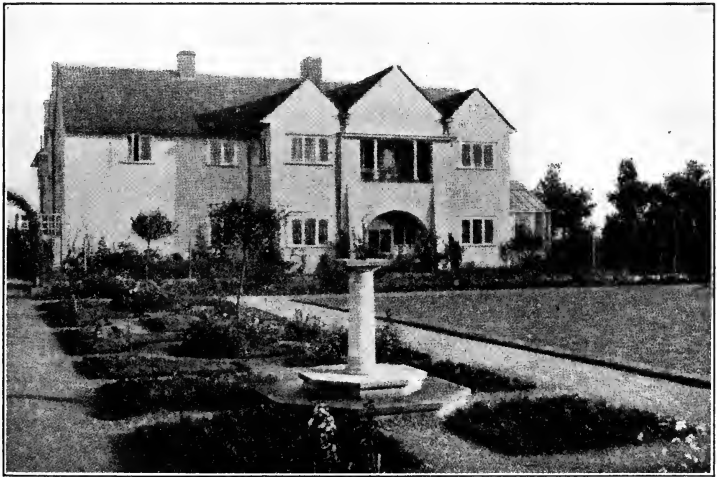

FIG. 2. — A modern English house.

Exterior and surroundings. — As we approach various houses on our hunting trip, we look for what is pleasing in the way of beauty and homelikeness, neatness, and general pleasantness. The house itself should give an invitation to enter, and should add to the beauty of the countryside or the town.

Apartment and block houses. — The question of rent is so important to the inhabitant of the apartment house, that the thought of architecture seems almost forgotten. Too many builders of such houses attract by cheap showi-

ness. Within a few years, however, apartment and block houses have been built that are dignified and strong in construction. Those of soft brown or dull red bricks, with harmonious ornamentation are pleasing to the eye.

Surroundings are important, and the apartment seeker must think of this as well as of the interior. Avoid fashionable streets, if the income is moderate. Rents are high in such neighborhoods. Find, if possible, a quiet street. Often in the side streets of the city the most satisfactory houses are found. If there are shops in the house or near, notice the kind. Avoid those that give off odors or that might be noisy, as, for instance, a laundry; also those that are likely to cause litter and attract flies, as a vegetable stand. Stables, gas houses, factories, and noisy railways should also be avoided. Notice if high buildings cut off sun, air, and view.

Convenience to some conveyance is often a necessity, and nearness to school, church, and business all have to be considered. If one cannot have all of these, for ideal spots are few, thought should be given to balancing the objections and selecting the best situation.

Choose an apartment with a plain and tasteful entrance, rather than the cheap and tawdry variety which adds to the rent and has no real beauty. There is probably no question of lawn or garden, but it may be that there is a green spot opposite, or near, or trees and plants at the entrance. Window boxes add much to the beauty of the house.

Architecture of the single house. — Here we have an opportunity to study one of the most delightful of the applied arts — domestic architecture. Despite many failures, house architecture in America is much better than it was a few years ago. Not only are the younger architects doing strong work in this field, but our taste, as a people, is im-

proving. For this is a taste to be cultivated, just as much as the taste for pictures, or music, or literature.

As in all other kinds of architecture we must learn from other countries and periods. Yet we have made grievous mistakes just here. Witness the French roof of about 1860,



FIG. 3. — A square house, with hip roof, New England, 1780.

an adaptation of the Mansard, dignified in its place, but ugly as the roof of a small dwelling. Then came, after the Centennial of 1876, the attempt to use an English style of architecture in the so-called Queen Anne; and there have been thousands of wooden boxes adorned with gables and porches, curious medleys, lacking in simplicity, strength, and beauty.

At present we find certain well-developed styles, adapted

from the Italian, the English, and the Colonial and post-Colonial of our own early days. The Colonial styles show both Dutch and English influence. In the stately Colonial mansions with pediments and columns, there is a suggestion of the Greek. On the western coast a *Spanish* type is being used, after the fashion of the early Spanish missions, in some



Courtesy of "The House Beautiful."

FIG. 4. — A modern house, semicolonial.

cases most happily. The *Italian* is taken from the villa of Italy and is for large houses only (Fig. 1). It is broad and low, and formal in composition; well suited to a dignified house with much space about it. The *English* is more informal in composition, sometimes rambling in structure, the roof much in evidence (Fig. 2).

In the *Colonial* style a number of types have developed,

both for the large and the small house. Our forefathers built strongly and simply, whatever style they used; they did not always originate, they frequently adapted. Some one has spoken disparagingly of the Colonial as "carpenter's Greek"; yet while there was doubtless some poor architecture in those days, there were certainly many houses suited to their setting, that expressed with dignity the life of that time. Under Colonial we class the square house, two-storied, with the "hip" roof, and pillared portico or porch (see Figs. 3 and 4). This type of roof is still much used, and is suitable to small houses of the square cottage or bungalow type (see Fig. 11). The more oblong house with the "gambrel" roof, sometimes one-storied, sometimes two, is a well-known Colonial type (see Figs. 5, 6, and 7). There are still simpler houses, built during the same period and later, those of one or two stories, with generous sloping roof, very plain and claiming no architectural style, but nevertheless showing very good lines. Then, too, we find houses with a long sloped roof at the back, known as "lean-to" or "salt-box" houses. This latter style is being used at present in small suburban houses, sometimes with good effect (see Figs. 8 and 9).

Whatever the style, there are some definite principles to be borne in mind, and others less easy to define, quite important — matters of feeling largely. There is a certain relation between material and style that must be noticed. As a rule, wood is better for a small than a large house. A large house built of wood may seem barnlike, or may resemble a summer hotel. That the English house is in better style than ours is due to the fact that stone or brick or plaster must be used in England, and architecture has developed accordingly. As wood becomes more costly here, style in architecture will accommodate itself to other materials.

Reënforced concrete, for example, seems to need a treatment quite its own. The combinations of different kinds of material, say, stucco and wood, are hard to manage, and are not usually good.

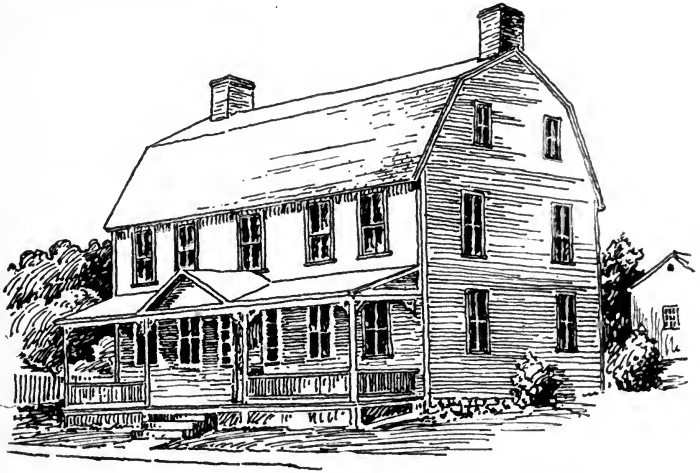

FIG. 5.—House with gambrel roof, New England, 1765. The piazza is a recent and poor addition.

Remember that the roof is an all-important part of a house, and its outline must not be much broken, except when this is necessary to give space and light inside. Dormer windows must be very simply treated, especially when used in a house of the Colonial style.

Every addition to the house in the way of porch, or dormer, or window must be made to seem a part of the house, by right proportion and placing, with as few “fancy” touches as possible. The old Colonial builders were especially successful in their treatment of doorways, porches, and windows, and their work should be studied with this thought in mind. A dignified two-storied house with fine

gambrel roof is made commonplace by a straight, narrow piazza stretching across the front. Remove such a piazza, add a square porch in front, or possibly at the end, and the change is wonderful (compare Figs. 5 and 6). If the house

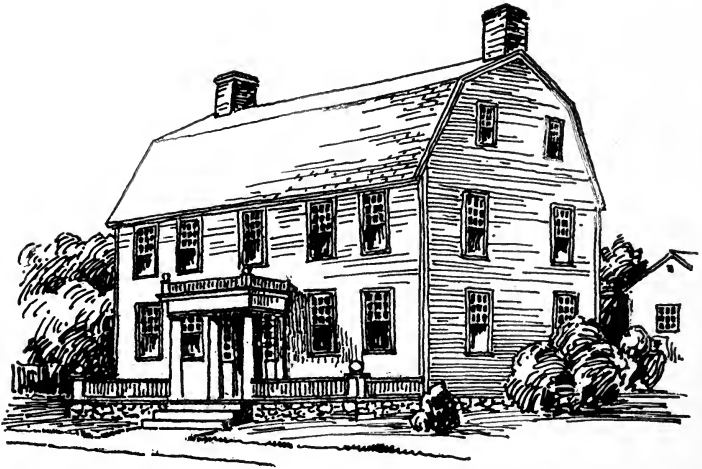

FIG. 6.—The same house, as it might be. Notice the fine effect of the windows as compared with Fig. 5.

has one main portion, everything should be made a part of that. If the additions are large, they must look as if they grew together. Notice how in Figure 1 the addition at the right has this intimate connection with the body of the house; in Figure 4, note that the porches are subordinated to the house.

An architect studies what he would call "balance" in his design. Notice the balance of the grouping of the windows on the two sides of the porch in Figure 4. In Figure 2 there is a beautiful balance in the gables and windows at the right of the building, and although these gables



FIG. 7.—A one-storied house with gambrel roof, New England, 18th century. A similar design is used at the present time.



FIG. 8.—A "lean-to" of plain design. New England, about 1750.

are at the right and not in the center, the building is well balanced as a whole.

The architect knows, too, that light and dark masses, rightly placed, give beauty. In Figure 4 notice the beautiful shadows cast by the cornice, and the shadows of the porch. In Figure 2 the two recesses for the door and the upper porch give pleasing shadows.



FIG. 9. — A modern small house with the "lean-to" motif. Notice that the long slope faces the front.

The color is a large item. Study the surroundings of the house and determine what colors will mingle with the setting, without standing out glaringly. Soft browns and buffs and grays and dull reds are almost always good. White is good where there are green spaces and trees.

What we seek is simplicity, repose, dignity, and unity. The eye should be able to see the house as a whole, and not be forced to move restlessly from one detail to another.

How are you to know what is good? Study what you see done by good architects, both in actual work and in print. Do not be discouraged if you do not understand the best

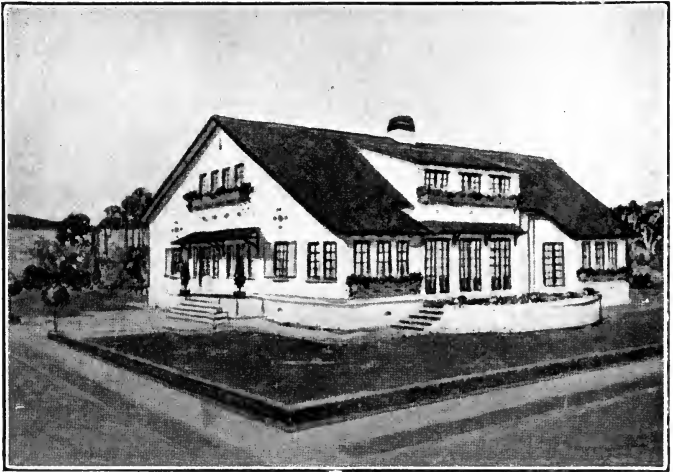

FIG. 10. — A modern suburban house of no definite style, but pleasing in effect at first. You will soon learn to distinguish merit and prefer it to “gingerbread work.”

Many magazines dealing with country and suburban life illustrate excellent types of houses. Magazines devoted to architecture and some art magazines give quite a little space to domestic architecture both foreign and American. These can usually be found in libraries, and some of them wherever magazines are sold.

Exposure of the single house. — Sunshine on all sides of the house and at every window is what we need. This can only be secured by placing the house in what may be called a cornerwise position in respect to the four points of the compass. That is, the house should have its corners

in these directions with its face southeast or southwest, northeast or northwest. Wherever free to choose, place the house in this way. The direction of the street often determines the position of the house in regard to these points of the compass, and unfortunately, there is a prejudice in favor of laying out streets that run north and south, east and west. Sometimes the house can stand at a slight angle to the street.

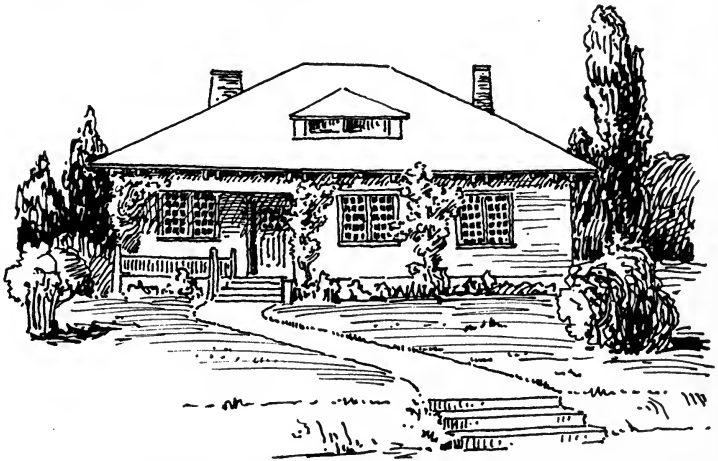

FIG. 11.—A modern square cottage, or "bungalow," well proportioned. A good design for a village house.

The house should stand as far back from the street or road as the grounds permit. If there is a choice between higher and lower level, the former is usually preferable on account of soil drainage. To be sure, such a house is more exposed to wind, but trees and other houses may serve as wind breaks.

The shade of trees is grateful in summer, but no matter at what sacrifice of the tree itself, no house should be shrouded

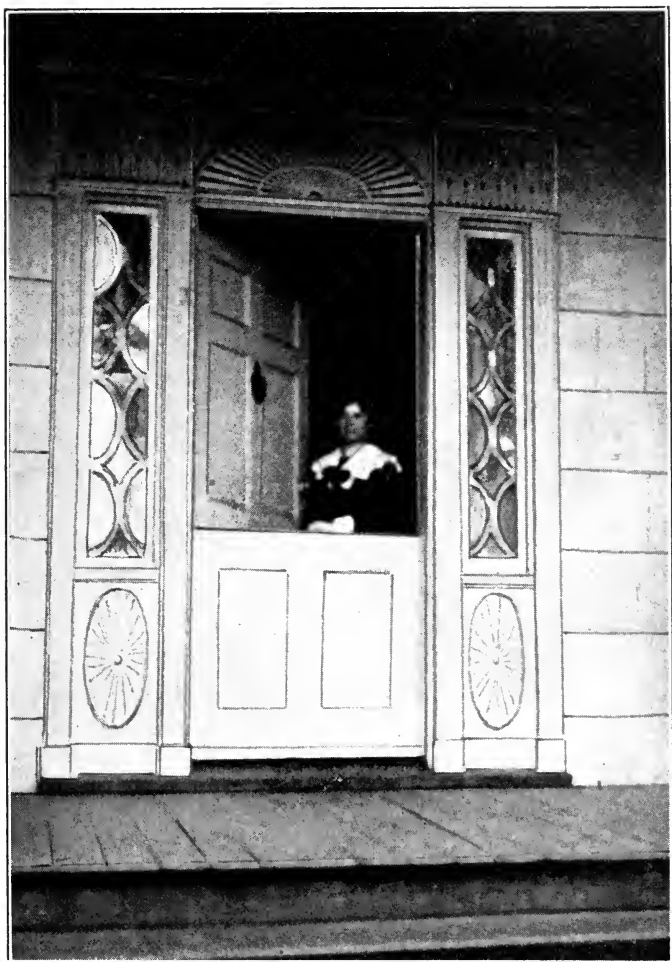

FIG. 12. — A postcolonial doorway, New Jersey, about 1800.

in foliage. Trees should not be too near the house for two reasons; their roots may penetrate the walls of a cellar, and their shade lying on the walls and roof is bad for the fabric of the house and for the health of the occupants. In setting out a tree its size when full grown should be estimated, and the tree set at such a distance that its future shade will not rest on the house. A verandah will give shade near by, though even this should not interfere with winter sunshine.

EXERCISES

1. Try to distinguish different styles in the home town. Compare examples of two different periods, and see which is better. Compare two of the same period.
2. Bring magazines to class, and discuss the illustrations, which often include both good and bad.
3. Make a collection of cuttings from magazines and advertisements. Many postcards of good historic houses are published, and are not difficult to obtain.
4. Photograph typical houses for the personal and school collection.

CHAPTER III

HOUSE PLANS AND CONSTRUCTION

AFTER all, the exterior of a house should be shaped and determined by its inner comfort and convenience. The Scotch phrase "far ben" speaks of that inner privacy, the hearth, which is the heart of the home, and around which everything else is grouped. Some one has said: "Begin with the chimney and fireplace and build the house around that."

Arrangement of rooms. — In spite of the fact that we must allow for radiators, registers, and gas logs, there is opportunity for much choice in the arrangement of our rooms. Certain things may be said of both apartment and house. Have as many separate rooms as the purse will allow. If there must be economy here, combine rooms in such a way that separate bedrooms may be retained. One may have a general living-room, instead of sitting-room and parlor; the dining table may even be moved into the living-room or the kitchen, rather than give up separate bedrooms for the sake of the dining-room. This applies only to crowded conditions, because we want our kitchen, dining-room, and sitting-room separate; though, in the simple home where a woman does her own work some doubling up, as suggested, saves many weary steps.

An important matter is the way that rooms open into each other. Each room should have an exit independent of every other room. Where rooms open into each other see that they can be cut off, when necessary, for warmth and privacy. Notice that the arrangement of doors and windows permits of draughts of air when they are desirable.

Wall space. — Many rooms that give an impression of cheerfulness actually have no places for furniture because they are so cut into by doors and windows, fireplaces or radiators. See that the bedroom has a place for bed and bureau, and that each room is so planned that there is space for the furniture appropriate to it. One house was found to have no wall space large enough for the upright piano except in the dining-room or kitchen.

The kitchen. — See that the kitchen is a comfortable room, not too hot in summer. It need not be large to be convenient and practical, but be sure that a draught may pull through it. Be careful to have the kitchen, supply closet, and dining-room in close relation to each other. Fancy yourself walking from one to the other, and see which arrangement gives the fewest steps.

The bathroom. — Notice that the location of the bathroom makes it easily accessible to all, and that it is light and well ventilated.

Closets. — Remember to count the closets and cupboards and see if every available space has been used for this purpose. There is little danger that you will find too many.

Entry or hall. — This is important to consider in the smaller house. We all like a wide, comfortable space as the front door opens to us. But in a large house a hall with broad and easy stairway, perhaps a fireplace, is even more pleasing. Do not have a cramped or crowded entrance, but be sure that space is not used here that might give more real comfort in the living-room or the dining-room.

Stairs. — Notice these particularly. Is the tread comfortable; are they safe and easy for older people and little children; can trunks be easily carried up and down? Look particularly at the back stairs, which are often awkward and dangerous.

Some other important points. — Remember the servant's room. See that it is habitable and planned for human comfort. In the apartment look particularly for the arrangement of rooms in regard to air-shaft and opposite apartments. Do not forget the placing of fire escapes. Be sure, too, in the large dwelling house, that there are fire escapes from the upper story. (For ventilation and plumbing, see Chapters IV and V.) In a house large enough, plan porches or balconies for sleeping out of doors, and also if practicable, a room that can be completely cut off in case of illness. Such a room may be placed in a wing or ell.

CONSTRUCTION OF THE HOUSE

This is a technical subject in the field of architecture, and the details must be worked out by the architect and builder. Every householder needs to be informed in regard to certain basic facts, however.

The foundation and cellar. — Never take a house without looking at the cellar; and when you are building, be willing to put enough money into it to make it good. A cellar must be dry, and the foundation strong enough to hold the upper structure firmly. Damp in the cellar penetrates the house, and a badly built foundation causes settling and cracking of the walls. This is true in an apartment house, where we usually ignore the cellar in selecting the apartment, trusting that all will be well. One family that had suffered a whole winter from various illnesses learned in the spring that a foot of water had been standing in the cellar. The foundation had been badly laid in the bed of a brook. In another apartment the walls cracked and a ceiling fell before the flat had been occupied a year, both defects due to a poor and badly laid foundation. Of course, good build-

ing laws and honest inspection will in time do away with such conditions. In the meantime, watch the cellar.

Have good workmen and do not hurry them. If the diggers of the cellar strike water, tiles must be laid to draw it off. The floor should not be perfectly level, but even and inclining gradually to some lower spot. This floor is made of a mixture of small broken stone, sand, and cement, at least two inches thick and well pounded. When this is hard, a layer of mixed *Portland cement* and sand two inches thick is laid over it and made smooth. Such a floor will be strong and water-tight. This *Portland cement* is the best material for making a cellar waterproof. It is inexpensive, and simple to use. The walls must be plumb, and it is well to have a coating of *Portland cement* placed on the *outside*. Chinks between the stones must be filled in, and an even coating of the cement, one inch in thickness, added. This should reach below the level of the cellar floor.

This same method can be applied to an *old cellar*, by digging the earth away outside, to the very bottom line of the foundation. This plan is recommended by a practical cellar builder, who has found this a permanent cure for many damp and leaky cellars.

Double cellar walls are sometimes used, and are good, but they add greatly to the cost of the cellar.

Materials for the upper structure. — Stone, brick, and concrete are the usual materials for large buildings, and small houses in cities must be built of these materials when the fire laws require it. They are durable and fireproof, and not absorptive of damp if the bricks are well baked and the walls well laid.

Wood has been the material of the average single house, on account of its cheapness. It is no longer cheap, if the quality is good, for our knowledge of forestry has come too

late to save our supply. More and more, brick and cement will be used in the small house. This will make for safety from fire; although there is a charm about a well-designed wooden house that other materials do not give. The outer wall may be covered with clapboards protected by paint or cedar shingles. The latter soon weather to a pleasing color and will last many years. Stained shingles are also much used.

Stucco, laid upon wood, is increasing in use. It gives warmth; has a pleasing color; and saves money, in that it is lasting, and does away with the expense of repainting. This may be used in the renovating of old houses instead of paint.

The house walls. — These must be double, with an air space between for warmth and dryness. In a wooden house some good sheathing should be used, of heavy paper made for the purpose. Hollow tiles give the necessary air space in brick and stone houses. The inner wall must be covered with good plaster. This must not freeze while wet, and must be thoroughly dry before the house is occupied. One thing that we should ask for in the inner wall and ceiling and floor is a curve when two surfaces meet at right angles; round corners, as it were. This does away with one trap for dirt, and is used in well-built hospitals. The architect will tell you that this adds to the cost. The inner finish of the walls will be considered in the chapter on decoration.

The floors. — The floors should be made of well-seasoned wood carefully laid. They should be double, in order that sound may be deadened. Sometimes other materials are used to assist in the deadening of sound. For details in regard to the floors see the chapter on House Decoration.

The roof. — Here the material is all-important. The roof must be waterproof, durable, a protection against

undue heat in the rooms beneath, not too expensive, not too difficult to lay, and in harmony with the remainder of the house. It will make the house warmer in winter and cooler in summer if a layer of mineral wool can be placed directly beneath the roof.

Tiling is beautiful on concrete and stucco houses, but it is very costly, and so heavy that the lower structure must be especially constructed to hold it.

Slating is also expensive and cold in effect.

Cedar shingles are durable, and one of the best of the ordinary roof coverings. There is a new method of applying shingles that gives the effect of the thatched roof seen on the English cottage.

A *felt*ing is being used as an inexpensive roof cover. It is cemented at the seams, and fastened with flat nails. It does not absorb heat and can be painted if desired. This is a good covering for the roof dormer windows.

Avoid *tin*. It draws heat, needs repair and painting often, is noisy when rain falls upon it, and it is ugly.

Technical details. — The details of wood, stone, and brick structure must be studied in some technical guide. Look into the matter before you build, talk over plans with the architect, and secure good workmen. Poor and cheap work are accountable for most defects in our houses.

Rental. — Rents vary so much in different towns and localities that no definite statement can be made beyond the fact that rent must never exceed one quarter of the whole income. If more than this is paid for rent, ends cannot be made to meet except by undue sacrifice elsewhere. This is a fact stated by economists that works out in practice. Of course, if the rent is one fifth or one sixth of the income, so much the better. Within the allotted sum one must find the best available.

The cost of building must also vary with the locality, for the cost of material and labor is not the same everywhere. The following comparison shows how much the average cost has increased within a few years. It is the custom for a contractor to estimate the cost per cubic foot. When the size of the building is decided upon, the number of cubic feet is calculated, and this is multiplied by what is proved to be the average cost per cubic foot, all labor and materials included. At present this is said to be \$0.18 to \$0.20. Ten years ago it was \$0.12 to \$0.15.

A country carpenter in Connecticut in 1911 made a plan for a small house costing \$1200. There were three rooms and pantry downstairs and three small rooms upstairs. This estimate did not include plumbing. It is evident then that \$2000 will build only a small house. From \$2500 to \$5000 must be available for average houses. This means that we need capital; that we must save for some time ahead, borrow from a good Building and Loan Company, or buy on installments. The last is better than renting, provided the company selling the house is financially sound, the location good, and the house well built.

No one should venture into such a scheme without consulting some good business man.

EXERCISES

1. Draw a plan of your own apartment or house, and bring to the class. Discuss its good and bad points. How would you alter it if you could? Discuss this at home.
2. Bring to class plans taken from magazines, and discuss in same way. This method is more useful than the attempt to draw ideal plans.
3. Visit houses in process of construction.
4. Ascertain rents in your own locality. Discuss the reasons for variation.
5. Get estimates of the cost of building from some local carpenter.

CHAPTER IV

HEATING, VENTILATING, AND LIGHTING

HEATING and ventilating must be studied together, for in our desire to shut in warmth and save fuel we too often shut out air, and must take great pains to see that this is supplied.

General aim. — We should aim to keep an even temperature in all parts of the house (from 68° to 70° Fahrenheit), to supply extra moisture, to have an inlet for fresh and an outlet for foul air, and to save labor and fuel. Most of our heating systems are defective in one or all of these requirements, and to secure them in any degree of perfection means a large outlay. But something can be done in each case to improve the ordinary practice.

Air if too dry is injurious to our breathing apparatus, our skin, and hair. In one schoolroom a test showed that the air was dryer than that of the Desert of Sahara. Yet this defect is one of the easiest to overcome. (See each system.)

The fireplace and grate. — These are unusual nowadays, used in summer in the camp or bungalow, in spring and fall when little heat is required, and sometimes to supplement other systems in winter. The open fire is the poetry of heating; nothing should ever supplant it. The heat is agreeable, but uneven. Ventilation is secured by the passage of air up the chimney, if the chimney is well built, but drafts from doors and windows are difficult to prevent. Both fireplace and grate are wasteful of fuel, as so much heat

passes up the chimney. With coal grates a large shutter can be placed in the opening of the flue, to be used as a damper.

Wood is a luxury to the city dweller and, as usually handled, an extravagance in the country. If the wood lot from which the supply comes is properly forested, wood is a useful fuel. Every one who owns a wood lot should obtain pamphlets on the subject from the United States Department of Agriculture.

The stove. — The first stoves date back to Colonial days, and still bear the name of the inventor, Benjamin Franklin. The original Franklin stoves are much sought, and there are now manufactured, by many stove firms, replicas of some Colonial pattern. They are in reality iron fireplaces or grates, standing out in the room, and radiating more heat into the room than the fireplace. They are used in country houses, or wherever an open fire is wanted and no fireplace is built in. (See Fig. 13.)

The type of coal stove known as "self-feeding" is most common. It is impossible to heat a house evenly with them, as it is seldom desirable to have one in each room. The room above can be warmed by placing a register over the stove, although bad air then passes upstairs; or by an iron "drum" in the upper room over an opening in the ceiling. If the stove is not well made, coal gas leaks out into the room. Moisture must always be supplied by some vessel standing on the stove top. This is important. Labor on this type of stove is now light as it can be made. The coal is poured in at the top, feeding the coal bed below slowly, and the draft and shaker are so well arranged that if cared for at regular hours, the fire will last for a long time; weeks even, as in a furnace. One great objection is the space taken in the room, and also the extreme ugliness of the patterns commonly on the market. Iron does not

lend itself to flower patterns and human faces. This is a place where good design is much needed.

The wood stove is used only where fire wood is abundant. The heat is intense. The wood in the stove has to be replenished more often than coal, but the fire will keep over

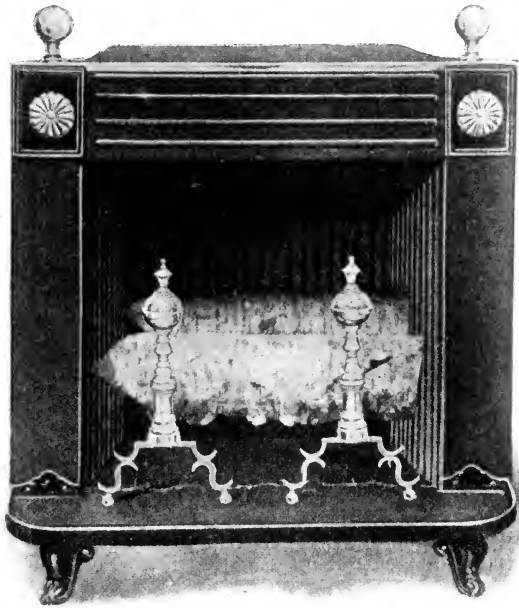

FIG. 13. — A modern reproduction of a Franklin stove.

night if a large stick is put in late and the damper shut. The sheet-iron stoves adapted to wood cost less than coal stoves. The old-fashioned name for these stoves was "The Air Tight," as contrasted with the open Franklin. A wood stove when made of soapstone gives a less intense and more lasting heat.

Oil and gas stoves are convenient, when other means of heating fail or are absent. They have to be carefully watched on account of possible fire. They vitiate the air, and frequent airing of the room is necessary. Water in an open vessel should always be placed on them to evaporate and furnish moisture to the air in the room.

The hot-air furnace. — In some ways this is one of the best methods of heating the small dwelling house. Fresh, moist air is easily secured. The heating, however, is not even for the house as a whole. In extreme weather the rooms are often cold on the windy side. Fresh air is obtained by a window, opening into an air box and flue, built into the house and opening into a chamber in the furnace, where a pan of water supplies moisture. This air box should have an outside opening above the level of the ground, in order to have better air, and should be carefully screened. There must also be a contrivance to regulate the amount of air entering. The hot-air registers should be placed in the walls at the side of the room rather than in the floor. A register in the chimney will give an outlet for bad air in those rooms adjoining chimneys.

Excellent furnaces are made that save fuel and labor, with appliances that regulate the fire, and the amount of heat given off in different kinds of weather and at different times of day.

Steam and hot-water apparatus. — These are the most common methods in cities. People differ in their opinions as to the merits of the two. Steam is cheaper to install. Hot-water apparatus gives an even heat, and once started, may be kept even for the season. Steam heat is controlled more quickly, but is more intense, and the heat is less even. With both these the secret of success is in having a large furnace with a moderate fire rather than a small furnace forced.

There are patent contrivances for regulating heat and supplying moisture, but these are not commonly found in inexpensive plants. *So here, above all, moisture must be supplied.* Have some unbreakable bowl or vessel standing on each radiator, secured by a wire if it does not stand firmly. A water receptacle made to hang on the back, containing a heavy piece of cloth like a lamp wick, may be purchased at steam apparatus supply shops. Radiators are apt to be ugly, and should be as much out of sight as possible. In the case of steam heat, if the radiator stands under a window see that it is protected by a piece of wood or metal standing out from the window sill; otherwise there may be trouble due to cool air condensing the steam in the radiator. In expensive plants hot-water apparatus is sometimes hidden in wall and floor.

Some schemes for ventilation. — In an ideal plan, fresh air, with dust removed, warmed and moistened, passes into the room in such a way that no draft is felt, while bad air is removed and carried out of doors. The air should usually come in at the top of the room, and pass out at the bottom. Inlets and outlets should be distributed over a space (say in small openings along the cornice and foot-board), and not concentrated in a few large openings. For such a system pumps and fans and shafts and flues are needed, and the cost is very great; so great that few such systems exist in private dwellings.

What, then, can the average person do? Windows and chimneys must be used. A register in the chimney, near the floor, is a good thing with any heating system. Windows may be made into ventilators by putting a board under the lower sash, thus letting in air between the sashes; if this is felt too much, cheesecloth can be placed over the opening and a board placed at an angle to turn the current of air

upward. Another plan is to lower the upper sash, and place cheesecloth across the opening. Whether air comes in or pulls out at a window depends upon the direction of the wind, and the position of the window in relation to other windows and doors. The place must be studied to see how drafts pull, and these arrangements made accordingly.

A screen as large as a fly screen and covered with cheesecloth is an excellent thing to use in all mild winter weather, and may be easily moved from window to window.

One thing we must write in large letters. **DO NOT BE AFRAID OF WASTING HEAT.** Some people are so economical of heat that they breathe foul air all winter, night and day. We should save fuel, but we must save human beings.

Remember to air rooms frequently. This may not be necessary in the twenty-first century, but it is now with our imperfect ventilation. If there is a ventilating system with fans, close all inlets and outlets in the room while the windows are open; else the whole system stops working. Airing is necessary to remove odors. Have windows open at night, in all weather. Delicate people must be protected from chill; but they, more than others, need the steady supply of air during sleep. Do not be afraid of night air. What else can you breathe at night?

Lighting the house. — The kind of light that we may have is often determined for us by the city supply, or that already wired or piped in the apartment or house. Sometimes we may choose, even in small towns and in the country. An electric trolley company often supplies light, and there are a number of methods for making a home supply of gas.

Artificial light should be steady, never flickering, lighting the room as evenly as possible, soft and not glaring, the color not too white, or bluish, or greenish, but inclined to the yellow. The placing of lights is something about which

we are often too careless. For lighting the room well high lights seem necessary; but then they need shading or softening, so that the light does not strike directly into the eyes. A better effect is obtained by side lights, moderately high, than by central lights suspended. All brilliant lights should be toned down by some soft shade of glass or other material.

In planning a house take time to see that the fixed lights in each room are conveniently placed for reading and sewing, and for toilet purposes.

A reading or sewing light should be low, shaded to protect the eyes, and to allow the light to fall upon the book or work. It should fall from the left when possible.

Candles. — Candles are still used for decorative purposes or when a soft light is wanted and for warm summer nights. Their chief defects are their flickering, and the possibility of fire. Candlesticks are now made with small glass shades, others with hoods that protect from drafts. Metal and paper or silk shades are made to fasten on the candle itself; but something attached to the candlestick is safer.

Lamps. — Nothing gives a softer and steadier light than a good kerosene lamp with a central draft and circular wick, or a lamp of the "student" type. They do not give a disagreeable odor, and are not dangerous if well cared for. A denatured alcohol lamp gives a pleasant, but rather too white light. It will not be used commonly until denatured alcohol is cheaper. One great advantage of the lamp is that it is movable, and may be placed where it is most needed at the time.

Gaslight. — The "batswing" flame is passing by, for mantle burners use no more gas, and give a more brilliant light. If you have the old-fashioned flame, see that it is even in shape. If it is not, something is wrong with the "tip." This you can remove yourself and clean with fine

wire, or sharp edge. A new tip may be needed. This kind of flame needs a shade to protect it from the motion of the air.

A mantle burner gives so vivid and white a light that a shade is required to soften it. See that the mantle is straight, and that it is not jarred. Have extra mantles on hand, and learn how to place them.

Electricity. — Where electricity is used, we need to be very careful about placing the light, and about shading it. A foreigner once remarked that we have much eye trouble in America because our lights are too bright. Probably we have swung too far from the tallow dip and pine knot of pioneer days. Doubtless, a bright electric light, unshaded, strikes the eye like a little flash of lightning. Many well-shaded and sometimes artistic lamps are on the market, and home-made shades will serve the purpose. We should be particularly careful of the eyes of little children when electricity is the lighting medium.

EXERCISES

1. State good and bad points in common heating systems.
2. Why should the pure air usually come in at the ceiling, and bad air be drawn out at the floor?
3. Send for and study the circulars issued by manufacturers of heating apparatus. They often contain plans for ventilation as well.
4. Study the heating system in your own home. Can it be improved without much outlay?
5. Visit, if possible, some large institution where there is a good system of heating and ventilating.

CHAPTER V

THE WATER SUPPLY AND DISPOSAL OF WASTE

Is it not strange that though we have almost conquered the air, we have not yet fully learned to control our water supply, and many people still trust to luck that the water they drink is unpolluted? This is one cause of the yearly deaths from typhoid, and the injuring for life of many who live through the fever. And this is only one of the evils from impure water.

What are our sources of supply? How shall we find clean water, and how shall we purify it if it becomes polluted? Scientists can tell us what to do and how to do it. We need to study the water supply and disposal of waste together, since it is waste matter that pollutes water.

Remember that clean drinking water is a matter of money. Every community can have it by paying for it.

Sources. — We may collect rain water in tanks. In Bermuda this is the only source of supply. Or we may use surface water from rivers or lakes. Or we may find a spring welling out from some hillside, coming from deep down in the earth, slowly filtered through leaves and soil. Or we may reach these hidden stores by digging wells.

How to prevent contamination. — Nature has her own ways of purifying water if we do not interfere. As water slowly passes downward through the soil it is cleansed, largely by filtration and partly by the aid of certain bacteria which oxidize the impurities. As the water flows along in a slow-moving river, or is held in a lake, the impurities tend to

settle. Air and sunlight also help to purify it. It is only when we let waste matter collect and seep through some stratum of soil into the well or spring, or when we pour it, untreated, into brook and river, that Nature cannot work fast enough and then we pay the penalty. A most terrible epidemic of typhoid in Lawrence, Massachusetts, was traced to one case of "walking typhoid," where an outhouse was built above a brook that ran into the river supply and contaminated the water of the whole city. So our watchword is: "Guard the sources from all uncleanness."

Rain water is used when other supplies are lacking. It is caught as it pours from the roof and pipes into a cistern. The pipes must be so arranged that after a dry spell the first falling water is turned away from the cistern, until all the dust has been washed from the roof, gutters, and pipes. The cistern must be cleaned out at least once a year. This gives a clean, soft water, with a "flat" taste that many people do not like.

A *spring*, to be safe, must be *above* all sources of pollution. Some town or state geologist should be able to tell you how the strata of earth lie, and what probability there is of danger. The spring should be dug out, cemented, screened, covered, and piped to the house.

The best thing to be said about a *well* is: Do not have one. If your property is large, and you know the lay of your land; and have all waste properly removed, a well is fairly safe. Or if you make an artesian bore, going below bed rock, the water is free from organic impurities, but may be "hard" with lime or iron. In a village or small town the ordinary well is too unsafe to use. You may cement it, have the surface about it clean, cover it, be careful of your drainage; even then you may have trouble from careless though quite distant neighbors. Every village and small

town should work for a common and safe water supply. Some people cling to their wells with almost personal affection.

The common supply is often brought from a distance at the expense of the taxpayer, but at a less cost in the end than the loss of human life or human vigor. The source, whether river or lake, must be freed from all filth by removing outhouses and refuse, and it must be made safe by constant guarding; in large systems there must be a patrol. Picnic parties, campers, and bathers must be kept off. Filtration plants of proper size must be installed no matter at what cost. A filtration plant is a large bed of gravel and sand through which the supply slowly filters before it reaches the consumer. Our large cities are learning this, and are spending millions of dollars; and some day our small towns will take like precautions. It is a mistake to value other luxuries above filtration plants.

Ordinary precautions. — If you use an unclean city supply, a filter on the faucet will strain out mud and large particles. Such a filter must frequently be unscrewed and boiled. If the public supply is reasonably good, faucet filters are of very doubtful value. If there is any doubt of the quality of the supply, the proper precaution is to boil the drinking water for at least five minutes. This must always be done in case of an epidemic of typhoid, which might be due to the water. The boiling "deadens the taste" by depriving the water of air, but this may be restored by letting the water stand in a clear, cool place or by pouring from one clean vessel to another several times. Boiling is also good if there is much lime in the water, in the condition known as "temporary hardness." Buying spring water is a doubtful remedy, unless you have knowledge of conditions at the source. Distilled water may be accepted as safe if the distiller uses good methods.

If drinking water is to stand, cover it.

The ice supply. — Natural ice is unsafe, for freezing will not destroy harmful bacteria nor remove dirt. Artificial ice is better, if the manufacturer is honest and the factory clean. In either case, do not put ice into the drinking water, but cool the water by putting it in bottles on the ice, or in a cooler with ice around it. “Too much trouble,” you say? Illness is a greater trouble.

DISPOSAL OF WASTE

So important is this matter that the degree of perfection reached seems the measure of the real civilization of any community. Most cities and small towns keep the “best” streets free of litter and filth; but look at the back yards along our railways, the vacant lots between apartments and houses, the river banks in manufacturing towns, the dump heaps where the town is filling in and “making” land, and you will see that we have much to learn, and much to teach. It is not enough in these days for the housekeeper to see that her own premises are tidy. She must work in some way with the whole community to see that good methods are used in street sweeping, disposal of sewage, food waste, and all the rubbish that is thrown in the scrap heap of the human family — ashes, tin cans, old iron, old shoes, and paper. “Out of sight, out of mind” has been the easy motto of the past, meaning out of our own sight, but not our neighbor’s always. Fire, earth, and water are coworkers with us if we use them aright.

The isolated house. — On the farm, or small place of a few acres, we can take care of our own waste, without trouble to our neighbors. Food scraps are given to animals. Everything burnable, like paper and rags, can be disposed

of in the stove or by bonfire. A large, cylindrical basket, made of a piece of woven wire fencing and standing at a safe distance from buildings, will hold this kind of refuse for several days, and it can then be burned in the basket, when the wind is not strong. Tin cans and unburnable material may be buried in a hole dug for the purpose, and kept covered. Such things should not be carted away and emptied by the roadside. Slops may be carried off in pails on a barrow, and poured on a different spot each day. An earth closet should be used, with pails that can be taken out and carried off, the contents to be burned. Wood ashes are used as a soil fertilizer; coal ashes for filling in.

If there is water piped into the house, waste is usually piped out. In this case the isolated house may have a cesspool, preferably constructed on the "septic tank" principle. It should be dug deep, and constructed so that it may be self-emptying. It should be cemented, and divided into two compartments. The waste passes from one to the other, and when completely liquefied, passes out by a system of pipes and tiles into some open field where it is taken up by vegetation. The old-fashioned cesspool in the back yard is a constant menace.

The village and city. — Here there must be community work. The outhouse with a vault and the cesspool must be banished, and some system used for the whole. Sewage can be piped out into a field at a proper distance, and distributed over the surface much as in irrigation, the surplus water draining into some brook or river after it has been thus thoroughly filtered through the soil. This "sewage farm" method has been tried at the Experiment Station on the Merrimac River, Massachusetts, with success. The septic tank treatment followed by filtration through sand may also be used on a fairly large scale. Sewage should never be

poured unchanged into a river, on account of other towns below. If sewage is poured into salt water, the pipes should run far out and reach the deep tide current, and even so the sewage should be screened. For disposal of other kinds of waste on a large scale there are ample methods, if the taxpayers will only believe it is worth while to pay the bills. The city may partially pay expenses here by selling usable rubbish.

Within the city house. — Have proper cans to hold waste, and obey the city ordinances. In New York City, for instance, food scraps and paper should be kept separate. This is a rule made by the authorities, because paper and food scraps are finally disposed of by the city in different ways. Whatever the town rules may be, obey them. If you find they are inadequate, help to get them improved.

Plumbing. — This is one of the vital things in the house, upon which good health depends. The plumbing system brings in water and takes out waste, with water as the cleansing and carrying agent. The waste pipes must be of iron, tight at all joints, and large enough to carry off all material without clogging. They must be placed in positions that insure a rapid and steady flow. Noxious gases must not be allowed to collect and pass into rooms. Ventilating pipes, called vent pipes, are connected with the waste pipes so that gases pass upward and out above the roof. Water is used to prevent the gases from rising into the room, and is called a water seal. The water is held in a bend in the pipe called a trap.

1. **The trap.** — Figure 14 shows a cross section of a trap, called the S trap on account of its shape. This is still considered the best form of trap, although there are others on the market. Notice that it is a perfect trap for holding the water; but when a basin is emptying, it allows a rapid

passage, and so it does not hold solid particles such as hair and lint. Notice that there is an opening at the lowest part of the S to be unscrewed with a monkey wrench for cleansing the trap once in a while. There may be a collection of lint, or grease in time, even when the traps are well flushed daily.

Each basin, sink, tub, and closet must have its own trap. If two basins are connected with one trap, the water may sometimes pull out or "siphon" from the trap.

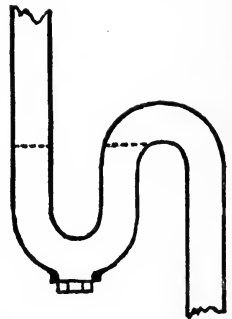

FIG. 14. — Cross section of an S trap.

2. **Sewerage system.** — Figure 15 illustrates the main parts of a house system. (1) is a basin, with (2) its S trap; (3) is a pipe two inches in diameter, (4) is a vent pipe for gases; (5) is the house pipe, four inches in diameter, and laid at an angle; (6) is the large S trap between the house and the sewer; (7) is another vent pipe; and (8) is the city sewer pipe.

3. **Plumbing attachments.** — These include basins, sinks, bathtubs, laundry tubs, water-closets, with the smaller metal attachments belonging to each.

For these receptacles a good porcelain or vitrified material is by all means the

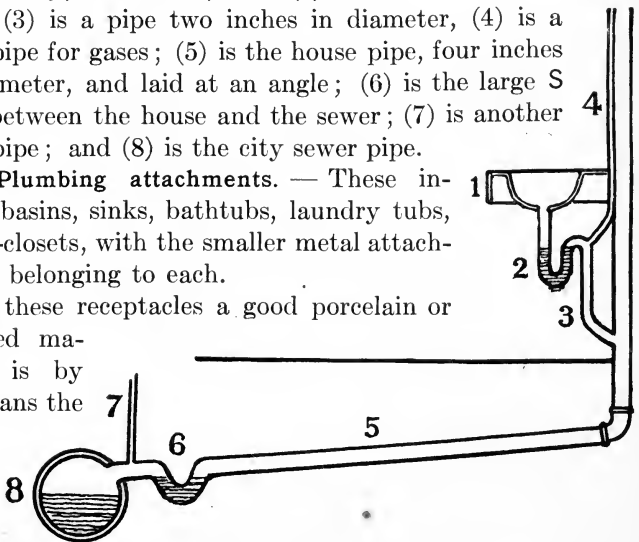

FIG. 15. — Diagram of the main parts of a sewerage system.

best, as it is sanitary and lasting. Nickel plate is better than brass for the small attachments, as it is easier to keep clean than brass.

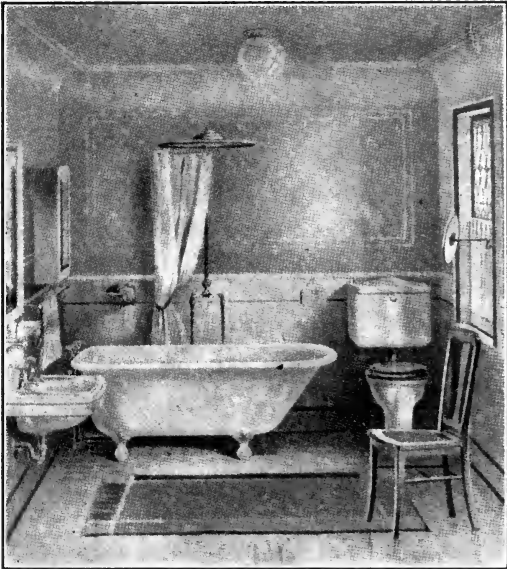

FIG. 16. — A well-fitted bathroom, the fixtures sanitary and simple.

Figure 16 shows a well-fitted bathroom. Notice the simplicity of the support of the basin. How easy to keep the floor clean beneath. It would be even better to have the type of tub that rests on the floor. For general furnishing of bathroom, see next chapter.

Figure 17 gives a cross section of a basin. Notice that there is no chain for the stopper. The "waste rod" (1) acts directly on the stopper. The stopper (2) in basin is operated by turning the handle (3). This particular device is said to be simpler in construction than any other of this type.

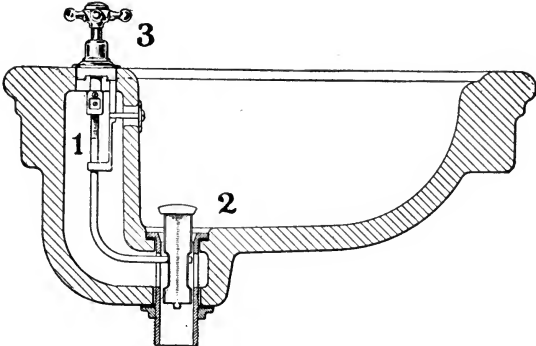

FIG. 17. — Cross section of a basin.

If the faucet is one that turns on and runs steadily, an overflow is needed. This overflow is not easy to keep clean.

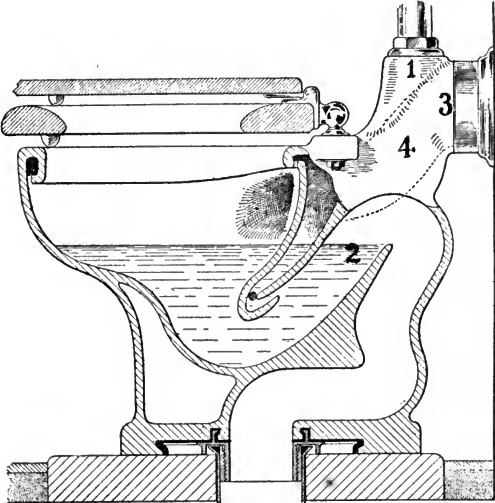

FIG. 18. — Cross section of a siphon water-closet.

It is better to have the type of faucet that needs a steady pressure to keep up the flow.

Figure 18 shows a cross section of a siphon water-closet. The jet of water is concealed from view and passes in from the pipe at (1), the water rushes out of (2), the vent for gas and odors at (3) is said to be the best. The construction is such that the vent is above the top edge of the closet, so that any overflow taking place from stoppage in the closet is not forced into the vent pipe, and each time the closet is operated the vent chamber (4) is flushed, as well as the bowl. This closet is also more noiseless than many.

Care of plumbing. — All basins must be cleansed daily with hot and cold water. Once a week wash out the traps with a solution of caustic soda. If leaks in pipes are suspected, pour peppermint oil in the vent pipe of the roof. If the odor is detected anywhere in the house, send for the plumber.

EXERCISES

1. Find out the source of water supply in your own town. Visit it if possible.
2. If a small town or in the country, find out the geological structure of the country. There are always government reports to be had that will describe this. Decide where a well might be safe.
3. Explain how a mass of threads and lint lying in an S trap with one end in the trap and the other lying over the curve of the trap would affect the water seal.
4. Open a trap with a monkey wrench, having a basin below. Cleanse it thoroughly and replace the screw.
5. What principles of physics are illustrated in the action of the water-closet, Figure 18?

CHAPTER VI

DECORATION OF THE HOME

FEW people realize the effect that a well-decorated and well-furnished home has on the daily life of a family. It produces an environment of harmony, of beauty of form, line, and color; and the general atmosphere resulting from this harmony is conducive to better living. In the past this work has been put largely into the hands of the experienced decorator or left to the haphazard working out of those who did not know or who were guided by intuition rather than principles. The girl of to-day and to-morrow should have a fund of information along these lines that will aid her in surrounding herself and her family with the colors and forms that tend to promote an atmosphere of restfulness in daily living. Many people who have not technical artistic skill can make home attractive, and this is as much an expression of the artistic temperament as the ability to paint a beautiful picture or to model a statue. It is very important, for it is helping to make life more beautiful through the adaptation of art to everyday things. The desire to decorate, to beautify, is inherent in the race, and the most primitive peoples give evidence of this in their houses, tools, and dress.

In successful home furnishing, the æsthetic aspects together with economy and hygiene should be borne in mind. Too many homes are furnished simply for show without relation to health or pocketbook.

Beauty in house decoration depends upon the harmonious

relation of parts and of each part to the whole. The aim should be to make it as simple as possible, and appropriate, in that it is adapted to one's mode of living. William Morris said, "To give people pleasure in the things they must perforce use; that is the one great office of decoration." The home should be refined and inviting — a place that it is a pleasure to enter — where cheer and comfort greet us and the atmosphere is one of rest.

Much of this general atmosphere can be produced through the right kind of house decoration. Bright colors and showy effects with exciting combinations do not tend to produce an atmosphere of repose. The interior should be simple and an honest expression of the life within the home. Young people starting a home will find it wise to select articles with thought toward appropriateness and serviceability. This requires a definite plan before purchase is made, for it means a consideration of the whole life of the home, spiritual as well as material. The problem of those who are already established in homes is more difficult, for this often necessitates the utilization of present belongings in the attempt to produce harmony. Sometimes this will call for the disposal of much that is ugly, though valuable. The articles about the home should express the individuality of its members and should be honest, simple, and true. Is the furnishing of use? Does it please in color, form, and decoration? Is it durable? All these questions help one to decide whether the furnishings are to be discarded or whether they shall remain a part of the daily life. It is not good taste to accumulate a quantity of useless articles in the home, but rather to select a few things that will add to the comfort and well-being of the family. Do not forget in selection the suggestion, "Decorate construction, do not construct decoration."

Unity. — The first guiding principle then in the selection of decorations and furnishings for a home is the thought of unity. Some definite scheme should be adopted in planning the whole apartment or house. This idea should be kept always in mind when the decorations and furnishings are selected. In those things that nature clothes, there is unity — a freedom from disturbing and unrelated elements. This unity we find is due to proper relationship of shapes, lines, dark and light, and color. With this idea in mind one would never decorate in bright red a room opening into one of lavender treatment, or place a set of dark stuffed furniture in a country home where only wicker and chintz or light furnishing would be appropriate. No object should intrude itself, and one should be conscious at first only of a delightful whole. Decoration is for the purpose of producing this harmony, it is not simply for ornament.

Simplicity in house decoration and furnishing is evidence of good taste. It will prefer the things that are appropriate and which meet the needs of comfort and daily living. Simplicity of taste means that conglomerate mixtures of all kinds of materials and furnishings will not be tolerated. One picture of good print and simple framing will be preferable to several bright chromos or large family portraits in gilt moldings; one simple vase with a beautiful spray of apple blossoms has more beauty than an exhibition of bric-a-brac such as many homes exhibit. Use as well as beauty if kept in mind will guide.

Appropriateness. — In planning avoid the selection of unusual or pretentious furnishings or decoration. The furnishings should represent the ideals and the standards of living of the family, should be within the income, and should be appropriate to the station in life. A Louis XV drawing-room would not be an honest representation of a college

professor's life, even if he could afford such furnishings. Ideals as well as ideas influence selection. Simple wicker furniture and muslin curtains, if one can afford them, are better than cheap imitations of fancy brocaded satin draperies and upholstered chairs. The principle of appropriateness must be borne in mind in the furnishing of each room. Uncomfortable chairs do not suggest the ease and restfulness of a living room or heavy draperies and thick carpets the healthful or inviting bedroom. The use of articles often determines their appropriateness. "Dust collectors" are seldom useful or appropriate, and much time is consumed in dusting useless bric-a-brac, furniture with much carving, twisting, and ornamentation that is neither beautiful nor suitable. One would not expect to find upholstered chairs or velvet carpet in a kitchen, and neither should one find inappropriate furnishings discarded from other places in the bedrooms or living room.

Decoration must take into consideration also the principles of good line, dark and light, shape and color. These principles will be shown in their application to dress (Chapter XIX) and are as truly applicable to questions of decoration and furnishing of the home.

Good "lines." — The home selected may not have good form or "lines." If built according to one's plans and ideas, it is possible to keep the proportions in proper balance. If this is carefully worked out, homes so constructed will not need as much decoration, for the pleasing "lines" and proportions are decoration in themselves. Houses, like people, must be so decorated by dress as to bring about the most harmonious effect, and to correct the poor lines of inartistic construction. Some suggestions will be given under wall coverings for changing the effect of fixed lines. There should be no jerky angles, but a rhythmic flow of lines one

within and into another. The proper arrangement brings about design and space relationship, which must be carefully considered in choosing wall coverings, draperies, rugs, and other furnishings.

Color.¹ — Many women fail in their schemes for home decoration because of a lack of real appreciation of color. This is due to the fact that the color sense needs training, which is sometimes difficult to attain. Appreciation is often inherent and a part of one's being because of early associations, travel, and training, which come in life to some, and from which others are debarred. Every girl in her high-school art classes will have opportunity to study color. To think about color in daily living is a good way to study it. Notice what nature teaches. Observe the sunsets on a clear day, then on a misty one when all is rather gray. Notice the wonderful backgrounds of middle values of gray and purple, brown and green. See how the bright colors are placed in little patches by way of relief and determine the relation of these color combinations to the problems of dress and home decoration. (See color suggestions under dress, Chapter XIX.)

Color schemes in relation to light must be carefully considered. This will be explained under selection of wall coverings. Gradation of color is a part of every correct scheme in home decoration. The dark values and less intense colors should always be at the base, consequently ceilings are light in value and walls of intermediate value and intensity. Very often they flow one into another without sharp lines of contrast. Contrasting colors or complementary colors should be used carefully, as this arrangement of decoration tends to make both colors stand out. Suc-

¹ "A Color Notation," A. H. Munsell, is suggested to the teacher for color theory.

cessful combinations provide for the use of a large amount of one color and a small amount of the contrasting color, which is always in subordinate relation. In planning color schemes, those having one predominant color will be found very pleasing for simple interiors.

With these general principles in relation to furnishing and decoration one can begin to consider in more detail the problems of decoration.

After the house is selected, the first problems in decoration relate to floors, woodwork, walls, and ceilings. These should really be considered together as well as in the relationship of one room to another. It is desirable to have an effect of unity and harmony. For convenience in study, the walls will be discussed first.

The wall decorations. — Before choosing the particular decoration for any wall, there are several problems which confront the home maker and which should be considered before choice is made. The location of the room, its size, shape, exposure, use, — all affect selection if a harmonious whole is to be the result. In considering the walls, questions of sanitation and protection are as important as decoration. The painted wall is most sanitary, for it can be cleansed with soap and water and permits of some decoration in the way of stenciled borders, etc. Wall papers sometimes decay and become infected with germs. They therefore are not as sanitary as painted walls. This makes paint especially preferable to paper in the case of the bedroom, as well as the kitchen, pantry, and bathroom. Walls are often covered with burlap, canvas, Japanese matting, muslin, or rough plaster, and for decoration these are sometimes painted. Paper is the most common wall covering, and many beautiful effects can be obtained with it. Its use is more general because it is as a rule cheaper. Care should be taken to

keep it clean, and it should be changed after a certain period of use.

In selecting wall decorations, the question of light is one of primary importance and the location of each room should be carefully studied. Light enters usually from the sides only, and we have not only direct but reflected light from all the wall and ceiling surfaces. This should be considered in decoration when the question of too little light necessitates a light wall covering, or too much one of darker value to absorb the brightness and light. Colors of strong chroma and dark value absorb a great deal of light. When there are few windows and the interior is gloomy, a bright wall covering of cream, yellow, pale green, or other bright color value with white woodwork will produce a light effect because of the reflection as well as the decoration itself. The question of the particular hue, value, and chroma of color to be used will depend on the amount of light admitted to the room by day as well as its lighting at night. On the north side of the house one should have some warm color to balance the deficiency of light and warmth from the sun. Yellow in various values, or other warm colors, such as the so-called reds, terra cotta, tan, golden brown, buff, etc., should be used where north light predominates. When rooms are located with a southerly exposure and there is plenty of sunlight, the cool colors are most effective—the light values of green,¹ blue, lavender, tan. Bright yellow or reds are not needed in a sunny room, neither are cold greens or blues comfortable in one of northerly exposure.

The color of the woodwork and floor also affects the predominant color of wall surface. If the woodwork is painted, it can be changed more easily to harmonize with the wall

¹ It should be remembered that green, blue, and lavender papers in a sunny room are apt to fade rapidly.

color than can the varnished or stained woodwork of modern houses. This harmony of color with woodwork as well as the daylight and sunlight of a room should be carefully weighed in choosing color. If furnishings have been bought, they too should be kept in mind in the selection of color of wall covering for the various rooms.

The use of the room as well as its exposure should affect choice of wall decoration. Bedroom walls should be covered simply and quietly. Such rooms are primarily for rest. The kitchen walls as well as the bathrooms and pantries are best painted green, tan, or buff, a warm or cool hue according to location and amount of light. The living room walls should be treated with something which will be unobtrusive in color and design, as it is the room where the family collects usually for rest at the end of the day. The dining room should offer cheer, and certain values of tans, blues, and reds, according to the amount of light, are always pleasing.

The size and shape of the rooms are also of primary importance. If the rooms and halls are small and open one into another, an effect of unity is produced by deciding on one rather light color for all. This effect produces a feeling of spaciousness, for light colors make small rooms look large as dark ones tend to make large rooms look small. If the ceilings are low, stripes will emphasize the height. Borders should be omitted in rooms with low ceiling, as they break the line between wall and ceiling and detract from the height. If the ceilings are high, the effect of the height may be broken by carrying the color of ceiling down on the side walls or using a border with the picture molding below. This horizontal effect detracts from the height.

The walls should be considered as a background for the pictures, furnishings, and life of the home, and must be so

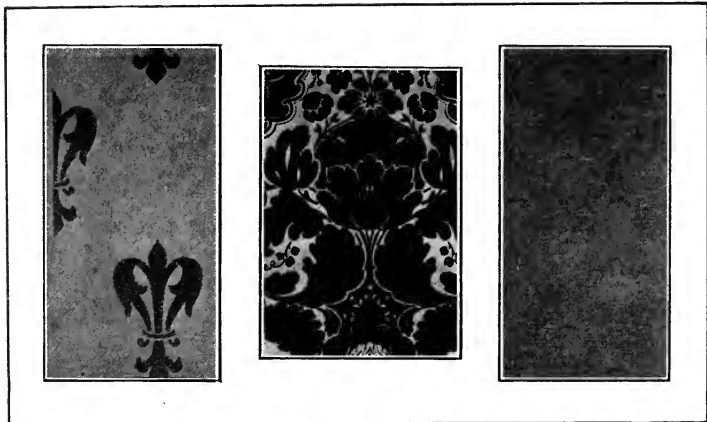

1

2

3

FIG. 19. — 1. A poor surface pattern. 2. A poor surface pattern. Bad in dark and light; rather good in line. Original too intense. 3. A good surface pattern.

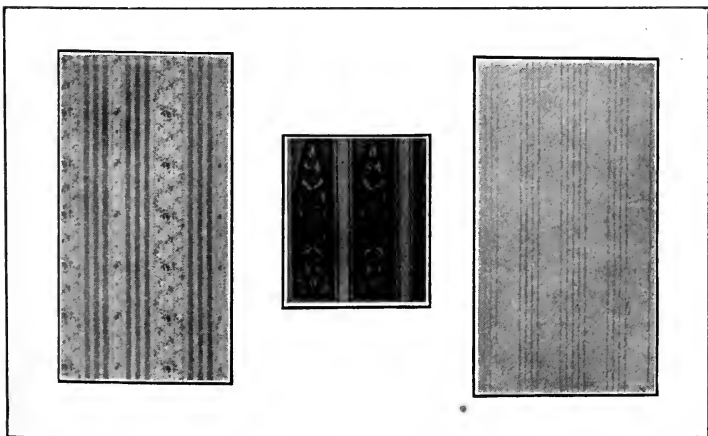

FIG. 20. — A poor striped paper between two good ones.

harmonious, that they will tend to unite the whole, and yet remain the background and confining outer limit. Color in wall covering is, therefore, very important in its effect on the atmosphere of the home. Red is known to be very exciting and to tax the nervous energy of the occupants; while strong blues and cold colors, especially in sunless rooms, may have a depressing effect. Yellow values add to the sunniness and cheer; and browns, tans, and grays have a calming influence. The study of color is very important in its many combinations and possibilities. The soft colors, that is, those of low chroma and middle value, are the most pleasing, for they make good backgrounds which harmonize well with the woods of furniture, floors, and woodwork, and thus unite the whole.

Plain papers make the best background for pictures, as they throw in relief the subjects of interest. Plain papers are more restful than figures, and one does not grow so tired of them. They are more apt to show spots or soil and, especially in a hallway, though they are pleasing, they are not durable. Cartridge papers of good soft colors make effective backgrounds, as do burlap, linen, and matting in plain color. These may be relieved by a decorative band or border near the ceiling, the width of which will depend on the height of the room. Borders may be stenciled on plain paper, or designs cut from figured paper may be arranged to form a border and give a finished appearance.

There are many excellent inexpensive calcimine tints and water color paints which are produced in good shades. They can be used on rough or smooth plaster, burlap, muslin, or any surface used for walls. Oil paint, though more expensive, is always sanitary and pleasing, especially in the dull finish.

Figured papers are preferred by many, but great care is necessary in selection in order to obtain harmonious

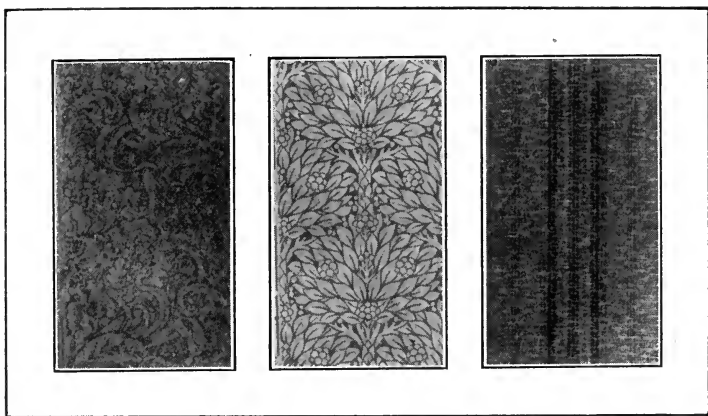

1

2

3

FIG. 21.—1. Good surface pattern. If dark and light contrast were stronger, this would be bad. 2. Good surface pattern—good in dark and light and line. 3. Good surface with effect of stripe.

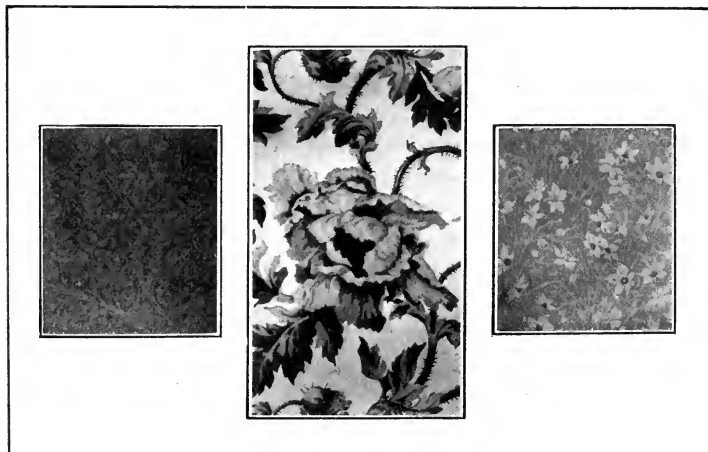

1

2

3

FIG. 22.—1. Conventionalized floral design in two values of green. Good floral surface. 2. A poor floral design. Too strong in contrast. 3. Good floral wall covering; value relation about right.

effects. The use, exposure, and furnishing of the room should all influence choice (see Fig. 19).

Striped papers are good in many places (see Fig. 20). They accentuate the height of a room and are dignified. There should not be great contrast in color between the stripes, for this tends to emphasis, and the pronounced dark lines will stand out in an unpleasant way. The width of the stripe should depend on the size of the room. Broad stripes would be out of proportion in a small room, as they would tend to lower and narrow the effect.

There are many excellent patterns in wall paper, and they should be chosen with the room in mind. Be sure that the principles in relation to pattern are considered, for the shops show many that are ugly and distressing. The plain patterns are usually the best. All-over patterns, in which the figures connect, are more pleasing than those in which spots of repetition stand out in relief (see Fig. 21). Figures of all-over patterns in two or three values of the same hues are more agreeable than those of contrasting hues. There are many ugly scroll patterns on the market. Beware of these. They are particularly bad when carried out in contrasts of color so that one feels bewildered by them on entering a room. The wall as a flat surface should not be covered with bouquets or flowers which appear waiting to be picked (see Fig. 22). The designs should be flat, and good decoration will represent the floral or fruit designs conventionalized and adapted to the flat surface. Avoid glaring contrasts of color and design. Large figures are suitable only for large rooms.

Borders and friezes should be used with figured wall covering only when the height of a room will permit, and should not be used at all unless the border matching the paper is good in design. The walls of some rooms may be of proper

height to permit of a combination of figured and plain covering. This combination is very effective, and is usually so arranged that the lower $\frac{3}{4}$ or $\frac{2}{3}$ of the space is plain, with the figured paper above. This gives the appearance of a wide border and in a large room is very effective.

Ceiling effects should be unobtrusive. The lightest values of color scheme should be used there, for it must be remembered that the ceiling acts also as a reflector of light. Scroll effects and gay color are not suitable, but light creams, grays, and tans which harmonize with the walls are always good taste.

Picture moldings should be carefully placed, for they form a horizontal line around the room and may break the space in wrong proportions. They are usually placed at the top of the wall covering close to the ceiling or below the border. When the ceiling color is carried downward to make a high room look low, the molding is put below it, and about on a level with the tops of the doors or windows. Avoid over-elaborate, highly colored moldings. The simple ones of natural wood or color harmonizing with the walls are always the best.

Floors. — The floors of each room should be considered in relation to use, furnishings, woodwork, and wall decorations. These should all harmonize. The floor is the foundation and a background for decoration, and much of the final harmony will depend on its treatment in color.

It is certainly more hygienic and it requires less work to have *bare floors* with rugs. Rugs may be cleansed more easily than carpets and the wood may easily be kept free from dust. If the floors are old and the boards not too rough and uneven, it is possible to fill the cracks and holes with a good filler and then paint and varnish or stain and varnish them. The question of the kind of finish will

arise, and it will depend on the cost, use of room, etc., whether the floor is to be waxed, painted, or varnished. Light values of brown are usually good, and harmonize with furnishings and at the same time do not show the dust. The durability of floor finish should be carefully considered, for much labor may be saved by selecting the proper kind. The manufacturers of paints and finishing varnish have many varieties for all kinds of woods and all conditions of floors. Careful consideration of conditions is necessary in selecting the finish. Some of these bring out the natural beauty of the wood if the floor is a new one. If it is impossible to have hard wood, good yellow pine makes an excellent floor.

Hardwood floors are the most beautiful and quite hygienic. These can sometimes be laid over old floors if the surfaces have been planed. Oak and maple are perhaps the most satisfactory. These can be left the natural color except for the filler and wax or other finish, or can be changed in color by staining. If the color is too light, as it is in some natural finishes, the lack of harmony with the walls and woodwork may destroy the color scheme. Rugs of carefully selected color may then be used to bring about the right balance. The finish is important. Good wax gives a beautiful smooth surface and lasts a long time. Hardwood floors are expensive in the beginning because of the filling, staining, varnishing, and waxing, but are so durable that they may be kept in order for a long time with very little extra expense, while carpets must be often removed and changed to be hygienic. Waxed floors may be well preserved by treating occasionally with a new coat of wax. This must be well rubbed in, which makes the cost greater than some other finishes.

Kitchen floors are often a problem. There are many floor

coverings on the market of inlaid rubber, cork, and other materials. Some of these are very satisfactory, many are expensive. The inlaid linoleums can be bought in good colors and geometric designs and are very serviceable. Wood is often used for kitchen floors. Maple is very dense and a treatment with oil will tend to prevent the wood from absorbing grease.

Linoleum or soft wood painted and varnished makes a good bathroom floor when it is not possible to have hard wood. Color is again important in order to have an unobtrusive background. The linoleum is easily cared for and can be laid over any kind of a floor provided the boards are even. An uneven warped floor will cause the linoleum to wear. Good linoleum costs \$1 or more per yard.

Floors for any part of the house where scrubbing is not necessary can be filled, stained, varnished, and waxed, or in place of varnish, shellac can be used.

Woodwork. — Woodwork can be painted, stained, or finished with varnish or wax. Color as well as durability must be kept in mind. White, gray, or cream is excellent when these colors harmonize with color schemes. In Colonial decoration white woodwork in harmony with mahogany rails is characteristic.

To secure good results in properly finishing woodwork with wax or varnish requires much labor. This, however, pays, for it is most durable. It must be rubbed thoroughly in order to get a satiny, glossy finish. Varnish when left shiny is most inartistic and cheap looking. The woods are usually finished to show the grain. They are filled, sometimes stained, and finally finished with wax or varnish. If stained, the color of walls, floors, and furnishings should be considered, and the stain should not be obtrusive in color.

Sometimes soft wood is painted to represent the grain of

hard wood. This is not good taste, for it is not honest. Such a finish is called "graining," and painted surfaces are made to imitate oak, or the grain of other wood surfaces. A plain painted surface of suitable color is preferable to this.

It is not necessary to have hardwood trim in order to get pleasing effects. Yellow pine and some of the cheaper woods, when stained in gray or brown and well rubbed down, can be made to give most artistic results. A little experimenting is worth while.

After the walls, floors, and woodwork of the house have been carefully considered in relation to color schemes, finish, etc., it remains to place one's belongings or to select new articles. Successful furnishing of the rooms depends on the harmony between the articles of furnishing; this may exist in most humble interiors and depends upon careful selection and orderly arrangement.

Floor coverings. — A great variety of floor coverings is on the market from which choice can be made.

Carpets of various kinds have been used as floor coverings for many years. At best, they are not hygienic unless often removed and cleansed, which is seldom practicable. In most old houses floors were finished rather roughly, and carpets were used for warmth as well as beauty. When it is necessary to use carpets, they should be carefully chosen in reference to the size of the room and the color values of the walls and woodwork. A plain color is often advisable, and can be used with rugs that are not too pronounced in color or design. Greens and browns are usually good. A carpet with large scroll pattern or bunches of Easter lilies is not good taste because obtrusive. It is not a good background for the rest of the furnishings. The carpet should be restful, the size of the design depending on the size of the room, and the colors not too many in number, preferably two values

of one hue. It is wise to have the floor colors of darker value than the walls and woodwork, but in harmony with their value and intensity. This color harmony should also be kept in mind in selection of matting or rugs as background for furnishing.

Carpets of Body Brussels, Wilton, velvet, and ingrain are the most popular — when carpet is to be used. Japanese matting and other fibers are inexpensive if the floor is to be entirely covered. In selecting these good color and unobtrusive designs are best, and can be used with a few rugs to relieve the monotony or with one large rug covering much of the central part of a room. Do not forget that a good-sized rug makes a room look larger than several small ones.

There are many varieties of *rugs* on the market from the beautiful durable Oriental to the rag rug woven at the farm home or by local weavers. The Oriental rugs are beautiful in texture and coloring and are choice possessions. These rugs were first used by the tent-dwelling peoples for wall as well as floor coverings, and were things of sentiment as well as beauty: wedding rugs, dowry rugs, prayer, throne, and grave rugs — all woven in symbolic designs with wonderful colors of wools and silks of beautiful texture. Much of the wool for modern Oriental rugs is still spun by hand, and the rugs are woven with much patience and diligence, as each little knot is tied to make the pile of the rug. They are really mosaics in wool. Rugs from the East are imported from many districts and have many names, Turkish, Caucasian, Persian, Turcoman, Indian, in many varieties. Oriental rugs should be selected by one who understands their value, or the purchase should be made from a reliable house. The value depends upon many things: the number of knots to the square inch and the length of the ends, the beauty of design and color, the quality of the materials used,

the dye, and the manner and care with which the weaving is done. A study of the various kinds with their characteristic designs is most interesting.

There is great variety in American rugs; those of Body Brussels and Wilton are the most serviceable and are sold in good colors and patterns. The "Smyrna" rugs are soft and reversible, and there are other good wool rugs, many of which have patterns in two values of one hue, as border design or good simple figures.

The old-fashioned braided rug and the rag rug are useful for certain kinds of furnishings. The old-fashioned patterns of "hit and miss" are sometimes distracting, because of the way in which the white is introduced, but when woven with a plan so that the spacing, line, light, and dark have been kept in mind, they are quite pleasing.

EXERCISES

1. Mention five general principles to be kept in mind in house decoration. Explain how each affects harmony of atmosphere.
2. What principles affect the selection of wall covering for a room?
3. Explain the relationship of woodwork and floor treatment to wall covering.
4. Bring in samples of good wall papers for a bedroom, living and dining rooms of a modest eight-room house.
5. In all house decoration and furnishing what are the important things to remember about color?

CHAPTER VII

FURNISHING OF THE HOME

Furniture. — There is perhaps no more delightful task in home making than the selection of furniture for the new home. A few fortunate people are the happy possessors of heirlooms of beautiful Colonial mahogany (see Figs. 23, 24). There is always a place for these in a scheme of house decoration because of their beautiful simplicity of line, decoration, and finish. They should be treasured and preserved. Those that have been disfigured by generations of poor varnish may be restored. The majority of young people, however, in furnishing their new homes need some guiding principles which will help them to select modern furniture wisely.

It must never be forgotten that furnishings express the taste of the individual making the home. They are a part of the individual and show his ideals for life and standards of taste and beauty. The ethical influence of well-made and well-designed furniture is difficult to estimate, and is one of the most interesting features of the really successful home. It should yield utility and comfort, and furniture, in order to be beautiful, should be simple and strong in construction, with good lines. It should also be appropriate. With such principles in mind there will be fewer gilt chairs selected, ornate and insufficient in strength to hold an average person.

It is better to furnish slowly and to choose one good piece at a time than to buy whole "sets" with superfluous pieces. Most people have too many pieces of furniture in

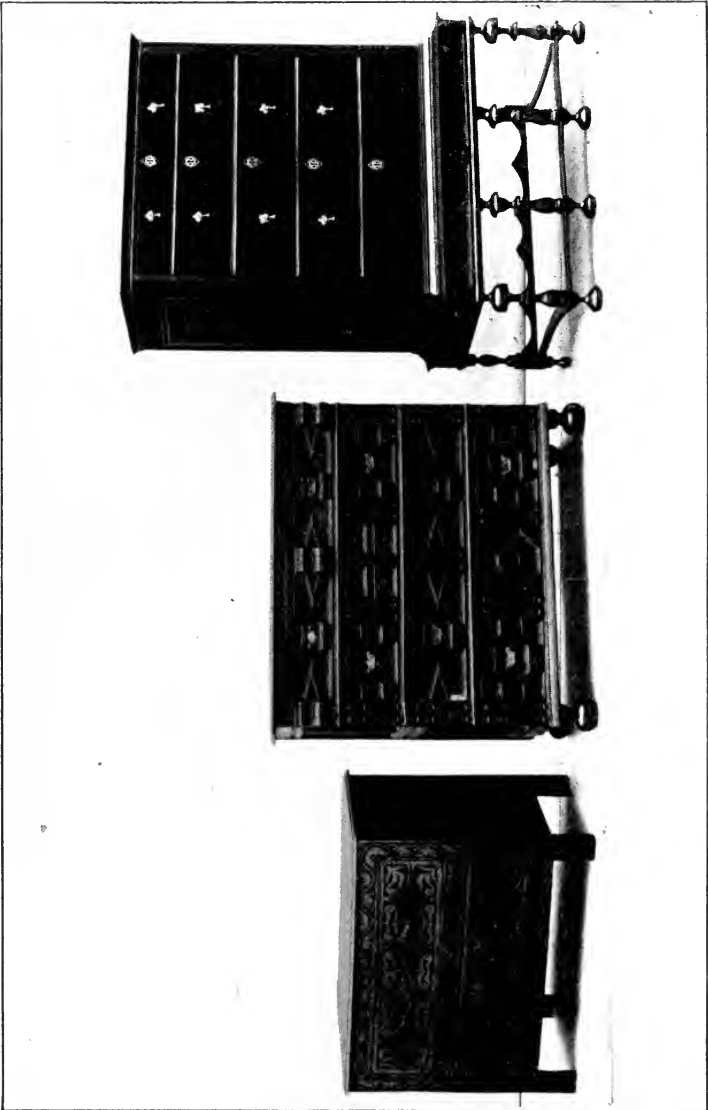

Courtesy of Metropolitan Museum of Fine Arts.

each room; a few of real purpose and well placed are more pleasing. A wise rule is to choose only those pieces that meet the needs of the users. This necessitates a careful study of old furniture as well as the new styles and productions of the leading manufacturers. It is better to buy one durable piece with good lines than three that will soon go to pieces and be of no service. Real antiques are very expensive, but there are to-day excellent reproductions of the furniture of our great grandfathers, and the simplicity of line of the Colonial assures us that the style will be a permanent one. We have really no new shapes, but the copies of the old English and Colonial times are so well reproduced, especially those of the seventeenth and eighteenth centuries, that a brief study of those periods should help one to choose intelligently.

Our cabinetmakers to-day owe much to the designs and models that originated in England and were copied by the



Courtesy of Metropolitan Museum of Fine Arts.

FIG. 24. — Colonial table.



Courtesy of Metropolitan Museum of Fine Arts.

FIG. 24a. — A sideboard of Sheraton style. Notice simple lines.

furniture makers of New England. The influence of four firms of English cabinetmakers is strongly felt in the reproductions of to-day. They were in reality artists: Thomas Chippendale, A. Heppelwhite and Company, Thomas

Sheraton, James and Robert Adams. These were all eighteenth-century designers. The Adams furniture was formal, ornate, and costly. The Chippendale showed traces of Dutch and Chinese influence, and the ornamentation of French style (see Fig. 25a). It was characterized by fine

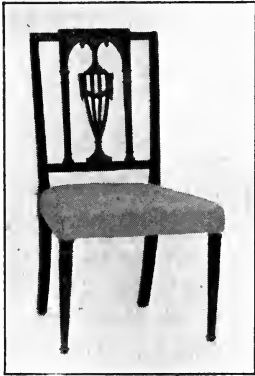

Courtesy of Metropolitan Museum of Fine Arts.

FIG. 25. — Chair of Sheraton style.



Courtesy of Metropolitan Museum of Fine Arts.

FIG. 25a. — Chippendale chair.

proportions, rather elaborate carving, and the bow form at the top of the back of chairs. The claw-and-ball foot is also characteristic. The Heppelwhite is characterized by graceful lines, and is lighter than the heavy Dutch styles which had previously influenced English furniture making. Carving and inlay were used in the backs of chairs as well as designs of paint or Japanned work. The backs of the chairs were oval, heart, or shield shaped (see Fig. 26a). Sheraton styles were somewhat similar to Heppelwhite, but the chairs were characterized by more rectangular-shaped backs (see Fig. 25).

Other styles were of such periods as Louis XIV and XV, Spain under Moorish influence, Holland of the sixteenth cen-

tury, and England under William and Mary as well as the Georges.

In the furnishing of the American home of to-day the styles of the early Italian and French are disappearing and the reproductions are rather of the more informal types from the time of William and Mary to the end of the seventeenth century. The comfort and the beautiful lines of these styles are better adapted to our mode of living than the elaborate Italian and French designs.



Courtesy of Metropolitan Museum of Fine Arts.

FIG. 26. — A good modern chair of Heppelwhite type.



Courtesy of Metropolitan Museum of Fine Arts.

FIG. 26a. — Heppelwhite chair.

“Mission” furniture as well as the Craftsman is a modern style. It lacks grace, and is often extremely clumsy, but is honest and simple. It is made of oak and will last for generations. It is comfortable as well as durable and has a place in modern furnishing (see Figs. 27, 28, 29).

“Cottage” furniture is well adapted to use in summer homes or where it is necessary to furnish at moderate expense. It is in good style, simply finished, and durable — a

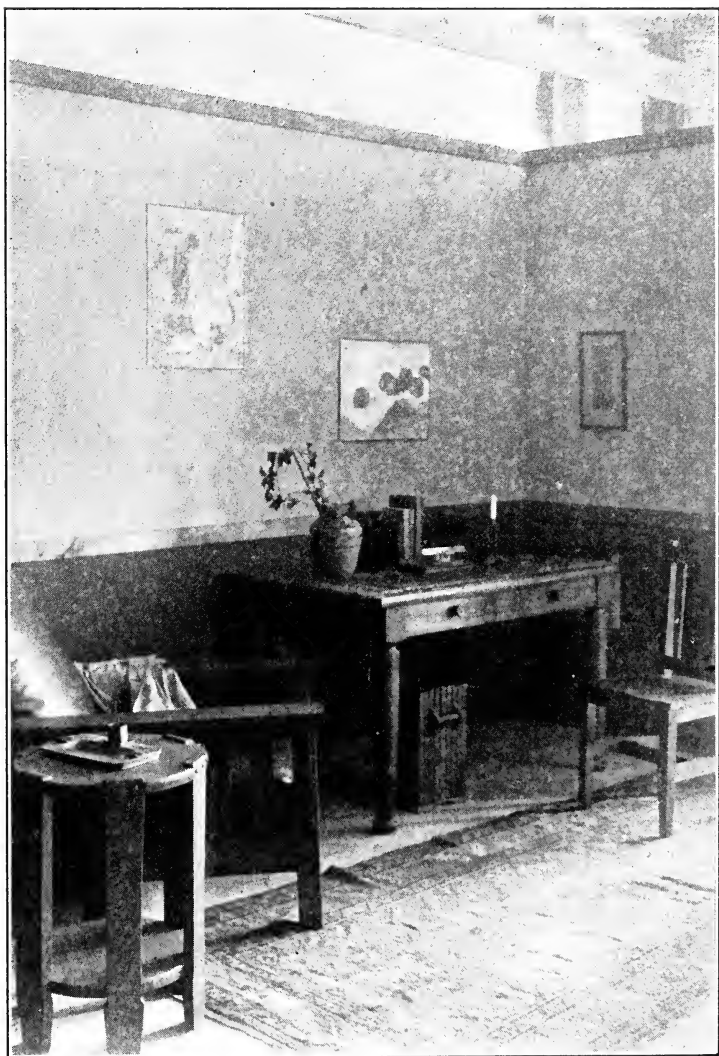

FIG. 27. — A simple arrangement showing use of Craftsman furniture.

great improvement on the cheap, painted, beflowered cottage furniture of the past. It is dignified, easily cared for, and less expensive than the Craftsman (see Figs. 30, 31).

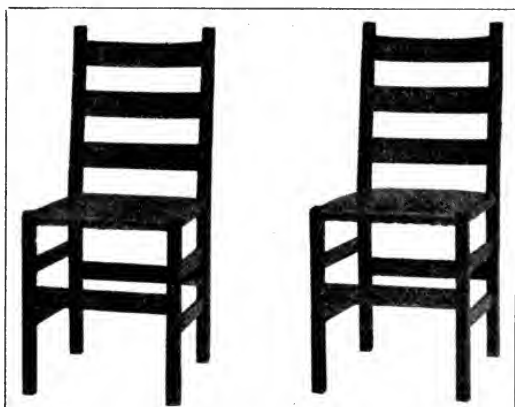

FIG. 28. — Craftsman furniture is simple in line and honest.

Willow furniture is very attractive, and has its place in modern schemes of furnishing. It is comfortable and artistic in appearance, and much of it is durable and inexpensive. It can be used a long time in the natural color and then stained or enameled. In selecting this style the workmanship should be carefully examined for weak places or poor materials. Willow furniture can be used with or without cushions, and is most serviceable. Very often for expensive interiors upholstery of elaborate velvets and other textiles is used for willow furniture (see Figs. 32 and 33).



FIG. 29. — A living room showing the use of Craftsman furniture.



Courtesy of William Leavens & Co.

FIG. 30. — "Cottage" furniture.

Bent-wood furniture, serviceable and simple in construction, is offered in the shops in variety of design in combina-

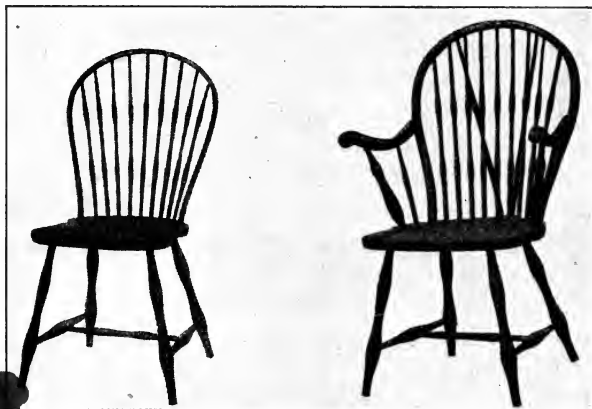

Courtesy of William Leavens & Co.

FIG. 31. — "Cottage" furniture.

tion with cane or without. It finds its place in decoration of simple rooms, especially bedrooms.

The woods used principally in the making of Colonial furniture were mahogany, rosewood, walnut, cherry, and birch. In some furniture we find, instead of the solid mahogany, some soft wood or occasionally mahogany backing veneered with a layer of mahogany. This was not sham, but utility, for by cutting the veneer to run in opposite direction to the underwood, the maker provided against the tendency of the wood to shrink in one direction. The period of wal-



Courtesy of "The Popular Shop."

FIG. 32. — Willow chair for living or bed room.

nut furniture in America was a poor one. The wood was subjected to so many groovings, and the furniture ornamented with so many poor designs stuck on the surface, that little of the old walnut was beautiful or is of use to-day. It was made during a period of debased design in all art.

Draperies and curtains. — The heavy dust-catching draperies, long curtains, and hangings used in many houses in the past seem to be giving way to simpler forms, and in many American homes to-day a more rational system of decoration with curtains and draperies is being followed. The sill-length curtains and overhangings and the lighter draperies are better adapted to the modest home.

The draperies add to or detract from the artistic whole. As a rule the portière should be of the same "value" as the walls. Plain walls can be relieved by figured portières, and figured walls are made more interesting with plain hangings. The principle to bear in mind in choosing should be simplicity, suitability, and harmony with the other furnishings and decorations. Select hangings in keeping also with the purpose of the room. A velvet hanging is not appropriate in a bedroom. If plain textures are desirable, there are many beautiful reps, poplins, casement cloths, soft silks, denims, arras, and other material. Velvets of many kinds make a rich, plain finishing, and many of the beautiful designs of old textiles from the palaces, churches, and museums of Europe are being reproduced. These fabrics with brocade and pile surface are interesting in dignified rooms where the effect desired is to produce the high lights and contrasting deep shadows.

Figured fabrics are many, from the old-fashioned English chintzes, cretonnes, and block-printed linens to the more expensive silk brocades and wool tapestries.

Portières hung straight to escape the floor are the present

style, and are more dignified than many overhanging arrangements. By lining it is possible to use only one set in a doorway and have the lining harmonize with the room it faces. Good taste in hanging implies that they serve their purpose for decoration and use, and this in a harmonious way with thought of good lines, color, and design.

Curtains are used for decorative purpose at windows to soften the lines of the wood casings and to make the room less stiff. They are placed to prevent those outside from looking into a room or to shut out unpleasant sights. Windows are for ventilation and light, and for the purpose of giving an opportunity to those wishing to look beyond the confines of the narrow room; curtains should not interfere with these aims. Rooms would be prisons otherwise. Curtaining should not obstruct the view unless it is an unsightly one, and they should not obscure it except for the purpose of privacy.

Long, clumsy lace curtains are seldom used to-day, but have been replaced by curtains made of many lovely materials from the inexpensive madras, scrim, cheesecloth, lawn, swiss, and linen to the more expensive curtains of brussels net and linen with inserts of filet and cluny lace. Costliness does not always mean that the best has been chosen, but in selection the material should be appropriate, sensible, and harmonious, and many inexpensive honest materials of swiss and cretonne, when used skillfully and in harmony with surroundings, are more beautiful and artistic than imitation velvets, laces, and nets which may have cost more at the beginning. Plain curtains of pongee, scrim, or simple muslin look well in some rooms when decorated with simple stenciled designs.

There are many simple ways of hanging curtains. Curtains suspended from a brass rod in the straight-line effect,

with or without a valance, are very pleasing. They may be caught back simply, to admit light and air. For bathrooms, or other rooms where sash curtains are desirable, they may be fastened to the window frame to prevent them from blowing out, or they may be placed on a rod at the proper height from the sill.



Courtesy of Miss Hettie R. Meade.

FIG. 33. — Willow furniture is well adapted to this simple bedroom.

Pictures, bric-a-brac, and small furnishings. — Again in selection one is confronted by the question of use and reason for being. Pictures and bric-a-brac are not of use except as they exert a silent influence. Pictures, casts, ornaments used to beautify should do this. With so many splendid reproductions from famous artists available, in sepia prints,

etchings, and photographs, there is no excuse for filling one's home with worthless chromes. A few pictures, well chosen, are preferable to many. The Japanese place but one work of art at a time. In American homes we usually have too many pictures. If one is so burdened, it is possible to put some aside and change the subjects from time to time. Pictures of personal interest, as photographs of friends and personal favorites of reproduction, should be placed in the bedroom. In the hallways and general rooms subjects likely to be of interest to others are suggested. There is a wonderful fund from which to make selection: reproductions from Millet, Corot, Whistler, Abbey, Sargent, and hundreds of others having artistic value, as well as photographs of exquisite bits of scenery and dignified old ruins. Family portraits, when really artistic, have a place in the living room.

The framing of pictures is important; mats should be carefully chosen; white ones are, as a rule, too conspicuous in places where the furnishing is in brown or green or dark values. Soft browns and grays are preferable. The frame of a picture should be neat, simple, durable, and inconspicuous. A frame should not be noticeable, but it should bring out the attractiveness of the picture. Gilt frames are reserved generally for oil paintings. The hanging of pictures requires thought. Avoid having too many pictures on the walls; they collect dust, and the effect is not artistic. The cord or wire should be as simple and inconspicuous as possible. Vertical wires with two hooks are preferable to slanting lines where but one hook is used. The size and shape of the picture should be considered in relation to the wall space, and an orderly, dignified arrangement made. Many pictures are hung too high. A diagonal effect in placing pictures is usually displeasing.

In choosing bric-a-brac for decoration or use, keep in mind the principles of simplicity and harmony. Rhythmic lines that flow one into another are the most beautiful. Some ornaments may serve a use other than beauty, as *jardinères* of brass or pottery, brass candlesticks, trays, and bowls for flowers. A few pieces well chosen are of value, but a cluttered shelf or "whatnot" full of bric-a-brac is a disturbing element in the repose of any room. Many of these things are valuable, but not from the standpoint of the home maker who has the principles of simplicity and harmony in mind. A few flowers, well arranged, or some growing plants add much to the attractiveness of a home, and are far more beautiful and graceful than cheap vases, statuary, and other useless, dust-collecting atrocities.

The furnishing of the bedroom. — A bedroom is primarily a place for rest. Sometimes it serves also the purpose of sitting room or study for individual members of the family. If it serves this double purpose, furnishings may be introduced that one would not put into a room used only for sleeping and dressing. There should be a comfortable place for reading, for writing, and for sleeping; these are the essentials of the combination room. The room should have only the most simple furnishings and those which can easily be kept clean. The ideal bedroom should have good ventilation and should be situated on the sunny side of the house. The floor should be of wood with rugs; light-color values are preferable for the walls and woodwork in bedrooms, and the curtains and bed valances, if used, should be such as can easily and frequently be laundered. Metal beds are the most sanitary. The mattress and springs can be kept in good condition with fitted muslin covers. The bed should be comfortable. Good springs and mattresses are an economy. One third of life is spent in bed, and

efficiency depends much on the way one rests; therefore thought should be given to the selection of bed furnishings. Good light blankets, sheets of right width, and good pillows all add to comfort. A few well-placed pictures are restful, but too many are distracting and have no place in



Courtesy of John Wanamaker Co.

FIG. 34. — A girl's bedroom.

a room intended for rest unless they are of personal interest to the occupant. Few ornaments are necessary. They add to the labor of cleaning the room. Beware of the room cluttered with all kinds of hangings, ornaments, and knick-knacks which collect dust and possibly disease germs.

Wicker furniture with muslin and chintz curtains is well adapted to the furnishing of some bedrooms (see Figs.

33 and 34). Old mahogany pieces or reproductions of them are always interesting. Brass beds when of very simple design are good, and white metal beds always cleanly and attractive. Bedroom furniture in "sets" is not always the most pleasing furnishing for the bedroom. Chairs of varying styles add interest to a room, and relieve the monotony of set pieces. The bedroom should provide a place for the storage of clothing. There should be a comfortable chair well placed with regard to light for reading by day or night, and a study desk or table for writing purposes. "Cottage furniture" for bedroom purposes, where expense must be considered, is attractive, relieved with a comfortable wicker chair or two.

The bathroom. — The furnishings for this room should be as simple as possible. The walls are most sanitary if painted, and the addition of tiling as a surbase adds to the ease with which they can be kept clean. The aim should be the maximum of comfort and cleanliness with the least care. The floors can be tiled, painted, or of hard wood, and the woodwork painted or varnished. There should be a comfortable rug and a bathmat. Bath tubs resting on their own base rather than on feet are more cleanly, as dust cannot collect beneath, and rounded corners and edges of the room are more sanitary. There should be plenty of rods and hooks for towels according to the number using the room. It is preferable to have a sunny bathroom. It should be well ventilated and the plumbing absolutely without question. Mirrors and a closet or cabinet are almost indispensable, and a small stool adds greatly to comfort. A basket or bag for soiled clothing is a necessity (see Fig. 16).

The dining room. — This room should offer cheer and comfort, for in it much of the social life of the home takes

place. The wall covering should be carefully chosen in relation to light and should not be too dull. Wainscoting is effective in some dining rooms. In others the paper is so arranged that the lower part of the wall is in plain color and a wide border ($\frac{1}{4}$ height of wall) is applied above. An



Courtesy of Miss Hettie R. Meade.

FIG. 35. — Notice the good lines of the chair and sideboard in this simple dining room.

open fireplace that can be used adds to the cheer. The furniture — table, chairs, and side table — should be carefully selected. Large pieces should not be chosen for a small dining room, and simple outlines are much more agreeable than heavy carving and claw-and-ball feet, which collect

dust and are cumbersome (see Fig. 35). A few well-placed pictures of general interest are decorative, and plants add much to the cozy effect. The floor is most hygienic if of wood with a rug that can be removed and cleaned frequently. One large rug is preferable in a dining room to several small ones, and one of not too deep pile is more cleanly. Body Brussels and Wilton are serviceable if one cannot afford an Oriental rug. A display of dishes, ornaments, and bric-a-brac is not good taste in a dining room. Plate rails collect dust. A few articles of table service, candelabra, or a dish or two may be attractively placed on the side table or sideboard. Dishes and most silver should be kept in closets rather than displayed in china closets with glass fronts. Few dishes are really good art. The sideboard with a long drawer for linen and shallow drawers for silver is serviceable. The curtains in a dining room should be placed to admit good light. Scrim, net, and simple muslins are best for the modest home. When there is an interesting view of garden or landscape from the dining room, a large window carefully curtained to disclose the view adds much to the charm and beauty of the room (see Fig. 36).

The living room. — The same general principles of simplicity, beauty, and comfort should be applied in the furnishing of the living room. In few modest homes of to-day can a room be spared for occasional use as parlor. A living room, which answers for sitting room and library, may be so planned that one's friends can be entertained there rather than in a stiff parlor (see Fig. 37). In most homes where entertaining is of an informal nature the "parlor" of former days is no longer known.

The living room should offer cheer and comfort, and good common sense should be used in the selection of furnishings,

useful as well as beautiful (see Fig. 38). It is here that the family assembles and friends are entertained, therefore comfort and harmonious furnishings should greet the occupants. Soft-colored wall coverings of one or two values or a simple pattern, with woodwork to harmonize, are preferable. A



Courtesy of Story and Triggs, London.

FIG. 36. — The "Byron" dining room. Georgian furniture.

wood floor with small rugs or one large rug, a fireplace with comfortable chairs or davenport near, a couch and pillows well placed, a good table for lamp and books, a desk with a good light — are the essentials. Bookcases can be arranged in this room if there is no separate library (see Fig. 37). The furniture should be simple and dignified in outline. The old-fashioned "sets" of upholstered tufted furniture

are no longer considered desirable. A few wicker chairs in the living room add greatly to the degree of comfort ; they are easy to move about, and can be ordered in colors to harmonize with the furnishings. Avoid cluttering ; have only the essentials of comfort, convenience, and beauty. Curtains should be simple and arranged to admit light and air. Plants, a few dignified vases, a bowl of brass, some well-chosen



Courtesy of Sherwin Williams Co.

FIG. 37. — A living room which suggests comfort in the arrangement of its furnishings.

prints of good subjects will be found sufficient decoration. Arrange the furniture in relation to light with the idea of comfort for reading, writing, and the other home activities in this much-used room.

The reception room. — In many houses a small reception room is almost a necessity. It is a room for occasional use, and when space permits, can be utilized to great advantage. It is there that people can be received who are not admitted to the intimacies of living room or library. It may con-

veniently serve also as a music room if the young people of the house must practice.

The treatment of this room should be formal. As a whole it should be in lighter color value than the living room. It is the place where choice pictures should be hung,—some oil paintings, when not too heavy, and selected etchings.



Courtesy of Miss Hettie R. Meade.

FIG. 38. — This shows the use of the willow swing suitable for a country living room. Notice its position before the fire, suggesting comfort and cheer.

Avoid gilt furniture, statuary, and other frivolous furnishings without use or beauty. A well-finished floor with a few good rugs, dignified chairs and sofa, a palm or other plant well placed, and the piano and stool, make it a place for formal use.

The hall of every home should represent to the visitor something of the ideals and standards of taste of the family. There should greet the visitor orderliness, cheer, and dignity, — an introduction to the life within. Very little furnishing is necessary. The essentials are few, a chair where space per-



Courtesy of Pratt Institute.

FIG. 39. — A glimpse of a simple dining room from the living room.

mits, an umbrella stand, a place for hanging a few wraps or hats, and a mirror. If space permits, a table is often useful. The family wardrobe of coats, rubbers, and gloves should not be deposited in the hall space; a closet at the rear is quite necessary, or a few hooks screened.

The wall and floor covering should be chosen with care. It should express cheer and dignity. Unless the hall is very

large, small patterns of wall paper look best, and stripes are usually a success unless the stairway is very long and the lines accentuate the height. The floor covering should be unobtrusive, and of a color that will not show soil or foot-prints. Many ugly pieces of hall furniture destroy all feeling of harmony and beauty. A simply framed mirror and a good chair are decidedly to be preferred. Curtains of muslin, scrim, or silk are serviceable. A golden-colored china silk with brown hall furnishings adds light and cheer.

The kitchen. — The greatest care should be exercised in furnishing the kitchen. It is of primary importance that everything in it be easily kept clean. There are numerous floor coverings, but good linoleum is perhaps most satisfactory for the average home. It can be kept clean easily and lasts a long time. The selection of wall covering, paint, and woodwork should be as carefully made as for the living room, and with the same idea of harmony in color and line.

The kitchen furnishings should be so arranged that energy and time are saved. A small room where articles are at hand is most convenient. A light arranged near the stove and good light near the sink are essential. Furnishings to promote the comfort of the worker, a high stool, a sink of sufficient height to prevent backache, convenient utensils near at hand, and provision for the protection of all articles from dust should be carefully considered in furnishing this very important room. The kitchen should be carefully screened — both at windows and doors. A plant or two on the window sill furnishes cheer. A good clock and a book shelf for cookbooks are necessary.

EXERCISES

1. What will influence your selection of floor covering for a bedroom, living room, dining room?

2. Name four English furniture designers whose influence has affected modern furniture making. Give characteristics of each type. Try to find pictures of old or modern chairs of each type.

3. Bring samples of net, swisses, or other simple curtain materials. Pin on bulletin board in classroom for comparison of price and width. What reasons should influence your use of curtains?

4. If possible, as a class plan an excursion with your teacher to see old furniture and textiles in the museum, or modern furniture at some good shop.

5. What place has willow furniture and chintz in the furnishing of modern American homes?

6. What are your ideas for the use of pictures, plants, and bric-a-brac in a home?

7. Plan how you would spend (a) \$700, (b) \$1000 in furnishing and decorating a six-room apartment or small house. Give items of expense for each room; also samples of wall covering and curtains. If possible show pictures of furniture for each room. This might be a class problem and each girl plan a room after approximate division of money has been made.

8. Plan decoration and furnishing of a girl's bedroom just as you would like it, keeping in mind the principles that you have learned. It might be a combination of bedroom and study. In your art class sketch the bedroom and show possible coloring and arrangement of furniture.

9. Describe an ideal living room in a modest home.

10. Describe an ideal kitchen.

PART II

TEXTILES: MATERIALS AND HOW THEY ARE MADE

CHAPTER VIII

COTTON

Reasons for the study of textiles. — Woman is the chief purchaser, and upon her rests the responsibility in household affairs of making each dollar procure full value. Many women spend foolishly, and this is due principally to ignorance. Women should have a knowledge of textiles so that the materials used in the household for clothing and furnishings may be purchased intelligently. This knowledge means a study of the processes of modern manufacture of materials, their properties, and the laws governing the adulterations and fraudulent labeling of materials. In the present day of high prices, it is essential that girls, who sooner or later assume the responsibilities of the home, should make a study of these important things.

Cotton is the most common and the cheapest of the important textile fibers used in the manufacture of materials. It is a vegetable fiber, and a cotton field of unfolding bolls with the soft white cotton fibers within is a lovely sight (see Fig. 40). Cotton is the white, downy covering of the seeds that are borne in the capsule after the beautiful flower has disappeared (see Fig. 41). Nature provided the

seed with its soft covering so that, in the wild state, the wind would catch the fiber and carry the seeds far and wide.

Where grown. — Cotton is a native of many countries. Columbus found it growing in the West Indies and Cortez in Peru. Theophrastus wrote about cotton in India three centuries before Christ. Biblical references mention cotton as early as 519 B.C. Herodotus, "the father of History," in his book of travels speaks of the cotton plant. There are, however, many myths and fables as to its nature and origin. It was supposed by some to be a tree in which the buds yielded tiny, woolly lambs which stooped and grazed about the plant. The principal countries producing it to-day are the United States, India, Egypt, and Brazil. In our own country, about 30,000,000 acres are devoted to cultivation of cotton, and about 15,000,000 bales are produced annually. Texas leads the states in the production of cotton. The fiber depends on the nature of the soil. The best grows in sandy, loamy soil which will retain the proper amount of moisture as well as heat. It grows best between 35° north latitude and 45° south.

Varieties of cotton. — The value of the cotton fiber depends upon its quality. Strength, length, and evenness are affected by the soil and climatic conditions (see Fig. 42). Over one hundred varieties are known by the agriculturist. A microscopical examination of the cotton fiber shows that a fully developed ripe fiber has the appearance of a piece of twisted rubber tubing (see Fig. 87). The twist is of great economic importance and aids in spinning as well as producing a more elastic fabric. Its length varies from one half to two and one half inches, usually one to one and one half inches. Unripe fibers do not swell or twist as much and consequently do not accept the dye as readily. They can



Courtesy of Acmeograph Co., Chicago.

FIG. 40. — Cotton field.

be easily distinguished if used in colored cotton fabrics. The most important species of cotton are the *Gossypium herbaceum*, *G. arboreum*, *G. hirsutum*, *G. barbadense*, and *G. peruvianum*. Within these five species over one hundred varieties are recognized.

Gossypium herbaceum bears a short fiber or staple, and the seeds are covered with a short gray down. The plant grows

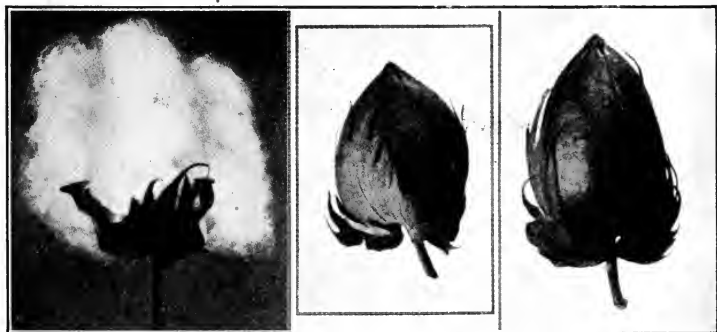

Courtesy of U. S. Dept. of Agriculture.

FIG. 41. — Cotton bolls.

about five feet in height and bears a yellow flower. Many varieties of Egyptian and Indian cotton are in this class. The cottons called "Nankeen cottons" are made from the fiber of this variety. This grows in China and India and is yellow in color.

Gossypium barbadense is a long staple cotton. The plant grows to be eight or ten feet in height and bears also a yellow blossom (see Fig. 43). The seeds are black and smooth, and unlike other varieties. Sea Island cotton is of this species and grows chiefly off the coast of Florida and Georgia. This species grows best by the sea and yields the finest

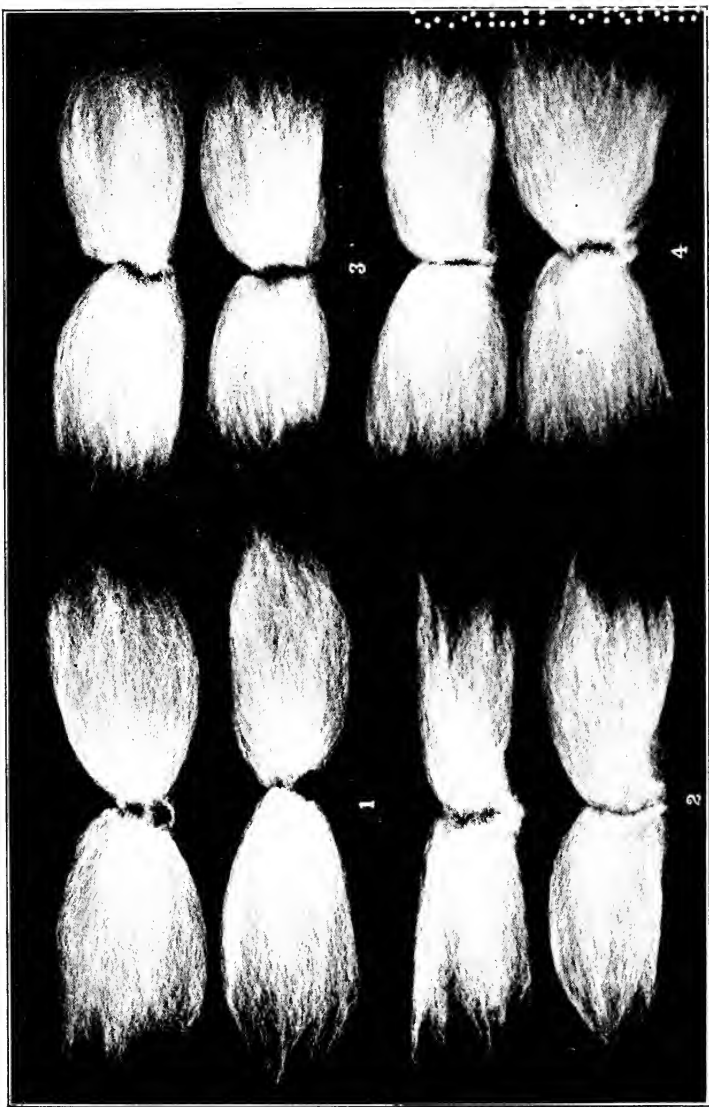

Courtesy of U. S. Dept. of Agriculture.

FIG. 42. — Showing length of cotton staple.

grade of cotton, since its staple is silky and from one to two inches in length.

Gossypium hirsutum is so called because its leaves, stems, branches, and seeds are of a hairy nature. The plant grows to be six feet in height. The fiber is short and the seeds covered with soft green down.

Gossypium arboreum grows higher than other cotton, about twenty feet at maximum. It is also called *religiosum* because the variety was used in spinning priests' robes in India. The fiber is short and the seeds covered with green fuzz. The flowers of the plant are brown and purple-red.

Gossypium peruvianum is considered a native of Peru and Brazil, and has all the characteristics of the *barbadense*. It is harsh and rather wiry in fiber and is used for wool adulteration because of this characteristic.

Cotton culture in the United States. — The United States produces three fourths of all cotton used. It was not until 1621 that it was grown for fiber in this country. It has become since then one of the most important crops in the world. This is largely due to the wonderful inventions in cotton machinery during the last three hundred years. Cotton planters prepare their fields in January or February and plant in April or May, and the picking begins about the middle of August and lasts until December. This period is a most anxious one for the farmer. He prefers light showery weather for the best development of his crop. Frosts are most destructive. There are many enemies which the farmer has to fight: the boll weevil, the cotton caterpillar, the bollworm, lice, and fungous growths. A large quantity of cotton is destroyed annually in this way. The United States government has rendered much assistance in studying these pests, but much is still to be done. One acre will produce a crop of from three to six hundred pounds of cotton.

Estimates of the cost per pound of growing cotton vary from five to nine cents. In the old days cotton was grown principally by the planters, who had large areas under cultivation with armies of slaves. It is now also grown by the small farmers who own their farms or rent them and also work on shares. Labor is so uncertain that owners of land cannot work individually, but must share with a tenant who helps in the work. The cotton is gathered by young and old, and this is a tedious task. It is picked with the sun upon it, and when exposed to this heat becomes dry and hard. It is put in marketable shape in the form of a bale, and is then taken to the gin house, where it is cleansed and the seed removed. Each cotton boll contains thirty to forty seeds and each tiny fiber is attached at one end to a seed. The process of separating seed from fiber is called ginning.

Cotton ginning. — Most of the cotton of to-day is ginned by machinery. In India and China the foot gins and other primitive types are still used. The primitive hand types are somewhat like a household clothes-wringing machine. The rollers separate, but do not clean very well — and the process is a slow one. A woman using the “churka gin” could separate three pounds per day at a wage of five cents. In the modern steam ginnery in one hour, on one gin, it is possible to gin enough cotton to make a bale of five hundred pounds. Eli Whitney invented the saw cotton gin, for which a patent was issued by George Washington in 1784. Water power was soon used in running these saw gin mills. The manufacture of cotton cloth could never have become a great industry but for this American invention. It was needed because of the wonderful improvements in spinning and weaving machinery, and this gin made possible a large supply of the raw material. The saw gin is made of a series of circular saws. The cotton is delivered

to the gin box, one side of which is grated. The saws revolve through this grid, which is fine enough to permit the fiber to be drawn through but not the seed. The seeds are heavy and fall, and are used later for various by-products. The fiber thus pulled from the seeds by the saws is brushed off by a revolving brush and delivered from the machine.

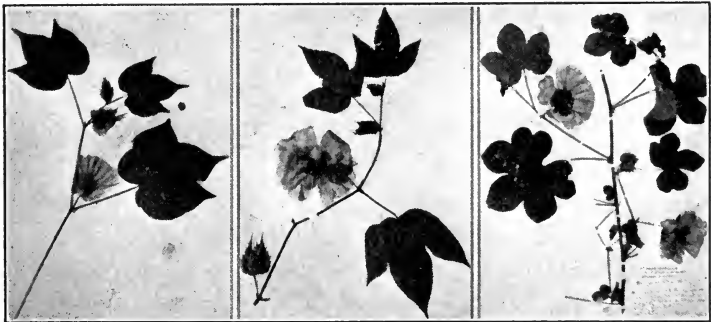

Courtesy of U. S. Dept. of Agriculture.

FIG. 43. — Cotton leaf and flowers.

Much American cotton is full of knots or “neps,” caused by the saw gin operating too quickly. This gin can clean under average conditions about three hundred pounds per hour. Cotton is also ginned by means of the roller gin, which is perhaps less destructive. This was the primitive method. The best long staple cotton, the Sea Island, is ginned on the modern roller gin. The saw gin is better adapted to the upland or short staple cotton. One early form of roller gin invented by Mr. Bissell of Georgia was used as early as 1788. Mr. McCarthy of Alabama invented a roller gin in 1840, and with steam power this gin will produce about one thousand pounds or two bales per day. The gin houses and baling presses were formerly on the planta-

tions, but now the processes of ginning and baling are completed at central points.

Cotton baling. — The cotton is delivered from the gin to the baling press. Boxes the shape of the American cotton bale are prepared with jute bagging and the cotton delivered into them. There are usually two boxes, one of which is filled while the other is pressed by means of a screw. This bale usually weighs about five hundred pounds, and fifteen hundred pounds of seed cotton are used in producing it. After being bound with sheet-iron bands it is ready for the local market or mill. The size of the American bale is about $54'' \times 27'' \times 16''$.

For shipping at steamboat piers as ocean freight, it is necessary to reduce the size, as rates are fixed according to space occupied. The machines used to reduce the size of the bales are called compressors, and are so powerful that the bale can be compressed to seven inches in thickness. This means great economy in transportation. Bales are shipped also by rail and from local mills by river boats to ports. The American system of round bales has been much discussed as to relative merit. The cotton from the gin is rolled in a lap as one would roll a bandage or a roll of tape on a spool. The air is pressed out and this bale is said to be waterproof and airproof. It is very easily handled and unrolled at the mill, and is in better condition because of proper wrapping of cotton cloth which protects and keeps it clean. It is called the Bessonette cylindrical bale.

The Egyptian cotton bale is a trifle longer than the American and weighs seven hundred pounds. The Indian bales are about four hundred pounds in weight. Cotton is shipped from the United States to Liverpool, Bremen, Havre, and Genoa, and to other ports in Spain, Japan, and India. We import cotton from Egypt principally, but also from

Peru and from India. The long fiber, imported Egyptian cotton is used for fine cotton goods requiring long staple, as sewing thread, underwear, cotton hosiery. The business of shipping cotton is transacted by great exporting companies. Each bale is so marked that it can be traced through each step of its journeying.

Cotton by-products. — Formerly the farmers wasted most of the cotton by-products, seed and stalks only being utilized. To-day the seed is first delinted and this lint product made into wadding. The hulls of the seeds are then removed and are used for fertilizer. The green kernels of the seeds are pressed and the oils used for various purposes, such as salad oil, cooking fats, soaps, candles, according to the refinement. The remains of the pressed kernel are ground to make the cottonseed meal used as food for cattle. It has been estimated that one ton of seed will produce 30 pounds of lint, 950 pounds of hull, 40 gallons of oil, and 675 pounds of meal.

Cotton yarn manufacture. — The bales, whether round or square, eventually reach the mill. There many processes are necessary before the yarn is finally spun and ready to be used in the weaving of cotton fabrics, the making of cotton thread, or for the knitting machines which consume much cotton yarn in the manufacture of underwear and hosiery. The cotton on arrival at the mill is first weighed. Sometimes after the bales are opened several qualities are mixed according to the quality of yarn to be made. The bale breaker machine is used for this purpose. The cotton must then be cleansed, and this is done in the picker machines by means of air currents which beat the cotton against cylinders until the dirt, seeds, and stones are removed. The final picker machine delivers the cotton cleansed in a lap like the cylindrical bale. The cotton is next treated at carding machines.

These cleanse still more, and by means of flat cards covered with small wire teeth the fibers of the cotton are laid parallel (see Fig. 44). The cotton roll or lap is delivered at the back of the machine and leaves it at the front, cleansed and carded — a gossamer web which is the width of the machine, but is reduced to a coarse rope of cotton called a sliver as it passes into the cylindrical cans prepared to receive it. During this process short, broken, and unripe fibers are removed.

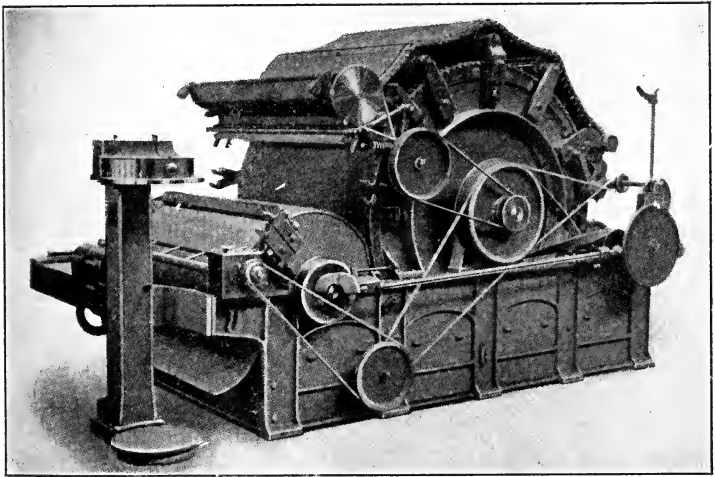
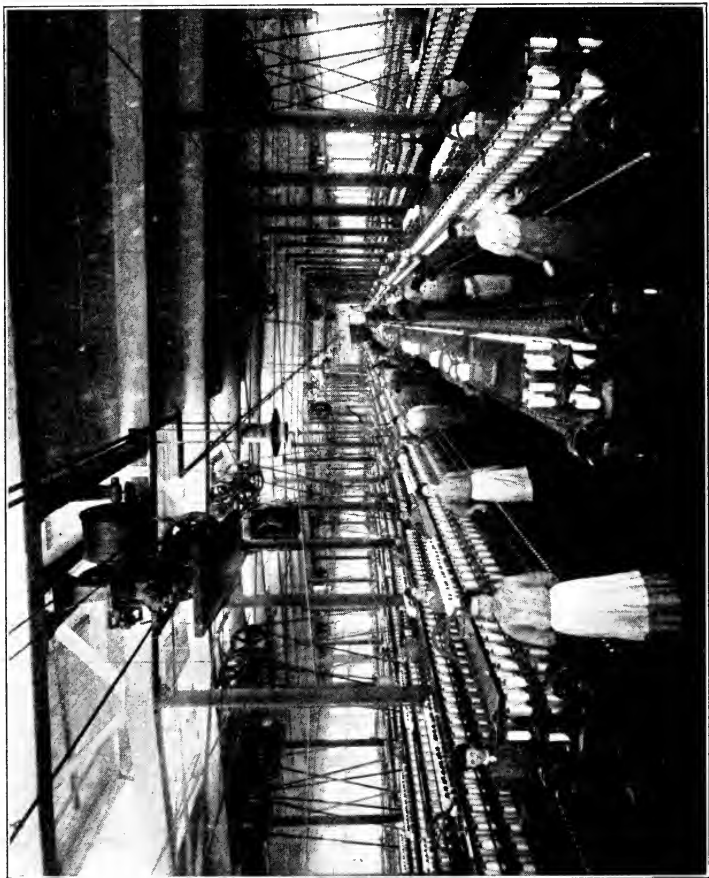

FIG. 44. — Revolving flat card for cotton. Delivery side.

The cans of cotton slivers are placed next before the drawing and doubling machines except when the cotton is to be combed as well as carded. This process of combing is used when very fine and strong yarn is required. A great deal of waste is made by the use of this machine, for only the best fibers for good yarn are wanted. The comb is made up of fine teeth on rollers, which remove the short

fibers and straighten out the long ones. The cotton from the carding machine is in the form of slivers and must be prepared for the combing machine. This is done in a sliver lap machine which prepares the slivers into laps ten inches wide which are ready for the comb. The cotton is delivered from the comb in the form of slivers which are delivered in cans ready for the drawing and doubling frames or machines. The purpose of these machines is to pass a number of slivers together between rollers and draw them out so as to equalize the strength of all. Several slivers may enter the back of the machine together and be delivered in front as one attenuated stronger sliver. We now have a cleansed cotton with fibers lying as nearly parallel as possible and drawn out in the shape of a sliver or ropelike form of cotton. In order that this soft sliver or rope may not break, it is necessary to put in some twist as the sliver is drawn out gradually until it is a fine yarn.

The cotton is passed through bobbin and fly frames to accomplish this twisting. There are several of these frames, the slubber, the intermediate roving frame, the roving frame, and the jack roving. All cotton does not pass through the full set of frames, but through those only that will accomplish the aim of the manufacturer. The cotton is delivered at the back of the machines on spools or bobbins. The first frame in this set has large spools with a thick roving and the last before spinning a much smaller spool with a finer roving. This reduction in size is accomplished by the bobbin and fly frames, which draw out the rovings as they pass between rollers and put in a twist which makes the attenuating possible. The twisted roving on bobbins or spools is a very different looking cotton from the soft cotton roving delivered from the drawing frames. This twisted roving, closely resembling thick yarn, is ready now



Courtesy of Olympia Mills, South Carolina.

FIG. 45. — Cotton spinning room. Ring spinning.

for the spinning, which draws it out, twists it, and winds it on spools. This drawing out of the roving into yarn makes it possible to obtain yarn of any degree of fineness. The spinning frames add the necessary twist to give the strength required (see Fig. 45). Modern spinning by power machinery is quite different from the spinning machinery of our ancestors, but the essential principle is the same in both — to obtain a fine twisted yarn which has been drawn out from the raw material.

The history of spinning is most interesting. We know that the earliest and most primitive peoples imitated nature and wove baskets, blankets, and clothing from the natural materials and the fibers which they spun into yarn for weaving. Spinning in the early days was done by hand. Some familiar old pictures show the spinner with a distaff holding the raw material, under one arm, and the spindle with the drawn out and twisted spun yarn wound upon it, dangling from the other hand. We know that Egyptian tombs have revealed the fact that spinning was an early art and that very fine yarn was spun by hand. “Who can find a virtuous woman? for her price is far above rubies. She seeketh wool and flax and worketh willingly with her hands. She layeth her hands to the spindle and her hands hold the distaff.” In various countries hand spinning was succeeded by simple wheel spinning. Some of us remember the large wheel of our grandmothers’ day for spinning wool and the small flax wheel for linen yarn (see Figs. 46 and 70). These wheels were used in Europe as early as the sixteenth century. The large wheel was worked by hand power, the small by foot power. The motion of the former was intermittent, for the spinner walked in one direction to draw out and twist the yarn and in another to wind it on the bobbin, while the flax wheel spinner sat and with foot power drew

out the fiber from the spindle which twisted and also wound it on the bobbin. Modern "ring" spinning is like the flax wheel, continuous motion, while the "mule" spinning frame is intermittent, as the rovings are drawn out and twisted by one motion and the machine reversed as the yarn is wound on the bobbins. Our grandmothers had to card the wool with hand cards and make the wool rovings which were spun on the great wheel.

Between the wheels of the sixteenth century and modern spinning there are many steps in the evolution of spinning machinery, and to-day we owe much to the inventors of those centuries. "Necessity is the mother of invention." In 1738 the fly shuttle was invented, and weaving was done very rapidly, but the yarn for weaving was not available. A machine was needed to rotate several spindles at once instead of the one spindle of the flax or great wheel. Several inventions followed. James Hargreaves of England invented the spinning jenny in 1764. Sir Richard Arkwright patented in 1769 a machine for spinning with rollers, which he installed in his mill at Nottingham, England. The jenny was an intermittent form of spinning, while Arkwright's invention was a system of rollers like our modern ring spinner. The greatest invention in cotton spinning machinery was the mule jenny of Samuel Crompton in 1779. This made possible the spinning of very fine yarn and the use of many spindles at once. This machine was a combination of Arkwright's and Hargreave's, and as it was a cross between the two was called a mule. After Crompton, Richard Roberts of England contributed an important invention, by making the mule spinning machine self-acting by use of a device in the mechanism (see Fig. 71).

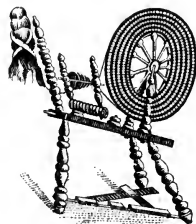

Courtesy of J. McCutcheon.

FIG. 46. — Flax wheel.

Modern spinning machinery is therefore able to accomplish the drawing out, twisting, and winding of yarn, and is able to spin many threads at once quickly and evenly. The mule spinning frame of to-day produces a softer yarn than the ring frame. It is therefore better adapted to the spinning of wool yarn and for yarn used in knitting machines for hosiery. It is a more complicated machine than the ring and occupies more floor space. The bobbins containing the rovings to be spun are placed at the back of the machine, and the spindles on which the threads are to be wound are in a traveling carriage which contains rows of them. As the machine recedes about five feet the threads, stretched between roving bobbins and the spindles in the carriage, are drawn out and twisted. As the traveling carriage returns to a position near the row of bobbins the twisted yarn is wound on the spindles.

The ring frame is especially adapted to spinning warp and coarse yarns. This machine occupies little space and spins continuously by means of rollers. The yarn is spun and delivered on bobbins — ready for the next process. It has been estimated that to-day there are over 150,000,000 of cotton spindles in operation in the world, and about twenty-five per cent are in the United States. Cotton yarns are spun in many sizes. These yarns are used principally for warp and woof in weaving, for material made on knitting machines, and for thread.

Cotton thread manufacture. — Cotton thread is made by twisting two or more cotton yarns together to form a hard twisted strand. The finest zephyr yarns from the spinning mule are used for thread making. The very best cotton, usually Egyptian or Sea Island, is used in spinning this yarn, for the long fiber produces a stronger thread. The first step in the process, after the spun yarn is prepared, is to

twist two yarns together. Three of these doubled yarns are again twisted to make the six-cord spool thread which is commonly used. The size of the thread can be controlled by the machines in the twisting process. The twisted thread at this stage is wound on bobbins which are taken to a reeling room, where machines wind the thread into hanks ready for dyeing or bleaching. The reeled hanks of unbleached thread are first carefully examined for knots and defects and then sent to the bleaching room, where they are cleansed and then immersed in a solution of calcium hypochlorite, "chloride of lime," for several hours until white. The next bath is one of water with some sulphuric acid added to neutralize the lime. The thread is again washed and boiled and the process of bleaching repeated. It is thoroughly washed and rinsed and dried in the hydro-extractor. The bleached thread is wound again on bobbins, is sometimes sized or gassed, and then wound on spools for commercial use. The thread to be colored is dyed in the skein, then wound and spooled. The finishing, winding, fastening, labeling of spools, is all done by machinery and is an interesting sight. A century or two ago Dutch flax, spun and made into thread abroad, was sent to this country for sewing of garments. Think of the progress that is represented by the six-cord spool of to-day.

Cotton cloth manufacture. — Cloth is made by interlacing the warp or lengthwise threads of the loom with a crosswise or woof thread which binds the edges, forming two selvages. Weaves may vary according to the way in which the warp and woof threads interlace, and even on the hand loom this variation can be controlled. Cloth is made to-day principally by power machinery on the power loom. The first power loom was invented by the Rev. Dr. Cartwright of England in 1774. Weaving is one of the most ancient of

arts and originated with the primitive needs of shelter and clothing. Biblical and classical history give many proofs of the early use of the art. Rushes and other short materials were probably used first and suggested the spinning of con-



Courtesy of U. S. National Museum.

FIG. 47. — Primitive weaving.

tinuous wool threads so that selvages might be formed, which was impossible with short rushes and other natural fibers. The early hand looms of many countries are most interesting and may be studied in any museum. The Indian looms are especially worthy of study to all Americans (see Fig. 47).

Early looms of all countries have the same characteristics. Some device for holding the warp or lengthwise threads in

place — called the frame of the loom ; some means of throwing the woof thread after separating or raising certain warp threads to make plain or pattern weave ; and some method of battening, or pushing firmly together the threads thrown across. The motion of dividing the warp threads for plain or pattern weaving is called *shedding*, that of throwing the

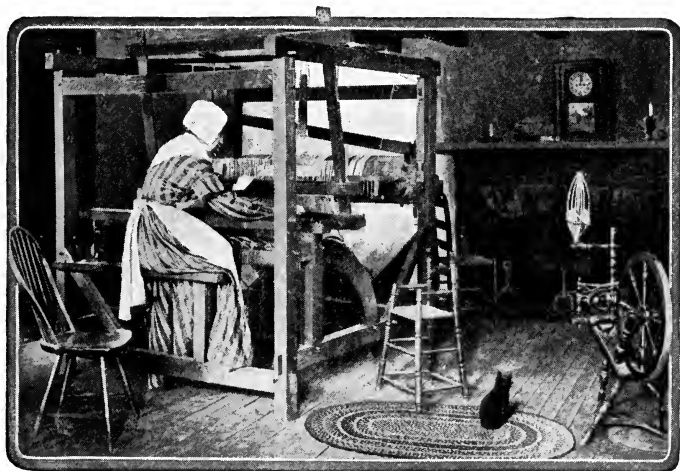

Courtesy of Draper Co.

FIG. 48. — "In days gone by."

woof across is *picking*, and the third step, of pushing the woof threads together, is the *battening* of the cloth. The primitive looms all accomplish these steps in a simple way by hand, and the power looms do so to-day much more rapidly by means of intricate machinery. A study of the Colonial type of loom will give a good idea of primitive methods and help one to understand some of the intricacies of the modern loom (see Fig. 48). We find a simple framework of wood, holding two rollers, one at the back on which the warp is

rolled and the one at the front for holding the roll of finished cloth near the weaver's seat. The warp threads, varying in number according to the width and fineness of the cloth, pass in parallel order from the warp beam at the back towards the weaver's seat, passing through a device called the *heddles*, then through the reed which is in the batten, and finally they are wound on the cloth roller. The weaver sits in front of the loom and weaves with a shuttle containing a bobbin on which the woof yarn is wound. This yarn unwinds as the weaver carries the shuttle back and forth. The weaving is done on the side of the batten towards the weaver. The weaver uses her feet also, and the treadles which she works are attached to the heddles above. If there are two heddles, as in plain weaving, the odd threads of the warp, 1, 3, 5, 7, etc., pass through the eyes of one heddle and the even threads, 2, 4, 6, 8, etc., through the second heddle (see Fig. 49). If one treadle is attached to the heddle with odd threads, a step on it will lower all alternate threads so that a division, or shed, is made through which the weaver can throw the thread. The other treadle attached to the even threads would in turn perform its duty. By means of this device for harnessing the threads in heddles and attaching heddles to treadles it is possible to make many variations of pattern. This device of harnessing accomplishes the motion of shedding, or dividing the warp threads, for the picking or passing of the woof.

To-day, shedding, picking, and battening can all be done by machinery on the power loom. Since the first power loom of Dr. Cartwright, there have been many improvements; and the complicated Jacquard looms of to-day make possible many variations of pattern and the accomplishment of many yards of cloth in an hour. Primitive looms contained but short lengths of warp as for a rug or blanket, but in the evo-

lution of the art the rollers were used as in the Colonial type to hold longer lengths of warp and so produce more yards of cloth. The power loom of to-day with its large warp beam can hold rolls of several hundred yards of warp (see Figs. 50, 51). Yarn which comes from the spinner's mule or ring frame is used for both warp and woof. If for the woof, it

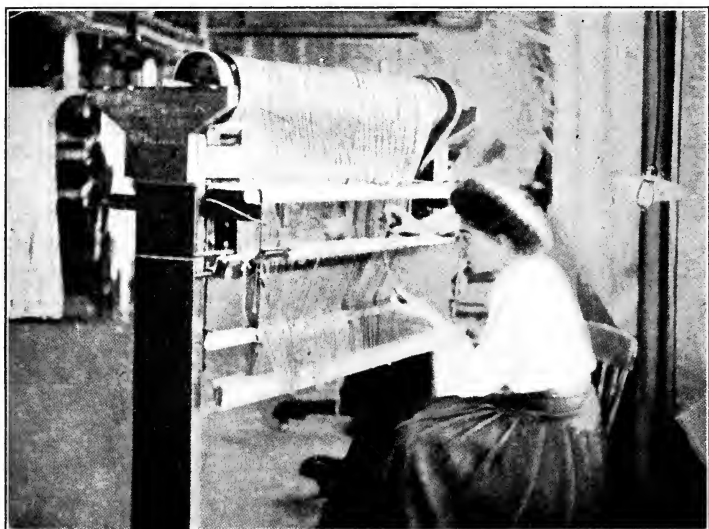

Courtesy of Cheney Brothers.

FIG. 49. — Drawing in of threads in preparation for weaving.

must be wound on the spools which fit in the shuttles. There are simple machines for accomplishing this. If for warp in the loom, the bobbins of yarn must be prepared for the warp beam. This process is called *warping* and was done by our grandmothers on warping bars in a simple way and by the modern machinery more easily and quickly (see Fig. 57). The yarn for warp is spooled on a machine

called a spooler, and then many spools are placed on a rack called a skarn or creel. The ends of yarn from the spools are gathered together according to the width of cloth required — if five hundred wide, then from five hundred spools — and are passed through a device which arranges the threads in proper order and from which they are wound on a cylinder called a beam. This beam fits in the back of the loom. Sometimes the warp threads pass through a bath of sizing of starch mixture. This is for the purpose of increasing the strength of the warp and making it smoother. Sometimes the object is to increase the weight of the cloth. The warp is then passed from the beam at the back of loom through the heddles. This process of harnessing is still done by hand (see Fig. 49). The movements of the modern power loom are fascinating as the fly shuttle moves back and forth in the picking and the batten automatically pushes forward the thrown woof. The division of the threads for the shedding is most interesting.

In the Jacquard harness for shedding is found a device which makes possible many variations of pattern. One finds placed high above the loom a series of cards. Each card represents one throw of the woof. The number in the series of cards making the pattern varies according to design. The pattern is repeated in the cloth by the cards revolving over again. Each warp thread running parallel below on the loom has attached to it a thread at right angles (see Fig. 58). These upward threads are attached to a set of iron rods above the loom in a box near the card series. The cards are perforated with holes and revolve against the ends of the iron rods. A hole in a card permits an iron rod to pass through it. A blank hits the end of the rod, knocks it out of place, and consequently lowers the warp thread attached at right angles below. The perforations

in each card are different and are worked out by the designers, who study the necessary shedding, or raising and lowering of warp, in order to accomplish the varying designs (see Fig. 59). This and the perforating of the cards requires close application. The Jacquard harness is used

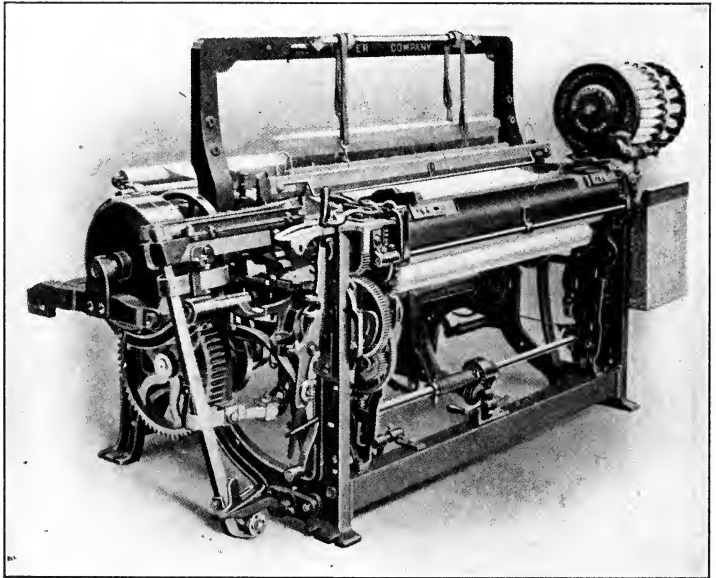

Courtesy of Draper Co.

FIG. 50. — Northrup loom for weaving plain material.

principally in the manufacture of elaborate silks and linen damasks and was invented by Joseph M. Jacquard about 1792. There are many variations of weave besides plain weaving, which is the simple alternation of warp and woof, and the Jacquard device for the elaborate pattern or figure weaving. Pattern can be produced in plain weaving

by means of color, as in stripes, checks, or plaids when the color of warp or woof thread is changed.

Plain twill and fancy twill weaving are produced by harnessing the warp so that the woof threads pass over and under the warp in such a way as to make diagonal ridges across the cloth. This necessitates a variation on each row of over and under so as to make the diagonal lines. Satin weave, as insateen or satin, is produced by the filling or woof passing over more threads than under, thus making a smooth surface of the woof. This is called a filling face satin. It is very easy in this weave to use a cotton warp and a silk filling and so produce a satin in which the cotton does not show and which is sometimes represented as all silk. A warp face satin is made by bringing most of the warp to the face of the cloth. Cotton and wool are sometimes so combined as all wool, but this weave is used more largely in silk or damask rather than in wool. There are other variations in weave which are not quite as common as the above, as lappet weave, which is a kind of embroidery. This is produced by needles on a small sliding machine which embroiders spots or other simple figures as dots in swiss or gauze. Turkish towels, velveteen, plush, and carpet are produced by the pile weave.

The finishing of cotton materials. — After the cloth is woven it is necessary to finish it before it is ready for commercial use, and various finishes are used to make the cloth salable. Before finishing, the cloth is inspected for defects and is then bleached if it is to be pure white. Starching is often used in finishing. This process weights the cloth and gives firmness for a time, but soon wears away in washing. The cloth is then pressed or calendered between rollers to produce a smooth, glazed surface. It is possible to vary this pressing so as to make various watered and moiré effects

like silk, which soon wear away. Cotton is also finished to look like silk by a process called *mercerization*, which is produced by chemical action. The yarn is dipped in a bath of strong caustic soda under tension and finally washed in water and dilute acid. This gives a lustrous appearance, and the yarn feels silky. It takes dye very readily after mercerization and is heavier and stronger. The outer layer of the fiber of cotton is affected and swells, thus reflecting more light and appearing lustrous. A good quality of long staple cotton is used for this purpose. The cost of producing mercerized yarn is more than twice that of ordinary cotton yarn. The stripes and figures in cotton materials which appear lustrous are made of mercerized yarn. It is sometimes used in the adulteration of silk.

Cotton can be finished also to resemble linen. The yarn is treated to sizing, is twisted more, and in finishing is beaten and pressed so the yarn stands out as in linen. Lisle thread, of which gloves and hosiery are made, is often supposed to be linen. This thread is cotton twisted a great deal so that the yarn is hard and strong. Cotton can be made to have also the appearance of wool. The Peruvian cotton of which some hosiery is made closely resembles wool. Chenille and velveteen are sometimes mistaken for wool, but are cotton woven in a pile and cut so as to show the numerous fuzzy ends of the yarn. Chenille curtains are woven of strips of this tufted pile cotton. Printed fabrics like calico and "silkaline" are printed by passing the plain cloth between cylinders on which the design of the pattern desired has been cut out. These cylinders take up colors from troughs in which they revolve and the impression is made on the cloth. The printed cloth is then finished so as to fix the dye and is pressed and ready for market.

COMMON COTTON MATERIALS WHICH EVERY GIRL SHOULD KNOW

NAME	USUAL WIDTH	USUAL PRICE	DESCRIPTION
Batiste	32-45 in.	\$0.15 up, according to width	A translucent light cloth made of a fine yarn. Varies in qualities. Used for shirt waists and dress goods. Coarser qualities for lining. Made in white and a few colors.
Buckram	19 in.	.12½ up	Used for interlining in garments to give stiffening and for millinery purposes.
Bedford Cord	27-36 in.	.25 up	A material with raised cord effect running lengthwise of cloth. Cords vary in width — from ½ to ¼ inch. Used for dresses, children's coats.
Calico	24-36 in.	.08 up	Cotton cloth with figured design printed on one side. First made in Calicut, India, whence name. Used for inexpensive dresses, aprons, wrappers.
Cambrie	36 in.	.10-.25	Name first given to very fine linen, made at Cambrai. Now made in cotton as well as linen. Plain weave, glazed smooth surface in finish. Sometimes coarser grades called cambrie muslin. Used for linings, underwear, dress goods. Berkeley cambrie — fine quality for underwear.
Chambray	32 in.	.20 +	A common staple fabric next to gingham. Always woven plain weave; light weight, colored warp, white filling, white selvage. Effect plain color. Used for dresses, aprons, bags, etc.

Canton Flannel	27-30 in.	.12	Heavy cotton with twilled surface one side and long, soft nap on other. Made first for trade in Canton, China. Used for children's underwear, interlining, etc.
Cheesecloth	36 in.	.05-.12	Thin, sheer, light-weight fabric; plain weave. White or colored. Used for wrapping cheese or butter, for curtains, bunting for decoration, and innumerable purposes.
Crinoline	19-36 in.	.12½ up	Used by dressmakers for stiffening. In white or black. Twenty per cent of sizing used to stiffen. Weave is plain or herring bone. Dull or glazed surface.
Cretonne	25-36 in.	.15-.75	A printed cloth rather heavy in weight. Printed in stripes and colored floral designs. Used for draperies, covers, etc.
Chintz	27 in.	.12-.50	From Hindoo word meaning variegated. A printed fabric, large floral designs of color. Used same as cretonne.
Corduroy	22 in. +	.50 to 3.00	Distinguished by half round regular ribs running lengthwise of cloth. Has appearance of velvet. Woven so as to form pile when cut.
Dimity	30-36 in.	.15 up	Light weight, thin fabric, with cords or ribs which distinguish it. Made in white or plain colors, or printed with figures. Used for summer dress fabrics.
Denim	36 in.	.18-.25	Strong fabric made with small uneven twilled weave. Used for furniture covering, overalls, floor coverings. Colors.

COMMON COTTON MATERIALS WHICH EVERY GIRL SHOULD KNOW — Continued

NAME	USUAL WIDTH	USUAL PRICE	DESCRIPTION
Duck	27-36 in.	\$0.12 up.	A heavy-weight fabric. Excellent wearing qualities. Made in many weights. Heavy used for sails, tents, awnings. Light weights for ladies' skirts and dresses, men's trousers; white or colored. First made in Damascus. A .twill and sateen weave, of geometrical or floral designs. Imitates linen damask. Used for table linen and towels. First made in silk.
Damask	1-2 yds.	.25 +	Used in manufacture of kimonas, wrappers, etc. Figures in color printed on plain surface. Slight nap.
Flannelette	27 in.	.08-.12	Used for dresses and aprons, shirtings, etc. Most universal fabric. Plain weave.
Gingham	24-30 in.	.10-.50	Many combinations of warp and woof to form stripes and plaids. Originally Indian zephyr ginghams very fine quality. Used for dresses. Madras gingham of fine quality for shirtings. Various weaves are used in finer gingham.
Galatea	27 in.	.14-.20	Used for children's dresses, outing skirts. Stands much wear and washing. Plain colors, figures, and stripes. Heavy, firm cotton cloth.
Grenadine	27 in.	.10-.15	Gauzy dress fabric, made also of all silk, silk and wool, silk and cotton, and all cotton. Plain, loose weave with stripes of satin weave. Black, white, or colors.

Huckaback	18-27 in.	.20-.65	Sold by yard, piece, or towel. Made in all cotton, all linen, or combination. Strong weave. Weave aids absorbing qualities.
Indian Head	36 in.	.15	A heavy white fabric resembling duck. Used for same purpose.
Khaki	27 in.	.25-.40	A twilled cotton used for men's clothing, dress skirts, and suits. Brown dust color, thence the Indian name meaning earth.
Linon	36 in.	.15-.25	Fine, closely woven, plain fabric. Washes and wears well. Yarn so treated that woven fabric resembles linen.
Long Cloth	36 in.	1.25-2.50 for 12-yd. piece	Finé cotton fabric, resembles slightly muslin and cambric. Soft to touch. Close weave. Used for lingerie, babies' long dresses, whence name. Made in many qualities.
Lawn	36-40 in.	.05-.25	Used for curtains, dresses, aprons. Soft, smooth finish, starched and pressed. Sheer fabric, light weight. Colored and white.
Madras	27 in.	.25	A staple cotton goods, used for shirtings, neckwear, and dresses; in color and white, in stripes and figures. White ground, colored stripe, very popular. Made first in Madras, India, of cotton and silk.
Mull	32 in.	.35	From Hindoo word meaning soft. A fine quality of soft muslin. Used for dress goods. Plain weave, white or colored. China or silk mull is union of cotton warp and silk wool.

COMMON COTTON MATERIALS WHICH EVERY GIRL SHOULD KNOW — Continued

NAME	USUAL WIDTH	USUAL PRICE	DESCRIPTION
Muslin unbleached	36 in.	\$0.05-.15	Used for sheetings, pillow cases of cheap grade. Unbleached fabrics wear better. Preferred where durability is the aim. Plain weave.
Muslin	36-72 in.	.07 up	Term given to line of soft cotton fabrics. Made in several qualities. Used for dress goods, sheetings, underwear, etc. Al-
Nainsook	27. in	.15-.50	pine rose is fine quality of muslin. A light, soft cotton fabric. From Hindoo word Nainsutch — originally a stout muslin manufactured in India. Not as much body as fine lawn or batiste. Made in several grades, used for lingerie, infants' clothes. When given the French finish it has more sizing and is slightly stiff.
Organdie	18-60 in.	.15 up	Used for dress goods. Plain or stamped with figure. It is a plain weave, very fine, translucent muslin.
Outing Flannel	36 in.	.10 up	Used in manufacture of shirts, pajamas, petticoats, infants' clothing. Similar in appearance to flannel; nap on both sides; produced by brushing up the surface. Made in plain color or striped and checked patterns.
Percale	36 in.	.12½	A closely woven firm cotton fabric made of good yarn. Originally French and made of linen. Plain or printed. Used for dresses, aprons.
Percaline	36 in.	.18	Used principally for linings or petticoats. Plain glazed surface or moirée. Solid colors. A lighter fabric than percale.

Pique	36 in.	.25	Used for dress goods, vestings, cravats, bedspreads. A heavy cotton fabric woven in figured or corded effects. The most common have straight cords running with woof or crosswise.
Silesia	27 in.	.10 up	Used for linings — a light-weight cotton fabric. Solid colors, as drab, black, brown, etc. Glazed, polished face.
Sateen	27 in.	.18 up	Smooth, lustrous surface like satin. Twilled weave. Used principally for linings.
Silkaline	27 in.	.15 up	A soft cotton printed on one surface, glazed finish. Used for household furnishings.
Serim	24 in.	.20 up	Used for household furnishings. An open mesh weave. Bleached and unbleached.
Tarletan	36-72 in.	.15 up	An open mesh fabric, light and transparent; used for drapery. Resembles mosquito and fly netting. Any color.
Ticking	36 in.	.12½ up	Used principally for pillow and mattress coverings. Woven in striped, twilled, or herringbone weave. A stout cloth, of good wearing qualities.
Velour	36-42 in.	1.50 up	Used principally for upholstery purposes, draperies, also light weight for dresses and coats. Usually of solid color. Sometimes printed and embossed. Woven and pile cut. Jute or other material for the filling or woof.
Velveteen	19-27 in.	.50 up	Used for dress and hat trimmings, upholstery, suitings. Corduroys in this group. Woven and then cut so as to form pile surface of the points of the fibers.

Other uses of cotton yarns. — The uses of cotton yarns are innumerable. The thread industry is one great specialty in itself. The knitting industry converts large quantities of cotton yarn into hosiery and underwear. Tape, belting, braids, binding, shoe and corset laces, and other narrow fabrics consume quantities. Lace making both by hand and machine requires both yarn and thread.

Cotton industry in the United States. — The first cotton mill in the United States was erected in 1788. As early as 1831 there were 800 factories in the New England States producing cotton fabrics, and 62,000 operatives engaged in the industry with a consumption of 75 million of pounds. Since then the advance has been rapid, and the development of the cotton industry in the Southern States has astonished the business world. At the present time about 2000 million pounds are consumed annually. The New England States, however, remain the center of the American cotton industry, Massachusetts leading, then Rhode Island, New Hampshire, and Connecticut. The presence of water power in New England explains its early success. This has been supplemented by steam with rapid development. In the South, Georgia, Alabama, North and South Carolina have shown greatest growth in this industry. The center of the cotton spinning industry in the South is at Charlotte, N.C.

EXERCISES

1. Give reasons why women should make a study of textiles.
2. In what way did Eli Whitney's gin revolutionize the cotton industry? Describe modern cotton ginning.
3. Compare the American system of baling with that of other countries.
4. What products are made from the cotton seed?
5. Describe the two principal systems of spinning machinery.
6. How is cotton thread manufactured?



FIG. 51. — Cotton weaving room, Olympia Mills, Olympia, South Carolina.

7. Name and describe various methods of producing patterns in cloth by weaving.

8. Describe the working of the colonial type of loom.

9. Describe four ways in which cotton is finished to resemble other materials.

10. Get samples of common cotton materials. Classify and mount in convenient form for reference. This can be an individual or class problem. Names, widths, prices of samples obtained should be given.

11. Describe the growth of cotton manufacture in the United States. Give causes.

CHAPTER IX

FLAX

NEXT to cotton the most important vegetable material for spinning is flax or linen. It is a bast fiber which is obtained near the outer surface of the plant stem.¹ The inner tissues are woody and of no value.

Where grown. — Flax has been cultivated for at least five thousand years in Egypt and Assyria. It was known to have been used by the Swiss Lake Dwellers, and is found wild in Europe, Northern Africa, and parts of Asia. We are told in Genesis, Chapter 42, that Pharaoh arrayed Joseph in vestures of fine linen. Russia to-day produces about half of the world's supply, but it is largely of inferior grade. Ireland and Belgium produce the best quality of fiber. It is grown also in Holland, France, Egypt, and Italy, and to some extent in the United States.

Varieties of flax. — The flax plant is classified botanically as belonging to the order Linaceæ. It has numerous varieties, of which those belonging to the species *Linum usitatissimum* are the most common. It adapts itself to varying climatic and other conditions, and is an annual, with erect stalk, which reaches the height of 20 to 40 inches. It has narrow lance-shaped leaves which are borne on stems that branch at the top, bearing a tiny blue flower. The seed pod is five-celled, each cell containing two seeds. They are

¹ A bast fiber, such as ramie or flax, is the fiber from the inner bark of exogenous plants. It must be cleaned and free from the gum before it can be used.

smooth, glossy, and greenish brown in color and of great value commercially as the source of linseed oil and linseed (flaxseed) meal. A microscopical examination of the fiber shows it to be a long, cylindrical tube of uniform thickness. It varies in color from pale yellow to gray and greenish tints. It averages in length about twenty inches, but is often thirty or forty inches. It is almost purely cellulose and shows microscopically the bast fibers running longitudinally.

Flax culture. — The cultivation of flax is one of the most ancient industries. In general, flax prospers best when grown on a deep, well-cultivated, but not too heavy soil. When grown for fiber, it is planted thickly so as to produce tall, slender stems free from branches. When grown for seed, it is planted more scantily to give opportunity for branching. When cultivated for fiber, the crop should be pulled before the seeds are quite ripe and while the stalks are brownish yellow. Flax exhausts the soil very quickly, the average occupancy being eight years in the Courtrai region in Belgium. Flax culture in America is expensive because of the hand labor required. Flax for fiber is pulled by the root and laid on the ground with root ends together and stalks parallel. The pulling is done in clear weather and the stalks are bound in bundles or stacked in stooks. The next process is *rippling*, or the removal of the seed from the capsules. This is usually also a field process and must be done so as not to injure the fiber. The simple machine for rippling is a kind of comb of iron teeth set in a wooden frame. This is placed on a large sheet so as to collect the seeds as they fall. After rippling the fiber is arranged in bundles for the *retting*. This is a most important process and is really the rotting away of the outer woody surface of the flax stem by means of fermentation. Flax is retted by dew and by water. When dew retted it is spread on the grass and subjected to

dew, sunshine, air, and rain. It is a slow process but necessary in order to break up the outer woody surface of the stem and free the valuable fiber. When retted by water, the bundles of flax are laid closely together in the ponds. Sometimes the bundles are placed in open slatted crates which are lowered in the water and weighted. The fermentation soon takes place and in about two weeks the flax is ready to be removed. A soft water free from iron is essential. If left too long in the water, the flax is weakened. If not long enough, some of the gummy substances are left, which interfere with the processes of manufacture. The retted flax is then spread to dry in the fields and in about two weeks it is ready for the *breaking*. This process is sometimes accomplished by hand with simple implements which break away the outer woody part of the stem, partly cleansing the fiber. Small steam or water power scutching mills generally perform this operation. The fluted rollers for breaking and scutching are arranged to work backwards and forwards, and as the flax passes between, the outer surface breaks away. The flax is then ready to be manufactured into yarn.

Flax by-products. — The flaxseed, or linseed as it is called, is very valuable commercially. The brown, elongated seed is crushed for the oils. The cake or meal left is a valuable food for cattle. Linseed oil is a most valuable drying oil. When pressed cold, it is often used for food, especially in Russia and Poland. When pressed hot, the color is brown. This oil is used in the preparation of oil paints and varnishes. It is also used in making linoleum and is one of the principal ingredients in lithographing inks.

Linen yarn manufacture. — Linen yarn manufacture is one of the oldest industries of the world, as well as one of the most extensive and widely disseminated. Until com-

paratively recent times flax was spun with the spindle, the distaff holding the yarn. In the sixteenth century the flax wheel succeeded and continued in use until the end of the eighteenth century. The inventions of Arkwright, Hargreave, and Crompton were especially for cotton yarn, and the manufacture of linen yarn suffered from the aggres-

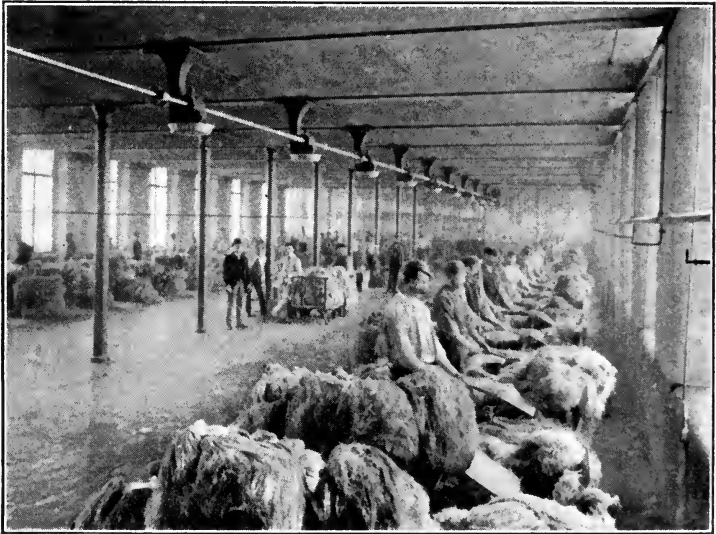

Courtesy of York St. Mills, Belfast.

FIG. 52. — Roughing flax.

siveness of the new industry. A machine was needed to spin flax yarn as quickly as cotton, and rewards were offered from time to time in the hope that some inventor would give his attention to this need. Linen is not as universally used as in our grandmother's times, for cotton has become cheaper through use of machinery. Our grandmothers grew, prepared, spun, and wove the flax for their sheets, clothing,

and household uses. The small cups on the old spinning wheels held water for wet spinning. Dry spinning was not considered as fine.

In modern factory spinning the scutched bundles of flax, measuring from twenty to thirty inches in length, are de-

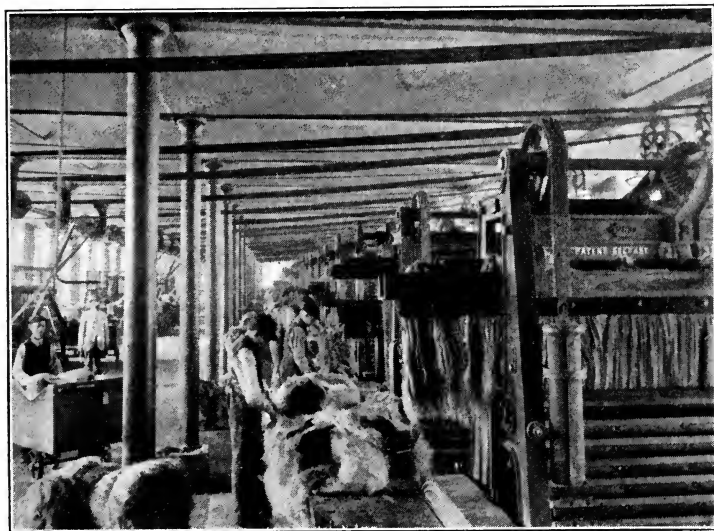

Courtesy of York St. Mills, Belfast.

FIG. 53. — Machine hackling or preparation of the flax for the spread boards.

livered at the flax mill. The first process is grading and labeling ready for use. The flax is then prepared for spinning by means of the hackle. This process, called roughing, when done by hand is accomplished on a board containing teeth through which the hackler draws the flax, cleaning and combing it (see Fig. 52). The long fiber is called the line and the short combed out fibers the tow. When hackled by machinery the first step is called roughing. The bundles

of flax are fastened in a holder of two iron plates. By a motion of these plates up and down the line of flax is subjected to a combing process from the hackle teeth of the machine (see Fig. 53). The tow from the hackle is put in a carding machine and is used for coarser purposes. The line is then sorted according to quality and is ready for the

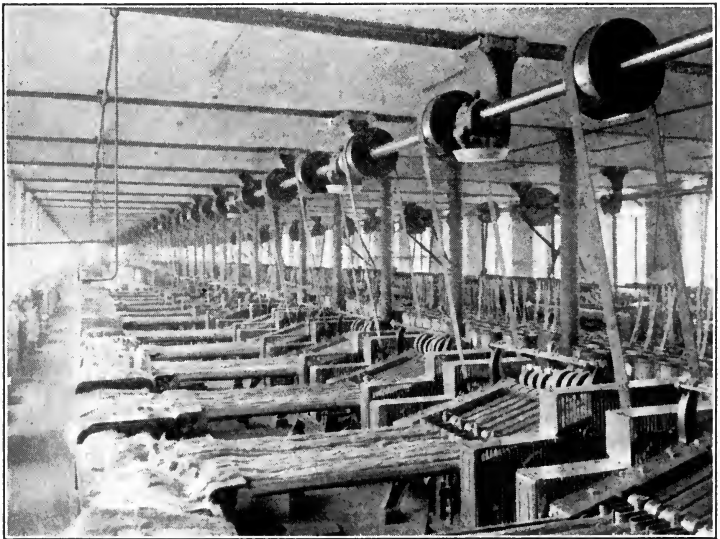

Courtesy of York St. Mills, Belfast.

FIG. 54. — Spreading flax in preparation for spinning.

spreading. The spread boards deliver the flax, on a traveling sheet where it is laid by hand in small bundles, to the "gill," a set of teeth in the machine which again clean it and form it into a sliver similar to the cotton sliver for spinning. This is the first time the flax is in a continuous length and ready to be made into yarn. Care must be taken to overlap the bundles on the spread board so that the line of flax will be continuous (see Fig. 54).

The slivers of flax are delivered from the spread boards in cans and subjected to processes similar to those in cotton manufacture which reduce the size of the sliver. The roving frames then put in the twist as in cotton yarn manufacture, and the flax is ready for spinning. The flax spinning machinery is similar in principle to the ring spinning frame

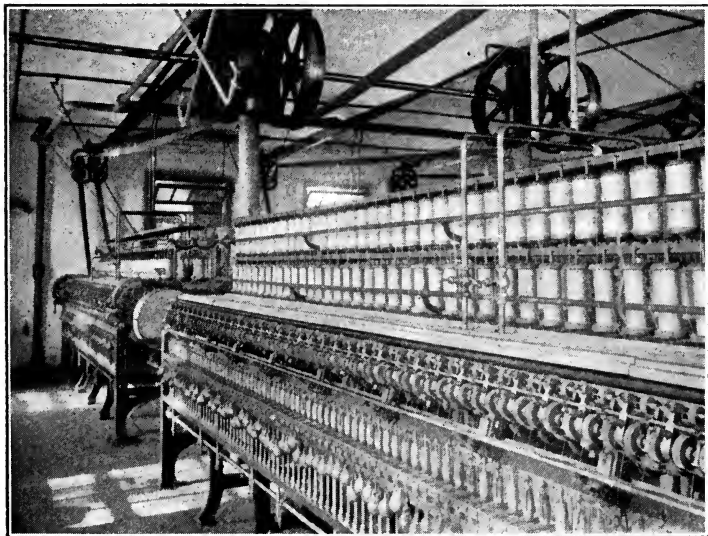

Courtesy of York St. Mills, Belfast.

FIG. 55. — Flax spinning.

used for cotton (see Fig. 55). The rovings are drawn out, twisted, and wound. The rovings pass between rollers and in wet spinning through a trough of warm water which dissolves some of the gummy substance of the fiber and makes possible a finer, smoother, firmer yarn.

Linen cloth manufacture. — Linen was woven by hand for many years after power loom weaving was used for the

manufacture of other textile fibers. This was due to the hardness and inelasticity of the linen yarn. Even to-day much of the fine linen is woven by hand. The factories of Aberdeen, Scotland, may be credited with perfecting the use of the power looms for linen weaving (see Fig. 56).

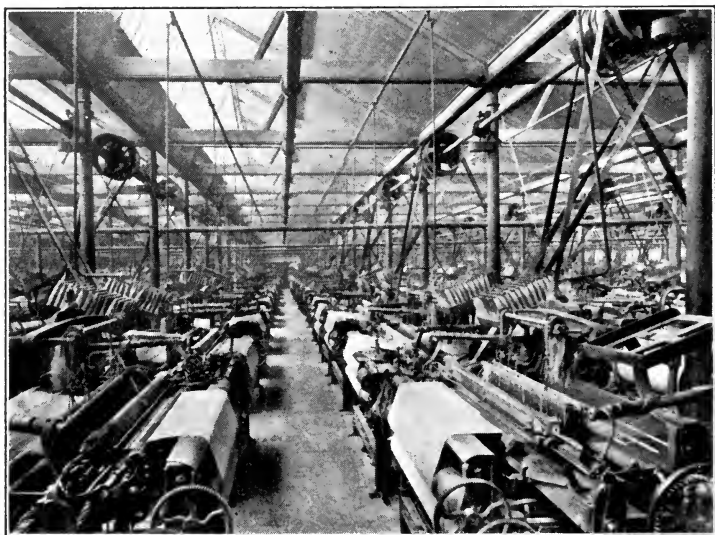

Courtesy of York St. Mills, Belfast.

FIG. 56. — Weaving.

The processes of preparation of the warp (see Fig. 57), the reeling, spooling, dressing, beaming, and drawing in or harnessing are the same in essential principles as the processes described for cotton weaving in the last chapter. The dressing of the warp in preparation for beaming is important in linen manufacture. A paste of flour or farina is used for this purpose. Linen fabrics as produced on the power looms of to-day with the Jacquard harness are wonderful

in texture, design, and quality (see Fig. 58). The beauty of the table damasks is not rivaled even by silk. The French designs are the most beautiful, the Scotch and Irish rank next (see Fig. 59, for the way in which the patterns are prepared).

The finishing of linen materials. — Linen is bleached sometimes in the yarn or in the thread, but often in the

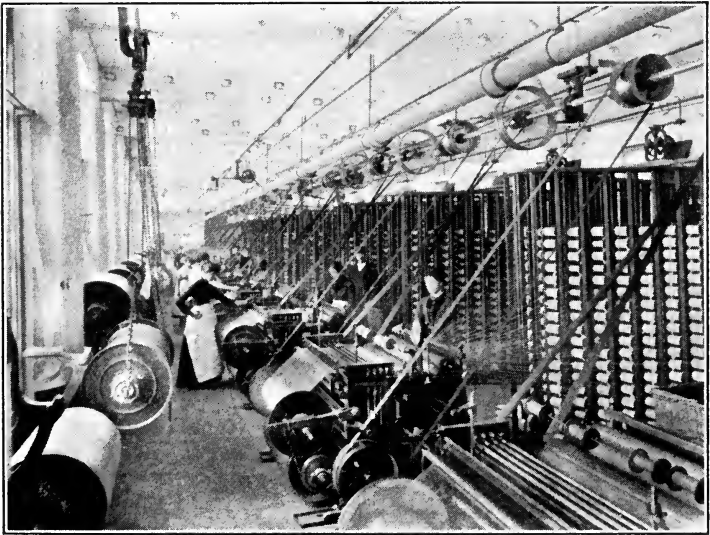

Courtesy of York St. Mills, Belfast.

FIG. 57. — Warping in preparation for weaving. The creel holds the spools.

cloth. It is done to-day principally by chemical process, but in our grandmother's time the process was a slow one, taking weeks and months. It was accomplished by wetting the cloth with sour milk and spreading it on the grass to bleach. In the process of bleaching, from 20 to 25 per cent of the weight of the linen is lost. Ireland is celebrated for

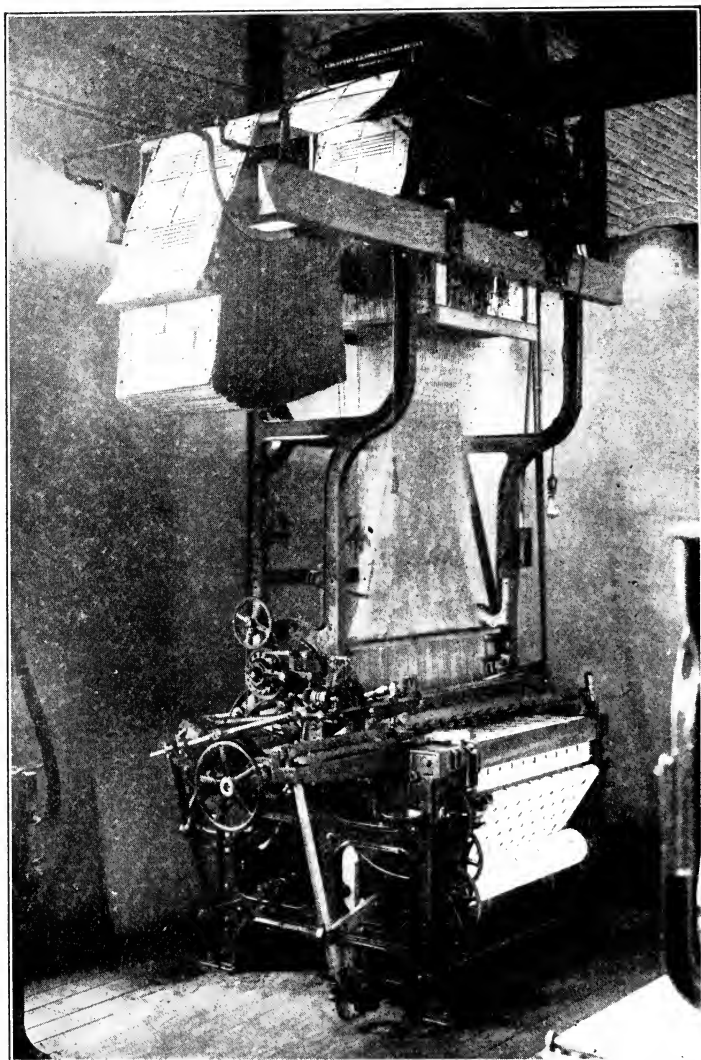

Courtesy of Crompton & Knowles.

FIG. 58.—Jacquard weaving. Beautiful pattern damasks are woven on this kind of loom.

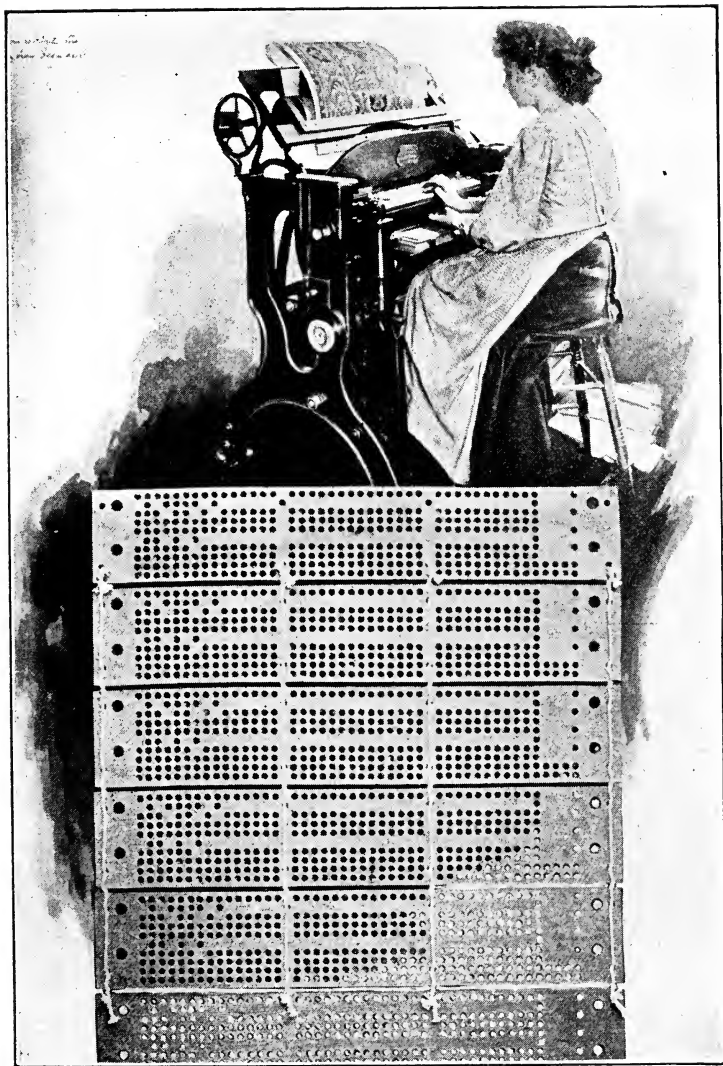

Courtesy of W. J. Whithall & Co.

FIG. 59. — Cutting patterns. The cards for the Jacquard loom, which regulate the pattern, are cut on this machine from the designer's drawing.

the purity of its linen. Chemicals are sometimes used in the early stages, and crofting or grass bleaching perfects the process (see Fig. 60). One can ride for miles in Ireland and see the linen spread in endless lengths on the grass. German unbleached linens are less expensive to buy because of less loss in manufacture through bleaching.



Courtesy of York St. Mills, Belfast.

FIG. 60. — Bleaching green.

After the bleaching, linen cloth is finished for commerce. It is passed through rub boards which wash it (see Fig. 61). Then drying, beetling (see Fig. 62), calendering, and pressing complete the finish. The beetling of the linen is a beating process which makes the fiber stand out. The calendering adds glaze and by pressing between rollers gives a smooth surface. Cotton is sometimes beetled to give the effect of linen, but the glaze is then easily removed by washing. Linen fabrics, if at all good, range in price from \$.60 to \$4 per yard.

Linen materials vary in quality and weight and certain countries are noted for their specialization in this manufacture. Certain parts of Scotland are noted for the manu-

facture of heavy linen, as sail cloth, canvas, sacking. Fine linen manufacture is centered in Belfast and the north of Ireland. Leeds and Barnsley are the centers of the linen trade in England. Damasks are produced principally in

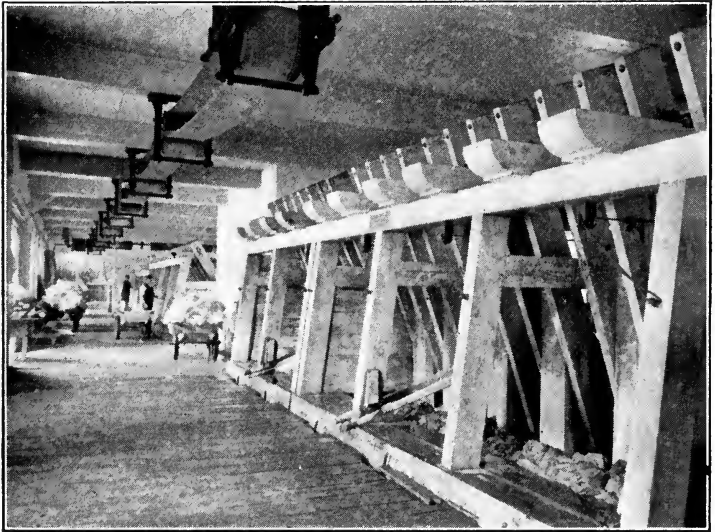

Courtesy of York St. Mills, Belfast.

FIG. 61. — Washing of linen after weaving.

Belfast and Perth, and dyed linen fabrics are made especially in Germany.

Other uses of linen yarn. — Beside the wide variety of fabrics, linen yarn is manufactured into various kinds of fine and heavy thread. The trade in linen thread is very large, as it is used in the machine manufacture of boots, shoes, leather goods, and saddlery. The thread industry is centered largely near Belfast in Ireland and in Paterson, N.J. Yarn and thread are also manufactured into very

fine lace. Cord, twine, and ropes are twisted from flax yarn.

The linen industry in the United States. — Very little flax is grown in the United States for fiber, though considerable quantities are raised for seed. In Minnesota and Kansas some experiments have been tried. The growth of weeds is

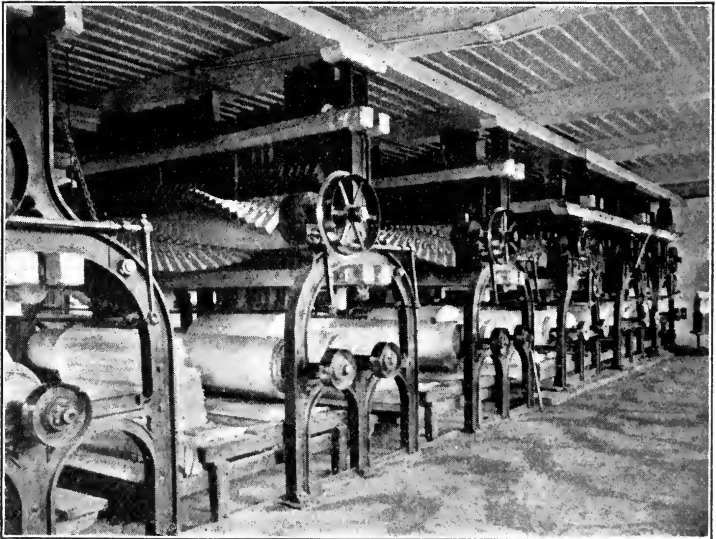

Courtesy of York St. Mills, Belfast.

FIG. 62. — Beetling, a finishing process of linen.

one of the chief obstacles to the success of flax culture in the United States. It is impossible to get the cheap labor for weeding that is possible in foreign countries. Machines are needed for pulling and other processes in the culture. The Minnesota flax is the best grown, but the materials manufactured from it are very inferior to the foreign-grown varieties. Flax costs twelve to thirty cents per pound.

COMMON LINEN MATERIALS

NAME	USUAL WIDTH	USUAL PRICE	DESCRIPTION
Batiste	36 in. +	\$1.00 up	Fine linen, waist and dress linens. Similar to linen lawn.
Butcher's linen	27-44 in.	.40-1.50	Used for butchers' aprons, dress skirts. A heavy, coarse weave.
Cambrie	36 in.	.50	Sheer linen used for dress goods and handkerchiefs.
Canvas	27-36 in.	.25	Used for interlining or upholstery purposes.
Crash	18-36 in.	.15 up	Used for toweling, dresses, upholstery uses.
Damask	Figured weave. Used for towels in width 16-36 in. and for table linen, 1½ yds. wide, and napkins.
Diaper	24 in.	.30 up	Bird's-eye pattern. Used for toweling.
Huckaback	18 in. +	.15 up	Coarser qualities for dress goods. Peculiar weave showing much surface of woof thread. Absorbs very readily. Used for toweling. Sometimes combined with cotton. Union goods are cheaper.
Handkerchief linen	30 in.	.60-2.00	Fine plain weave. Used for handkerchiefs and dresses.
Holland	27-36 in.	.35-1.00	Coarse linen, used principally for shades.
Linen lawn	36-44 in.	.40-1.00	A fine, sheer linen. Used for dress goods and handkerchiefs.
Sheeting	All widths.	1.00 up	Wide linen. Used for bed sheets and dress and suit materials
Velour	54 in.	1.00 up	Upholstery materials. Woven and cut in pile like velvet.

Other vegetable fibers.— There are many other useful vegetable fibers of commerce besides cotton and flax. The United States Department of Agriculture issues a bulletin

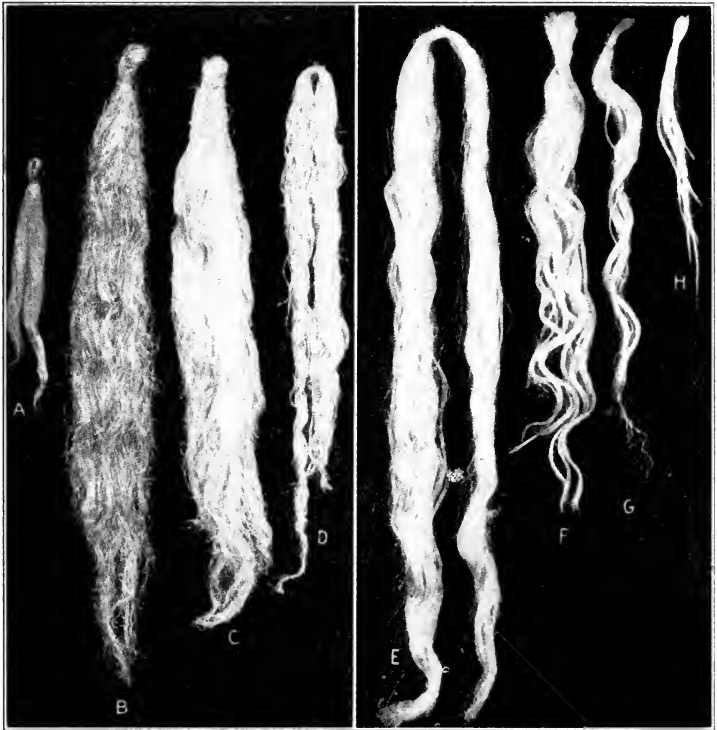

Courtesy of U. S. Dept. of Agriculture.

FIG. 63. — Flax and other vegetable fibers used for commercial purposes.

[A, Flax; B, C, Hemp; D, Jute; E, F, G, H, Manila, Sisal, and other hard fibers.]

in which over one thousand are mentioned. The principal ones are Hemp, Jute, and Ramie. *Ramie*, called also China grass, is a shrub growing from five to eight feet when cultivated. It is three times as strong as Russian hemp, and its

filaments may be separated to be almost as fine as silk. It is a bast fiber and is only half as heavy as linen. It grows in southwestern Asia. China and Japan cultivate much of it. It is growing in importance commercially, for it can be used to resemble silk in mixing fibers and is often used in adulterating wools. It can be woven into fine, beautiful fabrics, and will doubtless be used much when cheaper methods of cleaning have been found. It is used also for fine paper, and the pulp is especially valuable for bank note paper. Coir and Pina (see Fig. 63) are also used extensively. Hemp is used principally in the manufacture of cord and rope. Jute is not quite as strong and is used for sacks, bagging, and the finer varieties for mixing with silk, cotton, flax, and wool in the manufacture of plushes and carpets.

EXERCISES

1. What part of the flax plant produces the linen fiber? Name the principal countries where it is grown.
2. Describe the process of flax retting.
3. Name the by-products of the flax plant and tell their uses.
4. Name and describe the finishing processes for linen manufacture.
5. Collect samples of the common linen materials. Mount with prices, width, and use. Mount also union materials of cotton and linen.

CHAPTER X

WOOL

THE most important of all animal fibers is wool, which is a variety of hair (see Fig. 64). It is the soft, curly coat of the sheep and some other animals, like the angora goat, camel, and alpaca. Wool varies in fineness, and the coarse wools are called hair. The principal difference is that hair has a smooth surface and lies straight, and the wool is characterized by its wavy length, fineness, softness, luster, and serrated surface. The serrations can be seen microscopically and resemble the overlapping of the scales of the pine cone.

Where grown. — Sheep have been raised for clothing wools from time immemorial. Abel was a keeper of sheep, and King David of Israel wrote some of his beautiful psalms as he tended the sheep on the hillside. Nero had the walls of his palace covered with gorgeous textures of wool. Pliny speaks of the use of wool and linen. Homer and Virgil describe the processes of wool preparations, and Alexander, in early days, on expeditions to India, saw woolen shawls of great beauty. The wool industry in Australia, England, South America, South Africa, and the United States is very extensive. England, Spain, and Germany all give much attention to sheep raising.

Many varieties of sheep furnish wool. The merino sheep gives the finest. The angora goat of Asia Minor provides us with mohair, a beautiful, lustrous fiber resembling silk. The llama and alpaca wools are found on sheep of Peru and Chili. The camel also furnishes a beautiful soft fiber.

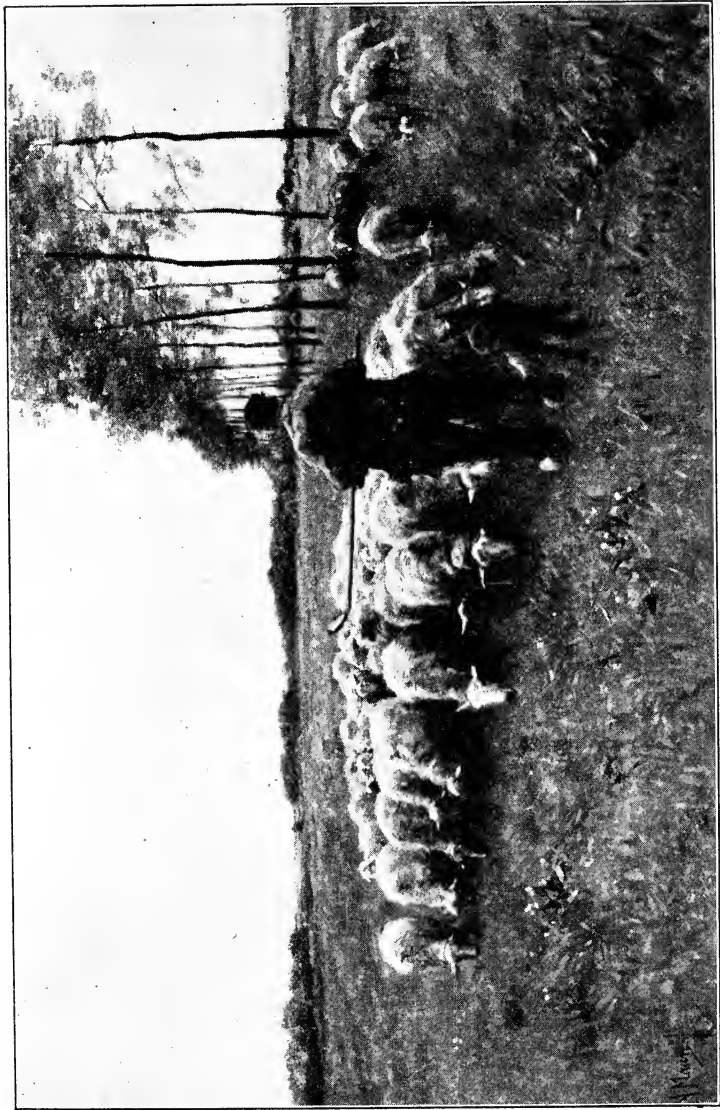

Courtesy of Metropolitan Museum of Fine Arts.

FIG. 64.—The source of our wool supply.

Varieties of wool. — Wool fibers vary in length, strength, fineness, softness, luster, and elasticity. Among different breeds of sheep the staple (or length of fiber) is very different. The average is about seven to eight inches. The fibers also vary in the number of serrations to the inch. A microscopical examination of the wool fiber will reveal the surface covering of minute scales. These are very important, for upon them depends the felting property of wool, which is its chief characteristic. It is the interlocking of these small serrations or scales of the fibers as they are mixed that makes possible the close texture of cloth and yarn. In fine felting wools there are as many as three thousand serrations to an inch of wool fiber. The microscope also reveals the porous nature of the fiber; the center or pith can be seen in a transverse section. This characteristic enables wool to take dye readily.

The length and quality of the wool staple are affected by climate, breed, and soil. Where the pasture is rocky and soil barren, the wool is generally coarse. The cross breeding of sheep produces many qualities. Many varieties find their origin in different climatic conditions. In southern England, where it is warmer than in the north, the wool is short and fine. If the sheep are removed north, the wool grows longer and stronger. Commercially there are three varieties of wool: the long, coarse wools, used for carpets and knitting because of strength; the short clothing wools, about three or four inches in length; and the long wools of good quality called combing wools.—about ten inches in length. The Saxony and Silesian wools are very fine in quality. The fiber is not long, but has excellent felting properties. English wools are of several qualities. The long wools are from Lincoln and Leicestershire, the shorter from Suffolk and Shropshire. There are several varieties of

Australian wools. A coating of wool as sheared from a sheep is called a fleece.¹ Fleeces vary in weight both as between different breeds and different animals of the same breed.

Wool culture. — The sheep industry of the United States is a very important one. The great states of the West, Idaho, Wyoming, Oregon, and Montana, support over 35 million sheep. Sheep are generally sheared once a year, usually in April or May. The old method with hand shears has been succeeded by the use of the machine clippers, for with such vast numbers it is necessary to use power. On the large ranches these power plants are installed at various places. The machine method saves much wool, as it shears closer. The fleeces are tied into bundles and then packed in sacks which hold about 400 pounds. They are then ready to be taken to certain wool shipping centers, where buyers examine and purchase large quantities.

Manufacture of yarn from wool. — When the wool is unpacked at the mill it is said to be “in the grease,” that is, the fleece is greasy, dirty, and unwashed (see Fig. 65).² The first process is to divide the fleece into different grades; this is called wool sorting, for wool from the head and upper part of the back and sides is finer than that from the belly or shins. Usually about six or seven grades are enough to separate it for spinning yarns of different qualities.

Wools cannot be made into yarns until the impurities are

¹ Other wools besides sheared wools come to the mill to be sorted. That from pelts of dead sheep is called dead wool. Wool from sheep that have been slaughtered is called pulled wool. The pelts after being washed are treated with a preparation that loosens the root of wool fiber from the pelt.

² The wool is sometimes shipped as washed wool, the sheep having been washed on the farm before shearing. Most manufacturers prefer the wool in the grease because it is better preserved in shipping, although dirt and grease are weighed with the wool.

removed. The grease of the wool is called yolk. This is the secretion from the skin of the animal and forms an encrusting surface to the fiber with the dirt and sand and preserves and keeps it soft. Wools from warmest countries have most yolk. As much as two thirds of the weight of the fleece may be yolk and dirt.

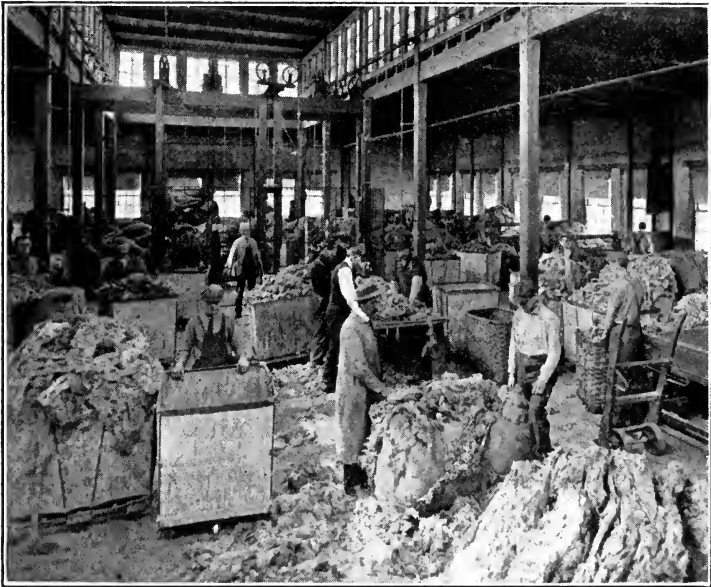

Courtesy of M. J. Whittall.

FIG. 65. — Wool sorting.

This grease must be washed from the wool before it can be carded, and the washing must be done carefully so as not to injure the fiber. Soft soap made from caustic potash is the most harmless. Soft water at a low temperature (about 120° F.) is necessary, as the high temperature harms it

very much. Strong alkalis destroy wool, and washing to remove impurities must be done carefully. The wool in factories is washed in a series of tanks, usually five, and the wool passed by rollers from one tank to another (see Fig. 66). The wool in the tanks is swished back and forth by means of wooden forks which carry it forward and beat out

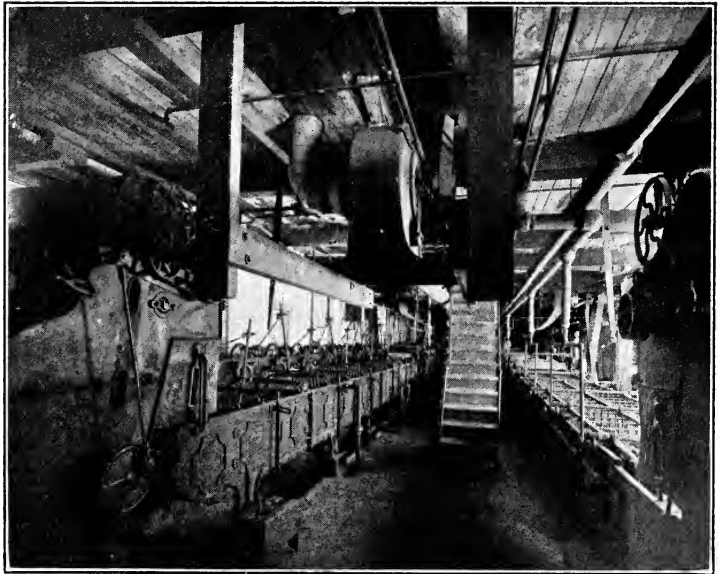

Courtesy of M. J. Whittall.

FIG. 66. — Wool washing or scouring. Notice the rakes in the machines which move the wool back and forth in scouring.

the wool. After leaving the washing machine the wool is dried in the "hydro-extractor" and beaten into a fluffy mass. About 70 per cent of the moisture is driven off. Wool, because of the nature of the fiber, has the power to retain a certain amount of moisture, up to 30 per cent of its

weight, hence it is said to be hygroscopic. This moisture helps to keep the fiber soft.

After the wool has been washed it is necessary to return to it some of the oil which has been removed in order to help



Courtesy of M. J. Whittall.

FIG. 67. — Wool carding. Notice the round cylinders revolving around the center cylinder. The web is being delivered into the can at the front.

in the spinning process and make it soft and elastic. Olive oil of good quality is used.

Wool although carefully washed may still contain burrs, leaves, and dirt which the sheep have gathered in the pasture. These must be removed, because if left in the wool they would later cause it to break. Sometimes a machine called a burr picker is used in which the dirt is beaten out. More

often a chemical process—carbonizing—for removing the vegetable matter is used. The wool is immersed in a weak solution of sulphuric acid, then dried at a temperature of 75° C. Vegetable matter becomes dust and is easily removed. After being freed from burrs by carbonizing, wool is ready for the first spinning process.

It seldom happens that new pure wool is used exclusively for fabrics. When it is, the cost of the material is very high. Of such material there would probably not be enough to clothe everybody. Wool is therefore blended or mixed before it goes to the carding machine to be further cleansed and mixed. This blending is done for several reasons. Each manufacturer knows what style, color, and grade of material he wishes to produce, and blends his wool accordingly. Cheapness of quality is one of the principal reasons for blending, and if it were not for this, few of us could afford woollen garments. The wools to be blended are spread out in thin layers, and passed through a machine which pulls the wool apart and mixes it. The products that are used in mixing to reduce the cost are remanufactured wool and substitutes. At this point the manufacturer may mix in cotton or jute if he wishes to adulterate or produce a very cheap fabric.

If, however, he wishes an all wool cheap fabric the substitutes used are shoddy, mungo, noils, flocks, and extracts. Shoddy is made from old rags of woollen materials, such as stockings, flannels, soft underwear—materials which have not been felted. The rags are ground, washed, and prepared for mixing with the new wool. Mungo is derived from wool rags which are of felted materials, such as broadcloth and fabrics for men's suitings. Flocks is the waste from the finishing machines when cloth is clipped or sheared. Noils are the short fibers left from the combing machines, which use the long fibers only. Extracts are the wools that are obtained

by carbonization from old materials which had been made from the union of materials. The manufacturer selects from these remanufactured products those best adapted to produce the grade of yarn he wishes. There are two kinds of yarn made from wool, *worsted* and *woolen*, and these are quite different in character and used for different grades of cloth.



Courtesy of M. J. Whittall.

FIG. 68. — Wool combing. This machine is used in the manufacture of high grade wools. There is much waste.

Worsted yarns are made from wool that is prepared for spinning so that the fibers lie parallel. It is stronger than woolen yarn. Long wool is used, and it goes through several combing processes so that the short fibers are removed and the long, straight ones used. This makes an expensive yarn.

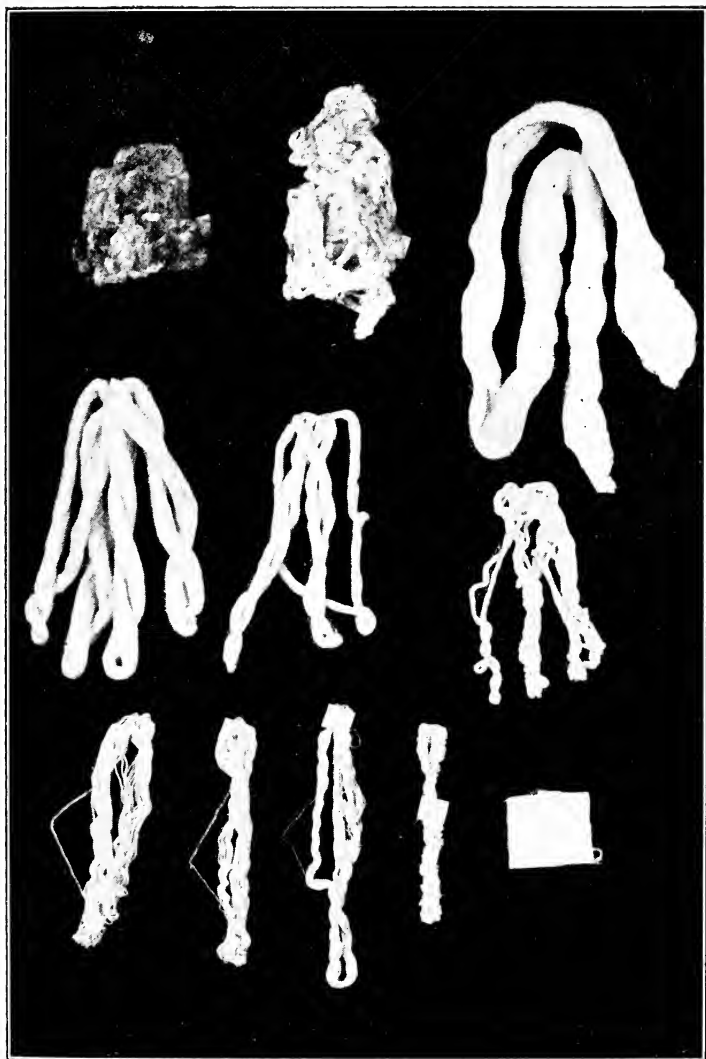

FIG. 69.—From raw wool to cloth. Showing reduction in size of roving, as it passes from machine to machine.

Combed worsted yarn of fine quality is used for high grade worsted materials and underwear. *Woolen yarn* is not combed, but carded a great deal so that the fibers lie in every possible direction. The serrations of the wool fibers are thus arranged for felting, when a warm temperature loosens up the gelatinous scales of the fiber and they interlock. One can readily understand why yarn for underwear should not be carded very much. The woolen yarn is woven into cloth which is felted, and we have the close, beautiful broad-cloths and meltons.

Wool carding is the first operation in preparation for spinning (see Fig. 67). The wool carder accomplishes the same result as the cotton carding machine. The wool carder is composed of a number of small cylinders which revolve around a central one. The wool passes from the carder in the form of a gauzy lap the width of the machine, mixed and cleansed and delivered as a sliver or rope of wool in the cans placed to receive it. If the wool is to be combed, the wool slivers are passed through the combing machines to be laid parallel. The wool combing machine is very complicated. Fine wire teeth separate and comb the fiber and deliver it in the form of a huge ball of soft, ropelike wool (see Fig. 68). These balls are called "tops" in the trade. Many manufacturers are engaged in making "tops" for various spinning manufacturers making yarns. At this point combed wools are put through a set of machines called gill boxes, which further straighten and arrange the fibers. Before the wool slivers are ready for spinning they must be drawn out and doubled, as in the process of cotton yarn manufacture, by means of the drawing and roving frames. These machines gradually reduce the thickness of the roving and put in some twist (see Fig. 69). The woolen or worsted yarn is then ready for spinning. Woolen spinning is either intermittent,

as in mule spinning, or continuous, as in ring spinning. The mule is better adapted to the spinning of woolen yarn, and the ring and other continuous frames to worsted (see Figs. 70, 71, 72).

Manufacture of cloth from wool. — The yarn, either worsted or woolen, is warped for the loom warp beam or wound on bobbins for the woof. Wool, like cotton, can be made

in many counts or numbers — fine or coarse yarns. Fabrics made from wool are numerous in design, from the plain homespun weave to the more complicated patterns of double



Courtesy of Johnson and Bassett.

FIG. 70. — The old way of spinning on the great wheel.

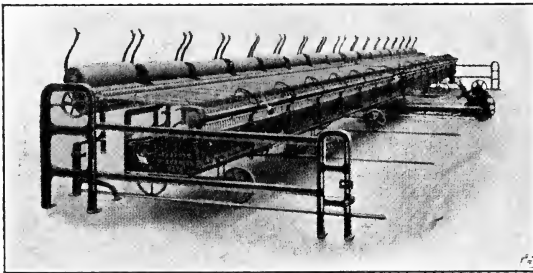

Courtesy of Johnson and Bassett.

FIG. 71. — The modern way of spinning on Self-acting Mule.

cloth weaving. The woolen yarn is more fuzzy than the worsted, and when used for cloth is woven more loosely; but in finishing it is shrunken to make a smooth, compact surface.

The yarns for weaving are harnessed as described under cotton manufacture, and materials of various patterns woven (see Fig. 73).

Dyeing. — Most wool is dyed either in the raw state or as yarn or cloth. Wool takes the dye readily, which means that the surface of the fiber takes a uniform color. Many kinds

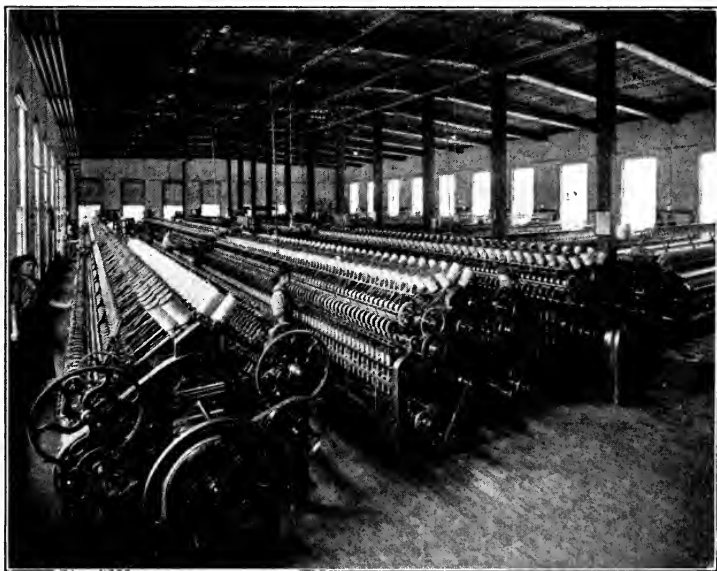

Courtesy of M. J. Whitall.

FIG. 72. — This spinning room shows the ring spinning machine in operation.

of dye have been used. Our grandmothers were experts in the use of vegetable dyes, but to-day the coal tar products are available in hundreds of colors. Wool takes dye more easily than cotton or linen. The dyeing of cloth is done in large vats on rollers; when dyed in the hank, the yarn is lifted on sticks in and out of large tanks containing the dye

(see Fig. 74). Yarn dyeing is better adapted for use in weaving certain fabrics (see Fig. 75).

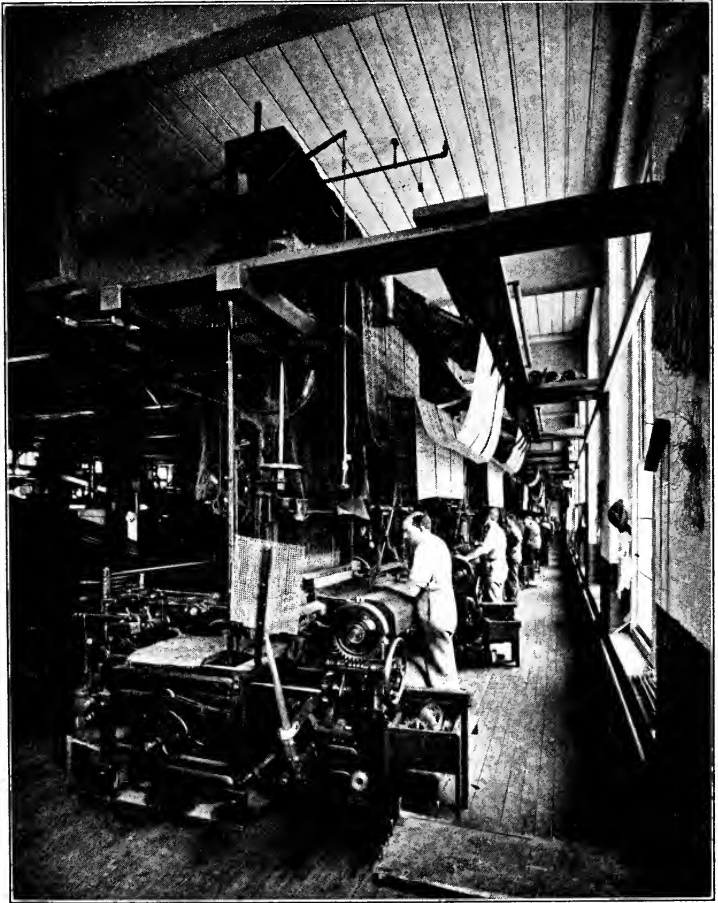

Courtesy of M. J. Whittall.

FIG. 73. — This shows the Jacquard loom used for weaving rugs and carpets.

Finishing of Wool Fabrics.— On account of style and the rapid changes from year to year manufacturers must finish their materials so as to meet the demands of trade. This means that the blending, dyeing, kind of weave, finishing, must all be carefully considered. There are, of course, certain fabrics which are staple goods and always finished in the same way, but the fancy weaves must vary yearly. Worsted cloths do not require as many finishing processes as do the woolen fabrics. The materials after weaving are first inspected over rods for imperfections, and a process called burling takes place. The examiner cuts the broken ends tied by the weaver, marks the places to be mended, and then sends them to the *mending room*. There materials are darned and mistakes in weave corrected. This is very exact work, requiring skill. The material, rather loosely woven, is then ready for the next finishing process of *fulling*. The aim of this is to produce a smooth, stronger, firmer material.

Worsted materials are fullled or shrunken little; woolen, a great deal. Material woven seventy-two inches wide is often felted to fifty-four inches. This process is done in large vats with water and soap, and at a certain warm temperature. The serrations of the wool fibers open, interlock, and as the water gradually cools, remain interlocked. In fulling broadcloths and other closely woven materials this process is continued for a greater length of time than for worsted materials. The physical properties of the wool fibers make this change possible. The cloth is dried, and then tented or stretched. After tenting some moisture is again added to the cloth before the process of napping. Some materials have a decidedly napped surface, as in blankets. The cloth is passed between rollers covered with teazels. The points rough the surface as the cloth passes

between the rollers. The cloth is then sometimes sheared. This produces "flocks or filling," the fuzz clipped from the cloth, which is sometimes used in the process of fulling, where it is introduced as adulterant to produce a firmer



Courtesy of M. J. Whittall.

FIG. 74. — The dyeing of hanks of wool.

broadcloth. The "flocks" shakes out as the material is worn. One sometimes notices in woolen skirts the accumulation in seams and hems of this soft, woolly substance. After shearing, the cloth is ready for the final pressing and is marketable or ready for the wholesale dealer.

Other uses of yarn made from wool. — Woolen or worsted yarns are also used in the manufacture of carpets (see Fig.

73), rugs, underwear, hosiery (see Fig. 76), blankets, and for hand knitting purposes — shawls, afghans, caps, sweaters, and innumerable small articles. Woolen and worsted yarns are often combined with cotton in the adulteration of wool fabrics. Shoddy or worked over wool fabrics are



Courtesy of M. J. Whittall.

FIG. 75. — Drying yarn. After the wool has been wound into hanks it is dyed and dried.

usually legitimate additions, but cotton yarns combined with wool in the twisting of yarn or combed with it are not legitimate unless sold for what they are. The pictures in this chapter show the steps in the making of rugs and carpets of good quality. Notice especially the Jacquard carpet loom.

COMMON WOOLEN AND WORSTED MATERIALS

NAME	USUAL WIDTH	USUAL PRICE	DESCRIPTION
Alpaca	36-45 in.	\$0.75-1.00	Fiber from llama, bright, strong, elastic, soft, combines with cotton readily. Fabric has glossy brightness of silk. Imitations are made of all cotton. Used for dress goods, men's coats, linings, etc.
Albatross	38-45 in.	.50-1.00	Used for dress goods. Soft open texture of wool. Made in fancy weaves.
Bedford Cord	54 in.	1.00-2.50	Used for dress goods principally. Made of cotton or cotton and wool as well as all wool. Corded, raised surface with recesses between running with warp.
Blankets	7.00-30.00 all wool	.75-2.00	Napped surface, combed wool. Vary in price. Good all wool blanket from \$7 up.
Brilliantine	54 in.	2.00-4.00	Used for dress goods and dust coats. Sheds dust easily. Wiry, silky looking fabric resembling alpaca. Made from Angora goat hair.
Broadcloth	24 in.	.35	Used for dress goods. Smooth, soft finished closely woven fabric. Fulled after woven, then pressed. Old standard material. Very good broadcloth costs about \$5 a yard. Made from woollen yarn.
Bunting	1.00 up		Used for making flags. Plain weave of worsted or mohair.
Carpets			Made principally of wool. Woven and cut in pile similar to velvets.

SHELTER AND CLOTHING

NAME	USUAL WIDTH	USUAL PRICE	DESCRIPTION
Cashmere	36-45 in.	\$0.75-1.25	Used principally for dress goods, wrappers, baby wear. A twilled weave, soft. Made in fine qualities from hair of cashmere goat.
Challie	30 in.	.50-.75	Used for dress goods. Made first of silk and wool. Now made of cotton and wool or either one. Light-weight fabric. Printed or pattern woven in.
Cheviot	42-48 in.	.75-3.00	Used principally for suitings. Plain or twilled weave. Stout woolen cloth made from combed or carded yarn, with rough surface or smooth finish. Somewhat like serge but heavier.
Covert	54 in.	1.00-5.00	Used for overcoats, suits, riding breeches. Heavy twilled cloth, felted, of woolen yarn.
Crépon	27-36 in.	.50-1.50	Used for dress goods. A fabric with rough, crinkly surface, caused by method of weaving.
Diagonal	48 in.	1.00 up	Name given to chevviots when of a diagonal or zigzag weave.
Eiderdown	27-44 in.	.80-1.25	A soft napped fabric of considerable pile. Heavier than pile of blankets. Used for wrappers.
Etamine	42 in.	1.25-3.00	Used for dress fabrics. A soft material of open weave or mesh.
Flannel	27-36 in.	.50-1.00	Used for many purposes — dress goods, baby wear, petticoats, dressing sacques,

Felt	24-50 in.	.80-1.50	waists, shirts. A light-weight, loosely woven fabric. Finished with soft surface slightly napped. Used for table covers, pennants, etc. A fabric made without being woven by compressing or felting the wool fibers together into a flat mass.
Gloria	36 in.	.50	Material of plain weave. Made of wool in combination with silk or cotton. Used for umbrellas. Strong, wears well.
Grenadine	54 in.	1.00-8.00	A material used principally for dress goods, of plain or figured weave, light, open-work like net; made of silk, cotton, or wool.
Henrietta	38-45 in.	1.00-1.50	A soft dress fabric similar to cashmere. Originally made with warp of silk. Twilled weave.
Homespun	42-50 in.	1.00-3.00	Used for dress goods or men's suiting. Originally made at home. A loose, rough material of coarse yarn. Made now by machinery to imitate.
Ladies' Cloth	32-54 in.	2.00-4.00	A smooth, satin finished fabric of light weight. Similar to broadcloth in appearance. Used for ladies' dress goods.
Melton	52 in.	2.00-4.00	Used for overcoats, suits, and heavy garments. Usually dark blue or black. Thick, heavy fabric much felted. A standard material. Woolen yarn.
Mohair	40-54 in.	.50-2.00	Dress goods. Has hard, wiry feel, made from hair of Angora goat, sheds dust, wears well. Combined often with silk or cotton.

COMMON WOOLEN AND WORSTED MATERIALS — Continued

NAME	USUAL WIDTH	USUAL PRICE	DESCRIPTION
Nun's veiling	36 in.	\$ 0.75-1.50	A soft, light-weight fabric. Open mesh weave. Used for dress goods. A standard material, made in solid colors.
Panama	42-54 in.	.75-2.00	A soft dress fabric of plain weave. Sold in plain colors. Somewhat similar to albatross. Serviceable.
Serge	42-54 in.	.75-3.00	Dress fabrics of twilled weave. Made in plain colors and several varieties according to finish; storm, mohair, silk serge, etc. Made of worsted yarns, hard and wiry. Serviceable standard material.
Sicilian	42-54 in.	.50-3.00	Similar to mohair. A dress fabric of cotton warp and mohair filling. Wiry, dust-shedding.
Tweed	52-54 in.	2.00-4.00	Coarse cloth made originally by hand in Tweed, Scotland. Of rough, unfinished, open texture. Usually several shades mixed. Very serviceable for suitings. Pattern not clearly defined.
Venetian	54 in.	1.00-2.50	Similar to broadcloth, but has a fine diagonal twilled face.
Voile	42-45 in.	1.25-2.00	A thin, gauzy woolen material like veiling, showing spaces between the warp and woof threads.

Wool industry of the United States. — Since the early manufacture of wool as a household industry, where all processes were done by hand at home, there have been rapid strides until in 1911 the wool product of the United States was estimated at 318,547,900 pounds. From the home as a center of manufacture we have the development of the factory, with 200,000 people engaged in woolen and worsted manufacture. The importations of wool in the United States vary; in 1910, 264 million pounds of foreign wools were brought in, and in 1911, 138 million. About two thirds of the clothing wool used by American manufacturers is raised here. Massachusetts has been the center of woolen manufacture in the United States. The first factory was located at Newbury, Massachusetts, in 1790. After the Civil War there were higher duties on wool fabrics, and the number of factories increased rapidly. The consumption per capita of wool averaged three pounds before the factory era; now it is six. The price of wool varies with the market from \$.15 to \$.30 per pound.

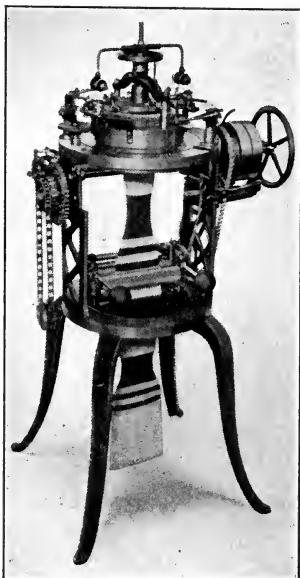

Courtesy of H. Brinton Company.

FIG. 76. — Knitting machine.
Underwear and stockings are made on similar machines.

EXERCISES

1. Describe the microscopical appearance of wool and give characteristics of this fiber.
2. What is meant by wool mixing? How does this enable the manufacturer to grade the price of wool?
3. Why is wool for underwear carded a great deal?
4. What is meant by a "pure textile law"?
5. How are woolen fabrics adulterated? Is adulteration ever legitimate?
6. Collect and mount samples of the common wool materials — with width, price, and use. Also some mixtures of cotton and wool.
7. How important is the wool industry in the United States?
8. Test some wool materials for shrinkage and adulteration.
9. For what other purposes is wool yarn used besides cloth?
10. Describe the process of wool carding.

CHAPTER XI

SILK

SILK is the most costly as well as the strongest and most beautiful of all the common fibers. This wonderful animal fiber of great length is a monument to the industry of the tiny insects which produce it. It is the covering in the form of a cocoon within which the transformation of the insect takes place (see Fig. 77). It is often produced at lengths of from one to four thousand feet. It is the secretion, formed by the worms at a certain time in their life history, which emerges from two tiny orifices at the sides of the head. These tiny filaments form into one as the gelatinous secretion hardens in contact with the air and forms a fine elastic fiber as the worm throws its head back and forth in spinning. In Latin the word is *serricum*, in Chinese the ancient name was *seres*.

Where grown. — Silkworms are raised principally in countries where labor is not expensive. They require much care and attention during their life growth. Japan, China, Italy, and Asia Minor produce most of the raw silk of commerce, Silk culture in the United States has failed on account of the cost of labor.

Varieties of silk. — There are many varieties of caterpillars secreting silk, but the one of greatest value commercially is the *Bombyx mori*, or mulberry silk moth of China, and closely allied varieties. They belong to the order Lepidoptera and the family of the Bombycidae. There are also certain wild moths that are utilized in the silk industry. The most

important of those producing wild silk are natives of India and China. The silk is inferior, and is known as "Tussah" silk. It has a use, however, in the manufacture of velvets and plushes. The wild moth is very valuable, however, because its silk is used for much of the pongee which is made.

A microscopical examination of the silk of the *Bombyx mori* shows a somewhat flattened combination of two tiny filaments. It is of a horny, gelatinous nature.

Silk culture originated in China about 3400 B.C. It is said that in 2460 B.C. the wife of Emperor Huangti, Si Ling Chi, devoted her time to the raising of silkworms and to reeling or unwinding of silk from the cocoons. This secret was guarded for a long time. Japanese history shows that knowledge of the industry reached there through Korea. A knowledge of silk culture traveled westward to India and Europe. In 910 the Moors imported silk culture into Spain, and by the twelfth century it was known in Greece and Italy. In the fourteenth century it was common in France. Since then silk culture has grown rapidly in importance.

Silk culture (see Fig. 77).—The silk moth *Bombyx mori* lays her eggs, which are as tiny as a mustard seed. These eggs are collected and kept cool until hatching time, when they are exposed to heat. The tiny worms hatched from these eggs grow rapidly, as they are fed on chopped mulberry leaves, and in about a month they reach their full size of about three inches in length (see Fig. 78). During that period they require constant care in order that lack of food and cleanliness may not breed disease. When grown, the caterpillar begins to spin the cocoon, which is composed of many feet of silk fiber in a parchment-like mass, closely held together with the gelatinous fluid (see Fig. 79). This cannot be removed without soaking. Cocoons are uniform in shape, about one inch and a half in length, and white or

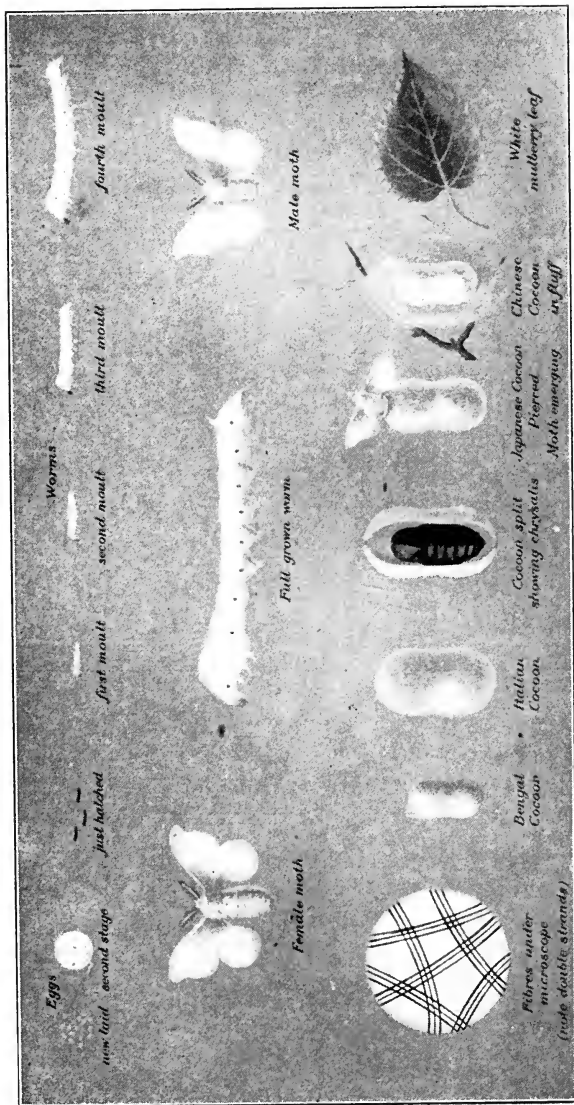

Courtesy of Cheney Brothers.

FIG. 77. — The silkworm in all stages.

yellow in color. The outside is covered with loose, flossy filaments. About three weeks after the completion of the cocoon, the caterpillar, which has been transformed during that time into a moth, is ready to escape. If he escapes, the mating with other moths takes place, and the life history is

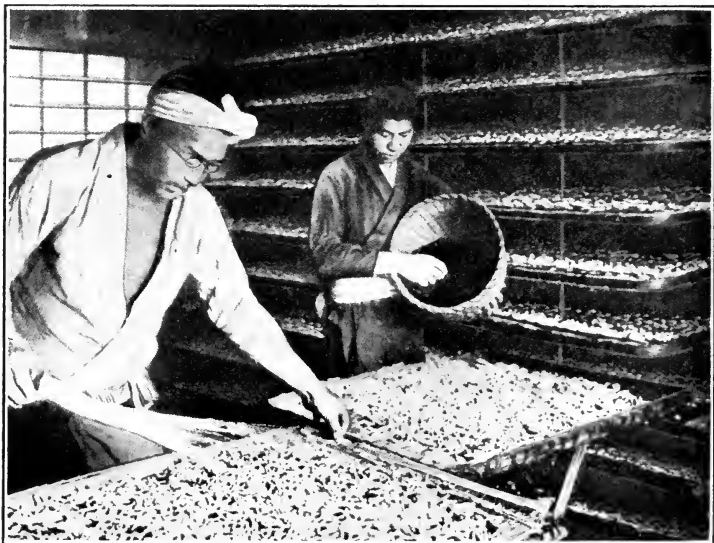

Courtesy of Cheney Brothers.

FIG. 78. — Feeding worms chopped mulberry leaves and clearing litter.

repeated. If, instead, the cocoon is subjected to great heat, the worm moth inside dies, and the cocoons are ready commercially to be reeled. When the moth is permitted to escape, he works his way out of his prison by moistening one end and slowly emerging, thus spoiling the cocoon for reeling purposes. The gum of the cocoon must be separated from the filaments so that it will reel easily. The cocoons are placed in hot water, which softens the gum. The ends

are then caught from four or five, and wound through a guide upon a reel. About five of these double filaments make up the thickness of a strand of raw silk. This reeled silk is made up into hanks and sold as raw silk by the pound and varies in price from \$7 to \$10 (see Figs. 80 and

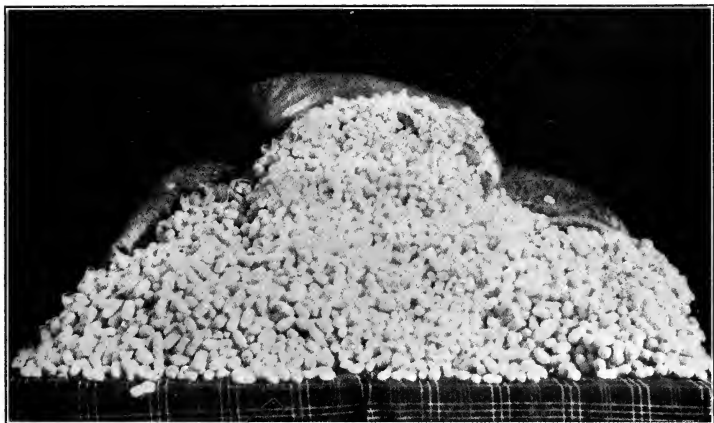

Courtesy of U. S. Dept. of Agriculture.

FIG. 79. — Cocoons.

81). Three thousand silkworms are required to spin one pound of raw silk. From one to two pounds are necessary to make a dress.

Silk yarn manufacture. — The silk industry in the United States is engaged principally in relation to the manufacture of silk. The hanks of raw silk are imported in bales weighing from 100 to 160 pounds. Hanks weigh several ounces each, and they are packed in bundles of five or ten pounds. The hanks go first to the throwster. Silk throwing consists of soaking the skeins to remove some gum in order to wind the silk from the skeins. The skeins of raw silk are placed on

reels and unwound on spools. A skein is made up of from 75 to 200,000 yards of silk. The spools are then placed in the machine, which winds (see Fig. 82) two or more together and puts in a twist, so that they form one yarn. This is called "organzine" and is used for warp on the loom. The

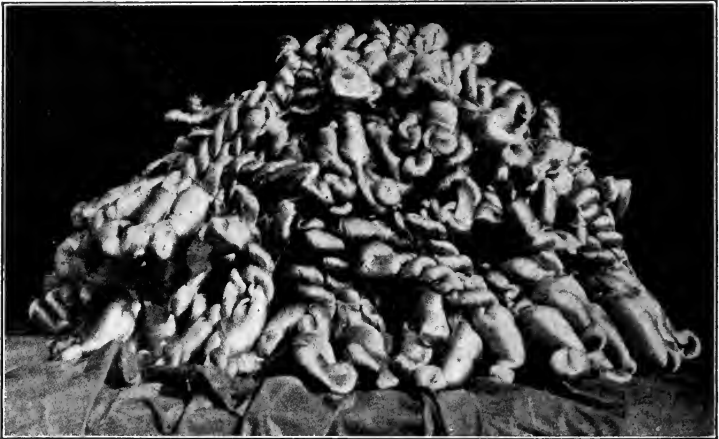

Courtesy of U. S. Dept. of Agriculture.

FIG. 80. — Some hanks of reeled silk.

wool yarn is called "tram." It is usually not as good a quality of silk, and is only loosely twisted. "Singles" is sometimes used for warp and woof in goods dyed in the piece or after weaving. "Singles" is the thread of raw silk wound on spools without much or any twisting. Silk requires very little preparation, in comparison with wool and cotton, as it is fine and continuous, although finer and smaller in diameter towards the center of the cocoon. It is the most perfect fiber.

Silk thread manufacture. — Silk is received in hanks by the manufacturer of sewing silk. The hanks are soaked in

warm water, dried, and reeled from the swift to bobbins. Two or more are doubled as for organzine or tram; then doubled again and twisted in the opposite direction and



Courtesy of U. S. Dept. of Agriculture.

FIG. 81. — Reeled and waste silk.

stretched. Embroidery silks and twists are made in a similar way, more or less twisting and stretching being done according to the kind of sewing thread desired. Dyeing and spooling follow (see Fig. 83).

Silk cloth manufacture (see Fig. 84).—Silk yarn is sometimes woven into cloth before it is dyed, but more often it is dyed in the yarn. The preparation of the organzine for the warpbeam is similar to that described under flax warping. The threads on spools are placed on the reel and the warp



Courtesy of Cheney Brothers.

FIG. 82.—Winding room. Silk on swifts.

prepared on the warping frames and transferred to the warp beams ready for the back of the loom. The Jacquard harness is used a great deal in the manufacture of silks, and all kinds of beautiful patterns in satins, silk, brocades, ribbons, and velvets can be produced by this wonderful invention (see Fig. 85). The shuttle contains the bobbin filled with the tram or woof. The shuttle is lined with sealskin to protect the filament. Silk cloth is made not only of reeled silk, but

of the silk waste called spun silk. This waste consists of the broken threads of manufacture, the cocoons which have been pierced by the moth emerging and so are not continuous thread, the outside fibers of the unpierced cocoons, and the innermost part next to the chrysalis. This waste is

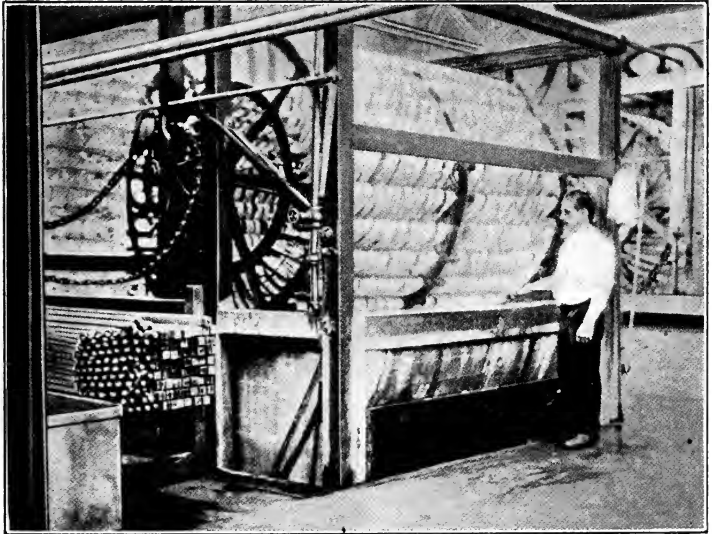

Courtesy of Cheney Brothers.

FIG. 83. — Dyeing. Skein dyeing by machinery.

boiled to remove gum, is then carded and passed through doubling and drawing frames as in cotton spinning, and the silk rovings are spun. It is then reeled into skeins for weaving yarns or other purposes. Silk ribbons are woven on wide looms, but with a number of pieces or widths in one loom with a small shuttle for each width.

Silk dyeing and finishing. — Silk is dyed in the yarn or in the piece. Thrown silk is sent to the dyer, who boils out the

gum, which is about 25 per cent of the weight of the silk. Some manufacturers, in order to make as much profit as possible, load the thrown silk before it is dyed. This is done by dipping the silk yarn in bichloride of tin or other substances which the yarn absorbs until often it weighs from twice to four times as much as the boiled-off silk. When exposed

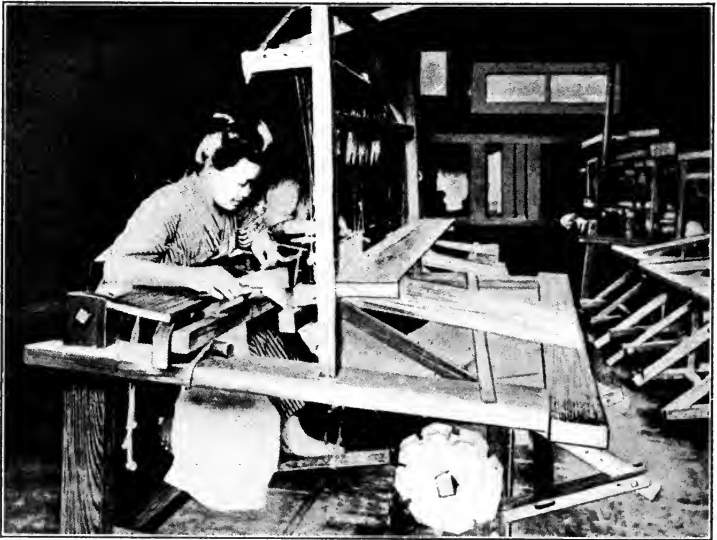

Courtesy of Cheney Brothers.

FIG. 84. — Weaving. Primitive hand loom.

to action of air and light these chemicals rot the silk fiber and the filament crumbles away. In order to overcome the loss after the degumming of the silk, all kinds of processes have been used. Weighting is added not only in the throwing, but often also in the dyeing. The filling generally carries more weighting than the warp, which must be strong for the warping. For dyeing, the coal tar products ("aniline dyes") are

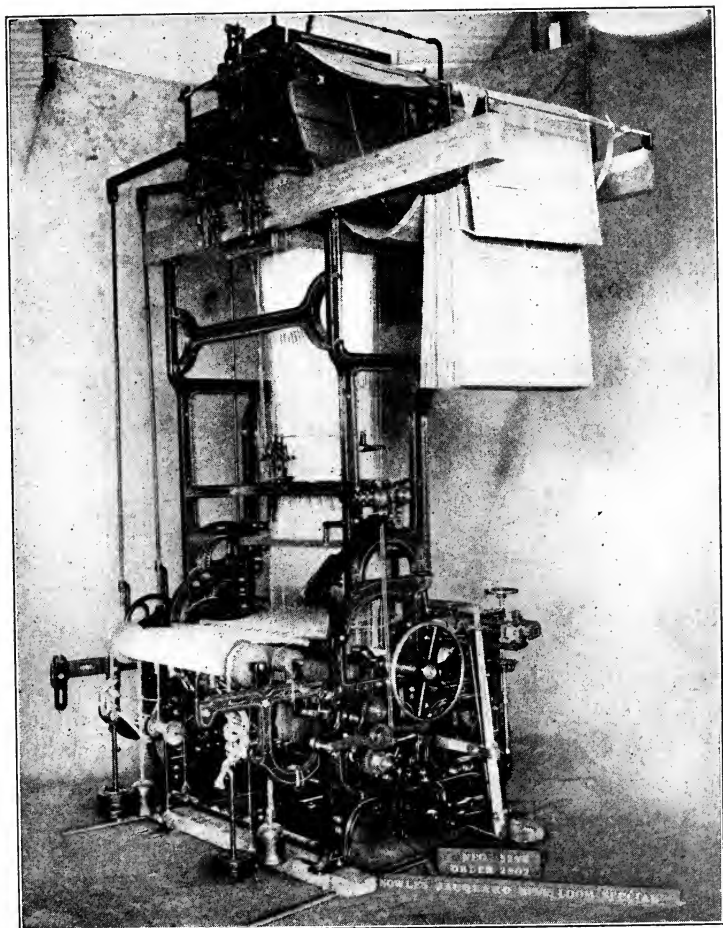

Courtesy of Crompton & Knowles.

FIG. 85. — Beautiful figured silks and ribbons are woven on the Jacquard loom.

used principally. Black silks are weighted more than light colored. Salts of tin and iron are used for weighting, and for the best black silks logwood is the dye. Only inferior silks are dyed in the piece. If silk has been woven with the gum in it, this must be removed before the fabric is dyed or printed.

Pattern or figure may be produced by weaving, printing, stenciling, or embroidering. In weaving, the Jacquard harness produces wonderful patterns. Printing, to-day, is done by means of cylinders on which the design is engraved. Other cylinders supply color to the design, and the necessary pattern in color is transferred to the cloth. This is then steamed to fix the colors, and finished. Sometimes the warp threads are stamped with a figure and then woven with a plain woof. The result is an indistinct pattern. Many so-called Dresden ribbons are woven in this way. Printing is also done in a more primitive way in Japan and China. Stencils and wood blocks are used. The effects are often very beautiful, but the process is slow. William Morris produced some beautiful designs and effects by block printing on cotton cloth. There are other finishing processes. Sometimes the surface is simply smoothed, or pressed. Again it is moiréed or watered by means of rollers engraved so that the moiréed effect is left on the silk. It is sometimes singed and gassed in the piece or sized with starch or glue to make it stiff. There are also machines for calendering or ironing it, stretching machines, embossing, and various finishing machines for special purposes. Sometimes a piece of silk will be treated as many as fifty or more ways after it is woven.

COMMON SILK MATERIALS

SILK

183

NAME	USUAL WIDTH	USUAL PRICE	DESCRIPTION
Bengaline	18-22 in.	\$0.75	Used for dress goods and trimmings. Effect of rounded silk cord like poplin. Made in all silk or with wool cord of wool covered with silk warp.
Brocaded Satin	24 in.	1.00 up	Beautiful fabrics of jacquard design. Slightly raised from surface. Dress goods, trimmings, and furniture coverings.
Chiffon	46 in.	.75-2.00	Used for dress goods, veils, millinery, and trimmings. A thin, gauzy, light fabric of plain colors generally. Finished soft or with dressing.
China Silk	24 in.	1.00	Name used for plain hand-woven silks of plain weave in China. Distinguished by irregular threads and softness. Used for waists, dress, underwear. Very durable.
Crépe de Chine	22 in.	.75 up	Used for dress goods. Plain color or printed. Smoother surface than most crépes. Soft and lustrous. Plain weave. Effect produced by right and left twisting of warp threads.
Foulard	24 in.	.75 up	Dress goods of printed or woven design. Name is French for handkerchief, for which originally used.
Habutai	27 in.	.60-2.00	Woven in gum. Boiled and finished after weaving.

COMMON SILK MATERIALS — Continued

NAME	USUAL WIDTH	USUAL PRICE	DESCRIPTION
Moiré	22 in.	\$2.00	A watered effect produced by pressing between stamped rollers on grosgrain silk. Used for dresses and trimmings.
Louisine	20 in.	.85-1.50	A plain, durable silk. Soft, glossy texture, slightly twilled in effect. Used for dress goods and trimmings.
Maline	27 in.	.25-.50	A soft, thin, gauzy fabric. Similar to net.
Mousseline de Soie	45 in.	.50 up	A thin, gauzy fabric with more starch in finish than soft chiffon. Used for trimmings and dress goods.
Peau de Soie	21 in.	.75-1.50	A plain, colored reversible silk in good quality. A heavy, soft-finished silk. Used for dress goods and trimmings.
Pongee	27 in.	1.00 up	A soft, unbleached, washable silk, ecru in color. Woven from silk of wild silkworm. Originated in China. Hand woven. Used for dress goods, coats, etc.
Plush	24 in.	3.00	A long, shaggy fabric of velvet class. Woven and pile cut. Used for dress trimmings, furniture covering, draperies, etc.
Rajah	36-54 in.	.60-2.00	A rough silk, plain weave of irregular threads. Not very durable. Used for dresses and coats.
Satin	21-54 in.	1.00-10.00	A very old weave with much of woof on surface to give smooth finish. Made in all grades and combined with linen and cot-

ton. Used for many purposes, box making, fans. Better qualities for fine gowns. Used for lining.
 A thin glossy, silk of plain texture. Same on both sides. Plain colors. Made also with printed and woven figures. Used for gowns, petticoats, linings. Does not wear well unless good quality and small per cent of weighting.
 A kind of silk net of open mesh. Used for neck wear, veiling, etc.
 Used for handsome gowns and trimmings. Woven and cut to form pile. Made also of cotton or linen in combination.

Skinner's Satin
 Taffeta

36 in.
 21 in. up

1.25 *
 .60-2.00

Tulle
 Velvet

3 yd. wide
 18-42 in.

1.75-2.25
 4.00-20.00

Other uses of silk. — Silk yarn is manufactured into cloth, ribbons, sewing silks, embroidery flosses, and twists. In addition it is used for many purposes. The secretion of the caterpillars is sometimes removed before they are permitted to spin their cocoons, and this is used for snells in fishing lines. The silk glands are taken from the dead worms and stretched to form tough, sinew-like cords. This costs from 25 to 30 dollars a pound. The electrician uses a great deal of silk for insulating wires and for other purposes, the surgeon for various uses, such as the tying of arteries, and the dentist, bookbinder, and others have many uses for the products of this tiny worm. Much yarn is consumed in the manufacture of velvets, plushes, hosiery, gloves, knitting, and other silks.

Other silk fibers. — Artificial silk has been manufactured in order that a substitute for silk may be used to reduce cost. There are several silk substitutes, some natural and others manufactured. Wool or cotton is treated by different methods to produce filaments which can be spun like real silk. Artificial silk has much luster, but lacks the elasticity of real silk. Spiders in Madagascar produce a valuable fiber, and Pinna silk, obtained from the shellfish of Sicily, is used there in the manufacture of shawls, gloves, and hosiery. There are also some seed coverings that have very fine hairlike fibers. The kapok plant furnishes most of this silk cotton.

The silk industry in the United States. — America leads in the manufacture of silks and in the consumption of raw products; France follows. The imports of raw silk in 1910 were 22,000,000 pounds. The larger part of the silk fabrics and thread used here, about 85 per cent, are manufactured in this country. Since 1850 the manufacture has increased rapidly. The silk exhibit of the Centennial Exhibition of

1876 attracted world-wide interest. The states engaged principally in silk manufacture are New Jersey, New York, Pennsylvania, and Connecticut. The development of this manufacture, owing to demand at home and high protective tariff, has been enormous.

Very little silk has ever been grown in America. As early as 1624 in Virginia certain skilled Frenchmen tried to start the raising of silkworms. Since then many experiments have been tried and have failed, principally because of the cost of labor. In 1747 the governor of Connecticut appeared in stockings and coat, the silk for which was produced on his own place.

EXERCISES

1. Describe the work of the silkworm in producing the fiber. What is the composition of silk fiber?
2. Name the principal countries producing silk and describe its culture.
3. Describe the process of silk throwing.
4. What are some of the possibilities for adulteration during the process of silk dyeing?
5. Name ten of the most common silk materials and give prices and widths. Bring samples to class.

CHAPTER XII

COMPARISON OF WOOL, COTTON, SILK, AND FLAX

A STUDY of the characteristics, appearance, and possible adulteration of the principal fibers is necessary in order that wise selection of fabrics may be made. Women so often demand quantity where it would often be wiser to think of quality. The manufacturer consequently caters to the consumer, and finishes his fabrics so as to imitate the more luxurious materials. These processes through which the fabrics pass are very disastrous in their effect on the fibers, and while they produce low-price goods it is often more than useless to purchase them.

Microscopical and chemical differences. — Wool when examined under the microscope is characterized by its highly serrated surface, which easily distinguishes it from other fibers. In some fine wools there are as many as 2800 serrations to the inch. Microscopical examination makes it possible to distinguish between wools of high grade and the remade wools, such as shoddy or mungo. The latter often accept the dyes irregularly when redyed — and the serrations are more uneven because of the treatment in the preparation of shoddy. An examination without a microscope shows the wool fiber to be a kinky, wiry fiber which stands out and curls. The wool fiber is, however, covered with a grease, the yolk or wool fat slightly permeates the fiber and makes it soft to handle. This is a natural protection rather than a part of the fiber substance. Tepid water removes the yolk, which is composed principally of potash salts. The fiber itself is a

nitrogenous substance belonging to the general group of proteins (see Fig. 86).

Cotton when seen microscopically differs materially from wool. Instead of the serrated kinky fiber one sees ribbon-like tubular fibers with more or less twist. The number of twists varies. Some good cotton fibers have very few. Unripe and half-ripe fibers appear without twist, and these are the ones which

in dyed fabrics are very perceptible because they do not take the dye well. The twist aids in the spinning. As many as 300 twists have been

counted on a single filament. To the naked eye cotton fibers appear fluffy and dull white. When woven, the threads are regular and uniform. Chemically the cotton fiber differs from wool in being almost pure cellulose, $(C_6H_{10}O_5)_n$, in its fully ripe condition. When subjected to mercerization, the caustic soda

affects the twisted wall, making it a smooth-walled cylinder (see Fig. 87).



FIG. 86. — Wool fibers magnified.



FIG. 87. — Cotton fibers magnified.

Silk fibers from the cocoon examined microscopically appear

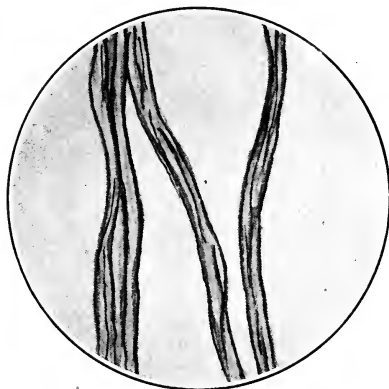

FIG. 88. — Silk fibers magnified.

without any characteristic markings. They have the appearance of a somewhat flattened combination of two filaments of noticeable length and continuity. If mercerized cotton is used with silk, the microscope reveals it by an occasional twist in the cotton. Without the glass, silk appears fine, long, uniform, and glistening. The fibers fly

and cling to the fingers. Chemically, silk fiber is composed of a center or core of fibroin, with a covering of silk albumen or sericin and a little waxy coloring matter. Fibroin is like horn or hair, except for the sulphur, the composition being carbon, hydrogen, nitrogen, and oxygen (see Fig. 88).

Flax or linen fiber, when spun, appears to the naked eye as glistening with occasional irregularities in the yarn. Microscopically the fibers are very like silk, rodlike in appearance, but with occasional

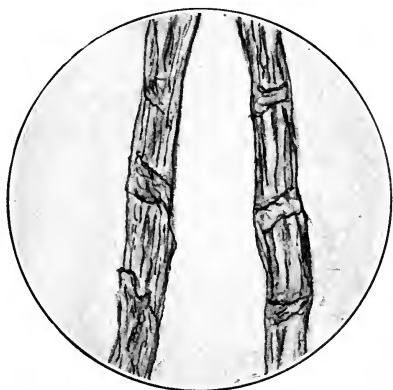

FIG. 89. — Flax fibers magnified.

node markings. It also appears more woody and rough. A chemical analysis of the flax

fiber shows it to be principally cellulose, $(C_5H_{10}O_5)_n$, associated with certain intercellular matter and pectin bodies (see Fig. 89).

Varying characteristics and properties. — Wool is perhaps the most important of all the fibers, because of the extent to which we depend upon it for warmth. It is a poor conductor of heat, and the spaces between the warp and woof of the cloth, which are filled with air, do not conduct the body heat rapidly. Wool feels warm because loosely woven, and because of this non-conducting property. The hygroscopic capacity of wool is from 12 to 17 per cent, and it often holds as much as 50 per cent moisture in damp air. It absorbs slowly and evaporates in the same way. A garment of wool when dry, next to the skin, feels warm, when wet, the moisture is not felt unless there is a great deal of it. Wool feels soft, springy, and elastic to the touch. Wool is used a great deal for underwear. It is excellent for young children, delicate or old people, as the body heat is not conducted rapidly and the slow evaporation of the moisture prevents rapid cooling of the body. There are, however, drawbacks in the use of wool for underwear which are discussed in the chapter on hygiene of clothing. It is not easily cleansed because of its felting properties. Cotton and linen are cooler because they conduct the body heat more rapidly. When loosely woven, the still air between spaces acts as a non-conductor. Good wool is expensive, and the best combed wool is used for underwear. Cotton as a vegetable fiber is by contrast hard and lifeless, not so yielding or elastic as wool. It absorbs moisture rather slowly. It feels warm to the touch when dry, and even when moist does not feel so cool as does linen. It has not as great tensile strength as other fibers.

Cotton burns very rapidly with light yellow flashes, with almost an explosion, and with an odor like burning wood.

The residue is almost imperceptible, a fine, ashy powder. Wool chars and burns slowly with a flickering flame which goes out easily and leaves an odor of hair, and a residue. Consequently it is the best fabric to use as an extinguisher. Wool is the third in tensile strength and is a good generator of electricity although the poorest conductor of electricity. When cotton and wool mixtures are burned, the line of cotton may be followed easily as it burns, leaving the wool. Cotton washes more easily than wool and does not absorb the impurities of the body when worn next to the skin, but it resists dust less than wool. A woolen dress will remain clean longer than a cotton one. Cotton is very absorbent when the outer waxy coating has been removed, and is of great value for surgical uses. Outing flannel, which is cotton, is rather dangerous for garments, because so easily inflammable. This is because of the surface treatment of the fiber, which makes it like guncotton. A modern process for the treatment of outing flannel has overcome this objection.

Silk fiber has the greatest tensile strength and is the most elastic fiber. It is said that it is as strong as an iron wire of the same size. It feels soft and smooth. Silk absorbs moisture rapidly and throws it off readily. It is very durable when not adulterated and is warm and light. It is a good non-conductor of electricity, and is therefore used for insulating purposes. It has a great avidity for moisture and will absorb 30 per cent of its weight without the fact being perceptible. Silk buyers require that silk shall be tested for moisture. In large manufacturing centers, special houses, called silk conditioning houses, do the work. The aim is to determine the amount of moisture the buyer is purchasing. The apparatus for drying is called a desiccator. Because of this avidity for moisture, silk accepts dye and weighting readily. When silk burns there is a strong odor of hair,

but it is not as disagreeable as wool. It burns with a flickering bluish flame and leaves a crisp ash. Silk feels cool to wear when dry, and when wet it is very cold in contact with the skin. Good silk has the striking physical property of high luster. This is noticeable after the silk gum has been removed by scouring. Extreme weighting of silk destroys this beauty. Silk also has the property termed "scoop." This is the rustle of silken fabrics that one sometimes hears or the crackling sound when it is squeezed or pressed.

Linen is often called the fiber of the aristocracy; it is costly because of the labor involved in its manufacture. It is a very strong fiber and when carefully handled in manufacture will last years, as is evidenced by the remains of our great grandmothers' household linens. It absorbs moisture very readily, so we know that linen dish towels are better than cotton, and it also dries very rapidly. Linen, because of its vegetable composition, when burned smells like wood and leaves a slight ashy residue. It burns almost as quickly as cotton, and with a bright, flashy flame. Linen feels silky, stiff, slippery, and rigid, and is cool and heavy in weight. It is more unyielding and less elastic than any of the other leading fibers. Linen is a better conductor of heat than cotton. It is the coolest fabric to wear when dry, and when wet, in contact with the skin, is remarkably cool. During the bleaching process linen may lose 20 per cent of its weight. Linen is the most cleanly fiber, because it is longer and does not fuzz up as cotton in the spinning. For this reason the woven surface is smooth and stays clean longer. It does not retain the dye as easily as cotton, due to its structure. Flax fiber is stronger than cotton, unless over-retted, when it is brittle and weak. The hygroscopic power of linen is about the same as in cotton.

METHODS OF ADULTERATION OF OUR COMMON MATERIALS AND WAYS OF TESTING THEM

The indifference of the buying public has made it possible for manufacturers to adulterate the necessary materials of everyday use and so increase the cost of everyday living. Our food and drug materials are now labeled and legislative measures control this labeling. There is corresponding need to-day of a pure textile law that will make necessary the branding of goods in such a way that fabrics will not be sold as all linen when they are half cotton, or as all silk when half weighting. Substitution of cheaper for more expensive fibers will probably go on and a certain kind is legitimate if the goods are so labeled that the purchaser knows what he is buying. There are many simple tests by which it is possible to estimate the composition of materials, and these should be known to every girl, in order that she may protect herself until legislative measures bring some force to bear upon the proper labeling of fabrics. Many interesting and surprising experiments can be made in the chemical laboratory that will make one more thoughtful in the purchasing of materials. There are many ways in which fabrics are adulterated. It is necessary to know something about the possibilities before applying tests for identifications. Some of the methods of adulteration have been indicated in the study of processes of manufacture.

Adulterations by weighting. — This means the substitution of something for the actual material. In cotton and linen fabrics, one method of weighting is the adding of much sizing. This can be removed, but the material after washing will be found to be a much more open mesh or weave. Many kinds of gums, glues, clays, and starches are used for this filling. Light silk is weighted with sugar and the

darker ones with metallic salts and dyes. This is because of the great hygroscopic property of silk, which enables it to absorb a great deal of moisture without apparently changing its quality. Dye and salts are cheaper than pure silk, so loading is practiced. Silk loses 30 per cent of its weight in the gum, and this is often replaced together with as much as 200 per cent of other matter. We rarely find to-day the pure silk fabric that our grandmothers used, a fabric which was expensive but which lasted even when stored away for years. This is because the public demands cheap silk and the manufacturer cannot produce it without adulteration when the cost of the raw fiber is so high.

Adulteration by combination with other fibers. — This is a common practice, and one often buys “all wool” which is half cotton, or “pure linen” which is a union of cotton and linen, or “pure silk” adulterated with artificial silk or mercerized cotton.

Adulterations due to use of waste or made over material. — In studying the process of wool manufacture we learned that there is not enough wool produced to keep everybody supplied, and a garment of all new wool would be very expensive. The practice of using shoddy, mungo, or extracts is legitimate, but one should not pay the price of a new wool or half new wool fabric when the composition is largely shoddy. There should be some legislation which would make labeling a requirement so that the purchaser may know what per cent of new wool she is really buying. Silks are sometimes sold as reeled silks when the spun silk from the waste cocoons has been used as filling or woof.

Adulterations due to methods of finishing. — In our study of cotton and linen manufacture we learned the uses of calendering. This pressing is sometimes used deceptively to give luster to the surface. Ordinary cotton is made to

appear silky or mercerized. Linen is beetled in finishing to make the fibers stand out. Cotton so treated is a good imitation of linen.

Tests for sizing.—Such adulteration is quite apparent and with a little practice easy of identification. It renders the material smooth but rather harsh. It conceals defects in the cloth which can, however, be detected by touch or, if the material is thin, can be seen by holding it against the light. Sizing may be removed by boiling in a covered kettle. The required time will depend on the quantity of dressing. Sometimes the material is boiled in 5 per cent solution of oxalic acid to change the starch to dextrin or sugar to dissolve it. Cotton that has been treated with olive oil appears very opaque and linen translucent, but if much sizing is present this test for linen and cotton is not as successful. Crush the material and rub together. Pick at the surface with your finger nail and the starch or sizing will easily come off. Wet and hang in the air. Notice the effect on the gloss after wetting.

Chemical tests for identification of fibers.—Acids and alkalies affect vegetable and animal fibers in different ways, so by testing woven materials chemically it is possible to discover their composition. A fringed sample serves better than a closely cut piece.

1. Place pieces of white cotton and woolen materials in dishes. Cover with a 50 per cent solution of nitric acid. The wool fibers turn yellow in color. If ammonia is added, the yellow wool will turn to orange color.

2. Place two pieces of wool and two of cotton fabrics in separate beakers. Cover one of each with sulphuric acid and the other two with 10 per cent caustic soda. Allow them to remain fifteen minutes, pour off liquid, wash carefully, and examine. The sulphuric acid dissolves the cotton and the wool becomes jellylike, while in the alkali or caustic soda the wool is dissolved and the cotton remains unchanged.

3. Boil cotton and wool samples in a 5 per cent solution of caustic potash, also samples of cotton and silk, for fifteen minutes. The animal fibers of wool and silk will be dissolved and the cotton will remain the same.

4. Moisten samples of wool and cotton with Millon's reagent. Place in porcelain dishes and heat gently. The animal fibers become red, while the vegetable fibers remain unchanged.

These tests also show that in laundering of fabrics one should know the composition of soaps and washing powders and the effects they will have on materials.

5. Cotton and linen are woven together and sold as union material. Place a fringed sample of this union material in a porcelain dish. Heat gently in a 50 per cent solution of caustic potash for two minutes. Remove with glass rod and dry between filter papers. The linen will be dark yellow in color and the cotton white or light yellow.

6. Treat union material in the same way for two minutes with concentrated sulphuric acid. Remove with glass rod. The linen fibers remain and the cotton dissolves. Linen is not as susceptible to acid as cotton.

This is not a good test for very delicate materials, but rather for heavy weaves as toweling and damask.

7. Treat silk with 40 per cent solution of hydrochloric acid for two minutes. The silk is dissolved. Also with 30 per cent solution of hydrochloric acid for about ten minutes. It will be found that very dilute acids will be absorbed by silk with the effect of adding luster. This will weaken the fibers. Common salt weakens silk, especially when it is weighted. A silk dress made of adulterated material is apt to show holes if spotted with salt water. The cracking and discoloring of silk in presence of salt is due to the effect of the salt on the weighting.

9. Artificial silk when boiled in 4 per cent solution of caustic potash will turn the solution yellow, while pure silk leaves a colorless solution. Millon's reagent will turn silk red, while artificial silk remains unchanged.

Other tests for fiber. — An examination of the raveled warp and woof of materials will often reveal a great deal. Cotton fibers are short and the ends appear fuzzy. Wool is kinky and stiff. Silk fibers are long, straight, and lustrous if reeled silk; if spun, the fibers are short and break easily. Linen is strong and long and ends uneven when broken, but more pointed than cotton. Unwrap the warp or woof

threads of wool and see if the core is of cotton. Wool feels springy and soft.

Microscopical tests. — The use of the microscope or magnifying glass will reveal many things. The fibers of materials when unraveled and examined are easily identified. Shoddy can sometimes be discovered in this way because of color of the threads. Old woolen rags of one color may be made up of various colored wools. If the yarn is found to contain individual fibers of many colors, it is generally due to presence of shoddy. The magnifying glass will also reveal whether "pure silk" so called is silk or simply mercerized cotton fiber. The microscopic is the only sure test for distinguishing cotton and linen fibers.

Burning tests. — 1. Unravel the fibers of both warp and woof. Burn with taper. The animal threads burn slowly, char, and give off odor of burned feathers. Silk leaves more ash when weighted. The vegetable fibers burn quickly with a flame.

2. Heat cotton and wool samples separately in dry test tubes. Notice the condensation on side of tube. The fumes from wool when tested with moist red litmus paper will turn it blue, showing presence of ammonia. Filter paper wet with lead acetate solution and held in fumes will turn black, showing presence of sulphur. The residue in tube is carbon and possibly weighting. Cotton fumes turn blue litmus paper red, showing acid present.

3. Weighted silks burn more slowly than pure silk. If very heavily weighted, the flame carries poorly and the form of the silk will remain. If it burns to an ash, it is not heavily weighted. Burn both warp and woof.

Test for shrinkage. — Measure width and length of your sample. Wash it in hot water and soap. Dry and measure again. Is it shorter and narrower? In making up cotton or woolen garments which are to be washed, allowance

should be made for shrinkage. Calculate how much the tested material would shrink in a yard.

Test for fading. — Mount a piece of the cloth to be tested on a board. Cover one half of it with cardboard or heavy paper and expose to the rays of the sun for several days. Remove cardboard and notice change. Expose covered piece also in bright diffused light as under ordinary conditions of service.

Test for strength. — Place the two thumbs together and press down on the cloth held tightly in the hands. Try to break first the warp and then the woof threads in this way. Sometimes there are imperfections in the weave or one set of threads is better than the other.

The laws of our country at present offer no protection to the purchaser of materials. Woman as the principal consumer should have a knowledge of adulterations in order to protect herself and family, for the question of the honesty of fabrics is one that must be met almost daily. Many adulterations are so carefully concealed that the use of microscope and chemical tests is required to disclose them. The purchaser for the everyday household who has no such facilities can do much to protect herself by the use of simple tests such as have been described above.

EXERCISES

1. What are the differences in the microscopical appearances of wool and cotton? Of flax and silk?
2. What are the chemical compositions of the four leading fibers?
3. Describe the principal characteristics and properties of wool; of cotton; of flax; of silk.
4. How can materials be adulterated by weighting; by methods of finishing; by combination with other fibers?
5. Describe two chemical tests for identification of wool fibers; for cotton.

SEWING AND GARMENT MAKING

CHAPTER XIII

UNDERGARMENTS

Hand vs. Machine Work. — With the knowledge of the plain stitches gained in the elementary school, it is possible for the high school girl to begin the making of undergarments. These may be made by hand, by machine, or by a combination of both processes. There is an indefinable charm about handmade lingerie, but very dainty and beautiful garments can also be made by machine. Some of the old-time drudgery of hand sewing disappeared with the introduction of the sewing machine, but there are many things that affect the general appearance and finish of the garment which the machine cannot do. It is useful to know well both methods. Very often it is possible to use the machine for the long seams of nightgowns, chemise, or drawers, and have the trimming and finishing done by hand. Saving of time is a great factor and should receive consideration in the planning of garments. It is wise to learn early to exercise care in handling materials during the construction of garments. A dainty, light touch, care in holding and folding, affect the dainty appearance, as well as the neatness of the sewing and finishing.

Undergarments made at home are apt to be more durable than ready-made garments. The materials are more carefully chosen, and one garment will often outwear two bought

ready-made. The homemade garments are apt to be better finished. A girl who learns to make her own underwear will have better looking garments as well as more durable ones, and will be able to save about half the cost. In making or buying underwear one must consider the laundering and wearing qualities. Muslin requires washing and ironing and should be so made up that the raw edges are carefully concealed and the stitches by hand or machine small enough to stand the strain and pull of the wringer and washboard. Cheap machine-made goods usually have very coarse stitching. Lingerie which is trimmed elaborately with ruffles and valenciennes lace is twice as expensive to launder as a plain flat trimming of French embroidery, feather stitching, or simple linen lace.

It costs in the time and energy which must be expended — and that time and energy often represent money wasted that might be spent to better advantage. Flat-trimmed underwear is easily ironed and stands the strain of washing better than lace and ruffles (see



Courtesy of J. McCutcheon & Co.

FIG. 90. — French nightgown.

Fig. 90). Underwear of cotton crêpe is pretty, and economical when laundering is a problem, as it does not require ironing. It can be dried in the air and sunshine and stretched and folded ready for wear.

The ethics of purchase of underwear. — In purchasing

underwear ready-made, every thoughtful purchaser is confronted by an ethical question. Under what conditions of labor were the goods manufactured? Many garments are made under such insanitary conditions that ready-made articles should always be laundered before they are worn. The Consumers' League is trying to raise standards in relation to the sanitation of workrooms and shops in which clothing is made, and to improve the wages, working hours, and conditions of workers in the manufacture of women's white underwear. The League permits the use of its label (see Fig. 91) by manufacturers of women's white underwear who give no work outside of their factories, employ no children



FIG. 91. — Consumers' League label and Union label.

under sixteen years of age, never exact overtime, and obey the state labor laws. Seventy firms in the United States are using the Consumers' League label. The labels are placed on all garments made in factories of firms which have agreed to fulfill the above requirements. Have you in buying underwear asked for goods bearing the Consumers' League label? Many garments are made in tenements where the surroundings are most unhealthy, and the labor of women and little children after school hours has been put into them. Even babies of four are set to work removing the basting threads. The "operators" work an unlimited number of hours and receive very little pay.

The prices paid under such conditions for making garments by machine are about 75 cents a dozen for nightgowns, 22 cents a dozen for corset covers, 98 cents a dozen for silk waists, and for other garments in proportion. The pressure of work is so great in tenement houses where this labor is done that there is little time for preparation of food or care of the home. Do you wonder that tuberculosis and other diseases thrive under such conditions and are transmitted in garments? To-day in New York City over thirteen thousand tenements are licensed by the bureau of factory inspection of the State Department of Labor. In these buildings work can be done for manufacturers on which the whole family labors without reference to factory laws or age. The labor law in New York State prevents any child under fourteen from being employed in factories. The law does not apply to these tenement sweatshops.

In buying ready-made undergarments one should also consider the cut. Do they permit of freedom in the necessary bodily movements? Is the material durable and firm looking? Muslin will wear better than nainsook. It will not pay to buy cheap, flimsy lace. Whether one should buy or make undergarments will depend on how much leisure time one has or on how well one organizes the use of time.

In planning to make undergarments one should first decide how much time there is at disposal for construction. Can one afford to put dainty hand sewing on everyday garments, and will handwork stand the wear and tear of constant use? The plain stitches learned in the elementary school will all be of use in construction, and the decorative stitches described under embroidery are of value for ornamentation. Machine sewing will not be found difficult if the machine is studied carefully and some time is spent in practice until neat, even stitching is obtained.

The sewing machine and its use. — Time will be saved if, before beginning to use the machine, the book of directions is carefully studied. This can be done as a home study lesson. The mechanism should be understood. The sewing machine was invented in 1846 by Elias Howe of Cambridge,

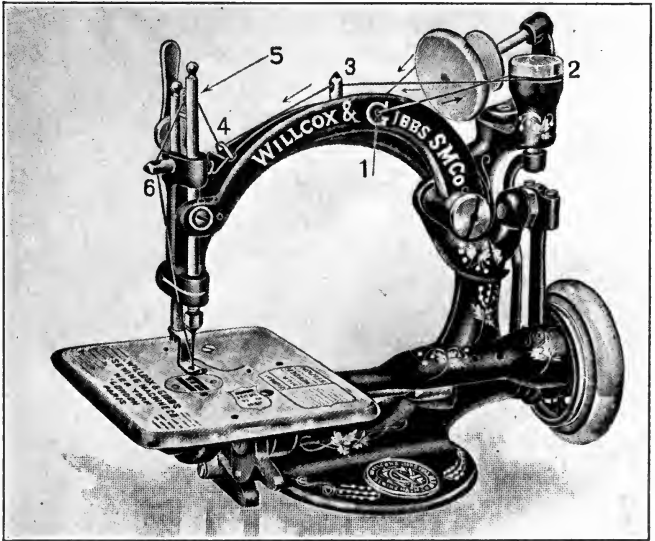

Courtesy of Wilcox and Gibbs Sewing Machine Co.

FIG. 92. — Single thread machine.

Mass., and improvements on his model soon followed. The two principal kinds for ordinary use are the single thread or chain stitch machine and the double thread or lock stitch type. It is advisable to learn to use both. The single thread rips easily, so the ends should be carefully fastened. In making hems, tucks, or flat fells on chain stitch machine it is necessary to stitch always on the right side, as the under side shows the chain. This necessitates very care-

ful straight basting. The double thread machine can be used effectively on either right or wrong side, and does not rip easily (see Figs. 92 and 93).

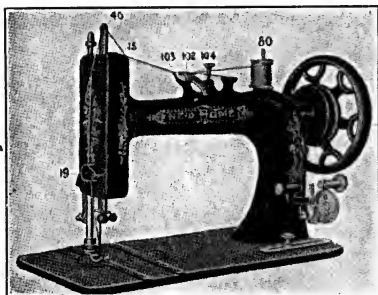

Courtesy of New Home Sewing Machine Co.

FIG. 93. — Double thread machine.

The attachments for gathering, hemming, and tucking all save time, but plain stitching should be learned first; and many prefer to do the preparatory processes of gathering, etc., by hand.

SOME THINGS TO NOTICE BEFORE BEGINNING PRACTICE

1. Look at the parts of the machine below the table. Study the relation of the treadle to the connecting rod, and to the wheel. What connects the wheel below the table with the wheel above?
2. Above the table, look for the spool holder, the shaft, the needle bar, the presser foot, the needle, the needle plate, the feed.
3. The single thread machine has an automatic tension that should not be touched; the double thread has a tension screw which regulates the speed with which the thread is drawn from spool and bobbin. Find this.

4. The double thread machine has a shuttle that fits in a shuttle carrier under the needle plate. Find it and remove the bobbin from the shuttle. This machine also has a bobbin winder. Where is it located?

5. Notice how the length of stitch is controlled. In some double thread machines a screw in the front of the arm must be turned to the right to increase the length, and in the opposite direction to shorten. In others a screw may be found in a groove at the base of the arm. This may be moved forward or backward according to the numbers in the table. In the single thread machine notice the lever for controlling the number of stitches to the inch, and the direction for size of thread to be used.

A FEW THINGS TO PRACTICE

1. Learn to tread evenly. This can be practiced before threading.

2. Follow book of directions for threading.

3. Learn to wind the bobbin if you have a double thread machine.

4. Practice threading the shuttle.

5. Practice turning the wheel and holding the upper thread so as to draw the under thread up through the needle plate preparatory to stitching on the double thread machine.

6. When necessary, practice change of stitch and use of tension.

7. Practice stitching on brown paper without thread.

8. Practice straight stitching on a piece of ticking or other striped material for a guide.

9. Practice straight stitching on a scrap of plain cloth, and try to turn good square corners. That is done by not raising the presser foot until the needle is down in the corner desired, then, with needle in cloth, raise foot and turn ma-

terial. Practice parallel rows of stitching. Do not stitch with pressure foot down without cloth under the feed; it spoils the machine.

A FEW THINGS TO BE CAREFUL ABOUT

1. Be sure that your machine is clean and well oiled. If it becomes sticky or if the machine is to stand unused for a few months, oil with kerosene. This will cleanse. Work it so that the oil will travel, and wipe off carefully. After cleansing, oil with machine oil. Use only a good quality. Keep a cloth in the machine drawer and always wipe the machine carefully before using.

2. The thread, needle, length of stitch, must all be in keeping with the material. For ordinary white work, No. 80 cotton is about right. Consult book or table of machine for size of needle to be used and suitable thread.

3. *If the machine does not work well* and is in repair, it is generally because it is not threaded properly above or below the table, or perhaps the needle is blunt or has been incorrectly set. Examine these parts.

4. In beginning to sew on the single thread machine, throw the thread between the prongs of the presser foot until started. Keep the cap covering the looper closed. In the double thread be sure the under thread is up before starting.

5. Learn to shorten the belt when necessary. If it is loose, the machine works badly.

6. When stitching bias and straight edges together, the bias should be placed down towards the feed, as it is more easily stretched and is thus held in as the feed moves forward. The presser foot holds the straight edge tight.

7. The table at the left hand is the place for the bulk of the work. It should not be crowded to the right of the pres-

ser foot, for it is then impossible to guide the work easily or stitch well.

Selection of materials for underwear. — There are a number of cotton materials suitable for underwear. In selecting, one should consider the use of the garment. Consult the list of common materials under "cotton." One can

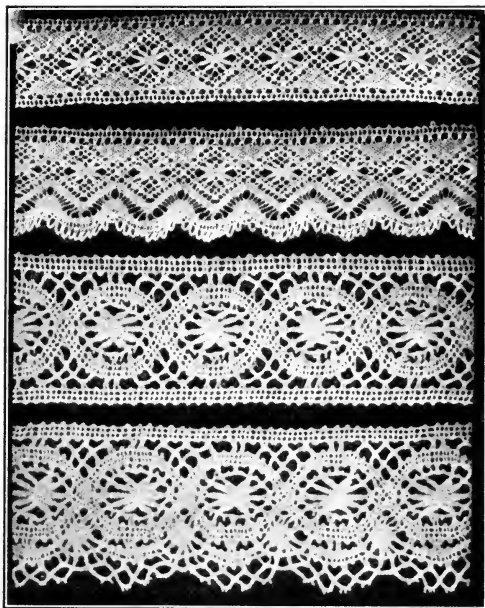

1 All linen Cluny insertion.

2 All linen Cluny edge.

3 All linen Cluny insertion.

4 All linen Cluny edge.

Courtesy of McCucheon's.

FIG. 94. — Laces.

spend a great deal of money on fine nainsook with lace and embroidery for trimming; but if one must economize, it is possible to produce very inexpensive and pretty underwear with a little thought in the selection of material and the decoration. Instead of lace or embroidery, garments may

be ornamented with simple stitches. Long cloth or a light muslin will give most satisfactory wear if the garment must

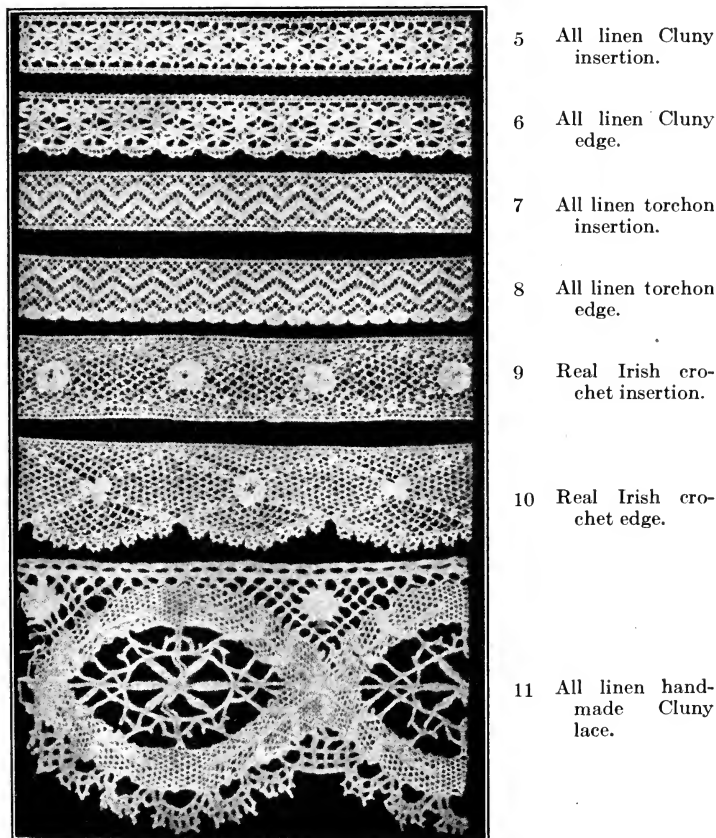

- 5 All linen Cluny insertion.
- 6 All linen Cluny edge.
- 7 All linen torchon insertion.
- 8 All linen torchon edge.
- 9 Real Irish crochet insertion.
- 10 Real Irish crochet edge.
- 11 All linen handmade Cluny lace.

Courtesy of McCutcheon's.

FIG. 94a. — Laces.

have hard usage. It pays to buy long cloth by the piece of twelve yards. For ordinary wear, if one does not care for

a very heavy garment, Berkeley cambric or Alpine Rose muslin are satisfactory. Nainsook is finer and softer in quality, but not quite as durable. Dimity, lawn, and crêpe are also used.

For durability linen laces are the most satisfactory (see Figs. 94 and 94a). Torchon and Cluny come in varying widths and qualities, and the machine-made linen laces in imitation of handmade Cluny and torchon are very good. Half inch edges and insertions can be obtained for six or seven cents a yard. Valenciennes lace is also used on underwear and is pretty, but not as durable as linen. The "German Val" is the best. There are other cotton laces, but they are generally not as pleasing in appearance nor of satisfactory wearing quality. Linen and cotton laces are often combined very effectively on underwear. Hamburg, Swiss, or batiste embroidery, edging, and insertion are used alone or in combination with lace on underwear. They are generally more expensive than lace, but come in many qualities.

Good taste is shown in the selection of materials for underwear as well as for outside garments. One should know what one can afford to spend, and then in selecting should consider the circumstances under which the garments will be worn and how they will be laundered. Flat, simple garments are easily laundered at home; and if sent to a laundry, the charge is less than for more elaborate garments. Expensive garments beyond one's means are not good taste.

If you are not very experienced in shopping, it would be wise to bring samples of materials to be used to class for criticism, before purchasing.

The decoration of underwear. — There are many simple and beautiful ways of decorating underwear. A dainty garment which warrants the expenditure of time can be put together with *entre deux*, or seam veining as it is sometimes

called, instead of the French or felled seams. *Entre deux* can be bought with swiss or nainsook background. Care should be taken to have it match the garment in quality.

Methods of use of *entre deux*, or seam beading. — *In seams of garments.* — Cut the muslin at each side of the *entre deux* the width for two seams. Sew as for French seam with first sewing on right side of garment and second on wrong. This can be done by hand or machine. The second sewing should come close to the beading so as to show none of the muslin on which the beading is embroidered. Ruffles can be attached to one edge of the beading or *entre deux* in the same way, but should be carefully basted before sewed.

Other uses. — *Entre deux* or beading is also used in joining lace by hand. Cut the muslin close to beading and overhand alternate rows of lace and beading. In overhanding hold the two edges together between the thumb and first finger. This makes a dainty trimming for sleeve, cuffs, collars, or yokes.

Sewing between rolled edges. — Cut the muslin from both sides of the beading or *entre deux* if both edges are to be joined as in placing an insert in a ruffle. Hold the wrong side of the cloth toward you. Roll the cloth, beginning at the right of the edge to be joined to the beading. This edge should have all ravelings cut away. Roll tightly towards the worker between thumb and forefinger of left hand. A tiny, neat roll requires practice. Keep about two inches rolled ahead of the sewing. In joining the rolled edge to the edge of the beading with the hemming stitch, pass the needle with each stitch under the roll. This keeps it in place so no raveled edges will escape. This is called whipping, and is a hand-sewing process.

The introduction of lace as decoration. — Lace insertion can be used as suggested above for embroidery, and whipped

to rolled edges. When a lace edging is to be attached to a rolled edge, it is sewed in the same way, but the lace is held a little full, or, if more fullness is desired, the top edge of the lace is overcasted and drawn up. This is better for full ruffles, as it does not weaken or leave an edge at the top. Lace edging can be attached to any hemmed edge or ruffle by hand. If fullness is desired, the lace should be held a little full towards the worker in sewing or the method suggested above may be used.

Lace may also be used in designs for decoration of flat surfaces. The lace is then basted in the shape of the design to the flat surface and sewed at both edges on the right side by hand or machine. The edge of the lace should be overcasted where round corners are turned. If the lace is sewed by hand, a running and backstitch is used or sometimes a hemming stitch. Turn to the wrong side. Cut out some of the muslin with care not to cut lace, leaving enough to turn back at both edges. This can be rolled and hemmed by hand to the edge of the lace, or the raveled edge rolls itself if overcasted to the edge of the lace. In machine work a narrow, neat hem may be basted both sides and stitched.

Whipping of ruffles. — In making underwear or other fine white work by hand, ruffles should first be whipped before being overhanded to the hem, beading, or lace insertion. In whipping a ruffle the edge is rolled as described above towards the worker with the thumb and first finger of the left hand. The needle is pointed as for the hemming stitch and the edge held over the finger in the same way, but the needle passes under the roll with each stitch and is brought out at the edge between roll and material. In this way the thread is gradually passed around the roll in spiral fashion. After a few inches of stitches have been taken, the thread

can be pulled and the ruffle drawn up to desired fullness for the space that it is to cover.

Tucking. — It is possible to decorate beautifully and inexpensively with hand or machine made tucks. Care should be taken to have them of even width. If made by hand, they should be marked with a measure (see Fig. 95). A piece of notched cardboard will be found easier to handle than a tape measure. The machine tucker has a guide for marking the fold of the tuck and the spaces between. In calculating the amount of material

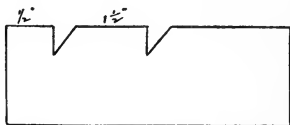

FIG. 95. — Cardboard gauge.

for tucks, allow for twice the width of each tuck desired. In placing tucks, fold the first tuck and stitch; then measure from the stitching of this tuck twice the width of the tuck plus the space between for the fold of the next tuck.

Tucks may be arranged in groups and in ascending or descending effects. The effect of an odd number is prettier than an even. Tucks may be made with both the warp and the woof threads of the cloth, and may be crossed in checkerboard fashion. This makes a very pretty decoration, but one must be rather expert to tuck in this way. Tucking combined with fancy stitches such as the featherstitch, lazy daisy, or chain stitch is the daintiest way of decorating clothing for children.

Fancy stitches as decoration for white work can be made simply or in elaborate designs in satin stitch. (See embroidery.) Designs may be made and transferred, or simple designs may be purchased. The simple arrangements of featherstitching and other decorative stitches can often be marked directly on the cloth with a hard pencil. Rows of featherstitching with French knots between the stitches is a pretty decoration to place between groups of hand tucks.

The lazy daisy stitch can also be used in rows (see Figs. 96 and 97). Circles marked with a spool to overlap, and featherstitched on the line make a very effective decoration. Squares or ellipses followed in the same way are also pretty.

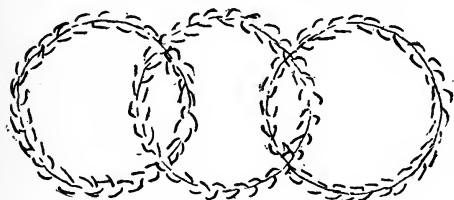

FIG. 96.—Featherstitching of circles interlaced.

Featherstitching can be used on finishing bands where an extra hand finish is desired. The bottom of ruffles can be finished inexpensively with featherstitching. Make one turn of material as for a hem the width desired. On the right side trace simple curves which should not go above the raw edge of turned material. Featherstitch closely on this tracing. Cut out the turned material on wrong side close to the feather stitching (see Fig. 113).

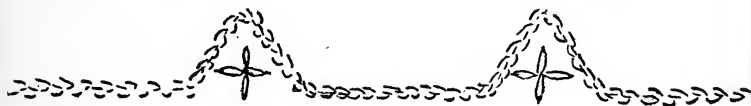

FIG. 97.—Hem of ruffle, featherstitching and lazy daisy stitch.

Scalloping is often used for edges where a flat finish is desired. It can be marked by means of a spool and makes an effective trimming around necks of chemise, nightgown, and top of corset cover. (See embroidery.)

Mitering lace and embroidery. — In finishing corners it is necessary to turn them neatly. A miter will give the smoothest finish. Plan carefully by folding embroidery to get desired finished effect, then cut, allowing for a seam. On the wrong side turn back seam allowance and overhand together. When opened and flattened, the raw edges can be

hemmed to the cloth on both sides by hand. The miter can also be stitched by machine, but should be basted carefully in straight seam. Embroidery is sometimes joined by cutting so the pattern matches and the edges sewed with a close buttonhole stitch on the wrong side of seam. When lace is joined in this way, the seam can be straight or may follow the outline of the design of the lace.

Bias bands as trimming. — A neat finish is obtained with bias bands instead of the finishing braid which can be purchased in plain or decorated patterns. The bias bands are used to cover raw edges at the top of ruffles on petticoats or drawers or to finish neck or armhole where ruffles have been used. The seam joining the ruffle to the garment is on the right side. The bias band is cut the desired width and basted carefully on both edges so as to cover the raw edges of the ruffle. It is stitched on the very edge. Bias bands are easily cut if one remembers that in folding the material the warp threads of the cloth should lie exactly on the woof. The diagonal thus formed is the true bias cut, and any width can be made. Other bias cuts can be made, but the true bias is the most satisfactory for turning round corners. Do not forget that in joining bias bands the seam must be made along the warp threads.

EXERCISES

1. Give reasons for hand *vs.* machine made underwear. What ideals should regulate the kind of material and decoration?
2. What ethical question confronts the purchaser of ready-made underwear?
3. What are the conditions existing in many factories and tenements where underwear is made?
4. Try to find out what the Consumer's League is doing along these lines. Have you joined the Consumer's League of your town? Is there a "white list" of shops where honest goods can be obtained?

What are you doing to relieve the burden of the shop girls at Christmas time?

5. Compare the single and double thread machines. What difficulties were experienced in practice? What things must one exercise care and judgment about in the use of the machine?

6. Give the names of five different materials used for underwear. Suggest various laces and embroideries for decoration. What should regulate their use? Bring to class samples of materials and laces for use. Mount on bulletin board with those brought by class members. Compare prices, widths, and qualities.

7. Explain the use of *entre deux* or seam veining as decoration for a nightgown.

8. Explain three ways in which lace may be introduced as trimming for undergarments. Explain how to whip a ruffle for a nightgown.

9. Explain how you would trim a corset cover inexpensively with tucks, *entre deux*, and hand work. How much material must be allowed in calculating for three $\frac{1}{8}$ " tucks?

10. Explain method of mitering lace for a square yoke of nightdress. Explain the cutting of true bias bands. How should they be used around armhole of corset cover for finish, and how joined?

CHAPTER XIV

PATTERNS

EVERY high school girl should know how to use the commercial pattern and to alter it to suit her needs. It is also possible to learn to draft patterns in a simple, free way. Drafting means the making of a pattern according to individual measurements. Drafting helps one to adapt patterns to suit individual figures and gives one a better understanding of commercial patterns. Modeling in crinoline, paper, or cotton cloth is another method of making patterns. All girls at some time have made patterns for dolls' clothing by pinning cloth or paper about the doll, and with scissors cutting out neck, armhole, and other parts to form a pattern. Skillful dressmakers, without use of patterns, join and drape materials into desired shapes, using the scissors to cut away superfluous parts. All this is a free way of pattern making. In beginning this study one should try to combine the use of these various methods in order to have a full understanding of the many possibilities. If one learns to model a shirt-waist pattern on a figure before learning to draft one, there is usually a better understanding of the method of making a comprehensive draft and of the changes that can be made in commercial patterns to adapt them to individual figures. One should learn as soon as possible to take measurements, for they will be needed in using the commercial pattern in order to test it, or in drafting to certain figures.

How to take measurements. — 1. The *bust measure* is taken by passing the tape measure under the arms over the

fullest part of the bust and crossing tape in the middle of the back between the shoulder blades, sloping the tape very slightly upward. Take an easy measure.

2. The *width of back* is taken from armhole to armhole across the widest part of the back.

3. The *length of back* is from the small bone at the nape of the neck to the waistline.

4. The *waist measure* is a snug measure about the smallest part of the waist.

5. The *neck measure* is taken by passing the tapeline around as a collar and is an easy measurement.

6. The *width of chest* is taken three inches below the lower edge of collar band and between the armholes in a straight line.

7. The *length of front* is from the bottom of the collar band to the waistline.

8. The *underarm* is taken from the hollow under the arm to the waist in a straight line.

9. The *armhole* is an easy measure around the arm at the shoulder, over the shoulder bone.

10. The *length of arm* is taken on the inside from armhole to the wrist and on the outside by bending the arm and passing the tape from the shoulder bone to the elbow and on to the wrist.

11. *Skirt measures* are taken for waist, hip, and length of front, side, and back. The hip measure is an easy one, and is taken by holding the tape around the fullest part of the hip and is usually about six inches from the waistline at the hip. The length of front, hip, and back are taken from the waistline to the floor.

The selection of the commercial pattern.— There are many reliable firms furnishing patterns. It is wise to try different makes until the most satisfactory is found. The

simplest ones where proportions of the figure are studied as well as style are usually the best. Patterns are bought by measure or by age, *i.e.* a pattern for a nightdress, drawers, or dress for fourteen-year age or as a shirt waist for 34-inch bust measure. Patterns for skirts state the waist, hip, and length measures. Good sense and thought are needed in the selection of patterns, for one should keep in mind the figure for which it is to be used. Standard measures only are used in making commercial patterns. In some figures it may happen that the hip measure is large in proportion to the waist and consequently waist and hip do not bear the same relation as those of the standard pattern. In selecting a pattern for such a figure, one should compare the measures given on the pattern with those of the person for whom it is to be used. If there is a difference, and the waist is smaller, it would be good sense in selecting a skirt pattern to choose one with the hip corresponding and fit the waist. If the waist is larger than the waist of the standard, choose one with the proper hip measure and add to the seams so as to fit at waistline (see Fig. 98).

Interpreting patterns. — Before using a pattern it is wise to study its pieces carefully. Read the directions and notice the numbering of its parts. Usually only one half of each part is given. It is wise then to notice carefully the notches and perforations, for if only one half of a pattern is given, some parts must be placed on a fold of the material so as to have those parts cut in one piece. Care and thought must be exercised constantly. Some patterns allow for seams and others do not. Notice the perforations, especially those which indicate how the pattern is to be placed on the warp threads. This is a very important point. A group of triple perforations at the edge usually means cut that edge of the pattern on a fold of the cloth. In studying the pattern be

able to identify each part and to tell the relationship of one piece to another.

Testing and altering patterns. — After selecting and studying the pattern the next step is to test it before use, for some alterations may be necessary in order that the garment fit well. Take the measurements of the person to be fitted and compare these measurements with corresponding measurements of the pattern. The proportions of waist, sleeve, or skirt may be changed in length or width to suit figures not quite in proportion to the standard pattern. To change length of front or back portions of a shirt waist, measure from collar band seam at the back of the neck to the waistline, and also of underarm from armhole to the waistline. When the figure is long waisted from the armhole to the waistline and short from underarm to the neck or the reverse, change of pattern can be made by slashing the pattern and inserting a piece to lengthen, or reducing length by taking a plait in the pattern (see Fig. 99). The amount will depend on the difference between the measure and the pattern at the two lengths. If this alteration is to be made, it should be done at a distance of about $2\frac{1}{2}$ inches above the waistline. This plait or insert should be in a straight line, and may necessitate building up the armhole. Sometimes it may be necessary to make two plaits or inserts, one between waist and bust and the other between bust and shoulder. To shorten or lengthen a simple skirt pattern, cut and insert a piece, or lay a plait from 6 to 8 inches below the hip line in each gore — that will be about $12\frac{1}{2}$ inches from waist (see Fig. 98). This shows also how the pattern can be changed to increase the waist measure without changing the hip.¹

¹ A gore is a portion of a skirt and is narrowed at the top to fit the waist and flares at the bottom to give fullness.

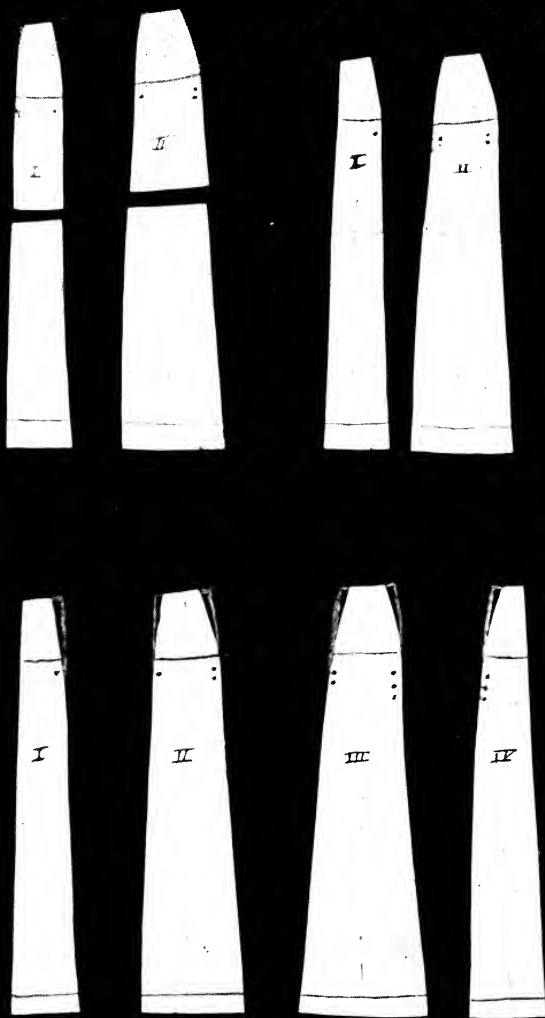

FIG. 98. — Alteration of patterns.

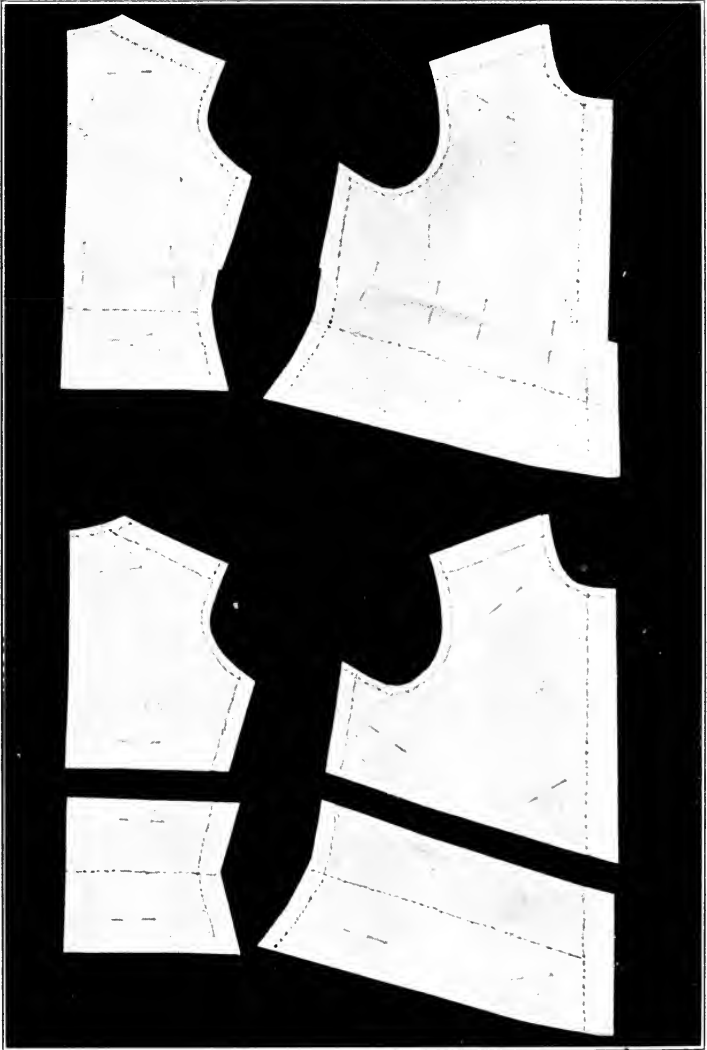

FIG. 99. — Alteration of patterns.

In order to test the commercial pattern after such suggested changes have been made, cut a simple waist or skirt pattern from inexpensive muslin or calico and change it by fitting and adjusting to suit the person. This when corrected may be kept for a foundation pattern and adapted to changing styles.

Very square or very sloping shoulders cannot be fitted with a standard pattern without wrinkles. Very square shoulders often cause wrinkles across the chest or in diagonal lines from neck to armhole. If wrinkles form at front or back of neck crosswise, the pattern must be changed at neck and shoulder. The neck should be cut out and the shoulder line from the neck to armhole changed in slant by dropping at the shoulder. There may also be wrinkles at right angles to the shoulder. This necessitates certain alterations — stretch the front shoulder, which should be shorter than the back. For the sloping shoulder do not cut out the neck, but take off some material at the shoulder seam, increasing the amount from neck to armhole. This will decrease the size of the armhole, which should be made larger by cutting away under the arm. The waistline can be adjusted to fit the overerect flat shoulder blade by changing the slant at center back. Care must be taken in altering the pattern for the person who has formed bad habits of sitting or standing and allowed fat to accumulate across the shoulders. A careful distribution of gathers at the waistline, in fitting, will help to correct this appearance. When on such a figure there is fullness at the armhole towards the front, so that it stands out, drop the whole front from 1 inch to $1\frac{1}{2}$ inches lower than the back at underarm seam and build up the armhole (see Fig. 100).

A knowledge of drafting helps decidedly in the understanding and altering of commercial patterns, therefore it is

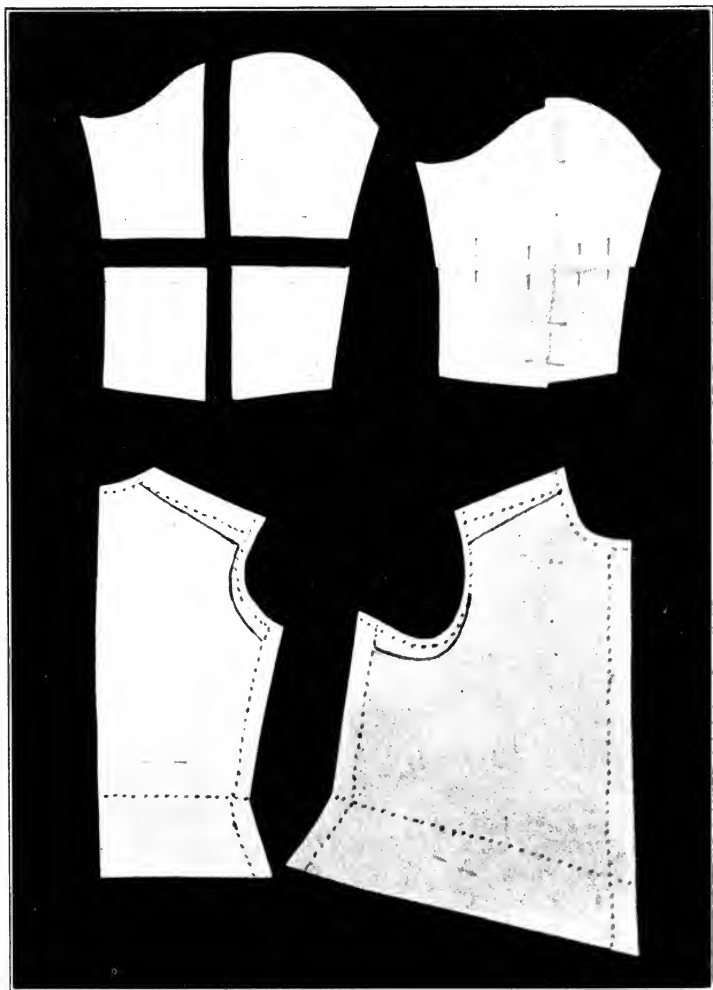

FIG. 100. — Alteration of patterns.

wise for every girl to learn some simple method of drafting. There are many good systems in use. The aim is not to commit to memory the system, but to become free, through the use of any system, so that one understands parts and can invent one's own drafts and change patterns made by others. The drafted pattern has the advantage over the commercial in not requiring as many changes.

EXERCISES

1. Name three types of patterns. Which do you think is in most general use? State some advantages of the commercial pattern.

2. Name three essential points to observe in reading the commercial pattern.

3. How do you test a pattern? Why? What measurements is it necessary to take for testing a waist pattern; a skirt pattern?

CHAPTER XV

THE DRAFTING OF PATTERNS

IN preparation for simple straight-rule drafting, one should have a good rule or square, a tapeline, pencil, and paper large enough for the particular pattern to be drafted. The first step is to take the necessary measurements for the particular garment. With a little practice it will soon become evident which measures are needed and why. The second step in learning to draft is to make a rough sketch of the outline of the pattern you expect to make. This helps in placing relationship of parts, and with the beginner aids materially in the understanding of them.

I. One of the simplest drafts for the beginner is the *kimono nightdress* (see Fig. 101).

(1) The measurements needed are —

1. Length from highest part of shoulder to floor.
2. Width across chest plus length needed for sleeves.
3. Loose bust measure.
4. Width and length (underarm) of sleeves.

(2) Make a rough sketch of the kimono gown, as it appears to you.

(3) *To draft:*

Fold the paper, which should be wide, lengthwise through center, so that when completed a full pattern of front is made. The pattern is to be drafted on the folded edge.

1. Measure on that edge the length of the garment *ST* according to measure.

2. At the bottom *S* measure out at right angles $\frac{1}{4}$ the width you desire the finished gown at the bottom *SB*. Remember this draft on the fold represents but half the front.

3. At right angles to point *T* place the shoulder line *TL*, which will be the measurement of one half the chest and sleeve length.

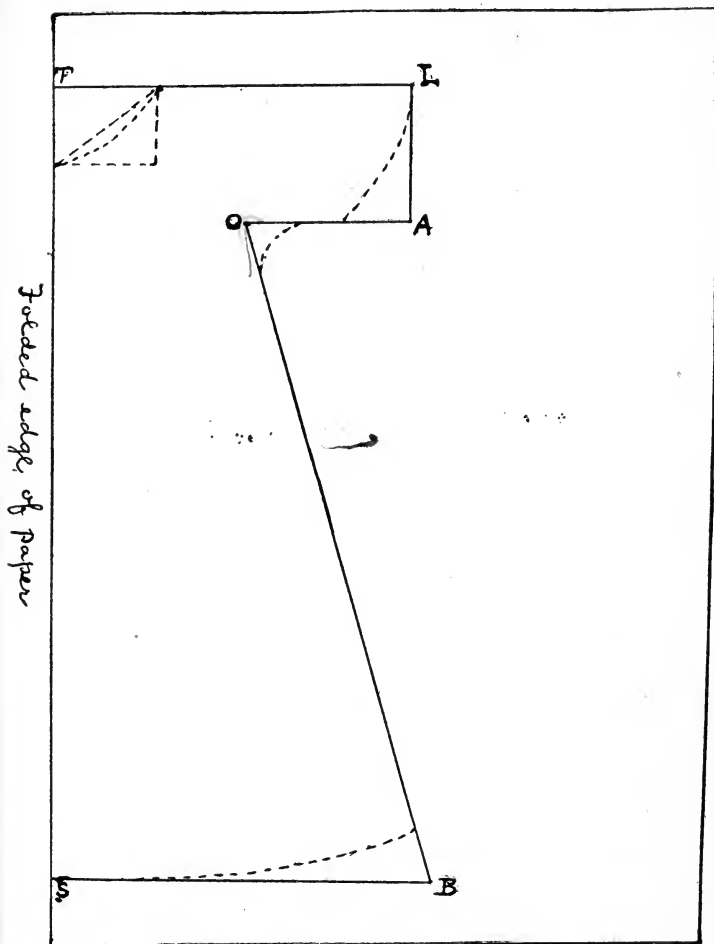

FIG. 101. — Kimono nightdress.

On that line measure from the fold for the desired neck to be cut out, square, round, or V-shaped.

4. At point *L* draw line to represent width of sleeve at right angles to *TL*. *LA* is the width of sleeve.

5. Draw the sleeve seam parallel to the shoulder according to underarm measure, line *AO*.

6. Draw side of garment a good line connecting points *O* and *B*.

7. *O* can be rounded instead of a sharp angle and makes a better underarm.

8. The bottom should also be sloped up to sides to give a better line and the bottom of sleeve shaped. (See dotted lines in Fig. 103.)

9. Cut out through two thicknesses of paper, making neck desired shape and allow 1" all around for seams. In cutting the neck if it is desired lower in front, cut out the pattern on a line for the neck desired in back and lower the front portion of material after all is cut out. Do not cut the fold. Notch in several places with tiny cuts so that garment can be easily put together if stretched. This pattern cut gives the full front or back. In most patterns but half is given, but in placing the pattern of the kimono nightdress on the cloth for cutting out it is easier to have a full front than half. The shoulder is placed on a crosswise fold of the cloth for cutting.

II. *A simple drawer draft* (see Fig. 102).

(1) Take measurements.

a. Length of leg from waist to knee.

b. Waist measure.

c. Hip measure over fullest part of hip 6" below waistline.

d. Width desired for drawer leg at bottom.

(2) Notice shape of the finished drawer leg.

(3) Draw picture of the way you think the opened pattern of one leg should appear.

(4) *To draft:*

1. Fold the paper in half, lengthwise. The draft will be made on the folded edge, the upper half of the paper representing the front of the drawer leg and the under the back portion.

2. With the folded edge in vertical position, mark the length measure for drawer plus $1\frac{1}{2}$ ". Begin about 5" from the top edge of paper so as to have plenty of room. The edge between *M* and *N* will be the length of drawer and represents the side of the drawer leg. This fold will be placed on the warp of the cloth in cutting out.

3. At *N* draw at right angles a horizontal line to make width of leg. This may be $\frac{1}{2}$ waist measure plus 3" or according to measure *NO*.

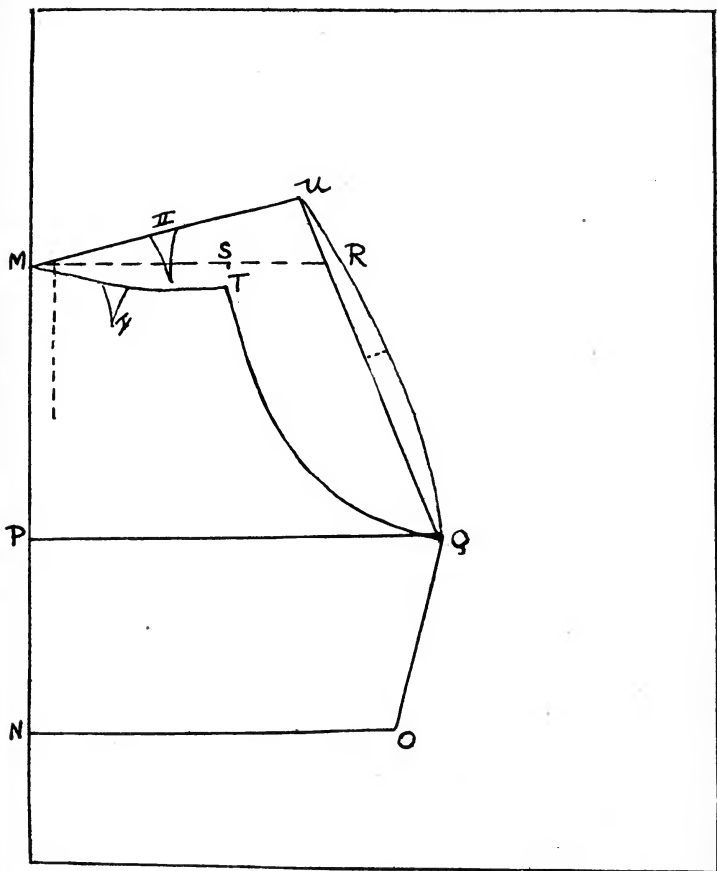

FIG. 102.—Draft of drawers.

4. From *M* measure down $\frac{1}{2}$ the length plus $1\frac{1}{2}$ " to locate point *P*.
5. At right angles to *P* draw *PQ*, which is $\frac{1}{2}$ the hip measure minus two inches.
6. Connect *OQ* for inner side of leg.

7. At right angles to MN at M measure $\frac{1}{2}$ the waist measure plus 1", draw dotted line MR for waistline. This will have to be lowered in front and raised at back in making pattern to allow for shape of figure.

8. From M for front of waist, measure on MR $\frac{1}{3}$ the waist measure, point S . Below S place point T $\frac{1}{2}$ " to allow for dip in front of drawer.

9. Connect MT with a slight downward curve and TQ with an inward curve for front of drawer leg.

10. From Q draw slanting line through R extending 4" beyond on same slant. QU equals back of the leg.

11. Connect MU for top of back part of leg.

12. Darts are from 4" to 5" deep and about 1" wide at top. Dart I is placed about 5" from T and dart II about 7" from U . If necessary take off dart at placket opening.

13. The placket opening, which is about 6" in length, is represented by the dotted line in draft, parallel to MN and 1" towards the back of leg.

14. If the drawer is to be opened instead of closed, and legs faced at center, more room must be allowed in back for lapping. The dotted lines indicate the change for the extra fullness for lap. At right angles to middle of line UQ draw dotted line $1\frac{1}{2}$ " and draw an outward curve.

15. To cut out pattern, cut on all outside lines through *two* thicknesses of paper. Do not cut the folded edge. Why? Raise the upper half of the pattern and cut on line representing front of drawer leg through one thickness of paper only.

III. *The shirt waist* (Fig. 103):

A good shirt waist draft is most useful, for from it can be made not only the shirt waist and variation of waists for simple lingerie and one-piece dresses, but the chemise, corset cover, and nightdress with sleeve. A thorough understanding of this draft will enable one to change it easily, according to measurements, for the other garments.

(I) Take measurements for shirt waist.

1. Place tapeline around waist, pin in place.

2. *Length of back.* From bone in nape of neck to bottom of tapeline at waist.

3. *Width of back.* Across broadest part of back from armhole to armhole (not too broad).

4. *Width of chest.* Across chest from armhole to armhole. 3'' from hollow of neck.

5. *Underarm.* Fold tape at 2'' point over lead pencil. Place pencil horizontally under arm, with care that shoulder of figure is not raised unnaturally. Take measure to bottom of tapeline at waist. Deduct two inches.

6. *Length of front.* From hollow of neck to bottom of tape measure at waist.

7. *Neck.* Around bottom of neck band, not too tight a measure.

8. *Bust.* Easy measure, pass tape measure over fullest part to middle of back, raising slightly upward. Measure taken from behind figure.

9. *Waist.* Snug measure at waist.

10. *Armhole.* Place tape around arm to bone of shoulder. Snug measure when sleeves are small.

Place the figures of measures gained in this way on the corner of sheet of drafting paper or convenient place for easy reference.

(II) On a waist form or human figure model a half waist in crinoline or tissue paper. Place the edge of the crinoline on a line with the center of the back, with selvage lengthwise. Pin so that cross-wise threads run across width of back. Pin at neck and armhole. Crease where shoulder and underarm seams should fall. The tip of shoulder for shoulder seam is about one third the distance from center front to center back of neck, and about one inch back of highest point of shoulder. The top of underarm seam should fall on line with it and slope slightly towards back at waistline. Pin fullness in at waistline towards center back. For front, pin selvage along line of center front. Allow plenty at top to cut neck and shoulder. Pin carefully so line is straight across chest. Crease shoulder and underarm seams. Cut away extra material. Pin in fullness at waistline in plaits. This is good practice before drafting.

(III) Draw a rough sketch of the way you think the half front and half back will appear. It is necessary to draft but half of each, but for convenience draw them side by side.

To draft back :

1. Towards left edge of paper draw vertical line to represent the length of back *AB*.

2. At right angles to *A* draw line *AA* to represent $\frac{1}{2}$ the whole bust measure plus $\frac{1}{2}$ ''.

3. Divide AB in half at C ; this is the back at about underarm.
4. Divide AC in half at D for location of width of back.
5. On AA from middle back measure $\frac{1}{3}$ of $\frac{1}{2}$ the neck measure to E . Raise F $\frac{3}{8}$ " above E .
6. At right angles to D draw DG , which measures $\frac{1}{2}$ of width of back.
7. At G erect perpendicular line GH same length as AE .

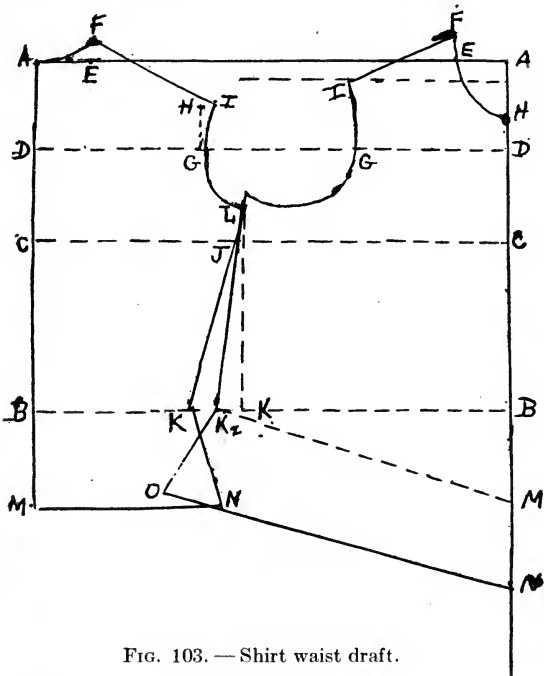

FIG. 103. — Shirt waist draft.

8. One half inch to right of H on line place I .
9. Connect A with curve to F for neck and F with straight line to I for shoulder.
10. From C draw at right angles CJ , which equals $\frac{1}{2}$ width of back plus $\frac{1}{4}$ of that measure.
11. At B draw BK at right angles, equaling $\frac{1}{4}$ the waist measure.

12. From *K* draw slanting line through *J*, which will equal underarm measure *KL*.

13. Connect *I*, *G*, and *L*, with an easy curve for armhole.

14. From *B* drop line 4'' *BM*.

15. From *K* draw slanting line *KN* for bottom 4'' long. This is made with rule on *F* and *K*.

16. Connect *M* and *N* — straight line.

To draft front. (In figure this is drawn to overlap slightly the back at bottom).

1. Continue construction lines *AA*, *DD*, *CC*, and *BB*, all equal $\frac{1}{2}$ bust plus $\frac{1}{2}$ ''.

2. Towards right edge of paper and at right angles to line *AA*, drawn to represent $\frac{1}{2}$ whole bust measure plus $\frac{1}{2}$ '', draw line *AN* indefinitely.

3. On *AA* from *A* measure $\frac{1}{3}$ of $\frac{1}{2}$ neck measure for point *E*.

4. From *E* draw *EF*, which equals $\frac{1}{4}$ ''.

5. From *D* draw *DG*, which equals $\frac{1}{2}$ width of front.

6. From *A* measure on *AN* $\frac{1}{3}$ of $\frac{1}{2}$ neck measure plus $\frac{1}{4}$ '' . *H* is point of neck in hollow at front ; make neck curve *FEH*.

7. To construct shoulder line, measure from *A* $\frac{1}{3}$ of distance between *AD*. Draw dotted construction line parallel to *AA*. From *F* measure in slanting line to meet dotted line the length of back shoulder less $\frac{1}{4}$ '' . Shoulder line is *FI*.

8. From point *J* of back draft, drop perpendicular dotted line to meet line *BB* at point *K*.

9. To left of *K* measure one inch *K²*.

10. From *K²* draw through *J* line for underarm of front according to underarm measure. It is slightly longer than back underarm. Point *L*.

11. Draw armhole curve *IGL*.

12. From *H* measure length of front *HM*.

13. Connect *K²* with *M* for front waistline.

14. From *M* measure down 4'' for point *N*.

15. From *K²* draw slanting line 4'' long towards bottom of front with rule on *F* of shoulder and *K²*. Connect *O* and *N*.

To draft shirt waist sleeve (see Fig. 104) :

(I) Take measurements for shirt waist sleeve.

1. Length inside of arm minus depth of cuff.

2. Measure around top of largest part of arm plus fullness desired.

3. Measure of hand over knuckles (hand extended as in putting through sleeve) plus desired fullness.

(II) This sleeve is to be drafted in one piece. Draw a rough sketch of the way it will appear.

(III) To draft sleeve. Draw dotted lines to form rectangle *ABCD* and draft sleeve within it. *AB* equals length of sleeve plus 4" or 5". *AC* equals measure around top plus fullness desired.

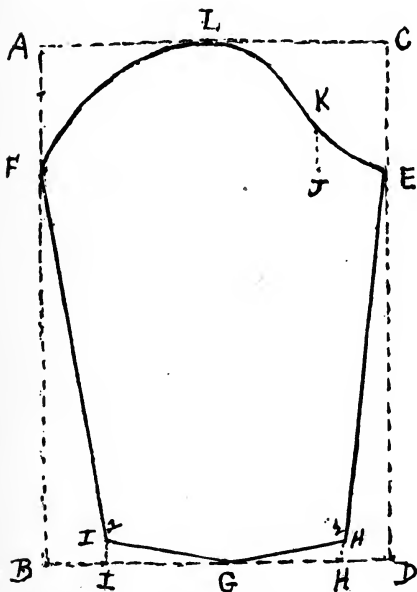

FIG. 104. — Shirt waist sleeve draft.

point *J*. Two inches above *J* place *K*.

Divide *AC* in half for point *L* at top of sleeve and make top curve of sleeve for upper and under side of sleeve.

IV. *To change shirt waist draft to nightdress* (see Fig. 105).

(I) For front.

1. Continue length of front according to desired length. Measure of length is taken from highest point of shoulder to floor.

2. From that point at right angles draw line for bottom of the gown — an indefinite length.

On *CD* from *D* measure length of sleeve *DE*.

On *AB* measure same length *FB*.

Divide *BD* for center sleeve point *G*.

From *G* in both directions on *BD* measure $\frac{1}{2}$ the hand measure plus fullness desired for points *I* and *H*.

Points *I*² and *H*² are one inch above.

Join *FI*² and *EH*² for inside line of sleeve and *I*² and *H*² with *G* for bottom.

From *E* measure to left three inches for

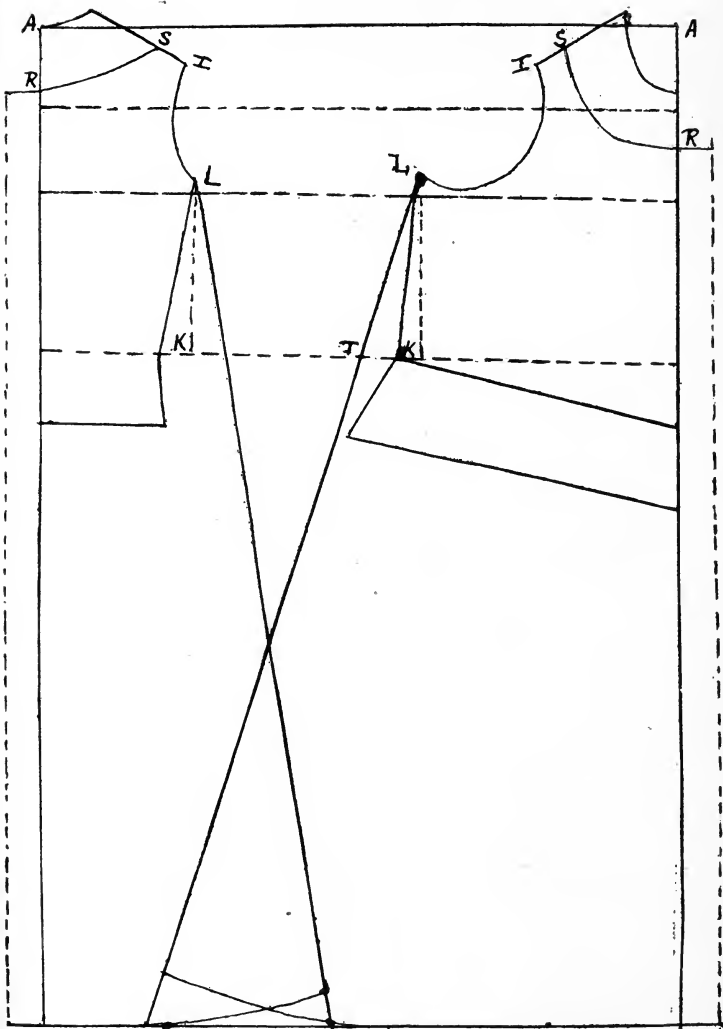

FIG. 105. — Nightgown developed from shirt waist draft.

3. Point *R* from *A* is $\frac{1}{2}$ neck measure + $1\frac{1}{2}$ inches.
Point *S* equals $\frac{1}{3}$ shoulder from *I*.
Connect for neck curve of low-neck gown.
Point *T* is 3 inches from *K*.

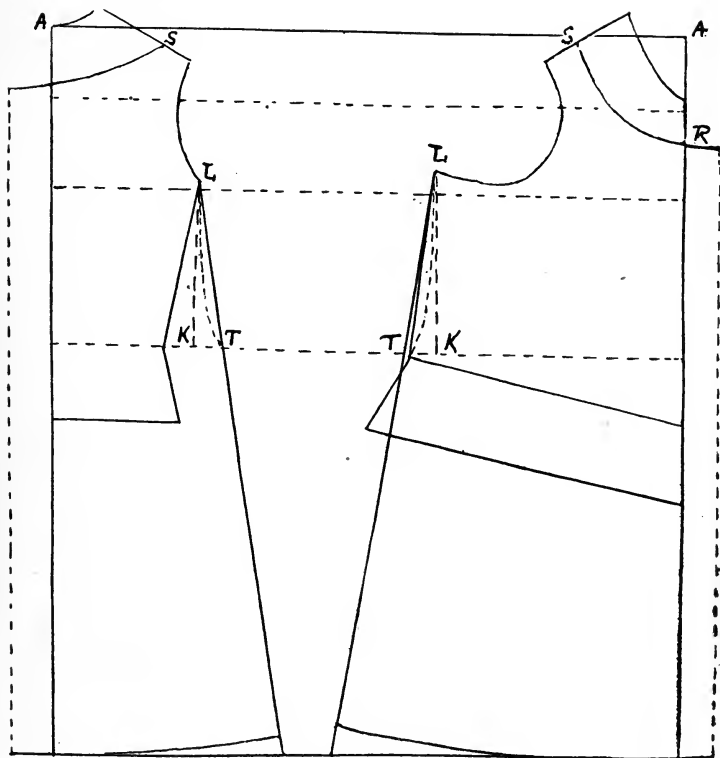

FIG. 106. — Chemise developed from shirt waist draft.

4. Connect *L* at underarm and bottom with slanting line through *J*.
 5. Curve at bottom — to give correct underarm length.
- (II) For back.
1. Continue length of middle back to desired length.

2. From that point draw at right angles line for bottom an indefinite length.

3. Point *R* equals $\frac{1}{2}$ neck - 2 inches.

Point *S* equals $\frac{1}{3}$ shoulder from *I*.

Connect with neck curve for low-neck gown.

Point *T* is 2" from *K*.

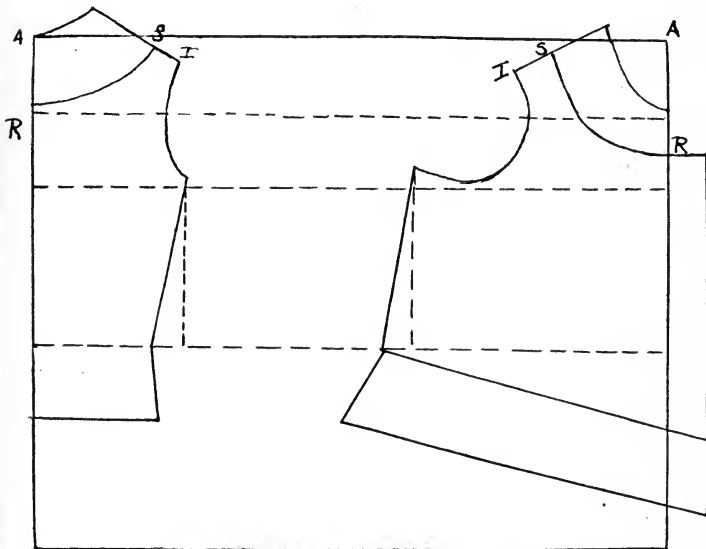

FIG. 107. — Corset cover developed from shirt waist draft.

4. Connect *L* at underarm with bottom by slanting line through *T*.

In cutting material, if allowance is to be made for tucks around neck in front or back add to the width in placing pattern, according to number and width of tucks, at the center front or center back. Two inches will give good fullness. (See dotted line in draft.)

V. To change shirt waist draft to chemise (see Fig. 106).

Change in same way as for nightdress except at point *T*, which is $1\frac{1}{2}$ inches out from *K* on both the front and back drafts. This is to give less fullness than the nightdress at the waist. The dotted

lines in drawing indicate the way in which the chemise can be cut on the underarm seam curve at the waist for still less fullness. Two inches more or less on front or back can be added for tucks as desired. Curve at bottom according to length.

VI. *To change shirt waist draft for corset cover* (see Fig. 107).

For front. Allow 2" or more for fullness and plait at front.

Point *R* from *A* = $\frac{1}{2}$ of neck plus $1\frac{1}{2}$ ".

Point *S* = $\frac{1}{3}$ of shoulder from *I*.

For back. —

Point *R* from *A* = $\frac{1}{2}$ of neck - 2".

Point *S* = $\frac{1}{3}$ of shoulder from *I*.

VII. *To draft the peplum for a corset cover* (see Fig. 108). If it is desired to finish at waist with less fullness over hips and abdomen.

1. Draw a square *abcd*. $ab = \frac{1}{2}$ waist minus 1 inch.

2. Measure from *C* four inches for point *E*.

3. Measure from *B* four inches for point *F*.

4. $AE =$ radius of circle for waistline, which should equal $\frac{1}{2}$ waist measure.

5. Four inches below *FE* draw curve *BC* for bottom of peplum.

6. $FB =$ center front.

7. From *C* measure down $\frac{1}{2}$ ". Connect *E* with that point for center back.

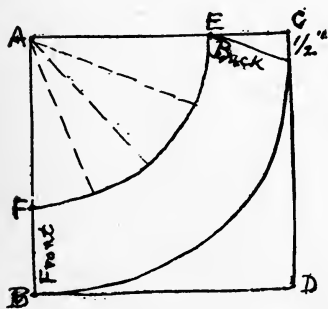

FIG. 108. — Peplum draft for corset cover.

VIII. *The skirt draft.* It is also advisable to learn to use a skirt draft which can be changed to conform to the varying styles of skirts, 4, 5, 6, 7, and 9 gored skirts, with panel front and back, and the other changes from season to season. From such a draft petticoats may also be made. Every high school girl should be able to draft such patterns and to learn to alter and adapt others. This foundation pattern if well understood will serve such purposes.

(I) *To take measurements for drafting foundation skirt draft.*

1. Place tape around waist and pin.

Four length measures are needed: center front, center back, right hip, and left hip. All are taken from bottom of tapeline at waist to floor.

2. *Hip measure.* An easy measure around the fullest part of hip. Add to this two inches when narrow skirts are worn.

3. *Waist measure.* Snug measure.

4. *Measure for dart at hip.* Straight line from bottom of tape-line at waist, over fullest part of hip to locate depth where hip line should be drawn in draft. This varies from $5\frac{1}{2}''$ to $6\frac{1}{2}''$ in length.

After taking the necessary measurements the next step is to decide on the width of the bottom of the skirt. This is in proportion to the hip and varies from $1\frac{2}{3}$ to $2\frac{1}{2}$ times the hip.

(II) *To draft the foundation skirt* (see Fig. 109).

1. For construction of waistline and hip draw the rectangle *ABCD*. Only one half of the pattern will be drafted. $AB = \frac{1}{2}$ the hip measure. $AC = \frac{1}{10}$ of $\frac{1}{2}$ the width desired around bottom.

2. To locate on *AB* the point for the waistline, measure from *B*; $\frac{1}{8}$ of $\frac{1}{2}$ the width around the bottom for point *E*.

3. Draw *EF* parallel to *BD*.

4. To locate hip dart, divide *CF* in half for point *G*.

5. Find the difference in length between the front length and larger hip length and measure the difference above point *G* for point *H*. This allows for the proper waist curve and dip in front. Draw the waist curve slightly up to meet *H* from *C* at center front and *E* at center back.

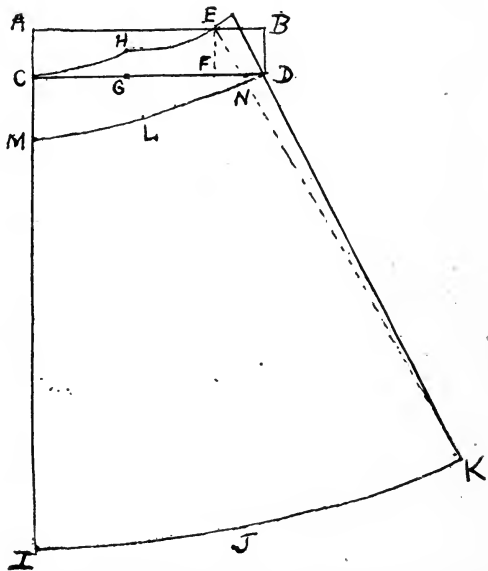

FIG. 109.—Foundation skirt draft from which skirts of gored division can be made.

6. Measure from *C* for the length of front *CI*.

7. With ruler at right angles to the waist curve at *H* measure length of larger hip for location of point *J* at the bottom.

8. From *E* draw dotted line for length of back. Point *K* will be located by measuring from *I* through *J* and to *K* for $\frac{1}{2}$ of the desired width at bottom, at point locating length of back from *E*.

9. From *H* with ruler at right angles to waistline measure down length of dart measure. Place point *L*.

10. Point *M* is placed on *CI*. It is the depth of dart minus the difference between the front and larger hip length from *G*.

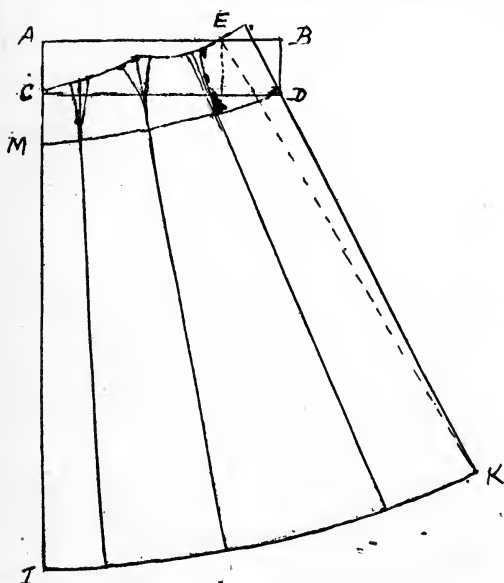

FIG. 110.—Six-gored skirt draft from proper division of the foundation skirt.

now be divided to make a 4, 5, 6, 7, or 9 gored skirt.

III. *To divide the foundation draft into six-gored skirt* (see Fig. 110).

1. Make the foundation draft according to measures. The space within the outline of skirt is to be divided for six gores. This is but half the skirt.

11. Point *N* is found on line *EK* and is the depth of dart minus or plus the difference between the hip and back length.

12. Draw the hip curve.

13. Measure the hip curve of draft and compare with measure taken. If too short, draw a new back length line at the extension point and extend waist curve beyond *E* to meet it. This does not increase the width at bottom.

This foundation draft of skirt can

2. Draw front gore. Measure on the hip line $\frac{1}{6}$ of $\frac{1}{2}$ hip measure.

Place dot. On bottom line from front line measure $1\frac{2}{3}$ times the space from front to dot placed for hip point of front panel. Connect these two dots continuing to waistline.

3. Draw back gore. This is $\frac{1}{2}$ " wider at hip line from center back than the front panel, and is $1\frac{2}{3}$ times this width at bottom. Draw lines connecting point at bottom with hip and waistline.

4. Divide remainder of hip line in half. Divide remainder of bottom line in half.

Move this last point $1\frac{1}{2}$ inches towards front.

Draw line through these points to waist for hip seam.

5. The waistline is too large, so darts must be taken. Measure waistline of draft. Subtract from this $\frac{1}{2}$ the waist measure of figure; the remainder must be taken out in darts on $\frac{1}{2}$ the pattern.

First. Take off from front and back gores, on the side of front towards first gore measure at waistline $\frac{1}{8}$ to $\frac{1}{4}$ of an inch and make curve to hip line. On the back gore side towards side gore measure off $\frac{1}{8}$ to $\frac{1}{4}$ inch at waist and draw curved line to hip line.

Second. On first gore, side towards front, take off at waistline $\frac{3}{4}$ to 1 inch. Draw curve to hip line.

On second gore, side towards back at waist take off $\frac{3}{4}$ to $1\frac{1}{4}$ inches. Draw curve to hip line.

Third. Subtract sum of what has been taken out in darts from amount needed to be taken out and take the remainder from seams over the hips.

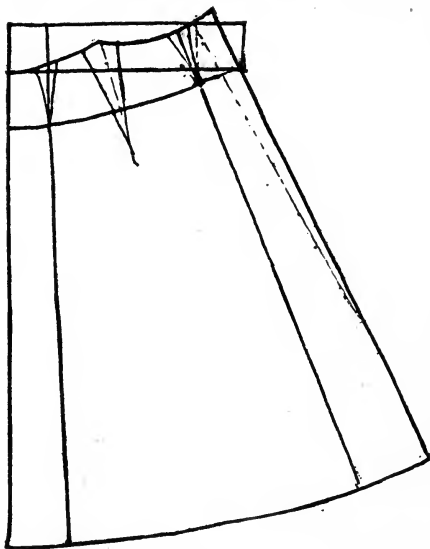

FIG. 111.—Four-gored skirt made from the foundation skirt draft.

It is advisable to take off slightly more on the bias edge of the gore than from the straight. Draw curved lines to hip.

IV. *To divide foundation draft into four-gored skirt* (see Fig. 111). Make division for front and back gores with dart off at waist as for six-gored division. One gore is left for the side. The hip dart is taken at the hip point of elevation and is carried down much deeper, about nine or ten inches. The slope for dart curves is calculated as for six-gored division.

V. *To divide foundation draft into five-gored skirt.*

Use the same division for back as for six-gored.

Combine the front and first gore. In order to reduce width of this combination gore move the hip seam forward one inch. This will increase the width of second gore. Make darts as suggested for six and four gored division.

With the above practice in division of this skirt outline it is possible to divide the space according to style into 7, 9, or 11 gores.

EXERCISES

1. What is drafting? What help is such knowledge in the use of commercial patterns?

2. Explain how measurements are taken for a nightdress; corset cover; petticoat; drawers.

3. What principles should be kept in mind in selecting a commercial pattern? How can one learn to interpret them?

4. Draft a pattern of a kimono gown for some one at home.

5. Draft pattern for drawers with full width leg.

6. Draft a foundation skirt pattern using the following measures:

Hip 40".

Lengths: Front 40"; Right hip 41½"; Left hip 41½"; Back 42".

Dart 6½".

Waist 24".

½ desired width of bottom 33½".

7. Draft a shirt waist and show how it can be changed for use as a nightdress. Use following measures:

Length of back 15".

Width of back 13".

Underarm 8½".

Length of front 16".

Neck $12\frac{1}{2}$ ".

Bust 36".

Waist 24".

Armhole 14".

8. Take the measurements of a corset cover which you like and draft a pattern.

9. From the foundation skirt draft make a pattern according to the prevailing style you desire.

CHAPTER XVI

CUTTING AND MAKING GARMENTS

Cutting of underwear and other garments. — Before cutting into material it is wise to lay all the pieces of the pattern on the cloth. A large flat surface is necessary. Much care and thought should be exercised in placing the pieces. When there is a nap or pile, it should run towards the bottom of the garment. See that flowers or figures all run one way, and be careful to match plaids so that where they meet at seams the prominent stripes match instead of meeting at angles to each other. If the material has a right and wrong side, care must be taken not to cut the parts all for one side of the garment, such as two sleeves for one arm. This can be avoided by folding the cloth with two right or two wrong sides together and cutting two at once, or by placing the right side of the portion cut to the right side of the material and using it for a pattern. When figures and right and wrong sides must be considered, careful planning is necessary and as a rule more cloth is needed, for the pieces cannot be placed as economically.

In placing the pieces be as saving as possible. The wide end of a gore or portion cuts to better advantage at the cut end of the cloth. Always remember the triple perforations representing half a skirt front or back portion of a waist must be placed on a fold of the cloth. Follow directions given on patterns for placing, as for instance the line of large single perforations on the warp.

Pin the parts carefully first where straight edges come,

and smooth carefully towards top and bottom and pin. Do not use too many pins. Cut on the line of pattern unless necessary to allow seams. Use long shears and cut with even edges. Mark the notches with a pencil, chalk, or basting thread. Never cut notches in cloth.

The fitting of undergarments. — Comparatively little fitting is necessary, if the measurements have been carefully taken and the commercial pattern altered or draft made for the individual. Care should be taken to have the armhole comfortable and in fitting the nightgown or corset cover, notice especially if this needs to be slashed in fitting and later cut out. The length of garments should be noticed especially, and all should be fitted loosely, as they will shrink somewhat in length and width when laundered. In fitting petticoats made from the commercial pattern, be sure the pattern is understood. If the hip is smaller than waist measure the hip seam must be taken in; if the pattern for the individual has a waist measure in proportion to its hip but larger than the waist of the person to be fitted, it must be fitted at the waistline. Drawers and combinations should be smoothly fitted over the hips so that no wrinkles will show through the outer garments.

SUGGESTED PROBLEMS IN SEWING

I. Simple machine work in preparation for more advanced machine sewing on garments.

1. *Pillow case.* — To be made of muslin of desired width. Practice in stitching can be had on the long seam at side and across end. Turn, baste, and stitch three-inch hem.

2. *Protecting cover for gowns.* — There are many simple patterns of this kind, from the bag with draw strings at the top to the oblong bag with turnover piece at top where hole

is left for the hanger. Such covers offer splendid opportunity for practice in stitching and are very useful. They can be used to cover gowns stored away in a closet or for light, perishable ones. Canton crêpe, unbleached muslin, lawn, and dimity are suitable. If made with a flap at the top, this turnover piece can be bound with tape or ribbon as can the hole at top where hanger protrudes, or edges can be hemmed.

3. *Aprons.* — Current magazines suggest many kinds of aprons which can be made by machine. The simple nurse's or maid's aprons offer opportunity for practice. The one-piece princess style is very useful for kitchen wear and can be made of tan or blue chambray or figured percales.

4. *Laundry or stocking bags.* — There are many varieties of such bags. Church fairs often have suggestive types. The bag with a draw string is very useful. The laundry bag can be extended at the top with a stick and a slit cut in the middle of the front side and bound. There are many possibilities in materials, and combinations of two kinds can be used for strength as well as artistic effect. Cretonnes and linens are strong enough for this purpose. The stocking bag can be made with a round or oval stiff pasteboard covered with the same material for the bottom, and the bag part arranged with pockets before it is attached.

5. *Traveling cases.* — Cases of linen lined with rubber or linen are very useful. They can be divided in partitions for hairpins, pins, combs, brush, powder, and other necessary articles. They can be bound with tape or white linen in contrast. A very nice present for a traveler is an outfit of cases. This is composed of three flat pieces bound or hemmed to cover over clothes in trays of trunk. They can be hemmed or bound by machine and marked with cross-stitch letters. Small bags for shoes and slippers also marked add to the set.

The flat case with partitions above mentioned completes the outfit.

Cases for rubbers are also very useful for traveling, and can be made by machine and decorated with cross- or feather-stitch.

6. *Other cases.* — Cases for flat silver can be made of long strips of cotton flannel in white or colored, partitioned and bound according to spaces desired. These can be rolled up and tied with a piece of ribbon or tape like the binding. Cases for centerpieces or doilies can be made of a flat piece of cretonne or linen with lining of same or contrasting color, and attach a round stick at one end of the strip so as to roll the doilies. This round stick may be a piece of broom handle. A space as a casing is left at one end and the stick slipped between the two thicknesses of material.

The above articles suggest some possibilities for machine practice. If one or more of the above are made, they may serve as gifts.

II. Problems which offer review of hand stitches learned in the grades (see Fig. 112).

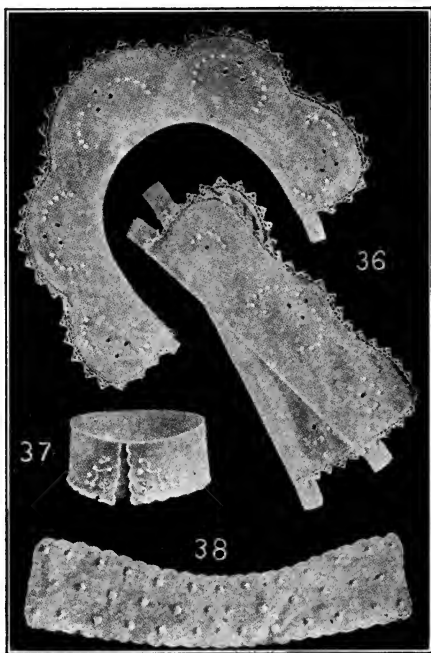

— Courtesy of J. McCutcheon.

FIG. 112. — Dainty neckwear.

1. Work bags.
2. Slipper bags.
3. Serving aprons, chafing-dish aprons.

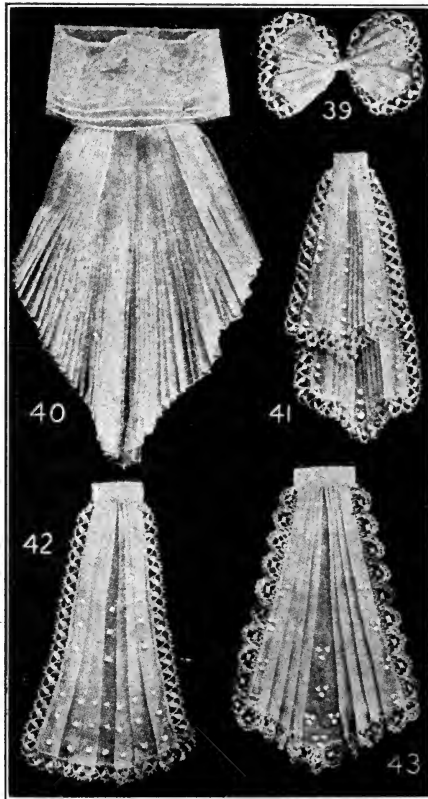

Courtesy of J. McCutcheon.

FIG. 112a. — Dainty neckwear.

4. Corset cover or Marguerite (see Fig. 115).

5. Jabots.

6. Collar and cuff sets.

7. Baby dresses and caps.

III. Garments to be made by machine or to offer practice in combination of hand and machine processes.

1. *Kimono night-dress*. — Use commercial or drafted pattern. The garment may be cut from $3\frac{1}{2}$ yards of material, 40 inches wide. Flat fell or French seams by machine. Hem three inches at bottom by hand or machine. Groups of tucks at yoke if too full. Trimmed at yoke with

flat trimming of lace insertion and edging or scant ruffle put on with bias bands. Bottom of sleeves trimmed to correspond

with yoke. (See description of lace as decoration, whipping, etc., Chapter XIII.)

2. *Drawers* (see Fig. 113).—Use drafted or commercial

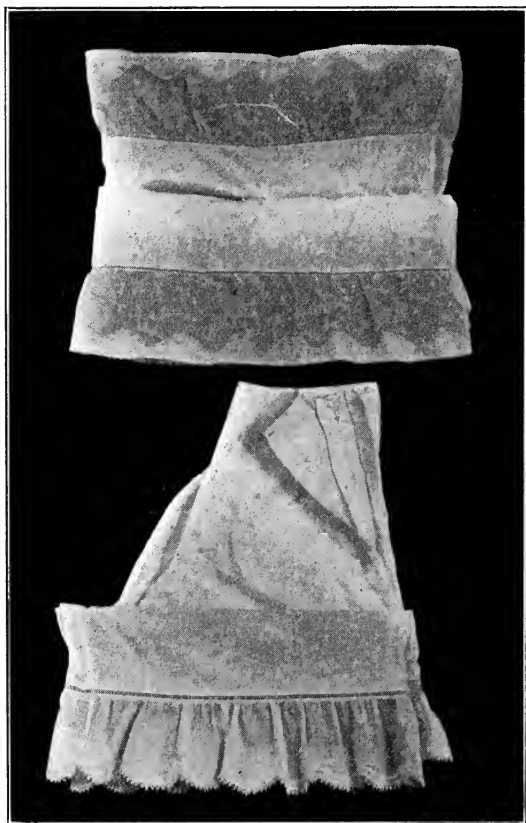

FIG. 113.—Drawers showing featherstitching.

pattern. $2\frac{1}{4}$ yards of cloth are necessary. Prepare ruffles with simple decoration of featherstitching (see decoration

and Figures 98 and 99), or ruffles with inserts of lace, or hem and lace edging. Ruffles should be one and one half times the width of space to be covered, or twice if much fullness is desired. Divide ruffles and drawers legs in quarters and adjust fullness evenly. These can be joined to bottom of legs as whipped ruffles joined with *entre deux* or bands of embroidery insertion. Bias bands or finishing braid may be used instead of a receiving tuck made at the bottom of each leg and turned over the rough edges of the seam. The legs and ruffles can be seamed separately and then joined, or the ruffles attached and seamed with the leg, using the flat-felled seam. The latter process is an easier method when the machine is used. By hand it is daintier to finish the ruffles separately and then attach them. Face the open drawers with a true bias facing $\frac{3}{4}$ of an inch finished. For closed drawers apply flat fell by hand or machine. The placket openings are cut according to draft, 1 inch to the back of center leg. Face opening with two-inch strip cut lengthwise of the cloth. This is basted around the entire opening and stitched in seam. Turn to the wrong side and stitch 1 inch wide half the length of the opening. The other side is finished by cutting away half of the width of facing less a seam and folding it back on the garment. This can be stitched or hemmed by hand. Take dart to fit figure over hips; use felled seams. Face top with same width facing. Tape can be run in or drawers lapped and two small buttonholes placed one below another.

3. *Chemise*. — Use commercial pattern or altered shirt waist draft. Twice the length desired plus material for ruffle is necessary. French seams by machine. One-inch hem at the bottom or ruffle by hand or machine. Trim at armholes or around low neck as desired. Embroidery beading, for ribbon with lace edge not too full, makes a neat

finish. Scalloping with eyelets for ribbons and feather-stitching makes an inexpensive and attractive trimming. Armholes should correspond with the neck finish.



FIG. 114. — Petticoat.

4. *Petticoat* (see Fig. 114).—Cut from five-gored skirt draft or commercial pattern; 4-4½ yards are required.

French seams by machine. Dust ruffle at bottom — width 4 inches finished. Cut across warp. Join widths (selvedges) with overhanding stitch. Finish bottom of ruffle with $\frac{1}{2}$ -inch hem. Join to bottom of skirt with receiving tuck $\frac{3}{8}$ inch wide sewed flat. (The receiving tuck covers the raw edges of the ruffle where attached to skirt with seam on right side of skirt, and leaves no raw edges on wrong side.) Prepare the overruffle. This may be from 6 inches to 10 inches or deeper and of embroidery or same material with inserts of lace, tucks, lace edging, as desired (see Fig. 114). This ruffle may also be of a finer or heavier quality of cloth. It can be hand scalloped or trimmed with featherstitching (see Fig. 113). Divide ruffle in quarters, quarter skirt, and baste so bottom of ruffle is $\frac{1}{8}$ inch above the bottom of the dust ruffle. To cover raw edge at top of ruffle a narrow bias band or finishing binding can be basted and stitched on both edges so as to lie flat. Embroidery beading for ribbon can also be used and is trimmed and stitched close at both edges. The top of ruffle can be finished also with a receiving tuck $\frac{3}{8}$ inch deep taken in skirt just above the raw edges of ruffle and turned down over them and stitched flat. To finish the top of skirt take darts to fit figure if necessary. Finish placket with straight strip 2 inches wide. This is made by starting the strip at the waistline with right side of strip to right side of skirt. Stitch and turn to wrong side and hem by hand. Lap at bottom of opening so it lies flat and backstitch across the bottom with slanting line of stitches. Instead of this facing, that suggested for drawers might be used. The back is without fullness and flat as possible. Finish top with $\frac{1}{2}$ -inch true bias facing of same cloth turned evenly with the top and stitched flat. Lap in back with three buttonholes, one at waist, two below on the placket lap.

5. *Satin or sateen petticoat.* — This can be made, involving the same principle as the above. The overruffle can be pinked or side plaited.

6. *Dressing sacque.* — Cut from commercial pattern. Lawn, crepon, dimity, or light madras. Seams French. Finish front with hems turned to wrong side, to lap down front. Bottom with narrow hem $\frac{1}{2}$ to 1 inch. Neck with flat trimming or collar as desired. Collar if attached joined to neck flat and finished with bias band $\frac{1}{2}$ inch basted on right side. Sew band and collar to sacque with same stitching, turn with even edge at neck and hem band flat on inside of the sacque. Finish bottom of sleeve with trimming to correspond with neck, cuff, or flat trimming. Seam sleeves with French seam. Sleeves put in with French seams. Place underarm seam of sleeve 2 to $2\frac{1}{2}$ inches to front from underarm seam of sacque. Baste with seam on right side, adjust gathers so they are distributed 2 inches back of shoulder and 4 inches to front of seam. Turn seam and finish with second sewing on wrong side. Baste before stitching.

7. *Corset cover* (see Fig. 115). — Cut from adapted shirt waist draft or commercial pattern. One and one half yards of cloth are necessary. French seam at shoulder and under arm — hand or machine. Front to lap right over left. On left make hem $\frac{3}{4}$ inch wide turned to wrong side. On right of front make turn to right as for hem. Stitch, featherstitch, or run by hand $\frac{1}{8}$ inch from each edge of front lap and edge of hem to hold in place. This makes lap for front buttons and buttonholes. If buttons are to be concealed, a doubled strip can be hemmed under right lap for the buttonholes. Even the bottom and finish with narrow hem. Gather at waistline center front and center back to fit figure. On inside under adjusted gathers baste narrow straight band $\frac{1}{4}$ inch wide. Stitch top and bottom. The waist can also

be finished with band on the outside or a row of beading. Top of cover can be gathered to fit figure, finished with *entre deux* and lace edging attached with beading or whipped ruffles (see Chap. XIII). Armhole finished to correspond.



FIG. 115. — Corset cover.

A very neat finish for neck and armholes of corset cover can be made by turning narrow hems $\frac{1}{8}$ inch wide to the right side first, and then turning back to the wrong side as for napery hem. Overhand. If lace or beading is to be added, it can be joined

at the same time. By this method no stitches are visible on the right side. Buttonholes should be placed lengthwise of the box plait. If a smoother fit is desired over the hips, a peplum can be drafted (see Fig. 108) and attached to the waistline of cover with seam on right side. The raw edges can be finished with a flat, straight band $\frac{1}{2}$ inch wide or a band of beading or lace insertion.



FIG. 116. — Nightdress.

8. *Nightdress with sleeves* (see Fig. 116). — Cut from adapted shirt waist draft or commercial pattern. Three widths of the desired length are necessary. Make flat felled seams at underarm and shoulder. Hem at bottom 2 inches. — Open

down front $\frac{1}{3}$ of distance from neck to floor. Face with placket facing as described for plackets of closed drawers. Finish both back and front with tucks according to fullness allowed. These can be made by hand or machine, as time permits. The high neck gown can be finished with band of embroidery insertion and tiny ruffle of lace. The sleeve trimming should correspond. Place sleeves in position and sew as for dressing sacque. A very neat, dainty finish for a low neck gown can be inexpensively made by using bias bands of lawn about one inch finished (Fig. 116). These can be attached around low neck and short sleeve with *entre deux* or simply stitched and turned to wrong side. Colored ribbon can be run through this casing. There are many other possible ways of finishing with long or short, gathered or loose sleeves. (See for descriptions of decorations of underwear, Chap. XIII.)

EXERCISES

1. What are the important points to bear in mind in the placing of patterns and cutting out of garments?
2. Give a few suggestions in relation to the fitting of underwear.
3. Describe the way in which a French seam is made on underwear; a felled seam.
4. How would you prepare the ruffles for drawers? Describe two methods of attaching them to the legs.
5. Describe the placing of the sleeve for a nightgown or dressing sacque.

CHAPTER XVII

EMBROIDERY

Suggestions for the study of the history of embroidery.

— All girls have interest at some time or other in embroidery. It is a satisfaction and a pleasure to be able to ornament one's gowns in a simple way, to make some household article more attractive, or to prepare simple gifts for friends. There are a few of the most common stitches which if learned in relation to proper placing, color, combination of stitches, and adaptation to material produce very pleasing results. It is interesting also to study in museums and books the relationship of the embroidery of to-day to the beautiful embroidered textiles of other centuries and embroideries from foreign lands. Embroidery is the enriching of textile fabrics and other materials with needlework. The art is an old one, and the most primitive people have made use of the needle in this way and do to-day. Among the relics of the Swiss Lake Dwellers have been found most crude needles to prove the antiquity of the art. In the museum at Cairo, Egypt, there are several fragments of linen woven in blues, greens, reds, and black and ornamented with needlework. The remains of Egyptian garments and mummy wrappings found in the tombs are most interesting. The lotus flower designs of Egypt are fascinating and one piece bears the name of the owner, of the fifteenth century B.C. In the British Museum in London, and the Louvre in Paris are to be found interesting pieces of old Assyrian and Persian embroideries dating back

to 485 B.C. Many of the Biblical writers of the Old Testament mention the use of ornamented textiles. Pliny in his writings mentions the embroidered garments of the Phrygians. The examples which remain of Roman embroideries of about the fifth century show figures, animals, birds, flowers, and foliage. The method of making was really weaving supplemented with decoration. Later the influence of the Christian era is seen in the work and the symbols used. There is also a greater choice of color. Later examples show pictorial Bible scenes. One notices in studying the history of embroidery the influence of the Byzantine style of the highly conventionalized forms. This lasted for several centuries until probably the thirteenth century.

There are also many interesting examples in museums of embroideries of the middle ages. While this work was used to adorn curtains, garments, and articles of household use, the pieces preserved were generally the vestments and ecclesiastical articles. The monks produced some of this work and much was made in convents, but there are records of the guilds of embroiderers of the middle ages. In England the art was a favorite employment for many centuries, and flourished especially during the thirteenth century.

Linens embroidered in wools, silks, and metallic embroidery were very beautiful. The famous Bayeux tapestry is 231 feet long and 20 inches in width. It depicts in embroidery in seventy-two scenes the conquest of England by the Normans. It is embroidered in worsteds in eight colors on linen which is now light brown from age.

There are many interesting examples of French embroidery characterized by great beauty. The schools of painting influenced the work of the embroiderers, and pictures were copied in great detail, showing draperies beautifully shaded, marbles, and architectural designs. There are also many

interesting samples of applique, where figures and designs have been cut from velvet and other materials and embroidered in places.

The embroideries of Italy show great skill and beauty. Many are worked in gold and silver and silks of many colors on wonderful materials of silk and velvet. The designs were often made by well-known artists. There are many beautiful examples also of appliqué, couching, and cutwork on linen. Some of the Sicilian examples are very interesting and follow those of Italy, in quilting and padding with wool to throw in relief the design.

Spanish embroideries reflect the influence of the Arabs' Oriental patterns, and many of the old German embroideries follow the Byzantine traditions.

Indian, Chinese, Turkish, and Persian embroideries date back to early times. Many of these are beautiful in texture and design. Some Indian and Turkish embroideries are enriched with pieces of glass, tinsel, and beetle wings. Chinese and Japanese embroideries are usually done in silk on a background of silk. Japanese designs are more pictorial in character, while the Chinese include dragons, birds, and flowers. The surface effects of some of the Chinese embroideries are often wonderfully smooth and regular. In the Persian embroideries of carpets, robes, and hangings, a preference is shown for floral designs. In the Victoria and Albert Museum is a beautiful linen prayer rug quilted and embroidered in chain stitch of silks in yellow, green, white, and red. The design is a floral one.

With the complexity of modern civilization the interest in the making of beautiful embroideries in England and America has somewhat subsided. The Royal School of Needlework in England is reviving the interest and there is much improvement over the seventeenth and eighteenth century

examples. The influence of the art of William Morris and Burne-Jones was felt in the embroidery of the nineteenth century and helped to improve the designs.

A FEW USEFUL EMBROIDERY STITCHES AND HOW TO MAKE THEM

Darning stitch is made with rows of even or uneven running stitches so placed that the stitches of alternate rows come under the spaces of the row above. Huckaback toweling is sometimes used as a basis for darning decoration. This is a useful way of filling in a space and making a figure stand out in relief (see Fig. 117).

Chain stitch is found on Oriental embroideries. The stitch resembles links of a chain. Designs can be outlined with this stitch or it can be used for filling in designs so as to bring them in relief as in Persian work. It is sometimes used simply in outlining or for filling in initials on towels or other articles before covering with satin stitch. It is made by bringing the needle to the right side on the line of work, holding thread with thumb of left hand and replacing needle in same hole from which thread was first drawn. Then the needle is drawn through loop formed. The loops should lie flat. In making this stitch the needle is brought up each time the same distance as the stitch from first hole. The stitches are even and are always taken in the loop of the chain, not below it. (See Fig. 117 for application.)

Blanket stitch is most useful and can be used for edges of scallops to prevent fraying, or other edge finishings. Wallachian embroidery is blanket stitch used to make relief designs rather than on edges. It is worked from left to right. The work is held with the edge towards the worker. The stitch is started with a few running stitches and the needle brought up close to the edge. Hold the thread under left

thumb and insert the needle at the depth desired, carrying needle up under edge and through the loop thus made. The thread should lie along the edge. This stitch can be varied to form ascending and descending groups or made all of one depth. *For scalloped edges*, which can be marked with a spool, it is wise to pad the scallop before using blanket stitch unless the thread used is very heavy. For padding, especially on flannel, run the outline of the scallop with small running stitch and near edge of scallop make one row of chain stitches. The blanket stitch is made over this padding, and the stitches are taken close together. Blanket stitch for blanket edge or other decorative purposes can be taken with spaces between stitches. This is a very useful and durable edge for towels or table linen. See Figure 117 for use of stitch for scalloping. See Figure 118 for other uses of blanket stitch.

Featherstitching is one of the most useful for purposes of ornamentation, and makes a beautiful and simple trimming. It is made in several varieties and is used to outline designs or in straight rows as at the top of a hem to hold it in place. It can be made with any kind or weight of thread in same or contrasting colors. When daintily made with white D.M.C. cotton, it is very effective on baby dresses and fine lingerie. While learning the stitch it is well to draw pencil marks or to run in a thread as a guide if the practice piece is not striped. The stitches are taken to the right and left of the line alternately. Bring the needle through on the line. Hold the thread down on line with left thumb. Insert needle for short slanting stitch to left of line pointing towards right. Draw needle through so thread looped will lie flat. Then with thread again on the line take slanting stitch at the right towards the left. The variations of stitch are made by taking two or three double or triple featherstitches, instead of one each side of the center line. The stitch must

be done very evenly to produce a pleasing effect, especially when used on curves. (See Fig. 117 for application.)

French knots are very often used with featherstitch for variation and additional ornamentation for the centers of flowers, and for filling in a space inclosed by outline or other stitch. Bring thread up through cloth in the place knot is to appear. Take a slight backstitch and with the needle protruding from cloth, wind thread around needle two or three times. Draw needle through, while holding coils of thread close with left thumb. Insert needle again on edge of coil in same place to hold securely. Pass needle without cutting thread to the next place where knot is to be made.

The lazy daisy stitch is also used with French knots and featherstitching on white work. The stitch is made by drawing needle to right side, forming a small loop of thread and replacing needle in same hole. The opposite end of the loop to the hole is caught with a tiny overstitch (see Fig. 97).

Outline stitch is one of the most common and useful. It is used to outline designs and the stitch is taken on the line. Care must be taken to throw the thread one way all the time in order that the effect may be regular. The stitch progresses from left to right. To begin, draw needle to right side on the line. Throw thread to one side, take backstitch on the line with needle pointing towards worker. This will make longer threads on the surface than the short back stitch beneath. Repeat. When the stitches are placed rather close together, the effect is prettier than when they are far apart. (See Fig. 117 for application.)

Cross-stitch is usually worked over open meshed canvas unless the material is so woven that the stitch can be regularly placed. If canvas is used as a guide, its threads can easily be withdrawn after the design is completed. This stitch is a useful one for marking linen (see Figs. 117 and 119)

or underwear and for fancy work. Baste the Penelo canvas very carefully in place so that the warp threads of the canvas lie on those of the fabric. The stitch consists of two slanting lines crossed. On the wrong side the stitches may be either horizontal or vertical. The canvas is so woven that the cross will be made over two threads high and two wide. Bring needle up to the right side at lower left corner of the square that the stitch would form if inclosed; pass thread slanting across the warp threads and take stitch, pointing needle towards the worker and on line with the warp. When thread is drawn through, a slanting line of half the cross is made. This can be repeated across a whole row, finishing the crosses by returning from right to left with the same vertical stitches. Care must be taken to have all the stitches cross in same way. All the ground stitches should run in one direction and all stitches crossing should run the opposite way (see Fig. 119).

Herringbone or catch stitch. — This stitch is useful for ornamentation or for holding down flannel edges which are liable to shrink in washing. It is made from left to right and resembles cross-stitch. While learning, a thread or line as guide is a help. The catch stitch is made of backstitches placed alternately above and below the guide line. The spaces between stitches should be the same and the stitches below opposite the spaces between those above. This arrangement causes the thread to slant and makes the cross. (See Fig. 117 for application.)

Satin stitch is used on all kinds of materials for ornamentation and in making initials on linen. It is an over-and-over stitch. Many people get the best results by working this stitch in a frame or embroidery hoop. If it is desirable to have the stitch high, it should be carefully padded with rows of chain or outline stitches running the opposite direc-

tion from the final satin or surface stitch. Padding is unnecessary if the thread is heavy. The needle is pointed from right to left of design, carrying the thread over and over and placing the stitches close together. The design can be followed from top to bottom or in the opposite direction. Care must be taken to place the needle always on the line of design. When single lines occur, an outline stitch may be used or the over-and-over, taking only a small hold of the cloth to produce a cordlike effect. This stitch is used a great deal on white work and also in colored silk embroidery (see Fig. 117).

Hemstitch is made after threads have been drawn at the top of a hem or tuck. Measure carefully twice the width of desired hem plus turning and draw three or four woof threads. Then baste hem carefully along line of first drawn thread. The hem should be held in a vertical position over the fingers of the left hand. Place needle in edge of hem and draw thread without a knot under the edge of the hem as for plain hemming. Throw thread away from worker and take up bundle of threads by passing needle under them and pointing it along edge of hem. Again pass needle under same bundle, but this time bring through the under cloth and edge of hem turned. There are several methods of hemstitching, but this is the most simple. Double hemstitching is made by catching the same bundle on the opposite side. The number of threads taken in a bundle will depend on the coarseness of the material.

Couching and appliqué.— Designs of contrasting colors can be cut from the material and applied to other fabrics with an overstitch taken around a couching cord placed at the edges of the figure. Couching is also used around the outline of designs without appliqué. The cord, which is drawn through a hole in the fabric made with a stiletto, follows the outline and should be kept perfectly flat. The

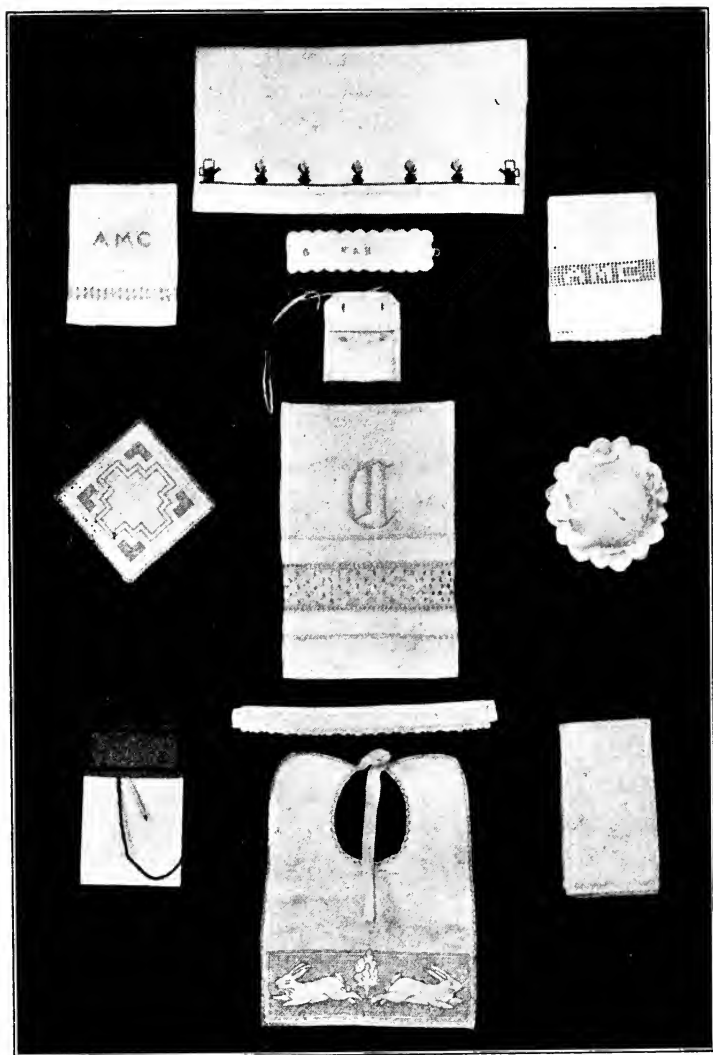

FIG. 117. — Articles showing use of embroidery stitches.

stitches holding the cord are taken from right to left. The needle is slanted, and in taking each new stitch the needle is placed directly opposite the spot where the thread was just drawn. This makes straight stitches at right angles to the cord and holds the cord and edge of applied material both in place (see Fig. 118).

A USEFUL EMBROIDERY EQUIPMENT

Small, sharp-pointed scissors.

A smooth thimble.

Princess embroidery hoop.

Embroidery standard for holding hoop.

Needles — crewel, round-eyed, and sail.

Embroidery magazines for designs and stitches.

Carbon paper, perforating machine, stamping powder.

A FEW USEFUL SUGGESTIONS FOR APPLYING THE ABOVE SKETCHES IN COMBINATION

Good designs are absolutely necessary in order to get good effects. It is wise to prepare these with the aid of the art instructor and suggestions found in embroidery and other magazines. In this way it is possible to prepare designs especially executed for the placing of certain stitches. Designs for dress embroidery especially must be carefully planned for placing and stitch. They can be transferred with carbon paper, or if the school has a perforating machine, the design can be perforated and transferred by rubbing stamping powder over it and then pressing with a hot iron.

1. **A child's bib** (see Fig. 117). — This is made from a small piece of huckaback 12" wide \times 16" long. The design of tree and rabbits was first transferred and then outlined with the outline stitch in dark blue D.M.C. cotton. Two rows of plain outlining form a frame about the picture. The back-

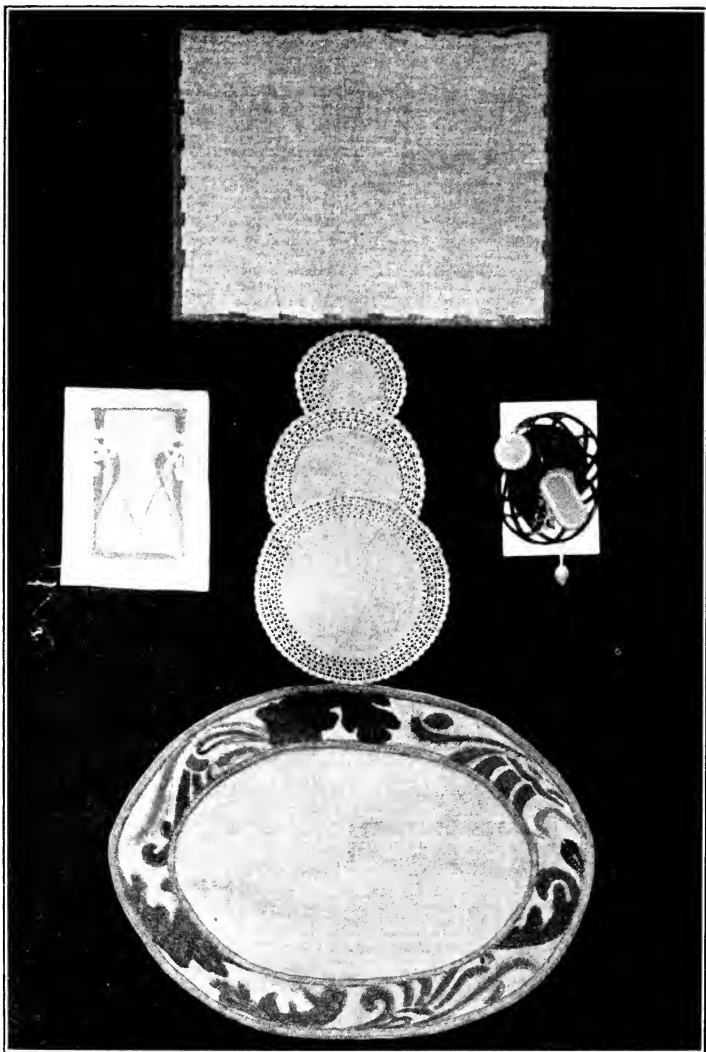

FIG. 118. — Articles showing use of embroidery stitches.

ground of running stitch was put in by catching the surface threads of the toweling. Simple featherstitch was used to hold the hem at edge. The neck was bound with white tape, which forms the tie ends, and the neck band featherstitched. This article gives practice in making three stitches.

2. **A simple cover for porch cushion** (see Fig. 118) can be made of Russian crash. A strip 1 yard long and about 16 inches wide will make one of good proportions. Hem one end with $\frac{1}{2}$ " hem and other with 1". Fold so that the one-inch lies on the half-inch hem. Baste carefully all around edge through two thicknesses. The cushion cover should be so folded that the opening where hems overlap is four inches from one end. The blanket stitch in block pattern is worked all around the edges on four sides and holds the two sides of the cushion together. It is completed with snaps sewed on the hems and can be stuffed with excelsior or feather cushion for porch use. Simple table runners and covers can be decorated at the edge with this stitch in same or different arrangement. The cushion in illustration is worked with a mercerized brown cotton (called "Poseidon") to harmonize with the linen crash.

3. **Napkin ring** (see Fig. 117). — This is made of a piece of white linen 8" long \times 2 $\frac{1}{4}$ " wide finished. Mark the scallops with a thimble or spool and work the blanket stitch close. D.M.C. embroidery cotton No. 25 can be used, or finer if linen is fine. Finish with loop and wash button and with or without initials in cross or satin stitch. The scallop can be run or stuffed with chain stitch before scalloping with blanket stitch. See also initial on towel for satin stitch.

4. **Towel with lace insertion.** — Large towels may be made from toweling 24 or 27 inches wide. One and one fourth yards will make a good sized towel. Cut from each end a piece 7 inches in depth and full width. At the ends of long

strip hemstitch one-inch hems. The seven-inch pieces can be turned to form double hemstitched ends of two inches wide toward bottom and one inch wide toward lace. Put together with bands of crocheted lace. This makes excellent practice in hemstitching (see Fig. 117).

5. **Three guest towels** (Fig. 117). — (a) The towel with cross-stitch lettering is made from a piece of toweling 16 inches wide and 27 inches long. The hemstitched hems are $1\frac{1}{4}$ inches wide, and a row of drawn work $\frac{3}{4}$ inch wide is made at one end and $\frac{1}{4}$ inch wide at the unlettered end.

(b) The second guest towel shown (Fig. 117) is made of a piece of striped toweling 16 inches wide and 27 inches long. The ends are turned with narrow hem and a blanket stitch taken over the hem. Stitches about $\frac{1}{8}$ inch apart. The crocheting is caught in this blanket stitch. The band with crocheted initials is put in in the same way.

(c) Hemstitched towel with cross-stitch border of flower pots (see Fig. 117). Huck toweling 16 inches wide and $\frac{3}{4}$ yard long. Jenny Brooks patterns and colored D.M.C. cotton were used. Hems at ends are one inch hemstitched.

6. **Linen bag with cross-stitch design** (see Fig. 119). — The old-fashioned smooth-finished brown linen was used for bag in illustration. A piece 28 inches long and 10 inches wide makes one of good proportions. Simple seams sewed with stitching stitch were made at sides, after cross-stitch designs were worked across one side of the bottom. Colored D.M.C. cotton and Jenny Brooks patterns were used. Measure hem for top two inches. Before hemstitching work row of cross-stitch across top, placing it so it will appear near top of finished bag. Then turn and hemstitch so no threads of wrong side show. Line with batiste of cream-color so that the seams of inner bag are turned in towards seams of outer bag. Catch with hemming stitch to the hemstitch-

ing with same brown thread. Any kind of cord can be crocheted and sewed below hemstitch for drawing up, or rings placed for cord.

7. **Table runner** with cross-stitch border across ends and sides (see Fig. 119). Gray tan linen $1\frac{3}{4}$ yards long and 14 inches wide. Hemstitch both ends, allow 3-inch hem. Jenny Brooks patterns and D.M.C. colored cotton thread were used. Border is placed near the edge.

8. **Oval centerpiece with appliqué** (see Fig. 118). — This piece for library table is of a good quality of Russian linen crash worked in colored linen thread and with pieces of colored linen cut out and applied in design. The pieces of the design are held in place with blanket stitches worked close together around edges of design in an irregular and regular height. The oval is 18" wide and 27" long. A narrow hem was placed around edge and a very close featherstitch in blue linen floss used to hold the hem. This row of featherstitch appears very solid and is outlined on both sides with outline stitch to make a band.

9. **Waist protector** (Fig. 117). — One yard or square of cheesecloth or silkoline. Hem turned and basted all around square and catch stitch used to hold in place. Cut hole in center for hook of waist hanger and bind with ribbon.

10. **Memorandum desk-pad** (Fig. 117). — Made from brown linen with design in chain stitch. The cardboard back of the pad is covered on both sides with brown linen overhanded at edges. The top portion for holding pad was decorated first with chain stitch and the edges folded over pad at corners and overhanded to the covered back. The chain is worked in heavy brown linen floss and pencil attached with a crocheted chain.

11. **Book cover**. — Book or magazine covers of linen or crash make useful gifts. A piece of linen $\frac{1}{2}$ yard in length,

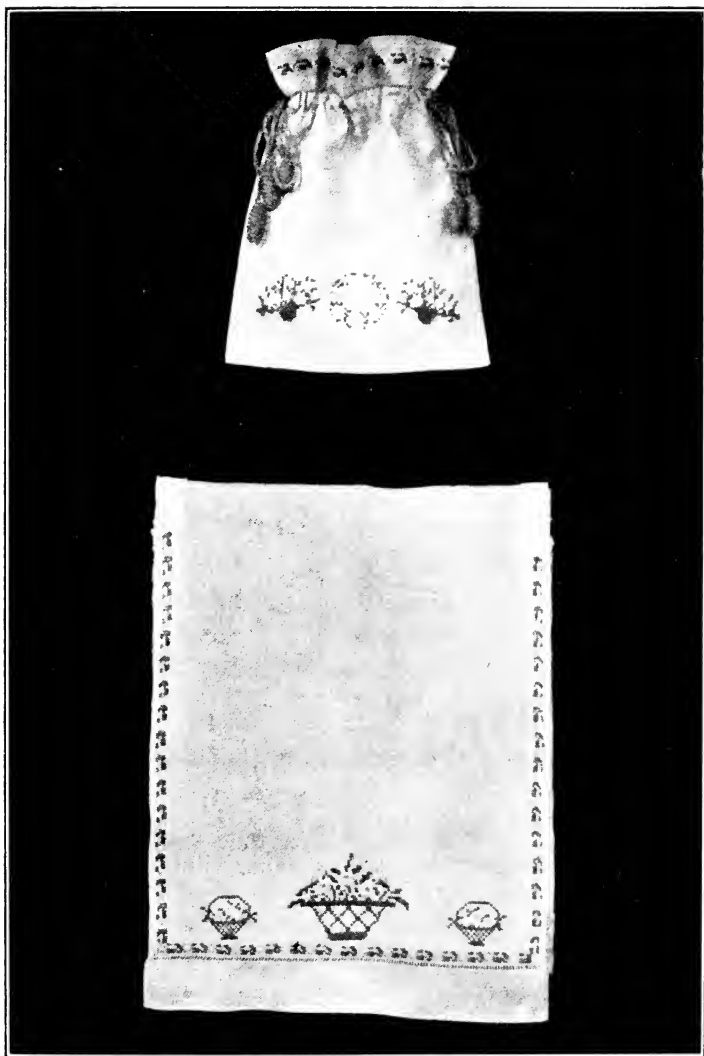

FIG. 119. — Articles showing use of embroidery stitches.

if about 22" wide, can be folded to make one of good shape (see Fig. 118). Hem all around four sides with $\frac{1}{4}$ " hem. Fold over $1\frac{1}{2}$ " top and bottom. At sides fold about $2\frac{1}{2}$ ". Overhand lapped ends. Place design on front cover. The one in illustration is of gray-blue linen worked in two values of blue. Stitches used are satin, outline, and darning.

12. **Doilies and centerpiece with crocheted borders** (see Fig. 118). — Made of brown linen. Edges turned and basted for first turn. Turned and hemmed for second turn. This care makes good, even edge. Blanket stitch is made in edge of the hem with stitches $\frac{1}{4}$ " apart. Crocheting is caught in loops of blanket stitch. An easy way to cut circles the correct size is to take the three sized plates and place on cardboard; mark with pencil and cut out patterns.

13. **Small doily** (see Fig. 117). — Made of two thicknesses of linen for asbestos mat between. Design in outline stitch in blue D.M.C. cotton. Centers of corner pieces of design darned and outlined. Blanket stitch in linen-colored floss at edge to hold two pieces together. Narrow lace overhanded around edge. Selvedge is used on one side of lining piece where it is left loose.

14. **Small work basket** (see Fig. 118). — Equipped with pin disk, emery, and needlebook with featherstitch design.

15. **Turnover collar** (see Fig. 117). — Design worked in satin stitch.

16. **Cushion cover** (see Fig. 117). — Two circles, white linen, 7" in diameter. Scalloped edges with blanket stitch in white D.M.C. cotton. Initial worked in satin stitch (white). Eight eyelets $\frac{1}{4}$ " spaced evenly $\frac{3}{4}$ " from edge.

17. **Linen money bag**. — This little case is very useful when one is traveling. It has an inner case of chamois which can be replaced, and the outer covering can be laundered. It is made of a piece of fine white linen $8\frac{1}{2}$ " long \times $4\frac{3}{4}$ " wide.

Hemstitch across one narrow end $\frac{3}{8}$ " deep. Hem sides with fine hemming stitches; hem $\frac{3}{8}$ " wide on both sides. Shape the other narrow side and hem with same width hem. Featherstitch below hem. Fold and overhand sides. Place two buttonholes and two buttons (see Fig. 117).

EXERCISES

1. Bring from home samples of old hand embroideries of grandmother's time: samplers, lace collars, etc. Have school exhibit.

2. Bring any samples of old textiles with good designs. If possible, mount for permanent school exhibit.

3. Collect from current magazines good designs and suggestions for embroidery problems. File in classroom in systematic way with aid of household arts teacher. Such suggestions will be useful for the whole class and following classes.

4. If museum is near, plan trip alone or with class to see old textiles, laces, and embroideries. Suggestions may be found for use in school.

5. Bring in trial samples of five stitches described in the text.

6. Plan with original design a Christmas or birthday gift costing only 15 cents, on which some of the embroidery stitches are to be used.

7. Look up information about the Bayeux tapestry.

8. Trace the historical use of some of our common embroidery stitches.

9. Describe two ways of transferring designs.

10. Name some of the common embroidery flosses and threads, and needles for carrying them.

DRESS

CHAPTER XVIII

HISTORY OF COSTUME

THE history of costume from ancient to modern times forms a most interesting study to one considering the importance of dress and the adaptation of costume design to the individual. Few appreciate the fact that apparently there is "nothing new under the sun" and our present styles are adaptations of the dress of olden times. One should be able to recognize in modern dress the styles of the periods from which they were derived, and the study of costume should teach one to apply such knowledge in attempting to improve modern styles of dress.

Much of the knowledge of very early costume has been obtained from the ancient hieroglyphics, paintings, illuminations, and sculptures. The old tombs with their designs have furnished a great deal, and we are indebted to the Egyptians, Grecians, Romans, Early Gauls, and Franks for much that is beautiful in costume. Regular fashion sheets, however, have been in vogue only since about the time of the French Revolution, so this history from books does not date very far back.

Egyptian costume. — The history of costume of any country is always closely associated with the history of its political life. The Asiatic conquests made Egypt politically su-

preme, and with the new era of luxury the earlier simplicity of dress gave way to more attention to the outward appearance. We are indebted to Egypt for good color, design, and ornament.

The costume in Egypt during the early dynasties was simple and the material very coarse. Hieroglyphics of that period show the men wearing a short skirt made of stiff, coarse material, which was practically a loin cloth. The waist was omitted. There was some variation of this in relation

to classes. Among the upper classes the skirt was made to stand out in triangular form in front. During a period of some two or three hundred years following, changes took place and the costume developed. The skirt apparently lengthened and widened, the materials were more transparent and less stiff. From the IVth to the XVIIIth Dynasty the dress of the women was a straight, tight tunic of diaphanous material kept up by means of braces over the shoulders and exposing the breasts. Servants wore a short skirt for freedom of movement,

leaving the upper portion of the body bare. A very interesting fact is that the men's costume during this period showed many changes. The thin material of which the costumes were made led to the adoption of an underskirt. Beginning with the XVIIIth Dynasty a distinct change may be traced



FIG. 120.— Egyptian costume.

— the shirt or waist was added. This garment opened on the right side and had a sleeve for the left arm; the under-skirt was changed in length and the outer skirt looped or draped to show it. This was probably the beginning of draperies. During the XIXth Dynasty this puffing was omitted on the outer skirts, both were often full and plaited, and about the XXth Dynasty panels or aprons were added for ornamentation (see Fig. 120). Garments became more numerous; mantles and capes were worn and flowing sleeves and plaited skirts apparently adopted. Elaborate headdresses, made necessary by the great heat of the country, were an important part of the costume. Their decoration and the color and ornamentation, which included the use of the lotus flower, the asp, and many other interesting symbols, offer much which is beautiful in design and worthy of adaptation in our present costume.

Greek costume. — The Grecians in their dress improved on the ideas acquired from the East and adapted them to their needs and social life. The women of Early Greece wore rather tight-fitting waists, — somewhat like the kimono waists of to-day, — with full skirts. Illustrations show that the garments of the men were long tunics and mantles. When we speak of the “Greek dress,” with its charm and simplicity of line, we do not mean this early costume.

The Greek dress of men and women did not differ in principle, but the women made certain additions, such as veils and ornaments for the hair.

There were two garments in the costume, the chiton or dress, and the mantle, called the himation. The Greek women did their own weaving and each garment as woven was complete, for it was worn without being cut and sewed, simply held together, when arranged, with clasps or pins. Authorities differ as to whether the garments were all sewed

or all pinned, or some sewed and some pinned. The question remains unsettled. The Doric chiton differed from the Ionic in being simpler. It was scant and fell in a few large folds. The material was rather heavy. The Ionic appeared more elaborate, for it was made of much thinner material



FIG. 121. — Grecian costume of mourning woman.



Courtesy of Liberty Theater.

FIG. 122. — Showing the contrast to Grecian costume which conforms to lines of the figure. Period of 1885.

and a very large oblong, so that the fullness arranged itself in many small folds. The general shape of both was the same — rectangular. The Doric dress was about a foot longer than the person was tall and as wide as the distance from tip to tip of the hands with arms outstretched. The foot of extra length was folded over, and the whole piece doubled in the center and folded about the body. It was pinned together on each shoulder, so the

garment remained open on one side. A girdle bound the waist and the fullness of cloth concealed the opening. If the garment was too long, the extra length was allowed to blouse over the girdle. The Ionic, while the same shape, was much larger.

The outer garment was cut either rectangular or square as the fancy of the wearer dictated. The women usually arranged theirs more elaborately. The regular manner of wearing was this: the upper left-hand corner was brought over the left shoulder and tucked under the arm; the other upper corner was brought around under the right arm, draped across the body, and thrown over the left shoulder. This completely covered the body and permitted only the right arm to be free. This arrangement caused the mantle to fall in many folds and gave grace and dignity to the figure. (See Fig. 121 for the graceful folds.)

The men wore their hair rather long and the women arranged theirs in a simple knot at the back. This was adorned often with diadems, fillets, and jeweled ornaments. The head covering was the veil or a part of the mantle.

Roman costume was adopted from the Greeks. For men the tunic or undergarment worn was somewhat like the Greek chiton. The toga, the national dress, was the outer garment or mantle. Women wore the "palla" and "stola." The stola was a long tunic with a dark border of ornamentation or fitted piece at the bottom. It usually had sleeves. The palla was the mantle, used in many cases, like the Grecian himation, as a head covering. The toga for the Roman citizen was white and made of fine, expensive material, but the color was varied for generals and emperors. It was a piece of woolen material generally elliptical in shape and arranged somewhat as the Grecian himation according to fashion or the taste of the wearer. The outer garment of

the poorer classes was made of heavier, more somber woolen material. Roman costume was more ornamented than the Grecian and fuller in drapery. In 55 B.C. Cæsar conquered the Gauls, who in time became Romanized. It is interesting to trace the development of the costume of the early Gauls. Their painted and tattooed bodies of early times, the skins of animals, the hip aprons, were all succeeded later by the tunic, trousers, and mantle which they wore when conquered. If they became Roman citizens, the toga was permitted. Their garments were rich in beautiful ornamentation of embroidery and color worn with a great deal of barbaric jewelry. After the complete conquest of the Gallo-Romans by the Franks in the fifth century and the establishment of the French kingdom, a combination of Roman, Gallic, and Frankish costume for men was adopted, consisting of a tunic, short trousers, leggings, and a mantle, the last varying in size according to use.

French costume. — The eighth century was practically the beginning of French costume, and among the higher classes there was some variety of dress. The women wore two tunics. The under one was straight, long, and narrow, and the outer full and short. Mantles and bands on the gowns were also worn, and veils, of which they were very proud. The costume of the men was much as before. Jewels and embroidery were used for decoration on all the garments. Under Charlemagne, 768–814, there were edicts against luxury. Later the materials worn were heavier. Men wore the inner garments of linen and the outer tunic of wool bound with silk, and the mantles, short for everyday life, but long for ceremony. With the beginning of the age of chivalry (eleventh century), silks, cashmeres, and velours were introduced by the returning crusaders. Buttons appeared for the first time. Men adopted garments which were

long and full, making them look much like the women, who also added fullness to their costumes. Veils were shorter and bands were worn around the head by the women.

The last of the middle ages, while the Hundred Years' War was going on, garments were more fitted and often made of two colors. The tunic was called a surcoat. It was usually made without sleeves and worn over a closely fitting under dress, which had long, close sleeves.

At the last of the fourteenth century came a period of luxury. The garments for men were characterized by the doublet and hose, the latter being trousers and stockings in one. The sleeves of the doublet were large and often reached to the ground. This century is noted for its eccentricities of dress. The very pointed shoes and high, pointed headdress harmonized with the turrets and towers of the Gothic architecture of that period. In the fifteenth century, during the reign of Louis XI, dress was more simple for both men and women, and under Louis XII, influenced by Queen Anne of Brittany, dress although of exceedingly rich materials showed more dignity, simplicity, and charm than ever before. At the death of Charles VIII, whom Anne had first married, black for mourning was introduced by her. She was also responsible for the close-fitting headdress, which she brought from her own country. The French costume of the last of the fifteenth century was characterized by the use of rich materials, bright colors, and greater dignity and grace of line. It lacked the eccentricities of the former period and marked the beginning of the French Renaissance, which bloomed in all its glory under Francis I a few years later.

The sixteenth century, the period of the Renaissance, is marked by a great change in dress. Many innovations were introduced; distinctly different garments were worn by men and women. This period saw the beginning of

crinoline, of hoops and corsets for women. They wore a chemise of linen, a corset not boned like the corset, of to-day, but made of several thicknesses of heavy material fitting the figure very closely, a hoop of heavy canvas, and over these a bodice with pointed waistline, front panel to cover the hoop, and a dress or robe which fell in tube-like folds to the floor. The headdress was still small. The men wore a chemise, a heavily embroidered doublet, short, full trousers, hose, and a mantle with big sleeves. The garments of both men and women were much slashed, and contrasting colors were introduced. Henry II married an Italian princess, Catherine de' Medici, who brought the corset from Italy; also introduced the ruff, which became exceedingly popular and was worn by both men and women.

During the reign of Henry II and his sons, Francis II and Charles IX, costume, while elegant and richly embroidered, was less slashed and the general lines were simpler. However, Henry III, aided by his sister, Marguerite of Valois, encouraged elaborate dress, and many men adopted feminine fashions, wearing enormous ruffs and tight corsets.

During the reign of Henry IV and Marguerite de Valois the hoop skirt, formerly A-shaped, was changed and with the aid of pads became barrel-shaped and so large that the arms rested upon it. The waists were smaller and more pointed and padded and puffed; sleeves with very large ruffs completed a ridiculous silhouette. The corset had become a true instrument of torture, as is attested by the models in museums, and very small waists were the fashion.

The reign of Louis XIII and Anne of Austria brought a decided change. Spanish fashions replaced Italian ones for women. Hoops, paddings, and ruffs were discarded and the costume became more graceful. The overskirts were draped to show the under, and bodices were no longer exceedingly

tight and pointed. Sleeves were large with deep cuffs. The collar was flat instead of arranged as a ruff, and the hair was done low, with curls about the face.

Similar but more elaborate styles were worn during the reign of Louis XIV. Among the accessions were small muffs for both men and women. Gowns showed again the pointed waistline; they had very low necks and short sleeves; no hoops were worn, but skirts were much draped, and stiff materials worn at the back marked the introduction of the bustle. Much lace and ribbon were used for decoration on waists and skirts. About 1680 a new headdress was introduced and remained in favor thirty years. The story told is that a lady of the court had lost her hat and had used her garter, made of lace and ribbon, to bind her hair. The king complimented her, and immediately her example was followed, and an enormous headdress was introduced that sometimes reached two feet in height. In 1711, just before the end of Louis XIV's long reign, hoops were again revived and soon became very large. They were called "pannier" and lasted until the French Revolution.

The eighteenth century was characterized by its grace. The charming "watteau" costumes and the lovely pompadour silks were worn with the "pannier," which constantly increased in size. Gowns were much decorated with lace, ribbons, puffings, and flouncings, but lacked the heaviness which had marked the profuse ornamentation of the preceding century. Beautiful but tragic Marie Antoinette next occupied with Louis XVI the tottering throne of France and became absolute queen of fashion (see Fig. 123). Under her sway enormous hoops and equally enormous headdresses were worn. The watteau fashions were still in vogue, but only for informal occasions. Near the end of the century, as the Revolution was beginning, English fashions were

adopted — the waistcoat and redingote with triple lapels, wide collars, and large hats.

Fashions changed rapidly during the ten years of the French Revolution. At first styles and materials became simpler, but with the Directorate (1795–1799) there came an unexpected

reaction. Soft, transparent materials were used, and the Greek and Roman costumes were copied by women but in an exaggerated way, while the men wore large cravats, lapels, and collars in imitation of the English. By 1799, at the beginning of the consulate, the ancient costumes were still being copied, but in a more modest way. Transparencies were no longer worn. Shawls were introduced from Egypt and costumes were

simpler (see Fig. 124). The costumes of the time of Napoleon and Josephine (1804–1815), which we now call Empire, were revivals of the same Greek fashions (see Fig. 125). The dresses had short waists, long skirts, low necks, and usually short, puffy sleeves. With these transparent shawls were used.



FIG. 123. — Marie Antoinette.

The period of 1815–1830, called the Restoration, was marked by the return of stays or corsets. Fashions were exceedingly ugly; street dresses were long and ball gowns were short; both were elaborately trimmed. Hair dressing, which had been simple under the Empire, now became absurd, and it is said that during these fifteen years 10,000 different shapes in hats and bonnets appeared, all very ugly.



FIG. 124. — Costume of period of Louis XVI. Directoire, 1798–1799.



FIG. 125. — Ball costume of 1800–1801. (Empire.)

Later, gowns were cut with low necks and long shoulders. Small waists and large, bell-shaped sleeves were in vogue. The period around 1850 is marked as one of luxury and extravagance of rich trimmings and materials (see Fig. 126). In 1854 hoops had returned. The polonaise was introduced with triple flounces on skirts. From that time to about 1870

there followed a period of luxury and hideous costumes for women. There were many changes with flounces and wide circular wraps. Hoop skirts of steel and crinoline were much used, and violent color contrasts were common. By 1870 skirts became smaller, hoops disappeared, and we find the lines



FIG. 126. — Costume of period about 1850.

of gowns more modest and dignified, following more the outline of the figure. Exaggeration and vulgarity were no longer prevalent. From then to 1880 dress was more simple and graceful. Gloves were generally adopted and materials were many, rich, and beautiful. From 1880–1900 there was greater originality developed in dress and more good taste.

Bustles and pads were common for a time (see Fig. 122), "leg of mutton" sleeves and boleros were at times popular, but it was a period of improvement. During the last ten years, dress has generally been simpler, more beautiful, and in better taste. The changes have been many, but the novelties have not lasted long. More intelligence and thought have been given in the adaptation of the best of the costumes of the past to the needs of to-day.

Thus we have a story of progress from the tattooing and decoration of the body of primitive man to the various combinations in color and form of modern dress. The tendencies of other generations can be studied in dress as well as in architecture and language. Certain tendencies in dress, characterized usually by flowing robes, have been noted in days of peace, while girdled garments of close cut were preferred by the warlike nations. In this history of dress, color has always played an important part, and Southern Europe has in its dress been characterized by its harmonious masses of color. Rank and power have been shown by dress; the ladies, the cavalier, the court fool, the judge, the monk, the maid, all varied the styles in relation to their position. The ceremonials of royalty, the pageants, and displays were all rich in color and variety of dress,—a constant panorama. In modern dress many individual distinctions have been lost, and with them much that was beautiful has passed away. Intelligent thought and art are continually reviving from the past styles those adapted to modern needs.

EXERCISES

1. Of what value is the study of the history of costume? How has much of the knowledge of early costume been obtained? Of later costume?
2. What were the characteristics of Egyptian costume? What use is made to-day of Egyptian contributions to costume?
3. What is meant by the charm of Greek dress? Describe the two principal garments. What was the Roman toga?
4. Describe the innovations in costume of the period of the Renaissance. What were the styles of the time of Louis XIV? Describe the changes in fashion during the ten years of the French Revolution.
5. Trace the influence of Greek costume during the various periods of dress. What has this study to do with modern dress designing?

CHAPTER XIX

COSTUME DESIGN

The importance of artistic dress. — The subject of dress is one of importance. Our garments are not a meaningless covering; they speak loudly for us or against us, not only to our friends but to the most casual observer. They have the power to make us look conspicuous, absurd, undignified, and to magnify our physical imperfections. They have also the power to make us feel comfortable and at ease. The consciousness of a costume which is appropriate and becoming tends to lend added charm and grace to the figure and develop an ease of manner that enhances the individual charms. Notice the lack of self-respect and charm in the slovenly, untidy, unbecoming attire of some women. Garments have also the power to caricature. A really well-dressed woman is never conspicuous. Young girls in learning to plan their wardrobes and in selecting styles and materials for hats, gowns, and wraps should study carefully the requirements of dress and learn to adapt the prevailing styles to their individual charms and defects. It is worth while to study the modeling of the face and the lines of the form to make the best use of our possibilities in every way — to do justice to ourselves in the selection of clothing, in personal cleanliness which is beauty, and in the arrangement of the hair. It is woman's duty to be as beautiful as possible, and "fine feathers make fine birds" if the "feathers" have been adapted to the lines, coloring, hair, and silhouette of the individual. The costume should be considered as a beautiful

painting or work of art and much thought should be given to choosing wisely in order that this added beauty may be given to friends and the world. Every girl has an individual style that should be studied and carefully developed. These being the facts, we should use intelligent thought in making our costume serve us.

The requirements of dress. — From the artistic standpoint the first question to be asked in regard to a costume is, does it to the greatest possible degree enhance the charm of the wearer? Of the truly artistic costume it will not be said "what a beautiful gown that woman is wearing," but "what a beautiful woman." In this desirable result the gown plays a large part. A gown may be beautiful in itself but so strong in its color or so striking in its design that it asserts itself above the wearer with unpleasant results. Some can wear successfully more striking costumes than others. With colorless hair, faded eyes, and an insignificant figure, it is an easy matter to don a gown that will cause the wearer to sink into insignificance, while the same gown on a woman of strong characteristics, of dark hair, and strong color might keep its proper secondary place. If the gown keeps a subordinate place, it must be harmonious and restful in color and design, for ugly, inharmonious elements attract the attention and annoy the eye. Before selecting conspicuous plaids or using violent color contrasts (which if used in large masses are usually unpleasant), it is well to consider this principle, bearing in mind that if the costume is to be pleasant to look upon, or if it is to hold the eye pleasantly, for any length of time, it must be entirely free from disturbing and unrelated elements.

Unity. — A second point for consideration is that of unity, for no costume will be successful that violates this principle. Not only must the hat and gown have unity, but the woman

and her costume must be so closely connected in a fine relation of line and color that they are no more to be separated than a bird from its feathers. In whatever nature clothes, we find this unity. The subordinate relation of the costume to the wearer and the unity of the whole is a result of the study of art principles; for dress design is first of all an art problem. Like all objects, costumes have shape, lines, dark and light, and color. When these are finely related, we have the artistic costume; when not, the commonplace.

As the outline or *silhouette* of the figure is seen by a greater number of people than the lines within the costume, it is of first importance that the outline be pleasing. The human figure with its matchless lines and subtle curves possesses the greatest beauty in creation. In judging the silhouette of a woman as she appears on the street, compare the outline, as it is presented, with that of the human figure. While it may not be desirable that its lines reproduce those of the figure, yet they must not contradict or falsify them, but be in harmony and all "sing together." In the outline of the costume, the lines must flow rhythmically one just into another and not present a series of jerks and angles. A thin neck, for instance, should not be emphasized by the décolleté gown, French necks, and Dutch collars, which draw attention to the hard lines of the throat. "Improvements" on the feminine figure, such as bustles, hoops, puffs, and pinched waists, have not only failed to add either to its beauty or grace, but have given the figure a silhouette broken, angular, and without rhythm or charm (see Fig. 122). The figure must also present a balanced silhouette. In this respect, too, consider the figure itself, remembering that it is created for movements and must preserve a balance in action. As figures differ in their proportions, the matter of balance is an individual problem. Usually a small hat presents a better

balance than a large one when worn with a short, close-fitting walking skirt, because the short skirt apparently decreases the height of the figure, and also because there is insufficient width at the base to balance the width of the large hat (see Fig. 127). The large hat is usually best adapted to the long



FIG. 127.—Showing difference in balance of large and small hats with short skirts.

skirt, which adds to the apparent height of the figure. Such a hat is even better balanced by a gown with a train to broaden the foundation of the figure. As the first consideration in the selection of a hat should be its becomingness to the figure, it should be selected when standing at a little distance from a long mirror, and when wearing the costume for which it is

designed, in order that the figure may make a pleasing and well-balanced outline. The hat itself ought always to appear to be balanced on the head both in shape and in placing of the trimmings. A hat with feathers or other trimmings massed on one side should have extra emphasis in width or in turn of the brim on the other, to preserve this balance, that it may appear poised on the head and not held in place only by the use of hat pins.

A good *design* in costume, as in all design, has a fine relation of spaces. The surface of the gown is broken into spaces by lines — bands of trimming, rows of buttons, seams, etc. For an artistic result there must be a plan, an idea carried out in the entire costume to give an orderly arrangement of these lines. Lines of equal strength running in various directions without “rhyme or reason,” beginning nowhere and ending nowhere, will never produce an artistic result. For example, a gown which has a band of trimming arranged in points on the skirt, placed horizontally on the sleeves, and in a curve around the yoke, presents a disorderly design, confusing to the eye. If the band on the skirt were placed horizontally, corresponding with those on the sleeves, and the band outlining the yoke omitted, it would give a design, the principal lines of which make a repetition of horizontal lines, and the then inconspicuous line of the yoke would introduce a pleasing element of difference in so subordinate a relation as not to destroy the rhythm. The merit of the design would depend on the fineness of the relation of these lines and of the spaces made by them.

Dark and light “value.” — A costume of black and white is very pleasing when well carried out. Black and white, being exact opposites, are not easily reconciled, and a “spotty” effect is frequently the result of their combination; as, for example, in a costume where the gown is white, the hat,

gloves, and shoes black. In such a costume the eye jumps from one spot of black to another and finds no resting place (see Figs. 128 and 129). If with the white gown were worn white shoes and gloves, the black hat pleasingly trimmed with white, thus carrying the white into the region of the black



FIG. 128. — Spotty effect. The eye jumps from one spot to another.



FIG. 129. — This effect is more pleasing and is not spotty.

and that of the black into the white by perhaps a black velvet bow at the throat, the darks would then be massed near the face, giving a spot of sufficient emphasis to hold and rest the eye. Another way of holding the black and white together is to introduce an intermediate step; for example, a black skirt with a black chiffon waist made upon white gives a transition in "value" from the black skirt to the white of the yoke and collar, making the step from the white to the black less violent. An intermediate value may also

be introduced by a touch of color. The black and the white should not be of equal areas; let one or the other predominate. The black skirt and white shirt waist may be improved by a black tie, the two spots of black then predominating over the one of white. Pure white, although distinguished, lacks softness; costumes in chalk, oyster, and so-called old ivory have a soft charm. In line, in values, and in color it must be made easy for the mind and the eye to grasp the intention, the plan; they must not be forced to jump from spot to spot. Pleasure will result from a restful harmony, but not from confusion.

Value in color. — Value exists in all colors with their gradations from light to dark. With values closer together, the contrast is less striking than in black and white, and the harmony less difficult.

In selecting the color for a costume consider first its wearer, for it is in the color, even more than the design, that the appearance may be improved or injured. A color should always be of sufficient "grayness" to allow the individual characteristics to stand forth. This grayness varies according to the strength of the characteristics of the wearer, but it must always be sufficiently dull to form a background — a setting for the face and to show the figure to the best advantage. This question of color is one of great importance not only to the wearer but to all with whom she comes in contact. It is an outer expression of refinement and culture, and every girl should desire to have this true appreciation of color harmony.

This brings us to a consideration of "chroma," or the intensity or brilliancy of a color. A full, intense note of color is the strongest, loudest possible expression of the color. A full red says "red" to the human intelligence as powerfully as red can be said; it is insistent and exciting. Few

people have sufficient vitality to stand against a red gown of full intensity. Only a person of striking characteristics, strong personality, and a small figure (as the mass of red would then be comparatively small) could hope to wear such a gown successfully. A red which has lost more than half its strength — a gray red, a dark red, or a light value of red (pink) — can be worn by a greater number of people, as it intrudes itself less forcefully and is less overwhelming. The same holds true of the other colors, only in a somewhat less degree, as red is the most aggressive, but it will always be found wise to use colors in full strength or nearly so only for touches of color on a gown which is in itself far from full intensity. Blue is a retreating color, cooling and quieting. Because of its retreating nature, blue is adapted to larger figures than red; it is also suited to those not having pronounced features. It will be found that blues which have lost at least half of their strength, which do not say “blue” as strongly as it may be said, but rather *suggest* blue, are most interesting and becoming for the entire costume. Yellow is nearest light, and in combination with red, which gives orange, out of which come the browns, it is rich and warm in effect. Green, the combination of yellow with blue, combines the characteristics of each. It is light, and cheer, and calmness mixed. It is restful, soothing, and hopeful. More cheer will be found in the greens in which yellow predominates, and more calmness and poise in those dominated by blue. Violet gives the combination of the exciting quality of red, cooled and calmed by the blue. It is a color full of interest, particularly in its subdued tones.

Color harmony. — In determining a color scheme for a costume, think about the dominant color and endeavor to bring the others into harmony with it. Whatever tends to bring colors together and to diminish opposition tends

toward harmony. Harmonizing colors, like harmony of line, is a matter of appreciation, but a few suggestions may be helpful.

1. Contrasting colors may be harmonized in a subordinate relation, *i.e.* by using a large quantity of one and a small quantity of the other. Example: A violet gown with a touch of gold, or a yellow gown with a bunch of violets. The more subdued the tone in the larger mass of color, the greater the amount of the contrasting color that may be used.

2. Touches of black will help to bring colors together.

3. Combining colors of low intensity: The fire opal offers a suggestion for a pleasing color harmony with its one spot of bright color, while the others are subordinate in tone. A "one mode" harmony, *i.e.* one color used in different values, is a safe harmony to use, but it is not of extreme interest.

To emphasize a color, a touch of the same color may be added in another part of the costume. Blue eyes may be made to seem more blue by a touch of blue on the costume. A piece of somewhat faded embroidery may be brightened by an added touch of the same color. Another way of increasing the apparent strength of color is to use with it a complimentary color. Examples: red and blue; green, yellow, and violet; green and plum; blue and orange; purple and yellow green. Violet tends to make yellow hair look more golden, care always being taken to keep the violet of sufficiently low intensity not to overpower the color in the hair. "Red" hair is also made brighter by a blue costume. This combination should be sought or avoided, according to the strength of the color of the hair. Greens, particularly the soft greens, are very pleasing with auburn hair.

Lines and colors for different figures. — In deciding what colors are best adapted to different figures, value, intensity, and the characteristics of colors must all be considered. A costume is occasionally designed for a special occasion, as are stage costumes, when the background against which it is to be seen is known, but the usual costume is worn on various occasions and seen against different backgrounds. The average background is of about middle value, *i.e.* about halfway between black and white, and is very gray. Black and white, therefore, being far remote from gray stand out strongly from the background; black calls attention to its boundaries, and so should be worn only by those possessing good figures, while white tends to make the figure appear larger and as a mass. Blue, blue green, and blue violet, if about middle value and very "gray," as well as gray itself, are best adapted to stout figures, being retiring colors, and also much like the background against which they are seen; they melt into it and so do not give prominence to the figure. A little brightness may be added by a small touch of brighter color to make the costume more becoming to the face. Such points of emphasis should be used through the center of the gown, that the eye may not be drawn to its boundaries. It is generally understood that vertical lines tend to lengthen the figure, and, conversely, horizontal lines tend to shorten. This is only half the truth. A vertical *movement* tends to lengthen and a horizontal movement to shorten the figure (see Fig. 130). Example: a gown of broad-striped material may add to the height of the figure, but it will also broaden it, as the eye moves not up and down on the stripes, but horizontally along the *repetition* of the stripes, giving a movement from side to side and an apparent increase in width (see Fig. 131). A band of trimming on the bottom of the skirt may "cut off" the figure, but a dozen bands

placed horizontally on the gown, while adding somewhat to the width of the figure, will apparently increase the height.

To obtain the greatest effect of height, place the longest possible vertical or slightly oblique line through the center of the figure, with no points of emphasis in the way of trimming on outer parts (see Fig. 130). To broaden the figure, emphasize the outsides of the sleeves, the sides of



FIG. 130.—The effect of vertical movement in lengthening the effect.



FIG. 131.—The effect of horizontal movement in shortening figure as eye travels from side to side.

the skirt, outer parts of the shoulders, making such an arrangement of trimming that the eye will be carried across the figure. Boldness of design, conspicuous color combinations, large plaids, and broad stripes tend to increase the size of the figure. Quiet color in dress is an evidence of good taste. This taste should be trained early, for crude

color habits are almost inexcusable. In combining colors the aim is to obtain the proper balance.

Fashion. — In our costumes we should have a higher ideal than mere fashion. While we are willing to think for ourselves and to express our ideas freely on most subjects, in the matter of clothes we too often allow some one else to do our thinking for us. We follow the fashions blindly for fear that we will not look quite like everybody else. To be merely fashionable is to be of the thousands; to wear artistic and individual costumes is to be well dressed. It is not for the benefit of womankind that the fashions are made to change so frequently, but to enrich manufacturer, modiste, and fashion-book maker. Fashion is also governed by traditions which determine many styles, as well as the competition of leaders of fashion who wish to display their wealth in this way. The love for adornment and display in the female sex — the desire to attract, to be beautiful — is also responsible for many changes. Each generation is in the grip of social customs; we submit unconsciously to the survivals of style. It is not a matter to be treated lightly, so much of health, comfort, and good looks depend on the garments we wear that they deserve intelligent thought.

We are frequently unaware of how much our clothes hinder us in our daily tasks, so much disability comes below this level of our consciousness. The full, plaited walking skirts when too long require energy better devoted to something else, in order to support them. Instead of mere novelty the attraction offered by dressmakers should be graceful, beautiful, and becoming garments. Change we want, but let us accept only such change as is for the better, either in the direction of comfort or beauty, or both.

Simplicity. — A discussion of costume would be incomplete without a word on simplicity, for 99 out of every 100 cos-

tumes are spoiled by a lack of it. Simplicity is not plainness, nor stupidity, but the intelligent omission of the superfluous. Being well dressed often means knowing what to leave off. Every bit of trimming, every line, every button or bow or feather either adds to the beauty of the costume or detracts from it. Because one band or bow is good it does not necessarily follow that ten are better. Imbecility of ornament, trimming without reason, spoils an infinite number of costumes, but every bit of trimming that improves a costume fills a place that would be empty without it. It often seems as if women dress and purchase their costumes without looking in the mirror. The caricatures are so grotesque. Stout women, wearing gay colors, material with big figures, large picture hats, should know enough to avoid anything but the most simple lines, figures, and inconspicuous colors. No woman is well dressed in a costume which is exaggerated, and especially when it verges on lack of refinement. The too scant skirt, the very low-cut neck, or transparent skirt are all forms of exaggeration and they show extremely bad taste.

A study of beauty, wherever it is found in painting, sculpture, architecture, or nature, will aid in its appreciation and so help in its application to the costume. Beauty will be found to be not necessarily the result of costliness but of artistic appreciation. Simplicity may help in selection of costume, so that the mad race of attempt to conform to style may not consume so much time and energy.

Appropriateness. — If I were to mention a woman's "uglifiers," I should first suggest the inappropriate gowns and hats. Although a thing may be good in itself, it does not exist alone, nor is it seen alone, but in relation to its surroundings. A girl's light blue or pink satin "party gown" does not make a pretty "dress up" street or school

dress. Nor does a big hat loaded with ostrich plumes make an attractive morning hat. A girl is never well dressed if she wears anything which is too ultra for the life of the community in which she lives. That which is appropriate for the formal city drawing-room reception is entirely out of place in a small town. Gowns should be appropriate to the occasions on which they are worn. The dress of linen or other wash material is most appropriate in every way for the sick room or the kitchen. The business girl's dress should be simple and adapted to her daily uses. Girls should early learn to criticize their own clothing in relation to its appropriateness to the time and place in which it is worn. Another "uglifier" is imitation. The shirt waist made in imitation of the more expensive waist, of coarse material covered with lace and cheap embroidery, is in bad taste. Far better and "smarter" is a plain, well-tailored waist that is all it pretends to be. Other imitations to be avoided are satins, ostrich plumes, laces, and jewelry of a cheap quality. Uncomfortable, untidy, soiled clothing is irritating and does not make for good nature and health. Clean, appropriate, neat clothing cultivates self-respect.

The artistic gown, then, is appropriate to the occasion on which it is worn; it is of good material, neat, convenient, graceful, healthful, allowing for free movement of the body. It is free from superfluous trimming, it is restful to look at rather than disquieting, in color and design it is alluring and persuasive, not self-assertive; it emphasizes in every possible way the charm and personality of the wearer. Such a costume requires intelligent thought and study, which is more than justified by the result.

Jewelry, when worn thoughtfully, is adornment and often enhances the loveliness of a face. Selection should be carefully considered in relation to the costume with which it

will be worn, in order that it may not be simply a costly display, extremely vulgar. Not only the costume, but the individual charms and shortcomings, should be studied, and jewels worn that will add to the attractiveness of appearance. Young girls do not need jewels to enhance their charms when they are appropriately and becomingly gowned. Youth is charm. Jewels appeal because of their beauty, and when worn should be chosen in relation to the coloring of the wearer. Many of the semi-precious stones, although inexpensive, have true artistic charm and are beautiful both in color and setting. Such are entirely appropriate for girls. When the correct color combinations are made, such jewelry may add just the brilliant touch needed to complete the costume. The coloring of the jewels should be in harmony with the gown — corals with salmon rose, warm grays, and yellows.

EXERCISES

1. Why is the study of modern dress important to every girl? What are the requirements of dress?
2. What is meant by unity in relation to selection of hat and gown?
3. What consideration should be given to silhouette in costume designing? What is meant by balance in costume?
4. How is the surface of gowns broken by trimming? What principle must be kept in mind in planning the decoration?
5. How do dark and light values affect the appearance of a costume?
6. In what way does the color of a costume injure or improve a girl's appearance?
7. What is meant by color harmony in dress?
8. What lines and colors should be worn by a stout person of middle age of swarthy complexion and dark hair?
9. What do you mean when you say a person is "well dressed"?
10. Simplicity in dress should be the ideal. What can you do to achieve it? What is "appropriateness" in dress?

CHAPTER XX

THE HYGIENE OF CLOTHING

THE hygiene of clothing is very important, and no girl is well dressed who does not consider the relation of her clothes to health. No costume can be really artistic if it is unhygienic, but not all hygienic clothing is artistic. One element of art is adaptation to use, and all clothing should be so carefully planned and studied that it serves in the best possible way. There have been numerous dress-reform styles started, many of which were freakish, but the aim of every girl in relation to dress should be to evolve for herself something simple that will not necessitate an undue amount of time and show, something pleasing and artistic in its adaptation to individual appearance, and comfortable enough to permit freedom. During the girlhood period of adolescence especially, clothing should permit this freedom so that the body may perform its functions properly. Few give any attention to it or realize that ill health is often the result of lack of thought in the protection of the organs of the body. Heat and energy are generated by the body and are necessary in order that the machinery may run properly. If the heat is dissipated too quickly by surfaces of the body being exposed, there is a waste of the energy which should go to provide for the necessities of the body. Very thin stockings, low shoes, low-necked dresses, scant clothing in winter have this effect.

The purpose of clothing is primarily to protect the body from the cold and to maintain a constant body temperature.

It also serves as a protection against hard, sharp objects, although decoration is the most powerful and controlling factor in the selections of body coverings. Modesty also affects selection of covering and is controlled somewhat by custom. Clothing is healthful or non-healthful in form, pressure, and arrangement as controlled by these purposes of decoration, covering, and protection. Individuals cannot entirely ignore fashion, but it should be controlled and adapted to healthful, artistic, appropriate uses. Pride should not be the only source of warmth. Selection of clothing should be based on occupation, conditions of health, and requirements of age. In summer, clothing should not interfere with the dissipation of heat, but in winter it should prevent an undue loss of heat from the skin. Care should be taken to remove wet clothing as soon as possible, and to change the underwear worn next to the skin twice a week.

Shoes should be chosen with the idea that they are to be adapted to use. Why should it be fashionable for a woman's foot to appear smaller than it really is? The wearing of tight, small shoes is a strain on the body and foot, and women toddle instead of walking with a free, easy spring. This deformation is as bad as that of the Chinese women, who used to bind and deform their feet because it was the custom. Shoes should fit the instep and heel snugly and should be straight on the inside line. The heel should be broad enough to balance the body properly and the soles thick enough to be impervious to dampness and substantial enough to walk on. The toes should have plenty of room for free movement. Why should a girl try to wear shoes that are not the shape of the foot with which nature endowed her? It is not necessary to wear an orthopedic shoe if one has normal feet, but common sense should lead one to bear in mind the above suggestions. The choice of foolish footwear leads to dis-

comfort and frequently to lack of efficiency. "Fallen arch," which is common among women, affects the whole nervous system. Many women suffer and are not conscious of the cause.

Care should be taken to keep the feet dry. This is quite essential if women wish to keep well and be efficient. It is much cheaper to buy rubbers than to pay doctors' bills. Rubbers also protect the shoes and prevent the thread from rotting through being water soaked.

Hats and hair. — The use of false hair is not now as prevalent as it was a few years ago. It is fast falling into disuse by those who wish to preserve health. Many diseases are communicated through it. Eczema, smallpox, and dandruff have been traced to false hair. The undue warmth resulting from false hair also affects the head and causes the natural hair to fall out. When one's hair begins to grow thin, a physician whose specialty is dermatology should be consulted. It is often the result of general ill health or from wearing the hat so much that the circulation is restricted and the head not sufficiently ventilated. A good tonic is to brush the hair every night with at least one hundred strokes. This keeps the hair in good condition when one is in normal health.

Hats when too large or heavy affect health. Much nervousness in women is due to the continuous expenditure of energy in balancing large, heavy hats, and sometimes the body comes to have an unnatural position because of the effort to balance and maintain the poise. A hat should rest lightly on the head and be large enough in head size to permit freedom of circulation.

The corset. — Few young girls appreciate the necessity for careful consideration in the selection of the first corset or corset waist. The test for such a garment is that it

should leave no marks on the body. Corsets cause an atrophy of the abdominal muscles, and if not properly fitted interfere seriously with the circulation of the blood and cause displacement of the viscera — when lacing is resorted to, the thorax is deformed and “uglified.” These displacements, caused by ignorance, lead to the ill health and inefficiency of about one half of the women. Corsets which give



FIG. 132. — The victory of Samothrace.

the figure an hour-glass effect cause pressure in the wrong place and do not permit of deep abdominal breathing, which is essential to health. Any waist or corset may be unhygienic if it causes a downward pressure at the waist. The corset or waist should press upward, supporting the abdominal viscera. All bands about the hips or waist should be over the corset. Tight bands or corsets interfere with the circulation and cut off the supply of blood needed by the brain and internal organs. The corset should fit snugly over the hips, but allow plenty of freedom at the waistline. Garters attached to corsets should not be so tight as to interfere with the circulation or bear downward. The corset should be fitted to support the organs. Most girls wish to preserve

the figure an hour-glass effect cause pressure in the wrong place and do not permit of deep abdominal breathing, which is essential to health. Any waist or corset may be unhygienic if it causes a downward pressure at the waist. The corset or waist should press upward, supporting the abdominal viscera. All bands about the hips or waist should be over the corset. Tight bands or corsets interfere with the

the lithe, graceful waistline with which nature has endowed them. Notice the beautiful hip and waist curves of the Venus de Milo, or the Winged Victory of Samothrace. Are they not more beautiful and artistic than the corset-made lines? Girls can preserve this vigorous, graceful form through proper exercise of the muscles at the natural joint — the waist. Fat easily accumulates around the waist muscles, and proper exercise and plenty of it will prevent this. The corset does not prevent this accumulation. Tennis, golf, gardening, hoeing, sweeping, horseback riding, mountain climbing, walking, all help to prevent the excessive development of fatty tissue. The waist may not then with proper development be called slender, but it is lithe and graceful like the beautiful ideals of the "Venus" or "Victory" (see Fig. 132).

Underwear. — Fatigue and ill health are often due to weight of clothing and to restriction of skin ventilation and circulation caused by certain fabrics. There is a close relation between the regulation of bodily temperature and the texture and fibers of materials. Clothing should be adapted to climate and conditions under which it is worn. Underwear coming next to the skin should be coarse in mesh to give plenty of air space, and should be easily cleansed. In the selection of underwear these hygienic properties of materials should be studied.

Life produces heat; the average human body, even at rest, produces enough heat daily to raise forty pints of water from the freezing to the boiling point, and with exercise the heat production is greatly increased. The body must keep an even temperature to be in health. This temperature is 98° F., and some heat must constantly be eliminated. The elimination of body heat is accomplished by radiation, evaporation, and conduction. More than half is lost by

radiation. The air and clothing surrounding the body cease to be cooler when the temperature is high, as in excessive summer heat; the radiation from the body ceases and evaporation of perspiration takes place. When the air is very humid, evaporation is slow; when dry, evaporation takes place more quickly and bodily heat is reduced. Consequently, an excess of dry heat can be endured, while moist heat is oppressive. Conduction of bodily heat is favored when there is velocity of the air current and moisture. The wind in drying the moisture cools the underlying surfaces. This is the reason why very cold weather is so keenly felt in a moist climate and not as keenly in a dry one.

The clothing worn is for protection against the changes in temperature, in velocity of air, and in humidity, and should be so constructed that there is no interference with elimination of bodily heat nor too much elimination when it is necessary to conserve this heat.

The body loses about three pints of water in twenty-four hours through evaporation; humidity does not favor evaporation, consequently clothing which absorbs and retains much moisture is not as healthful as that which eliminates it more quickly. This process of absorption and elimination differs in various fabrics. It is quicker in linen than in other fabrics. Wool on a dry body, as on old people or on those who do not exercise very freely, feels warm and continues so as long as the evaporation of the skin is not in excess of the power of the woolen garment to absorb and eliminate it. If through physical exercise the amount of moisture is increased and the wool does not absorb it as fast as it is excreted, the air about the body will be moisture laden and evaporation interfered with. A bodily feeling of oppression will follow, due to the retention of the heat. Moisture and velocity of air favor conduction of heat; therefore if the body is exposed to a

draught under above conditions, the bodily temperature may be reduced too quickly.

Elimination of heat takes place when the materials conduct it. The protection against too great elimination is favored by the porosity of materials. Air in the meshes offers this protection, for a still layer of air is not a good conductor of heat. A loosely knitted shawl is warmer under certain conditions than one which is more compact. The air spaces are ventilators as well as non-conductors. Two light-weight garments are warmer than one heavier one because of the layer of air between. Wool and flax both conduct heat, but wool more slowly. Porous wool feels warmer than a plain linen next to the skin. The radiation is about the same in both when the linen is made of the same porosity and air capacity as the wool. Wool is warm and irritating to many people. It is not as cleanly as some fabrics, for it absorbs the bodily excretions, and is not easily laundered. As it felts in shrinking, the air space between meshes is lessened. Loosely woven or knitted underwear with large air spaces is more hygienic than the closely woven. Many cotton garments are now woven loosely and so treated in manufacture that they absorb easily. Outing flannel with its large air spaces is consequently warm, but the ordinary kind is dangerous for underwear because it burns so easily.¹ Peasants and some explorers in the far north wear next to the skin linen of a porous variety; others wear wool. Some Eskimos wear cotton shirts under their furs. Silk as underwear is very pleasing and luxurious but too costly for most people. A combination of silk and wool is excellent but expensive. Silk and wool because of their physical

¹ A method for the permanent fireproofing of cotton goods has been developed, but is not yet commonly applied. Persistent inquiry on the part of consumers will greatly aid the introduction of this important improvement.

structure are able to care for the excretions and perspiration. Silk is more easily cleansed than wool. The great argument for wool is that evaporation is slow, and there is not the same danger as in rapid evaporation through cotton and linen of an undue reduction of bodily temperature. The selection of the kind of underwear will depend on conditions of health, climate, occupation, and age. Each must study those conditions and experiment until the most comfortable and satisfactory has been found. Union suits are by some considered more hygienic because an even layer of clothing covers the body instead of an uneven when the vest and underdrawers overlap about the abdomen. On the other hand, the extra warmth around the abdomen is often beneficial, some people finding it necessary to wear a flannel band in addition to the usual underclothing.

The outer garments for protection should be rather closely woven so that the wind cannot penetrate and conduct the heat too rapidly. Heavy garments are a great burden and prevent freedom of action and efficiency.

EXERCISES

1. What are the purposes of clothing? How is health affected by bodily covering?
2. What controlling ideas should guide one in the selection of shoes? Why should the feet be kept dry?
3. How may hats and false hair affect health?
4. The corset is important. How should it be tested in selection?
5. What should guide one in the choice of underwear?

CHAPTER XXI

THE ECONOMICS OF DRESS

MANY of the problems that confront the shopper are to be considered in the chapter on purchasing of household material (see Book II). There are a few things, however, that should be especially considered in the selection of materials for gowns. (1) A careful study of the whole wardrobe is necessary in order to determine the kind and number of gowns needed. This will depend on the amount of money one can afford to spend for clothes and on the needs of the person; in other words, the social demands of the community and the individual life of the girl. One engaged in business life will have different needs from the one who is the home maker. The first things to consider then in selection of materials are suitability and economy. It is more economical and advantageous to the woman of moderate income to do her shopping between seasons. If your income is limited, never buy things unless there is a particular need. Evening wraps lined with white satin are not apt to be economical expenditures for a woman of moderate means.

(2) After the use has been determined and one knows the amount that can be expended, the selection of material for the gown should be *appropriate to that use*. It is inappropriate to wear silks and satins for work dresses about the house, neither would one select for street or business wear materials which are suitable only for reception or evening gowns.

(3) One must also consider in selection whether one wishes to follow the demand of *fashion* and have new gar-

ments to meet the changes every few months. To do this, if one has a large amount to spend on clothing, good materials can be purchased ; otherwise one must choose inexpensive ones and give no attention to the wearing qualities. If one attempts to follow the fads of fashion, there is likely to be undue extravagance. Exaggerated styles are not only conspicuous but short lived. If one's clothes must be worn for some time and remade, then the wearing qualities of materials should be carefully considered. A knowledge of textile materials and of their manufacture will be of value in selection. If one dresses conservatively and is not influenced by the frequent changes of fashion, one can afford better materials. This is usually a more economical method of dressing, and one is apt to appear always well dressed.

(4) *Color and design*, as have already been suggested, must be borne in mind. Color should suit the individual and be pleasing to others ; and design should suit one's figure and style.

The allowance and dress budget. — Many girls have an allowance to spend for dress. Some do not have to consider their expenses, and the bills are paid by father or mother. Others are engaged in business and anxious to make the amount of the income that can be spent on dress go as far as possible. It will be found worth while for every girl to keep a systematic account of her expenditures for clothing, whether she earns the money for it or not (see chapter on Household Accounts, Book II.) The reason for this is that one should early form the habit of planning and expending so as to get the greatest amount of wearing value and satisfaction in return. When one does not know the amount that may be spent, one cannot weigh the relative satisfaction of different articles, but even without this knowledge, every girl will feel repaid to keep such accounts for a

certain period. As some clothing lasts more than one year, the average for three years should be taken to obtain the cost per annum for clothing. One should also remember that, as a rule, most clothing made at home by the girl or mother costs less and has a longer period of usefulness. If one has the time, it may not be necessary to purchase ready-made garments. Very often, however, it is more economical to buy the ready-made when one's time is well occupied and the saving of energy for the daily work must be considered. The following budgets for expenditures for clothing may be suggestive and help those interested in planning their wardrobes economically and healthfully. A girl with a limited amount to spend may learn, by taking thought, to spend that sum so as to be as well dressed for her income and needs as the woman of unlimited income in a different environment. The care given clothing has much to do with its length of life. Every girl should feel the responsibility for neatness of appearance and cleanliness. It costs money and energy to be clean, and this factor should be a guide in selecting articles of clothing. Some women have, instinctively, an inborn sense of proportion and know how to dress, others must cultivate it.

The following clothing budget gives an idea of what a girl can do with \$65, if she makes some things herself.¹

The average is taken for three years. The first year is naturally the highest, and in the second many articles can be used which were purchased the first.

¹ Perchance some may be skeptical about the possibility of purchasing the following articles of clothing, averaging \$65 per year. All of the articles mentioned can be obtained from a reliable department store in New York, at the prices stated. Many girls can spend no more for clothing. The writer knows from her contact with girls that this is about the wardrobe selected. Sometimes gifts supplement what the girl is able to purchase and she may appear better dressed.

WARDROBE — COST AVERAGING \$65.00 PER YEAR

Planned for a girl who makes her own dresses and waists in spare hours, but buys most of her underwear.

FIRST YEAR

Shoes, 2 pair, at \$3.00	\$6.00
Rubbers, 1 pair75
Ties, 1 pair	2.00
Gloves, kid, 1 pair	1.00
silk, 1 pair, or 3 pair cotton, at \$.2575
woolen, 1 pair50
Hats, best winter hat	3.00
best summer hat	2.50
2 business hats, at \$1.50	3.00
Coats, 1 winter	9.00
1 spring	5.00
Dresses, 2 gingham, at \$1.50	3.00
1 cashmere	10.00
2 cotton shirt waists	1.50
1 dress skirt	4.00
1 woolen waist	2.00
Handkerchiefs and collars	2.00
Hosiery, 6 pairs, at \$.25	1.50
Underwear, 3 union suits, winter, at \$2.00	6.00
3 union suits, summer, at \$.50	1.50
3 pairs drawers, at \$.2575
3 corset covers, at \$.2575
2 pairs of corsets, at \$.75	1.50
Garters25
2 flannelette skirts, at \$.2550
2 short white skirts, at \$.50	1.00
1 long white skirt, at \$1.00	1.00
2 dark skirts, at \$1.00	2.00
3 nightdresses, at \$.75	2.25
Umbrella (gloria)	1.00
	<u>\$76.00</u>

SECOND YEAR

1 pair shoes	\$2.00
1 pair slippers	1.50
2 pair rubbers	1.50
1 pair ties	2.00
1 pair kid gloves	1.00
1 pair silk gloves75
1 winter hat	3.00
1 summer hat	4.00
1 winter suit	16.00
1 linen suit	5.00
1 lingerie waist	3.00
1 silk waist	4.00
1 gingham dress	1.50
2 cotton waists	1.50
Collars and dainty linen	5.00
1 dark petticoat	1.25
1 white petticoat	1.50
2 pair corsets, at \$.75	1.50
6 pair stockings	1.50
Elastics50
Nightdresses, 2, at \$.75	1.50
2 chemises, at \$.75	1.50
2 drawers, at \$.3570
	<u>\$61.70</u>

THIRD YEAR

Umbrella	1.00
Sweater	3.00
6 pairs stockings	1.50
1 pair shoes	2.50
1 pair ties	2.00
1 pair rubbers75
Remodeling hats	2.00
Remodeling cashmere dress	3.00
Organdie dress	6.00
2 gingham dresses	3.00
2 shirt waists	1.50
1 walking skirt	4.00
1 woolen waist	2.00

3 union suits	\$6.00
3 union suits	2.25
Petticoats	3.50
Chemise and drawers	2.25
Corsets and elastics	1.75
Raincoat	5.00
Small supplies	3.00
	<u>\$56.00</u>

Average of \$64.57 per year.

WARDROBE — COST AVERAGING \$125.00 PER YEAR

A working girl earning \$1000.00 spends one eighth for clothing, which averages \$125.00 per year. The first year the budget aggregates most.

FIRST YEAR

4 summer undervests	\$.25	\$1.00
4 pair drawers50	2.00
4 corset covers50	2.00
2 pair corsets	1.50	3.00
4 pair winter stockings25	1.00
4 pair summer stockings25	1.00
3 union suits (part wool)	1.50	4.50
2 pair high shoes	3.50	7.00
2 pair low shoes	3.00	6.00
2 pair rubbers75	1.50
1 pair sandals50
3 nightgowns	1.00	3.00
1 long kimono		2.00
2 white skirts	1.00	2.00
2 seersucker petticoats85	1.70
2 outing flannel petticoats50	1.00
1 black petticoat		1.50
1 wool sweater		5.00
1 rain coat (rubberized)		5.00
1 umbrella (gloria)		1.50
2 woolen waists (Scotch flannel) made at home		3.00
1 wool dress skirt		4.00
1 winter suit		18.00
1 silk waist to go with suit for best		5.00

1 long coat	\$14.00
2 winter hats	8.00
2 summer hats	8.00
1 simple silk dress for afternoon, made at home	15.00
3 tailored waists	3.50
2 white lingerie waists	3.00
1 Indian head dress, made at home	2.00
1 linen skirt	3.00
1 lawn dress, made at home	2.00
Collars, ties, belts	3.00
Gloves, 1 dogskin, 2 kid, 2 white cotton	5.00
Handkerchiefs (8 for \$1.00, plain linen)	2.00
	<u>\$150.70</u>

SECOND YEAR

4 undervests	\$.25	\$1.00
4 pair drawers50	2.00
4 corset covers50	2.00
3 nightgowns	1.00	3.00
2 pair corsets	1.50	3.00
Stockings, 8 pair25	2.00
1 pair high shoes		3.50
1 pair low shoes		3.00
1 pair slippers		3.00
1 pair rubbers75
1 pair sandals50
1 black sateen petticoat		1.50
1 wool dress plain, to be worn with coat for every day		10.00
1 silk waist		4.00
Winter hats, remodeled, one new		8.00
3 tailored waists		3.00
Summer hats, remodeled		2.00
1 new summer hat		6.00
1 silk umbrella		2.00
Mending shoes		1.50
Gloves, 1 pair dogskin, 1 kid, 2 cotton		3.00
Collars, etc.		5.00
1 spring suit		20.00
1 white muslin dress		8.00
1 linen suit		10.00
		<u>\$107.75</u>

THIRD YEAR

4 summer undervests	\$1.00
4 pair drawers	2.00
4 corset covers	2.00
2 pair corsets	3.00
Stockings	2.00
3 union suits, part wool	4.50
2 pair high shoes	7.00
2 pair low shoes	6.00
2 pair rubbers	1.50
1 pair sandals50
3 nightgowns \$1.00	3.00
1 black sateen petticoat	1.50
Short outing flannel skirts	1.00
1 winter suit	18.00
1 new hat, winter	10.00
4 shirt waists	5.00
1 lawn dress, made at home	2.00
1 new hat, summer	8.00
Handkerchiefs, 16 at \$.12½	2.00
1 simple silk dress for evening	15.00
1 simple wool dress	10.00
Gloves, 3 pair	3.00
1 waist to go with last year's suit	3.00
1 rubber coat	5.00
	<u>\$116.00</u>

Average per year of \$124.82.

EXERCISES

1. What is meant by a clothing budget?
2. Plan to keep an account of all the money spent for your clothing by your parents during the year.
3. In order to plan the wardrobe economically, what points must one consider?
4. Criticize the clothing budget which averages \$65 a year. How might it have been improved?
5. Prepare a \$100 budget for a girl making her underwear and shirt waists.

CHAPTER XXII

CARE AND REPAIR OF CLOTHING

“ A STITCH in time saves nine,” and the life of an article of clothing may be prolonged by good care. This means more money to spend on other things when one’s income is limited. In order to be well dressed and well groomed a girl should give daily care to the articles of clothing being worn. It may be but a slight attention here or there, but if the small things, such as replacing a hook, fastening a button, removing a spot, are neglected, much more time is consumed finally in repairing or renovating, and in the interim one is not neatly dressed. There is no indication of character so sure as this one.

A FEW SUGGESTIONS FOR DAILY USE

Coats, skirts, and waists should be kept on *hangers*; skirts on the kind that will keep the bands straight and coats or waists on coat hangers. If one has no hangers, loops at the sides of the skirts and nails placed in the closet at right distance will keep bands extended. A piece of wood wound with cotton batting covered with muslin or silk and with a ribbon or tape hanger will make a good substitute for a coat hanger. If one has hangers, a pole across a closet is an economizer of space. Hangers prolong the life of clothes and cost very little.

Clothes when removed at night should be *aired*. Waists should be turned so shields will dry. Shields should be washed every two or three days. Underwear being worn

should be aired daily. Different clothing should be worn at night.

Waists in reserve may be kept in boxes or bureau drawers. If they are fancy, stuff the sleeves and bows with tissue paper. Good gowns should have cover bags slipped over them as they hang in closets. The cover bags are easily made (see Chap. XVI).

Remember to protect clothing in daily use. — A little brushing every day will keep dust from accumulating. An apron worn while at work is a great protection, and there are many attractive ones for all kind of uses. Do not throw clothing around in a heap. Notice if your skirt braid is torn or a hook and eye is needed or a stitch is necessary. Do it at once. Watch the yokes of dresses. Removable ones that may be washed are most serviceable.

Pressing. — There is nothing which adds so much to the life of a suit or skirt as an occasional pressing. It also increases one's feeling of comfort and one appears better gowned. It can be done easily at home if one cannot afford to send garments to a tailor. Press on the wrong side, as a rule, except in the steaming process. In pressing, place a dampened cloth over the part to be pressed, and press with hot irons until nearly dry. Then turn and press dry on wrong side. Sleeve breads, tailor cushions, and good boards are aids in pressing. Woolen goods will mark or shine if pressed on right side without a cloth.

Care of shoes and rubbers. — It pays to have two pairs of shoes for daily wear and to alternate in wearing. Keep the pair not in use on shoe trees. These can be purchased in different grades from \$.25 to \$1, and they prolong the life of shoes. If one cannot afford trees, the ordinary pliable rattan of one half inch diameter can be bent and used to keep the shoes stretched. A good polish helps to preserve the shoes

and is necessary if one is neat. Rubbers protect shoes. When shoes get wet the thread rots and the soles separate. Rubbers will last a long time with care. Wash them. Soft paper stuffed in heels and toes will prolong their life. Adhesive plaster or a few stitches will help if they become split at the sides.

Care of clothing between seasons. — After each season, clothing should be put away in good condition ready for the next year. Woolen garments should be repaired, well brushed, hung in the sunshine, and then carefully folded. Brush out of doors if possible and do not forget the inside of pockets, the lapels, and cuffs or hems where dust and eggs of moths collect. Fold carefully on seams whenever possible. Gum camphor and tar paper are moth preventives, and can be used in packing clothes away. After boxes are wrapped, mark with labels so that contents can be easily found when needed. Garments brushed and put away in newspapers and boxes carefully sealed are well protected, if no other preventive is obtainable. In packing away summer clothing it should be clean and carefully folded. Blue tissue paper is said to prevent white materials or lace from turning yellow.

Care of colored clothes before laundering. — It pays to set colors before washing. For blue, use $\frac{1}{2}$ cup of vinegar and 1 tablespoon of alum to a pail of water. Lavenders may be treated with 1 tablespoonful of sugar of lead. Pinks and blacks may be set with salt, 2 cups to the pail of water, and soak several hours before washing.

Renovating and cleaning of clothing. — Much expense can be saved by home care of clothing and all textiles through renovating and cleaning. It is well at the beginning of a season to examine the contents of one's wardrobe and decide as to the possibilities. The cost may be a little trouble, but

when gowns, suits, and hats are worth renovating or remodeling it is a satisfaction to make use of them.

Dyeing. — Many garments may be freshened and made presentable by cleaning. If they are faded, it often pays to redye them. Garments or materials to be dyed should first be cleansed, spots removed, or garment washed if possible. If there is a trimming of a different textile, it should be removed and dyed separately. If one is inexperienced in the chemistry of dyeing and in the mixing of colors, it is possible to obtain package dyes with full directions for use on different textiles. Do not forget that the fibers take dyes differently and require different mordants for fixing the colors. Dyes intended for wool or silk cannot be used on cotton or linen. A mordant of alum or salt of tin is used to fix the color. It is wise to experiment if possible first rather than to spoil the article to be dyed. Goods should be thoroughly wet before being put into the dye bath, or they will dye unevenly. The washing and rinsing are a necessary preparation, for material which is dirty will not take the dye in a clear way, but will look muddy. The washing may also aid in removing some of the old dye by boiling in strong soap and water for half an hour and changing the water when it becomes colored. Wool, of course, should not be boiled in this way.

There is one great difficulty which confronts the novice in this field — it is not easy to tell what influence the dye will have on the fabric if it is already colored. It is easy to dye white fabrics or redye any material the same color or a trifle darker, but the combinations of dye color and fabric color necessitate a real study of color in order that the mixing may bring about the desired results. The material to be dyed should be rinsed carefully after dyeing. A little experimenting with samples will repay the inexperienced

dyer. *Tinting* is sometimes a useful way of renovating. Logwood is useful in obtaining brown; for blueing try laundry blue; cream color may be obtained from saffron; and tea and coffee give different ecru shades.

Renovating laces. — Irish crochet should be carefully washed in warm water and a pure white soap to which some good ammonia has been added. If possible put on the grass to bleach. Irish crochet may be ironed on the wrong side on a soft crash towel. It is better to place it on a cloth-covered board and pin down carefully each point of lace in the shape desired. Place it in the sun to dry. Almost any lace can be pinned down. It is not necessary to starch or add dressing. If pinned while very wet it will be stiff enough. Softer laces may be tacked to cheesecloth soaked in cold water, and washed carefully in borax and water, and if necessary bleached with Javelle water. (See Laundering.) Place in sun to dry. Some laces can be pressed between cloths and some varieties on the wrong side with cloth or paper between. Judgment must be used. A marble slab is useful and lace spread on the marble carefully or wound about a bottle often dries very satisfactorily and looks like new.

Renovating of silks and velvets. — Velvet should be brushed and steamed. Put a wet cloth over a hot iron, and the wrong side of the velvet towards the wet cloth; draw it back and forth, brushing with soft brush. The nap is raised by the steam unless too badly marked. Velvet can also be steamed over a kettle. The effect of panne velvet can be made by dampening the back of the velvet and ironing it on the napside with a cool iron. Silks should be sponged before pressing. Lay the silk flat on a marble, sponge up and down with a mixture of soap and water and alcohol. Rinse but do not wring. Press when half or nearly dry on the wrong

side between papers; do not put the iron next to the silk, as it takes away its life and makes it shiny. Old silks and ribbons when renovated can be used for hair ribbons and hat trimmings. Old silk waists and petticoats can be used for shirred silk hats when such are in style.

Renovating of hat materials. — Besides silks and velvets old hat materials, such as feathers and flowers, can be cleansed and reused. Faded flowers and foliage can be used when not too old or soiled by cutting away the frayed edges and painting them with water colors or oil paint thinned with gasoline. Feathers when slightly uncurled can be recurled by shaking and drying over the stove on which some salt has been sprinkled. A small curling knife can be bought for curling purposes, but unless one is expert, more damage than good is the result, and it is better to take the feathers to a reliable shop to be renovated. Wire or other frames can be reused by changing shape, lowering crowns, and enlarging brims. Straws can be easily cleaned. Black straw after dusting can be cleansed with ammonia and water, reblacked with shoe blacking or dye; the straw can be brushed and freshened with dye or blue. Whole hats can be dyed; and when a white hat has been burned this is perhaps the best way to make use of it. Natural straws can be treated with prepared cleaning fluids or washed in warm water and a pure white soap applied with a brush. In cleaning shops, blocks are used for pressing. To restore stiffness, press hats with hot iron while still damp.

Cleaning of clothing can be done with little expense and often in a satisfactory way at home. Washing accomplishes a great deal (see Laundering, Book II). The first thing to do toward removing a stain is to try to discover what has caused the stain. If one does not know, it is wise to test some other place on garment where it will not be noticed.

Woolen goods can be cleansed by washing in warm water with soap solution or soap bark. A soap solution is made by simmering, not boiling, one cake of soap in two cups of water. Press on the wrong side when almost dry or with damp cheesecloth on right side. Soap bark is prepared for use by putting five cents' worth in a few quarts of water. After it has stood an hour, strain it and pour into the lukewarm water in which material is to be washed. Wash and rinse carefully, always rinsing in the same warm temperature as the washing, so as not to shrink by sudden shock. Bath temperature is about right. Every girl should know how to remove the everyday spots that are so likely to appear. Large garments which need cleansing should be sent to the professional cleaner, as well as delicate fabrics spotted by an unknown substance. There are some of the simple stains that can be removed with care from white cotton goods. Silks, wools, and colored goods need special care.

Ink. — Where the composition is unknown it is difficult to know what to use first. Sour milk or several rinsings in sweet milk may cause the spot to disappear. Then wash in warm water and soap to remove grease. If this is not successful, a paste made of lemon juice, starch, and salt, or finally Javelle water. Soak for a few minutes in Javelle water, wash; repeat process if necessary.

Grass stains. — Alcohol may be used when the material cannot be washed, or for white goods. When color will stand it, dyed fabrics, grass stained, can be washed with strong ammonia and water followed by warm soap solution and careful rinsing.

Blood stains. — Lukewarm water and a little ammonia will remove blood stains that are fresh. When on colored silk, wash carefully with lukewarm water or soap solution.

Rust stains. — On table linen, wet the spot and apply a few drops of hydrochloric acid solution and wash thoroughly. On colored or wool goods, if of good quality, special applications of citric acid solution cold will generally remove. Great care is required for colors.

Fruit stains. — Stretch the fabric, if white, over a bowl and pour *boiling* water from a height through the spot. On white wool or silk, lukewarm soap solution is sometimes effective, or boiling water applied while borax is brushed on. On colored garments it is wise to consult a professional dyer.

Coffee and tea stains. — Remove by washing in lukewarm water and then dipping in washing soda solution and again carefully rinsing to remove all soda. (Make solution of three parts of washing soda to one hundred of water.) Tea stains can also be removed by soaking in glycerine and then washing.

Grease spots. — Most grease spots can be easily removed with naphtha soap and lukewarm water. Chemical or dry cleaning will remove grease spots by dissolving the fat. The cleaning liquid may be ether, turpentine, or benzine (*which must be used well away from fire or flame*), or chloroform or carbon tetrachloride. On silk and satins rub the spot with a thin paste made of benzine and carbonate of magnesia. The benzine evaporates and the magnesia will absorb the grease and can be brushed off. Dry French chalk or magnesia powdered and allowed to remain on the material for a while will usually remove grease spots successfully. It may be necessary to brush off and repeat several times.

On wool or cotton remove grease spots by rubbing the spot several times with a sponge saturated with benzine. Use fresh benzine, as each rub removes some of the fat, otherwise fat will spread. A warm iron and blotting paper will remove some grease spots.

Milk spots. — Cold water and a pure white soap will remove milk spots from some fabrics. Wet the spot with pure glycerine by means of stiff brush. When thoroughly saturated, wash carefully for five or ten minutes in lukewarm water. Wring out and iron on wrong side.

Machine oil. — Wash in cold water and pure white soap. This will remove most machine oil spots.

These simple methods of removing spots should enable every girl to be neat. It will aid materially in removing spots if a pad is used. This can be made of several thicknesses of old cloth or blotting paper and should be moved about to take up the grease in a fresh spot as the solvent dissolves it. Good brushes and a glass slab aid in doing careful work.

If the garment is too large to be cleaned at home, brush and repair it carefully before sending to the cleaners. If it is to be cleansed at home, use only the best of gasoline or naphtha. *Beware of fire* and dip the garment in quantities of the gasoline large enough to make it worth the effort. Rinse again in fresh gasoline.

Mending and remodeling of clothing. — Mending in many families seems to be a lost art. Stockings are worn until holes appear, then discarded. This does not tend to increase one's self-respect, for well-cared-for clothing is an indication of character. The majority of housewives repair after the weekly laundering. It is wise also to repair before. Laundering often increases the size of holes and weakens the torn or worn parts as they are rubbed. This pre-laundering repair will be found to be a time saver and increase the life of the garments. It is possible to spend too much time on old garments. Good judgment should be used. The sewing machine can often be used for darning, patching, or other repairing. Sewing machine darners

vary in practicability, but some are serviceable. Good judgment is necessary in deciding about the method of repairing various garments, whether a patch or a darn is to be used, a part replaced, or a bit of tape or net used as a stay. Tape and net are indispensable. Brussels net placed under worn collars or lingerie waists, thin dresses, or even light wool materials is useful and serviceable for staying while darning.

A mending basket is a great help, and if possible a mending drawer, where basket, darning bag, with all the necessary tools and materials for stocking darning, and garments to be repaired can be kept. A sewing room is an added joy to the housewife. A drawer in which to keep materials for repairing is almost indispensable. A scrap bag, if one cannot spare a drawer or (one woman's invention) a sofa cushion cover may be used as a scrap bag where space is limited. In large families it saves time to have the clothes of individuals carefully marked. There are various systems of marking that aid in sorting.

Patching. — As all girls should learn to patch in the elementary school it is not necessary here to describe the method of making the various patches. The hemmed patch is perhaps the most useful, and the flannel patch is one every girl should know how to make. Patches are used when holes are too large to be darned. The hemmed patch is used on materials requiring laundering, such as underwear and household linen, the flannel patch on garments that are liable to shrink and which are too thick for turned edges. When it is necessary to use a patch of new material on a faded garment the patch can be faded, if of cotton or linen, by boiling in soapy water to which soda has been added. The overhanded patch is used on materials seldom washed, where the rough overcast edges on the wrong side are not objectionable.

The overhanded patch shows little on the right side, and is useful for dimity or other dresses. In all repairing careful pressing is a great aid.

Darning is useful not only to replace parts worn away, but to prevent wearing. Methods of darning are familiar to all high school girls. It is necessary to choose carefully the mending material so as to match the color and texture of material. Wool, silk, linen, and cotton thread, ravelings of material, horse hair, and human hair are all possibilities. The needle should be as fine as can be used with the necessary thread, as it is desirable to make the work as inconspicuous as possible. When the material is missing the woven darn is necessary. Stockings, sweaters, woolen gloves, and caps of knitted materials are best repaired by darning. When this method of repairing is used for reënforcing cotton, net is often very useful. It is basted under the woven part and the darning used to strengthen and hold in place. The machine darner is well worth while for certain purposes of everyday mending.

Mending tissue is a useful adjunct of the repair basket. It is used by tailors for mending ragged tears. It is a semi-transparent substance of rubber consistency. A piece is placed beneath the tear and a hot iron melts the substance, which adheres to the material and keeps the edges together.

Remodeling.—It does not always pay to cleanse and make over old clothes. Decide first whether the material is good enough to make the work worth while. It is generally worth while to replace yokes, to add new sleeves, or to lengthen garments. Children's garments can be lengthened by letting down hems and adding false ones. This can be done with the use of tucks and seldom shows. Material of the same or contrasting kind can be added to skirts at the bottom. Quite a length can be added by turning the

hem to the right side and using a cord covered with the same material as piping where hem is sewed. Featherstitching, braid, or other trimmings are useful in this way. Garments of wash material can also be lengthened by the insertion of bands of embroidery or braid. Care must be used to place well in proportion to the length of the skirt. Old skirts, if of good woolen material, can be ripped, washed, recut, and made over satisfactorily. Wash waists which have become worn about collar or wrists and are not worth a new collar or cuffs can be utilized by cutting away worn collars and wearing with a turn-down Dutch collar in warm weather. The sleeves can be cut short as desired and finished with a suitable edge. When waists are worn beneath the arm and are worth it, rip the sleeve at the armhole and underarm seams, and replace with new pieces.

If mothers or sisters have the time, it pays to use good half-worn clothing for coats or suits for the boys or little children. Discarded clothing of no value to others can be washed, cut in strips, and sent to a local weaver to be made into rugs. Old stockings make very good stripes in the carpet, or several may be sewed together and used for iron holders or soft cleaning cloths.

In our grandmother's day, sheets were made of two widths of cloth sewed through the middle. When worn, they were ripped at the center and the worn part turned to the edges. It is possible to-day when sheets become worn, if width permits, to cut through center and place the selvages in seam at the center, thus lengthening their period of usefulness. Tablecloths, napkins, towels, pillowcases, and curtains should be watched carefully and darned or patched in time.

EXERCISES

1. Give five suggestions for the care of clothing which can be practiced daily.
2. What ethical reasons can you give for exercising care of one's clothing?
3. Experiment in the chemical laboratory with the use of some package or vegetable dyes.
4. Bring to the chemical laboratory garments from which spots are to be removed. Follow directions for removal.
5. Bring to class and repair garments by means of patching, darning, and use of mending net.
6. Give suggestions for economy in the use and remodeling of clothing.

CHAPTER XXIII

THE CONSTRUCTION OF DRESSES

IT has been said that one of the evidences of an education is the ability to do. All high school girls should be able if necessity or desire dictates to make their simple dresses. Girls often remark what a saving it is to be able to make even their shirt waists and white skirts. It saves money and one can have prettier garments because it is not necessary to pay a dressmaker. Girls have in some high schools in New York made their own graduation dresses within a limit of one dollar for materials. There is a great satisfaction which comes with the independence one feels in the ability to do.

What dresses should a high school girl be able to make? —

The following list includes simple dresses that come within the ability of every high school girl. If she has made the undergarments suggested, the following outer garments can be made under the teacher's direction with little difficulty: —

- | | |
|----------------------------------|-----------------------------|
| 1. Middy blouse | 6. Norfolk jacket waist of |
| 2. Shirt waist (simple lingerie) | cotton, to be worn with |
| 3. Tailored cotton skirt | tailored skirt |
| 4. Gymnasium suit | 7. Simple one-piece gingham |
| <i>a.</i> bloomers | dress |
| <i>b.</i> waist | 8. Simple one-piece white |
| 5. Tailored shirt waist | dimity or lawn dress |
| 9. One-piece wool dress | |

The construction of these garments should be very easily accomplished, as some of the processes have been practiced

in the garment making described in previous chapters. A few suggestions in relation to each will be made to indicate the course of procedure.

The middy blouse. — This is one of the first garments for which every high school girl has a need — in basket ball or other gymnasium work. It can be worn with bloomers or, outside the gymnasium, with a skirt. White duck or linen is a suitable and satisfactory material.

Use commercial pattern (see Chap. XIV for selection of pattern). Lay it economically, trace according to allowance for seams. Do not forget to place pattern on a fold where only half a part is given.

Baste seams on the outside at shoulder and underarm. Try on, and if necessary drop the front to fit smoothly across chest, or let out at underarm, if extra fullness is needed. Stitch seams on right side. Cut off a portion of each seam towards front and lap back portion to make flat fell $\frac{1}{2}$ " wide. Make hem at bottom 1" finished, turned to right side. Seams are often finished in other ways and turned to the wrong side. Next prepare collar. If it is to be trimmed with braid, do so before it is attached or lined. Attach collar and facing, following notches and directions of pattern so as to have a smooth facing around the opening of the blouse where it rolls back at the neck. Hem the collar, facing neatly by hand around neck after collar has been stitched on and the outside edges stitched in tailored fashion. The sleeves can be seamed with a false French seam. This is a simple seam made on the wrong side and the edges turned in and stitched. Sleeves of the middy blouse are made both with and without cuffs. Often a half-inch hem only is placed at the bottom and the sleeves rolled. A cuff gives the sleeve a more finished look. Follow directions of pattern for attaching it. The blouse is worn with a silk scarf placed

under the rolled collar and tied in a sailor's knot at the front. Black or red ties contrast well with white waists trimmed with dark blue or red braid.

Simple lingerie shirt waist. — Use drafted shirt waist pattern from which the corset cover and chemise were developed (see Fig. 103). Dimity, lawn, madras, and flaxon are all suitable materials. Put the cambric pattern of the shirt waist on a figure. Look through fashion books and decide how you wish to trim the waist. Hold or arrange the material over the pattern on figure to get the effect and, if it is to be tucked, pin in an arrangement. Remove material and tuck or decorate with lace according to style selected. (See decoration of underwear for methods of inserting lace or other decoration.) The waist can be opened in front or back. Plan decoration and make hems for laps accordingly. Do not lay cambric pattern of waist on the material for cutting out until the decoration has been completed. In laying the front pattern, adjust fullness so that the fullness falls in straight lines and is not drawn towards underarm. The warp of the material at underarm should be slightly on the bias. Trace, making seam allowance 1" at shoulder and underarm and $\frac{1}{4}$ " at neck and armhole. Cut from corrected drafted pattern.

Baste seams and try on. Pin cotton belting $\frac{1}{2}$ " around waist, and in fitting adjust gathers at center front and back to fit the belt. The sides and underarm should be smooth, and the seams on a straight line about under the armpit. The shoulder seams should be well located on top of shoulder. If a person is round-shouldered, the seam placed slightly to the back of the shoulder bone will help to correct this in appearance. Trim the armhole if it is snug. Even off around bottom according to length desired. Four inches below belt is sufficient. This can all be done at the first fitting, and unless

the waist needs many alterations it can be finished to this point, leaving neck and sleeves for second fitting. Care must be taken that neck is not stretched at the first fitting. The collar can be prepared, pinned, and basted in place if desired, for this fitting. Finish underarm and shoulder seams with French or false French seams as narrow as possible. Belt can be sewed on the right or wrong side of waist. If belt is not used, a piece of tape can be sewed at center front and back to hold the fullness of gathers. Sometimes tape or belting is attached only at back from underarm to underarm seam, and the front left loose to be held in by ends of the belt passed around to front and lapped. Stitch belting or tape at both edges, but be sure it falls below the waistline of skirt band. Hem bottom of waist by machine with $\frac{1}{4}$ " hem. Next, prepare collar — a straight piece is best for a simple lingerie waist, if a collar is desired. Decorate to correspond with waist trimming. The top of the collar can be slightly shaped; the bottom should be straight. Prepare sleeves to correspond in trimming with waist. Slip on to see if width is correct and sew the seam. The sleeve seam usually falls from 2" to 3" to the front of the underarm seam. The gathers of sleeve should be adjusted 2" or $2\frac{1}{4}$ " to the back and 4" to the front of the shoulder seam. The collar and sleeves should be basted in place for this fitting. There should be a good straight line at bottom of collar where attached. Try on and, if necessary, alter sleeve or collar. If these are placed carefully, it seldom happens that a third fitting is necessary. Baste armhole binding. This should be a bias strip of lawn 1" wide. Baste to the waist side. Stitch on with sleeve, which should be stitched on the sleeve side. Turn and hem by hand to seam. Collar can be stitched flat on right side and the inside edge of waist hemmed to collar, or collar turned and hemmed to the waist. It can also be

stitched in a seam on wrong side and the edges turned in false French seam. *Entre deux* is sometimes used in joining the collar to the waist. Necks can also be trimmed and finished for square necks or round low necks for Dutch collars.

Tailored cotton skirt (see Fig. 133).—This skirt can be worn with tailored shirt, lingerie, or Norfolk jacket waist. Cotton duck or linon is inexpensive; or linen can be used.



FIG. 133.—Tailored shirt waist and skirt.

Use draft for foundation skirt pattern. Divide in gores according to style (see Fig. 109). Place gores on cloth economically. Trace seam allowance and cut out. One inch is enough to allow on the seams and $\frac{1}{2}$ " at top of skirt. Mark the notches and allow for the bottom of the skirt.

To fit skirt: Baste together with seams on the wrong side, holding bias side of gores always toward the worker and match notches. Place tape belting around waist, lapping at point where skirt will open. Skirts are fitted with right side out. Pin carefully at waistline to the belting. The lines of skirt seams should be straight and not fall too far to front or back. Skirt should be easy over the hips, and not so tight across back or front that easy walking is impossible or the form is displayed in an ugly fashion. Darts should be carefully pinned to fit. Remove skirt, trace alterations, rebaste, and fit a second time before stitching. Seams can be finished with simple seams lapped or flat felled. If paneled front or back is used, as in six-gored skirt, the side seams are usually simple and the panels stitched flat to the side gores $\frac{1}{2}$ " from the edges of panels. This gives a tailored finish of $\frac{1}{2}$ " tuck at each side of panel. Seams inside can be

overcasted. There are many ways of finishing the placket facing. If the paneled front is used, finish the under lap or straight edge of first gore with two strips of cotton tape sewed together flat with raw edge of gore between tapes. The panel or front of placket which is on top should not show the sewing on the right side. Place the raw edge of panel between two strips of tape and hem by hand to the material inside. The edges of the tape at the outside can be stitched together. The belt can be finished by trimming the skirt material so it is even with top of waist tape. Place another strip of tape on top and stitch at both edges. The bottom of skirt should be turned and tried on and corrected if necessary. Lay plaits of fullness carefully where they fall and baste the hem. Try on again before stitching or hemming by hand. If an inverted plait is used at center back opening of the skirt, a single piece of material 2" wide can be attached to the under side of opening with a felled seam. Outer edge of this can be hemmed with $\frac{1}{4}$ " hem. The upper side of opening can be faced with a strip 2" wide sewed in simple seam and hemmed flat. A row of stitching across bottom of vent will prevent tearing down.

The gymnasium suit, bloomers and waist (see Fig. 134). — Sateen is inexpensive and can be handled easily; brilliantine or serge can also be used. If one does not care to have the blouse match the bloomers, the middy of cotton duck or linen can be used with the bloomers. Use commercial pattern. Alter according to measurements (see Chap. XIV).

Lay the pattern economically. Find out whether or not your pattern allows for seams and trace accordingly.

Bloomers should be seamed with flat fell seams. The plackets at sides can be constructed in the same way as described for closed drawers. The fullness of the bloomers can be plaited or gathered to fit the waistbands. The waist-

bands should be wide enough to be comfortable ; if the pattern does not indicate them at least 2'' wide finished, alter it. The front band is usually shorter than the back and the buttons are placed on it and the buttonholes on the back band. Buttonholes can be placed on the middle of the bands or two at sides instead of button if it is to be buttoned to the waist. At the knees make casing and run in elastic to hold fullness.



FIG. 134. — Gymnasium suit.

After cutting the waist, baste at underarm and shoulder for fitting. Some patterns do not allow for plaits at front lap or tucks to be taken for extra fullness across front. If this allowance is not made, the front hems for laps and the tucks between front and armholes should be made before the waist is cut out, as described for lingerie or tailored waist. If pattern allows for tucks, then these must be basted and also front hems before fitting, as described for lingerie waist. Buttons or hooks and eyes can be placed on the waist belt, and the bloomers hooked

or buttoned to it. An extra belt can be used to cover over and finish. The collar and cuffs can be finished as pattern provides. The open neck is more comfortable for gymnasium work, and some prefer short sleeves to long ones with cuffs.

Tailored shirt waists (see Figs. 135 and 136). — Use drafted shirt waist pattern (see Fig. 103). Decide whether or not tucks are to be placed each side of front lap. If so, place and finish tucks as well as front lap before cutting out. The tailored waist should lap from left to right. The under

lap at right should be $1\frac{1}{4}$ " turned to wrong side of waist. The upper lap for buttonholes should be $1\frac{1}{2}$ " wide and finished with a row of stitching each side $\frac{3}{8}$ " from the edges. If the material has a right and wrong side, care must be taken to turn the lap to the wrong side and to inclose the raw

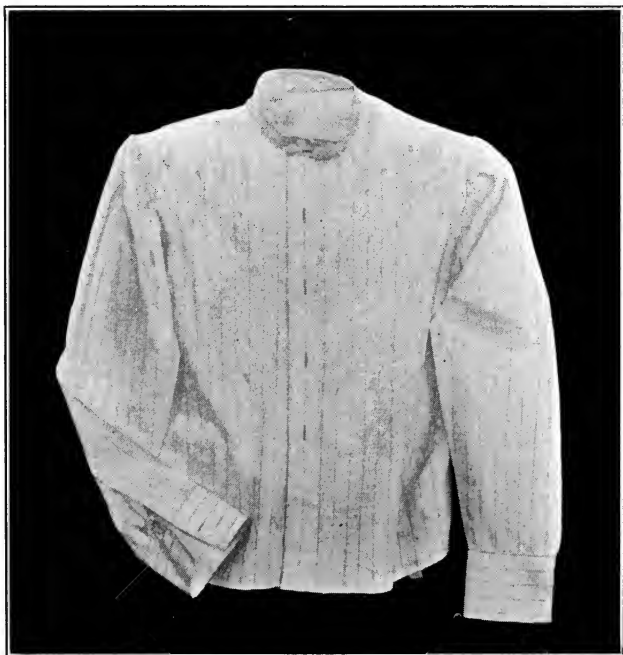

FIG. 135. — Front of tailored shirt waist.

edge in the $\frac{3}{8}$ " tuck on the inside of the plait where the stitching is placed. Lay pattern economically and trace. Allow for seams and fitting as described for lingerie waist.

Seams for tailored waists should be flat felled on the right side $\frac{1}{4}$ " finished. Attach belting and hem at bottom as de-

scribed for lingerie waist. Finish neck with shaped collar band $\frac{3}{4}$ " wide finished at center back. For draft of shirt sleeve use pattern under teacher's direction (see Figs. 135 and 136). Finish with $\frac{1}{4}$ " flat fell. Placket opening should be cut 1" to the under side from fold of sleeve. Face

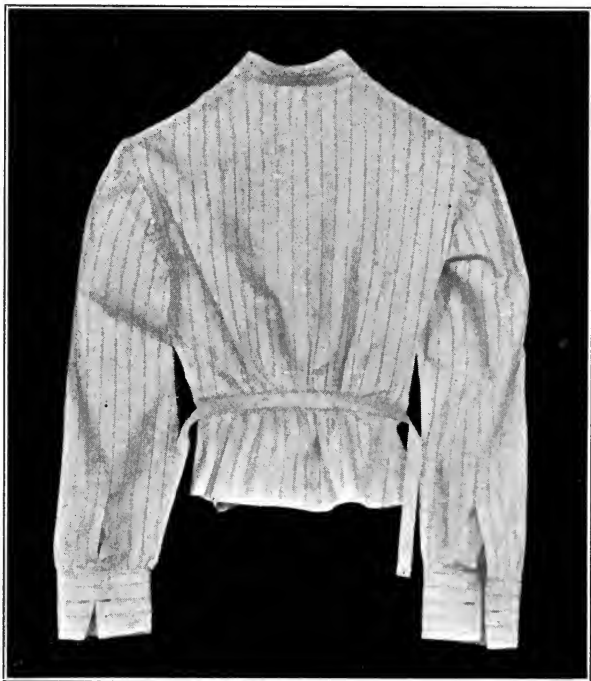

FIG. 136. — Back of tailored shirt waist.

in tailored fashion with pointed facing $1\frac{1}{8}$ " wide finished and in length from cuff 5" to top of point. The opening from bottom is cut 4". The cuff is a straight piece cut lengthwise of material 3" wide finished and length according to wrist

measurement. To make the placket two pieces are required. One is cut twice the length of the opening plus $\frac{1}{4}$ " and 2" wide. The second strip is $1\frac{3}{4}$ " wide and once the length of the opening plus $1\frac{1}{2}$ " for point above opening. Baste the long strip to side of opening, which will be under when finished. Begin at bottom of sleeve. Baste with right side of strip to wrong side of sleeve in simple seam and stitch to end of vent. Half the strip will be unattached. Turn strip to right side of sleeve, turn in $\frac{1}{4}$ ", and baste so finished facing will be $1\frac{1}{4}$ " wide finished. In folding over this facing, place so that $\frac{1}{4}$ " extends at the vent side and the seam taken falls $\frac{1}{4}$ " away from the edge. Fold the remaining half of the facing so it is the same width as attached half, baste edges, and fold this basted strip so that it lies flat on the half attached. Fold sleeve portion so that it lies flat on the strip and baste. The raw edges of this upper half must be covered with the second strip, cut $1\frac{3}{4}$ ". Prepare this strip by turning and basting edges so it is $1\frac{1}{4}$ " wide. Place end to bottom of sleeve and baste flat on top over the width of the under facing, and covering the raw edges. Turn top in point, cut away unnecessary thickness, and baste to portion of sleeve above opening. Stitch once carefully close to the edge. Prepare cuff and turn edges evenly and baste edges where they are to be attached. Slip gathered sleeve within, with the seam of the sleeve 1" back of the center of the cuff. Baste in place so the gathers fall principally on the top half. Stitch once all around cuff and across bottom where attached. A second row $\frac{1}{4}$ " from the row where attached gives a neat finish. The sleeves are located as described for lingerie waist, and gathers adjusted. Baste the bias lawn seam binding for armhole, holding it on the sleeve side instead of waist side as for lingerie waist. Stitch this on with the sleeve. Fold binding back flat

against the waist so that it covers the seam edges. Baste, and on right side place two rows of stitching about $\frac{1}{4}$ " apart so that the finish is like the felled seams. This double row of stitching falls on the seam binding.

Norfolk jacket waist, of cotton cloth, to be worn with tailored skirt (see Fig. 137). Cut from commercial pattern.



FIG. 137.—Norfolk jacket waist.

Use same material as skirt. Baste shoulder and underarm seams and if necessary alter, locating shoulder and underarm seams as suggested for fitting lingerie waist. Trace alterations and seam the shoulders *only*, with seam on right side. Place yoke seam so as to correspond with shoulder seams and raw edges inside. Baste carefully. Locate position of straps, which should be prepared by basting and stitching only at the place where belt will pass. Baste and stitch straps in place. Face fronts; seam underarms with flat fell seams; hem bottom with 1" hem. Prepare collar, stitch to facing, turn inside out, and attach to the waist so that hemming down by hand of the facing is around the neck on inside of waist. Prepare sleeves with cuffs as pattern directs. Finish with buttons and but-

tonholes and necktie if desired.

One-piece gingham dress. — Use drafted pattern of shirt waist and foundation skirt pattern. Any suitable wash material can be used. Select style from fashion book. Prepare waist according to directions given above for lingerie or tailored waist. Prepare skirt as suggested for tailored skirt or

other adaptation of foundation skirt. Do not finish waist at bottom or skirt at belt or bottom hem. Try on waist and skirt together. Lap at the waist so that the belt of the skirt falls in the right place on the waist, pin in place carefully. Finish the waist with a belt of same material, braid or embroidery trimming, according to waist decoration. This is placed over the lap of skirt and waist and stitched in place. A cord may also be used to finish top of skirt, if belt is not desired. Cut away unnecessary portions of waist below the belt line and finish at the waistline before hem is placed in bottom of skirt. This is to insure evenness. Simple gingham dresses can be made with square or round-cut necks or finished for Dutch collars and cuffs of white linen. Trimming of lace or embroidery can be used for decoration according to the texture of the material. For a tub dress of this character the seams of the waist should be felled, French or false French, and the seams of the skirt overcasted. For convenience the dress can be opened down the left side of the front.

One-piece dimity or lawn dress (see Fig. 138).—This can also be made from the adapted pattern of shirt waist and skirt. Follow directions given for lingerie waist and foundation skirt. It is possible to use this dress for graduation and to make and trim it in a suitable way for this purpose. If time permits, some simple decoration in hand embroidery can be placed on the waist and sleeves. Dimity, batistes, Swisses, Persian lawns, white cotton voile, are all suitable for this purpose. The waist and skirt can be attached as described



FIG. 138.—Suggestion for simple lingerie dress.

for one-piece gingham dress. For girls of high school age, the simple lines with simple decoration are much more suitable than the fussy, elaborate, and overtrimmed graduation dresses of silk one sometimes sees. Study carefully the chapter on Costume Design before you decide on the style for your graduation gown.

One-piece wool dress. — All high school girls should be able to make simple wool dresses suitable for school. The adapted Peter Thomson styles are suitable and the construction similar to the middy blouse. A commercial pattern can be used or the shirt waist and foundation skirt pattern adapted. The kimono waist is suitable for this one-piece wool dress. If desired, cut from commercial pattern. Materials such as serge and wool dress novelties are the most satisfactory. The handling of wool material is more difficult than cotton and necessitates very careful basting and pressing to secure a neat finish. It is not necessary to line simple wool dresses, but if this is desired, the waist can be made over the shirt waist lining. The material for a wool dress should be carefully sponged before making. This is sometimes done at the store where goods is bought, or it can be given to a local tailor.

For the *skirt* use the adapted foundation skirt. In cutting out, lay pattern economically and allow $1\frac{1}{4}$ " for seams on wool. Do not forget to allow for the hem at the bottom, usually about 3" to 4". Baste. Try on and fit as suggested for cotton skirt. Open and press the seams on the wrong side. Be sure to place a wet cheesecloth over the material and not to scorch with too hot an iron. Overcast if material is easily raveled. If of firmer cloth, the seams can be notched or pinked. The hem of the skirt is not finished until the waist and skirt have been attached. There are several good ways of finishing the hem. It can be turned

once and catch-stitched to the cloth. This can be done so that the stitches do not show very much on the right side. Another way is to use Prussian binding. This should always be held a little full when used, as it is apt to shrink. It can be stitched to the top edge of the hem by machine, overlapping so that it does not pull out, and then finished by hemming by hand to the skirt. It is never advisable to turn a woolen hem twice. It should be as flat as possible, and pressed carefully. The placket of the skirt is important. It should bear some relation to the waist for the sake of good line. A placket opening at the side of the front and the waist at the middle does not help to make long lines. Open the placket from 12" to 14". Some soft silk can be used for facing sleeves, neck, and placket. For the underlap of the placket, such as can be used at the side of a panel front opening, seam binding can be used at the edge. On the wrong side of this lap, on the line where the eyes for fastening should fall, stitch a piece of Prussian binding for strength. The eyes can be sewed through to this. For finishing the upper lap, take a piece of silk $3\frac{1}{2}$ " by 14". From the wrong side, slip it within the fold formed by the tuck of the panel. This can be held in place by the stitching of the tuck. Sew on the hooks, two close together near top and others about $\frac{3}{4}$ " apart and not nearer the edge than $\frac{1}{2}$ ". The placing depends somewhat on the width of the panel tuck. Fold over the silk facing and turn edge so that it covers the shank of the hook. Hem along edge. This makes a very neat finish. The top of the skirt if attached can be turned at the top. Shrink a square of cambric from which bias strips can be cut. Place a bias strip of this shrunken cambric at the top where the skirt is turned over. This gives strength and is sufficient to keep it in shape if attached to the waist. If separate, hem the belting on the inside to the top edge just below where

turned. A raised waistline is usually $1\frac{1}{2}$ " above the normal. Mark with a basting in fitting.

For the *waist*, use commercial pattern or drafted shirt waist pattern. If lining of cambric is to be used, prepare it by holding in the fullness each side of front in fitting and laying the fullness each side of the center back in plaits. The lining is not absolutely necessary in the simple one-piece wool dress, but for sake of cleanliness can be slipped in and tacked in place. Plan outside according to fashion selected. Arrange material on figure to get the desired effect. This is really modeling.

It is also possible to use the altered commercial pattern. The sleeves should be seamed and pressed open carefully on sleeve board. Place as suggested for lingerie waist. Finish sleeve at bottom by turning desired length, basting, and pressing. Sew on hooks and eyes and face with same silk as that used for the placket. The necks can be finished for simple Dutch collars of linen or embroidery or for standing collars. The waist can also be cut out V-shaped or round and the dress worn with a guimpe of net or embroidery. The guimpe can be cut by the shirt waist pattern, and half sleeves or caps used to hold it down in place. In turning the neck for finish use a piece of the shrunken cambric. Cut it on the bias about 1" wide, and in turning back the cloth around the opening, turn it over this shrunken cambric. This is for strength and to prevent the waist from losing its shape. The facing of silk should be cut the shape of the neck opening.

In attaching skirt to waist a belting can be placed on the outside or inside of the waist and stitched. The skirt can be fastened to this by back-stitching by hand or by stitching below the turned top of the skirt, or the top may be corded if that finish is being used.

EXERCISES

1. Describe the use of felled seams on a tailored shirt waist. How is the lap prepared for the buttonholes, where there is a right and wrong side to material?
2. How are the gathers distributed and the sleeves placed in a simple lingerie waist?
3. Make a shirt waist placket in paper or muslin at home before making it on the waist.
4. Draw a sketch of the arrangement of decoration for a lingerie waist. Make a sketch of a simple gingham dress.
5. How much material will you need for your graduation dress? Compute the cost. Draw sketch of it. Bring to class samples of some suitable materials.
6. Bring samples to class of suitable wool materials for school dress. Compute the cost.

CHAPTER XXIV

MILLINERY

EVERY girl enjoys the thought of being able to produce her own hats. Many have natural deftness of touch and an aptitude for copying and designing; others may be able to acquire this to a certain degree. The novice with or without this natural aptitude must practice and practice again in order to secure neat, faultless results and to improve in design and the ability to handle work lightly and delicately. It is not expected that the average high school girl will have time during her course to become very expert. It will be a satisfaction to learn the most common processes and how to choose hats adapted to face and coloring even if later one buys all one's hats. Although there may not be much time for millinery in the average course, with such elementary principles and practice in making hats for herself and friends, the girl of even slight ability can accomplish much.

The selection of style in headgear. — In the discussion of the importance of dress, the general principles of line, rhythm, balance, and unity, and color were discussed. These principles apply to the selection or planning of hats as well as to gowns (see Chap. XIX). The hat, by being too large or out of proportion to the figure, may change the appearance of the whole silhouette and so overbalance it that the appearance of the figure is anything but pleasing. The hat is the most difficult article to select for a woman's wardrobe. Good taste in selection means a combined knowledge of line, form, and color as well as the fitness of things. The first

rule, then, is to choose or plan hats in relation to the whole figure rather than to the head alone. This means that a hat should be selected before a full-length mirror or planned with the full figure in mind.

The second rule is that the lines of the hat should be adapted to the lines of the face. The round face, with re-troussé nose, looks best in a hat that is slightly tilted in front or with a rolling brim at the front and side. A person with a round face should not wear narrow hats that bend over the face. The long, thin face will be accentuated by wearing high, pointed trimming. Trimming that emphasizes the width, and a brim that is rolling and wide bring a better effect. If the brim is worn slightly forward, rather than rolled as for the round face, the tendency of the shadows is to shorten the length of the face. In adapting the lines of the hat to the head much depends on the style of dressing the hair. The long face is difficult to suit in headgear if the hair is drawn back sharply at the sides, and the round face with the hair worn fluffy may look more round than if the hair were drawn slightly back.

The care of the hair and skin is very important, for the hat tends to emphasize the defects as well as good points of the wearer. A neat appearance and becoming arrangement of the hair have much to do with the becomingness of a hat.

Young girls should be especially careful about the use of bows on the hair. Extremely large bows are not in good taste, but only overemphasize one's defects. The bow to be becoming should conform to the lines of the hair and face, and the color should be in harmony with the complexion and hair.

The aim is to wear what is becoming and adapted to one's style rather than to follow the extremes of fashion. The styles of each season can as a rule be adapted to suit indi-

viduals. This is the milliner's business, to study faces and styles and relate the two. When the individual style of hairdressing is changed according to the prevailing mode, styles in hats are usually more easily suited to the individual, as the season's hats are adapted to the style of hairdressing.

The third rule is to select color that is related to the skin as well as the hair. White, for instance, is not becoming to a pale skin, but rather to a fresh, rosy complexion. Black has a tendency to make the complexion look white and should not be worn next to the face by those with dark, swarthy skin. Brown is most becoming to the person with auburn hair and good complexion, and gray to eyes and hair of that color. The study of contrasting colors, as suggested in the discussion of colors in dress, is one that should be adapted to the selection of color in headgear. A person with fair hair and skin must wear very different contrasting colors from the type of person with brown or auburn hair. The blending of colors in trimming is a study in itself and the suggestions given under dress and house decoration in relation to color apply also to hats. A study of color theory in the art classes will help one to make pleasing combinations in hat trimming.

In the art classes it may be possible under your teacher's direction to sketch some hats. These should show the relation of lines to faces. Begin as soon as possible to cultivate careful observation of hats that appear pleasing on people and the good and bad lines of hats in shops. Simple lines will be found the most satisfactory and in best taste.

A fourth rule is to wear the hat properly. The prevailing styles do not suit all faces, but can be adapted, and hats should be well placed on the head and worn in correct position so that they conform to the outline of the hair.

The making and covering of a buckram hat. — This is a

very easy kind of hat to make. One yard of milliner's buckram is sufficient, one roll of hat wire, and a yard and a quarter of velvet 22" wide, for the outside. The under brim can be faced with satin.

I. To cut patterns for brim, top, crown, and side crown.

A circle about 7" in diameter makes a good top crown. An eighth-inch square of paper folded four times can be cut into a good circle. After folding until cone-shaped, measure $3\frac{1}{2}$ " from the point of the cone on both sides and cut off edge in a curved line. Open, mark the outline of this pattern on the buckram, and cut out. No extra allowance is necessary.

To make the brim pattern, cut in same way as described, a circle 18" in diameter from a square 20". Fold the square in cone shape and measure 9" along sides of cone, before trimming in curved line. Measure also 4" from the point on both sides of the cone and cut a curved line for the inner circle or head size of the brim. This will give a large circle with hole in center for head. Fold this ring once, and notch at the center front and center back. Cut through back fold. From the center front notch, cut a slash to within $\frac{1}{4}$ " of inside head circle. Slash the eight radii (which will make every other one) in the same way. Lap the edges slashed about $\frac{1}{2}$ " and pin. This makes a curved section and pattern of a mushroom hat brim. Mark this outline of pattern on the buckram, allowing one inch on the inside around head size and one inch on one end for lapping. The one inch on the inside will form a bandeau when slashed (see Fig. 139).

The side crown pattern is made from a strip of paper. As the head size and top of crown size differ, this straight strip must be slashed and lapped to fit. A strip $28" \times 4\frac{1}{2}"$ is a good one to start with. Mark center of this strip for

center front. Slash to within $\frac{1}{4}$ " on opposite edge. At each side of this slash cut three more, with a distance of $3\frac{1}{2}$ " between the slashes. Lap the edges of the slashes about $\frac{1}{2}$ " and pin. The lapped edge is now only $22\frac{1}{2}$ ". Mark outline of pattern on the buckram with one inch allowance for lap at end (see Fig. 139).

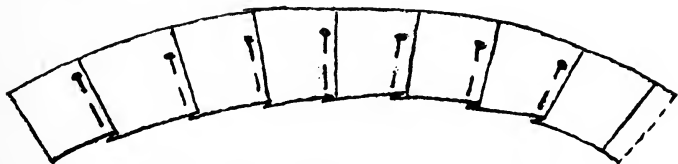

FIG. 139. — Lapping of slashed paper pattern for side crown. The method of lapping is the same for the brim.

This pattern is not extreme and is typical of many patterns that can be cut for all styles and shapes of hats. The necessary measurements are: (1) diameter of hat, back to front, (2) size of head, (3) height of side crown, (4) diameter of tip.

II. To copy a style one should take measurements from the inside. A tape measure is used.

Brim: Outside edge,

Width of brim, center front, sides and back,

Headline,

Crown: Diameter of tip,

Size around tip,

Depth of crown,

Base of side crown,

Note any unusual features.

III. To wire the buckram hat.

Top of crown. — Cut wire 24" long. Lay wire on buckram even with edge, sew with buttonhole stitches about $\frac{1}{2}$ " apart (see Fig. 140). A milliner's needle No. 4 and

No. 30 cotton or milliner's thread are necessary. Do not let wire slip; it should lie even with edge but on the under side of the top of the crown. Lap the ends of wire 2" and sew securely. In opening the roll of wire, care must be taken not to tangle it. Cut the fastening wire and slip roll on the left arm and shake it until it has loosened into large rings and has lost its spring. This saves much trouble.

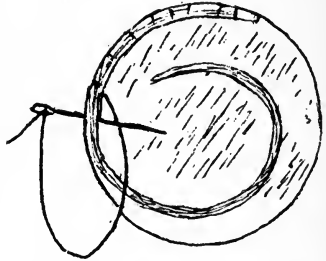

FIG. 140. — Wiring of top crown. The method is the same for side crown and brim.

Side of crown. — Wire base only, using same method as for top of crown. Sew the unwired or top edge of the side crown to the wired edge of the top crown (see Fig. 141).

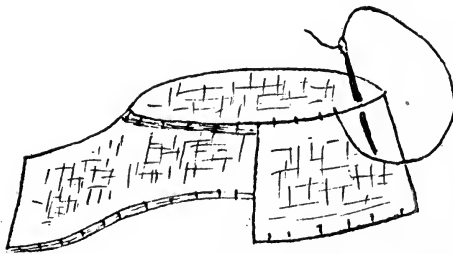

FIG. 141. — Sewing the side crown to the top crown of the buckram crown.

The wire should all lie on the inside and not show from the outside of the crown. Start at the center back, using the buttonhole stitch. When finished, lap ends at back and hold down with catch-stitching (see

Chap. XVII for description of the stitch).!

Wiring of brim. — Lap ends of brim one inch in back and hold down with catch-stitching. Cut a wire for outside edge of brim 3" longer than the edge. Begin at back where brim is lapped. Sew as described with buttonhole stitch and lap wire 3" at back. At the head size slash the one-

inch allowance, make the slashes one inch apart and one inch deep. Bend these slashes up and at the bottom of slashes or lower head size place a wire two inches longer than the head size. Sew with buttonhole stitches and lap ends at center back two inches. Cut another wire same length and sew it to the upper edges of the slashed head size, lapping ends in back. This makes a one-inch bandeau of the same size on both edges.

This method of wiring buckram frames can be adapted to many shapes.

IV. To cover the buckram hat.

The upper side of brim. — Preparation of frame for covering. Bind the edge of the brim with one-inch bias strip of

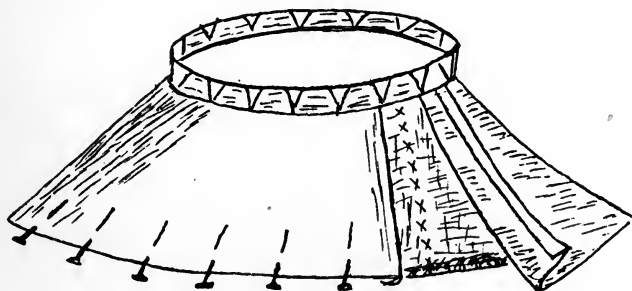

FIG. 142. — Covering buckram frame.

thin crinoline. Sew with long running stitch. Place the velvet over the top of the brim so that the bias lies from front to back. Make rough fit first. Pin around edge every two inches and smooth fullness towards the back from the front. Slash velvet at head size so it may drop over the bandeau. Stretch velvet from head size to edge of brim; fit and pin smoothly. Cut velvet at center back. Fold under one edge $\frac{1}{2}$ " and pin (see Fig. 142). Fold in other edge $\frac{1}{2}$ " at center back, so that the edges exactly meet. Sew

with tiny slip stitches. Cut velvet around edge of brim, allowing $\frac{1}{2}$ " to turn under. Catch-stitch this turned edge to the buckram carefully so stitches will not show through. Pin crown in position. Sew it with long stitches (running) to the brim.

The crown. — When it is to be smooth finished, lay velvet over the crown; cut so it is large enough to extend half an inch from the tip at the sides. Sew in place with long running stitches.

The side crown, when smoothly covered, is finished with a true bias piece of velvet. For the dimensions of the hat described, a piece $29'' \times 5\frac{1}{2}''$ will be long enough. Join the velvet along selvages to make piece long enough. Turn under $\frac{1}{2}''$ top and bottom of strip; place around crown and pin in place, stretching at the bottom edge at base of crown, but holding the upper edge so as not to stretch it. The piecing in the velvet can be placed where the trimming will fall. Pin the ends of the velvet, fold under $\frac{1}{2}''$ at the end, and blind-stitch in straight seam.

The crown can be covered with a full tam-o'-shanter if desired. This is made of a circle of velvet about $18''$ in diameter. Gather at edge with two draw strings and pull in to fit the base of the crown. Pin in place; sew flat and cover sewing with a true bias strip of velvet one inch in width turned at both edges. The fullness of crown can be tacked to suit the face.

The underside of brim. — The underside of brim can be faced with velvet, silk, or satin. If thin silk or satin is used, a layer of cotton sheet wadding should be cut to fit and laid on the under brim. Turn the hat with under brim up. Lay satin on brim with bias from front to back. Pin in place at front, first at edge, then at head size. Push the fullness to back and to the inside of hat. Fit facing, pinning at

outside edge and then at head. Fit and smooth until surface is without wrinkles. Trim at edge, leaving $\frac{1}{2}$ ". Slip-stitch seam at center back as on top covering. The edge of the facing can be finished at center back. Pin a few inches and then sew, using a stitch which will be $\frac{1}{2}$ " long under the wire, and a tiny stitch through the top. Sew on the satin side, so that the stitches do not show on the velvet. By making a groove with the needle under the wire as the sewing proceeds, the stitches will be concealed, as they are drawn beneath the wire and a cord effect only is seen at the edge. At the center back tie the ends and finish the sewing, lapping the wire one fourth of an inch.

The satin at the head size is slashed until it fits and is sewed to the headband.

This style of hat can be trimmed effectively with wings, feathers, or large satin bows. If the tam-o'-shanter crown is used, it can be trimmed effectively at the base with a band of fur or rich embroidery. The brim can be bent in various ways to suit individual faces.

The lining of the hat. — Hats can be lined with taffeta, China, or Sicilian silk. The length should be 1" longer than the head size, and about 2" more in depth. Turn a hem and run at edge, making casing wide enough for a ribbon to slip through. The hat lining is put in after the hat is otherwise finished. Place the raw edge inside the base of the crown, begin at center back and sew, using two tiny stitches one over the other and placing them $\frac{1}{2}$ " apart. These are taken exactly on the headline. Finish at back by lapping so that the end of the outside when finished will be turned in. Sew up in seam or flat with running stitches. Draw up with ribbon. A small square or circle of the lining silk can be placed in the top of the crown to complete the finish and prevent straw or wire from catching the hair.

Making and covering a wire frame. — Every girl should learn to make wire frames. The construction is not difficult, after a little practice. It is possible to buy wire frames inexpensively, but the styles are not usually the exclusive ones. If one knows how to construct a frame, it is very easy to remodel those one buys, or to plan any variety of shape with round or square crowns, rolling or round brims, such as one cannot purchase. The shape of the wire frame then will depend on the prevailing styles. Visit the millinery shops and study the fashion sheets for hats. The following description of how to make a wire frame is typical and can be adapted to the style.

For the frame making, the following materials are necessary: —

1 roll of frame wire, 1 spool of tie wire, 1 yard of thin crinoline, pincers, tape measure, pencil.

In preparation, wind off some of the tie wire. Fifteen turns around three fingers will enable one to cut the lengths evenly and all at once. After winding, cut at both ends. There will be thirty pieces about two inches in length. Open the roll of wire carefully as discussed above. In measuring wire, always measure with the tape on the outside of the curve.

I. Practice lapping and tying wires. Lap two pieces of frame wire, 5" in length; hold the two-inch piece of tie wire with the first finger and thumb of left hand against the frame wires (see Fig. 143). Twist the tie wire firmly twice around the frame wires with right hand, and twist the ends of this wire together around each other. Then twist the tie wire ends with the pincers and break close. Practice until you can do this tying firmly. Then practice crossing wires at right angles and tying those.

II. To make a wire frame. The crown and brim are made separately. The following is a simple shape with

brim rolling at left side. This can be varied according to style and made with oval or square crown. It is typical of how to make a wire frame. Mushroom, sailor, turban, and other shapes can be made, using the same method, after accurate measurements have been decided upon.

The brim. — Make the head wires first, 22" of wire plus 2" for lapping. Mark the twenty-two-inch point. Make two circles, same size; lap ends two inches and tie both ends. Divide head size into eight equal divisions. Mark wires of both circles with pencil. Measure carefully, beginning at center of lapping of wires, which is the back. The marks should be $2\frac{3}{4}$ " apart. For the spokes of the brim cut eight wires 10" long. At each mark on the head wires, a spoke wire is to be attached by being wrapped about it. Two

FIG. 143. — Method of twisting the tie wire.



inches from the end of each spoke wire make a bend with the pincers. Take the spoke wire in the right hand and place bend inside of one of the head circles at center back at the place marked. Twist once around the circle wire very close and tight. This requires practice. One inch above this twist on the short end

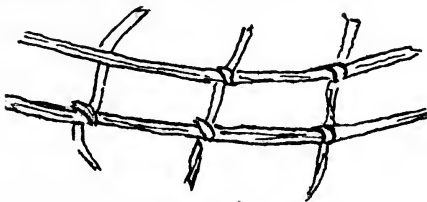

FIG. 144. — Detail of method of twisting spokes about head wires.

of the spoke wire place the second head size circle and twist the spoke about it (see Fig. 144). The center back spoke is now in place, attached to the two head circles. Follow the

markings carefully and attach the center front spoke by same method. Then the center left side and the center right, working with opposites until all spokes are in position (see Fig. 145). Straighten out spokes and roll up the ends at one side as if for brim, keeping the line of the various radii

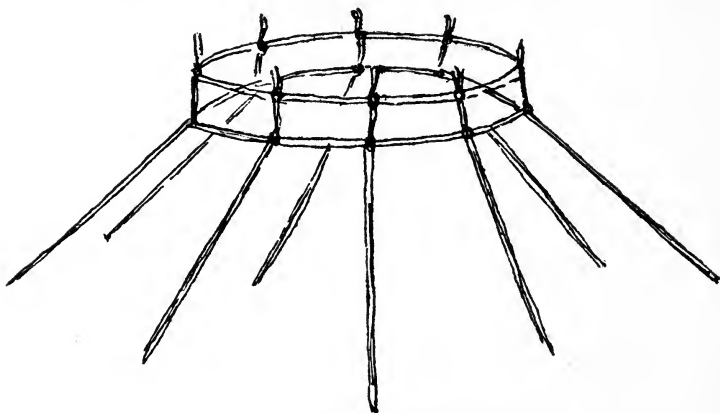

FIG. 145. — Spokes of a brim in place.

straight from the center. The edge wires and brace wires for the brim come next. As the hat rolls at one side, the spokes will be longer on that side. It is necessary to measure the length of each spoke from the lower head size wire. Back $4\frac{1}{2}$ "', left side back 6"', left side 7"', left side front 6"', front $4\frac{1}{2}$ "', right side front, side and side back at right all $4\frac{1}{2}$ "'. Bend upward with pincers at marked places. The edge wire is to be placed at the bent places, in spokes. Cut 52" piece of wire, which will allow 4" for lap at back. Mark the distance on the edge wire to the left between spokes. From the middle of the four-inch lap to the left, mark $5\frac{1}{2}$ "', 12, 18, 25, 31, $36\frac{1}{2}$ ", 42, 48, which is the middle of the back. Place edge wire in position and twist each spoke about it at

the marked point on the edge wire. Lap the ends and tie twice at center back. The brace wires are placed next and keep the spokes in position. They are circles cut according to dimensions, lapped and tied and placed flat on the underside of the brim and tied to each spoke with tie wire. Cut the brace wires 45", 37", 33", and 27" long. Two inches are allowed on each for lapping. The largest circle is placed one inch from the edge wire on the right side and $1\frac{1}{2}$ " from it on the left, and the other three divide the space evenly about one inch apart.

The crown. — If this is to be dome-shaped, make the base wire 32" plus 2" for lapping. Tie in circle. Divide this circle into eight parts, 4" between each mark. Cut four crown spokes each 20" long. Bend with pincers one inch at each end of the spokes. Place bend in-



FIG. 146. — Two of the crown wires placed for crown by opposites. Two more to be added.

side of base wire at point marked and turn the one inch of the crown spokes around the base wire at the eight places marked. Place these by opposites (see Fig. 146). Shape the dome as desired and tie the four spokes at center with one tie wire. Five brace wires are enough for the crown. These are placed about $1\frac{1}{2}$ " apart and tied to the spokes as

the braces were tied to the brim. Measure for the brace wires by holding wire around the dome-shaped crown and allowing 2" for lap on each wire. This completes the crown of the hat. A square crown is easily made by same method with the measurements of the diameter of the tip and depth of crown (see Fig. 147).

Wire hats can be covered with crinoline or cape net, and the final covering can be of velvet, cloth, or straw.

III. To cover with thin crinoline. This must be of a light quality to fit into all the curves. Do not pull too tightly and bend the frame. Hold under-side of brim up and lay crinoline over it. Pin over the edge wire and lower head size wire, working from front to back, first on one side and then on the other. Cut fullness away at center back, lap over one inch, and pin over back spoke. This is the first fitting; go over it again to remove wrinkles, but guard against making it too tight. Slash at head size space at each spoke and halfway between. Turn up the slashed ends and pin to head size wires (see Fig. 148). Sew with even running stitches first

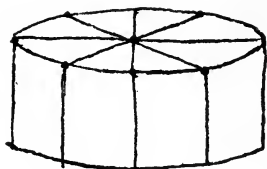

FIG. 147. — Square edged crown showing crossing of wires.

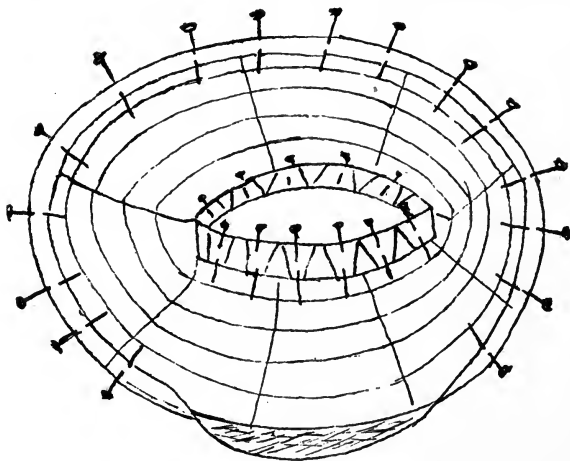

FIG. 148. — Covering brim of wire frame with crinoline.

around upper head size wire, then around edge wire; place stitches just inside the wire. Trim off extra crinoline, leaving only half inch at edge wire where turned.

The crown can be covered by laying a piece of crinoline over the top of the crown, smoothing it over the spokes, and pinning fullness in little plaits at the base where it is

turned under base wire (see Fig. 149). Sew around with running stitches and trim off on the inside.

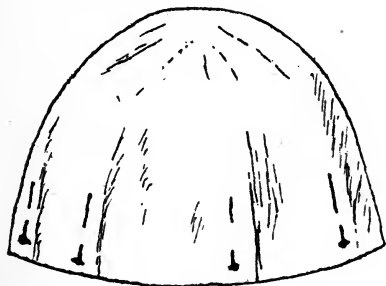

FIG. 149.—Covering crown with crinoline. Notice plaits at base.

IV. To sew straw for covering wire frame. Bind the edge of the brim with straw, using the running stitch. If the straw is too thick and this makes a clumsy

edge, bind it with a one-inch bias strip of velvet, satin, or silk; use running stitch.

In sewing straw use No. 40 or No. 50 cotton thread of same color as straw. Silk should not be used, since it cuts the straw. Begin with the top of the brim a little to one side of center back. Sew the straw so that one edge is even with the brim. The stitches should be small and concealed under a weaver of the straw on the upper side and about half an inch long on the underside of brim. Do not draw the thread too tight, for every impression shows. Sew only on the outside edge. Lap the second row over the first as little as possible. The braid is continuous for the brim. Sew the second row so that it also holds the inner edge of the first row of straw with the one sewing. The inside edge of each row must be held in slightly to fit and lie flat. Carry

the straw round and round the frame. Care must be taken in passing from one row to another to have the transition gradual, and in rounding to make a good curve. If one side of the brim is wider and rolls, continue with the straw until the narrow side of the brim is covered. Then fill in the remainder of the wide side, which is uncovered, with sections of the circle, cutting each section separately. The under brim is covered the same way.

To sew straw for the crown, one can begin at the base or tip of crown. To begin at center of tip, bend straw to form a good circle in center, sew as for a flat mat with the same stitch as for brim. Occasionally lay the sewed straw over the frame to fit. Continue to the base. This is accomplished more easily if the braid is pinned four or five inches ahead before sewed. A tam-o'-shanter crown of straw is started at the center and sewed round and round in a mat or plateau until it is about 10" in diameter, according to size desired. Draw in gradually in sewing until it is crown-shaped.

Another way to sew braid for the crown is to begin at the base and sew around so that the first row is even with the base. The second row is overlapped and a gradual transition made to the top. Finish the top neatly. A hole can be made through the crinoline at the center of tip and the ends brought through. They should be sewed flat on the inside.

In straw sewing, much depends on the uniformity of the lapping. A hat which has uneven rows is not well made. This uniformity of width can with care be preserved by thinking about it as each row is turned.

Bow making can be practiced in paper or cheap cambric muslin, if no old ribbon is available. There are a few simple bows which are very useful, which every girl should know how

to make. With practice it is possible to get artistic effects and to make many variations of these. Cut the muslin about three inches wide. Always tie a bow when possible, for a tied bow is much more graceful than a sewed one.

The simple cravat bow is really familiar to all. Plait the ribbon a distance from the end to allow for a streamer or bow end. Hold the plaits with the thumb and first finger of the right hand; with the left hand measure the length of the first loop; plait, and hold all plaits with thumb and first finger of left hand. Measure and plait the second loop in the same manner. Tie a knot over the plaits by twisting

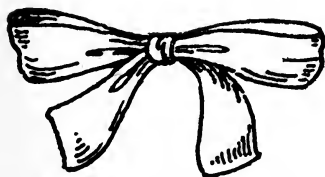

FIG. 150.— Simple cravat bow.

this twist or loop you have just made, from the direction it was taking when it formed the last loop. If you put this end through the twist from the opposite direction, no knot will be made and your bow will tumble. If you can tie the

cravat bow, you can tie every bow that is made. The process is the same, but the difference lies in the number and relative lengths of loops and ends (see Fig. 150).

For the uneven bow, measure a long loop, plait, and hold with right hand. Opposite this, measure, plait, and hold a much shorter loop. Parallel with the first loop measure, plait, and hold a loop a little shorter than the first one. Opposite, measure another loop a little shorter than loop No. 2. Parallel with loop No. 1 make a fifth loop. Continue until you have as full a bow as you wish. Usually five loops are enough, three on one side of the knot, and two on the other. Tie the knot over the plaits you are holding with thumb and finger of the right hand as you did for the cravat bow.

Remember to bring the end of the ribbon through the twist from the same direction in which it was when the last loop was made (see Fig. 151).

Rosettes. — Make a rosette bow as you did the uneven bow, but measure all loops so they are of even lengths. Have the same number of loops on each side of the knot. Ten or twelve loops will make a good-looking rosette bow (see Fig. 152).



FIG. 152. — The rosette of even loops.

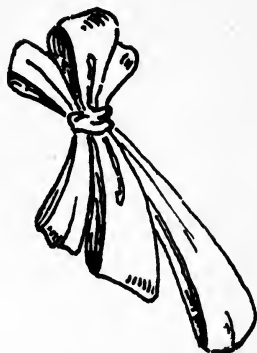

FIG. 151. — The uneven bow.

The *rounding rosette* is made in the same way as the rosette bow. Draw the knot very tight and pull the loops over it so as to conceal the knot and make the bow the shape of a pom-pom or half sphere (see Fig. 153).



FIG. 153. — The round rosette.



FIG. 154. — The flat rosette.

For the *flat rosette*, make loops as for rosette bow, but do not draw the knot very tight. Arrange loops around it flat so as to have a wheel effect (see Fig. 154).

A FEW SUGGESTIONS FOR TRIMMING

1. See the current fashion magazines.
2. Simplicity in trimming is always most pleasing. A hat is spoiled if overtrimmed.
3. After the trimming is pinned in place, hold hat at a distance and criticize. Notice what may be taken off.
4. After placing the trimming, sit or stand before the mirror and adjust trimming to suit the face and outline of the hair.
5. For young girls, trimming across the front or back may be becoming. It is usually placed at the left side, although sometimes on the right.
6. A simple trimming is made by rolling a twist of ribbon around the crown and finishing with a bunch of flowers.
7. Wreaths or ribbon flowers can be made in class. Scraps of silk or ribbon can be used for this purpose.
8. Wings and quills are suitable for young girls. A quill is often trimming enough for a stiff tailored hat and can be put through the crown and brim if turned. Wings must be carefully placed in relation to lines of face to get the best effect, and should be pinned in position and tried.
9. Straw hats, if of tailored finish, can be trimmed with straw bows, wings, or ornaments. This makes an economical trimming and uses up the odd pieces of straw.
10. Ribbon bows are always suitable for young girls' hats. Every girl should be able to tie the simpler styles. (See directions.)
11. The ability to trim a hat artistically is a gift. One may possess it and not be aware. Begin to practice placing. Study the best designs in shop windows and magazines. Notice the colors and materials combined.
12. Sew trimmings with as few stitches as possible to

hold, — wings, feathers, and flowers securely at the base but tacked loosely with invisible stitches.

13. Large black-headed pins are useful in placing trimming and in holding until sewed.

EXERCISES

1. What knowledge should guide one in selecting a hat? What proportion of the expenditure for clothing should be spent on hats?

2. Make and trim buckram hat for some one at home. Perhaps you have some old silk which will do for the facing of the brim. Try to keep the cost as low as possible.

3. Bring in three bows made at home, of old ribbon, or cambric.

4. Describe method of covering a wire frame with crinoline.

5. Describe the principal stitches used in millinery.

6. Practice tying wires in preparation for frame making.



INDEX

- Adulteration of materials, 194-196.
by combination of fibers, 195.
by methods of finishing, 195.
by use of waste materials, 195.
by weighting, 194.
- Æsthetic education in the home, 8-9.
- Aprons, construction of, 246.
- Architecture,
colonial, 20.
domestic, 18-26.
English, 19-20.
Italian, 20.
principles of, 18-29.
Spanish, 20.
- Bathroom, 31, 52-53, 88.
fixtures, 88.
furnishing, 88.
location, 31.
- Bedroom, 86.
- Bleaching of
cotton thread, 113.
cotton yarn, 113.
linen, 139, 142.
- Bric-a-brac, 84, 86.
how to choose, 86.
use of, 86.
- Budgets for clothing,
wardrobe costing \$65 per year,
314-316.
wardrobe costing \$125 per year,
316-318.
- Building, cost of, 36.
- Candles for lighting, 43.
- Carding,
cotton, 106-107.
wool, 158.
- Care of clothing, 319-330.
before laundering, 321.
during off seasons, 321.
pressing, 320.
removal of stains, 324-327.
renovating and cleaning, 321-322.
shoes, 320.
suggestions for daily use, 319-321.
- Carpet manufacture, 161.
- Cellar, 32.
how to construct, 32.
importance of, 32.
- Cesspools, 49.
- Chemical composition of
cotton, 189.
flax, 132, 190.
silk, 190.
wool, 188.
- Chemise, 237-238.
construction of, 250.
pattern from shirt waist draft, 237.
- Cisterns, 46.
- Cleanliness in the home, 4.
- Closets, 31.
- Clothing,
budgets, 314-318.
care and repair of, 319-330.
hygiene of, 305-307.
corsets, 305-306.
hats, 305.
rubbers, 305.
shoes, 304-305.
underwear, 307-310.
purposes of, 311-312.
remodeling of, 327-328.
- Coal stoves, 38-39.
- Cocoons, 172-175.
color of, 172, 174.
reeling of, 174, 175.
- Colonial architecture, 20.
- Color in decoration, 59-60.
contrasting, 59.
complementary, 59.
gradation of, 59.
values, 59.
- Conductivity of materials, 191-193.

- Consumers' League label, 202.
 conditions of labor, 202-203.
- Corset cover,
 construction of, 253-255.
 pattern of, from shirt waist, 238.
- Corsets, hygiene of, 305-307.
- Cost of building, 36.
- Costume,
 design in, 275, 276.
 Egyptian, 274.
 French, 279-286.
 Greek, 276-278.
 history of, 274.
 Roman, 278.
 The Renaissance in
 16th century, 280.
 17th century, 281.
 18th century, 282.
 19th century, 283-286.
- Costume design, 288.
 requirements of, 289.
 adaptation to individual of, 297.
 color and color harmony in, 294.
 dark and light "value," 292.
 lines in design, 292.
 the silhouette (lines), 290.
 unity, 289.
- Cotton, 97-129.
 appearance, 98.
 baling, 105.
 by-products, 106.
 composition of, 189.
 culture of in United States, 102.
 ginning, 103-105.
 varieties, 98-102.
 where grown, 98.
- Cotton cloth manufacture, 113-121.
 dyeing, 121.
 finishing in, 120.
 industry in the United States, 128.
 mercerization, 121.
 pattern making for, 115, 116, 118.
 printing of, 121.
 warping, 117.
 weaving, 121.
- Cotton industry in the United States, 128.
- Cotton materials, 122-127.
- Cotton yarn manufacture, 106-110.
 bale breaker, 106.
 carding, 106.
 combing, 107.
 doubling and drawing, 108.
 picker machine, 106.
 spinning, 110.
 uses of yarn, 112.
- Curtains and draperies, 82-84.
 how to hang, 83.
 materials used for, 82.
 reasons for use, 83.
- Darning, 329.
- Decoration of underwear, 210-215.
 bias bands as, 215.
 fancy stitches as, 213-215.
 tucking on, 213.
 use of *entre deux*, 211.
 use of lace, 211.
 whipped ruffles on, 212.
- Decoration, principles of home, 57-60.
 appropriateness, 57.
 color, 59.
 effect of environment, 56.
 good "lines" 58.
 simplicity, 57.
 unity, 57.
- Design in costume, 288-289.
 adaptation to individual of, 297.
 color and color harmony in, 294.
 dark and light "value," 292-294.
 lines in design, 290.
 requirements of, 289.
 the silhouette (lines), 290.
 unity, 289.
- Disposal of waste, 48-53.
- Doilies, crocheted edges, 272.
- Domestic Architecture, 18-26.
- Doorways, 22, 30.
 architectural effect, 22.
 for exit, 30.
 for ventilation, 30.
- Drafting of patterns, 219-243.
 chemise from shirt waist, 237-238.
 corset cover from shirt waist, 238.
 night dress from shirt waist, 234-237.
 peplum from shirt waist, 238-239.

- Drafting of patterns,
of drawers, 228-230.
of kimono nightdress, 226-228.
of shirt waist, 220-223.
of shirt waist sleeve, 234.
skirts, 239-242.
 four gored, 242.
 five gored, 242.
 six gored, 240-241.
tools for, 226.
- Drainage systems, 49-53.
- Drawers, 249-250.
construction of, 249-251.
pattern of, 228-230.
- Dress,
adaptation of, 311.
appropriateness, 300.
color in, 294-296.
design of costume, 288.
economics of, 311-318.
fashion in, 299.
hygiene of, 303-310.
importance of the study of modern,
288.
jewelry, 301-302.
requirements of, 289.
simplicity in, 299.
- Dresses, construction of, 322-347.
gymnasium suit, 337.
middy blouse, 333.
Norfolk jacket waist, 342.
one piece dress, 334-336, 342-346.
shirt waist, lingerie, 334.
tailored shirt waist, 338-342.
tailored skirt, 336.
- Dressing sacque, construction of, 253.
- Dyeing, 160.
cotton thread, 113.
cotton yarn, 113.
- Economics of dress, 311-318.
allowance, 312.
budgets, 313-318.
darning, 329.
patching, 328.
ready vs. home made dress, 313.
remodeling, 327.
wardrobe costing \$65 per year,
314-316.
- wardrobe costing \$125 per year,
316-318.
- Education in the home, 6-8.
intellectual and æsthetic, 8.
physical, 6-7.
religious, 8.
- Egyptian costume, 274-276.
- Electricity for lighting, 44.
- Embroideries, 257-260.
Chinese, 259.
Indian, 259.
Persian, 259.
Turkish, 259.
- Embroidery, 257.
application of, 266-273.
equipment for, 266.
history of, 257-260.
- Embroidery stitches, 260-266.
how to make them, 260-266.
blanket, 260.
 scalloping, 261.
chain, 260.
couching and appliqué, 264, 266.
cross, 262.
featherstitching, 214, 261.
French knots, 262.
hem, 264.
herringbone or catch, 263.
lazy daisy, 262.
outline, 262.
satin, 263.
- English architecture, 19.
- Entertainment in the home, 12-13.
- Entre deux* in undergarments, 211.
between rolled edges, 211.
use in seams, 211.
- Ethics of purchase of underwear, 202.
conditions of labor, 202.
- Fashion, 299-302.
selection of, 299.
simplicity, 299.
study of history of, 274.
- Featherstitching, 214, 216-262.
- Fibers, principal vegetable,
coir, 147.
cotton, 97-129.
flax, 131-147.
hemp, 146.

- Fibers, principal vegetable,
 jute, 146.
 pina, 147.
 ramie, 146.
- Filters, water, 47.
- Filtration plants, 47.
- Fire-escapes, 32.
- Fireplaces, 37-38.
- Fixtures, bathroom, 88.
- Flax, 131-147.
 antiquity of, 133.
 appearance of, 132, 190.
 botany of, 131.
 breaking of, 133.
 by-products, 133.
 composition of, 190.
 culture of, 132.
 retting of, 132.
 rippling of, 132.
 scutching, 133.
 varieties of, 131.
 where grown, 131.
- Floors, 67-69.
 structure of, 34.
 wood, hardwood, 67-68.
- Floor covering, 67-72.
 carpet, 70.
 linoleum, 69.
 rugs, 71-72.
 oriental, 72.
 rag, 72.
- Franklin stove, 38.
- French costume, 279-286.
- Furnace, hot air, 40.
- Furnishing of the home,
 bathroom, 88.
 bedroom, 86-88.
 dining room, 88-90.
 functions of, 55.
 halls, 94.
 kitchen, 95.
 living room, 90-92.
 reception room, 92-93.
- Furniture, 72-83.
 "cottage" 77.
 English furniture makers, 75-76.
 how to choose, 73-75.
 mission, 77.
 willow, 79.
- Gas, lights 43.
 stoves, 40.
- Greek and Roman costume, 276-279.
- Gymnasium suit,
 construction of bloomers, 337.
 construction of waist, 337.
- Hair, 305.
 arrangement of, 349.
 bows on, 349.
 hats in relation to, 305.
 hygiene, 305.
- Hallways, 31.
- Harmony in the home, 4, 5.
- Hats,
 bow making, 363-365.
 buckram frame, 350-356.
 covering of, 350-356.
 making of, 350-354.
 hygiene of, 305.
 lining of, 356.
 suggestions for trimming, 366.
 wire frames, 357-362.
 covering of, 361.
 making of, 337-361.
 straw sewing, 362.
- Heating the house, 37-41.
 fireplaces, 37-38.
 furnace, hot air, 40.
 hot water, 40-41.
 steam, 40-41.
- History
 of embroidery, suggestions for
 study, 257-260.
 of costume, 274-286.
- Home, the,
 atmosphere of, 1, 2.
 decoration of, 55.
 education in the, 5, 9.
 entertainment in, 2, 3.
 furnishing of, 12.
 influence of, 2, 5.
 mistress of, 9-11.
 sanitation in, 4-5.
- Home decoration, principles of, 55-60.
- Home furnishing, functions of, 55.
 æsthetic, 55.
 economic, 56.

- Homemaker, the ideal, 11-12.
 Homemaking, the aim of, 4-5.
 Honesty in home ideals, 3.
 Hot water heating, 40.
 House, the, 15-29.
 additions to, 22.
 apartment and block, 17.
 architecture of, 18-25.
 color of, 25.
 exposure of, 26.
 inner finish, 34.
 materials for, 21, 33.
 plans of, 30-32.
 requirements in, 15-17.
 single, the, 18.
 structure of, 32-35.
 surroundings, 17.
 Hygiene of clothing, 303-310.
 corsets, 305.
 hats, 305.
 rubbers, 305.
 shoes, 304.
 underwear, 307-310.
 Hygroscopic power of material, 191-193.
 Ice supply, 48.
 Ideals for homemaking, 3-5.
 cleanliness, 4.
 godliness, 4.
 harmony, 4.
 honesty, 3.
 orderliness, 4.
 right living, 3.
 simplicity, 3.
 unity, 1, 4.
 Italian architecture, 20.
 Jacquard weaving, 118-120.
 Kitchen, 31.
 convenience to dining room, 31.
 ventilation of, 31.
 Lace, 208, 211, 323.
 for underwear, as decoration, 211.
 mitering of, 214.
 renovation of, 323.
 Laundry bags, construction of, 246.
 Linen cloth manufacture, 137-143.
 finishing in, 139-142.
 beetling, 142.
 calendering, 142.
 rub boards, 142.
 pattern making in, 138, 140, 141.
 use of Jacquard loom, 139, 140.
 warping, 138.
 weaving, 137.
 Linen industry in United States, 144.
 Linen materials, 145.
 Linen yarn manufacture, 133-137.
 hackling, 135.
 roughing in, 135.
 spinning:
 wet, 137.
 dry, 137.
 spreading, 136.
 use of flax wheel in, 134.
 uses of yarn, 134, 143.
 Lighting the house, 42-44.
 candles, 43.
 electricity, 44.
 gas, 43.
 lamps, 43.
 Living room, the, 90-92.
 Loom, the, 114-116.
 hand, 114-115.
 harnessing of, 116, 118.
 heddles, 116.
 inventors of, 116.
 Jacquard, 118.
 parts of colonial, 115.
 power, 116.
 primitive, 114.
 spooling for, 117.
 warping for, 117.
 Manufacture of
 cotton cloth, 113-121.
 cotton thread, 112-113.
 cotton yarn, 106-110.
 linen cloth, 137-143.
 linen thread, 143-144.
 linen yarn, 133-137.
 woolen and worsted cloth, 159-164.

- Manufacture of
 woolen and worsted yarn, 151-159.
- Materials, adulteration of, 194-196.
 conductivity of, 191-193.
 hygroscopic power of, 191-193.
 tensile strength of, 191-193.
- Materials,
 common cotton, 122-127.
 common linen, 145.
 common silk, 183-185.
 common woolen, 165-168.
- Mercerization of cotton cloth, 121.
- Microscopical appearance of
 cotton, 98, 189.
 flax, 132, 190.
 silk, 172, 190.
 wool, 148, 188.
- Middy blouse, 333-334.
- Millinery, 348-367.
 bow making, 363-365.
 making of hats, 350-363.
 selection of hats, 348-350.
 suggestions for trimming, 366-367.
- Mistress of the home, 9.
 common sense, 11.
 foresight, 10.
 health of, 10.
 self-control, 10.
 sympathy of, 10.
 tact of, 10.
 training of, 10.
- Moth, silk, 171-172.
 Bombyx mori, 171-172.
 wild, 171-172.
- Nightdress, 255-256.
 construction of, 248-249.
 pattern of kimono, 226-228.
 with sleeves, 237.
- Oil stoves, 40.
- Order in the home, 4, 5.
- Patching, 328, 329.
- Patterns, 217-243.
 chemise from shirt waist, 237.
 corset cover from shirt waist, 238.
 drafting of, 226.
- drawers, 228.
 interpreting, 219.
 kimono nightdress, 226.
 measurements for, 217.
 nightdress from shirt waist, 234.
 peplum, 238.
 selection of commercial, 218.
 shirt waist, 230.
 testing and altering, 220.
- Petticoat,
 construction of, 251.
 pattern of, 239.
 sateen or silk, 239.
- Physical education in the home, 6, 7.
 cleanliness, 7.
 exercise, 6.
 food, 6.
 fresh air, 6, 7.
 water, 6.
 work, 7.
- Pictures and picture moldings, 84, 85.
 framing of, 85.
 hanging of, 85.
 selection of, 84, 85.
- Pillow cases, making of, 245.
- Plumbing, 50, 53.
- Porch cushions, 268.
- Problems in sewing, 245-256.
 hand and machine made, 248-253.
 machine made, 245-247.
- Ramie, uses of, 197.
- Reception room, the, 92, 93.
- Religious education in the home, 8.
 character building, 8.
 reverence, 8.
- Remodeling, 327.
- Rental, 35.
- Repair of clothing, 327-330.
 darning, 329.
 dyeing and tinting, 322.
 mending, 327.
 patching, 328.
 remodeling, 327.
 renovating and cleaning, 321.

- Richards, Ellen H. (Frontispiece).
 mottoes for right living, 13.
- Roof, the, 19, 22, 34, 35.
 architectural importance of, 19-22.
 gambrel, 21.
 hip, 19-21.
 lean-to, 21.
 materials for, 34, 35.
- Rooms,
 arrangement of, 30.
 convenience of exit, 30.
 economy of space, 30, 31.
 wall space in, 31.
- Sewage disposal, 48-53.
 city and town, 49-50.
 farm, 48, 49.
- Sewerage system, 51.
- Sewing, 200-215.
 hand *vs.* machine, 200, 201, 203.
- Sewing machine, 204-208.
 care in use of, 207.
 kinds of, 204.
 practice on, 206.
 study of parts before practice, 205.
- Sheep, 148-151.
 shearing, 151.
 raising, 148.
- Shirt waist, 333-336.
 construction of lingerie, 334.
 construction of tailored, 338-342.
 pattern of, 220-238.
- Shoddy, use of, 164.
- Shoes,
 care of, 320.
 hygiene of, 304-305.
- Silk, 171-190.
 antiquity of, 172.
 appearance of, 172.
 artificial, 186.
 composition of, 190.
 cost of, 175.
 culture of, 172.
 raw, 175.
 reeled, 174.
 source of, 171.
 varieties of, 171.
 waste, 179.
 where grown, 171.
- Silk cloth manufacture, 178-179.
 adulteration in, 180.
 dyeing, 178-180, 182.
 finishing, 182.
 pattern making in, 182.
 use of Jacquard loom in, 178, 181.
 warping, 178.
 weaving, 182.
 weighting, 180, 182.
- Silk industry in the United States,
 186, 187.
- Silk materials, 183-185.
- Silk moth, 172.
Bombyx mori, 171, 172.
 wild, 171, 172.
- Silk ribbon, manufacture of, 179.
- Silk worms, 172.
 classification of, 171.
 culture of, 172, 174.
- Silk yarn manufacture, 175.
 dyeing, 179.
 opening of hanks, 175.
 throwing, 175.
 use of organzine, 176.
 use of tram, 176.
 uses of, 176.
 winding, 176.
- Simplicity of living, 3, 4.
- Skirt patterns, 239-242.
 five gored, 242.
 four gored, 242.
 foundation, 239, 240.
 six gored, 240, 241.
- Skirts,
 construction of tailored, 336,
 337.
 patterns of, 239, 242.
- Spanish architecture, 20.
- Spinning, 110, 113.
 distaff, 110.
 flax wheel, 110.
 great wheel, 110.
 inventors of machinery for, 111.
 mule spinning machine, 111.
 of flax, 135, 137.
 ring spinning machine, 112.
 spindle, 110.
- Stains on clothing, removal of, 324.
- Stairs, 31.

- Steam heating, 40, 41.
 Stocking bags, construction of, 246.
 Stoves, 38-40.
 coal, 38.
 Franklin, 38.
 gas, 40.
 oil, 40.
 wood, 39.
 Structure of house, 32-35.
 cellar, 32.
 roof, 34.
 walls, 34.
 floors, 34.

 Table runner, 270.
 Tests for fibers, 196-199.
 burning, 198.
 chemical, 196, 197.
 microscopical, 198.
 washing, 198, 199.
 Textiles, 97-199.
 comparison of fibers, 188.
 reason for study of, 188.
 Thread manufacture, 112, 113.
 bleaching, 113.
 cotton, 112.
 dyeing, 113.
 linen, 143.
 reeling, 113.
 silk, 176.
 twisting, 113.
 Towels, 268-269.
 guest, 269.
 initial on, 269.
 Trap, the S, 50-51.
 Traveling cases, construction of, 246.
 Tucking, 213.

 Undergarments, 200-215.
 conditions under which made, 202.
 construction of, 244.
 cutting out of, 244.
 fitting of, 245.
 flat trimmed, 210.
 hand *vs.* machine made, 201.
 hygiene of, 307.
 materials of which made, 208.
 trimming for, 210.
 use of *entre deux* on, 211.

 Underwear, 200.
 hygiene of, 307-309.
 Unity in the Home, 1-4.

 Ventilation, 37, 41, 42.
 Ventilating systems, 41.

 Walls of house, 34.
 materials used, 34.
 space for furniture, 31.
 structure of, 34.
 Wall papers, 64-67.
 borders and friezes, 66.
 ceiling papers, 67.
 figured, 64-66.
 plain, 64.
 striped, 66.
 Walls, the covering of, 60-67.
 burlap, 60.
 exposure of, according to, 62.
 location of room, according to
 61.
 paint, 60.
 paper, 60.
 sanitation, 60.
 shape of room, according to, 62.
 size of room, according to, 62.
 use of room, according to, 62.
 Water, 45-48.
 contamination of, 45, 46.
 purification of, 45-46.
 sources of, 45.
 Water closet, 53.
 Water filters, 47.
 Weaving, 113-120.
 pattern in variations of, 116-118.
 primitive, 114, 115.
 process of
 battening, 115.
 picking, 115.
 shedding, 115.
 use of shuttle in, 115, 116.
 Wells, 46.
 Whipping of ruffles, 212.
 Windows, 22-30.
 architectural effect, 22.
 care in placing, 30.
 for ventilation, 30.
 Wood stoves, 39.

Woodwork, the, 69-70.

Wool,

appearance of, 148, 188.

composition of, 188.

culture of, 151.

source of, 149.

varieties of, 150, 151.

where grown, 148.

yolk in, 151, 152.

Woolen and worsted cloth manu-
facture, 159.

finishing,

burling, 162.

dyeing, 160.

fulling, 162.

mending, 162.

shearing, 163.

harnessing, 160.

pattern in, 160.

warping, 159.

weaving, 160.

Woolen and worsted yarn manu-
facture,

carbonization in, 154.

carding, 158.

combing, 158.

difference between, 156, 158, 159.

drying, 153, 154.

gilling, 158.

sorting, 151.

spinning, 158, 159.

substitutes in, 155, 156.

tops, preparation of, 158.

uses of, 158, 163, 164.

washing, 152, 154.

Wool industry in the United States,
169.

Wool materials, 165-168.





THIS BOOK IS DUE ON THE LAST DATE
STAMPED BELOW

AN INITIAL FINE OF 25 CENTS

WILL BE ASSESSED FOR FAILURE TO RETURN
THIS BOOK ON THE DATE DUE. THE PENALTY
WILL INCREASE TO 50 CENTS ON THE FOURTH
DAY AND TO \$1.00 ON THE SEVENTH DAY
OVERDUE.

AUG 5 1936

NOV 19 1936

FEB 24 1939

FEB 3 1941

YB 15270

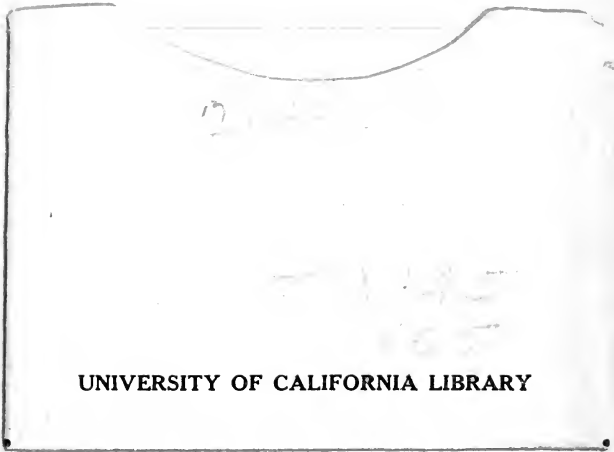

UNIVERSITY OF CALIFORNIA LIBRARY

