

A SHORTER COURSE IN WOODWORKING

A PRACTICAL MANUAL FOR HOME AND SCHOOL

CHARLES G. WHEELER



Class TT 180

Book 1148

Copyright N^o _____

COPYRIGHT DEPOSIT.

BY CHARLES G. WHEELER, B.S.

Woodworking for Beginners

A Manual for Amateurs

A Shorter Course in Woodworking

A Practical Manual for Home and School

A SHORTER COURSE IN WOODWORKING

A Practical Manual for Home and School

BY

CHARLES G. WHEELER

AUTHOR OF "WOODWORKING FOR BEGINNERS"

WITH 765 ILLUSTRATIONS

G. P. Putnam's Sons
New York and London
The Knickerbocker Press

1911

THIRD
11-8

COPYRIGHT, 1911
BY
CHARLES G. WHEELER



The Knickerbocker Press, New York

© CL A 259332

PREFACE

TEACHERS, parents, business men, and mechanics are demanding that the training of youth be more practical. A satisfactory system must meet the demands of the pupil or the individual student, that his interest and enthusiasm may be so aroused as to call forth his best efforts; of the educator, that the subject may be presented to the pupil in the way best for his general development; of the mechanic, that the most practical methods may be adopted; and of the business man that the pupils be trained in up-to-date methods and modern ways of thinking.

This book is not meant to conflict with courses in woodworking now in use, but rather to fit in with any system; for the approved methods of work—the result of the experience of generations of workmen—should be known to all teachers, pupils, and individual students.

No set course of procedure can be adopted by all, nor is there any necessarily logical order in which many of the tools and operations must be taken up, although some are naturally brought into use before others. Therefore the material in this book is so arranged that it can be used in any order, and any desired topic can be referred to readily.

When class exercises are begun with oral and manual demonstrations many pupils do not readily grasp and assimilate the new ideas, technical terms, and details during one demonstration by the teacher, and it is believed that a general manual which can be used as a text-book and reference-book will be helpful and time-saving to both teacher and pupil.

Manual training, from a pedagogical point of view, is a com-

paratively new subject. Therefore many teachers of woodworking naturally belong to one of two classes at present. First, professional teachers who have studied the subject with reference to teaching, and, second, skilled mechanics who have taken up the work of instructing. It is natural and inevitable that many of the first class should be more or less lacking in practical knowledge and breadth of woodworking experience, and that those of the second class should lack the knowledge, training, and experience of the teacher. It is hoped that this book may be of help to both classes and also of use to the independent student.

A number of what may be called typical models are given—simple examples of various classes of work. These are to show the approved methods of construction, and the principles are applicable to many similar articles.

The aim of the systems of work used in schools ranges all the way from the general development of the pupil's faculties to turning out trained workmen. Each of these systems has its place, but in the matter of using the modern machinery there is some disagreement between the methods of many schools and those of the work-shop. The day has passed for the old-fashioned all-round mechanic who was a hand-workman only. The day for the modern narrow specialist who is but a cog in a machine is passing away. The mechanic of the future must not only be an all-round hand-worker but he must also understand and use the machines of his line of work. He will be broader and better-developed than those of either of the other two classes. This fact seems to be overlooked by some who advocate an almost interminable course of hand-work alone, on the ground that it is best for the general development of the pupil. Often he is kept using tools for their educative value which the mechanic never uses unless obliged. For example, no practical workman would think of using a bow-saw for anything which could be done by a band-saw or jig-saw, while the pupil is kept at work with this almost obsolete tool, long after he has learned from it all that is worth while. On the other hand the extremists who would have nothing done by hand

which can be done by machine would cause the pupil to miss the great development and training (physical, mental, and moral) which undoubtedly comes from varied and continued hand-work.

Machinery is of course unsafe for small children, and it is good practice for hand and eye to use the bow-saw, for example, therefore the pupil should learn the use of this tool, but having mastered it reasonably well he should not be obliged to use it longer. If old enough he should be taught the use of the band-saw (or the jig-saw), for machinery has its educative value as well as hand-work. If too young to be trusted with machinery the sawing should be done for him. If power-machines are out of the question, excellent ones to be run by foot (or hand) can be bought for a small sum. Also, for another example, after the pupil has acquired the skill to plane down surfaces accurately, it is a great waste of time, and is discouraging, for him to continue to do work which should be done by machinery.

Looked at from an artistic and sentimental point of view there is something about hand-work—the personal equation—which no machine can supply, but from a purely mechanical point of view it is idle to claim, as is frequently done, that hand-work is necessarily superior to thoroughly executed machine-work. Two men cannot scrape a board in a day so accurately and smoothly as a first-class scraping-machine can do it in fifteen seconds. We may prefer the hand-scraped table for its human touch, but mechanically it is inferior to that scraped by machine. In most so-called hand-work of the present day machinery is largely used to save time, labor, and expense. It is a mistaken view to scorn the help of machinery. The advantages of hand-work need not be sacrificed, but the position of machinery must be recognized, for it has come to stay and the age demands it. The time saved by the help of machinery will enable him who has hand-work, or general development, alone in view to advance to more difficult problems in hand-work, instead of being held back by doing over and over again what he has once learned.

The way which seems the most logical and to promise the best

all-round results, whether the final aim be general development or special technical training, is to follow the natural process of evolution. That is, give the pupil a good thorough course in the essentials of hand-work. When he has acquired a reasonable degree of skill with any tools and processes now obsolete in practical work, let such work thereafter be done by machine. There will still be enough hand operations left to test to the utmost the skill of the most brilliant pupil or instructor. It is partly a question of time-saving. The question is not whether the pupil is well employed or not, but whether his time is being used in the *best* way and so as to save as much as possible for further advancement.

The maker of a manual on the subject of woodworking is in danger of saying too much or too little. If he is not explicit enough the pupil is hindered from lack of sufficient data. If he explains matters which should be learned by observation, experience, investigation, and experiment or which should be left to the intelligence and common-sense of teacher and pupil, he retards the student instead of developing his faculties. The effort has therefore been made to give the necessary facts and no more, that each teacher may be free to arrange his methods of procedure according to his circumstances, and that the pupil may have a chance to work out his own salvation.

It is wished to keep this book up to date, therefore notification of errors and omissions, or any suggestions, sent the author under care of the publishers, will be gratefully received.

C. G. W.

TO TEACHERS

THE teacher of woodworking is often looked upon as one who need only be proficient in the practical execution of woodwork. But to get the best results he must have as good pedagogical training as other teachers, and to this he must add practical knowledge of the work itself. In fact it is doubtless better that he be a teacher first and a mechanic afterward, than that he be a mechanic first and a teacher afterward. But nothing less than a happy combination of excellence in both respects will do full justice to the pupils.

The wise teacher of woodworking, as of many other studies, will not tell the pupil what he can learn better by observation and experience. The pupil enjoys finding things out for himself, and what he learns by experience he remembers. As a practical matter, however, there are many things which, as time is limited, had best be told or shown. Nor will the judicious teacher yield to the temptation to help in the actual work. The pupils should never learn to rely upon him to do any of their work for them.

The tools must be sharp and in good condition. It is useless to expect satisfactory results with dull tools. The wood should be clear, dry, straight-grained stock. The novice cannot be expected to do good work with anything else. The benches and all of the equipment should be kept in good working order.

To be sure that the pupil has a clear idea of the work he is about to do before he begins the teacher must first understand it himself, and it is easy to be over-confident in this respect. In elementary work make every article yourself before giving it to a pupil to make, unless you are an experienced mechanic, and it is a wise thing to do even then. It is astonishing what unforeseen difficulties or objec-

tionable features sometimes develop in the process of making simple objects, and the teacher should not get caught by difficulties which the experienced workman would foresee. Besides, the pupils are as quick to discover the limitations of the teacher's knowledge in wood-working as in other branches. By this it is not meant that the teacher must be an experienced workman in order to do useful work as an instructor—for to teach some woodworking it is not necessary to know all woodworking—but he should not fail to understand all the details of every problem which he knows to be before him.

The beginner should at the outset learn the construction, adjustment, and management of every tool, as it is harder to do this after his interest has become centred on the actual work. Similarly, unless the pupil be held to a good standard of execution in the early work, it will be difficult to do so in the more advanced articles. In woodwork, as in drawing and other branches, the sense of accuracy is in many cases very defective, but usually can be gradually developed until the pupil can see for himself inaccuracies which at first he could not see even when pointed out. On the other hand there is danger in striving for too minute exactitude with some pupils, to the exclusion of other matters, lest they never have time to learn anything else.

It is easy for a teacher to become so absorbed in a set of models as to think the reproduction of them by all the pupils to be the end and aim of manual training, forgetting, in his zeal for the routine of the work, that the pupil has brains to be cultivated, as well as hands and eyes. Originality and spontaneous effort should be encouraged, and the power developed to overcome difficulties other than those of mere manual dexterity. Manual dexterity often requires but little brain power beyond the faculty of attention to the work in hand. After a time, as the pupil begins to acquire skill, certain movements and operations become more or less automatic and cease to require the higher order of faculties. Therefore he should then have projects which require more than mere attention,—something mentally stimulating. If all his work is carefully laid out for him and

all his thinking done for him in advance, he is losing perhaps the most important part of his training. Thus there is danger that he may acquire a good degree of manual skill without the power to apply it usefully to the purposes of everyday life. Therefore in zeal for details and for turning out an accurate set of "models" the teacher should not lose sight of the broader aspects of the subject.

If a pupil spoils a piece of work do not feel that you must in every case keep him making the article over and over again, until it is satisfactory. This soon becomes very discouraging and should not be done too often, but he should be allowed to advance to some new problem by which the desired end can be reached.

The prevailing opinion seems to be that the best method for elementary work is to have the pupils make a progressive series of useful articles. Besides this, the objects should be such as to arouse each pupil's interest, and touch so far as possible his life and the things which naturally appeal to him and the things which are suitable to the community. The teacher is, or should be, looking at the pupil's ultimate benefit, but the pupil (unless quite mature) is looking at the object he is making as the end in view. He may understand and appreciate the purpose of his schooling, but the direct interest of a young pupil is more in the article he is making than in the training he is getting, and without his interest and enthusiasm a full measure of success will never be attained.

In real life woodworking is done for some definite end. Things are made because they are wanted,—because there is some reason for making them. In school they are often made with the idea that what is learned may be of some use later in life (what may be called disciplinary or preparatory work), but the work in a school shop should be real work,—a part of real life, not merely a preparation for what may or may not come later. The pupils are as much a part of life now as they ever will be, and what young pupils are interested in is life *now* and not in preparations for the future. Their tasks should be so far as possible a part of home or school or outside life. There should be some definite useful and present purpose in all their work.

Let the teacher who doubts this try giving his pupils work which appeals to them and work which does not, and he will soon learn the difference. There is as much educative discipline in work which is a part of the pupil's present life as in that in which he can take but little interest. As he grows older and becomes more proficient this problem of seeing that he has suitable work will take care of itself.

The greatest difficulty in arranging a course of work for the beginner lies in the early stages,—in so introducing him to the work that he can have something suitable to do,—something worth while—and still use no more tools and operations at the same time than can be understood readily or than can be kept track of by the instructor. After the pupil has once learned the elementary uses of the common tools and the elementary operations, there is no further difficulty in finding suitable work for him. In fact he will often provide himself with a greater number of good projects than it is possible for him to execute.

In regard to allowing pupils in their early work to choose what they shall make, it is well at first to let them select from but few carefully considered articles, giving them wider choice as they progress. The different groups from which they may be allowed to choose should, however, be thought out carefully, that the objects in each group may offer similar problems and difficulties, and the groups themselves be progressively arranged. Many pupils wish to make things which are too hard and would take too long to do properly. On the other hand do not feel that only short jobs should be undertaken. A comparatively long piece of work about which the pupil has enthusiasm is better than a short one in which he takes no interest. The discipline—the mental and moral training—which comes from sticking to work and working hard at it until it is as well done as can be expected is lost if only quickly executed work is undertaken. Therefore, when the pupil's proficiency and mental development will allow, let him have the experience and satisfaction of undertaking and successfully carrying out work which when finished will be of real value and a source of pride to all concerned.

It is important to remember that a well-trained eye is a valuable possession. Therefore have the work tested by eye so far as possible before using instruments, and in the elementary work avoid mechanical appliances and make the pupil rely on hand and eye and the common hand tools. Time-saving and accuracy-securing devices should not be introduced until the worker has attained a reasonable degree of skill without them.

After the pupils have become fairly proficient in the use of the common tools, group-work can sometimes be used to good advantage, provided no pupil is kept too long at any one operation. Objects which give valuable lessons in construction—a side of the work often much neglected—can frequently be made by a number of pupils which it would be impracticable for one to make alone.

The student should be shown different ways of doing work, as it cultivates versatility, adaptability, and resourcefulness. If everything desirable is not available to meet a particular situation, do not give the work up, but encourage the pupil to contrive some way to reach the desired end. The path will not be hewed for him in real life. Let his real life begin in the school. Do not keep him too closely to a set course of procedure. Let him, within reasonable limits, propose, design, and make articles in which he is interested.

Whenever connection can be made between the woodworking and the regular school work this should be done. Comparing notes and interchange of ideas on the part of the different teachers may show ways in which the work can be so correlated as to be helpful and stimulating to the different departments. If a pupil can try to work out in the art department the best design for something which is to be made in the shop, the advantage is too obvious to be neglected. Also, whenever the pupils can use the shop as a laboratory for the working out of any problems or the construction of apparatus for scientific studies it is for the advantage of both departments to do so.

If some project involves the use of other materials than wood do not reject it on that account, if otherwise desirable. A little simple auxiliary work in metals, leather, etc., does not interfere with

the success of the woodworking, but is often a stimulus, and the relation of the different branches of mechanical work is better understood.

The practical work should not be sacrificed for such correlative topics as forestry, lumbering, the growth of trees, their distribution, leaves, etc. Such subjects can be taken up at any time of life, and information about them is accessible to all, but if the best period of life for the manual training proper is once past it cannot easily be recalled. If the time will admit it is of course well to take up the most important of such topics. It is well to have on hand models of joints and the like, as thereby much time is saved. After the most elementary stages different kinds of wood should be used. It is a good plan to have catalogues of tools (these will usually be supplied by the dealers) accessible to the pupils, to increase their interest and give useful information.

Much difficulty is often found in keeping a large class together in the elementary exercises. Supplementary or extra work for the quicker pupils may perhaps answer the requirements of discipline—may keep the class out of mischief—but from an educational point of view such a method is so crude, and so unfair to those who show the most aptitude and are therefore required to “mark time,” that it is hard to justify it on any higher ground than that of expediency. It is certainly doubtful if there be any satisfactory way to keep pupils together in large classes, nor is it desirable to do so except for the difficulty of handling so many individually. Of course each pupil should be free to advance as fast as he can, but if the classes are large it is physically and mentally impossible for the teacher to handle the pupils individually in the early stages of the work, and he has no alternative but to try to keep them together as well as he can. Classes should not be too large to allow every pupil to have the individual attention of the teacher. But this is a subject about which, unfortunately, the teacher is usually not consulted.

The excessive haste of many pupils is a great hindrance to good work. Sometimes advice and reasoning will soon effect a slowing

down; and repeated failures, and incidentally the waste of considerable material, with watchfulness and patience on the part of the teacher, will often bring about a great improvement. This is a hard problem for the conscientious teacher, but he should apply to it careful thought, with study of the individual characteristics, for often some of the most intelligent and industrious workers are afflicted with this trouble in an acute form.

Where machinery is used the teacher who has had extended experience with it will not need to be cautioned about the dangers to which the novice may be exposed—and no one should take charge of such work without sufficient experience—but too much stress can hardly be laid upon insisting that nothing be allowed to distract the attention of any one while working at a machine. All belting, shafting, and gearing with which one can come in contact should be protected, and care should be taken that no pupils work with dangling sleeves or any exposed loose ends of clothing. If the workshop is not supplied with machinery, the pupils should be taken, when sufficiently advanced, to a mill and the machines and their uses studied. Rolls of bandages, antiseptic gauze, absorbent cotton, adhesive plaster, and some antiseptic and healing preparations for cuts and bruises should always be on hand, within reach of all, whether machinery is used or not. Pupils should be cautioned not to put glue on a cut, because of possible infection. In case of a bruise or pounding the nail put the finger at once in as hot water as can be borne.

The teacher of woodworking, dealing as he does with tangible materials and the creation of objects, has constant opportunity to inculcate the virtues of honesty and thoroughness in work. Also, because of the practical nature of the subject, he has a fine opportunity to encourage the pupils, by his interest in what interests them, to talk over with him not merely the projects of the school shop but the outside private mechanical work which so many of them are sure to undertake. He need have no fear that such efforts will not be appreciated, and he may thereby often learn something useful himself.

To attempt to specify the attainments of the ideal manual training

teacher does not come within the province of this book, but it will bear reiteration that it is even more important for him to be a good teacher than to be a good mechanic. While he must read, study, experiment, and keep up to the times in woodworking, he must also be keenly alive to pedagogical progress and to outside interests.

While the position and authority of the teacher must be maintained with proper dignity and kindly firmness, it is not well to try to exact all the conventional requirements of the ordinary school-room, for much freedom of movement, and mental liberty also, is necessary. The successful carrying out of his work is sure to result in much self-government and self-discipline on the part of the pupil. Occasional acts of thoughtlessness or forgetfulness are hard to prevent in any collection of youth, and there may be times when "discipline" must be resorted to, but if the teacher finds the need of much of it in his classes, he should ask himself wherein he has failed to arouse and hold the interest of his pupils. If the teacher does his part as it should be done, there will be little occasion for government, for the pupils will have no desire for mischief, but will be eagerly and zealously attending to business.

CONTENTS

	PAGE
PREFACE	iii
TO TEACHERS	vii
INTRODUCTORY	I
<i>PART I.</i> —COMMON TOOLS AND THEIR USES	6
Tools for laying out and testing work.—Saws.—Chisels.— Planes.—Boring tools.—Other cutting tools.—Tools for putting work together.—Miscellaneous tools and appliances.—Wood- working machines.	
<i>PART II.</i> —OPERATIONS IN SHAPING, FITTING, AND FINISHING WOOD	139
APPENDIX	201
Wood.—A few elementary principles of construction.—Some practical problems in drawing and laying out work. Some types of construction.	
INDEX	275

A SHORTER COURSE IN WOODWORKING

INTRODUCTORY

1. The Process.—Before any complete article can properly be made in woodworking, one must learn its construction, what materials are to be used, and what tools are needed and how to use them.

First, the shape, size, and all the details of the object should be decided upon and understood, and a working drawing with dimensions be made.¹ (See page 217.)

Second, the most suitable materials must be decided upon,—the kind of wood, hardware, and other things necessary.²

Next, the material must be selected and the “stock” got out. To do this the dimensions must be measured and the outlines of the piece or pieces marked out on the wood. Usually these are got out a little too large with saws or other tools and afterwards reduced by planing and other operations to the exact required dimensions.

Finally, the various pieces must be fitted together in accordance with the plan, and the whole smoothed and finished.

2. Estimating, Laying out Work, and Getting out Stock.—An

¹ Whether this drawing should be made by the pupil or be provided for him must depend upon the circumstances and the nature of the work, but he should have a drawing to work from in every case.

² Sometimes it is necessary to do this, wholly or partly, before making the working drawings.

estimate of materials and cost should be made before beginning any but the simplest work. Make liberal allowance for waste which varies with every job and can rarely be foretold exactly. The beginner should have thoroughly seasoned, clear, straight-grained, dry stock. (See page 201.)

The unit of lumber measurement is the "board foot," or "square foot," which means a volume one foot square and one inch thick. This contains 144 cubic inches, and any piece of wood containing 144 cubic inches is a board foot, without regard to its shape. Most lumber is sold by the square foot, the price being set by the M (1000 feet). Thus, if pine boards are selling at \$100 an M, one foot will cost ten cents.

A board 1" thick, 12" wide, and 12' long¹ contains 12 feet, board measure, or 12 square feet. A board 1" thick, 6" wide, and 12' long contains 6 square feet. Thus to measure twelve-foot stock simply find the width in inches. If the board tapers, measure at the middle. In case of a plank² multiply the width in inches by the thickness of the plank. A plank 3" thick, 7" wide, and 12' long contains 21 square feet. This method is easily applied to pieces of which the length or width is a convenient multiple or divisor of twelve.

Boards less than one inch thick are usually sold by the square foot of surface,—the price varying according to the thickness, except where an inch board is planed down, when, of course, inch thickness is charged for. There is no distinction in *measuring* made between a rough board 1" thick and a planed board $\frac{7}{8}$ " thick, as they represent the same amount of lumber.

Some rare woods are sold by the pound, as ebony, leopard-wood, etc. Pieces turned out in quantities for special uses, as strips, mouldings, etc., are often sold by the running foot. Certain regular sizes and shapes of lumber are sold by the hundred or by the piece. Shingles, clapboards, and laths come in bunches or bundles. For other matters relating to Wood, see page 201.

The first, or rough dimensions, for small work, should usually be, for the beginner, about one eighth of an inch greater in thickness than the

¹ The symbol " means inches and ' means feet.

² Planks are more than 1" thick.

final dimensions, about one quarter of an inch greater in width, and about one-half inch, or so, greater in length.

A list, or lumber order, of all the pieces, arranged according to kinds of wood and dimensions, should be made out, so that they can be got out as systematically, quickly, and economically as possible. As different kinds of lumber, different thicknesses, etc., are usually kept in separate piles, state first the kind of wood, next the thickness, and then the width and length.

PINE

<i>No. of Pieces</i>	<i>Thickness</i>	x	<i>Width</i>	x	<i>Length</i>
2 pieces	$\frac{7}{8}$ "	x	12"	x	4'
4 pieces	2"	x	8"	x	2' 6"

OAK

3 pieces	$1\frac{3}{4}$ "	x	3"	x	1' 9"
----------	------------------	---	----	---	-------

A list of hardware,—nails, hinges, screws, etc., can also be made.

Make measurements and lines exact. Do not be satisfied with coming within an eighth of an inch. Cutting to a line does no good if the line is in the wrong place. Go over measurements a second time to be sure there is no mistake.¹ Where there is chance for mistake in putting work together mark the pieces, to show their relative positions, with letters, figures, or other symbols (Fig. 1), and it is also well to roughly mark the places for mortises, tenons, etc. In many kinds of work allowance must be made for expansion and contraction. (See page 211.)

Lay out work from one edge or surface only, for you can rarely be sure

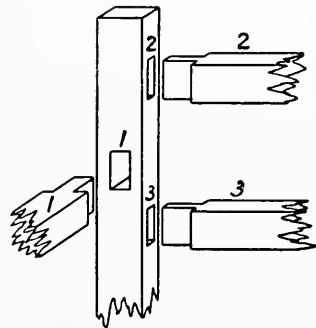


Fig. 1

¹ In rough work, where many pieces of the same length are to be got out use the first as a measure for all the rest.

that the edges or surfaces are exactly parallel. Select the best surface for the "face" and the best edge for the "joint-edge." Make a mark on each to avoid mistakes, and lay out the work from this side and edge only. A mark like a V as in Fig. 2 will designate both working-face and joint-edge.

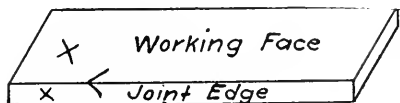


Fig. 2

In some work the face side should be the side which shows, as the top of a table or the front side of a picture-frame; but the face sides of the legs of tables, chairs, etc., should be on the inside to ensure accurate joints with the rails and other parts.¹ (Fig. 687.) In the same way the joint-edges in such work as door-frames, etc., should be on the inside. It is essential that all working-faces and joint-edges should be planed true in all cases where joints are formed.

Operations of the same kind should be done at the same time so far as possible. Lay out duplicate pieces together (Figs. 3 and 4), mark



Fig. 3

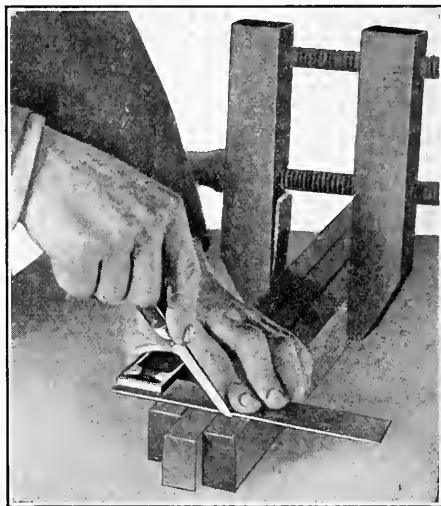


Fig. 4

¹ If otherwise suitable, the concave side of a warped board is the best for the face side, because it is the best to plane first. (See page 165.)

similar details, and do similar sawing, planing, boring, etc., at the same time.

3. The Work-shop.—A work-shop should be well lighted and properly heated, and dry, lest the tools rust and the work be injured by dampness. The floor should be of wood. Concrete is bad in case of dropping tools, and the dust from it is objectionable.

It is an advantage to have windows on all sides of the shop. In any case the worker when standing at his bench should face the light and have it also on his left so that it may fall properly on his work.

Except for childish work the only advantage of double benches for school use is in saving space and expense. Each pupil should have his own individual bench. (See page 80.)

Separate benches, which may be of a cheaper quality, should be provided for finishing, filing metal, and other work which might hurt the regular benches.

Have everything where it can be reached in the least possible time, the tools used most nearest to the worker. Have tools that go together, as bit-brace and bits, kept near together. Have all the common tools within reach, instead of put away in chests and drawers.

Oily rags should either be burned at once, or, if a few are kept, should be kept in a stone jar or covered tin box. They are dangerous. If there is any dampness in the shop, the steel and iron parts of the tools should be rubbed, after using, with a little fat,—tallow, lard, wax, vaseline, oily cloth, or some anti-rust preparation.

PART I

COMMON TOOLS AND THEIR USES ¹

TOOLS FOR LAYING OUT AND TESTING WORK

THE most important are the Rule, Square, Knife, Scratch-awl, Pencil, Bevel, Gauge, Compasses, Straight-edge, Chalk, Chalk-line, Level, and Plumb.

4. **The Rule**, used to measure and lay out work, is divided into inches, halves, quarters, eighths, and sixteenths. To mark distances for accurate work, lay the rule on edge so that the divisions on its side touch the wood (Fig. 5). In making several small measurements



Fig. 5

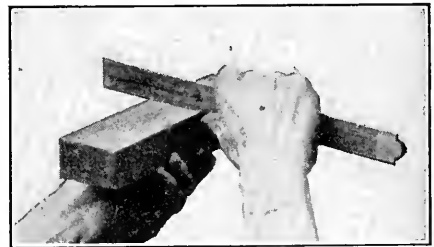


Fig. 6

do not move the rule (Fig. 5). To measure as in Fig. 6, use any divisions on the rule rather than its end, for the end is likely to be

¹ A number of illustrations of tools are given through the courtesy of the Stanley Rule and Level Co., New Britain, Connecticut.

inaccurate, and is harder to place in line with the edge of the wood. The thumb will help adjust the rule.

A two-foot rule, folding once, is convenient for bench-work. A four-fold rule, folding to six inches in length, is better to carry around, and many prefer to begin with it because of its common use among workmen. The

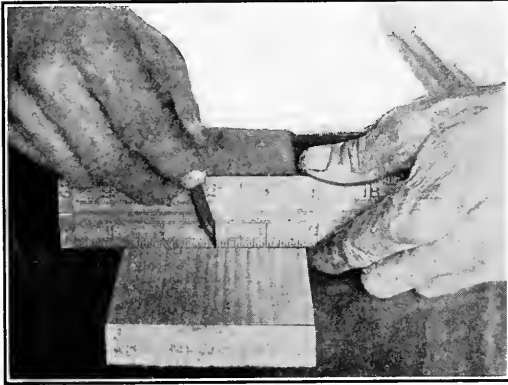


Fig. 7

zigzag folding rule from 2' to 8' long is convenient, fairly accurate, and in common use. The extension or slide rule is useful for obtaining inside dimensions (see below). The caliper rule is also good for small outside measurements (see *Calipers*, page 21). A stick six feet long and another ten or twelve, with feet and inches marked, are handy in laying out work.

To find the middle of a given distance, as the width of a board, with the rule, slide it across the surface until some inch-mark is at an equal distance from each edge of the board (Fig. 7).

To divide a distance, as the width of a board, with the rule, into an equal number of parts, place the rule so that the required number of equal divisions upon it will just reach from one edge of the board to the other, and make a dot exactly at each division (Fig. 8).

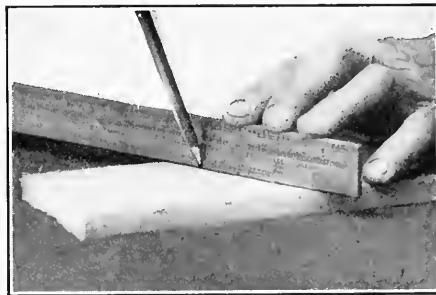


Fig. 8

To find the distance between two points, where it is not convenient to use a common rule, measure with an extension or slide rule; or, where you cannot mark the distance on a single stick, two sticks may be used as in Fig. 9.

5. **The Square.**—The *try-square* is to test right-angled work, and to mark lines at right angles across surfaces. Keep the beam or head (Fig. 10) pressed against the surface to which it is applied, and the blade will then be in position for either marking or testing a right angle (Figs. 11 and 12).

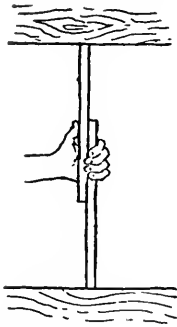


Fig. 9

A good way to mark with the square is to place the knife on the given point and slide the square along until it hits it (Fig. 11). Then draw the line. To continue such a line upon the adjacent surface, place the knife at the end of the line as in Fig. 13, slide the square up to it, and mark the

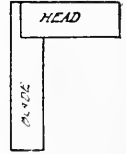


Fig. 10

next face.

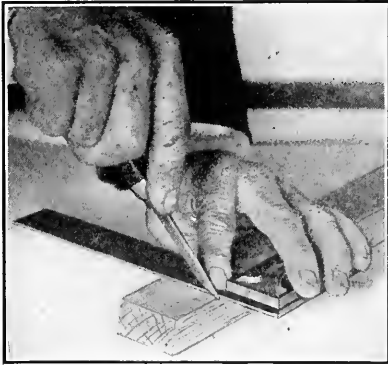


Fig. 11

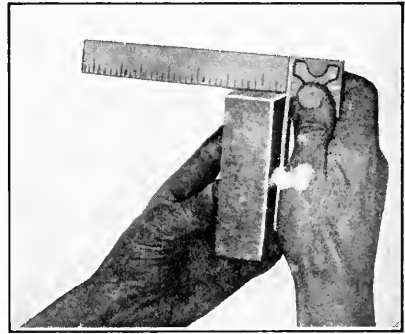


Fig. 12

In testing a surface or edge with the try-square (Figs. 12, 14, 15), place it at several points. Face the light.

The best try-squares are entirely of metal. A medium-sized one (9- or 10-inch blade) is more useful than a small one. A scale is often marked on the blade. Sometimes the end of the head or beam next the blade is cut on a bevel (Fig. 16), for mitring (see page 142), but the

bevel is so short that it is accurate only for very small work. (See *Bevel*, page 10.)

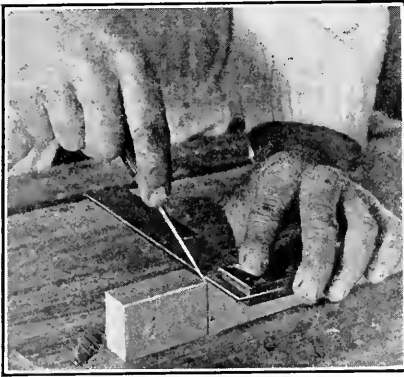


Fig. 13

To square across or around an hexagonal, octagonal, or cylindrical stick, place a rectangular piece between the head of the square and the stick (Fig. 17).

To lay out a bevel with a square, get out a wedge-shaped piece with the required taper and use it as in Figs. 18 and 19. A saw-kerf can be made in the wedge to admit the blade of the square. (See *Bevel*, page 10.)

The *framing-square*, "steel square," or two-foot carpenter's square, is used like the try-square and is of great value in getting out

stock, in laying out work, and in testing work too large for the try-square. It can also be used as a rule (see page 6), as a straight-edge (see page 16), and to set the bevel at different angles (see page 10.)

Many computations can be made by means of the figures on the blades. For squaring large work, see page 223.

6. The Knife, which should be used for fine, accurate marking may be a common pocket-knife, a sloyd knife, or a special marking knife. The scratch-awl can also be used.

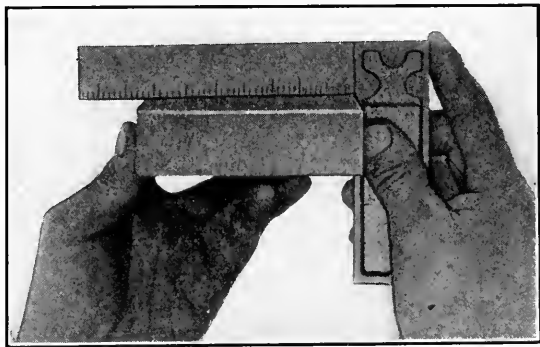


Fig. 14

The marking-awl, or scratch-awl, has a round, sharp point, and can be used like the knife for marking.

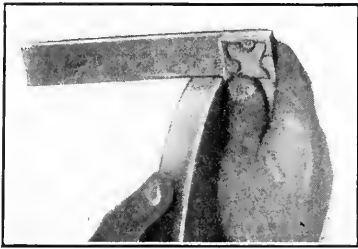


Fig. 15

7. The Pencil.—For moderately nice work a round pencil (medium-hard or somewhat soft) will do. A pencil is best to mark curves which cannot be drawn with compasses. Sharpen pencil points on fine sand-paper or a file kept for the purpose. For framing and the

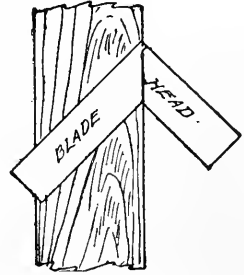


Fig. 16

rougher kinds of carpentry, for getting out stock, etc., a carpenter's pencil sharpened flatways may be used.

8. The Bevel is similar to the try-square, but the blade can be set at any angle. The *mitre-square* is fixed at an angle of 45° , and is better for accurate mitre-work than the adjustable bevel (see page 142). The head of the bevel like that of the square must be held firmly against the wood (Fig. 20).

To get angles of 45° and 135° with the bevel, place it against the in-

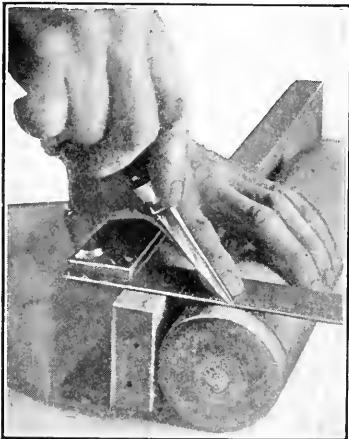


Fig. 17

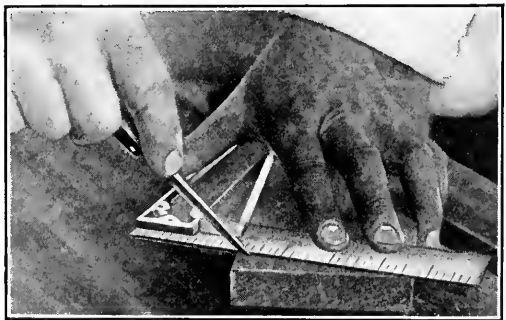


Fig. 18

side edge of the steel-square (Fig. 21), and set the blade at the same distance on each arm of the square.* See also page 226.

* A right angle can be drawn from the straight-edge of a board, points marked at equal distances from the point A (Fig. 22), and the bevel set by these points.

To make a bevel for small work, useful when the same angle is to be tested frequently, take a small block of wood 2" or 3" long and about 1" square, make a saw-kerf in one end, and fit *tightly* in this kerf at the required angle a slip of wood 2" or 3" long (Fig. 23).

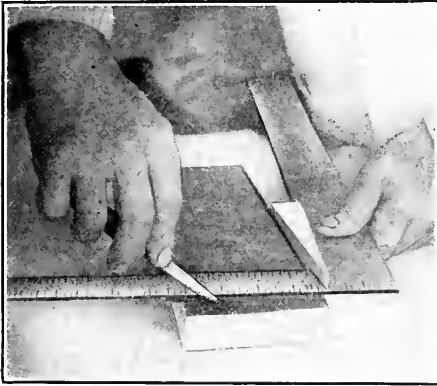


Fig. 19

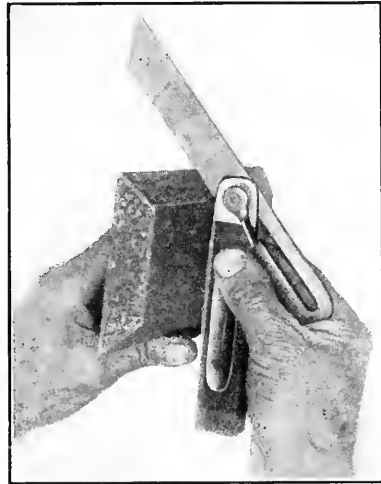


Fig. 20

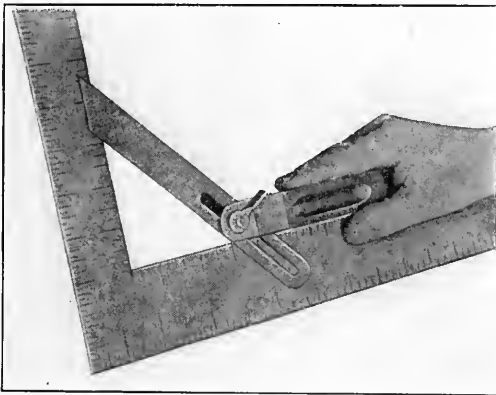


Fig. 21

A Protractor can also be used for obtaining any desired angle.

See under *Square*, page 9, and also page 226.

9. The Gauge is used to draw lines parallel to an edge. It has a block, called the head, stock, or fence, to slide against the edge of the wood, and a bar, beam, or stem, which passes through the block, and

can be set by a thumb-screw to project to the distance required. A spur or marking-point is inserted near the end of the bar, which has the

divisions of a rule marked upon it, by which to set the spur, but it is more accurate to measure with the rule from the head of the gauge to the point of the spur (Fig. 27). It is better to sharpen the spur to an edge parallel with the head (Fig. 24) rather than to a point.¹

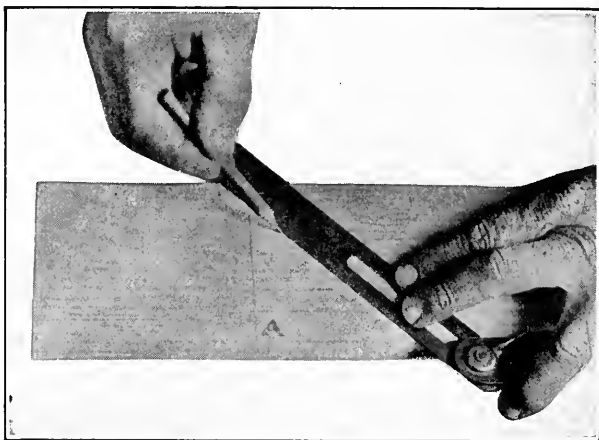


Fig. 22

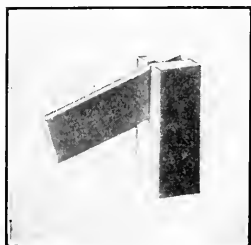


Fig. 23

See that the spur projects from $\frac{1}{16}''$ to $\frac{3}{16}''$. Hold gauge and rule as in Fig. 26. Set the spur at the required distance from the head by adjusting with the thumbs and forefingers.² Tighten the thumb-screw and test the distance with the rule (Fig. 27). Push the end of the piece of wood to be gauged against the bench-stop or some other firm



Fig. 24

object. Hold the gauge as in Fig. 28 in front of you and tip it from you so that the spur will be drawn along the surface and make only a slight mark. Keep the head of the gauge *firmly pressed* against the edge of the wood and push the tool steadily from you.

¹ The spur will make a better line when slightly convex on the side toward the head (Fig. 25). This helps to keep the head close to the wood.

² In getting out stock for nice work, if the gauge is set exactly at the given distance, when the gauge-mark is planed out afterwards, the piece will be slightly smaller than intended, so allow for the width of the gauge-line in such cases. In gauging for joints and the like, set the gauge exactly right and make no allowance.

When the spur is quite far from the head, the gauge can be held as in Fig. 29.

In marking across the grain, unless the spur has a very keen knife-edged point, use the square and knife or scratch-awl instead, for nice work, else the wood may be torn.

Let gauge-marks run by (see page 17) where they will not show after the work is finished. Gauge from the same side of the wood in laying out mortises or any lines to be at a fixed distance from the edge, else the gauging may not come parallel (see page 3).



Fig. 25

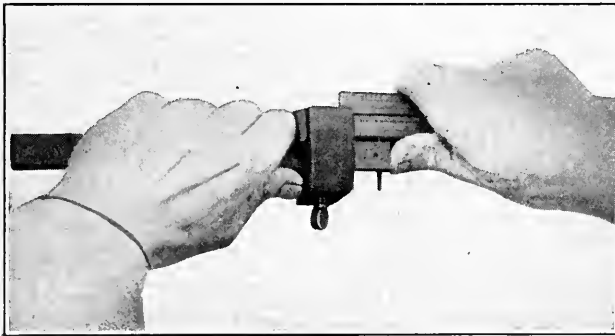


Fig. 26

The only gauge needed in many cases, where accuracy is not called for, is a rule and a pencil. A line may be drawn at a given distance from the edge of a board as in Fig. 30. For lines near the edge, as in chamfering or bevelling, where it

will not do to scratch the wood, the finger and pencil can be used as in Fig. 31, or a gauge with a hole bored near one end of the bar or beam, into which a pencil will fit tightly.

It saves time to have at least two gauges for ordinary work. For special cases a fixed gauge can be

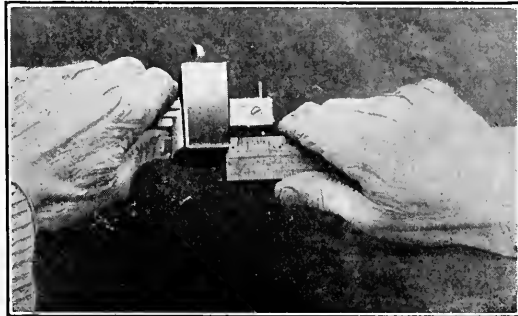


Fig. 27

made (Figs. 32 and 33). The form shown in Fig. 33 is better for straight work because the head is longer.



Fig. 28

The *mortise-gauge* has two spurs, one of which can be set at any required distance from the other, and two lines marked at once, as for a mortise (see page 144). It saves time but is not a necessity and is often hard for the beginner to use.

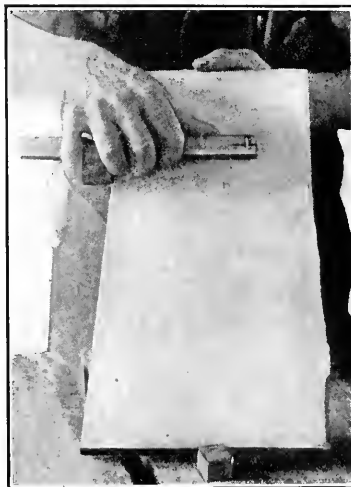


Fig. 29

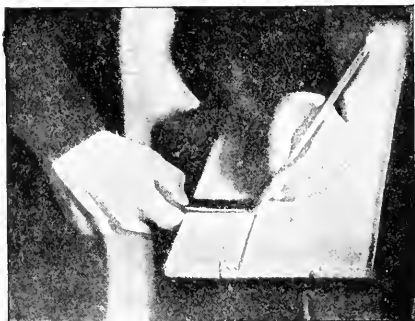


Fig. 30

Some gauges have a steel wheel with sharpened edge instead of a spur. Occasionally a knife point or blade is used for cutting thin stock. There are gauges called panel-gauges, with long beams and heads for wide spaces. One can easily be made.

10. Compasses are used to strike circles or arcs; to lay off angles and arcs; to take measurements from a rule, a drawing, or some object; to lay out measurements; and to "scribe" where a gauge can not be used. To set

them by the rule place the points on the rule as in Fig. 34. When striking circles or arcs, hold the compasses by the top at the hinged joint, as grasping them lower down may cause the points to move; and lean them slightly in the direction they are being turned, so that the marking point will be drawn along smoothly (Fig. 35). Hold them in the same way when "stepping off" measurements.



Fig. 31

Wing compasses, or those with arc and set screw, are easy to adjust and will not slip. A pencil attachment can be used on one leg. In nicely smoothed work a thin slip of wood should be put under the point of the compasses (Fig. 36).

To draw a circular curve at the end of the piece in Fig. 37 set the compasses at one half the width and scribe



Fig. 32

a line at that distance from the end, across the middle of the surface. Also another from one edge. Where the two lines cross, set one point of the compasses and strike the arc as shown in Fig. 38.

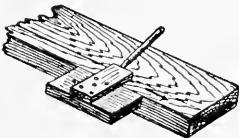


Fig. 33

Or, as in Fig. 39, find the middle of the end (A) and also the same distance (D) from the corner on

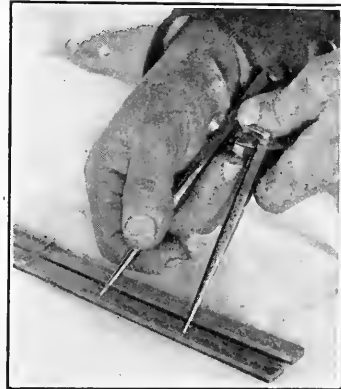


Fig. 34

one edge. From these points with radius AB, strike arcs intersecting at

C. Where marks will deface the work when finished, place a thin piece of cardboard or wood on the surface.

To strike larger circles or arcs than can be done with the compasses,

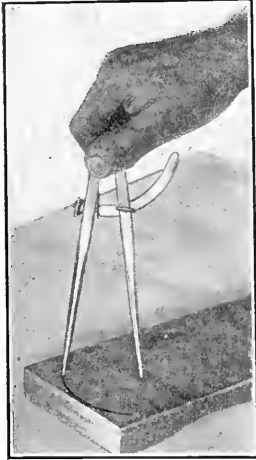


Fig. 35



Fig. 36

a *beam-compass* (sometimes called a *trammel*) is used. This is a rod having sliding sockets which carry steel or pencil points (Fig. 40). As a substitute, two nails (or a nail and a pencil) put through a stick can be used (Fig. 41). This is more accurate than to use a string. (See also page 231.)



Fig. 37

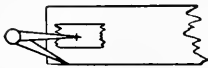


Fig. 38

To scribe a line parallel to another line or surface, as in fitting the edge of a board to an irregular surface as shown in Fig. 42 or 43, run the compasses along with one point on the irregular surface and the other marking the piece to be fitted. See also page 221 for problems requiring the compasses, or dividers.

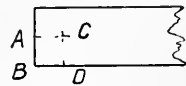


Fig. 39

II. The Straight-edge is used in marking straight lines and for testing the straightness

of edges and surfaces. Any piece of wood or other material that

has a straight edge and is convenient to use can be so called, from a common ruler or the edge of a square to a long board.

When marking by a straight-edge keep the marking tool very slightly inclined away from the straight-edge, but with the point close to

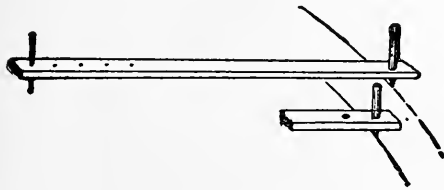


Fig. 41

the edge (Figs. 11 and 13). The marking point often tends to follow the grain of the wood and run off the line, and will force the straight-edge out of place unless the latter be held firmly (see page 220). It saves time to let lines which meet at a point cross one another. Also the crossing of two lines marks a point in the most accurate way. For work to be nicely finished, however, make no unnecessary lines where they will show. Light pencil marks can be removed by a rubber eraser, in preference to sandpaper or scraper.

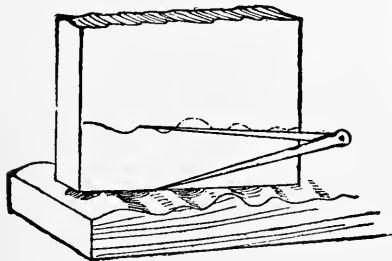


Fig. 42

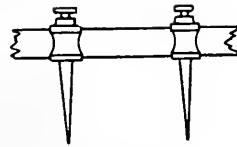


Fig. 40

the edge (Figs. 11 and 13). The marking point often tends to follow the grain of the wood and run off the line, and will force the straight-edge out of place unless the latter be held firmly (see page 220). It saves time to let lines which meet at a point

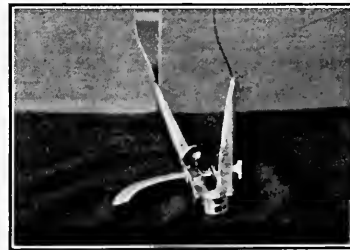


Fig. 43

Every woodworking shop should have at least two or three straight-edges. Good sizes are about 4' long, $2\frac{1}{2}$ " to $3\frac{1}{2}$ " wide, $\frac{1}{2}$ " or $\frac{5}{8}$ " thick; and 8' or 10' long, 4" wide, and about 1" thick. For short work use the edge of the framing-square, or the try-square. Clear straight-grained

white pine or mahogany is good for a straight-edge. Sometimes one becomes curved. To test, mark a fine line by it, then turn it over and see if the edge coincides with the line.

The straight-edge is also used to determine whether a surface is straight or "true." A surface is true only when a straight-edge (in whatever position placed) will touch it throughout.

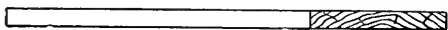


Fig. 44

A surface may be smooth without being true. The board in Fig. 44 is a true surface. Sight across it in any direction and the edges will be in line and no point of the surface above or below the edges. On the other hand, when the board is warped as in Fig. 45, the surface is "winding."



Fig. 45

A well-trained eye is one of the most valuable possessions of a skilled workman. Therefore do all the testing you can by eye before using instruments. When planing the edge of a board, for instance, sight lengthways toward the light (Fig. 46). If you can see that the edge is too high or too low anywhere, do not stop to apply a straight-



Fig. 46

edge, but plane until it looks straight. Use the straight-edge only as a final test (Fig. 47). Always look toward the light. If any shows through, the edge is not straight, but must be planed until the straight-edge touches it throughout. In the same way, to determine whether a broad surface is true sight across it from

different directions (Figs. 48, 49, 50), lengthways of the surface, crossways, and diagonally, finally using the straight-edge (Figs. 51, 52, 53). When the surface is true, the straight-edge (in whatever

position placed) will touch it throughout. The plane can often be used as a straight-edge for testing (Fig. 144).

12. Chalk is used for rough marking and also with the chalk-line. (See *Chalk-line*, below).

Sticks of graphite or some composition are also good for the roughest marking, but not with the chalk-line.

13. The Chalk-line is a chalked cord used to mark between two points. A small cord is better than a large one. At one end

of the desired line fix the cord with a loop around an awl or nail, and chalk it from this end, as in Fig. 54, so that the chalk will not be cut in two. It can be revolved in the hand as the line is chalked. Then draw the cord taut to the other end of the desired line, hold it down with one hand, lift it squarely from as near the middle as practicable with the thumb and forefinger of the other hand, and let it snap back to the surface (Fig. 55).



Fig. 48

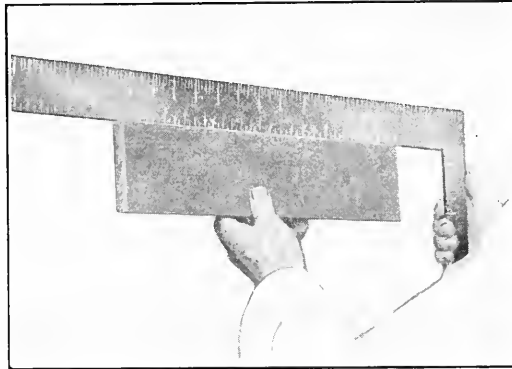


Fig. 47

14. The Spirit-level (usually combined with a **Plumb**) is important in carpentry and building and for many kinds of mechanical work.

For large work a long straight-edge of equal width throughout should first be placed on the surface to be

tested, and the level or plumb applied to the straight-edge (Fig. 56).

To get a plumb-line hang any weight at the end of a cord. The cord will be vertical as soon as it stops swinging (Fig. 57). The cord can be hung on a board with a line gauged down the middle of the side, parallel to the edges (Fig. 58). When the cord hangs exactly on the line, or at the

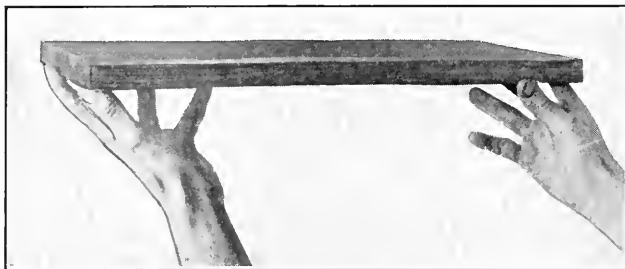


Fig. 49

apex of the notch, the edge of the board will be vertical. A long plumb is more accurate than a short one in most cases. For example, the post plumbed as in Fig. 59 *a*, will be vertical, taken as a whole; but if only a part of it be plumbed, it may lean to one side (Fig. 59 *b*).



Fig. 50

As a horizontal or level line is at right angles with a vertical one, a level can be made as in Fig. 60. When the plumb-line *ab*, at right angles to *cd*, is vertical, *cd* will be level. The frame should be several feet long for large work.

15. Calipers, which are called "inside" or "outside," according to whether they are to find the diameter of a hole or the outside diameter of an object, are very important in some work, as turning. The diameter of a curved object can often be found by some simple combination of squares, rules, etc., as suggested in Fig. 61.



Fig. 51

Small outside measurements can often be taken with the caliper-rule.

16. A Flexible Ruler, or **spline**, of wood, rubber, or other material can be used for drawing irregular curves. (Fig. 62. See page 236.)

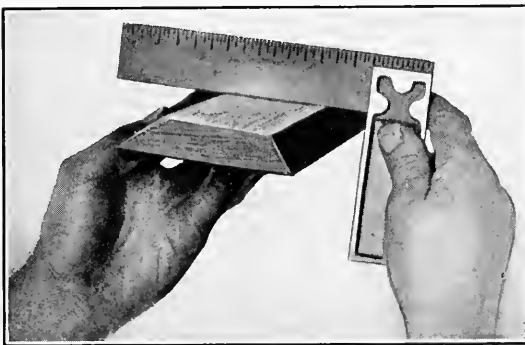


Fig. 52

SAWS

There are many kinds of hand saws, both coarse and fine, for cutting with the grain and across it, and for curved work. In most saws the teeth are bent outwards, one tooth to one side, the next to the other. This is called the *set*, and makes the cut wider than

the thickness of the blade, allowing the saw to slip back and forth easily¹ (Fig. 63).

17. The Cross-cutting Saw is used for sawing across the grain. The teeth are pointed and sharp (Fig. 64), and cut across the fibres

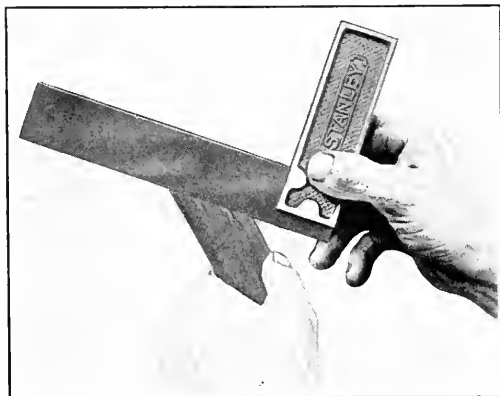


Fig. 53

of the wood somewhat like the point of a knife. The sharp cutting edge of each tooth is on the outside. The teeth cut best when slightly inclined toward the tip of the saw (Fig. 64).

First place the wood upon a pair of horses, or fasten it in the vise. Hold the saw firmly, with the forefinger against the side of the handle to steady it (Fig. 65). Seize the wood with the left hand,

place the saw at the outside edge of the line, and hold the thumb of the left hand against the blade (*above* the teeth) to help start the cut in the right place (Fig. 66).

First draw the saw gently backwards, lest it splinter the edge, with as little pressure as possible, then push it gently forward, and after a few easy strokes to get the cut started right, move the left hand a little further away and saw with long, steady strokes, but not such long strokes that the tip of

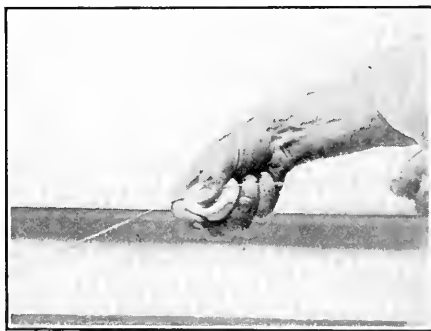


Fig. 54

¹ The blade of the common hand saw is thicker at the teeth than at the back, and at the handle than at the tip, to stiffen it and to enable it to pass through the wood freely.

the saw enters the kerf, lest it catch and the saw buckle. With a sharp saw there is nothing gained by bearing down heavily on the



Fig. 55

teeth. Rather let it run of itself with an easy, *light stroke*, guiding it carefully. Sawing furiously may make the saw jump out of the kerf and damage the work or cut the hand.

If the saw begins to run off the line, twist it a little with the wrist as you go on (Fig. 67) to bring it back to the line, which can be done most easily

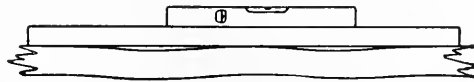


Fig. 56



Fig. 57

when the saw is held at about the angle shown in Fig. 74.

Try to keep the side of the saw blade at right angles with the surface of the wood. It can be tested with the

try-square (Fig. 68), but this is inconvenient and it is best to learn to

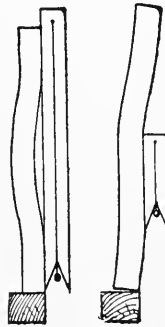


Fig. 59

saw without such help. If the saw is not cutting squarely, bend the blade sideways (Fig. 69).

At the end of the cut saw gently with light strokes and hold with the left hand the piece which is being cut off, or support it



Fig. 58

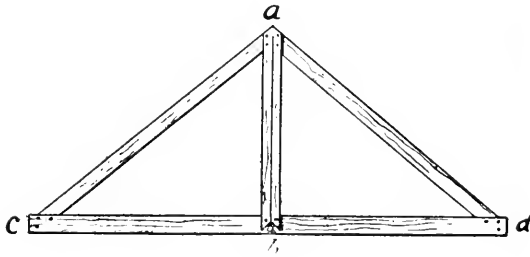


Fig. 60

in some way, lest it break off and splinter one of the two pieces (Fig. 70).

From 18" to 24" is a good length for a cross-cutting saw, with about 8 to 10 teeth to the inch. For ordinary work 10 points to the inch is a good number. A figure often found near the saw handle tells the number of points to the inch.

The slant given the teeth—the rake or pitch—is such that the point can be drawn smoothly and easily across the wood. The degree to which the teeth are set and the number of teeth to the inch depend upon the use



Fig. 61



Fig. 62

to which the saw is to be put. The less set in any hand-saw the better, provided it is enough to give the blade clearance. The finer the teeth the smoother the cut. A cross-cutting saw for soft wood can be given more

set than one for hard wood. The former needs a wider set to give the blade clearance, because the fibres of the looser-textured soft wood are bent aside

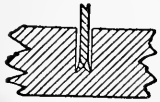


Fig. 63

by the saw teeth and are not so cleanly cut off as in the hard wood. It is common, however, to use the same saw for both soft and hard wood.

In nice work, a little notch can be made with the knife or chisel on the outside of the line, to help start the saw (Fig. 71).



Fig. 64

18. The **Splitting-saw** (or *ripping-saw*) is used to cut with the grain, and the teeth differ from those of the cross-cutting saw. The latter are like little knives to cut across the grain, but the teeth of the splitting-saw cut only on the forward stroke, and are like little chisels to cut with the grain (Fig. 72), but are not suitable to cut directly across the grain. The sharp ends, which are square (Fig. 73, showing set), or may be oblique, cut off the fibres, and the front edges of the teeth push them out of the kerf. The splitting-saw is used like the cross-cutting



Fig. 65

saw (see page 22) but usually cuts best when held slanting (Fig. 74).

If the cut closes after the saw so as to "bind" it, drive a wedge into the kerf (Fig. 74). When you come to a hard knot it is sometimes



Fig. 66

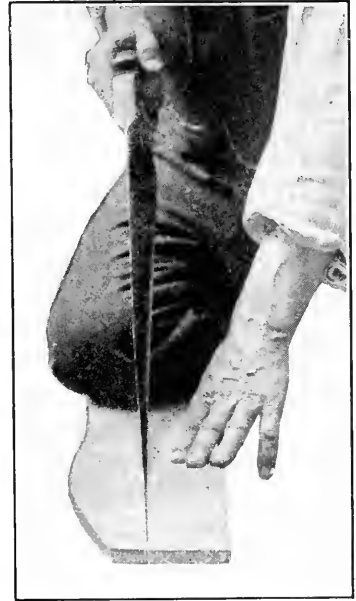


Fig. 67

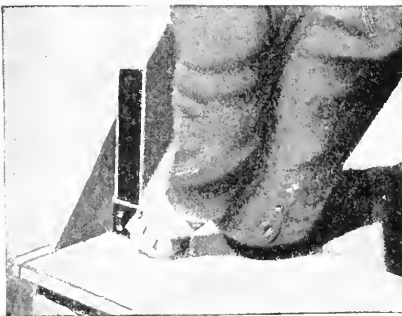


Fig. 68



Fig. 69

best to take the cross-cutting saw to cut through it. Many pieces of wood can best be screwed in the vise for sawing, grasping the wood with the left hand. If the saw is cutting far from the vise it may "chatter" and not work well. While finishing the cut hold the ends in place (Fig. 75).

In sawing into a block after cutting about as far as shown in Fig. 76, reverse the piece and saw from the opposite side as shown in Fig. 77, and so on. Thus you have only to follow the line on the side towards you. As your skill increases you can saw further without reversing.



Fig. 70

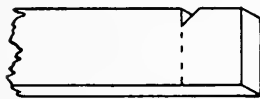


Fig. 71

The ripping-saw usually has larger teeth than the cross-cutting saw. Seven points to the inch is good for common work. Five to eight points to the inch will cover ordinary cases.



Fig. 72

19. The Back-saw has a very thin blade to make a fine cut, and a back of metal to give the blade firmness. This saw is used like the cross-cutting saw (see page 22), but care must be taken lest the blade become bent. Fig. 78 shows a common use of the back-saw. Place the wood upon the bench-hook (see page 83), start the stroke as with the cross-cutting saw in the position shown in Fig. 79, and gradually lower the handle until the blade cuts the whole width of the piece (Fig. 80). Great care is necessary to cut exactly to the knife line. The back-saw can also be used as in Figs. 76 and 77, and to saw two ends to fit (see page 155). See *Mitre-box*, page 85.



Fig. 73

20. Saws for Cutting Curves.—It is well to learn the use of the



Fig. 74

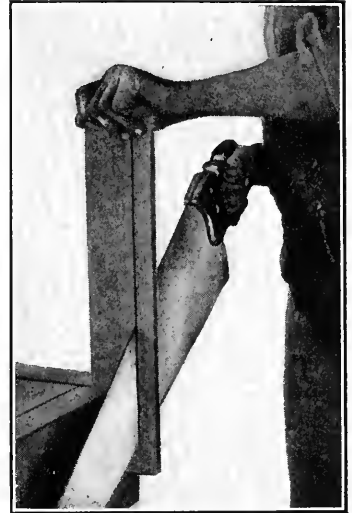


Fig. 75

compass-saw, the *keyhole-saw*, the *bow-* or *turning-saw*, and the fine *coping-saw*, although the bow-saw and compass-saw are now seldom used by practical workmen, since most curved sawing can be done better, quicker, easier, and cheaper by a band-saw or a jig-saw. The compass- and keyhole-saws must be used with care, as the narrow blades are easily injured.



Fig. 76

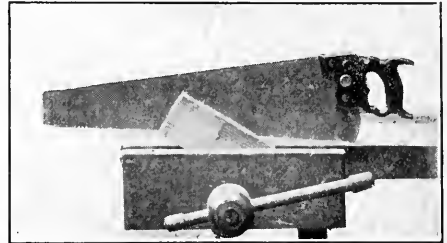


Fig. 77

21. The **Compass-saw** is for cutting curves, and is used like the other saws. In sawing holes ("inside" or "coring" work) one or more smaller holes must be bored in which to start the saw (Fig. 81). The blade is narrow, tapers from the handle to the tip, also from the

teeth to the back-edge, and the teeth have a wide set. Thus it will cut a small circle. The teeth are a kind of compromise between those of the splitting- and cross-cutting saws, to cut freely either way of the grain.

22. The **Keyhole-saw** is smaller than the compass-saw and is used in the same way for cutting quicker curves, as for a keyhole. The blade can usually be adjusted to project from the handle to suit the size of hole to be cut. The compass and keyhole saws are sometimes combined, with several blades.



Fig. 78

23. The **Turning-saw or Bow-saw** can be used for curves when

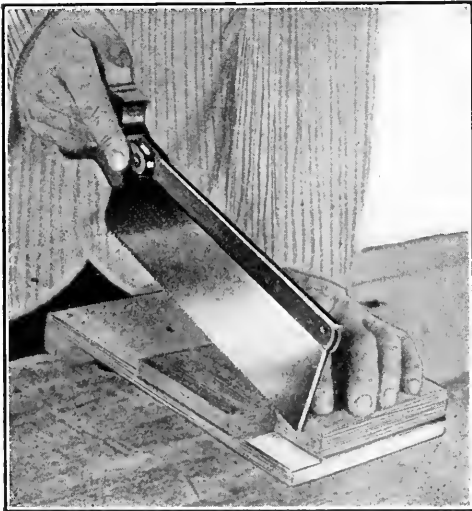


Fig. 79

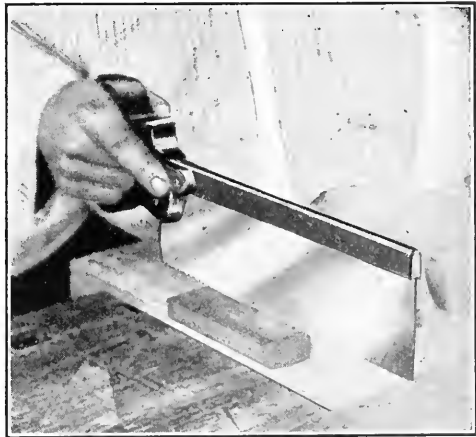


Fig. 80

the frame will not prevent. Hold it by the larger handle with both hands (Fig. 82). The teeth should point from you. Saw lightly with

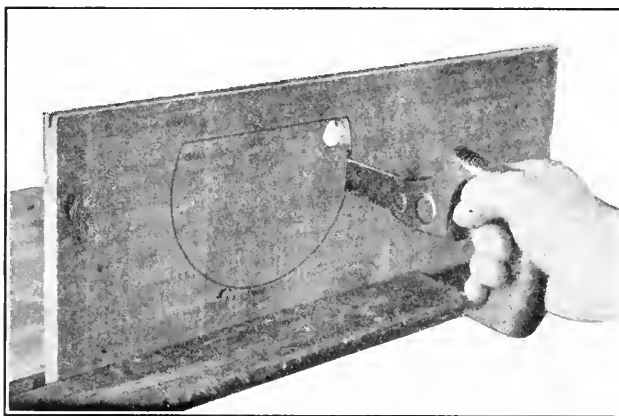


Fig. 81

long, even strokes. Try to make the cut square with the surface. The handles and blade should turn so that sawing can

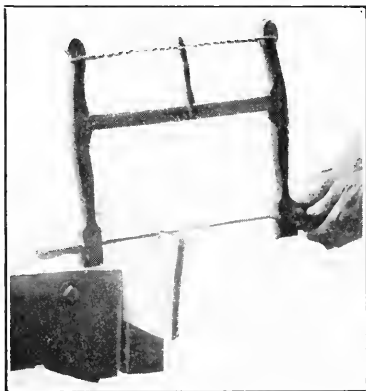


Fig. 82

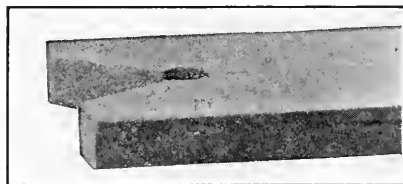


Fig. 83

be done at an angle with the frame.

24. The **Coping-saw** or **Bracket-saw** is useful for fine work. Cut the end of a board as in Fig. 83. Clamp this on

bench or table and use the saw as in Fig. 84.

For *Saw-machinery*, see page 88.
 For *Sharpening Saws*, see page 136.

CH. SELS

25. The Firmer-chisel is meant for hand-work only, for paring and trimming wood to shape, and can be used for light mortising.

26. The Framing-chisel is stouter than the firmer, to stand heavy blows of the mallet, in framing, mortising, and other heavy work.

The chisel handle is usually held with one hand, and the other used to guide the blade and also to rest upon and hold the wood in place if necessary (Fig. 89). The left hand should always be kept behind the cutting-edge. Where the wood and tool can not both be securely held by the left hand the work should be firmly fastened by vise, or clamp, and the left hand be free to help control the chisel.¹ For fine cutting the chisel can be controlled as in Fig. 102. The fingers of the left hand can thus guide

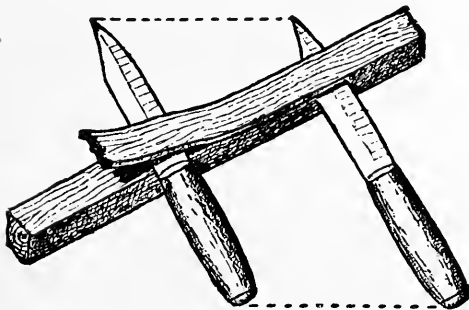


Fig. 85

¹ It is largely by the varying balance of two forces—the pushing forward of the chisel with one hand and the controlling with the other—that effective use of the tool is acquired.

² The edge of a razor can be pressed against the hand without cutting, but if moved

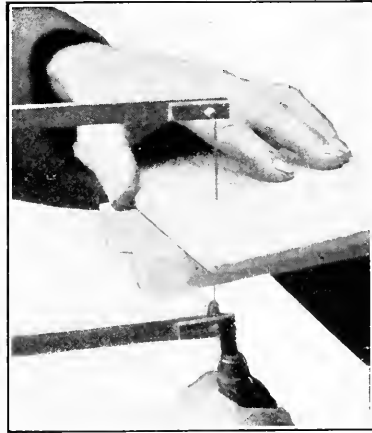


Fig. 84

or check the tool as it is pushed forward by the right hand. As a rule cut with the flat side of the chisel next the wood.

A slicing or shearing stroke² is effective. That is, hold the tool so that the edge cuts slantingly, or somewhat sideways, instead of being *pushed* straight through the wood (Fig. 94).

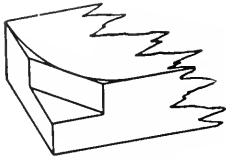


Fig. 86

A curve like that shown in Fig. 86 can be cut best by first removing part of the wood with the saw. Then hold the chisel as shown in Fig. 88. Begin at the edge just *outside* of the end of the curve and work *with* the grain, so that the waste wood may break off and not the part to be kept.

Take such a position that you can sight along the flat side of the chisel and thus keep it perpendicular, else the cutting may not be square with the surface. Advance the tool a little for each stroke so as to trim off but little at a time with the forward edge of the chisel. Keep the flat surface of the chisel against the part already cut as a guide. Either cut straight down with the chisel or, as is often better, start the chisel as in Fig. 87 and push the handle both forward and downward until at the end of the stroke the tool is upright (Fig. 88). Or hold the chisel upright and move it sideways as it is pushed down, making a slanting cut (Fig. 89 and 88a.) As you trim to the line test the squareness. Another way is first to cut off the corner with the chisel up to the curve (Fig. 86), keeping the surface and edges square. Then pare off the angles again and so on (Fig. 90) until the curve is cut.



Fig. 87

lengthways it will cut at once. Even a blade of grass will cut if drawn quickly through the hand. A powerful microscope will show that the edge of a sharp tool, which seems smooth, is really quite rough and ragged, and will, as a rule, tear or saw its way through the wood best if used with a slanting or sideways stroke (Fig. 85), at the same time that it is pushed forward. Usually the softer the material the greater the advantage in this slanting or slicing stroke. Owing to the angle at which it works, the cutting edge can also be considered as thinner, and so more effective, with a slanting stroke.

Saw cuts can often be made nearly to the line, so that the waste wood can be cut off easily without danger of splitting the work (Fig. 91). The shave is usually a better tool for curved work. (See pages 59 and 102.)

The cleanest cutting can often be done across the grain with a slanting stroke (Fig. 92). Slant the cut, if possible, so that any splitting will be

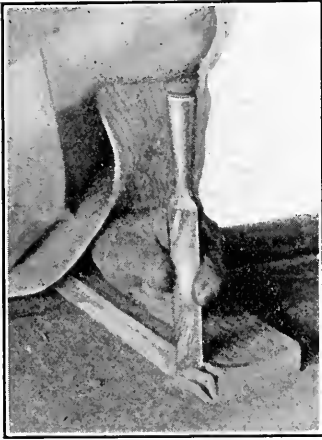


Fig. 88

in the waste wood and not in the part to be kept. Cut the opposite way when the direction of the grain changes, but some pieces are so irregular in grain that this cannot be done. In cutting off or rounding a corner or an edge, a slanting or shearing cut can be used (Figs. 93 and 94).

Sometimes the chisel will work best with the basil (or sloping side) downward (Fig. 95), until the line is nearly reached. The surface can then be smoothed with the flat side of the tool downward. Figs. 91a, 96, 97, 98, and 99 show other ways of using the chisel for paring.

To remove the wood from a gain (Fig. 100), pare off thin shavings from one side (Fig. 101). Then cut from the other side. Finally trim carefully to the line. Usually the best way to smooth the bottoms of gains and grooves is with the router. (See page 43.) Moving the chisel handle from side to side as the tool is pushed forward (Figs. 101 and 102) gives a slanting effect to the stroke. (See page 31.) Another way is to make slanting cuts at each side of the space until they meet (Fig. 103). Then trim down to the line with the chisel held flatways.

To pare to a line ABC (Fig. 104), bevel or chamfer each edge to the

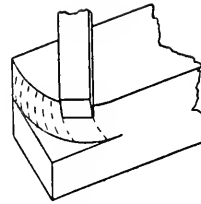


Fig. 88a

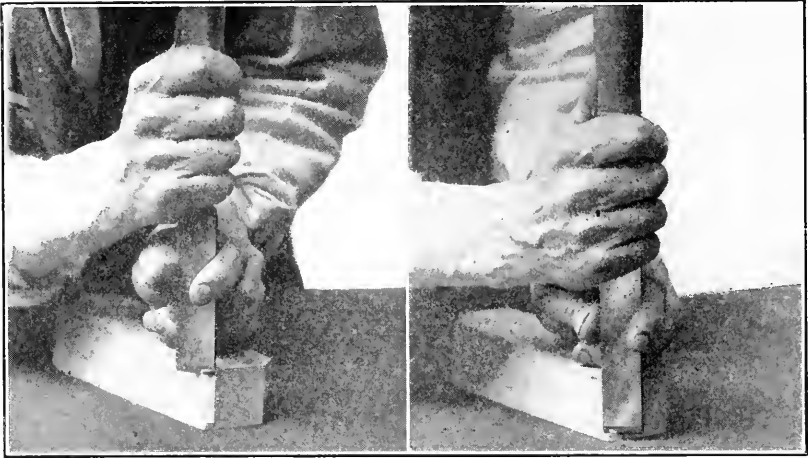


Fig. 89

line (Fig. 105), and then pare across with the chisel until the chamfers are removed.

For sharpening, see page 128.

Socket chisels are the best and those with disks of sole leather, or ferrules, where the handles are struck by the mallet, are strongest for heavy work. *Mortise-chisels* with great thickness of blade are not likely

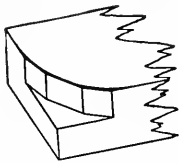


Fig. 90

to break in heavy work, and the thick blade tends to make the cutting more accurate. Besides the firmer-chisel, the *paring-chisel* is used for paring only, and is lighter than the firmer. The blade of the firmer or other light chisel is

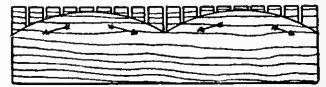


Fig. 91

of steel only, while that of the framing-chisel is partly of iron to make it tougher.

Bevel-edged chisels, with the long edges bevelled on the same side as the cutting basil, are convenient for working into corners, dovetailing and the like, and are easier to sharpen than those with square edges. The corner of the basil is sometimes ground off. The *Straight-bent chisel*

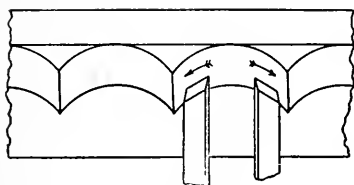


Fig. 91a

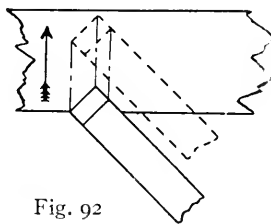


Fig. 92

(Fig. 106) is useful for cleaning out corners, grooves, and other places where the common firmer-chisel cannot be used to advantage. (See also

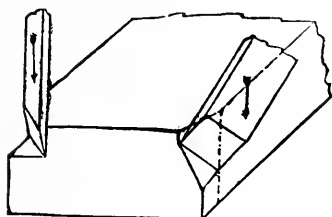


Fig. 93

Router, page 43). A *Skew-chisel* has a slanting edge and is convenient for corners and odd-shaped work. See *Carving Tools*, page 171. There are other chisels seldom needed by the beginner, as the *corner-chisel*, which is similar to the carver's V- or parting-tool, and is used in angles and corners.

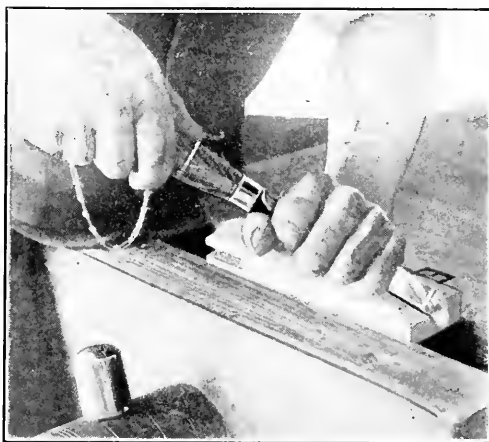


Fig. 94

PLANES

A plane is, in principle, a chisel stuck through a block which serves to control the cutting. The sharp-edged piece of steel which cuts the wood is called the plane-iron (Fig. 107).¹ The bottom surface of a plane is called the face or sole (Fig. 108), the wedge-shaped hole

¹ Sometimes called the plane-bit.

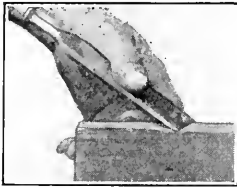


Fig. 95

where the plane-iron goes is called the throat, and the slot at the bottom through which the edge of the iron projects is called the mouth (Fig. 108). Most common planes have a plane-iron cap with a dull edge screwed to the face of the cutting-iron (Fig. 109), and are called "double-ironed" planes.¹

With cross-grained wood the mouth should be narrow to ensure a smooth surface. The more cross-grained the wood the nearer the cap should be to the cutting-edge. The nearer it is to the cutting-edge, the smoother the result, but the harder to work the plane. Screw the cap firmly in position, else it may slip. Also see that the edge of the cap fits tightly against the plane-iron so that shavings cannot pass up between them. The edge of the cap can be ground to fit if necessary.

Sight along the face (Fig. 111) to see that the iron projects the right amount, and also that it is not askew, lest one side cut more deeply than the other. The way to adjust the iron in an iron plane is easily learned from the plane itself. The iron should project more for soft and loose-

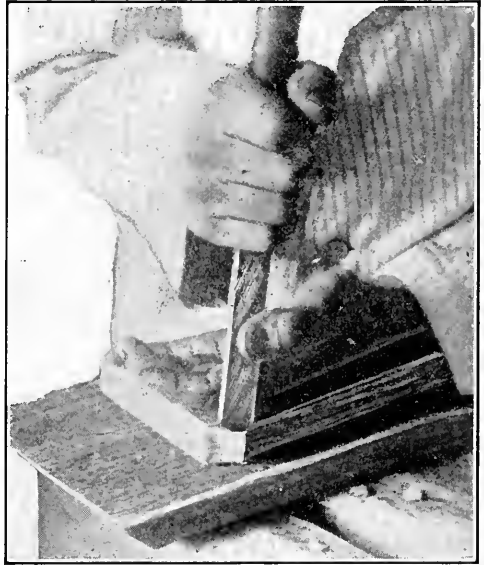


Fig. 96

¹ The single plane-iron when used against the grain (Fig. 110) or on cross-grained wood, is apt to leave the surface rough, because the shavings tend to split the wood ahead of the cutting edge. Therefore the cap is added to bend the shavings up against the forward edge of the mouth, so that they can be cut off smoothly before splitting begins.

grained wood than for hard, and the cap-iron be nearer the edge for hard wood. The beginner is apt to set the iron to project too much,—to make too thick shavings.

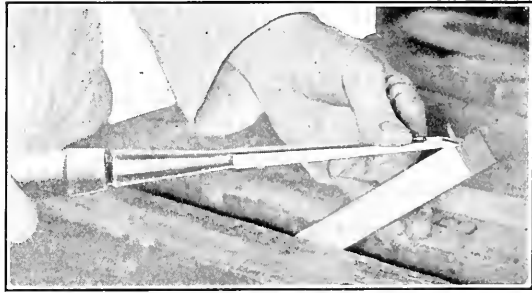


Fig. 97

To raise the iron of a wooden plane, hold the plane with the left hand so that the iron cannot fall through, and tap on the top of the fore end of the plane (Fig. 112) or on the rear end of the smoothing-plane (Fig. 113).

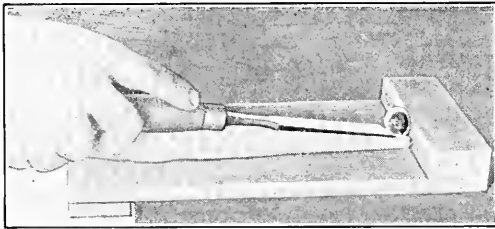


Fig. 98

When the iron is adjusted fix it firmly in place by tapping on top of the "chip" or wedge which holds it in place (Fig. 114). To lower the cutting-edge, tap on the upper end of the iron (Fig. 115) and then on the chip as before. To remove the iron for sharpening, the chip also is removed. Hold the plane in the left hand in these ad-

justing operations. Do not strike any part of it while it rests on anything solid. If the cutting-edge projects unevenly, tap on one edge of the upper part of the iron (Fig. 116).

Good planes are made with wooden stocks, but with the adjustments of the iron planes. Some workmen still prefer the wooden planes, as there is a lightness and smoothness about their action not found in the iron ones. The wooden stocks however sooner or later become warped and then the face has to be "jointed" to make it true. Iron planes



Fig. 99

are easier to adjust and to keep in order. To protect the cutting-edge lay planes on their sides or ends, or, better, arrange a little strip to raise one end slightly from the bench or shelf.

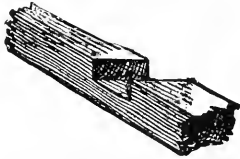


Fig. 100

very slightly rounded.

27. The Jack-plane, as now commonly used, is to straighten and level the surface of the wood, and can be followed by the smoothing-plane. The iron is ground squarely across (Fig. 107), but with the corners

This plane was formerly used for coarse work and to rough off the

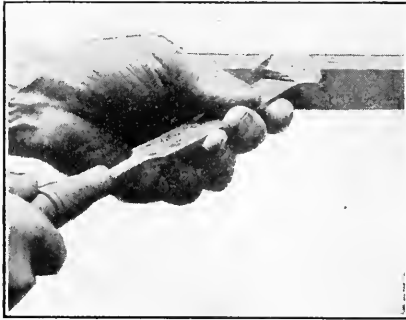


Fig. 101

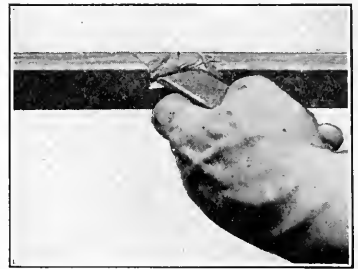


Fig. 102

surface before using the other planes. The cutting-edge was rounded, cut deepest in the middle (Fig. 117), and removed heavy shavings, leaving the surface uneven (Fig. 118, exaggerated).



Fig. 103

The jack-plane was followed by the longer fore-plane or trying-plane, which was used to straighten and level the surface,—the iron being but very slightly rounded. These planes are still occasionally used, but as machine-planed stock can be obtained of any desired dimensions almost everywhere, the jack-plane and fore-plane now commonly have the iron ground squarely across and differ only in size. It is often convenient to have an extra jack-plane iron with rounded edge for rough work. The jack-plane (with

rounded edge) is good for "traversing" or planing across the grain, which is frequently the best way to plane down a surface. (See page 50.)

28. The **Jointer** is longer than the jack-plane and thus more accurate for making a surface level and true. It is good to straighten the edges of boards. (See *Jointing*, page 47, and also page 45.) The *long jointer* is longer than the jointer and correspondingly more accurate.

29. The **Smoothing-plane** is used for the final smoothing of the surface, so far as it can be done with a plane.¹ It will make a surface smooth; but unless the surface is small, it is hard to make it straight or level or true with this plane, because it is short and will follow the irregularities of the surface (Fig. 119).

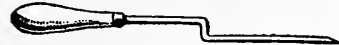


Fig. 106

The smoothing-plane is therefore merely to *smooth* the surface after it has been straight-

ened by a longer plane (Fig. 133), or where the surface must be smooth but need not be true. Small pieces can be straightened and trued by the smoothing-plane alone. See also *Block-plane*, below and *Planing*, page 43.

A wooden smoothing-plane can be held as shown in Fig. 120.

30. The **Block-plane** is chiefly for planing across the ends of pieces (for planing "end-grain").

It has a single iron set at a more acute angle with the face than in the other planes and with the bevel upward. The width of the mouth is often adjustable. As the block-plane can be used with one hand,

¹ The final smoothing of nice work is done with the scraper (page 61) and sandpaper (page 78).

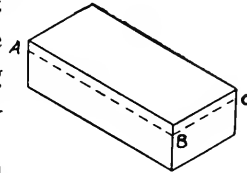


Fig. 104

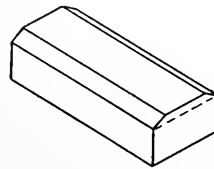


Fig. 105

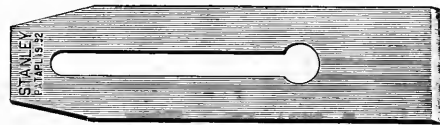


Fig. 107

it is convenient for trimming pieces which cannot well be held in the vise. Modern machinery and trimmers have greatly lessened the value of the block-plane. Many prefer the smoothing-plane.



Fig. 108

ing the further edge. Then reverse and plane from the other edge in the same way. Sometimes a piece of waste wood can be put at one edge to prevent chipping (Fig. 122), or one edge can first be cut off as in Fig. 123.

The ends of many pieces can be planed on the bench-hook, jack-board, or shooting-board. (See page 83.) Hold the piece firmly against the "stop" or cross-piece of the bench-hook, with the end

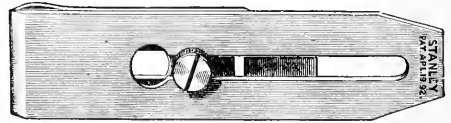
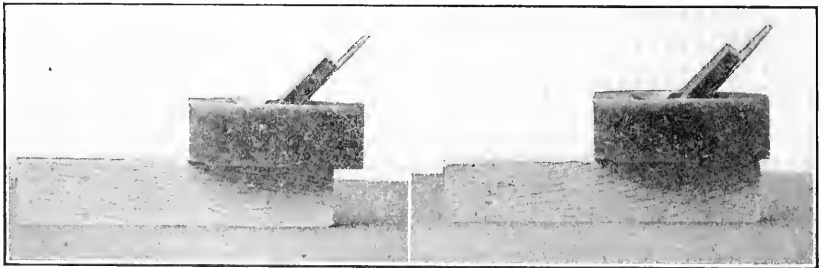


Fig. 109



PLANING WITH THE GRAIN

PLANING AGAINST THE GRAIN

Fig. 110

just at the edge (Fig. 124). Then plane as shown and the end of the piece will be smoothed and perhaps squared. The joint-edge (the one from which the work is squared (see page 4) should be placed

next the stop. All planing done in this way should be carefully tested with the square and replaned if necessary, until correct.¹



Fig. 111

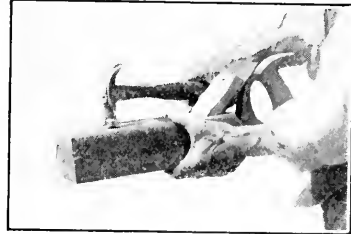


Fig. 112

When the end is large or nearly square in section, it can be held in the vise and planed diagonally from corner to corner, both ways, as described above (Fig. 125).

31. The Toothed-plane is about the size of the smoothing-plane,

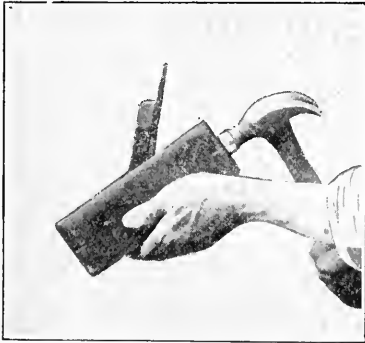


Fig. 113

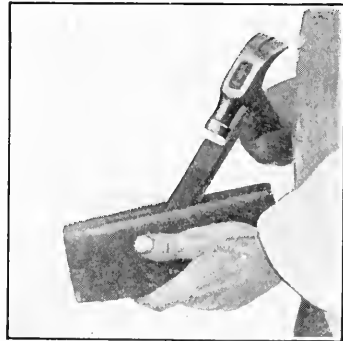


Fig. 114

¹It rarely happens that the surfaces of the bench and bench-hook will be so accurate, and the handling of the plane so skilful that the result can be assumed to be exact. Therefore it should always be tested. Many prefer to fasten the wood in the vise for this kind of planing (Figs. 121 and 125).

but the iron is set almost vertically and the flat side is scored length-ways with fine grooves (Fig. 126), so that the cutting-edge has little



Fig. 115

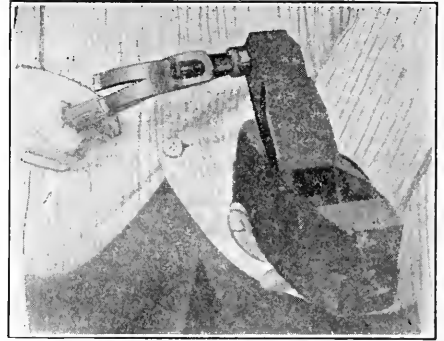


Fig. 116

teeth which make grooves on the surface of the wood. It is used in veneering (see page 177) and other work, to make the glue hold more strongly (see page 182).



Fig. 117

A very cross-grained surface can sometimes be smoothed more easily if it is first "toothed" in different directions. If a surface cannot be planed smooth however, the trouble is usually

with the edge of the plane-iron or the adjustment, or with the manner of planing, for a *very keen edge* should cut the most obstinate grain, unless the wood is extraordinarily hard and knurly.

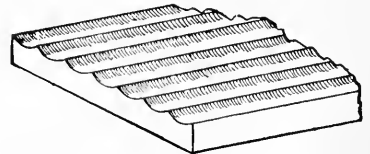


Fig. 118

32. The **Bull-nosed plane** has the iron at the fore end, to work into places which cannot be reached by the common planes. The iron is reversed. The **Rabbit-plane** is to cut rabbets (page 159). Much of its work is now done by machinery. The planing can be started with the aid of a straight-edge as a guide. Hold the plane firmly against the wood without tipping it sideways. The **Circular-**

plane has a flexible sole of thin metal, which can be adjusted to plane either convex or concave surfaces. The **Router** is for smoothing the bottoms of grooves and depressions, and is useful in fitting hinges, locks, and similar work, and in inlaying. There are other planes for special purposes, as, for example, the *plough*, *matching-planes*, *hollow* and *round planes*, *beading-planes*, etc., as well as "combination" and "universal" planes. The plough and matching-planes must be kept level or square with the surface. Modern machinery, when available, does most of the work of these special planes more quickly and economically than it can be done by hand and progressive workmen only use them in case of necessity.

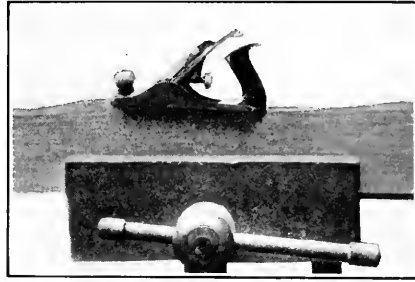


Fig. 119



Fig. 120

33. Planing.—Before beginning to plane, see that all dirt or grit which might dull the tool is brushed from the surface. Fasten the wood low in the vise (Fig. 127), as you can plane better than if the surface is high, or lay it upon

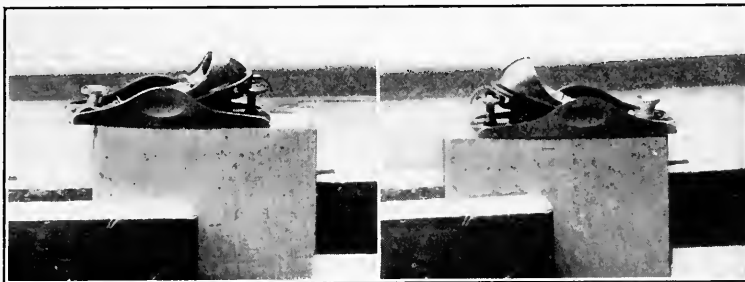


Fig. 121

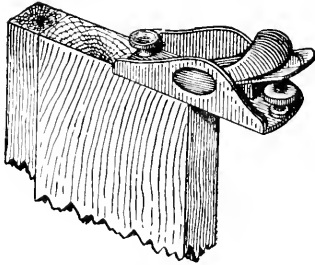


Fig. 122

the bench top against the stop, or fasten it between one of the stops and the tail vise (Fig. 214), as the case may require. If the piece is long and tends to drop at the unsupported end, fasten a hand-screw to it (Fig. 128). See that the plane is set right (see page 36). Place the wood so as to plane with the grain if possible. Stand at the rear end of the work and hold the plane as in Fig. 127.¹ Plane with the arms from

the shoulder, not with the whole body.² Press down on the forward part of the plane during the first part of the stroke, and on the rear part of the plane during the last part of the stroke (Fig. 131). Plane slowly, and watch the mouth of the plane and the shavings to know



Fig. 123



Fig. 124

whether the work is being done right. With cross-grained stock plane with the grain as much as you can, turning the piece around if necessary. Sometimes it is well to turn the plane sideways to make

¹ Hold a wooden plane as shown in Fig. 128a.

² It is natural to begin and end the stroke as shown in Fig 129 and to roll the body back and forth, with the result shown in Fig. 130, and the plane is apt to "chatter" or jump, making little hollows and ridges.

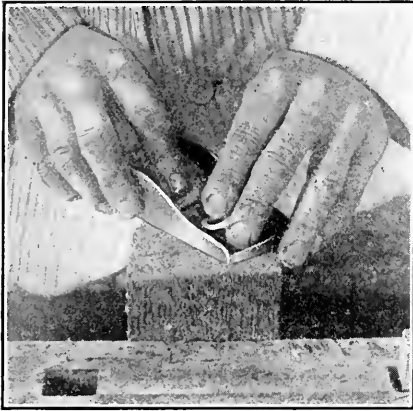


Fig. 125

a slanting cut across the grain (Fig. 132. See also page 50), but as a rule the plane should be pushed straight forward. If it runs hard a few drops of oil can be rubbed on the face, but use no greasy lubricator to deface the surface of nice work. An oiled pad is good to lay planes on when not in use. Wood planed by a common machine planer may seem smooth, but nice work should be planed by hand carefully until

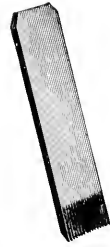


Fig. 126

all the "planer-marks" are removed. (See page 107.)

If you have to start or end a stroke at any other point than the end of the piece, the rear end of the plane can be lifted slightly from the wood at the beginning and end of the stroke, thus tapering the ends of the shaving. A light, easy movement in placing and raising the plane is all that is necessary. This is not easy to describe but can be learned by experiment.

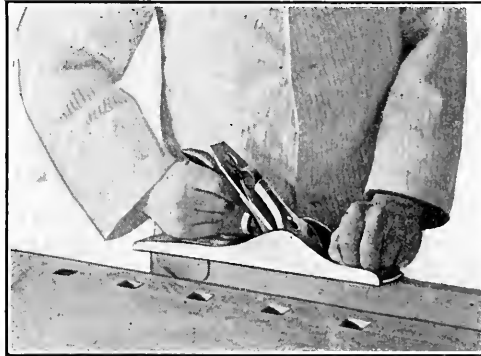


Fig. 127

34. Planing Edges and Narrow Surfaces.— What you have to do is to make the edge straight from end to end and also square with the side of the piece. A long plane does this better than a short one (Fig. 133). Use the jack-plane, fore-plane, jointer, or long jointer,

as the case may require. The plane-iron should be set fine, unless

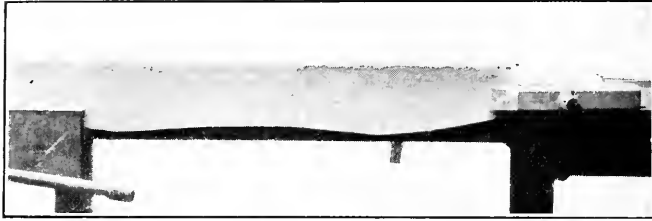


Fig. 128

the edge is very uneven, when coarse shavings can be made at first. Before planing an edge see that the plane-iron projects evenly.

In planing or “jointing” an edge it is common to hold the fingers below the sole of the plane as a guide (Fig. 134).¹ The jointing should be done with long, deliberate, steady strokes. The last stroke should be the full length of the piece if possible. Sight and test the edge as already shown. (See p.18.)

If one side of an edge is too high, the plane can be moved over so as to plane that side only (Fig. 135). If the edge of the plane-iron is at all rounding, it will then take off a shaving thicker on one edge than the other (Fig. 136). If part of the edge is higher on one side and part on the other, making the edge winding, the planing can be begun as just directed and the plane worked over to the other edge as it is pushed forward (Figs. 135, 137, 138). In



Fig. 128a

¹ A wrong position of the left hand on the fore part of a wooden plane (see Fig. 128a for correct position) will tend to tip the plane sideways. The shooting-board can be used to advantage for short pieces (see page 83), and attachable guides can also be obtained.

beveling or rounding an edge, or planing an end, it is often best to hold the plane as in Fig. 139.

35. Jointing is planing edges to make a tight joint. The term is also commonly applied to straightening and squaring the edge of one piece only, as to "joint" the edge of a board. If the edge is nearly straight, the only plane needed is the jack-plane or fore-plane, —or better, the jointer, or the long jointer, if the piece is long. The plane should be set fine, but if much wood is to be planed off it can be set to make a coarse shaving at first.



Fig. 129



Fig. 130

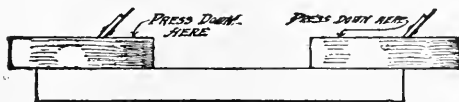


Fig. 131



Fig. 132

To plane for a "glue-joint," first see which edges will best go together. In joining two or more boards to make a wider one, notice the way the grain runs lengthways, and the way it crops up to the surface, for usually the surface will have to be planed after the joint is glued, and if the grain runs in different ways it will be hard to make the surface smooth.¹ With soft, straight-grained

¹ Sometimes, however, in handsomely figured wood, as quartered oak or mahogany, the pieces should be arranged in the way that looks the best, but in such cases extra labor is expected in order to have the article as handsome as possible.

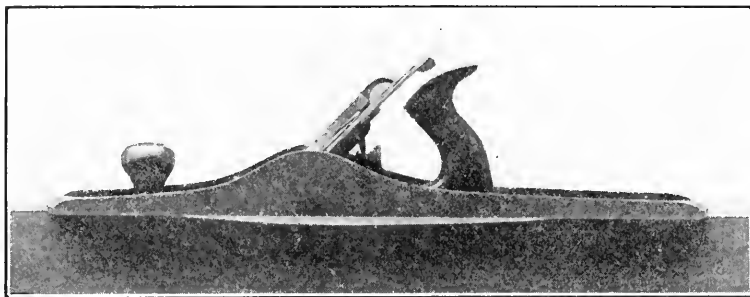


Fig. 133

white pine or white wood, for example, this is of less importance than with wood which is hard to smooth. In jointing narrow se-

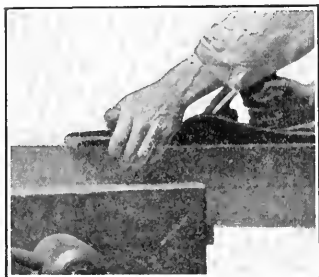


Fig. 134

lected pieces to be glued together so as to prevent warping, etc., examine the end grain and arrange it in different ways (Fig. 140. See p. 212).

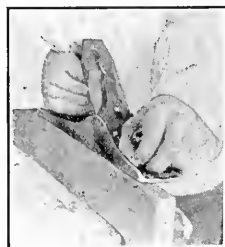


Fig. 135

When the pieces are arranged, mark on the surface across the joints (Fig. 141), to show which edges go together, for this is easy

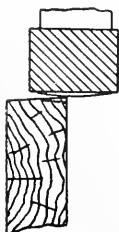


Fig. 136



Fig. 137



Fig. 138

to forget. Joint each edge separately. For nice work plane edges, which are to be joined, from opposite sides,—that is, if the edge of the first piece is placed in the vise with the marked side of the board *toward* you, plane the next piece with the marked side against the bench, or *away* from you. This is to offset any unevenness in setting the plane-iron, tipping of the plane to one side, or winding in the pieces. (See *Shooting-board*, page 83.) Do not use the try-square to test the edge when making glue-joints.

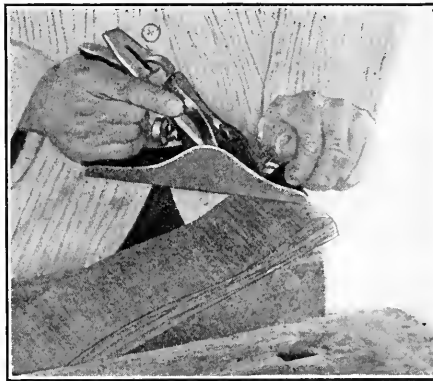


Fig. 139

To test the planing, put one piece in the vise with the jointed edge up, place the other piece on it in the proper position, and see if the edges touch throughout. Notice whether you can see the light through anywhere. Strike the under board slightly to see if the upper one shakes or tips sideways or endways. Also slide the top board length-



Fig. 140

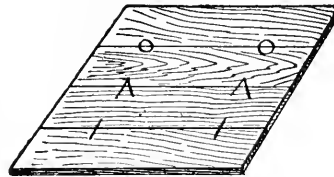


Fig. 141

ways, for a sensation of adhesion or suction can be felt when the two edges fit, and press down at the ends to see if they touch. If the edges do not touch throughout, one or both must be planed with thin, careful strokes until they fit, for the joint will not be good otherwise.

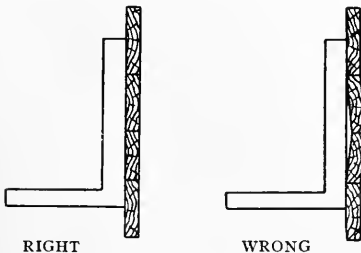


Fig. 142

Not only must the edges touch

throughout, but the sides of the boards must be in line (in the same plane). Test this with the steel square or any straight-edge (Fig. 142. See also *Circular-saw*, page 100). Before gluing hard wood edges it is well to plane them with the toothed-plane. (See page 41.)

Sometimes the edges of boards to be glued are made slightly concave lengthways, so that they touch at the ends but do not quite come together in the middle (Fig. 143), the idea being that a clamp applied at the middle will, by forcing the joint together for its whole length and expelling the surplus glue, give a stronger result than if the edges are straight. If there is to be any open place in the joint before gluing, it is better to



Fig. 143

have it in the middle than at the ends, and in the case of long joints it may be best to have the edges slightly apart in the middle; but with short joints the advantage of this method is certainly doubtful.

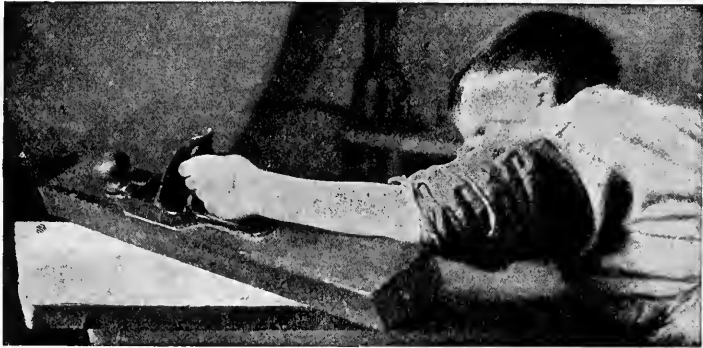


Fig. 144

36. Planing Broad Surfaces.—Keep the plane from tipping sideways at the edges or more will be planed off there than elsewhere.

If much wood has to be removed, it is often best to plane across the grain (called “traversing”) first, either planing straight across at

right angles to the front of the bench, or as in Fig. 132. Also plane diagonally or at whatever angle will give the best result. The final

smoothing off should be with the grain.

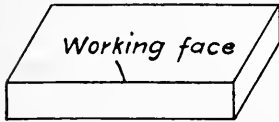


Fig. 145

Test by sighting with the eye in different directions and with a straight-edge (see page 18), or the

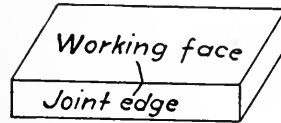


Fig. 146

edge of the plane itself, if straight (Fig. 144). By applying a straight-edge lengthways, crossways, and diagonally, you can determine whether the surface as a whole is straight and true. Winding-sticks can also be used. (See page 86.)

37. Squaring Stock to Dimensions.—To plane a piece of rough stock to a rectangular shape and given dimensions:

First: Select one surface, usually the better side, not an edge, for the “working-face,” as in Fig. 145, make it *straight, true, and smooth* with the plane, and mark it as shown, or with an X or any simple mark.

Second: Select one of the edges, usually the better one, for the “joint-edge”

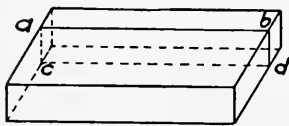


Fig. 147

(see page 4), as shown in Fig. 146, and plane it *straight and square throughout* with the

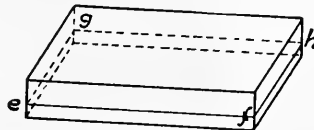


Fig. 148

working-face, testing in the usual manner. Mark it as before.

Third: Set the gauge at the required width and gauge a line *ab* on the working-face and also on the opposite face, *cd* (Fig. 147), *gauging from the joint-edge*.

Fourth: Plane to these gauge lines.

Fifth: Set the gauge at the required thickness and gauge lines *ef* and *gh* on both edges, *gauging from the working-face* (Fig. 148).

Sixth: Plane the surface opposite the working-face down to the gauge lines just made.¹

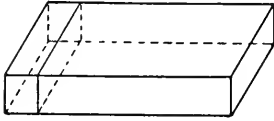


Fig. 149

Seventh: With try-square and knife square lines around the four sides near one end (Fig. 149), squaring from the working-face and joint-edge; and saw and plane to the lines, testing with try-square.

Eighth: From the end just finished measure the required length on the working-face and with square and knife mark lines around the piece (Fig. 150), as at the first end. Saw and plane to the lines, and the piece will be reduced to the required dimensions. Do all squaring from the working-face or joint-edge.

For sharpening the plane, see page 128.

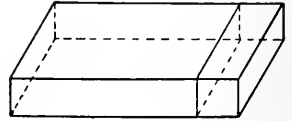


Fig. 150

BORING TOOLS

38. The Brad-awl should not be quite so large as the nail to be driven. Bore with the cutting-edge across the grain (Fig. 151) lest the wedge shape of the tool cause the wood to split. After the edge is well into the wood, the awl can be twisted a little back and forth as it is pushed further. There is always risk of splitting thin wood near an edge.

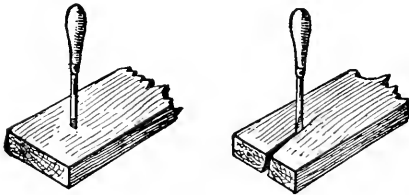


Fig. 151

It is well to have a variety of sizes. A handle into which different awls

¹ Theoretically, if the working-face and joint-edge are made true and square with one another, planing to the gauge marks on this opposite side is all that is necessary, without testing to see that the surface is straight and true. But, practically, no part of the work is perfect; therefore if dimensions are more important than accuracy of shape, there is no object in testing after the work has been cut to the lines, for any alteration would change the dimensions. On the contrary, if accuracy of shape is more important than exact dimensions, the surfaces and angles should be tested and corrected, even though this makes a slight change in the dimensions.

can be fitted is sometimes used, but for shop-work it is more convenient to have each awl in a separate handle. Unlike gimlets and bits, the awl does not remove any wood, but merely presses it aside, so the fibres of the wood tend to close tightly around the nail or screw.

39. The Gimlet is occasionally useful, as in repairing in awkward places, but for general use is superseded. Great care is needed to prevent splitting thin wood or near an edge.

40. The Auger.—The cutting part of an auger is like that of the auger-bit (Fig. 152), but the upper end of the shank (which can be of any length) is either bent into a crank-like handle, or has a handle attached to it. Although an old-fashioned tool, it is in common use in carpentry, shipbuilding, and the larger forms of woodwork.

41. The Bit-brace or Bit-stock.—The ratchet-brace is preferable to the common form, because it can be used where there is not room to turn the handle around.

An extension, fitted to the brace, can be used in places which cannot be reached without it,—also a “universal angle” appliance, to bore in out-of-the-way places; but these are seldom needed in new work, if properly planned.

42. Bits.—The **Auger-bit** consists, at the cutting end, of a worm or spur, two scoring-nibs, and two cutting-lips. The worm *a* (Fig. 152), acting as a screw, draws the bit into the wood so that the scoring-nibs *b* make a circular cut. As this cut deepens, the cutting-lips *c* slice off shavings, which are brought to the surface as the boring proceeds. See *Sharpening*, page 135.



Fig. 152

The sizes are arranged by sixteenths of an inch from $\frac{3}{16}$ " to 2" in diameter. The number on the shank is the numerator of a fraction of which the denominator is 16, and indicates the size. If the number is 8, the bit is $\frac{8}{16}$ of an inch in diameter, that is, $\frac{1}{2}$ inch. A short auger- or *dowel-bit* is sometimes convenient for dowelling (page 152) and other work, and is not easily bent by the beginner.

43. **The Centre-bit** is sometimes useful, particularly for very thin stock. It cuts a smooth hole, but does not cut very well with the grain, that is, in "end wood." The spear-like point *a* (Fig. 153) acts as a centre, the point *b* scores a deep ring, and the edge *c*, which is bent to form a flat chisel, cuts away the wood. It is well to bore a trial hole when exactness is required, because the spur is not quite in the centre and thus the hole is a little larger than the bit.

See *Sharpening*, page 135.



Fig. 153

44. **The Twist-drill** makes a good hole, bores easily, is not easily dulled, and can be used upon metal. Care is necessary, particularly in hard wood, lest it be snapped by bending. It ranges in size from $\frac{1}{16}$ " to $\frac{1}{2}$ ".

45. **The Twist-bit** for wood cuts quickly and well, and being softer than the twist-drill is not so easily broken, but it is hard to start exactly at the desired point, is liable to work off to one side, and bends easily. It ranges in size by thirty-

seconds of an inch from $\frac{2}{32}$ to $\frac{29}{32}$.

46. **The Expansive-bit** is adjustable, and with one or more sizes holes can be bored from one-half inch in diameter to three or four inches. It must be used carefully in hard wood.

47. **Other Bits.**—The *gimlet-bit* is a common form for small holes, and is useful to bore for short stout screws. It is easily dulled and bent, and its tapering end is apt to split delicate work. It is hard to start exactly at the desired point, and is liable to work off to one side. The *German-bit* is a modification of the gimlet-bit, twisting but once in its length. The *spoon-bit* or *pod-bit* is for small holes, but the *twist-drill* and *twist-bit* are now used for most purposes. The *Forstner bit* has no worm, so the bottom of the hole is smooth. It is good to bore in end-grain, and can also be used with only part of the bit bearing on the wood. Drills for metal only are often useful to the woodworker, but the most important is the twist-drill for either metal or wood. There are various patterns of *drill-stocks*, some of them automatic, for holding drills of various sizes for small holes. Radial drills, with chuck, driven by gears, are good. Very small

drills for metal are also useful for wood, and can be kept with the points stuck in a small flat dish of wax or soap. bits (half-round, square, octagonal, conical) are to enlarge holes and to make them conical. Reamers for metal are also useful. Bits can be kept in a divided drawer or box, or, more conveniently, stuck in holes in racks exposed to view.

The *Countersink*, used with the bit-brace, is to enlarge the outer part of a hole to receive the head of a screw (Fig. 185).



Fig. 154

The rose form of countersink is good and suitable for all hard woods. The Clark double-cut

countersink (for wood only) cuts smoothly and is easily sharpened. A countersink for metal is useful.



Fig. 155

48. Use of the Brace and Bit.—

Fasten the bit firmly in the jaws of the brace. It is often well before boring in hard wood to prick a hole with an awl to start the worm of the bit in the exact place, as sometimes it works off to one side. The worm can be placed on the point as in Fig. 154, and the brace and bit changed to the proper position before boring. After the bit has gone a short distance into the wood, stop boring, stand squarely in front, and judge by eye whether the bit is at right angles with the work. Then stand at either side at right angles

to the first position and judge again. Alter the position of the

brace if necessary and repeat the test after boring a little farther.

The square can be used, but it is better to learn to bore without relying on such help. To keep the bit perpendicular some workmen look directly down upon it from above, instead of from the side, turning the brace while they move slowly around from one side of the work to the other. Some rest the chin on the left hand on top of the handle of the brace, to steady it (Fig. 155); and to increase the pressure when necessary, as in driving heavy screws with the screw-driver-bit, the shoulder is sometimes applied. No pressure is needed to bore with an auger-bit. If much force is needed it is a sign that the bit is dull, or that something is wrong.

To remove a bit from the wood, give the brace a turn or two backward, which will loosen the worm, and then either pull the bit straight out when it can be done easily without turning the brace, or as you pull it out keep turning the brace as if boring, thus bringing out most of the chips.

In boring through a piece of wood, watch for the coming through of the worm on the other side. When it pricks through, turn the piece and bore back from that side. This is to prevent splintering, or a ragged or "burred" edge, where the bit leaves the wood. Care must be used in boring back from the other side or the bit may tear the wood as it comes through. When you cannot bore back from the other side, clamp on a piece of waste wood and bore through into it. When the position of a hole must be exact on both sides of the wood, mark the centre accurately on each side, and bore from each side until the holes meet.

In boring a hole of considerable depth with the grain, that is, into the end of a piece of wood, withdraw the bit after boring a short distance, to clear the chips from the hole, reinsert, bore, withdraw again, and so on. This will make the boring easier and may save injury to the bit, and can sometimes be done to advantage when boring in other directions. In boring with a small bit, like the gimlet-bit, where there is danger of splitting, turn it backward as well as

forward, and work it slowly through the wood. A gimlet-handle for use with small bits and screwdriver-bits, is occasionally useful in places where the bit-brace cannot be used.

When holes must be stopped at a fixed depth, use one of the bit gauges or stops made for the purpose. Lacking this, measure from the wood to the chuck of the brace each time, or if many holes are to be bored, use a piece of wood at the side of the bit (Fig. 156), or bore through a piece (Fig. 157). The depth can be told approximately by counting the turns of the brace in each case.

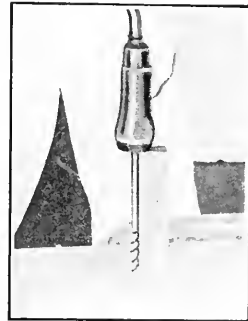


Fig. 156

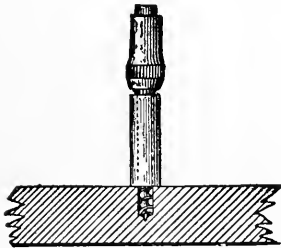


Fig. 157

To cut a hole larger than any bit bore a hole within the circumference of the desired circle, in which to insert the blade of the keyhole- or bow- or compass-saw, with which the curve can be sawed (Fig. 81). The edge can finally be smoothed with gouge, file, spokeshave, etc., according to the size of the hole. See also *Jig-saw*, page 104. Or bore a series of smaller holes all around and then trim to the line. See also *Screw-pocket*, page 254, and *Counterboring*, page 177.

OTHER CUTTING TOOLS

49. The Hatchet is not easy to control, so keep the fingers out of the way and watch the direction of the grain of the wood. To remove waste wood it is often best to make cuts nearly to the line and then trim to the line (Fig. 158). With crooked grain this lessens the danger of splitting the part you wish to keep. (See also page 33.)

There are many kinds of hatchets, but a common medium-sized bench-hatchet that can be used easily with one hand is all that the beginner will ordinarily need.

50. **The Knife.**—The sloyd knife is excellent for whittling, but the common pocket-knife or jack-knife is commonly used by workmen.

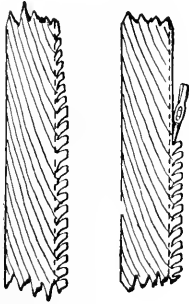


Fig. 158

Keep the left hand *behind* the blade, and when possible cut *from* you, for the tool may slip. A slanting stroke is often best (see page 31). See *Whittling*, page 139.

A great variety of work can be done with a common pocket-knife or jack-knife, which is perhaps the best *emergency* tool for either the beginner or the skilled workman. A knife is so easy to sharpen that there is not much excuse for using a dull one. (See page 132.) In selecting a pocket-knife get a plain one, with not more than two or three blades, and of the best steel. Open the blades to see that each is in line with the handle, as is necessary for strength.

51. **The Gouge** is like the chisel except that the blade is curved. The common gouge has the basil or bevel on the convex or outer side and is known as an “outside” gouge. It is used for ordinary work. The “inside” gouge has the basil on the inner or concave side, and is useful for some purposes, but is less important than the outside gouge for general work, and is harder to sharpen. Gouges, like chisels, are of various kinds for different uses, and are of different degrees of “sweep” or curvature,—Fig. 159 showing a “flat” and a “quick” curve. In using the outside gouge, light, short strokes frequently have to be made, for only the basil bears on the wood, which makes this gouge hard to control at times; but as long strokes should be taken as the nature of the wood will allow. The gouge can often be rolled around with the hand to make a slanting cut (see page 31), sometimes useful with crooked grain or across the grain (Fig. 160). In working out a moulding or other odd shape, for instance, the tool can often be held at an angle with the work (Fig. 161). Watch the grain of the wood. Try not to scoop little hollows



Fig. 159

below the required depth of the cut. To smooth the surface after using the gouge, take the file, or curved scraper, and sandpaper, the latter held around a block curved to fit the desired shape.¹ (See page 78.)

52. The Spokeshave works on the same principle as the plane, but as it has

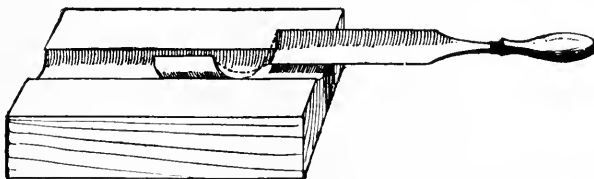


Fig. 160

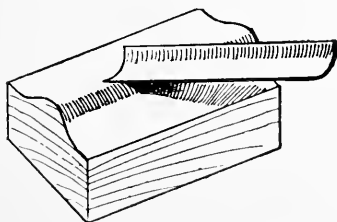


Fig. 161

a short sole or face to bear on the wood, it is used only for shaping and smoothing small curved or irregular surfaces. Grasp it firmly as in Fig. 162, bear downward, and push it from you so as to cut like a plane. It can also be drawn toward you. See *Sharpening*, page 128.

are made with adjustments for different curves, etc.,—also a “universal” spokeshave with movable handles and detachable side for rabbeting. The spokeshave is very valuable for much curved work, but should not be used as a substitute for the plane.

53. The Draw-knife or Draw-shave is useful for slicing off large shavings and for trimming wood into odd shapes (Fig. 163). It cuts much like a knife or very wide chisel, and can be used with the

Metal spokeshaves of various patterns



Fig. 162

¹ In carved work this smoothing can be omitted, as it is usually best to show the tool-marks.

flat side or the bevel against the wood as may be required. As it has only a short surface to bear on the wood and guide its course, it is

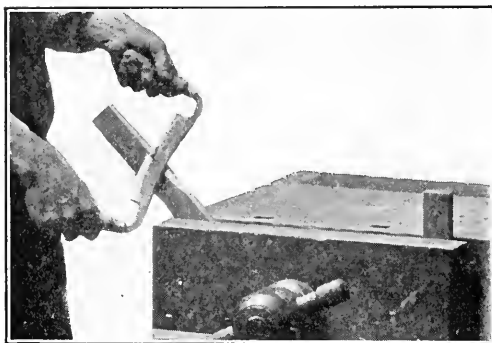


Fig. 163

apt to follow the grain and cut too deeply, so be careful to cut with the grain if possible. Stop and cut the other way whenever necessary. It is often best either to draw the tool sideways across the work while pulling it toward you (Fig. 164), or to hold it obliquely and pull it straight toward you (Fig. 165. See page 31.) It is a dangerous tool if left carelessly on the bench. See *Paring*, page 140, and *Chamfering*, page 158, and *Sharpening*, page 133.

ap to follow the grain and cut too deeply, so be careful to cut with the grain if possible. Stop and cut the other way whenever necessary. It is often best either to draw the tool sideways across the work while pulling it toward you (Fig. 164), or to hold it obliquely and pull it straight toward you (Fig. 165. See page 31.) It is a dangerous tool if left carelessly on the

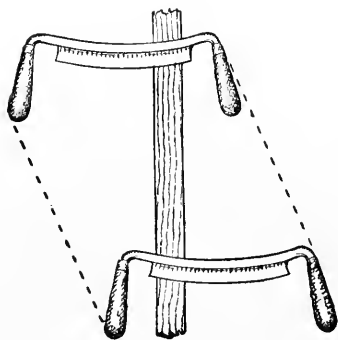


Fig. 164

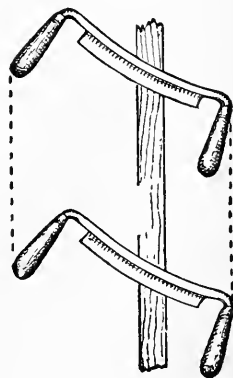


Fig. 165

Draw-knives are made with folding and adjustable handles, for places which can not be reached by the blade of the common form, and there are guiding attachments for chamfering, etc.

54. Trimmers, which are made in many forms, are excellent for trimming the ends of pieces accurately and smoothly at any

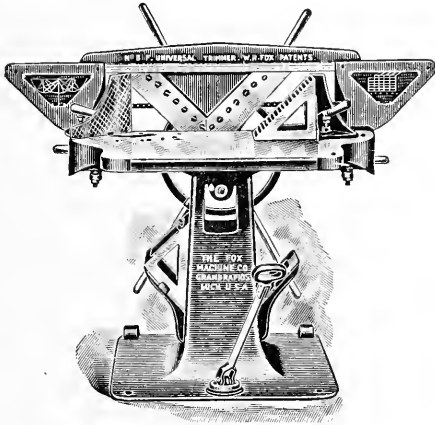


Fig. 166

required angle (Fig. 166).¹ An effective shearing stroke (see page 31) is made, and the wood trimmed to shape by a succession of thin slicing cuts. The cutting edge must be kept sharp.

55. The Scraper.—The cabinet-scraper is made of saw-blade steel, and is used to make a surface smoother than can be done with the plane or other tool. The edge is turned over as in Fig. 167 (see also page 109) and cuts off thin shavings. Hold the scraper between the fingers and thumbs (Fig. 168), inclined from you but as nearly upright as will allow the edge to cut well, and push it forward with force. Spring or bend it slightly so that it will cut in the middle (Fig. 169). Scrape with the grain as a rule. It is often best however to hold the scraper obliquely to the grain (Fig. 168), when there are little ridges or undulations on the surface, and where there are alternations of hard and soft grain, as in quartered oak. If the grain is crooked or twisted, scrape in any direction that will make the surface smooth. Test for smoothness by running the fingers over the surface with a light touch. An experienced workman can at once feel in-

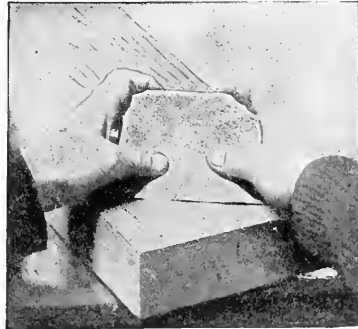


Fig. 168

¹ By permission of Fox Machine Co., Grand Rapids, Michigan.

equalities that he cannot see. When the scraper ceases to make fine shavings and merely scrapes off wood-dust, it is dull and should be sharpened. See *Sharpening*, page 133.



Fig. 169

Sometimes one end is held between the thumb and fingers of one hand and the palm of the other hand applied below to push the tool (Fig. 170), but for nice work the way shown in Fig. 169 is best.

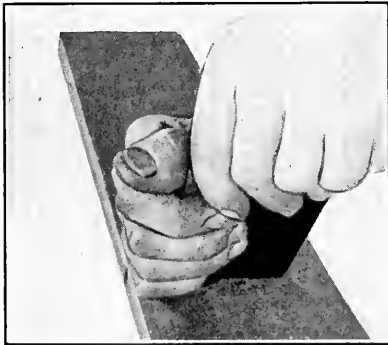


Fig. 170

A scraper is sometimes set in a stock with a handle or handles and also in a stock like that of a plane. The latter helps to keep the surface of the wood true, as the flat sole can not follow the irregularities like the hand scraper, with which there is danger of scraping more in one spot than in another. But so far as smoothing the surface goes there is nothing better or more easily taken care of than the common hand-scraper. It is best

to follow the scraper-plane with the hand-scraper. It is well to have

curved-edged scrapers for curved work. A block with slanting saw-cuts is good to hold scrapers when not in use. See *Scraping-machines*, page 109.

56. A few **Carving-tools** are often useful, and can have handles different from those of the other tools. A few carving chisels, both square-edged and skew (with the end ground obliquely), are good for odd-shaped work because the edge is bevelled on both sides. A *parting-tool* ("V" tool) and a small *veining-tool* (like a very small gouge) are occasionally convenient, though rarely needed for plain work.

TOOLS FOR PUTTING WORK TOGETHER

57. The Hammer.—The common forms for ordinary woodwork are the bell-faced and the flat-faced. The face is the part which strikes the nail. The former kind, as the face is slightly convex, will drive the nail farther into the wood without marring the surface than can be done with the flat-faced hammer.

There are many other varieties for special purposes, as for upholstering, riveting, etc. For general use choose a carpenter's hammer of medium size and weight. The Maydole bell-faced is good. A smaller brad-hammer or upholsterer's hammer is also very convenient.

58. Use of the Hammer. Nailing.—Hold the hammer near the end of the handle,¹ and swing it freely but so that the head can strike the nail squarely (Fig. 171) and not slantingly, or it may be driven crooked or bent. Use light strokes—mere taps—in starting the nail. After you are sure it is going straight, you can use more force. On nice work do not try to sink the nail quite flush with the wood. Leave that for the nail-set (see page 68), as even a slight dent will be likely to show when the work is finished.

To start a nail straight, sight it from different directions. Keep the face of the hammer free from grease or glue. Bore holes when

¹ In rare cases it will do to hold it nearer the head, as in driving very fine brads in delicate work.

there is danger of splitting or when slender nails are driven into hard wood, lest they bend. The hole should not be quite so large as the

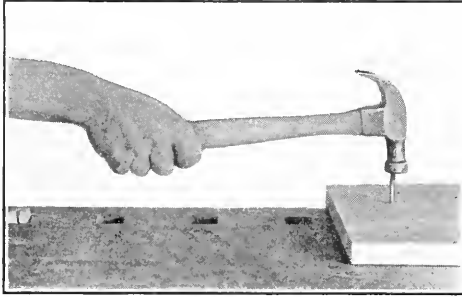


Fig. 171

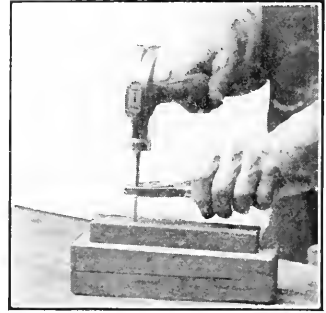


Fig. 172

nail. To drive long, slender nails into hard wood, hold with pincers (Fig. 172), or between three fingers, to lessen the danger of bending. With nails having large heads and in hard wood the holes in the outer piece can be about as large as the nails, if the latter drive tightly into the inner piece.

In such cases as shown in Fig. 636, drive the nails into the outer piece until the points prick through. Then place the piece in position for nailing and the points of the nails will help hold it in place. Nails drive into hard wood easier if the points are rubbed on a piece of soap.

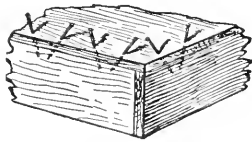


Fig. 173

59. "Toe" Nailing.—Nails hold strongest when driven slanting or "toed" (Fig. 173). Slanting the nails helps to draw one piece tightly up to another (Fig. 174), and this effect can sometimes be increased, after the

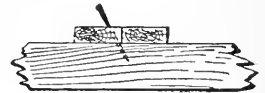


Fig. 174

nail has been driven part way, by drawing the hammer in the direction of the point of the nail so as to bend the upper part toward the other piece.

60. Clinching.—For good work nails made expressly for clinching should be used, though for rough work any nail that can be bent without breaking will do. Drive the nail through, hold a hammer or piece of metal against the head, and strike the projecting point with light, slanting blows so as to curl it over gradually to one side. As it bends, strike more directly downward until the hooked end is embedded in the wood. Clinch across the grain of the wood. The nail can be driven through a little way, the point bent over, the nail then driven in to the head, and the clinching finished by striking the bent end so that it is sunk in the wood, but without crushing the fibres (Fig. 175). Another way is to drive the nail through against a heavy hammer or other solid piece of metal, held on the other side, so that the point is bent over until buried in the wood.

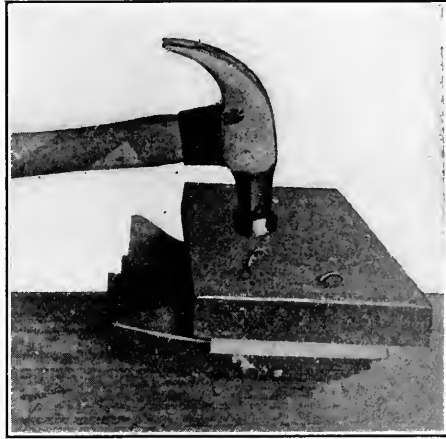


Fig. 175

Clinching is often useful, as in nailing cleats on a rough door and in boat work, and is better than toeing for anything that is to have violent strain.

61. Staggering.—In nailing cleats, or in similar cases, “stagger” the nails, that is, arrange them in a zigzag way (Fig. 442). This usually distributes them to the best advantage and lessens the danger of splitting the wood. This also applies to screws. (See page 69.)

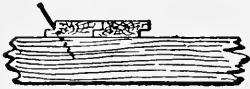


Fig. 176

62. Blind-nailing leaves no holes on the surface, as in floors of matched-boards. Each board is nailed slantingly just above the tongue (Fig. 176). This holds it down and draws it

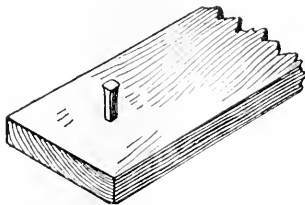
toward the adjoining board. The grooved edge of the next board conceals the nailing.

"*Sliver*" nailing is sometimes used for nice work. A little shaving is raised with the gouge (an inside gouge is best) or a narrow chisel¹ (Fig. 177), so that the nail can be driven and set. Hot glue is then dabbed into the groove, the shaving pressed back, and the place immediately rubbed with sandpaper drawn around a flat block until the shaving is firmly stuck. There may be a question as to the desirability of concealing methods of construction.

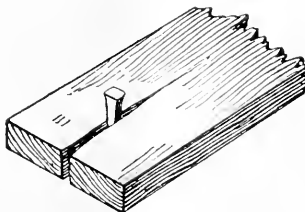


Fig. 177

The old-fashioned nails which taper on two sides should be used on the same principle as the brad-awl (see page 52), or the wedged shape of the nail may cause the wood to split (Fig. 178). With two sides smooth and two rough, you can tell by the fingers, as you pick



RIGHT



WRONG

Fig. 178

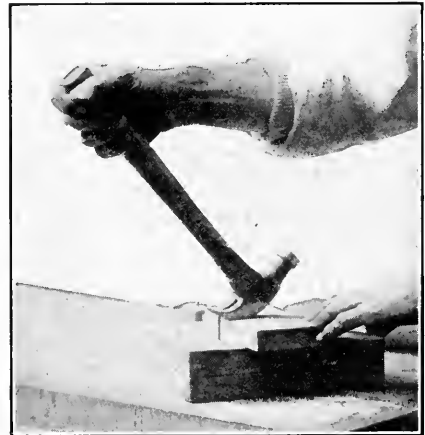


Fig. 179

the nails up, which way to hold them, the rough sides going across the grain and the smooth sides with it.

¹ A special tool is made for this purpose.

To set nails, see *Nail-set*, page 68.

To withdraw nails place a block under the hammer-head (Fig. 179), using thicker blocking, if necessary, as the nail is withdrawn, so that it can come out straight. After withdrawing a nail which has not driven straight, do not drive another in the same hole.

To draw nails from boxes, and in similar cases, pry up a board, together with the nails, a short distance—perhaps $\frac{1}{4}$ "—and then with a quick blow of the hammer pound the board back into place, striking between the nails. This will usually leave the nail-heads projecting a little above the surface, so that they can be drawn, as in Fig. 179. This saves splitting the boards and bending the nails.

63. Nails.—Wire nails are now used for most purposes, although the old-fashioned nails are better for some work, as shingling.

The old terms three-penny, eight-penny, etc., indicate the size. Distinguish between the common nails with broad flat heads and those with smaller round heads. The smaller sizes of the latter are called brads. If they are to be set,¹ use the round-headed ones, as the flat-heads make rough holes. Copper or galvanized nails and tacks are best for boat-building, copper being preferable, particularly for salt water.

64. Tacks are sold as one-ounce, two-ounce, and so on, according to size. Do not use tacks for fastening wood to wood (except in canvas-canoe work), but only for fastening leather, cloth, or the like to wood. The pointed wedge shape of the tack tends to split thin wood.

65. A Rivet is a pin of metal with a head, especially useful in boat work. Bore a hole for the rivet, drive it through the wood or metal, hold a hammer or solid piece of metal against the head, and pound down or "upset" the other end to form a second head. A washer or "burr" is slipped over the end of the rivet before upsetting it.

66. Bolts are of various kinds and are of great use where frame-

¹ Sunk below the surface. See *Nail-set*, page 68.

work must be fastened more securely than by screws or nails, as in parts of a gate, a bob-sled, boat-work, a heavy bench, etc. A washer should be used between the wood and the nut, and in work exposed to the weather a bolt should not be screwed up so tightly that the head is sunk in the wood, as water is apt to settle in the depression and cause decay.



Fig. 180

67. Dogs, which are merely short iron rods with the ends pointed and bent at right angles to be driven into the wood, are often used in heavy construction. If the pointed ends slant outwards slightly, they will tend to draw the pieces together (Fig. 180).

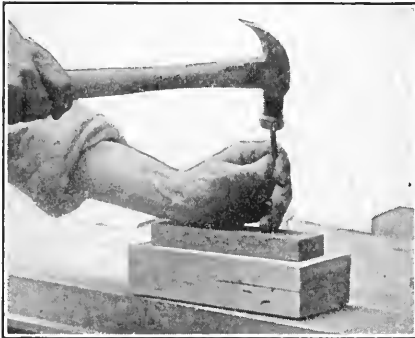


Fig. 181

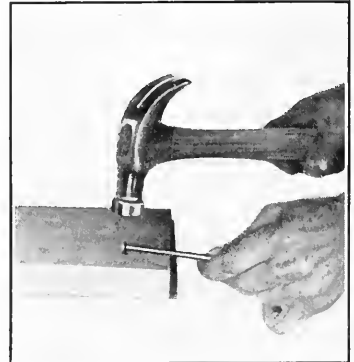


Fig. 182

68. The Nail-set or Punch is to sink nail-heads below the surface. Hold it firmly against the little finger, with the latter on the wood close to the head of the nail (Fig. 181), lest the nail-set slip off and deface the wood. The end must not be allowed to become rounded. If necessary, the head of a nail can be used (Fig. 182).

It is well to have several sizes. A slight conical depression in the end is good, and for larger nails there is also the spur set.

69. The Screw-driver.—Workmen usually prefer a long screw-

driver to a short one. A screw-driver-bit is useful for driving screws rapidly and with force, because of the leverage gained by the brace. Automatic screw-drivers work well for light work.

The end should be shaped like either of those in Fig. 183, so that it will remain at the bottom of the slot of the screw. If ground with a short bevel (Fig. 184), it will bear only at the top of the slot and will keep slipping out, on the principle of the inclined plane. A short bevel is also bad in extracting screws, as it necessitates pressing hard against the screw to keep the screw-driver from slipping out of the slot.

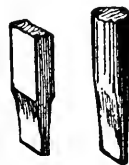


Fig. 183



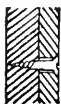
Fig. 184

70. Screws.—The common wood screws are either flat-headed, round-headed, or “oval”-headed, and of steel (bright, blued, bronzed, copper-plated, galvanized, or nicked), or of brass. To make a screw drive easily, rub the point on soap or beeswax.

The lag-screw is sometimes useful in fastening framework, as a bench, but should not be used where it will be seen in nice work. Nails are sometimes used when it would be better to use screws. Screws can often be tightened, if necessary, where nails would have to be re-driven. It is a recent custom to fasten many pieces of furniture with round-headed screws. In some cases this construction is strong. In others it is not. In most cases it gives the article the appearance of having been made either by an amateur or at a factory where cheapness of manufacture is the chief aim. The screw derives its value, mechanically speaking, from the principle of the inclined plane,—consisting of a thread winding spirally around a cylinder or conically terminated cylinder, the “pitch” of the screw depending on the inclination of the inclined plane or spiral. The size is indicated by the length in inches or fractions of an inch, and by the size of the wire from which the screw is made, as a $1\frac{1}{2}$ ” screw No. 9, meaning one and one-half inches long and made from No. 9 wire. Wood screws are made from $\frac{1}{4}$ ” to 6” in length and of wire from 1 to 30. Some screws for rough work are made to be driven with the hammer, the screw-driver being used only to finish the driving.

The hole for a screw should be so bored that the screw will just slip freely through the outer piece, and be screwed firmly into the inner one only (Fig. 185). The head of the screw will thus draw the outer piece tightly against the inner one.

The size of the hole in the inner piece should depend on circumstances. The stouter the screw the smaller hole required. The softer and larger the piece of wood the smaller hole required. If the piece is small or liable to split, the hole must be carefully made—very carefully in hard wood for a slender screw, as it is liable to twist off unless a sufficient hole is provided. Brass screws are very apt to do this, and much care must be used



in hard wood. If the hole is a trifle too large they will not hold. If a trifle too small they will twist off, which is very troublesome in such cases as hinge-screws, for instance, where the place for the screw can not well be changed. The hole in the inner piece (Fig. 185) should be somewhat smaller than the diameter of the screw. If the wood is quite hard the hole may be even as large as the core or solid shank of the screw if the threads were stripped off. In good sized pieces of soft wood there is frequently no need of any hole in the inner piece. Stop turning a screw in soft wood when it is well driven home, or you may strip off the thread the screw has cut in the wood.

Sink flat-headed screws flush with the surface, first using the countersink. For rough work in soft wood, however, the head of the screw can be driven flush with the screw-driver. If a screw hole must be moved a little, but not far enough to bore a new hole without the bit slipping into the old one, fit and drive in a wooden plug so that the new hole can be bored where required. For indoor work the plug can be dipped in glue. See *Screw-driver*, page 68 and *Staggering*, page 65.

71. Hand-screws are useful to hold pieces in any required position and to clamp work that has been glued. The larger sizes are more generally useful than the smaller ones. The C-shaped iron clamps, or carriage clamps, are also of great service.

To open or close a hand-screw, hold it at arm's length with a handle in each hand, and revolve it toward or from you (Fig. 186).



Fig. 186

When fitting it to hold two or more pieces, leave the jaws open a little at the tip at first (Fig. 187). Then give the final tightening with the outer screw until the jaws bear on the wood evenly (Fig. 188). When the surface of the wood may be injured by the pressure, put pieces of waste wood between the work and the jaws. Before glue is applied, the hand-screws should be fitted and placed where they can be put on as quickly as possible.

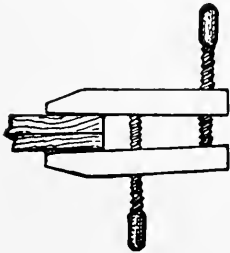


Fig. 187

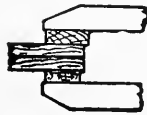


Fig. 188



Fig. 189

Glue often sticks to the insides of the jaws and should be removed by scraping, lest it deface the work. The screw threads should be rubbed over with blacklead, soap, bayberry-tallow, or beeswax and tallow melted together.

A clamp, suitable for such work as temporarily holding in place parts of a boat, is shown in Fig. 189. A hand-screw used in the benchwise is sometimes convenient to hold an odd-shaped piece (Fig. 190).

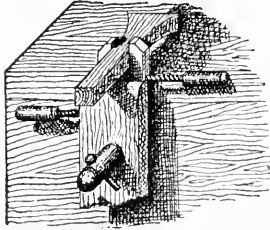


Fig. 190

that either the flat sides of the bars or the corners, as shown, touch the surface of the work, to keep it from bending toward the bars when the screws are tightened. Before glue is applied, the clamps should be fitted and placed where they can be put on as quickly as possible. When several clamps are used, tighten each in turn a little at a time, so that the joints may be brought together evenly. There is not much danger of clamping too securely.¹ See *Jointing*, page 47.

72. Clamps.—Cabinet-clamps, shown in Figs. 192 and 193, are useful in making glue-joints and in other operations. To clamp two or more flat pieces together, as in making a glue-joint, or a door-frame, lay the work on the horses, and apply the clamps as in Fig. 191. Put pieces of waste wood between the work and the clamps. Place the clamps so

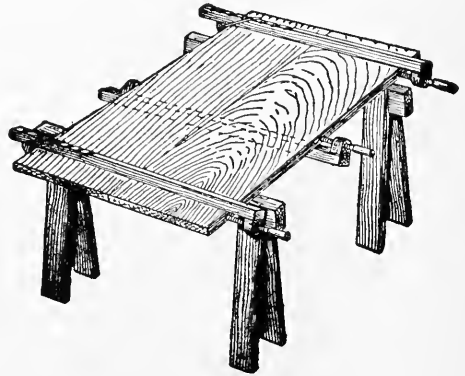


Fig. 191

¹ Unless the pieces are firmly clamped throughout, their shape may change before the glue becomes set. Clamping at only one or two points may force the joint to open elsewhere. First make the best joint you can. Then, after gluing, hold the pieces together with a good number of clamps, firmly and evenly tightened. The old-fashioned way of rubbing the two edges together and then leaving the rest to the glue is not so good for the beginner as to use clamps, except with small pieces, such as corner-blocks. (See page 76.)

As the clamps are tightened sight across the surface of the work. It will often be winding. (See page 18.) When this happens, move one or more corners of the work up or down, as may be required, in the clamps (Fig. 192), until the surface is true. A little experimenting will show how to do this. In the case of

framed work, such as doors, also test the angles with the square as soon as the joints come together. If the angles are not right, move one end of either or both of the clamps to the right or left, as the case may require (Fig. 193), and you can easily change the

angle until the square shows it to be right, when the screws can be tightened and the joints should close accurately. In truing work in this way with



Fig. 192

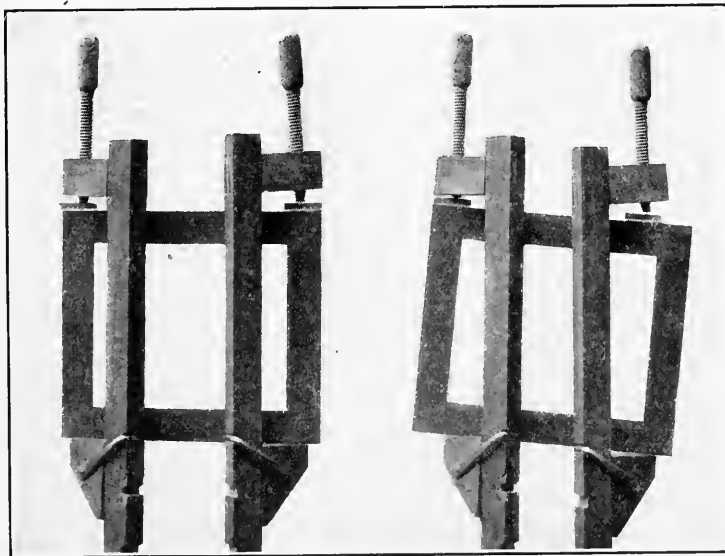


Fig. 193

clamps, particularly when cold glue is used, examine once or twice soon after setting the clamps to see that the continued pressure has not moved the work too much.

In such cases as that shown in Fig. 191, if hot glue is used, waste no time in trying to get the surfaces *exactly* flush with each other at the joint before partially tightening the clamps, lest the glue become set. Then any slight alteration can be made by tapping with the hammer near the joint. Use a waste block to strike against unless the dent from the blow will be removed afterwards by planing. The clamps can then be screwed tighter. See *Glue*, page 182. Where the pieces to be glued could be bent by the pressure of the clamps, put

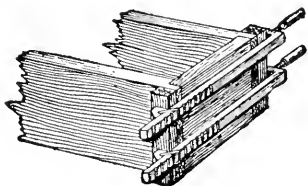


Fig. 194

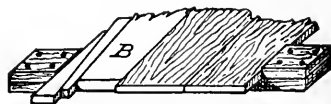


Fig. 195

stout pieces of waste wood between the work and the clamps (Fig. 194), to distribute the pressure and prevent bruising. See also *Hand-screws*, page 70.

Where pieces are already finished or for any reason can not be planed or scraped near the joint after gluing, put paper between the joint and the clamps.

Wooden clamps answer every purpose. Steel ones are better, but more expensive. Wood and iron are also combined. For heavy work, metal screws with winch handles are good.

Useful clamps can be made of any strong strips of wood of suitable length by nailing with clinch nails, or screwing, or bolting a block at each end (Fig. 195). The work can be tightly wedged to a close bearing by driving the slightly tapered double wedge (see *Wedges*, page 139); or by fastening one of the blocks at an angle, a single wedge of corresponding slant can be used.

Fig. 196 shows a simple clamp, easily made of two strips with corresponding holes in each.

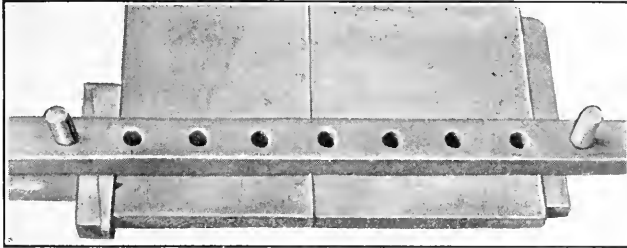


Fig. 196

In some cases a stout cord doubled, can be put around the work, and a stick inserted between the two parts of the string. By turning the stick the cord becomes twisted and the parts of the work drawn together (Fig. 197).



Fig. 197



Fig. 198

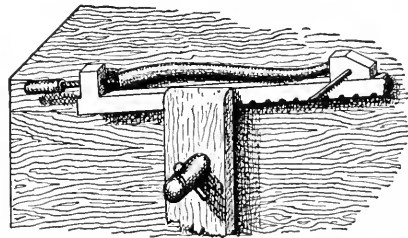


Fig. 199

Pressure can sometimes be applied by using the elasticity of a board or pole, sprung into place between the work and some firm object, like a beam of the floor above (Fig. 198).

Pressure can often be applied by a lever, and by wedges. To hold odd-shaped pieces for working, a clamp can sometimes be used with the vise (Fig. 199).

73. Corner-blocks are small pieces of pine, or other wood which holds glue well, rubbed with hot glue into interior angles of cabinet-work, to strengthen and stiffen the work (Fig. 200). The grain of the blocks should run in the same direction as that of the adjoining surfaces, if possible. Have the blocks warm, apply hot glue plentifully, rub the blocks back and forth several times, and leave to dry.

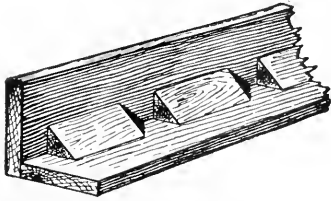


Fig. 200

If cold glue is used, the blocks should be held in place with hand-screws or clamps until the glue is hard, or be screwed or nailed.

Blocks to strengthen the inner corners of tables, chairs, etc., to be glued and screwed to the rails or other surfaces, should be got out with the grain running as shown in Fig. 201, for strength. The same principle applies to brackets of any kind where short grain at the ends would be liable to break off.



Fig. 201

MISCELLANEOUS TOOLS AND APPLIANCES

74. The Mallet is used to strike wooden tool handles and is made in various forms and sizes.

For heavy work it is well to have the handle put through the head from the outside, because then the head can not come off. A rounded head with the handle on the end saves effort, as it is equally effective in any position. Hickory, lignum vitæ, maple, or any dense, hard wood is good for a mallet. Rubber heads are useful in putting furniture together, to save bruising.

You do not gain force by using the mallet instead of the hammer, but the softer and more yielding blow saves the tool-handle.

75. The File is a piece of hard steel with rows of ridges or teeth cut obliquely on the surface, and is valuable for smoothing or rounding edges and curved surfaces. The teeth incline towards the point of the tool, so that it cuts when pushed forward.

Fasten the wood firmly and use the file with both hands. Hold it with the right hand, thumb uppermost, and steady the end with the left hand, thumb uppermost (Fig. 202), or with the fingers or palm. To file squarely across, push the tool steadily straight forward with a long stroke, without rocking up and down. Press only on the forward stroke. The use of the file is not to be recommended where a clean-cutting tool like the plane, chisel, drawshave, or spokeshave can be used; but there are many quick curves for which it is the best tool, and often there is not room to use the edged-tools. In filing rounded surfaces, a rocking motion is often best, and the way to file in all cases should depend upon the shape of the work and the grain of the wood. See *To Round a Stick*, page 160.

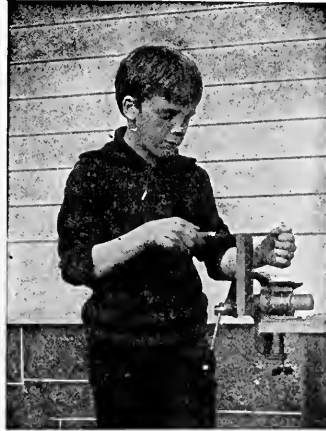


Fig. 202

The "half-round" shape, or cabinet-file (Fig. 203) is the most useful. The round (tapering) form is also convenient. Many other shapes, straight and curved, are sometimes useful, as carver's files, etc. For metal, the triangular, flat, half-round (Fig. 204), and round



Fig. 203



Fig. 204

forms are most needed. When the teeth are cut in one direction only a file is called *single-cut*, but when there are two oblique rows of teeth crossing each other it is called *double-cut*. A file meant for wood should not be used on metal, nor a file for metal on wood. Press lightly in using a new file. When a file becomes clogged with wood-dust or other substances use a *file-card*, or fine wire brush. Soak a clogged file in hot water and brush with a stiff brush.

76. The Rasp—for wood—is a kind of coarse file, but instead of ridge-like teeth it is studded with projecting points, which tear off the wood more quickly, but more roughly, than the file. It is useful to work curved objects roughly into shape.

A good-sized half-round cabinet-rasp is a valuable tool, if used with discretion, but should be put into the hands of advanced workers only, for the beginner is apt to prefer it to the edged-tools which he should be learning to use.

77. Sandpaper should be used, as a rule, merely to give a little extra smoothness, to remove fine scratches, to round edges and the like, but not to cut away the wood and scrub it into shape. To use it much, except to skim over the work, encourages a slovenly style of working, and the result lacks the sharp accuracy of good work. Do the work right and you will need but little sandpaper, except in a few special operations. Avoid using it until all cutting with the tools is done, if possible, for the grit dulls the tools. Sandpaper with the grain, except for work



Fig. 205

which is to be painted.

The fineness of sandpaper is indicated by numbers—00 (the finest), 0, $\frac{1}{2}$, 1, $1\frac{1}{2}$, 2, $2\frac{1}{2}$, and 3 (the coarsest). A size coarser than $1\frac{1}{2}$ is seldom needed. For most work a sheet can be torn into four parts, by means of any straight edge.

For a flat surface fold the sandpaper over a flat block of cork or wood perhaps 4" or 5" long, 3" or 4" wide, and 1" thick (Fig. 205), with the edges slightly rounded. After using the block, finish with the paper in the hand (Fig. 206). For an edge the block should be narrower than the edge (Fig. 207). If the surface be curved, a block curved correspondingly should be used. A piece of thick rubber or leather which can be bent is good for curved surfaces.

Care should be taken not to round the corners and edges of the work, since the paper cuts more near an edge than on the middle of



Fig. 206



Fig. 207

a surface. To avoid rounding the angles when the paper is used in the hand, hold it as in Figs. 208 and 209. In sandpapering delicate



Fig. 208



Fig. 209

work, when the edge might be rounded or the surface scratched by

even the finest sandpaper, as in rubbing down finished work (see *Finishing*, page 188), split the paper by removing the outer layer when the part to which the sand adheres will be more flexible. Sandpaper can be dampened on the back to soften it.



Fig. 210

Small pieces of wood can often be sandpapered best by rubbing them carefully on the sandpaper. To sandpaper a small end, lay the paper on a flat surface, hold the piece of wood upright, with the hand close to the sandpaper and push the piece steadily forward (Fig. 210). Raise it from

the paper on the backward stroke and push forward again. After a few strokes reverse the piece and push forward with the other edge in advance, and so on. To sandpaper an inner corner fold the paper and push it into the angle. In sandpapering round pieces like cylinders, sandpaper less, and more carefully, at the ends than elsewhere, or like other edges and corners they will be cut away too much. Faces or surfaces which come together to form joints should not be sandpapered.

For sandpapering rounded edges, etc., see page 161. See also *Sandpapering-machines*, page 110.

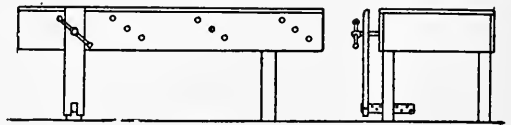


Fig. 211

Long, fine steel shavings called *Steel-wool* can be used for cleaning off paint and such work, but should not be used until all work with the edge-tools is done, because of the particles of metal.

78. The Work-bench.—There are many kinds, some with metal frames, but the general type is the same. For home use, a simple

carpenter's bench, easily made, can be used (Fig. 211), but those

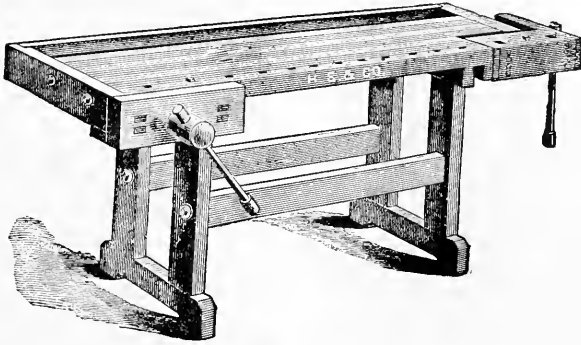


Fig. 212

made for cabinet-makers and for school use are much better (Figs. 212 and 213).¹

In many the back part of the bench-top is an inch or so lower than the front, with a strip at the back edge and sometimes at each end, forming a tray (Fig. 213), where tools, small pieces of work, etc., can remain while in use, keeping the front part clear for actual operations. The front part of the top should be of hard wood and is best built of selected strips glued and bolted together. The practical workman usually prefers a plain simple bench. There is no danger of a bench being too strong and solid,

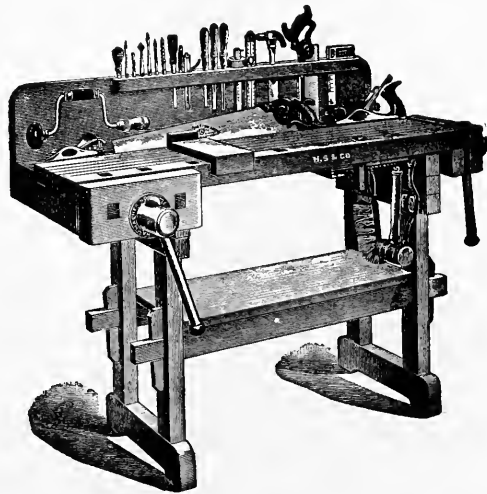


Fig. 213

¹ By permission of Messrs. Hammacher, Schlemmer, and Co., New York.

and it should be firmly bolted to the floor. For school use it is convenient to have it adjustable in height.¹

79. Bench-stop.—There is nothing better than the old-fashioned form shown in Fig. 214, which will not damage the work or the tools, and is easily raised or lowered.

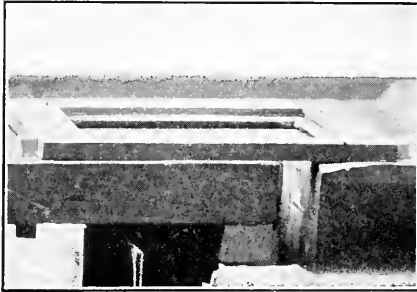


Fig. 214

80. The Bench-vise.—The work should be clamped in the vise only tightly enough to keep it from slipping. If a piece has to be held with considerable force in one side of the vise only, put a piece of waste wood of the same thickness in the other side (Fig. 163), to prevent straining the vise and to hold the wood with even pressure.

There are excellent bench-vises (preferably with jaws of wood), and also with a “quick-action” or “instantaneous-grip.” These are good, but are not necessary, and some think a common wooden vise better for the beginner. Some also prefer a bench without a tail-vise² for the beginner, on the ground that he should learn to keep the work steady without it, but a tail-vise is certainly very useful, and almost essential, in many cases.

81. Horses or Trestles are to lay stock on for marking or sawing, to put large work together on, and for similar uses (Fig. 191). Keep the tops smooth and clean, for hardened glue or varnish will deface nice work. See also page 242.

¹ The height should be such that the workman's right elbow, when holding the plane, is slightly bent and his back about straight (Fig. 127). If much too low, the work can not be managed well, the workman's back will get tired, and he may become round-shouldered. If much too high, it will be hard to manage the work, the planing can not be so well done, and the arms will become tired. A bench for carpentry is usually rather lower than for cabinet- or pattern-making, while a carver's bench is usually higher.

² The vise (with a stop) at the right-hand end of the bench, used for holding work flat on the bench-top against one of the stops (Fig. 214).

82. The Bench-hook (Figs. 79 and 124), holds small work firmly for sawing, planing, etc., and also saves marring the bench-top. It is placed on the bench as in Fig. 213, or one of the cleats can be screwed in the vise. For its use, see pages 27 and 40..

About 15" long by 6" wide is a convenient size. The cross-cleats should be screwed on and should be square with the right-hand edge of the board. If one cleat is short as in Fig. 215, it will save marring the bench in sawing. A kerf is sometimes made in the cleat for sawing at right angles (Fig. 216) and also at a mitre. See also page 85.

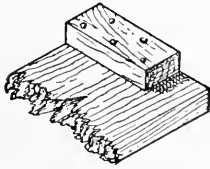


Fig. 215

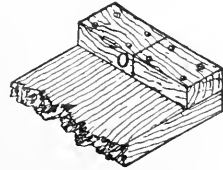


Fig. 216

83. The Shooting-board or Jack-board

is for jointing, and for squaring edges and small surfaces and ends with the plane,—and is particularly useful for short, thin stock. Lay the board to be jointed on the raised part of the shooting-board with the edge projecting.

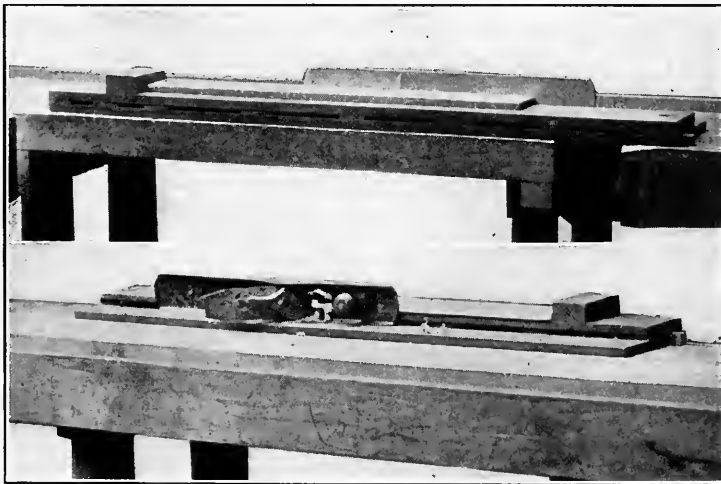


Fig. 217

Hold it firmly with the left hand. Use the plane on its side on the lower part of the shooting-board (Fig. 217). Thus the cutting-edge of the plane is approximately at right angles with the surface of the board, and the edge will be planed as nearly square across as the accuracy of the apparatus will allow.¹

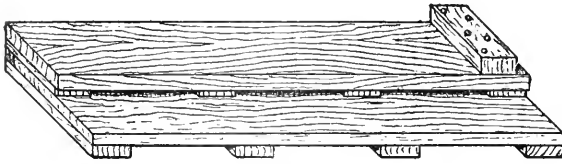


Fig. 218

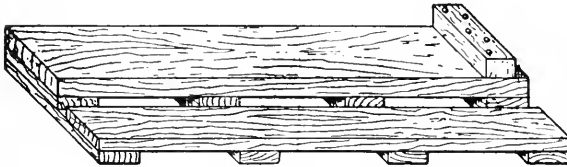


Fig. 219

The shooting-board should be fastened on the bench as shown. One of two pieces to be jointed for gluing can be turned over, as described on page 49. See *Jointing*, page 47 and *Bench-hook*, page 83.

A jack-board can be of any wood which holds its shape well. Clear white pine or mahogany is good. The stock must be planed free from winding. Two forms are shown in Figs. 218 and 219. The construction is plain, but careful work is necessary. Approximate dimensions are suggested, Fig. 218 being made of $\frac{1}{2}$ " and $\frac{1}{4}$ " stock, and Fig. 219 of $\frac{3}{8}$ " and $\frac{1}{2}$ " stock. Screw the pieces together from the under side. The stop or cleat should be at right angles to the nearer edge. In Fig. 218 the top board overlaps the ends of the cleats a trifle, which (with the spaces between the cleats) allows the escape of the

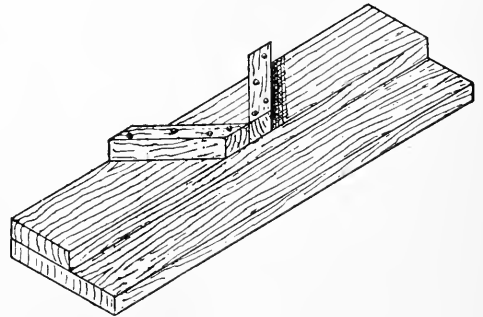


Fig. 220

¹ See footnote, page 41.

shavings. *Chute-boards* are also made of metal, and are of course more accurate.

A *mitre-shooting-board* or jack-board (Fig. 220) is also useful. The angular stop or stops must be fitted to make the angles exactly 45° . A

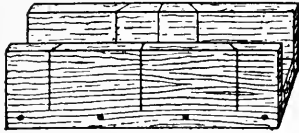


Fig. 221

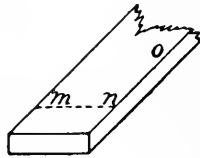


Fig. 222

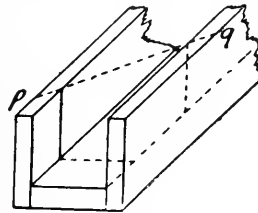


Fig. 223

sawed mitre holds glue better than a planed mitre, but trimming with the plane is often required.

84. Mitre-box.—An iron mitre-box which will cut at various angles is the best. See also *Mitre-shooting-board*, above, and *Trimmers*, page 61.

Great care is necessary to make an accurate wooden mitre-box (Fig. 221). Pine or beech is good. Do not use spruce or any wood liable to warp or twist. Square a line, $m n$ (Fig. 222) across the top side of the bottom piece, before putting together; and lay off from one end of this line a point o on the edge, at a distance equal to the width of the bottom, thus fixing the points m , n , and o . Next fasten on the sides, square upright lines on the inside of one side from the point m and on the inside of the other from the point o . The diagonal line $p q$ (Fig. 223) will represent the mitre.

The kerf for the saw to run in should be made with a back-saw or a panel-saw. In a similar manner square on the inside two upright lines opposite each other, draw a line across the tops of the sides to meet these lines, and make a kerf, as shown by the middle line in Fig. 221, for sawing squarely across. Fig. 224 shows a mitre-board for sawing strips, mouldings,

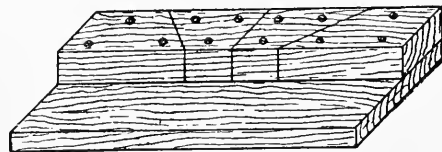


Fig. 224

and the like. Be sure the surfaces and edges are true and square. A good size is from 1' to 2' long and 6" wide (in all). The lower piece can be of $\frac{7}{8}$ " stock, but the upper one should be $1\frac{1}{4}$ " to $1\frac{3}{4}$ " thick. Mark the lines first on the bottom of the upper piece, then on the edges, and lastly on

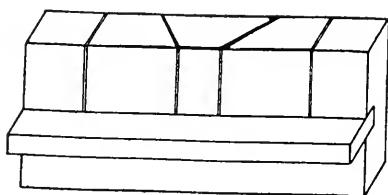


Fig. 225

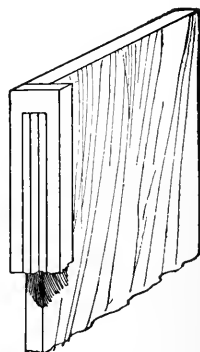


Fig. 226

the top, as with the mitre-box just shown, so that they will be at the correct angles with the surfaces against which the wood to be sawed will rest. A good form, readily held in the bench-vise, is shown in Fig. 225.

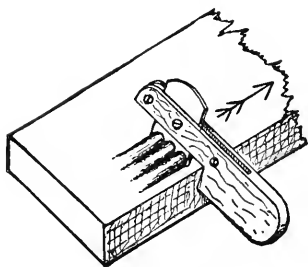


Fig. 227

85. Bead-cutters and reed-scrapers and fluters can be bought of various patterns. It is usually best to stop reeding a short distance from the ends of a surface, and with the chisel cut the reeds to a square end (Fig. 226).

Fig. 227 shows an easily made tool for scraping beading, reeds, and the like. The blade, made of a piece of saw-blade steel, is filed to the shape required. The hole in the blade is larger than the screw to allow of adjustment. This tool is pushed forward with both hands.

86. Winding-sticks (which are simply *straight-edges*), are to

help in getting surfaces true, and to determine whether different parts of the work are in the same plane. Take two straight-edges, each of equal width throughout, and lay them on edge, one across each end

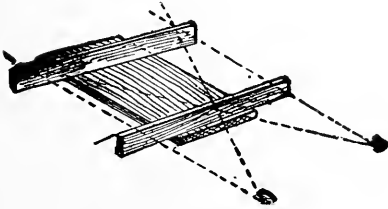


Fig. 228

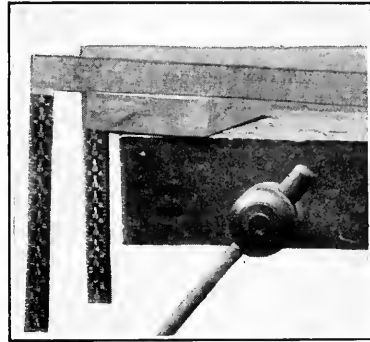


Fig. 229

of the surface to be tested. Stand back and look across the top edge of one to the top edge of the other. If these are in line there is no winding where the straight-edges are placed (Fig. 228). By putting them in different positions it can be determined whether the whole surface is true. Two framing squares can often be used as in Fig. 229, which shows the surface to be winding.

It is more accurate to use straight-edges longer than the width of the surface to be tested, as any warping or winding will be more easily seen (Fig. 230). If the upper edges of the sticks are thin, or "feather-edged," it is easier to tell when they are in line, but common straight-edges are sufficient for ordinary work.

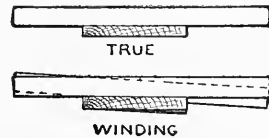


Fig. 230

To make a chair or table, for example, stand evenly, turn it over, lay straight-edges on the ends of the legs, and sight across (Fig. 231). Then trim one or two legs until the straight-edges are in line. For other methods, see page 256.

87. **Vise for Metal.**—Every woodworking shop should have a vise for holding metal, as those for woodworking should not be used for metal, and also a good wrench, a pair of pliers or pincers, cutting nippers, and files for metal. (See page 77.) Shears for metal and a hack-saw are sometimes useful.

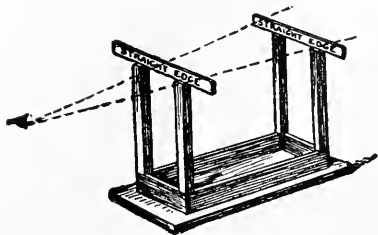


Fig. 231

88. **An Anvil** is often of use and is sometimes combined with a vise. It should have a flat steel surface and also a tapering point or "round horn."

89. A solid **Chopping-block**—a section of a tree-trunk—is often convenient.

WOODWORKING MACHINES

All who work in wood, even if they do not use machinery themselves, should be familiar with the general principles on which the machines work and should know what they can do.

To use woodworking machinery properly and safely the pupil should learn, under competent supervision rather than from a book, the principle, construction, and care of each machine, the meaning, use, and relation of all the parts. Each machine must be kept in good order, properly adjusted, properly lubricated, and the cutting-edges sharp. Also, while using a machine, the operator must attend strictly to what he is doing and to nothing else, or there may be an accident. This can not be impressed too strongly upon him, or upon others who might interrupt him or distract his attention.

There are so many designs and arrangements for each kind of machine that they cannot be described in detail, and the special study of such machines as are in use in each workshop must be made from the machines themselves. Combination machines often save expense and space; but if they are much used it wastes time to keep

changing the adjustments, and delay is caused by waiting for one's turn. It is better to have separate machines for each purpose if they can be afforded. Independent motors for each machine have some obvious advantages.

The most important machines for general woodworking are the Circular-saw, Band-saw, Planer, Jointer, Moulder, Boring-machine, Mortising-machine, Tenoning-machine, Jig-saw, and Turning-lathe. There are other machines for various purposes.¹

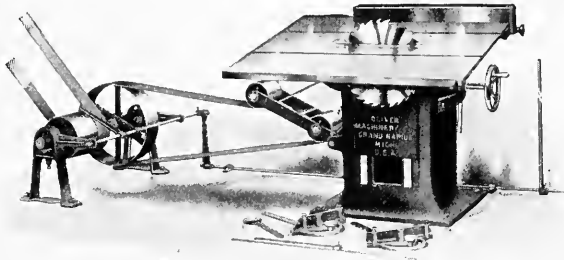
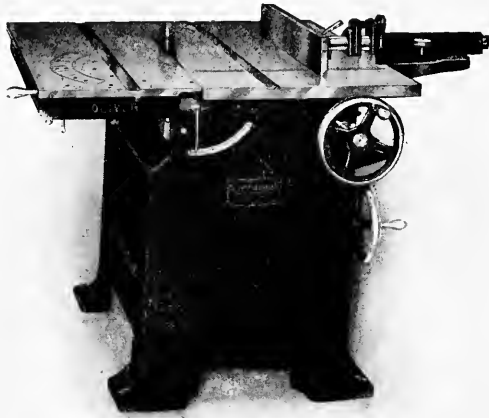


Fig. 232

90. **The Circular-saw** is the most generally useful machine, and the rapidly revolving saw cuts with speed, ease, and accuracy. Large circular-saws are used for sawing logs. In the smaller sizes for shop-work the saw projects through a bench or table-top (Fig. 232) on which the wood to be cut rests. As both splitting and cross-cutting saws are used, most of the common operations of hand-sawing can be done with the circular-saw, and also many special operations. Adjustable guides or gauges are fitted to the saw-bench top so that different lengths, widths, and angles can be cut. Fig. 232 is a typical illustration of a modern circular-saw bench. Fig. 233 shows the

¹The illustrations of power woodworking machinery are inserted by permission of Messrs. Baxter D. Whitney and Son, Winchendon, Massachusetts, and the Oliver Machinery Co., Grand Rapids, Michigan; and those of foot-power machines by permission of the W. F. and John Barnes Co., Rockford, Illinois, and Messrs. J. M. Marston and Co., Boston, Massachusetts.

gauges. That on the further side is for splitting, and those on the nearer side are for cross-cutting, either at right angles or at different



degrees. Fig. 234 shows a convenient form which carries two saws at once. Either can be quickly raised for use. Such machines have many convenient adjustments. A great variety of work can be done, however, with a saw-bench which has only the simple splitting and cross-cutting gauges, and illustrations 235 to 261 are taken with an inexpensive saw-bench to show the great usefulness of such machines where more expensive machinery is not available.

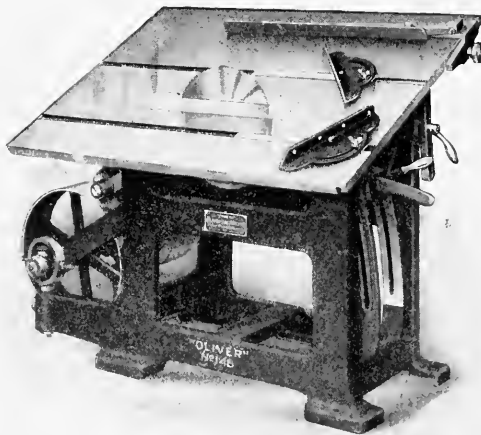


Fig. 233

The circular splitting-saw cuts on the same principle as the hand splitting-saw (see page 25), although the teeth are often "swaged" (see page 138). As the saw revolves toward the operator, it must be fitted on the arbor so that the teeth on top point toward the front of the bench (Fig. 232).

The cross-cutting saw also works on the same principle as the hand-

saw. See pages 22-25. Either the saw-bench top, or the saw itself, is made to raise or lower, so that the saw may project above the

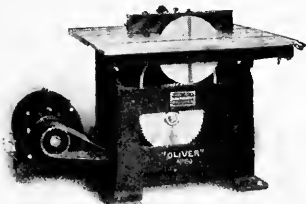


Fig. 234



Fig. 235

bench-top as much or as little as may be required. It cuts best when it projects only enough to cut through the piece to be sawed (Fig. 237). Always put the saw on with the maker's name on top, to reduce to the minimum the variations due to irregularities and to wear.

To split a piece roughly the wood can be guided by hand while the line is followed by eye (Fig. 235), but for all accurate work the gauge should be used (Fig. 239). Advance the wood evenly and lightly. Do not force it against the saw. Raise the end of a

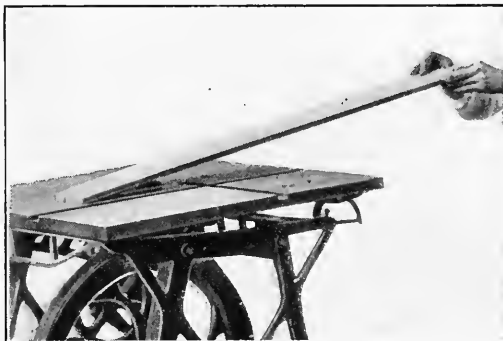


Fig. 236

long board very slightly above the level of the bench-top at first. To stop splitting instantly, or to remove the board instantly, raise the end you hold, so that the wood will clear the saw (Fig. 236).

Hold a short piece carefully as in Fig. 237, always keeping the hands in front of the saw—between the saw and yourself—or well

to one side. As the motion of the saw is toward the operator the hands cannot be drawn toward it while they are kept in front; but

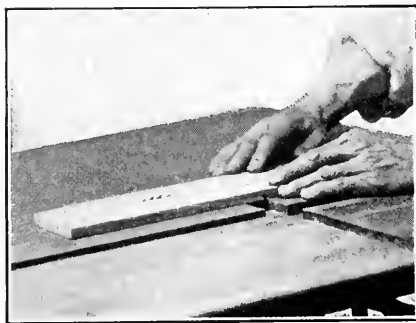


Fig. 237

if they are behind the saw or too close to the sides of it and anything happens there is great danger that they may be drawn against the teeth. Any attempt to escape or to remove the hands will be futile, for the motion of the saw is much quicker than any possible muscular movement. Many accidents come from carelessness in this respect. Another person may hold the ends of a diffi-

cult piece after it has passed a safe distance beyond the saw. If the wood binds on the saw it can be wedged at a safe distance behind the saw, as in hand-sawing (Fig. 74), but do not reach over the saw to do this, unless you have first stopped the machine. An attachment can be used behind the saw to prevent the wood binding.

At the end of the cut the pieces must be so pushed along that they are kept clear of the teeth at the further side of the saw (Fig. 238), or there may be trouble. If a piece is to be brought to the front of the saw again for further sawing, bring it around at either side of the saw,—never above it, for if it should fall upon the saw-teeth it might be hurled at you with force enough to inflict a serious or even



Fig. 238

fatal injury. When the saw-teeth fairly get hold of a piece in this way it will be moved toward the operator at a speed equal to that at which the periphery of the saw is moving,—perhaps from 5000 to



Fig. 239



Fig. 240

10,000 feet a minute. Guards can be fastened to a saw-bench to protect the operator. A piece of plank is often suspended over a saw to prevent danger from flying pieces.

To saw accurately with the splitting-saw one edge of the piece must be straight and kept against the splitting-gauge (Fig. 239), which can be adjusted at any required distance from the saw. When reaching the end of the cut, if there be a space of several inches between the saw and the gauge the piece on that side of the saw can be safely pushed through with the hand, provided two or three fingers are hooked over the top of the gauge, so that, if anything happens, the hand will instinctively cling to the gauge and thus be kept from being drawn against the saw-teeth (Fig. 239). If the space be narrow, push the piece

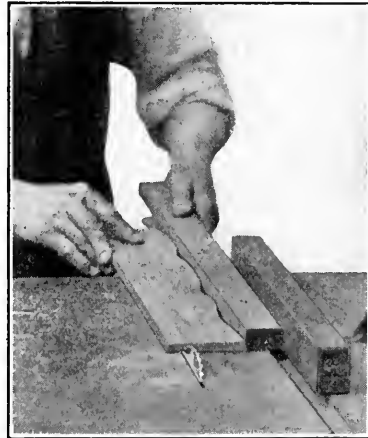


Fig. 241

through with a stick notched at the end as in Fig. 240. Push the piece clear through. Do not reach over after it. To split a

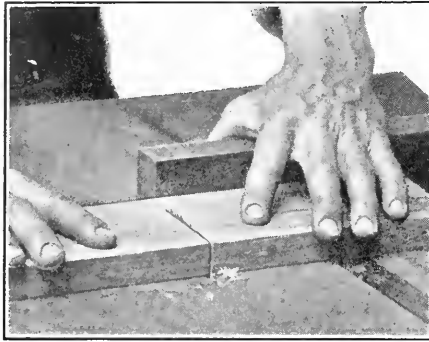


Fig. 242

splitting-gauge can be tipped for cutting bevels.¹

To saw across the grain use the cross-cutting saw, and also the cross-cutting gauge, which slides back and forth at right angles to the saw. Hold the wood firmly against the gauge (Fig. 242). If the piece to be cut off is long enough to require being held by the hand, simply steady it without pushing, lest the wood close on the saw (Fig. 242). Cross-cutting gauges are also adjustable to cut at any angle. Some gauges have an adjustment or "stop" for use when a number of pieces are to be cut of the same length, or a stick with a shoulder at the

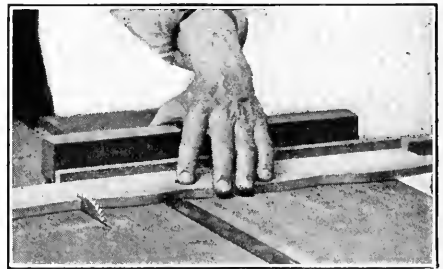


Fig. 243

¹ In splitting with the gauge tipped at a bevel, the piece often tends to slip away from the gauge at the angle where the gauge and bench-top meet. To prevent this another gauge can be fitted on the other side of the saw. If the machine has but one gauge, another can easily be made of wood for this purpose.

end can be attached (Fig. 243). A stop can also be attached to the splitting-gauge to regulate the length of pieces to be cut with the cross-cutting gauge (Fig. 244).¹

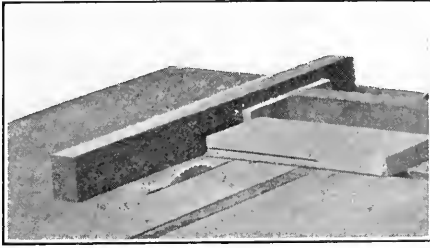


Fig. 244

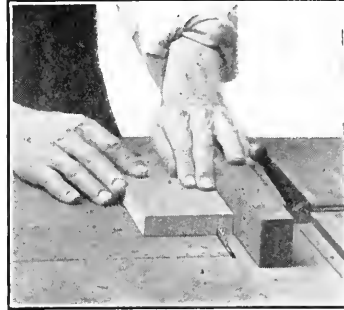


Fig. 245

To cut a rabet, lower the saw, or raise the bench-top, until the splitting-saw projects above the top just the depth of the rabet. Then set the splitting-gauge at the width of the rabet and make a kerf (Fig. 245). Cut the other side of the rabet in the same way (Fig. 246). If the rabet is to be cut across the end, use the cross-cutting saw and the cross-cutting or the splitting-gauge, as the case may require.

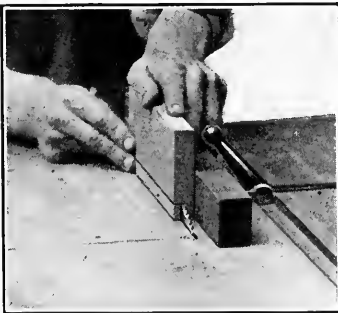


Fig. 246

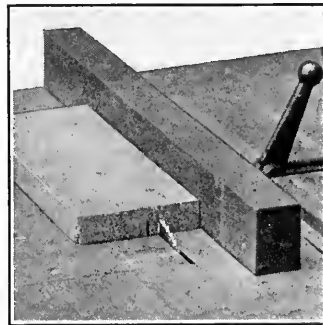


Fig. 247

¹ The splitting-gauge itself can be used as a stop, but a piece attached as in Fig. 244 is sure to give the wood clearance.



Fig. 248

To cut a groove, make a kerf at each side of the groove (Fig. 247), and remove the wood between by a series of parallel kerfs (Fig. 248). When much grooving is to be done, the saw can be "wobbled." For this a thick saw must be used, as a thin one will not be stiff enough. Make a pair of thin wedge-shaped collars of wood (Fig. 249), and place one on



Fig. 249

each side of the saw, so that they point in opposite directions (Fig. 250). Thus the saw will no longer be at right angles to the arbor on which it revolves, and the cutting-edge will wobble from side to

side and make a wide kerf (Fig. 251). The width of cut depends upon the slant of the collars, and can also be altered by changing their relative positions. Test with a piece of waste wood and alter the collars until

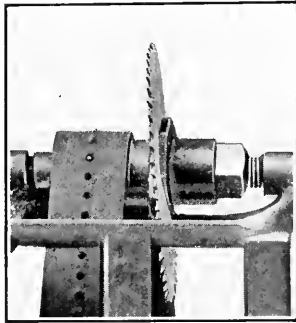


Fig. 250

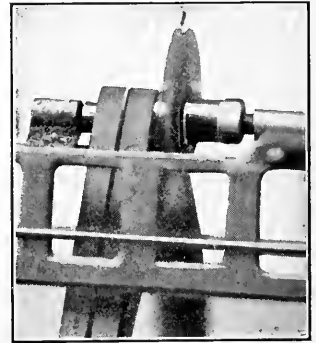


Fig. 251

the width of the groove is right.¹ Thick saws are made for grooving

¹ A simpler way is to fold up the necessary thickness of cardboard or some similar substance (Fig. 252), and insert equal thicknesses above and below (Fig. 253). This ensures tightness and stiffness of the saw, as the hardest cutting is done with the teeth which are on top and beneath when the saw is being adjusted. After the saw is fastened in place, a little tightening with the wrench will compress the pasteboard wedges more and thus alter the width of the cut.

(without wobbling), and special cutters are made for grooving and a great variety of similar work. Although convenient, these are not necessary for common work. Dados, grooves across the grain, are cut in the same way, with the cross-cutting saw or with the cutters made for the purpose. The cross-cutting saw can also sometimes be used for grooving and rabbeting lengthways in fine, light work, where an especially smooth kerf is desired, and in other splitting operations in light work.



Fig. 252

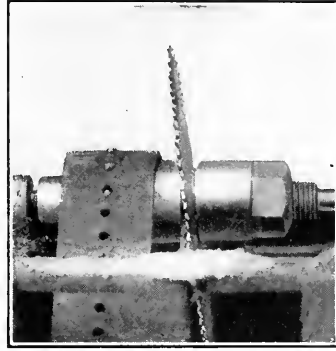


Fig. 253

To cut a rabbet or groove which does not extend to the edge or end of a piece, as in the "styles," or lengthways parts of a frame like that shown in Fig. 214, first adjust the saw to cut the required depth, then clamp blocks



Fig. 254

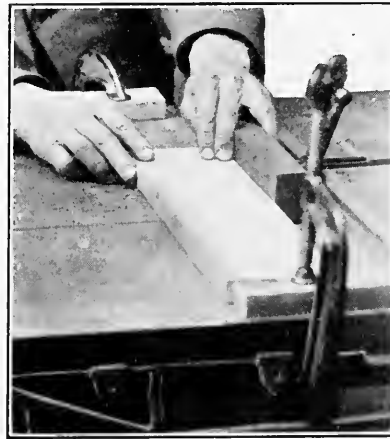


Fig. 255



Fig. 256

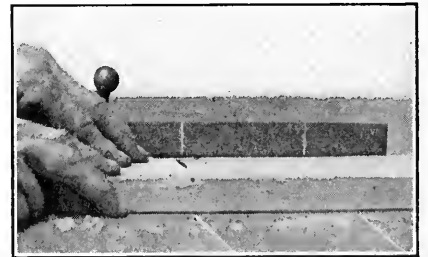
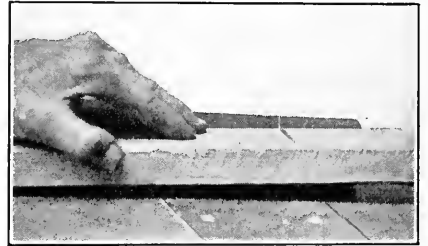
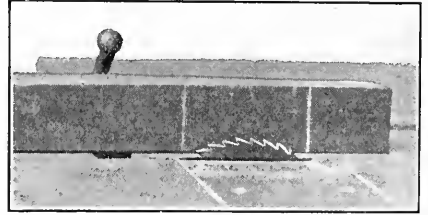


Fig. 257

upon the bench-top so that the wood cannot be pushed further forward or backward than is necessary to make the rabbet of the length required (Fig. 254). Hold the piece firmly, place the end against the nearer block, and carefully lower it upon the saw (Fig. 254), until it lies flat upon the bench-top. Push it along against the gauge until it reaches the further block (Fig. 255).

Then carefully raise the nearer end and remove the piece (Fig. 256).¹ The ends must be trimmed to shape by hand.

¹ Such rabbets can be gauged by marking on the upper surface of the wood opposite the ends of the projected rabbet, and also on the gauge, or on the bench-top, opposite the points where the edge of the saw rises above the bench-top when adjusted to cut the required depth (Fig. 257). Then place the piece so that the further marks agree, lower it upon the saw and push it along until the nearer marks are opposite one another. But it is safer to use a block at each end. Such rabbets can be cut with a moulding-machine, and also on the circular-saw bench with a cutter of the required shape or by wabbling the saw.

Mouldings and other odd-shaped pieces can, if necessary, be "roughed out" or worked approximately to shape with the circular-saw (Fig. 258), the final trimming and smoothing being done by hand. Cutter heads, to substitute for the saw for such work, are made in a great variety of shapes.

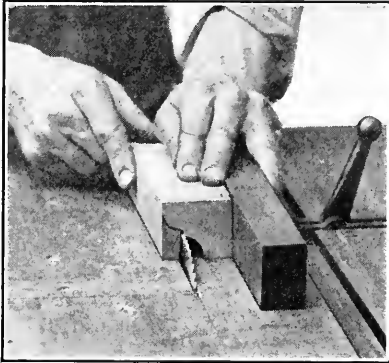


Fig. 258

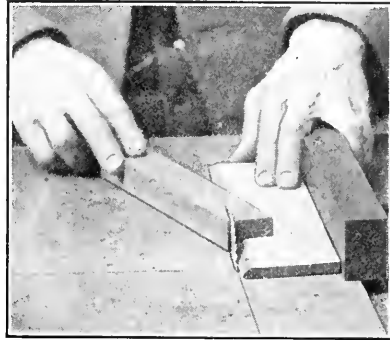


Fig. 259

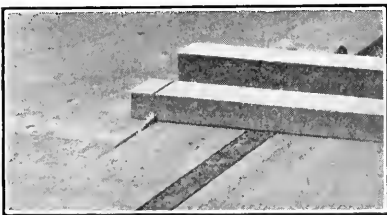


Fig. 260



Fig. 261

To cut a piece tapering, fit it into a notch of corresponding shape cut in the edge of a straight-edged piece, and push both through together (Fig. 259).

To cut a tenon, the process is similar to that in cutting a rabbet. Cut crossways as in Fig. 260, and lengthways as in Fig. 261.

To make joint-edges—for glue-joints—the saw should be fine and in the best condition. The minute roughnesses left by a fine saw assist the glue to hold, and as inconspicuous and strong joints as possible can be quickly made by a competent workman with a suitable

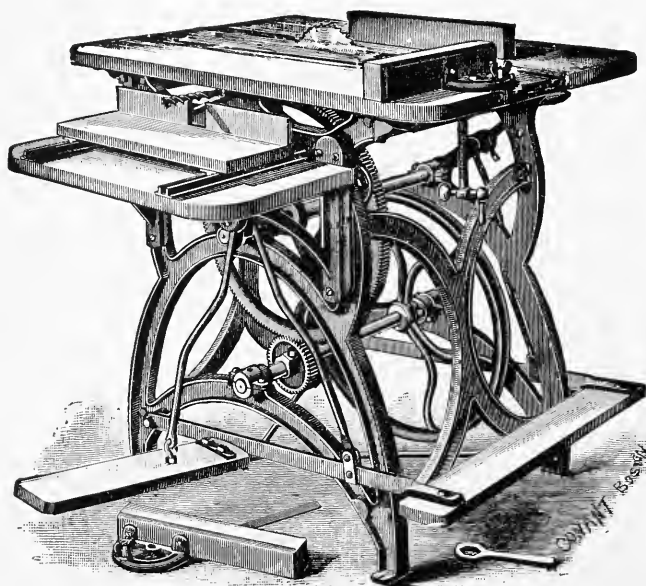


Fig. 262

saw. As the edge used against the gauge must be straight it is well to first joint the other edge with the saw. Then reverse the piece and joint the edge which is to be glued, to remove any slight irregularity left by the plane, reversing the edges more than once if necessary. The saw must be very sharp for this work.

See *Sharpening*, page 136.

Foot- (and *hand-*) *power* machines (Figs. 262 and 263) are very useful when the usual power-driven ones are not available. Such comparatively

inexpensive machines may not do so accurate and varied work, nor do it so quickly, as the most costly power-machines, but they will do good work for ordinary cases, within the limits of their capacity, and are to be recommended when power-machinery is out of the question. It should be borne in mind that no power is gained by foot-power machines—that no greater force can be used than is supplied by the operator. Therefore if thick wood, or hard wood, is used the



Fig. 263



Fig. 264

operator must not expect the work to be easy. The power is simply applied more advantageously than by hand. It is particularly essential that a foot-power saw be kept sharp, for the operator has no great reserve of force to drive a dull saw through the wood. Foot-power machines are safer than the others, because the saw does not run so powerfully, and usually not so continuously, and there is no belting or shafting. It requires more skill to run a thin saw than a thick one. Small power-saws should be run faster than large ones, that is, should make more revolutions in a minute. It is important that saws be run at the correct speed, which can be found by consulting tables for the purpose.

91. Swing-saws are often used for cutting off stock, particularly when many pieces are to

be of equal length. An ordinary cross-cutting circular-saw runs at the lower end of a frame which is usually suspended from the ceiling (Fig. 264), so that the saw can be swung across the bench upon which the wood to be cut is placed. Care must be used to avoid accident.

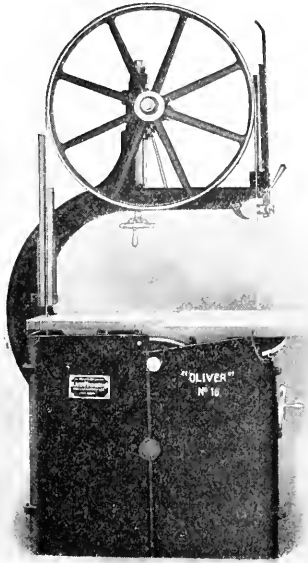


Fig. 265

92. The Band-saw.—As this saw (Fig. 265) cuts continuously while the jig-saw (Fig. 272) cuts only on the down-stroke, the advantage of the band-saw in saving time is obvious. Its motion is also smoother, but it is harder to take care of. The correct degree of tightness for the saw can be told by testing with the hand below the upper wheel, before the saw is started. This cannot be learned from a book, but it must be right. The saw must be fairly tight, but not overstrained. It should be loose enough that when the hand is applied near the guide (Fig. 266) the saw can be freely pulled a lit-

tle way toward the operator. This guide for the saw can be raised or lowered as the work may require. The saw must run evenly and be free from vibration. Do not reach around the saw while it is in motion to adjust anything. The table can be adjustable for sawing at an angle. Splitting-gauges and other attachments are sometimes used. An experienced workman can, if necessary, do a great variety of work with a band-saw, but skilful use of this machine must be learned by experience. The width of saw should be adapted to the work. While large sweeping curves (Fig. 267) can be cut with a wide saw, quick curves (Fig. 268) require a narrow saw to cut them properly.

Do not crowd the wood against the saw, but hold it lightly and easily, simply guiding it (Fig. 269). If the wood closes behind the saw, do not try to get it free by pulling it toward you, for you may pull the saw off the wheel. Stop the machine, open the kerf, and withdraw the wood. Care should be taken not to try to cut curves too sharp for the saw, and also not to turn too abruptly.

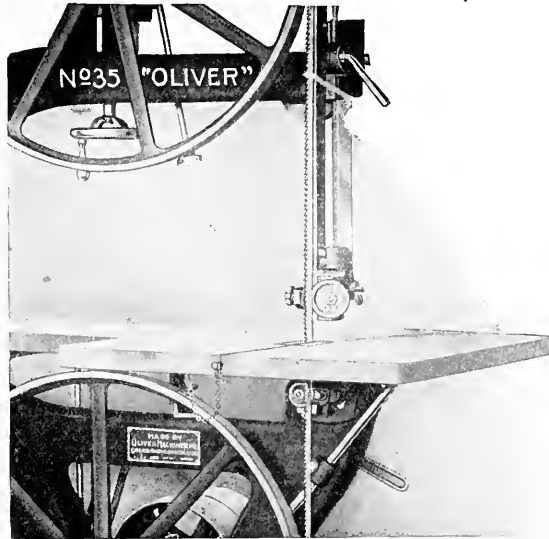


Fig. 266

Where the surface must be left as smooth as possible, saw with the grain of the piece to be kept (Fig. 267).

If necessary to cut a quick curve with a saw too wide for it, cut as nearly to the required curve as free and easy running of the saw will allow,



Fig. 267

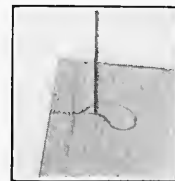


Fig. 268

and then work by short cuts up to the line (Fig. 270); but this is not to be advised and the curve will not be so smooth as when cut with a saw of suitable width.

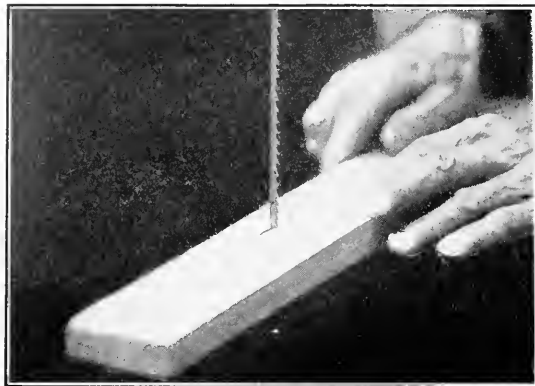


Fig. 269

A good **foot-** and **hand-**power band-saw (Fig. 271) will do excellent work up to the limit of its capacity, where power-machinery is not available. Large band-saws are used for sawing logs, and less wood is wasted than by the circular-saw, as the kerf is narrower.

93. The Jig-saw is now practically superseded by the band-saw except for "inside" or "coring" work. It is, however, simpler, safer, easier to use and to keep in order than the circular-saw or even the band-saw, and is therefore for some reasons the best machine to begin with. The foot-power jig-saw (Fig. 272) is the safest of all for younger pupils. The mechanism of the different jig- or scroll-sawing machines varies, but the principle of a narrow saw-blade running up and down is the same in all. For common work a saw-blade $\frac{1}{4}$ " wide will usually do, but for fine work and quick curves smaller sizes must be used (Figs. 268 and 270). It must be put in with the teeth pointing downward, so as to cut on the down-stroke (Fig. 273). The proper degree of tension for the blade cannot be described. The saw must not be at all slack, but tightly strained,— not however overstrained, or something may break.



Fig. 270

The hands should not be kept very near the saw, as in case of its catching a cut may result. Also, if a saw breaks, the upper end may come down on the hand. The wood should not be forced against the saw, but advanced only as fast as the saw will cut easily and freely, and without being bent in any di-

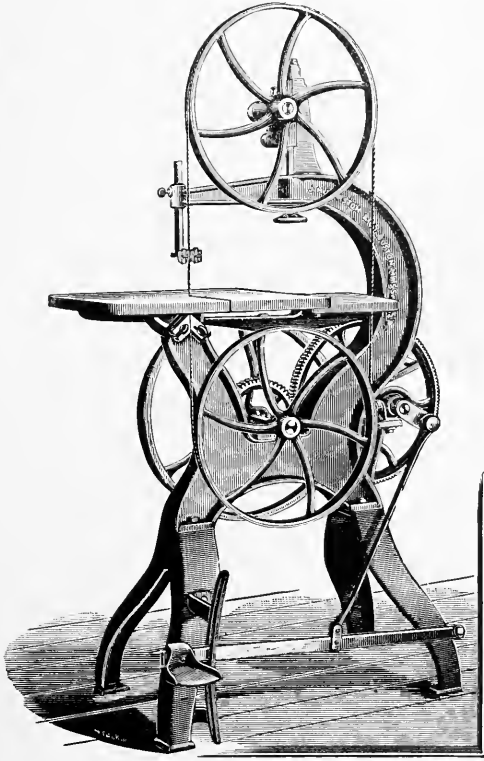


Fig. 271

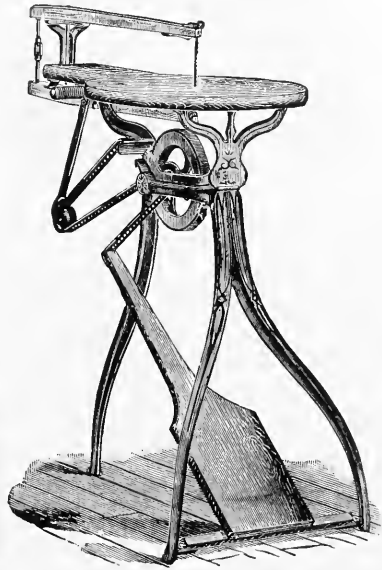


Fig. 272

rection. The wood should not be held down hard on the table, but handled lightly and easily. The general principle of sawing is similar to that with the band-saw (page 102). Care must be taken not to turn the wood too quickly, for it may catch and the saw or the work be injured. See also under *Band-saw*, page 103.

To saw holes—"inside" or "coring" work—a hole must first

be bored to admit the saw (Fig. 273). The table can be adjustable for sawing at an angle.

94. **The Planer** is highly important in saving time, but as stock

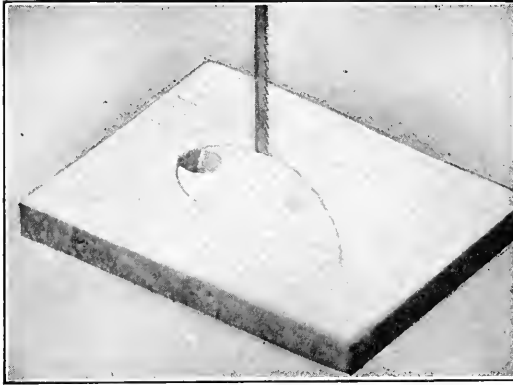


Fig. 273

can be bought already planed and necessary planing can usually be done at a near-by mill for a small sum, the planer can be omitted from a limited outfit much better than the circular-saw or the jointer, although it is an important part of a complete equipment. In the "single surfacer" (Fig. 274) the wood is moved

along over the smooth bed of the machine by means of "feed rolls" with corrugated surface, and passed under a rapidly revolving cylinder to which cutters or knives are bolted (Fig. 275).

These knives plane the surface (Fig. 276). There should be freedom from vibration, the feed must be steady, and the knives must describe a small circle at high speed to ensure the best work. The knives have pieces of steel fitted to them, on a similar principle to the cap of an ordinary hand plane-iron (Fig. 276 and page 36), so closely that chips cannot be forced between them.

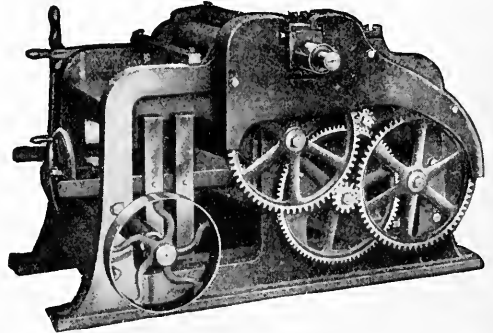


Fig. 274

With a "double surfacer" the upper and lower sides are both planed at once, and machines are made which plane all four surfaces at once.

The thickness of the planing is regulated by raising or lowering the table on which the wood is carried along. If a piece is to be made

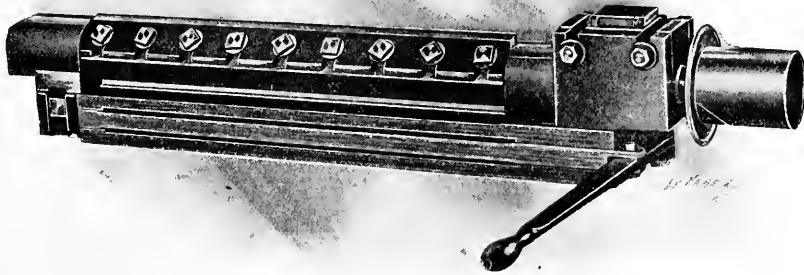


Fig. 275

much thinner, it is passed through the planer several times. To prevent as much as possible subsequent warping, plane equal amounts from each side (see page 209). The common planer makes the surface smooth, but does not true it. If a piece be warped before planing, it will be warped afterwards, although slight irregularities will be removed.¹ Therefore, when accurate work is desired, make one side as true as possible before planing. The knives or cutters (Fig. 276) make the little waves or undulations seen in machine-planed stock (Fig. 277).² These planer-marks must be removed by hand for all nice work.

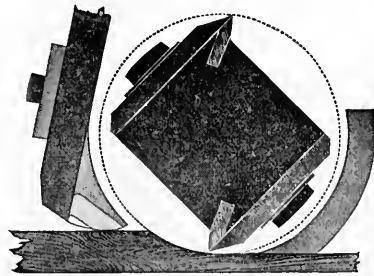


Fig. 276

¹ The old-fashioned Daniels's planer makes the stock true, but as it is slow and the surface is left very slightly rough, it is superseded, except where especial accuracy is required. Figs. 274-276 show a Whitney planer.

² These undulations correspond to the distance between the strokes of the knives.

Planers are made of various sizes. A small or pony planer is good for small work, and is useful as an auxiliary machine. A piece can be planed

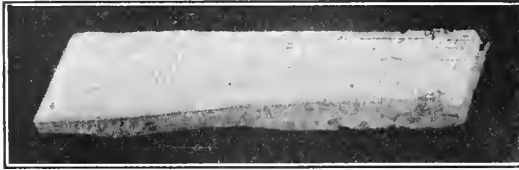


Fig. 277

of tapering thickness by placing it on top of another piece having the required degree of taper, and running both through together. A stick can be made octagonal by placing it in a cradle or form, as in Fig. 453, and running both through together.

95. The Jointer or "Buzz" planer is a very important machine (Fig. 278). It is used for planing edges and narrow stock, and pieces not too large can be trued and squared on it. The wood is held against the gauge and passed over the table by hand so that the revolving cutters (which are similar to those of the large planers) plane the under side of the wood. The knives are more or less exposed, and great care must be used. The jointer is often used to make glue-joints. It must be kept carefully adjusted for accurate work. The gauge is adjustable to plane bevels.¹



Fig. 278

96. Moulding-machines are either horizontal or irregular. The former can be used for such work as getting out matched boards, straight beading

Therefore small diameter, rapid revolution, and steadiness of the cutter-head, with steadiness of feed, and firm holding of the stock, are essential to making this waviness as slight as possible.

¹ It can also be used for chamfering, beveling, rabbeting, tonguing, and grooving, beading, and moulding in various ways, tenoning, etc., by the use of different adjustments and cutters.

or reeding, "sticking" strips of moulding, and the like. The stock is passed through the machine as with a planer.

The *irregular moulder* (Fig. 279) cuts the edge of woodwork in any desired shape for which knives can be fitted. The knives or cutters (of which there is a great variety of patterns) are fastened to the spindles which project above the table and revolve very rapidly. The wood is moved along against the spindle and shaped by the revolving knives. A first-class machine will mould the wood in any direction of the grain and leave the surface so smooth that no further finishing is required. A moulder is not a machine for the novice to experiment with.

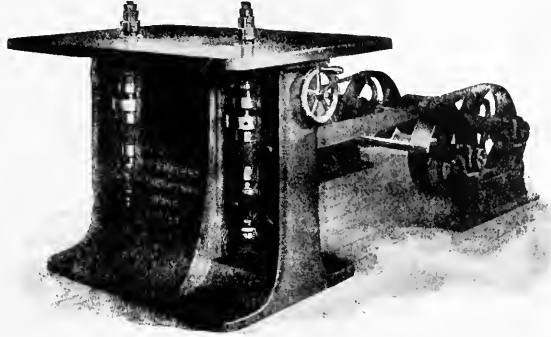


Fig. 279

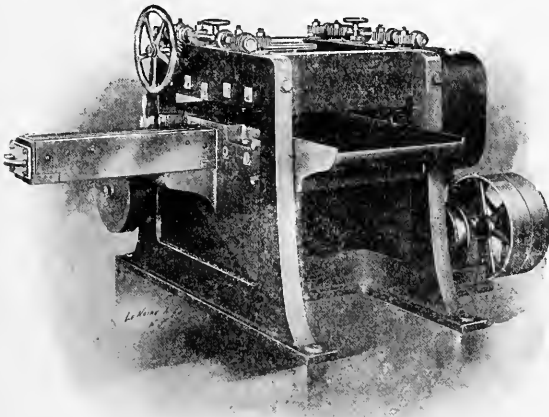


Fig. 280

Whitney scraper after it has been turned by the burnisher, and Fig. 282 a tooting-knife which can be used instead of the scraper.

98. **Boring-machines** are useful where much boring is done. A boring attachment to a circular-saw machine will do in ordinary cases, and there are many independent boring-machines made. Their use is easily learned.

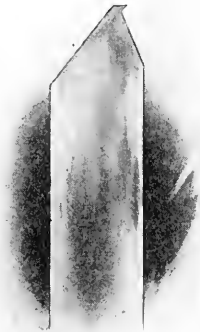


Fig. 281

99. **Mortising-machines** are in common use, and are often driven

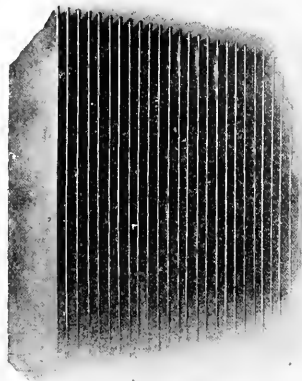


Fig. 282

by foot-power. The principle is similar to that of cutting mortises by hand, but the work can be done more easily and quickly (Fig. 283—Barnes).

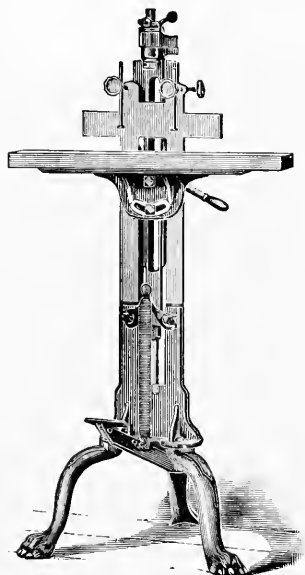


Fig. 283

100. **Tenoning-machines** (Fig. 284—Barnes) also save time and labor. See also page 100.

101. **Sandpapering machines**, through which boards are run as through a planer, give a smooth and even surface (though usually not to be compared with that produced by a scraping-machine) but the grit quickly dulls tools used afterwards. Simple machines, shaped like a drum or a disk covered with sandpaper, against which the wood is held, have long been in use and can easily be contrived—also sanded belts for rounded surfaces.

102. **The Lathe.**—Most woodworking machines are of recent invention, but the lathe in its primitive forms dates from antiquity. Woodturning is a trade in

itself, and is much better learned from experienced turner than from a book. All however, understand the general and the elementary operations, which included in a general handbook. Turning requires concentrated attention and freedom from interruption, both on account of the work and to avoid accident. Different turners frequently have different ways of doing work and there is much opportunity for thought in so handling the tools as to do the cleanest and best work in the least time. Therefore carefully observe the effect of holding the cutting edges in different positions so as to learn to do as much clean cutting, and as little scraping, as possible.

a practical and experienced woodworkers should, principles of turning are all that can be

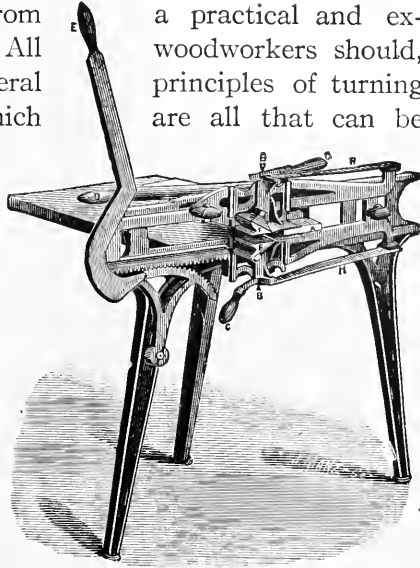


Fig. 284



Fig. 285

Handle the tools lightly and freely. Do not press hard and long at any one spot, on account of the friction.

For the common forms of turning, the wood is held between two points or centres, and is rapidly revolved toward the turner, who holds the edge of a tool against it, and thus cuts it into the desired shape. Fig. 285 will serve as a typical illustration of a lathe, for, though the details of different machines may vary, the general principle is the same in all.

One of the centres (the left in Fig. 286) between which the stick is held, has spurs which enter the wood (Fig. 287), so that when

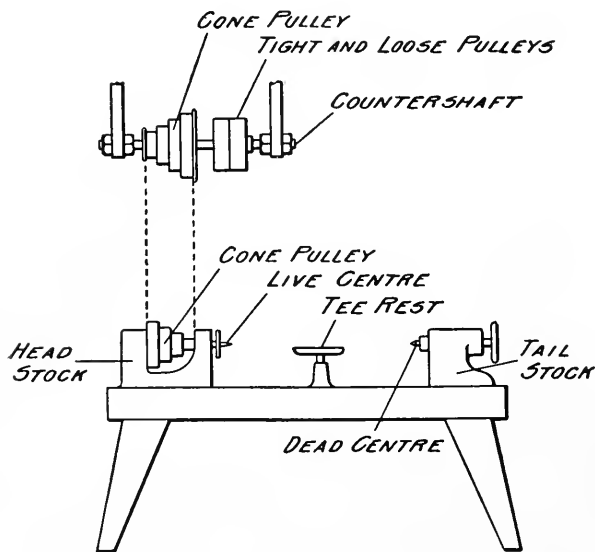


Fig. 286

this centre is revolved the wood is also revolved. This is sometimes called the "live" centre. The other centre (Fig. 288) is merely to hold the other end of the wood in place and does not turn with it. This is sometimes called the "dead" centre. A movable tee-rest for the tool is fastened in front of the wood, so that the tool may be held securely and steadily (Fig. 286).

Clear pine is the best wood to begin with, though whitewood or other similar wood will do. Select pieces free from cracks, checks, or shakes, which might cause the wood to split while being turned.



Fig. 287



Fig. 289



Fig. 288

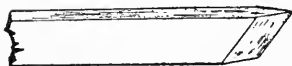


Fig. 290



Fig. 291

When the belt is on the smallest step of the cone-pulley (Fig. 286) of

the lathe it will be on the largest step of the driving-pulley on the countershaft above. This gives the highest speed, for when a belt runs from a large wheel to a smaller the speed is increased in proportion to the sizes of the wheels. For the slowest speed put the belt on the smallest step of the countershaft pulley and the largest of the lathe pulley, for the speed is decreased when a small wheel is connected with a larger one. Small work requires a higher speed than large.

To turn a cylinder. The tools needed are the turning gouge and the turning chisel. The gouge is usually ground with the edge rounded to correspond with the degree of curvature of the tool (Fig. 289). For roughing out, however, it is sometimes ground squarely across. The chisel is ground on both sides (Fig. 290) and is usually a skew-chisel also (Fig. 291). Experienced turners, however, are apt to grind with very little skew or squarely across.

First, get out a piece of wood with the circular-saw about 2"x2"x10".¹ Find the centre of each end of the stick by drawing diagonals or by one of the other methods given on page 229. Put a few drops of oil on the end of the piece where the dead centre will be inserted. Move the tail-stock (Fig 286) up toward the head-stock until the wood is held between the two, centring it by the marks just made upon the ends.² Screw up the tail-stock until the spurs of the live centre are firmly fixed in the wood and the dead centre also forced well into the end. The wood must revolve freely and at the same time be securely held. Adjust the top of the tee-rest to be about level with the centres (Fig. 285).³ Fasten it as close to the wood as you can without danger of striking, before starting the lathe. Do not change it while the lathe is moving.

¹ The exact size is immaterial,—1 $\frac{3}{4}$ " square will do—but for the following elementary exercises this is a suitable size and can be economically cut from a 2" plank.

² The experienced turner centres small work by eye, gives the wood a few revolutions and, if necessary, makes a slight cut with a tool to detect any inaccuracy in the centring. By stopping the lathe and by tapping or a slight movement of the piece he adjusts it to run true. If the wood becomes overheated at any time, stop the lathe and oil again or loosen the wood slightly. Do not oil while the lathe is in motion.

³ The rest can be a little below the centres for small work, but for large work should be somewhat above the centres.

Start the machine slowly.¹ First rough out the work with the gouge held as in Fig. 292. The left hand can be held as shown, or



Fig. 292

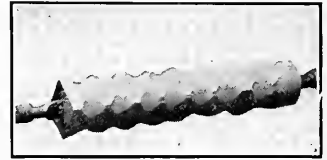


Fig. 293

underneath as in Fig. 296, and should bear firmly on the rest as well as hold the tool. Begin with the edge of the tool so placed that it



Fig. 294

would cut at a tangent (see page 116) to the upper part of the cylinder, as in Fig. 292. Then carefully raise the handle until the edge begins to cut. After dipping down into the wood in this way move the tool along a little and dip down again, making a succession of cuts as in Fig. 293. If the cuts are made nearer together the bulk of the corners will be roughed off. Then begin at the right-hand end and



Fig. 295

move the tool sideways back and forth along the stick until it becomes cylindrical. In smoothing with the gouge place the tool at first so that the back and not the cutting-edge bears on the wood and then carefully raise the right hand a very little until the edge begins to cut. The tool can be turned over slightly so as to cut with either side of the edge (Fig. 294) rather than with the extreme end, thus making a

¹ The highest speed is usually right for these small elementary exercises.

smooth shearing cut (see page 31). Test the diameter with calipers, holding them lightly as in Fig. 295. Leave the piece a little larger than required to allow for finishing with the chisel.

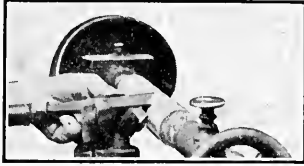


Fig. 296

Place the chisel as in Fig. 296, holding it on the rest with the left hand, so that the basil rests on the wood. The left hand is sometimes laid over the chisel in the position shown in Fig. 294. Then raise the handle



Fig. 297

slowly a very little until the edge begins to cut and move the tool steadily to the right, making a smooth shearing cut. Keep the basil bearing on the wood. It is well to keep the forefinger of the left hand hooked under the tee-rest, as this gives firm control of the tool (Fig. 297). Keep the upper point of the chisel clear above the wood. It is well to begin a little way from the end of the piece lest the edge of the tool catch. The tool can now be turned the other way and the cutting done in the opposite direction. As you thus trim to the exact diameter, test with calipers (Fig. 295). The hand is often held around the piece as in Fig. 298.¹ After moving the "shipper" or lever to stop the machine, lay the hand on the pulley to bring it to a standstill, not on the wood.



Fig. 298

Fig. 299 is turned in a similar manner. Rough to shape as already shown. Finish with the skew-chisel, working from the middle toward each end.



Fig. 299

To cut a cylinder with one or more steps. First turn a cylinder. Near the middle lay off a space, 2" for example, with rule and pencil

¹ With long slender work a piece of leather wrapped around the hand will prevent burning and the tool can be held against a nick cut in the leather. A back-rest for the work to bear against is used for work which will spring much.

(Fig. 300). Hold the chisel (skew or square-edged) as in Fig. 310, with the angle nearly touching the wood, raise the handle slightly and carefully so that the corner of the tool will dip down into the wood (Fig. 301) at each end of the 2" space and cut a groove about $\frac{1}{16}$ " deep. As there is but little wood to be removed it can be done with the chisel (Fig. 302). In cutting with the angle of the chisel next the shoulder, lower the handle slightly lest the tool cut too deeply.

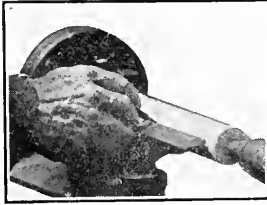


Fig. 300

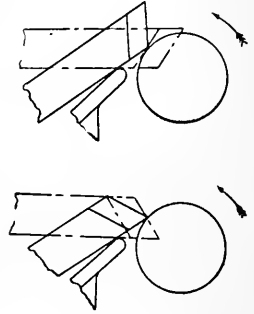


Fig. 301

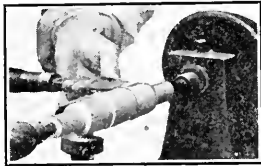


Fig. 302

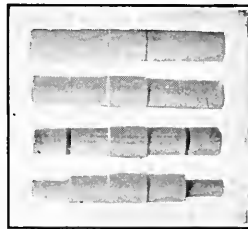


Fig. 303

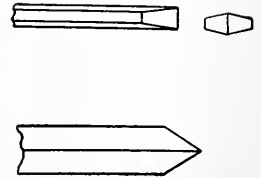


Fig. 304

Next mark off spaces, as before (Fig. 303), of $1\frac{1}{2}$ " for example, and cut down just outside the lines with the parting tool (Fig. 304) held



Fig. 305



Fig. 306



Fig. 307

as in Fig. 305, to a depth of $\frac{1}{4}$ ". Or cut a V-shaped groove with the chisel, first cutting straight down as in Fig. 306, and then slantingly as in Fig. 307. Turn to the required dimensions as before, first with the gouge, turning it when near the shoulder so that it will cut as in Fig. 308. Finish with the chisel as before. See that the ends of the shoulders are smoothed accurately to the lines with the chisel as in Fig. 306. It is well to practise with a variety of similar steps.



Fig. 308

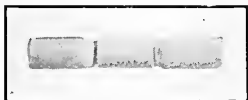


Fig. 309



Fig. 310

The exact dimensions are not important, as the object of such exercises is to get a good working understanding of the process.

To cut a half-bead (Fig. 309). After turning a cylinder, cut in with the chisel as in Fig. 310, and then, placing the tool as in Fig. 311 (Fig. 302 shows the angle at which to hold it more clearly), turn it to cut the half-bead, raising the handle gradually in a curve and pushing the tool forward as is necessary (Fig. 312). Remember to let the



Fig. 311



Fig. 312



Fig. 313

basil bear on the wood as a guide. At the end try to cut one shaving from the whole surface. To cut a half-bead in the opposite direction, reverse the positions and movements. This exercise can well be repeated with half-beads of different sizes.

To turn beads (Fig. 313). Lay out the spaces for the beads on a cylinder with compasses (Fig. 314), or with rule and chisel, making

a very slight cut.¹ Pencil marks can also be made for the centres of the beads. Cut down between the beads with the chisel as in Fig.

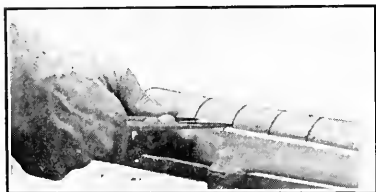


Fig. 314



Fig. 315

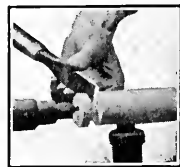


Fig. 316

310. Then proceed as in turning two half-beads. Practise with beads of different sizes and also try to make a row of uniform size.

To cut off a cylinder or other shape at a given length. Lay off



Fig. 317



Fig. 318



Fig. 319

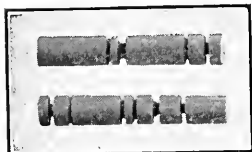


Fig. 320

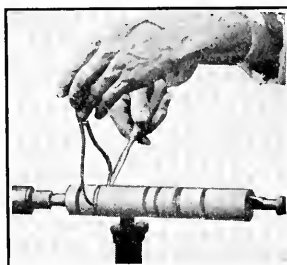


Fig. 321



Fig. 322

¹ Where many pieces have to be marked alike, a gauge can be made by driving brads in the edge of a strip of wood at the required points and sharpening the projecting ends. Holding this gauge lightly against the revolving wood will mark the spaces.

the required length with rule and pencil, leaving a little space at each end, enough at the live end that the tools cannot strike the spur when cutting in. Cut in carefully with the parting tool a little outside of the line marked or hold a $\frac{1}{4}$ "

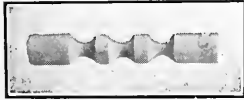


Fig. 323

scraping tool as in Fig. 305, with the basil down. Make successive cuts lightly to make the opening cut a little wider than the tool to avoid friction

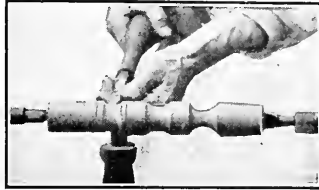


Fig. 324

and continue until there is only enough wood left to avoid danger of breaking (Fig. 315). Or cut entirely with the turning chisel, first straight down (Fig. 316) and then slantingly (Fig. 317), thus making a V-shaped cut and trimming thin shavings from the end of the part to be kept until the line is reached and the piece almost cut through.

To turn a tool handle, as in Fig. 318. First turn a cylinder roughly. After marking spaces, cut in or "size" down with the parting tool or chisel (the sizing tool, Fig. 319, is sometimes used for repeated sizings) where the dimensions are naturally measured (Fig. 320). Use the calipers as in Fig. 321, with one end close to the cutting tool.



Fig. 325

When the calipers indicate the correct diameter stop cutting. Do the rest of the turning with gouge and chisel as already described. Finally hold a small piece of folded sandpaper with the forefinger and middle finger and move it rapidly back and forth over the surface (Fig. 322).

To cut concave curves or hollows (Fig. 323). Turn a cylinder and mark the spaces, hold a small gouge horizontally and at right angles to the work (Fig. 324) and remove part of the wood, but keep well within the lines. Then hold the tool as in Fig. 325, with the basil bearing on the wood, and push it care-

fully forward and upward, at the same time rolling it partly around and moving the handle toward the right or left as the cutting proceeds, so that the gouge will work itself up out of the wood.

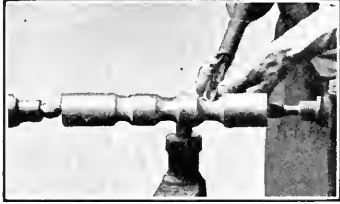


Fig. 326

At the end of the cut the tool should be in the position shown in Fig. 326. Next cut on the other side of the hollow in the same way, and continue cutting first on one side and then the other until the curve is correct. By keeping the basil of the tool bearing on the wood as a guide a slight movement of the handle will cause the edge to cut all that is required, and the

tool can be controlled so as to cut cleanly and without catching. Practise with hollows of different dimensions and try to make a series of uniform size and shape.

To turn a combination of hollows and rounds, as in upper part of Fig. 327, cut the hollows first, as in the lower part of Fig. 327, and then the convex curves or beads. The sides of the hollows must be cut down straight for some distance to allow for the rounding of the beads. Round the beads with gouge or chisel. The chisel will give a finer surface but the gouge will cut quicker. The experienced turner will cut both rounds and hollows smoothly with the gouge.



Fig. 327

Simple forms, of various degrees of curvature and in an endless variety of combinations, are the elements of which the outlines of most turned objects are made up.

To mark spaces where there are square members, or parts, as in Fig. 328, do this before setting the lathe in motion, squaring distinct pencil lines across one side of the piece (Fig. 329). Cut a groove at the ends of the square members (Fig. 330) or make deep V-shaped cuts with the chisel as already shown. Then round the corners of the square members as in Fig. 328, and proceed for this design as in Fig. 328.

Sandpaper should not be used in the earlier exercises, as the pupil should learn to cut rather than scour the wood into shape. For

ordinary work cut a small piece of sandpaper, double it and hold as in Fig. 322. Move it quickly back and forth to prevent scratching the work. In sandpapering sharp curves or beads care must be taken not to injure the shape (Fig. 331). The surface can be further smoothed or polished with a handful of fine shavings and dust made by the turning.

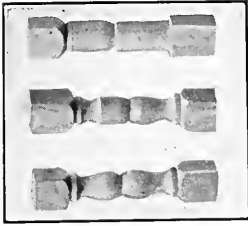


Fig. 328

For many shapes, rosettes and cups for example, the wood must be fastened to the live spindle only. Small pieces can be screwed (by turning the lathe) to the centre screw of the face plate (Fig. 332), which is substituted for the spur centre used in the previous exercises. For large pieces screws are inserted through holes in the face-plate. The tee-rest can be placed at right angles to the position already shown or at any angle required. Because of the varying angles at which the grain of the wood meets the edge of the tool in such work,



Fig. 329



Fig. 330

For many shapes, rosettes and cups for example, the wood must be fastened to the live spindle only. Small pieces can be screwed (by turning the lathe) to the centre screw of the face plate (Fig. 332), which is substituted for the spur centre used in the previous exercises. For large pieces screws are inserted through holes in the face-plate. The tee-rest can be placed at right angles to the position already shown or at any angle required. Because of the varying angles at which the grain of the wood meets the edge of the tool in such work,



Fig. 331

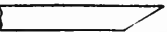
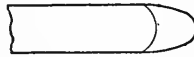
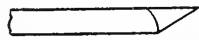
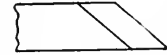
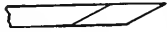
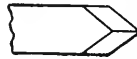
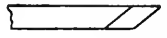


Fig. 332

to the centre screw of the face plate (Fig. 332), which is substituted for the spur centre used in the previous exercises. For large pieces screws are inserted through holes in the face-plate. The tee-rest can be placed at right angles to the position already shown or at any angle required. Because of the varying angles at which the grain of the wood meets the edge of the tool in such work,



Fig. 333

it is common to instruct that such turning be done with what are

called "scraping tools" (Fig. 333), which are of various shapes and have the basil on one side only. They are held horizontally on the rest with the basil down. The skilful, experienced turner, however, does the greater part of his turning with the regular tools al-

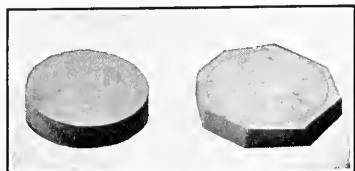


Fig. 334



Fig. 335

ready mentioned and on the same general principles of cutting that have already been described, and uses the scraping tools only when necessary. The beginner should learn to do his work as much by clean cutting and as little by scraping as possible. There are, however, some operations which can be done by scraping only.

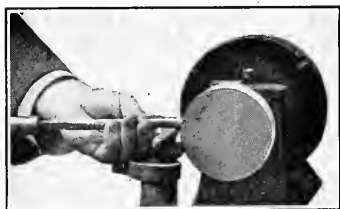


Fig. 336



Fig. 337

To turn a disk. Cut off the corners with a hand-saw or saw approximately to shape with the band-saw (Fig. 334). Screw to the screw chuck and mark with compasses. Place the tee-rest as in Fig. 335. Cut the edge with parting tool as in Fig. 335. It is common to put a piece of waste wood between the face-plate and the work, to cut

against. The edge can be finished, or cut entirely, with gouge and scraping chisel held in the position shown in Fig. 336. Turn the face



Fig. 338



Fig. 339

with gouge and scraping chisel, or scraping chisel alone, as in Fig. 337. Work entirely between the centre and the edge nearest you,—never beyond the centre, for the further half of the wood is moving in the wrong direction. Test the straightness of the surface by eye and with straight-edge.



Fig. 340

To turn shapes similar to that shown in Fig. 341, first turn a disk, then the centre with gouge and chisel, afterwards holding and turning the gouge as in Figs. 338 and 339, to remove, as at *A* in Fig.

340, a part of the large saucer-like depression. Keep the basil bearing on the wood. Next hold the gouge as in Fig. 341, and turn the tool so as to make a shearing cut at the edge, and also complete rounding



Fig. 341

ing the edge, working from the face-side. Then start the gouge as in Fig. 342 (*B* in Fig. 340), with the basil bearing on the wood, and move the tool forward, and at the same time roll or turn it in the positions

shown in Figs. 343, 344, and 345, so that the edge works itself up and out of the wood. The surplus wood (*C* in Fig. 340) can be removed and the surface finally smoothed by repeating the operations just de-



Fig. 342

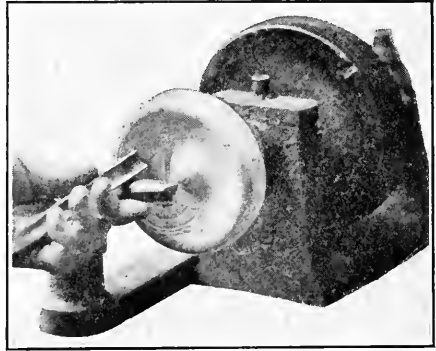


Fig. 343

scribed. This is the scientific way to turn such surfaces, by clean cutting rather than to scrape them into shape with scraping tools. Such opera-

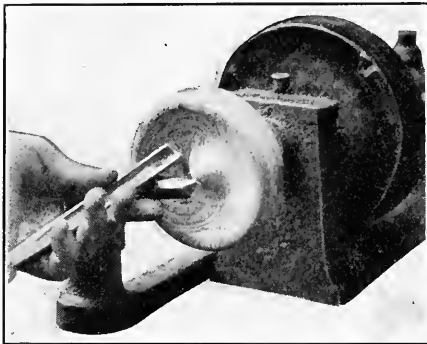


Fig. 344

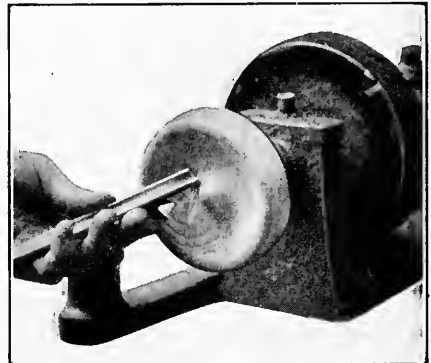


Fig. 345

tions are hard to describe, but bear in mind to keep the basil of the tool bearing on the wood as a guide during the whole operation and to

so hold and turn the tool as to cut with the grain, so far as possible. To cut a curve like that in Fig. 91 with a spokeshave, you would cut as shown by the arrows. Try to follow the same principle in turning.



Fig. 346



Fig. 347

In the same way the disk in Fig. 336 can be turned into a rosette (Fig. 346).

Some kinds of work have to be held in a chuck. For example, after turning the upper side of the candlestick base shown in Fig. 347, screw a piece of wood to the face-plate and turn a recess in it (Fig. 348) of the right size to tightly hold the turned base (Fig. 349). The depression in the bottom of the latter can now be turned.

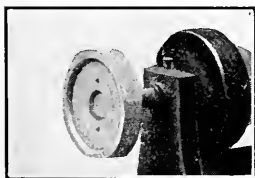


Fig. 348



Fig. 349

A templet, or pattern, is sometimes used to secure accuracy in turning some shapes. It is merely an exact reverse outline of the required form cut in sheet metal or thin wood and applied to the work to test it. Stop the lathe before applying the templet. It is best to learn to turn by eye as far as possible and to resort to such tests only when necessary.

The general principle of finishing turning is the same as with other work. See *Finishing*, page 188. The wood can be filled, if required, and the filler cleaned off with shavings. A common way to polish is with a

pad. Put a little oil on a cloth, pour on shellac and make a pad to hold against the work. Shellac can also be applied with a brush, revolving the work by hand, and afterwards rubbing down in the usual way.

Lathes are also adapted for screw-cutting, and have various tool-holding and self-feeding attachments—also knife attachments by which patterns can be turned automatically at great speed, and appliances for turning a great variety of odd shapes, as twisted or “rope” patterns,—but such matters belong to advanced work and manufacturing purposes rather than to the elementary principles of hand-turning.

103. Placing of machines.—All machines which require careful adjustment should be set up so that the light will fall properly upon the machines and the work. It is important that the circular-saw be so placed that the operator, when working, will face a window or a clear light, for the light should fall upon the work from the back of the saw. The lathe is usually placed before a window. All lines of shafting and all machinery should be set up exactly level and all connecting pulleys exactly in line. Machines should be firmly bolted to a firm foundation and be free from vibration.

104. A Countershaft is used so that a machine may be started or stopped without affecting the running of the main shaft, and is belted directly to the machine and also to the main shaft. The latter belt runs on either of two pulleys, side by side, on the countershaft—one tight, the other loose (Fig. 286). When the belt is shifted to the tight pulley the countershaft is turned and the machine set in motion. When the belt is on the loose pulley the countershaft and machine stop, while the loose pulley continues to revolve. The belt is shifted from one pulley to the other by one or more levers. Loose pulleys are apt to give trouble and must not be neglected.

105. Motors connected directly with each machine have some obvious advantages, as dispensing with the care, danger, and expense of shafting and belting, and also avoiding the need of running main shafting when only part of the machinery is in use.

106. Pulleys and Belts.—It is better to have large pulleys than small, but the relative sizes must be regulated by the speed required.

To find the speed of a pulley to be driven by another pulley, multiply the diameter of the driving pulley by the number of its revolutions and divide by the diameter of the pulley to be driven.

To find the necessary diameter of a driving pulley to give a required number of revolutions to a driven pulley of given diameter, multiply the diameter of the pulley to be driven by the required number of revolutions and divide by the number of revolutions of the driving pulley or the driving shaft.

To find the necessary diameter of a driven pulley in order that it may revolve at a required speed, multiply the diameter of the driving pulley by its number of revolutions, and divide by the required number of revolutions of the driven pulley:

To make a machine run in the opposite direction from the shaft, which is sometimes necessary, the belt must be crossed between the pulleys.

Belts are of leather or rubber. The hair side of a leather belt, being the weaker side, should be in contact with the pulley. There are various metallic fasteners for belts, which are easily applied,—also lacing of wire. The ends can also be shaved tapering, to lap over one another, and glued or riveted.

There are various ways of using the rawhide belt-lacing. A common way is shown in Fig. 350. Before lacing, cut the ends of the belt squarely across, using the try square. Punch holes with a belt punch. All crossing of lacings, whether leather or wire, must be on the outside. The lacing on the inside which comes against the pulley must run lengthways of the belt, as it would soon wear through if crossed. There are two thicknesses on the inside. To fasten the ends cut a little nick in the edge of the lacing at such a point that, when pulled through an extra hole made for the purpose with a knife, the nick will catch and keep the end in place (Fig. 351).

A speed of three thousand feet a minute is as fast as a belt should run in ordinary cases. For small pulleys and narrow belts 15 feet between shafting is a good distance, but for larger pulleys and belts a greater distance is better, although it is common practice to use much shorter belts.

To find the length of a belt, add the diameters of the pulleys, divide by two, multiply by 3.1416 and add twice the distance between the centres of the shafts.

To find the width of belt for a given horse-power, multiply the horse-

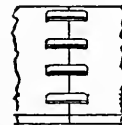
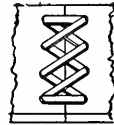


Fig. 350

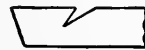


Fig. 351

power by one thousand, and divide by the speed of belt in feet a minute, the result being the required width in inches.

To slip on a belt, do so in the direction of the motion.

107. Oiling.—With the old-fashioned boxes where there is simply an oil hole, oil every morning before beginning work. Much machinery is now provided with devices of various kinds, which make it necessary to oil at long intervals only. These save much trouble and greasiness, although open to the objection that as the oiling is not a matter of daily routine it may be neglected until after the bearings have become dry.



Fig. 352

would injure the temper of the steel. Besides, the water carries off the waste particles of stone and steel, which would glaze the stone. To grind, stand on the side toward which the top of the stone turns.¹

To grind a *Chisel*, or *Plane-iron*, grasp the handle of the chisel or the upper end of the plane-iron, with the right hand, and hold the

¹ This is the proper way, but quite often the beginner can get a better result with the stone turning the other way, or from him, as it is easier to hold the tool without the edge catching. It is, however, usually harder to grind evenly in this way and the edge is usually not as good.

108. Sharpening Tools.—

The general process with chisels, plane-irons, knives, and the like, is to grind them on the grindstone, or the emery-wheel—the former is better for the beginner,—and smooth the coarse edge left by the grindstone by rubbing on a fine stone with oil or water, and sometimes finally stropping on leather. Saws are sharpened by filing. The grindstone must be kept wet, for the heat from the friction of the tool on the dry stone

blade in the left hand with the fingers uppermost and near the cutting-edge (Fig. 352) or lay the palm of the left hand across the blade. Lay the tool with the beveled side down quite flatly on the stone, and then raise the handle until the bevel touches the stone (Fig. 353). Keep



Fig. 353

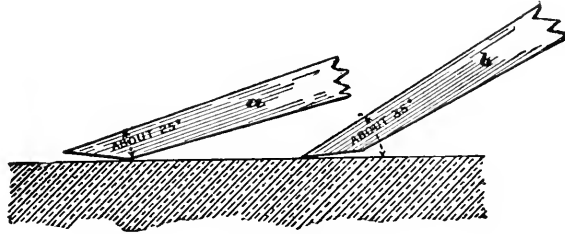


Fig. 354

the arms rigid near the body and hold the tool firmly against the stone. Move the tool slowly sideways, back and forth, across the stone, which helps to keep the edge straight and prevents the stone being worn away too much in one place. Control the grinding by the pressure of the fingers, or the palm, of the left hand, on top of the tool. Try to grind squarely across the blade, testing wide chisels and plane-irons with the try square.

The usual angle for the bevel of such tools as the chisel is about 25° (*a*, in Fig. 354), but for very hard wood and rough work the angle should be slightly greater, lest the edge become broken, while for very soft wood and delicate work a smaller angle may be used. Do all grinding on the basil. Never apply the flat side of the tool to the grindstone. The tool should be held at the same angle all the time or the basil will be rounded.¹ Wipe the tool dry immediately after grinding.

Any slight burr, or turning over of the edge, on the flat side ("wire-edge" or "feather-edge") should be taken off on the oilstone.

¹ Appliances can be bought (or easily contrived) to ensure the correct angle being kept, but it is better to learn to grind without such mechanical help.



Fig. 355



Fig. 356

This wire-edge can be detected by passing the thumb lightly over the edge (Fig. 355).

In rubbing the edge upon the oilstone (Fig. 356), do not attempt to smooth the whole bevel made by the grindstone, but lay the tool lightly on the

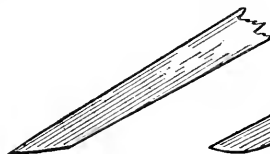


Fig. 357

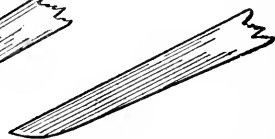


Fig. 358

stone as in Fig. 354, *a*, and lift the handle until the upper part of the

bevel is very slightly raised—barely enough to clear the stone (*b*, in Fig. 354),—the action of the oil will show when it has been raised enough,—and then rub the tool back and forth very steadily, which should make a small second bevel at the edge (Fig. 357). If the edge be rounded (Fig. 358), it will lack the proper keenness. The angle for the oilstone grinding is usually about 10° greater than that of the long

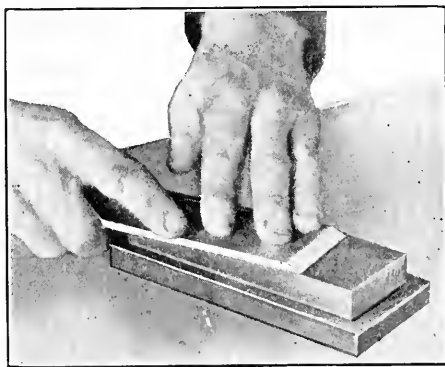


Fig. 359

bevel made on the grindstone or 35° (Fig. 354).¹

¹ Although the angles should be varied slightly according to the hardness of the wood and the kind of work, where there are only a few tools to be used for all purposes it is not practicable to vary the angles much unless there is considerable work of the same kind to be done. Experience will teach the best angles for different kinds of work. An edge suitable for delicate work in white pine would be injured quickly if used upon *lignum-vitæ*.

Any wire-edge on the flat side can be removed by drawing the flat side over the stone once (Fig. 359), toward you or sideways, but do not raise the handle at all, as any bevel on the flat side will spoil the edge. It can also be drawn flatways across the ball of the thumb. As you remove the wire-edge, feel on the bevelled side of the edge also. A slight wire-edge can often be removed by drawing the edge of the tool sideways across a piece of soft pine wood. After sharpening several times on the oilstone the bevel will become so wide that it is a waste of time to rub it down. The tool should then be reground and a new bevel made on the oil stone.

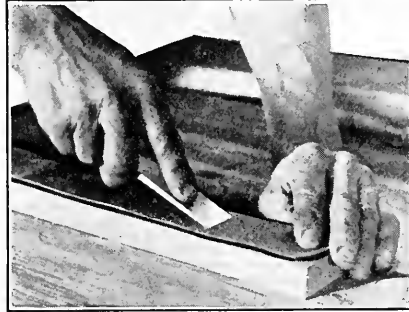


Fig. 360

To tell when the edge is in proper condition, hold it toward the light. If the edge, or any part of it, can be seen as a bright line the tool is dull. A keen edge cannot be seen by the naked eye. Test for sharpness with the thumb (Fig. 355). The lightest touch of thumb or finger will detect any lack of keenness. Test by cutting across the grain of a piece of soft pine. If the cut be clean and smooth, the tool is sharp.¹

The edge left by the oilstone can often be improved for fine work by stropping. Draw the tool back over the strop, away from the edge (Fig. 360). Raise it from the strop on the forward stroke.

Pane-irons can sometimes be ground to a more acute angle than chisels, although the jack-plane, if used for rough work, may need more strength at the edge.

Gouges.—The tool must be continually turned or rolled to make

¹ The fibrous structure of soft wood, being more yielding than that of hard wood, offers less resistance to the tool, and therefore requires a keener edge to cut it cleanly without tearing or crushing the wood. The firmer structure of hard wood can be cut by an edge which would merely tear the soft wood.

the grinding uniform. It can be held at right angles with the oilstone, and rolled as in Figs. 361 and 362. For "inside" gouges,

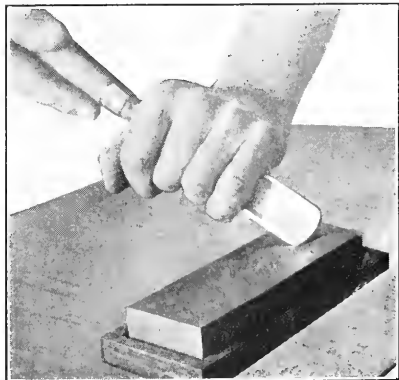


Fig. 361

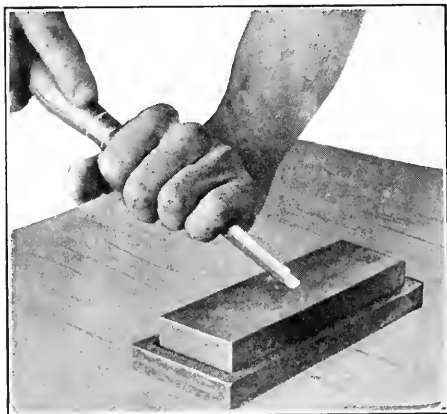


Fig. 362

rounded pieces of stone, called "slips" are used (Fig. 363). The slip need not fit the gouge exactly, but should have a curve a little quicker or sharper than that of the tool. The common "outside" gouges are not rubbed on the inside, except the merest touch to remove any wire-edge or burr, but the slip can be used on the outside (Fig. 364). It is well to have a separate stone for the outside bevel of gouges, for the rounded edges are apt to wear the stone unevenly.

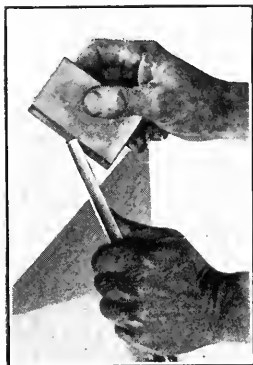


Fig. 363

The Knife.—To grind the point, it can be moved back and forth lengthways with a curving motion, while resting flat on the grindstone, and to grind the straight part of the blade, let it bear a little harder near the edge of the stone than elsewhere, as it is passed back and forth.

In rubbing the knife on the oilstone give it a circular motion rather

than simply back and forth, particularly for the point. The straight part can be allowed to bear a little more heavily near the edge of the stone as it is passed back and forth.



Fig. 364



Fig. 365

The *Drawknife* is ground in the way already described, and is rubbed with a flat slip in the same way as the gouge (Fig. 364) resting the tool on the bench.

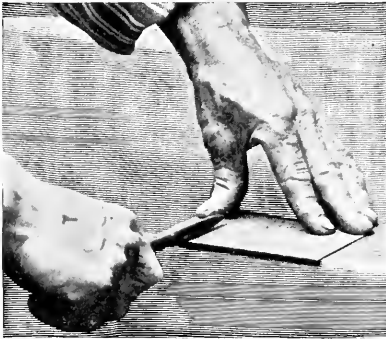


Fig. 366

To sharpen a *Scraper* requires a burnisher, which is simply a piece of hard, smooth steel of triangular or curved section.¹ First grind the two long edges of the scraper squarely across on the grindstone, or file them (using the file lengthways). Slightly round each corner to prevent scratching the wood. Then hold the file as in Fig. 365 and draw it along the edge of the scraper, keeping it at right

¹ If necessary, a burnisher can be made from an old three-cornered file, such as is used for filing saws, by grinding off the teeth and slightly rounding the angles on the grindstone until the tool is smooth.

angles to the edge. If there is a burr at the edge, rub the scraper lightly on the oilstone, first flat on its side and then on edge at right angles to the stone. When both of the long edges are square and

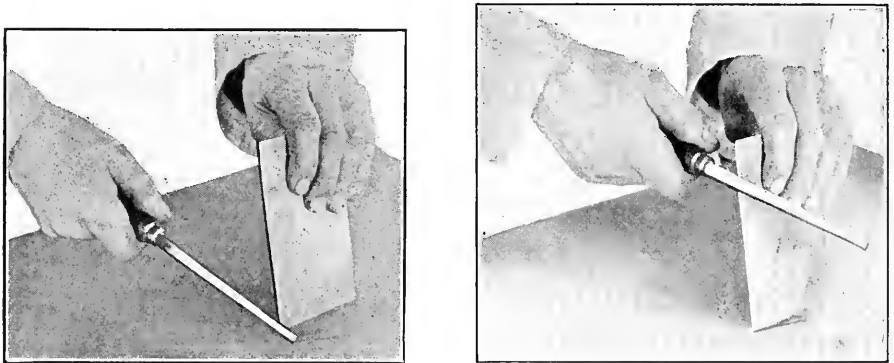


Fig. 367

smooth, lay the scraper flat on its side near the edge of the bench and rub the burnisher back and forth a few times as in Fig. 366, which is almost flat on the scraper. This bends a little of the steel over the edge. Do the same on each side of the long edges, making four edges thus curled over. Next, hold the scraper as in Fig. 367, and draw the burnisher with a firm, even stroke, once or twice, lengthways of the edge, as shown. The scraper can be laid



Fig. 368

flat on the bench, if preferred, slightly projecting over the edge. The burnisher should be drawn with a slightly end-to-end motion, as shown, which helps turn the edge. The fine edge (Fig. 368) thus turned over will take off shavings. All four edges can be treated in the same way. After one edge gets dull, use another. When all four are dull, resharpen with the burnisher, without grinding or filing the edge. This can be done a few times, but soon the turned edges will become worn off and must then be refled. Some workmen grind the edges of the scraper with a bevel and use only the acute angle of each edge. This gives a slightly keener scraping

edge than to grind the steel square, but requires more frequent sharpening and is of doubtful advantage.

The *Auger-bit* can be sharpened with a file and a slip-stone,—the scoring-nibs from the inside, lest they score a circle too small for the rest of the bit, while the cutting-lips are filed from the under side. The *Centre-bit* can be sharpened with a small oilstone.

Planer-knives and the like had best be taken to a machine shop where there are proper facilities for grinding such edges.

109. The Grindstone.—A quick-cutting stone is best or time will be wasted. Do not let it become softened in spots by being left immersed in a trough of water, for it will then wear away irregularly. A stone can be trued while revolving, either by one of the contrivances made for the purpose or by holding the end of a piece of soft iron, as a piece of pipe, against the surface, without water, the iron being moved from side to side as may be required. Emery-wheels are in common use, but are not so well suited to the beginner as the grindstone.

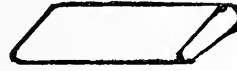


Fig. 369

110. Oilstones of very fine and hard grain, which give a keen edge but cut very slowly, are not so good for the beginner as those of moderate coarseness which cut faster. They should be set in blocks or boxes with covers to keep them clean. Wipe clean after using, to remove the paste of ground stone, steel, and oil left on the surface. In addition to the ordinary rectangular oilstones, slips of stone of various shapes are useful. Fig. 369 shows a common form. In rubbing with the slip, hold the tool upright in the hand and rub the slip up and down, moving the slip and not the tool (Fig. 364). If you rest the tool against the bench, it will steady it and the finger be less likely to be cut (Fig. 363). V-tools, carving gouges, or other tools sharpened on the inside, require slips of stone of corresponding shapes.

The carborundum stones are excellent. The Arkansas stone produces a keen edge, and is of fine texture. The Washita stone is good for woodworking tools, as it cuts rapidly. The India and Turkey stones are also used. Some stones cut well with water.

When an oilstone becomes unevenly worn, it can be trued by rubbing on sandpaper. Water can be used in this operation, or wet sand on a board.

Oil—Sperm oil is good to use with oilstones. Kerosene will do, but is thought to harden some stones. Lard oil can be used. All thick and gummy oils should be avoided. Never use any vegetable oil, as linseed, for it is not a good lubricator, and gums the stone.

The *Strop* is a piece of hard, smooth leather, as calf-skin or horsehide, on which can be spread a very little paste of sweet oil and emery, lard oil and crocus powder, or some similar preparation well rubbed in. The leather can be glued to a pine board for chisels, plane-irons, and other flat tools. A piece held loose in the hand is good for gouges and curved edges. Even a pine board on which air-dust has accumulated can be used as a strop.

Edge tools work more or less on the principle of the wedge (see page 139). This can be seen plainly when using the axe, hatchet, chisel, knife, etc.



Fig. 370

When cutting near an edge or where the wood bends aside easily, as in whittling thin shavings (Fig. 373), the edge cuts all the time and a thin blade with long, tapering wedge-shaped edge can be used, but where the wood will not separate easily a blunter shape is required to force the wood aside so that the edge may cut. Thus in splitting wood the cutting-edge starts the cut, but soon ceases to work, as the wedge-shaped blade splits the wood in advance (Fig. 370). The more acute the cutting-edge the easier it will work, provided it is obtuse enough to give the necessary strength to the end of the tool. Soft wood is more easily bent aside or compressed than hard wood so that the angle can be more acute for the former than for the latter. Thus, to always cut to the best advantage, the angle of the cutting-edge should,

theoretically, be changed with every new operation, but all that can be done practically is to have a longer bevel for soft wood than for hard.

Saw-filing is hard for beginners to do well, and it is soon enough to undertake it when the pupil has become quite familiar with the use of tools, for it does not need to be done very often and costs but little. The saw-filer should know for what work the saw is to be used and whether for hard or for soft wood. It is easy to understand the theory of setting and

filing saw-teeth, but to do the work well is hard and only a small proportion of good workmen are experts in fixing saws.

The teeth are first "jointed," or reduced to the same level, by lightly passing the flat side of a file over their points, lengthways of the saw. The saw is firmly fastened in a saw-clamp, so that it will not shake or rattle. At a north window is the best place for the clamp, on account of the light. The teeth are set by bending them outward, one tooth toward one side and the next toward the other side. Do this with a "saw-set." A tooth should not be bent for more than half its length.

For a cross-cutting saw the file (a triangular saw-file) is held at an angle with the blade depending upon the particular form of tooth adopted, as will be seen by examination. Hold the handle of the file in the right hand and the point between the thumb and forefinger of the left hand (Fig. 371). Push the file across with an even, straight stroke, without any rocking motion. Press only on the forward stroke and lift the tool on the back



Fig. 371

stroke. File from the handle toward the point, filing only the teeth which bend away (*i. e.*, every alternate tooth), and carefully keeping the file at the proper angle. Press only on the tooth being filed, but keep the file lightly touching the adjacent tooth, and make allowance for the fact that when the alternate set is filed the file will take off a little from the first set of teeth. Thus care must be taken not to file too much. Then turn the saw around and file the other teeth. On looking lengthways along the edge of a cross-cutting or panel saw that has been properly set and filed, an angular groove will be seen along the whole length, in which a needle will slide from one end of the saw to the other. After setting and filing, lay the saw on a straight board and joint the sides of the points of the teeth by running a

smooth file along the sides of the teeth. Thus the width will be more uniform and the cutting smoother.

The ripping-saw is usually filed square across at right angles to the blade (Fig. 73), but sometimes when a saw with fine teeth is used for very hard cross-grained wood, a slight bevel is given the teeth in filing. A saw with a very thin back, to be used without setting, is good for ripping very dry stock.

For soft, loose-fibred, and wet wood more set and larger teeth are needed than for dry hard wood, because the fibres, which are quite cleanly cut or broken in the hard wood, in the more yielding soft wood are bent aside by the teeth to close in upon the blade with considerable binding force. Less set is required for fine work than for coarse.

Power-saws.—The principle and the process of setting and filing circular-saws, band-saws, and jig-saws is the same as with hand-saws. The clamp for holding a circular-saw is circular. To joint a circular-saw revolve it at moderate speed and hold a stone (a bit of grindstone, whetstone, soft emery, or the like)

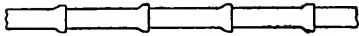


Fig. 372

against the teeth until all are reduced to the same length. The teeth of circular ripping-saws and band-saws are often "swaged" instead of being set in the way already described. The point of each tooth is spread with a tool called a swage, so as to be wider than the thickness of the blade (Fig. 372). Thus each corner of the tooth cuts instead of only one corner as with the common spring set. First joint, then file, then swage, then joint again and file each tooth sharp, and finally side-file to secure uniform width.

PART II

OPERATIONS IN SHAPING, FITTING, AND FINISHING WOOD

111. Whittling.—One great thing about whittling is that you do not rely on squares, rules, or compasses to get the work right, but must be independent, think quickly, look sharply, and rely on your faculties. Keep the left hand behind the knife-blade, and whenever possible cut from you, for the tool may slip. A slanting stroke is often best (Fig. 85). Much whittling is best done as in Fig. 373, often with the wood against some fixed object, and sometimes toward the thumb as in Fig. 374, the knife passing by the thumb and not against it. Watch the grain of the wood carefully to prevent cutting the wrong way. To cut a notch, begin in the middle and work outwards (Fig. 375). A notch or gain as in Fig. 100 can be cut as in Fig. 103. The wood for whittling should be of good quality, clear and straight-grained. Pine or white birch is good.

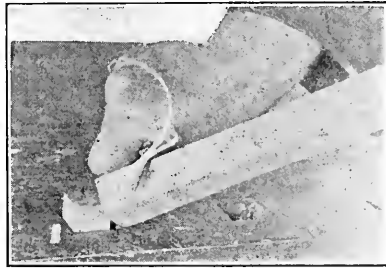


Fig. 373

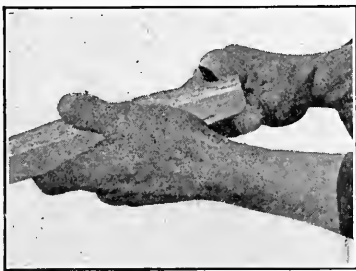


Fig. 374

112. Wedges are much used to clamp or hold parts of woodwork in place. See also page 150. To split, use a single wedge, but to press, hold, or move, without damaging the shape of the object, use

double wedges,—that is, two wedges having the same taper and pointing opposite ways. As the outer sides remain parallel when the separate wedges are driven, the work will not be injured (Fig. 195). Long, tapering wedges work more slowly than short, flaring ones, but are more easily driven and are less liable to slip. Tenons and dowels are often wedged (see page 149). Wedges and pins can often be made best with the chisel, after they are

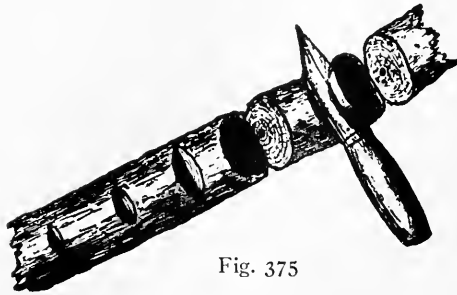


Fig. 375

sawed or split out approximately to shape (Fig. 98). Splitting wood (Fig. 370) is done on the principle of the wedge. Wood will split, as it cracks, most easily on the radial lines or in the direction of the medullary rays (see page 201), and also in the lines of the annual rings (see page 201).

113. Paring.—In paring to a line, the hatchet can sometimes be used safely until you nearly reach the line, but the direction of the grain must be watched carefully, since wood appearing to be straight-grained will not always split the way one would expect. It is often well to make a series of short cuts first, not quite to the line (Fig. 158), to break up the grain of the wood. Then trim in the direction of the grain with hatchet, chisel, drawknife, or whatever tool may be suitable (Figs. 158 and 376). This can often be done in chamfering, bevelling, rabbeting, hinge-fitting (see page 185), etc., and is common in carving. It is sometimes best to make cuts with the saw (Fig. 91).

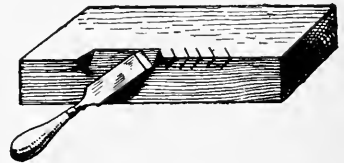


Fig. 376

114. Halving (Fig. 377) is a good way to join two sticks at right angles or obliquely. Place them in position, and mark the width of each upon the surface of the other with a knife. In small sticks the wood can be removed with the knife, first cutting a notch at each side

and then paring off the wood between (Fig. 103). With large pieces the side lines should be marked by the square, the depth (one half the thickness of either piece) with the gauge. The sides of the cuts can

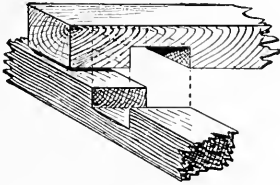


Fig. 377

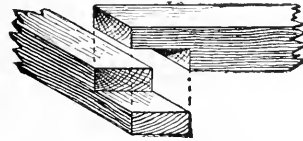


Fig. 378

then be sawed down, keeping just inside the lines. The wood can be pared out with the chisel (see page 33). When the halving is at the end of a piece (Fig. 378) the wood can be entirely removed by the saw.

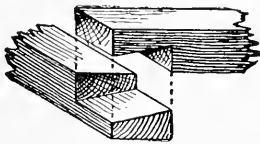


Fig. 379

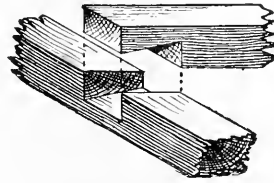


Fig. 380

Forms involving bevelling and dovetailing are shown in Figs. 379, 380, 381, and 382. There is also the open mortise and tenon (Fig. 383), which

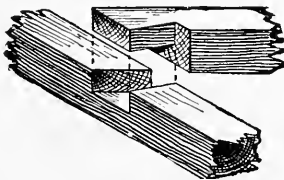


Fig. 381

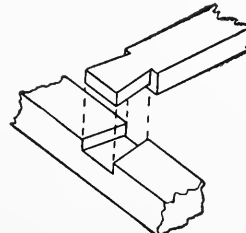


Fig. 382

can be applied to a mitred-joint, can also be dovetailed, and is in common use for cheap boxes (Fig. 384).

115. Mitring.—The only advantage of a mitred-joint (Fig. 385) is that it shows only a line at the angle and that the end wood is concealed. It is a weak joint at best. There are some cases, as in making a picture frame of “moulding,” when mitring is the only way

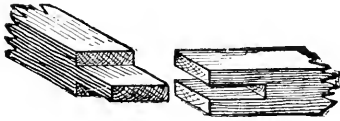


Fig. 383

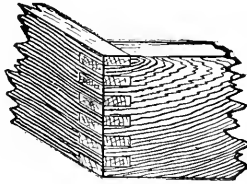


Fig. 384

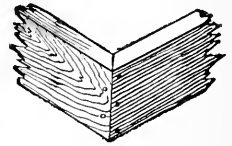


Fig. 385

in which the frame can well be put together, but as a rule, particularly where strength is required, avoid the mitre. To lay out a mitre, or the lines for the meeting of two pieces at any angle, the pieces can be laid one above the other at the desired angle (for which square or bevel can be used), and the points of crossing marked on each edge (Fig. 386).

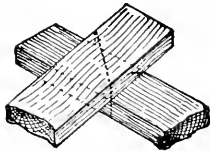


Fig. 386

Lines connecting these points will give the angles for cutting. Use the square to draw the lines on the edges. To nail a mitred-joint, fasten one piece upright in the vise, and after boring and driving the nail



Fig. 387

into the other piece until it pricks through, place the latter with the corner slightly projecting (Fig. 387). As the nail is finally driven home the upper piece can be forced down until the corners meet. Before gluing, size the joint with thin glue (see page 184).¹ When dry, scrape, glue again, and put the joint together (see *Picture-framing*, page 252).

¹ This applies to indoor work. Do not glue joints which are to be exposed to the weather.

The mitre-box (page 85) is the simplest way to saw a mitre accurately without machinery. A trimmer (page 61), with knives making a shearing cut, is good for trimming accurately at a mitre or other angle, and a mitre shooting-board (page 85) or an adjustable mitre-plane can also be used.

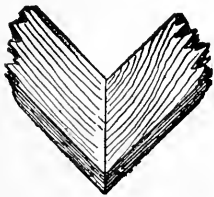


Fig. 388

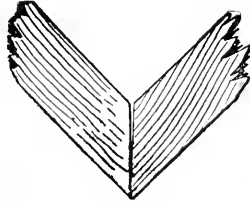


Fig. 389

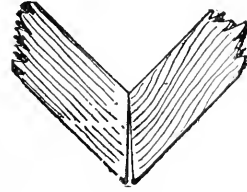


Fig. 390

The mitre is not a good joint for wide pieces used flatways (Fig. 388), for the wood will expand and contract more or less. Shrinking in width will open a tapering crack from the inner corner (Fig. 389); swelling, from the outer corner (Fig. 390). A mitred-joint can be strengthened by inserting a spline or tongue, with the grain running across the joint (Fig. 391), and

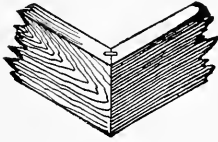


Fig. 391

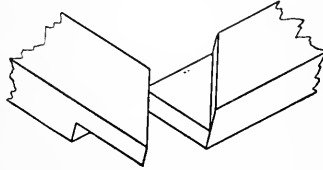


Fig. 392

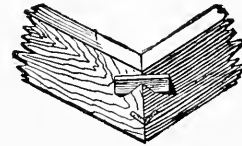
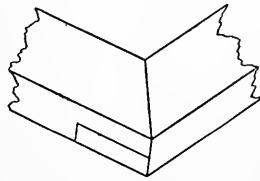


Fig. 393

glued under pressure when possible. This fitting is quickly done with a circular-saw, but requires much care to do well by hand. A mitred-joint can be halved (Fig. 392), and can also be dowelled (page 152). Saw-kerfs, or wider cuts, can be made (Figs. 393 and 394), into which thin strips can be tightly fitted and glued,—a good way, after the mitre is put together.

A combination of the mitre with the joint in Fig. 383 is shown in Fig. 395, the result being much stronger than the plain mitre.

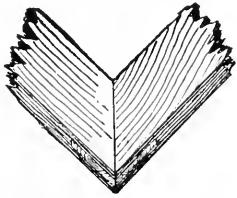


Fig. 394

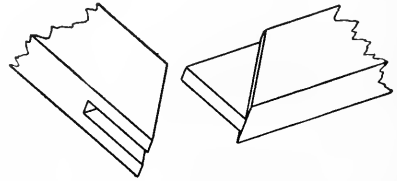
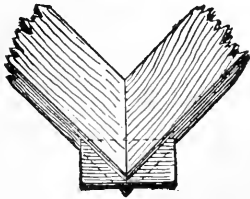


Fig. 395



116. The Mortise and Tenon.—The mortise (Fig. 396) is the hole in one of the two pieces to be joined. The tenon is the pin or projection in the other piece, shaped to fit the mortise.

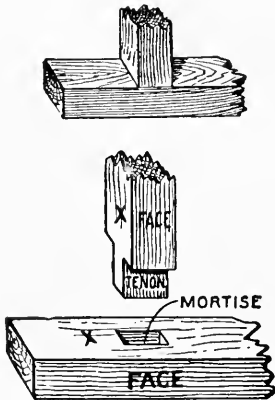


Fig. 396

To lay out a mortise and tenon (Fig. 396), select and mark the working faces for each piece. First take the piece in which the mortise is to be cut (Fig. 397). Square two lines, *ab* and *cd*, across the face (Fig. 397) and the same distance apart as the width of the tenon piece. Carry these lines across the side \times (*ae* and *cf*) and also across the side opposite to \times (that is, the side where the tenon will come through). Next measure from the end of the



Fig. 397

tenon-piece (Fig. 398) a distance a trifle greater than the width of

the face of the mortise-piece, and from this point square a line, *gh*, across the face of the tenon-piece. Continue this line, *gi*, around the piece, with the square. Set the gauge at the distance that the mortise is to be from the



Fig. 398

face, scribe the line *jk* on the side *X* (Fig. 379), and on the opposite side. From the face of

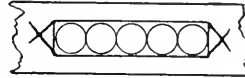


Fig. 399

the tenon-piece (Fig. 398), without changing the gauge, mark *lm* on the side *X*, on the opposite side, and on the end. Add the width of the mortise to the distance at which the gauge was set, and scribe another

set of lines, *op* and *rs*, etc., as before, gauging all the time from the same face. Another gauge can be used for this; or both sides of the mortise marked at once with the mortise gauge (page 14). In coarse work, where marks on the surface do no harm, the gauge marks can be run across the other lines. The parts to be cut away, or to be kept, can be shown by cross marks (Fig. 399). These are called "witness-marks" in framing.



Fig. 400

The simplest way to cut a mortise is to first bore a series of holes, from both sides of the mortise, with a bit of a diameter a little smaller than the width of the mortise (Fig. 399). The rest of the wood can be pared to the lines with the chisel. Do not jam it down lengthways of the mortise when the latter is blocked with chips or firm wood, lest the side of the mortise be split off.

To cut out the wood with the chisel only, take one a little less in width than the mortise, begin near the middle of the mortise, hold

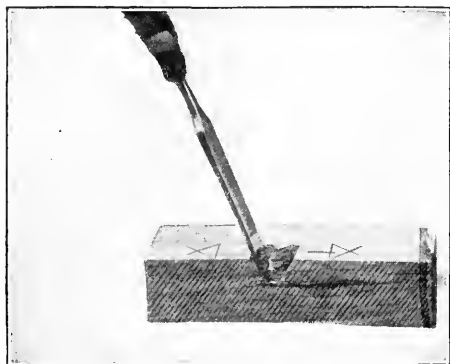


Fig. 401
SHOWING SECTION

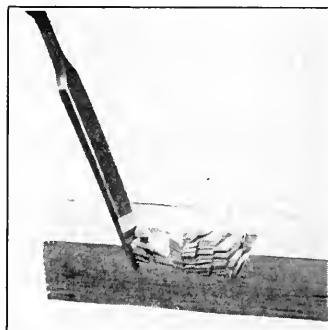


Fig. 402
SHOWING SECTION

the tool as in Fig. 400, with the basil turned outward, and make a V-shaped opening in the middle (Fig. 401). Then make successive cuts, working toward the ends, which will be left slanting (Fig. 402). Give

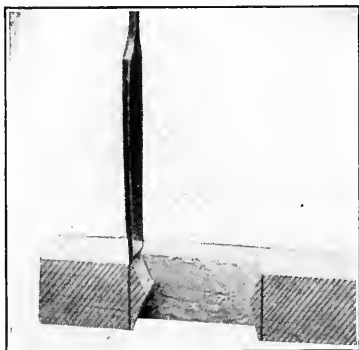


Fig. 403
SHOWING SECTION



Fig. 404

the chisel handle a slight pull toward the centre of the mortise each time you move it, to loosen the chips.

After cutting about half through the piece (Fig. 402), turn it over

and repeat the process from the other side (Fig. 403). Now turn the chisel around with the flat side toward either end of the hole (Fig. 403), and pare the end to the line. Finally, use the chisel lengthways of the grain only toward the end of the process, to pare the sides evenly with light strokes to the line. Try to hold the chisel so that the sides of the mortise will be square with the surface. Test the cutting of the sides and ends with the chisel (Fig. 404). The firmer- or paring-chisel can be used for light mortising, but for heavy work use the mortising-chisel.

To cut the tenon, saw carefully to the line *gh* and its opposite (Fig. 398), and on the lines *lm* and *rs*. Do not cut beyond the line, or the tenon may be too small. It is easy to trim it a little with the chisel if too large. In soft wood the sides of a tenon can often be pared down best with the chisel, but in hard wood the saw can often be used to better advantage. Cut a little bevel around the end of the tenon (Fig. 405), so that it will not tear the mortise. The projecting end of the tenon can be cut off afterward. The tenon should fit the mortise snugly, but should not require much force to drive in, lest it split out the sides of the mortise.

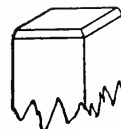


Fig. 405

The proportions of a mortise and tenon should depend on the kind of work, the wood, the strain to be put on the joint, etc. If the tenon is very thin it will be weaker than the sides of the mortise. If very thick, the reverse will be the case. One third of the width of the piece is as thin as a tenon is often made (Fig. 406). It will then sometimes be weaker than the sides of the mortise. If the joint is to stand violent wrenching, the tenon in this case might break before the mortise-cheeks, and had best be made a little thicker, with the sides of the mortise a little thinner; but if the joint is merely to hold the tenon-piece in position, as in case of a post resting on a sill, one third is wide enough for the tenon, as it is best not to weaken the sill by cutting a larger mortise than necessary. On the other hand two thirds of the width of the piece would be too thick to make a tenon, as it would leave the cheeks of the mortise very thin.



Fig. 406

The length of a mortise is also a matter of judgment. If the tenon is thin, the mortise can be longer than if it is thick, for the cheeks will be thicker and stronger; but, as a rule, avoid trying to make very long mortises, unless the tenon is very thin and the wood very strong, as there may not be strength enough in the cheeks of the mortise (Fig. 407).



Fig. 407

as long as it is well to make a mortise under ordinary circumstances.

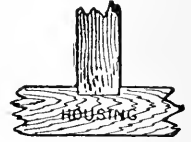


Fig. 408

Sometimes the tenon-piece is simply let into the other piece for its full width ("housing," Fig. 408). Two or more tenons are sometimes cut on a wide piece, thus avoiding too long a mortise; but this will not do for very wide stock, unless some of the tenons are fitted loosely at the ends, for the expansion and contraction of a wide piece may cause change of shape or splitting, if all the mortises fit snugly (Fig. 409).

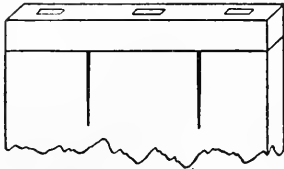


Fig. 409

In such cases as a door-frame, or when the end of a board is to be fitted into the side of a post, a tongue and groove is often used in addition to the tenon ("relishing," Fig. 410), and this is a good way. The mortise and tenon given in Fig. 396 is a very simple form. Sometimes the tenon is short and does not go through (Fig. 416). In this case it should not reach quite to the bottom of the mortise. This is a common form, sometimes called blind mortising.

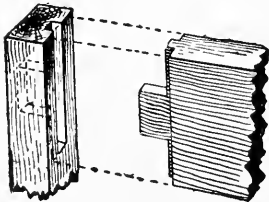


Fig. 410



Fig. 411

Mortise and tenon joints can be glued, pinned, wedged, dovetailed, and fastened with a key.

To pin a mortise and tenon, mark a point with square and gauge upon

each side of the mortise-piece (Fig. 411), fit the tenon in place, bore a hole, drive through a snugly fitting pin, and trim off the projecting ends. In fine work bore from both sides. The pin should be slightly pointed before

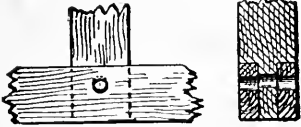


Fig. 412

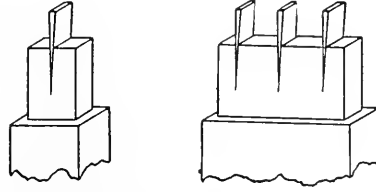


Fig. 413

driving. An eight-sided pin is as good as a round one. Do not use too large pins. In ship-building, bridge-building, and old-fashioned house-framing, pins and treenails from 1" to 1¾" or more in diameter are used. Dowels (page 152) will often do for small framing (though a rift-pin is stronger). For such work as pinning a joint in a chair or table, a ¼" hard-wood pin will usually do. If the pin is too far from the edge, its hold on the tenon will be weak and the end of the latter may break out (shear). If too near the edge, the sides of the mortise may tear or split off.



Fig. 414

Sometimes, particularly in timber work, to insure a snug fit at the joint, "draw-boring" is resorted to (Fig. 412). The hole in the tenon is bored a little nearer the shoulder than the holes in the mortise-piece,

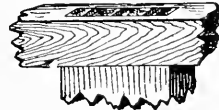


Fig. 415

so that when the pin is driven through it draws the tenon-piece to a snug fit at the shoulder. This has to be done with judgment; for if the hole in the tenon is too much out of line, driving the pin through puts too much strain on the end of the tenon, on the pin, and on the sides of the mortise.

To wedge a tenon, one or more saw-cuts should be made in it and carried farther than the wedges will extend (Fig. 413). A small tenon can be split carefully with a chisel. Before wedging, the ends of the mortise should be enlarged toward the side on which the tenon comes through (Fig. 414). The tenon and mortise having been glued,¹ and glue also put into the saw-

¹ Use glue for indoor work only. It is useless for work to be exposed to the weather.

cuts with a thin slip of wood, the tenon is fitted in place, and the wedges, previously prepared and tapering quite gradually, are dipped in the glue and driven down into the saw-cuts. Thus the end of the tenon is spread into a dovetail until it fills the mortise tightly (Fig. 415), making it very hard or impossible to pull it out.

When the tenon does not go through (Fig. 416), the mortise is undercut as before, and the wedges are so planned and cut that they will spread the tenon to fit the mortise. The wedges must not be so long as to break off or to interfere with the tenon being driven home, and the bottom of the mortise must

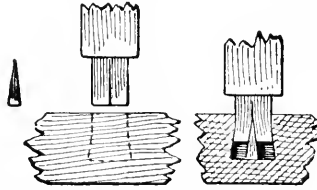


Fig. 416

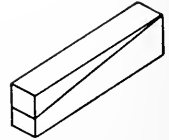


Fig. 417

be flat where the wedges will come, else they may be bent to one side and not drive into place. When everything is ready, apply the glue, start the wedges in the cracks, and drive the tenon to place. This will push in the wedges, spread the tenon at the end and fix it firmly. If well done, it cannot be withdrawn.

To have the tenons pass through the other pieces and be held in place by keys or wedges is a way much used for bookcases, tables, and the like (Fig. 696). The process is similar to that already described, and requires

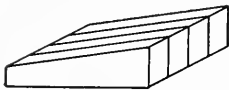


Fig. 418

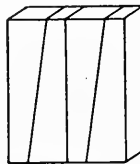


Fig. 419

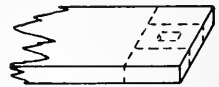


Fig. 420

much care. If the small mortises for the wedge-shaped keys are cut before the tenons, there will be less danger of splitting the latter. To make the keys, get out one piece of the required size and long enough to make all the keys wanted. Saw them to length, gauge the small ends, mark the taper on the sides (Fig. 417), and cut to the lines. They can also be got out in one block, tapering (Fig. 418), and then sawed into the required

number of wedges; or a rectangular block of the necessary size can be sawed slantingly (Fig. 419). (See also *Wedges*, page 139.) Square lines around a tenon piece at the shoulder. Mark the width of the tenon with the gauge on the sides and end. Gauge lines on the tenon for the sides of the mortise into which the key is to fit, and square lines across these gauge marks so that the mortise for the key will be of the right length for the latter to fit (Fig. 420). In marking the line which is nearer the shoulder, it should be a little nearer the shoulder than the distance from the latter to the pin, so that the pin will force the joint to a snug fit (Fig. 421).

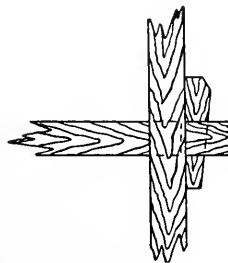


Fig. 421

The mortise is laid out and cut as already described. The shoulders of the tenon-piece can be slightly undercut, or bevelled inwards (Fig. 422, which is exaggerated) to ensure a close fit. It is common to have two mortises and tenons.



Fig. 422

For common or rough work the tenons already described will do, but for nice work shoulders are also cut at the other sides of the tenon (Fig. 413). This makes a neater joint, as these shoulders cover the ends of the mortise.

When the joint comes at the end of the mortise-piece, the tenon can extend to the edge on the outside and the mortise be cut out to the end, forming an open mortise and tenon joint (Fig. 383), or a wide shoulder can be left on the outside of the tenon (Fig. 423). This is done in doors and frames of various kinds.

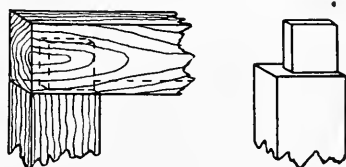


Fig. 423

When two mortises come together as in Fig. 726, the result may not be so strong as when they come at different places, because the mortise-piece may be cut up too much; but where there is plenty of wood in the mortise-piece in proportion to the size of the tenon, this will make no difference. In laying out mortising for frames, chairs, tables, screens, and the like, where there are two or more pieces alike, lay the

similar pieces on the bench or horses, for marking, with the face-sides either together or on the outside, to ensure accuracy in putting the work together.

117. Dowelling.—Dowels are round sticks of different diameters used in place of nails and screws, or instead of mortising, dovetailing, etc. They can be split and wedged (Fig. 424), in which case the outer ends of the holes should usually be enlarged. Dowels are much used in framing furniture, which is not to be recommended, usually, as mortise and tenon are generally much better. Split and wedged dowels are often useful. Dowels are sometimes good when slender members are to be joined, and are valuable in pattern-making and where it is required that the parts of work be separable, when the dowels can be glued into one piece only. Dowelling, to be good, has to be skilfully done.



Fig. 424

To find the centres for boring, so that the holes in the two pieces will be opposite each other, square lines across both pieces, and gauge lines at the required distance from the edge of each piece, crossing the lines just squared (Fig. 425).¹ It is well to take a round pointed awl and prick a small hole at each point marked, to start the

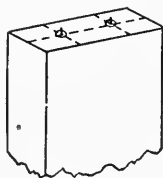


Fig. 425



Fig. 426

worm of the bit, as it is apt to work off to one side.

It is hard to bore the holes exactly at right angles to the surface,

¹ Where gauge and square can not be used, the centres can sometimes be found by scribing, with compasses, the same intersecting lines upon each piece, as in Fig. 37. Also, if other means can not well be used, cut off and point the heads of small wire brads and drive them into one piece, where the centres of the holes should be, until they project perhaps $\frac{1}{16}$ of an inch. Press the pieces together in the right position in order that the brads may prick corresponding holes in the second piece (Fig. 426).

which is necessary for a good joint. Sometimes the pieces can be laid flat on the bench and blocks arranged to guide the bit. The dowels must be thoroughly dry. It is better to have them a trifle too large rather than too small, for then they can be pared to a snug fit.¹ Trim off the sharp edge at the ends (Fig. 427).² Countersink (page 55) a little hollow around the mouth of each hole (Fig. 428) to catch the surplus glue, which otherwise may form a rim around the dowel. Before gluing, the work should be fitted together, as it is very awkward to make changes after beginning to



Fig. 427

glue. If the parts fit accurately take the joint apart, glue around the inside of one of the holes with a small stick,

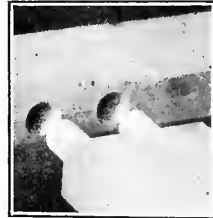


Fig. 428

dip one end of a dowel in the glue and drive into place. Wipe off any superfluous glue and repeat the process with each of the dowels in that half of the joint. Leave to dry a day or more. Then see that

there is no hardened glue on the dowels or on the faces of the joint, and glue them as before into the other piece, this time putting glue on the flat surfaces which are to come together. These should be warm (see page 182). Clamp the

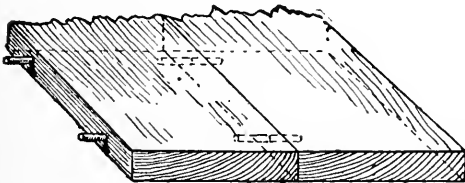


Fig. 429

whole firmly and leave to dry. Dowels are sometimes used in joining edges (Fig. 429), and in many other joints.

Dowels are usually of hard wood and can be bought in long sticks. To make them of exact size throughout, they can be driven with a mallet through a hardened steel plate having holes of various sizes. The sizes should be such that the dowels will drive snugly into the holes made by the corresponding bits. The holes in the plate should be slightly smaller at the top (Fig. 430).

¹ It is well to scratch them lengthways with the toothed-plane or with the edge of a file.

² Dowel sharpeners are made for this purpose.

118. **Dovetailing** requires much skill to do well. It is a scientific and workmanlike method, which should be understood even if seldom used. The common form, used in joining the sides of a box (Fig. 431), can be done as follows: mark the lines ab (Fig. 432), using the gauge,



Fig. 430

completely around each piece, at a distance from the end equal to the thickness of the stock. Lay off the lines cd on the end of the piece A : Lay off the oblique lines ec on both sides of the wood.

Fasten the piece in the vise, end upward, and with the back-saw (or a dovetail-saw) cut by these oblique lines (ec) to the lines ab . Lay the piece flat, and with the chisel cut out the parts to be removed (marked m), as in cutting a mortise (page 146), undercutting very slightly at the end (Fig. 422). When this cutting has been cleanly done, lay the piece

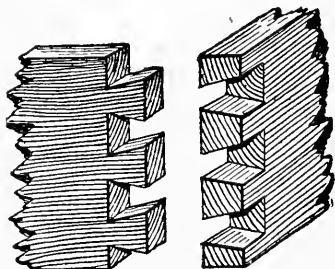


Fig. 431

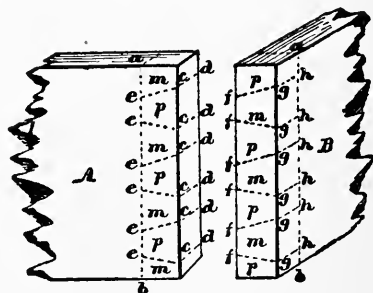


Fig. 432

A on the end of the piece B in the way it is finally to go, so that the pins just cut will rest exactly in position across the end of the piece B . Mark around the pins, forming the oblique lines fg , from the ends of which square the lines gh on both sides of the piece. Remove the wood as before, taking care not to cut on the wrong sides of the lines which mark the pins, or the dovetailing may fit too loosely. When fitted, apply glue, put together, and when dry smooth off.

Lap or drawer dovetailing (Fig. 433) is similar to the preceding form, but the ends of the pins or dovetails on the sides of the drawer are shortened,

and the recesses in the front piece which are to receive them are not cut through to the front. The side piece (Fig. 434a) is marked and cut as

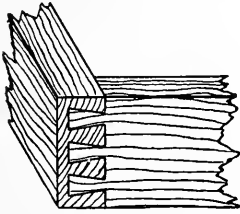


Fig. 433

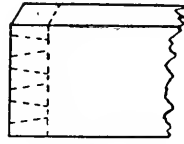


Fig. 434a

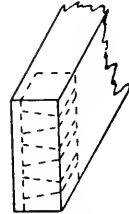


Fig. 434b

just shown, the pins being shorter; then the other piece (Fig. 434b) is marked and cut to fit. *Mitre dovetailing (blind or secret dovetailing)* is used where it is desired to conceal the dovetails, the result looking like an ordinary mitred joint. This process requires much skill and care.

Practised workmen in dovetailing usually (unless exact symmetry of the pins is required) determine the bevels for the pins of the first piece by eye.

119. End-joints.—Saw the ends off as squarely as possible and plane or pare them if necessary. To saw to a fit, hold the pieces in position and run the saw down through the joint AB (Fig. 435). If one sawing is not sufficient, repeat the operation. This method can be used with joints which meet at any angle, but should not be relied on as a regular way to make joints, lest it result in a careless method of work.

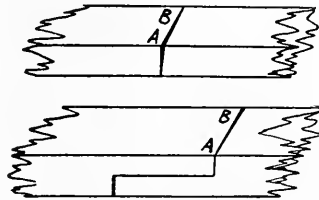


Fig. 435



Fig. 436



Fig. 437

Where only one side of each piece shows, the ends are sometimes undercut slightly—that is, the joint is made a little open at the bottom, to ensure

a tight joint on the side which shows (Fig. 436, which is exaggerated). Ends are sometimes joined by bevelled *scarfing* or *splaying* (Fig. 437), which makes a better joint in some cases than the common square or butt joint, but is more work. Strips of moulding are often joined in this way.



Fig. 438

120. Splicing.—There are many ways of splicing two or more pieces to get greater length, some for bridge-building, roof-framing, etc., being quite complicated. The beginner will rarely, however, have occasion to do more than nail strips (fish-plates) on the sides of the pieces (Fig. 438), or make a halved splice or scarfed joint (Fig. 439), which can be fastened in various ways. A joint for a brace is shown in Fig. 757a.



Fig. 439

121. To make Wide Surfaces with

two or more boards or planks several methods can be used. Cleating (page 157), though strong and suitable for such work as common drawing-boards, rough doors, and the like, is often undesirable. The simplest way, without cleats, is to glue the edges, which must first be jointed (page 47). Then after gluing (page 182), the surface can



Fig. 440

be planed and squared to the required dimensions. This kind of joint is sometimes doweled (page 153), or grooves cut and a spline inserted (Fig. 440). A rabbet can be cut in each edge from opposite sides (Fig. 708). The edges can also be matched (Fig. 740), in which case it is not usual to glue them. These last ways can be done by machine quicker than by hand.

To avoid warping and change of shape, any wide surface, such as a drawing-board or bread-moulding-board, should be cleated or fastened in some way, or be built up of selected narrower pieces (Fig. 441). This is done for many things, as the tops of benches, machine-tables, drawing-boards, etc.¹ Arrange the pieces so that the grain of the ends will be reversed in adjacent pieces (Fig. 441). This helps to counteract the ten-

¹ The frames of machines, chopping-blocks, masts, bows, fishing-rods, and many other objects are sometimes built up of selected pieces, to avoid flaws and defects and to arrange the grain to the best advantage. When glue is used there is always the danger that the joints may come apart. A piece which is practically perfect is probably better in most cases than a built-up combination. Otherwise it may be better to build up with smaller pieces of selected stock.

dency to warp. The grain on the surfaces of the pieces should run the same way so far as possible, otherwise it will be hard to smooth the surface after gluing,—for the whole should be glued together before smoothing the surfaces and edges.

122. Cleating.—A strong way to join two or more pieces of board or plank to make a wider piece is to cleat them on the side (Fig. 442). Such a cleat should



Fig. 441

not be glued unless the surface is very narrow, since the expansion and contraction across the surface is much greater than

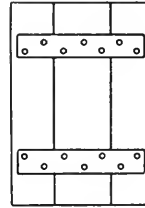


Fig. 442

that lengthways of the cleat (see page 211). Screws or nails should be used, as they will allow some play to the pieces. If the pieces are short they can be cleated across the ends (Fig. 443), which does well

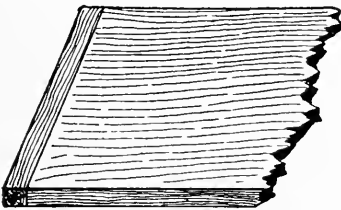


Fig. 443

for bread-moulding-boards and the like, or to keep a single board from warping. A groove can also be made in the cleat, into which a tongue on the end of the board can be fitted (Fig. 444). Grooves can be cut in both cleat and board, and a tongue or spline inserted (Fig. 445).

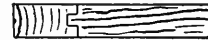


Fig. 444

These operations are done best by machinery. End-cleating does well on small work and where the tendency to warp is not too great. For heavier work, as doors, cleats on the side are stronger, though not always desirable. Do not put the screws or nails in a straight line, but “stagger” them (Fig. 442).



Fig. 445

A good way for such work as a drawing-board, but requiring nice work, is to use tapering wedge-shaped cleats, dovetailed into the under side of the board (Fig. 446). Make the cleats a little too long and drive them into place.

123. Chamfering.—A chamfer is the surface formed by cutting

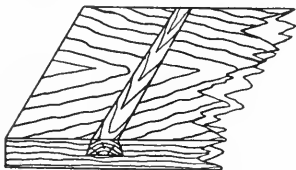


Fig. 446

away the angle made by two faces of a piece of wood. To chamfer or bevel with the plane, chisel, spoke-shave, draw-knife, or other tool, first mark parallel lines to work to (Fig. 447) with a pencil (Figs. 30–33) rather than a spur gauge, lest the work be defaced by the gauge mark. Then pare the wood

gradually to these lines, or first make a series of cross-cuts to break up the grain of the wood (Fig. 376), trimming off in the direction of the grain.

Where both end and side are to be chamfered, as in Fig. 448, first cut the end, because of possible chipping at the corner, and in cutting it you can work from each corner toward the middle. A simple bevel (Fig. 448) is usually best made with the plane, which can often be slanted to good advantage (Fig. 139). In paring a bevel

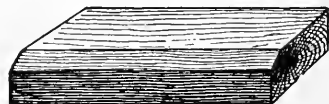
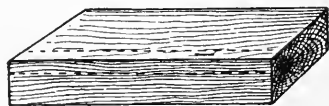


Fig. 447

across the grain with the chisel, push the tool as in Fig. 94. This is the easiest and cleanest way to cut, and prevents splintering. To remove waste wood the chisel can sometimes be held best with the basil down (Fig. 95), finishing with the flat side down. Test a chamfer with the bevel (Fig. 20), or by holding a straight-edge across the surface (Fig. 53).

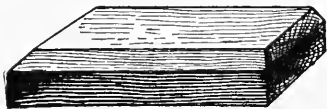


Fig. 448

In cutting the ends of a stop-chamfer (Fig. 449), do not cut quite down to the line at first, or a tool mark may be left which can not be removed. For long chamfers or bevels, use the plane, as far as you can without striking the wood at the ends. The plane can be held slantingly, so as to cut near the ends, and a bull-nosed plane will cut nearer still. The draw-knife can sometimes be used before the plane. The extreme ends must be trimmed with the chisel or other tool. In sandpapering a chamfer

care must be taken not to round the angles (Figs. 207, 208 and 209). Sometimes it is desired to remove only the sharp edge or corner, by merely a slight touch of a tool or by sandpaper. A "cornering tool" is made for this purpose.



124. Grooving.—A rectangular groove can be cut by hand with a plane made for the purpose (as the plough), although this operation has been superseded by machine work, except in cases of necessity. The beginner should, however, learn to do such work by hand. The router is often used to smooth the bottom of a groove or a dado.



Fig 449.

In some cases the sides of a groove can be sawed by a hand-saw and the material removed by the chisel, but this is not easy if the groove is long. A stick is sometimes clamped beside the line to guide the saw and occasionally attached to the saw itself, or to a piece of saw-blade. The lines for the groove can also be cut with the knife or chisel, and the wood between removed by the chisel. A templet or pattern can easily be made to test the depth of grooving.

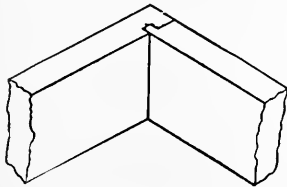


Fig. 450

125. Dadoing.—A dado is a rectangular groove across the grain (Fig. 450), and the principle of cutting is the same as for other grooving (see above). A dado-plane or the circular-saw (page 96) can be used. Dadoing is used for the best inside finishing, where the inside corner of the joint shows (Fig. 450), for it is good construction and never

shows an open joint, as may happen with mitring.

See also *Coping* (page 164), and *Rabbeting* (below).

126. Rabbeting.—A rabbet is a rectangular recess or groove cut lengthways in the edge of a piece of wood (Fig. 707), and is best made by machine (see *Circular-saw*, page 95). The beginner should

learn to cut one by hand however, and the rabbet-plane (page 42) is a useful tool.



Fig. 451

In some cases the saw can be used, the lines for the rabbet having been carefully marked with a knife or gauge. The chisel can also be used, as in cutting a mortise (Fig. 451). In the final trimming hold the flat side of the chisel toward the line. It is often best to pare across the grain with the chisel.

A strip of wood can be clamped across the piece on the line as a gauge or guide for the saw and the sawing be done with the heel or rear corner of the saw, keeping the latter close to the gauge, and pieces are sometimes even clamped to the saw itself to guide

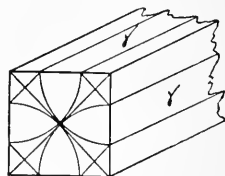


Fig. 452

it. Such expedients, though useful under some circumstances, are hardly the most workmanlike methods.

127. To make a stick eight-sided or octagonal in section.—First

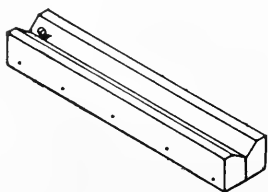


Fig. 453

make it square in section. Lay out an octagon on the end (see page 233). Gauge lines on the four sides of the piece, from the angles of the octagon, to show how much to plane off (Fig. 452).¹ For nice work a pencil-gauge (page 13) should be used to avoid defacing the work. Mark the sides which are not to be planed (Fig. 452), else they may be planed by mistake. In plan-

ing, place the wood in the vise, or against the bench-stop, or in a form (Fig. 453), taking care not to plane below the gauged lines.

128. To round a stick.—First, make it eight-sided (see above). Next, if the stick is large enough, plane off each of the eight corners so that it will be sixteen-sided. This is about as far as you can go in this way, unless the stick is quite large. Set the plane fine or you

¹ By setting the gauge equal to the radius of the arcs in Fig. 452, or one half the diagonal of the square, the required lines can be made, provided the piece is square in section.

may plane too much. Do the rest of the rounding with light, fine strokes, testing by eye and by passing the hand over the work. Sometimes the spoke-shave, chisel, or file can be used to good advantage,

as well as a curved scraper or glass. Cut sandpaper in strips and pull it back and forth around the stick (Fig. 454). Also use it lengthways of the grain (Fig. 455). An edge is rounded in the same way, first cham-

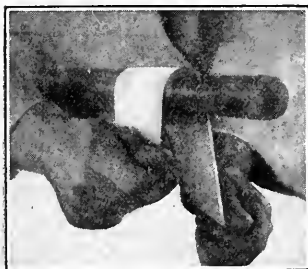


Fig. 454



Fig. 455

fering, then cutting off the angles left, and so on. Fig. 456 shows how the end of a round stick can be squared and Fig. 457 how it can be sawed.

Wood will rarely be found with perfectly straight grain, except in "rift" stock or natural sticks (and in these there are often unexpected twists and crooked streaks), so watch the grain carefully. Even a slight turn of the stick will often bring the grain wrong with relation to the tool, and one false cut running in too deep, or, perhaps across the stick, will spoil the work.

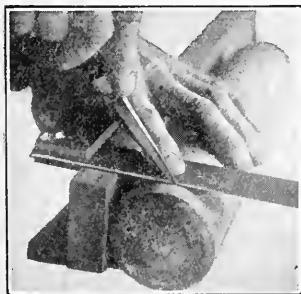


Fig. 456



Fig. 457

Masts and spars should be "natural sticks," if possible, and the final shaping and smoothing will be all they will require.

To round small sticks, as spars for model boats, arrows, etc., follow the

same process so far as the small size of the sticks will allow; but when the stick is too small to do this, fasten the plane bottom-up in the vise and pull the stick along the sole, or, hold the knife, with the edge downward, close against the side of your leg just above the knee, and pull the stick up steadily between the leg and the knife. Small square sticks can often be rounded entirely with the file, following the regular process so far as the size of the stick will allow. At the last one end can be rested on the bench and the stick turned toward you while filing.

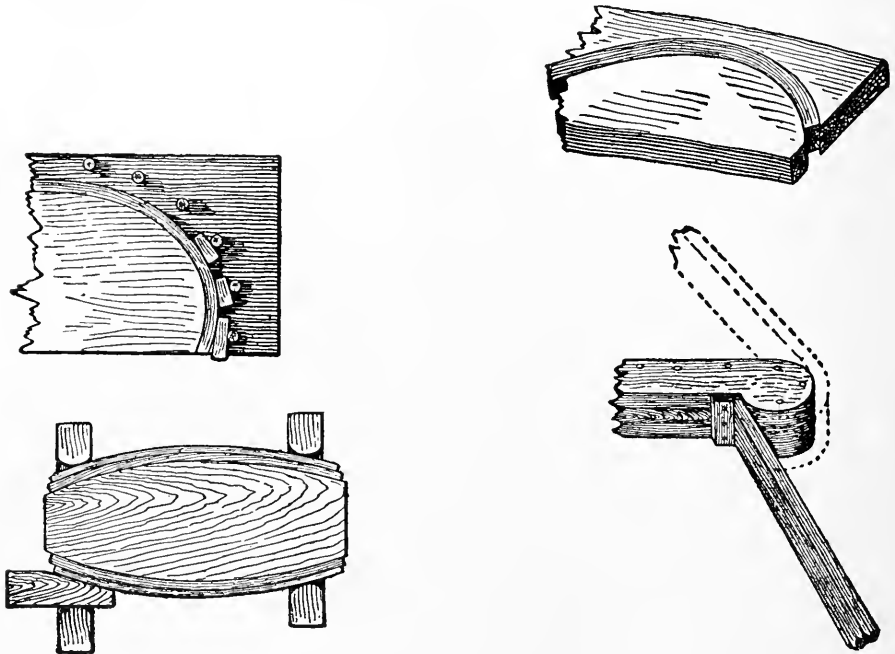


Fig. 458

129. Bending Wood.—The best way to make wood pliable for bending is usually by steaming in a steam-chest, which is simply a wooden or metal box with a steam pipe opening into it. Soaking wood for some time in boiling hot water will often make it sufficiently pliable, and cold water can be used in many cases. Soaked wood has, however, more tendency to straighten when dry than if steamed.

Pieces can be wrapped in cloth (flannel is good), or buried in sawdust or sand in a covered box, boiling water poured over them, and left to soak in the steam retained. Small pieces, or the ends of sticks, can be boiled in a kettle or wash-boiler. Boiling is not favorable to the durability of wood, nor is steaming conducive to strength. Greasing and applying heat is sometimes done.

Fig. 458 shows forms or moulds for bending. A strap of brass or other metal, or even a thin piece of wood should be placed outside of the stick to be bent when the curve is quick, to prevent the wood splitting or splintering. If one end of the strap be fastened to the form and a "stop" or end

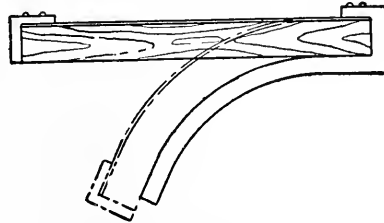


Fig. 459

piece attached to the other end, to bear hard against the end of the piece to be bent, end-pressure will be applied, during the bending, which helps (Fig. 459). Winding round or small square pieces with narrow strips of thin canvas, strong tape, or the like, will often prevent slivering.



RIGHT



WRONG

Fig. 460

After bending, the wood should be held in place until dry, or it will spring toward its original shape. The drying will take from several hours to several days, according to the size of the wood and the condition of the atmosphere. It is well to bend a piece a little more than you wish it to remain, unless it is to be permanently fastened, as there is usually a tendency to straighten out. A piece should be left on the form until dry and set.

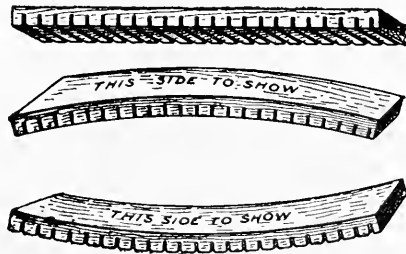


Fig. 461

For ribs, and the like, the stock should be got out so that the annual layers of the wood (page 201) will be at right angles to the direction in which the nails are to be driven (Fig. 460).

To bend a piece (without steaming or boiling), which is to be

fastened so that but one side will show, make a series of kerfs of equal depth (Fig. 461) across the back-side (the side which will not show), which makes the piece thinner so far as bending is concerned. This is best done with a circular-saw (page 94).



Fig. 462

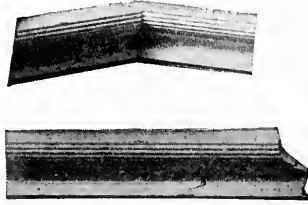


Fig. 463

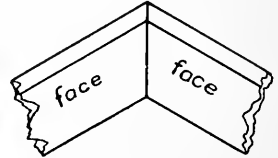


Fig. 464

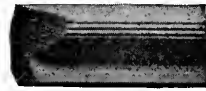


Fig. 465



Fig. 466

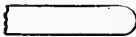


Fig. 467

The nearer together and the deeper the cuts the more the piece can be bent,—up to the breaking point. Hot water can be used on the face-side. Such curves can sometimes be strengthened by driving wedges, with glue, into the saw-kerfs after the piece is bent (Fig. 462), or the “kerfing” so planned that the cuts will close up, and can be glued. First run gauge lines along the edges, that the saw-cuts may be of equal depth. For uniform curves the kerfs should be the same distance apart. Bend the piece as you make the cuts. The proper distance between the kerfs for them to close up can be calculated, but this is unnecessary for the work of the beginner. A moulding can sometimes be bent after sawing it into strips lengthways.

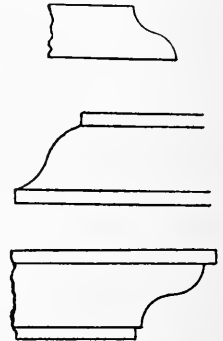


Fig. 468

130. Coping.—The end of a moulding is said to be coped when

it is cut to fit another piece, as in Fig. 463. Saw the end to be cut at an angle of 45° , as in making a “back” or “inside” mitre (Fig. 464, the reverse of the mitre for a picture frame), and it will give the line to which to cut (Fig. 465). The cutting is done with gouge and chisel

or a coping-saw (page 30). Dadoing (page 159) and coping are the best methods for fitting inside corners in first-class inside finishing.

131. Mouldings are of almost endless variety. A *fillet* (Fig. 466) is a strip of rectangular section, much used in ornamental construction and often combined with other forms. The *astragal*, or round-nosed moulding (Fig. 467), is in common use. The *ogee* (*cyma recta* and *cyma reversa*) is also common (Fig. 468). Figs. 469, 470, 471 show types of common mouldings, the proportions and arrangement of which are varied as desired. Beading, either projecting or sunk even with the surface, is a common form of ornament, either at a corner (staff-bead, Fig. 472), or edge, as in matched-boards (Fig. 473), or when called reeds as in Fig. 474. Mouldings are said to be "stuck," meaning worked or made. The bead

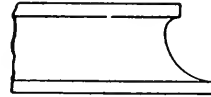


Fig. 469

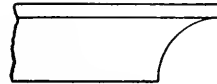


Fig. 470



Fig. 471



Fig. 472



Fig. 473



Fig. 474

in matched-boards is to render the joint less noticeable by making it an inconspicuous part of the moulding and in shadow. A few simple shapes, besides those given above, are suggested in Fig. 475, as being in common use for the edges of table-tops, bookcase-tops, and the like. The elementary forms can be variously combined, according to the taste of the designer.

132. To True Surfaces.—To true a curved or warped board, lay it on the bench with the rounded side down and wedge it firmly underneath to make it as nearly level as possible. Then scribe a line with the compasses across each end at the height of the lowest point of the surface (Fig. 476); and cut a depression or rabbet at each end down to this line (Fig. 477), or chamfer to the line. Winding-sticks (page 86)

will show whether the rabbets are in line, and they can be altered if necessary. Draw lines on each edge connecting the bottoms of the rabbets, or chamfers, and plane down to these lines. Test by sighting and the straight edge. The other side can be made parallel, and

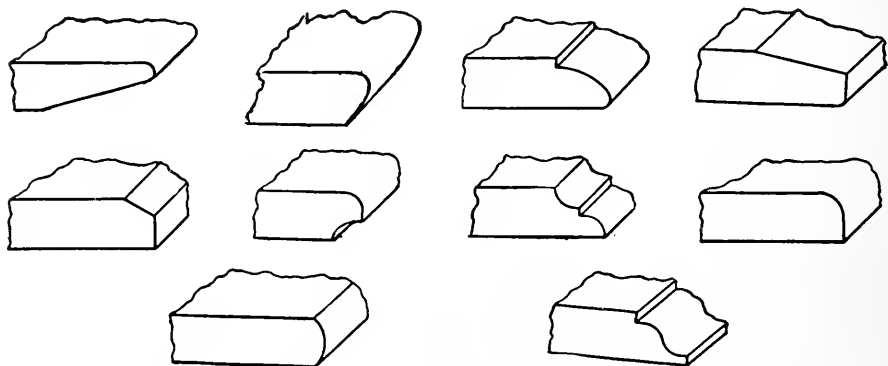


Fig. 475

therefore true, by setting the gauge at the thinnest point, gauging a line all around the edge, and planing to the line. Warping or winding of short pieces can be detected by laying a straight-edge diagonally from corner to corner (Fig. 478).

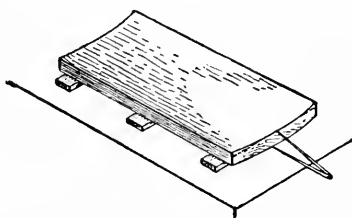


Fig. 476

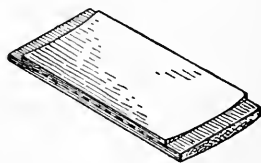


Fig. 477

A warped board can often be straightened by heating or wetting (or both) one side. Experiment will fix this in the mind best. These methods work quicker with thin wood than with thick, but do not feel sure that the result will be lasting. A board can be soaked or pressed into shape

between clamps or under a weight, and left until thoroughly dry. It is often well to bend a piece more than required, to allow for the tendency to spring back when released. Laying a board on a flat surface will often cause it to warp (thin wood quicker than thick), because the two sides are

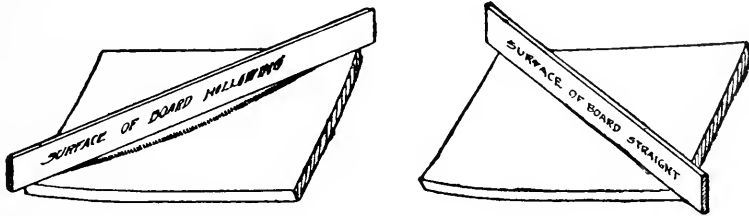


Fig. 478

unequally exposed to the atmosphere. Planing off one side only, or planing one side more than the other, often produces the same effect.

133. Panelling and Door-making.—To prevent bad results from swelling, shrinking, and warping of wide surfaces, the work may be framed in panels. The thin panel, fitting in the groove of the frame (Fig. 479), swells and shrinks, and often tends to warp and twist, but can not exert force enough to change the shape of the thick frame. It should fit closely in the groove, but be loose enough to slide in and out as it swells and shrinks. It should not extend to the bottom of the groove, but have room for expansion in width (Fig. 479, showing section on line AB).

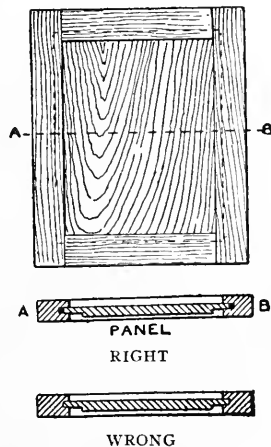


Fig. 479

In nice work rub wax or tallow around the edge of the panel before gluing the frame lest the panel become stuck. If it fits too tightly or becomes stuck it may buckle or split, or the frame be split or forced apart at the joints. If the door or surface to be panelled is too large for one panel,

several are used, often elaborately arranged; but all panelled work is based on the same general principles. The best way to fasten the frames of doors and panels is by mortise and tenon (see page 144). This can be done by machinery. Dowelling is often used for small doors, but is inferior, as a rule. A common way to make light doors, panel-frames, and other similar framework, which is not to be subjected to much strain, is to run the grooves in the stiles (Fig. 480) through to the ends and cut tongues or short tenons on the ends of the rails to fit them (Figs. 481 and 482). The whole frame and panel can thus be fitted quickly and accurately with a circular-saw (page 89). Sometimes the grooving and mortising are combined,—an excellent way (Fig. 410).

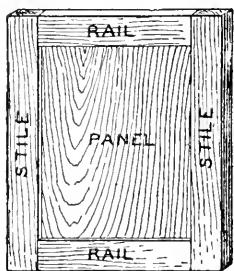


Fig. 480

In using any of these methods mark one side of each piece for the face and one edge for the joint-edge (which should be the edge next the panel), and lay out all the work from that side and edge only (Fig. 483). If done by machine gauge from the face-side and joint-edge. Do not cut off the stiles to length at first (Fig. 483). The projecting ends will be useful when you knock the frame apart for gluing, after first putting it together to see if everything fits, and the extra length makes the ends stronger for the mortising and fitting. The stiles are usually narrower than the rails and as a rule run the long way (Fig. 480), as in any common door. In laying out a door or panelled frame, place the stiles together, with the inside edges—the joint edges—uppermost and the face-sides outside, and square lines across the edges to mark the positions for the rails (Fig. 484). Carry

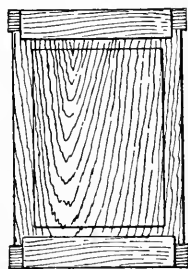


Fig. 481

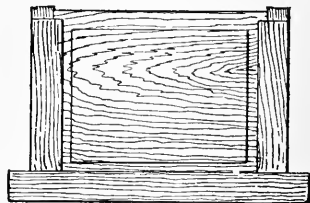


Fig. 482

these lines across the faces of the stiles and mark the rails and stiles with figures, letters, or some symbols to show the way they are to be fitted together (Fig. 483).

Plane and smooth the panel and the inside edges of the frame (the edges which come next the panel) and fit the whole together, to see that everything is right before beginning to glue. Then fit the panel in the grooves of the rails (Fig. 481), glue the tenons of one end of both rails and the grooves or mortises of the corresponding stile, and fit these parts into place (Fig. 482). Drive the rails home. Then glue and fit the other side of the frame in the same way (Fig. 485)—all being

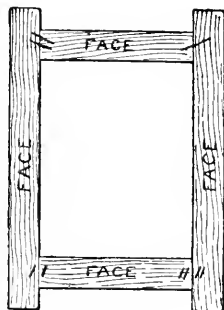


Fig. 483



Fig. 484

done as quickly as possible. Do not put any glue where it may cause the panel to stick. Finally clamp the frame securely (see *Clamps*, page 72). The tongued and grooved joint shown in the illustrations is not so good as a mortise and tenon, but can be used for a light door. Leave the work to dry, and when dry remove the clamps. Saw off the ends of the stiles,

and smooth the surface of the frame with the plane, scraper, and sandpaper. The end of a tenon is sometimes cut a little short and the mortise-hole on the outside edge plugged with a piece of wood, (page 189), with the grain running the same way as that of the stile (Fig. 486). The mortise is sometimes not cut through. Neither of these ways is so strong as a common mortise and tenon.

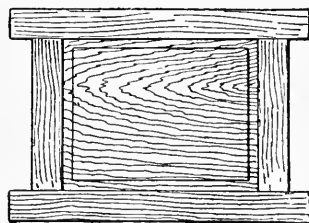


Fig. 485

In practical work it is best to make the grooving, or grooved and tongued joints, by machine. The beginner should, however, learn to do this by hand, with the planes made for

the purpose. The panel just shown (Fig. 479) is the simplest form. A panel is sometimes made flush with either side of the frame, by having a rabbet on that side (Fig. 487), but this can well be avoided by the beginner. The swelling or shrinking of the panel is an objection, as it is impossible to have it fit perfectly at all times. This difficulty can be avoided somewhat by making the panel thicker and grooving it as in Fig. 488. This is stronger and will show no crack. It is good for the lid of a box or desk, or any panel requiring strength. The surface of the frame must be finished before putting together, or shrinkage of the panel will show an unfinished strip. A panel can also be raised in the middle with a bevel or a curve around the edge (Fig. 489). Any combination of these forms can be used on the opposite sides. In nailing a moulding around a panel, nail it to the frame and not to the panel, for the shrinking of the latter may cause trouble.



Fig. 486

134. To Fit a Door.—Fit the edge which is to be hinged to the frame, then plane the top until the first edge and the top both fit the frame, and so on until all four edges are fitted, trying the door in place as the planing proceeds. A door must be fitted loosely enough to swing freely, and sometimes the edge which is not hinged is bevelled slightly to clear the frame. For *Hinging* see page 185.

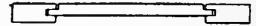


Fig. 487

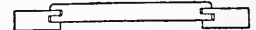


Fig. 488

135. A Few Elementary Operations in Simple Carved Work.—

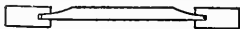
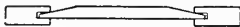


Fig. 489

The true carver can not get his inspiration from a book, nor even from a master, but must have in him that inspiration, artistic feeling, and power of execution, without which his work will not rise above the level of manual dexterity. No attempt can be made to teach the art of carving in a few pages, but it is well, however, to have some understanding of the methods by which the simpler forms in low relief are shaped, for the general woodworker often has occasion to work wood into odd shapes.

Elementary practise in carving can well precede the more mechanical forms of woodwork, for the training of hand and eye and mind given by it are of great value, not merely in the way of general development, but as increasing one's ability to handle the more mechanical processes later.

It is common to advocate beginning with soft wood, but there are some advantages in starting with good, clear-grained oak, not very hard. Pine, black walnut, mahogany, cherry, and other woods can also be used, if straight-grained.

The simplest tools are similar to other chisels and gouges, but are sharpened on both sides, and are of a great variety of sizes and degrees of curvature. The edges must be ground and whetted to be very keen, and kept so by frequent stropping. They should not be used for other work.

A carver's bench is usually a little higher than a cabinet-maker's or a carpenter's, but a special bench is not necessary unless much carving is to be done, as it is easy to block up the work. The bench should face the light, which should come down on the work if possible. Carving should be done standing, for it is hard to get the proper freedom of movement while sitting. A variety of holdfasts and clamping devices to keep the work in place are in use, but simple work can usually be held by the vises, clamps, wedges, etc., used in ordinary woodwork.



Fig. 490

Lay the tools on the bench before you but behind the work, with the handles away from you, as it is quicker to pick them up by the blades and to select the tool required. It is well to have the handles



Fig. 491

of carving tools of different pattern from those of the other tools.

The picture of what is to be carved should be

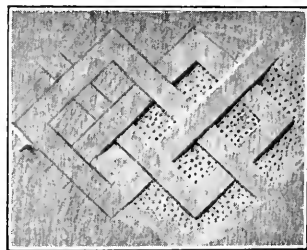


Fig. 492

clear and definite in the mind, lest the work become mere mechanical copying of a pattern.

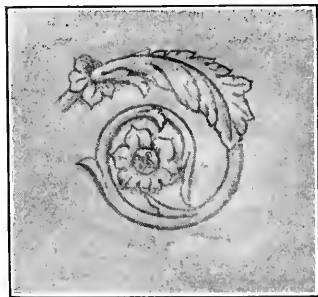


Fig. 493

A simple flat outlined design can be done by lightly cutting the outline with such tools as will fit (Fig. 490), cutting only deeply enough to clearly mark the outline. Try to use gouges of such curvature that the successive cuts will run together in smooth and flowing lines. Or the design can be outlined with a very light cut made with the V- or parting-tool (Fig. 491). Then stamp the background as in Fig. 492, with a carver's punch. For small places and corners

use a nail filed from four sides to a point.

To cut a simple scroll (Fig. 493), first roughly sketch the design

with chalk or pencil, and then go over it carefully with pencil. It is well at first to mark over the background (Fig. 490), as the beginner

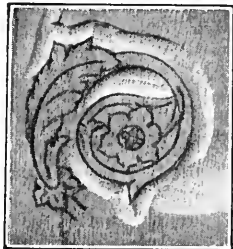


Fig. 494

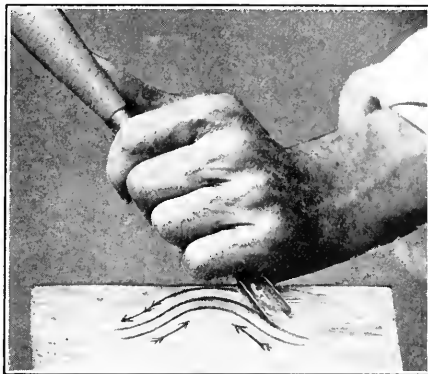


Fig. 495

is apt not to distinguish the design clearly. Clamp the wood firmly so that both hands can be free.

With a small gouge run a groove around the pattern, just outside of the line (Fig. 494), cutting in different directions when the grain requires. Remember to regard the grain of the pattern and not that of the background. Thus to cut the narrow band in Fig. 495 cut in different directions as shown. After thus roughly outlining the design (Fig. 494), carefully cut on the line down to the level of the background (Fig. 496). The mallet can be used for this. It is not necessary to have a gouge to fit every curve exactly. For an outside curve a gouge flatter than the curve can be

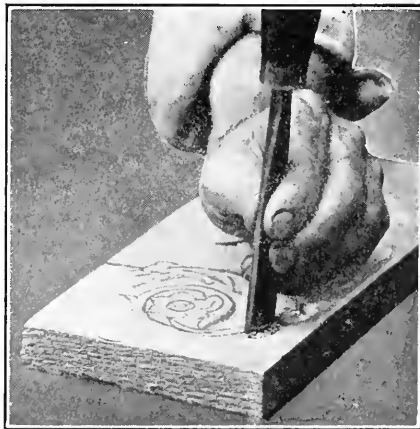


Fig. 496

used, and for an inside curve one "quicker" than the curve. As the groove first cut has removed most of the wood near the outline, the chips will readily break off in the waste wood (Fig. 496), without damaging the part to be kept, as might happen if the grooving were omitted (Fig. 497). The remaining wood in the background can

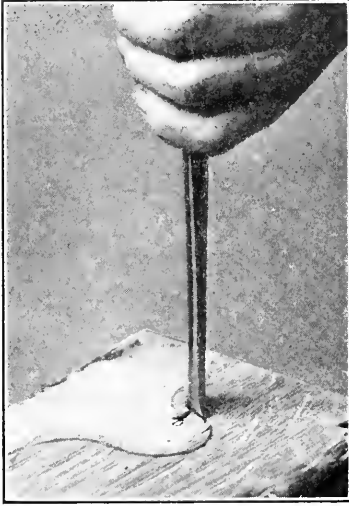


Fig. 497



Fig. 498

now be cut away, using as large a gouge as may be convenient (Fig. 498), and finally smoothed with a flat gouge. The angles and corners must be cut with whatever tool will best do the work, but the wood should in all cases be removed by clean cutting and not by prying. Do not try to make the background absolutely true, as if done by machine. The slight irregularity or waviness which naturally results from freehand work is proper in carved work. The

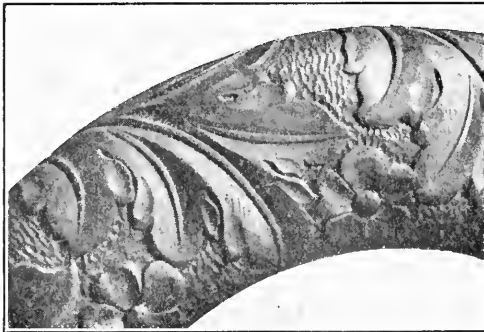


Fig. 499

usually results from freehand work is proper in carved work. The

background can be stamped as before, or, as is more commonly done, smoothed as nicely as may be with short cuts of a flat gouge. Little hollowing cuts as in Fig. 499 make a good background for many designs.

After a design has thus been outlined and the background cut the raised parts require to be shaped. In a design like Fig. 492 there is little to do but to cut down where the parts overlap. Sometimes the outline is undercut by sloping the handle of the tool outwards. When the design is to be moulded as begun in Fig. 500, for example, gouges of somewhat flatter curvature than those of the design are used. The cutting should be done with the grain, stopping and cutting the other way when the grain requires, on the principle shown in Fig. 495.

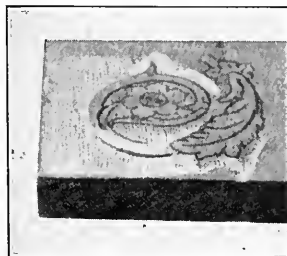


Fig. 500



Fig. 501

The general process with all work in high relief and odd-shaped or projecting forms is first to remove the superfluous wood, "rough out" the shape with such gouges as may be required, and then cut the details. Sometimes much of the waste wood can be removed by sawing. In roughing off the wood, begin at points distant from the final shape and work toward it, so that the waste wood only will break off, without danger of damaging the part to be saved. Sometimes waste wood can be quickly and safely removed by the use of the bits and bit-stock. When some part projects much above the general surface, a piece, or

pieces, can be glued on and carved afterwards, but gluing is not to be recommended unless necessary.

To shape the end of the arm of the corner-chair shown in Fig. 726 first round the end with the band-saw or by hand (Fig. 501), and then cut down between the divisions of the design, as shown, thus removing the waste wood before trying to work the wood exactly to shape.

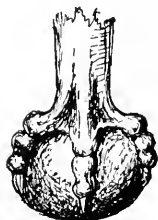


Fig. 502

In cutting a clawfoot as in Fig. 502, much of the waste wood can be removed by sawing as shown in Fig. 503 (see page 245.) The removal of the waste wood and roughing out can be begun as in Fig. 504, and the rest of the shaping done on the general principles already described.

In all cases remember to remove the wood by cutting, and never pry or tear it away. Also, learn at the start to work either right or left handed and to cut in any direction. The direction of the lines of the design and of the grain require continual change in the direction of the cutting, and it is not practicable to keep turning the work,



Fig. 503

therefore one must become ambidextrous in using the tools. Push with the hand which grasps the handle, check and control with the hand which governs the blade. (See under *Chisel*, page 31.) When the pushing force of the hand is not sufficient, a slight blow



Fig. 504

can be given the tool handle with the hand, but it is usually better to use the mallet.

Do not try to scrub carved work smooth with sandpaper. Leave it as the tool leaves it. A touch with sandpaper is sometimes permissible to remove a too sharp edge. Finish carved work either with wax or very thin shellac, never with varnish or a thick coating of shellac. A brush is the best thing for cleaning, rubbing over, and polishing carving.

The variety of odd-shaped carving tools occasionally used by carvers is very great, but for the work of the beginner or the general woodworker only a few of the simplest kinds are needed. A couple of skew-chisels, half a dozen gouges, a V-tool, veining-tool, and a couple of straight-chisels are enough to do a great deal of simple work. More can be added when needed. The outside of a carving gouge or parting-tool is sharpened much the same as other tools, but the inside bevel is made by rubbing with a slip shaped to fit the tool.

136. Counterboring is often done when the width of the piece to be bored through is not too great (Fig. 505). In boring with auger-bits the larger hole is bored first and then the smaller. If the smaller were bored first, there would be no wood for the worm of the larger bit to be screwed into, and it would be hard to bore accurately or even at all. To counterbore when the small hole is already bored a metal plug with a soft centre can be inserted in the hole for the worm to screw into (Fig. 506). See also *Screw-pocket*, page 254.



Fig. 505

137. Veneering. Veneers are sawed or sliced very thin from valuable logs, and are used to cover the surface of cheaper wood.

Veneering on a large scale is not suitable work for the beginner, but small plain work can be successfully done if sufficient care be taken. Veneering should be done upon soft straight-grained wood which is not liable to warp or twist and is free from knots, as clear pine. The surface to be veneered and the under side of the veneer are first toothed with the toothing-plane (page 41). The surface to be veneered is sized with thin glue, which is allowed to dry.

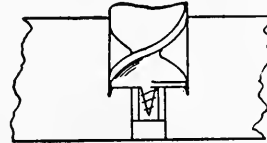


Fig. 506

The veneer, which should be cut a little too large, is dampened with hot water on the upper side and the glue then applied to the other side. Next the surface to be veneered is glued and the veneer put in place. The whole operation should be done as quickly as possible. To keep the veneer firmly in place until the glue has set strongly, it is pressed and held by a caul or

mould previously fitted to the surface and secured by clamps. The caul can be made of wood or of metal, should be heated and the surfaces soaped to prevent sticking. For very small flat work or patching, a flatiron can be used.

Veneers are also laid with a veneering hammer, which is held near the head with the handle turned away from the operator, pressed down hard and worked over the surface from the centre to the edges, forcing out the glue. The surface is finally dampened and wiped with a dry cloth. The use of the hammer requires considerable skill and experience.

138. Inlaying can be done by cutting out depressions or recesses in the surface of the wood and fitting in with glue pieces of wood or other substance of the shapes required by the pattern. The parts to be inlaid are got out of thin material in the required shape, the recesses carefully outlined, and the wood removed with chisels or router. If curved, the parts to be inlaid can be sawed with a bracket or coping saw (page 30). If both pieces can be sawed, place the piece to be inlaid on top and saw both together. The saw-table should be very slightly tilted, or if a bracket-saw be used it should be tipped outward at the top, so that when the parts are separated the upper piece will fit tightly in the opening made in the lower one, thus avoiding the loose fitting which would result if the saw were held vertically. The degree to which the saw or table should be tilted depends upon the thickness of the stock and of the saw. Much inlaying is easily done in this way with veneer or very thin stock, the inlaid piece being first glued in place and then the whole glued upon the surface of the work (see *Veneering*, page 177).

139. Lattice Work, fence pickets, and such regular work is easiest nailed by using a piece of wood of the same width as the space between the strips, and holding it beside each strip as a guide by which to nail the next one.

140. Shingling.—Begin shingling at the eaves and work upward. Lay a row the length of the roof, letting the butts slightly overhang the edge. On this row lay another, breaking joints with those underneath; that is, lay the first row double, but so that the spaces between the shingles of the lower layer are covered by the shingles of the upper layer. Leave a slight space (perhaps $\frac{1}{8}$ " to $\frac{3}{8}$ ") between the shingles in laying them. This gives room for swelling and allows the water to

run off freely. If the edges are close together at the lower end, the tendency is to dam up these water-courses and retain the moisture, which is injurious. Fasten each shingle with two shingle nails (one near each edge, within perhaps 1"), far enough up from the butt to be covered by the next row of shingles. Lay the butts of each row by a chalkline or against the edge of a narrow board, which can be adjusted and temporarily held in place by two strips nailed to it and to the ridge of the roof. Common shingles (16" long) can be laid about 4 1/2" to the weather; that is, with that portion of the length exposed at the butt. If shingles of extra length are used this distance can be varied accordingly. Trim off the upper ends of the top row of shingles and put on saddle-boards at the top, letting the edge of one overlap the other.

Cut nails are better than wire nails for shingling, as the latter rust away quickly. The best cedar or cypress shingles are not too good for any building where durability is of importance. Spruce is poor for shingles. Small knots or defects at the thin ends, where they will be covered by two or three layers, do no harm in ordinary work. Sapwood is objectionable as it is apt to rot before the rest.

141. Clapboarding.—Door- and window-casings, cornerboards, and such outside finish should first be put on. Clapboarding, unlike shingling, is usually begun at the top. Lay the upper row by a line, as in shingling (page 178), keeping the clapboards in place by a few nails in the upper part only. Then slip the next row up from below under the first row until only the desired width is exposed. Nail the first row near the lower edge with clapboard nails. This will hold the second row in position while the third row is put in place, and so on. The thin edge of the upper row can be covered by a strip of board or moulding. Clapboarding can be continued to the bottom of the building; or, if a water-table is used at the bottom (Fig. 507), the lower edge of the last row of clapboards should be bevelled to fit the upper edge of the water-table. Lay clapboards in line and at equal distances apart, as variations in the alignment are quite noticeable.

Break joints at the ends; that is, do not have the joints of one row in line with, or very near, those of the next row, above or below. Mark the ends accurately, using the try-square, and saw them carefully with a fine saw, trying to make as close joints as possible. A few defects in clapboards near the thin edges which are to be covered may do no serious harm for common work. Siding shaped as in Fig. 508 is sometimes used.



Fig. 507



Fig. 508

142. Flashing.—The tops of window- and door-casings and all similar joints should be protected by strips of sheet-lead, the upper edges of which are slipped up under the clapboarding (Fig. 509) or the shingles, thus covering the crack where the casing joins the side of the building, and shedding the water.

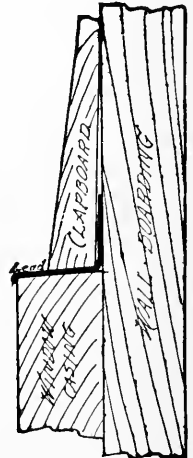


Fig. 509

This is important, as the rain will drive through such cracks, even though they seem tight. Tonguing and grooving (page 156) can be used in such cases, but flashing with lead is a simpler process. The same precaution should be taken where roofs or other attachments join a building. Zinc and even tin can be used, but are inferior to lead. Copper is good but expensive.

143. Repairing Furniture.—To repair thoroughly and leave no sign of the mending often requires more skill and ingenuity and more general knowledge of woodworking than to make new articles. To give complete directions for repairing would be to describe the majority of operations used in woodworking. One or two suggestions may, however, be of use.

To replace the arm of a chair, for example, first clean off all the old glue, next make the parts fit together, adding new wood if necessary, and finally

contrive some arrangement—hand-screws, clamps, a rope twisted, or some other device—to hold the parts firmly in place while the glue is drying.

The suggestion in Fig. 510 may be of use in curved or angular work. Rubbing chalk on the inside of the jaws of hand-screws helps to prevent their slipping.

In patching holes and defects in old work with new wood, the wood should match if possible. Trim off the new pieces after they have been glued in place rather than before, as a rule, but not until the glue has dried thoroughly. Staining (page 189) to match the older parts is often required. A repaired joint may not be quite so strong as a new one, therefore it is well to reinforce it with a block or brace glued and screwed on the under or inner side, where this can be done without showing, as inside the frame of a chair, sofa, or table.

If a tenon be too small, glue on thin pieces to make it larger, trimming them afterwards to fit. If this can not be done, wrap a little muslin, laid in glue, around the tenon. This can sometimes be done with round pins or dowels. Splitting and wedging tenons and dowels is often useful in repairing (pages 149 and 152). If necessary to use screws where the heads will show, first make, if possible, with bit or chisel a neat round or square hole of sufficient diameter to admit the head of the screw and deep enough to allow a plug of the same kind of wood to be inserted after the screw has been driven (see page 189).

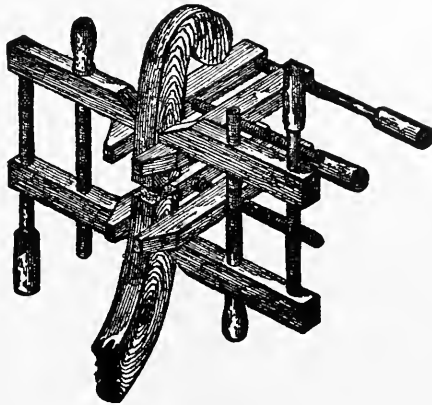


Fig. 510

144. Glue and Its Use.—Glue is made from refuse animal matter or from parts of fish. It comes in sheets or cakes or flakes or ground, to be dissolved and used hot, or in liquid form to be used cold. Hot glue is preferable for nice work if all conditions are as they should be, otherwise, cold glue may be better. In either case, buy the best

grade. Do not use glue that has a mouldy or otherwise disagreeable smell.

The only sure test is to get a little and try it. Glue end-wood under pressure after sizing (see page 184), leave until hard, and see how much force is required to break the joint. Soak glue over night, or as long as may be necessary, in as much water as you think it will absorb. The more it will swell without dissolving, the better the quality. You cannot tell good glue by the color, for there are many kinds and many makers; but it should be clear looking.

The Glue-pot is made of copper, iron, or tin, and is like the "double boiler" used in kitchens to prevent overheating. It should have a cover.

Glue-brush.—Brushes are made especially for glue. A good one can be made of a stick of rattan. Soften the end in hot water and pound it with the hammer until the fibres separate. For corners, cracks, and holes, use sticks, whittled to the required shape.

Preparation and Use of Glue.—To prepare glue hot, break it into small pieces, soak it in all the cold water it will absorb for perhaps twelve hours, then put it in the glue-pot and boil the water in the outer vessel for several hours. When cooked the glue should be thin enough to drip from the brush in a streamlet, without collecting in drops,—about the consistency of thin cream. Glue is oftener used too thick than too thin, but do not weaken it by diluting with more water than is necessary. Glue loses strength by repeated meltings, so clean out the glue-pot after every second or third using. For very nice work, clean it out every time.

Wood is filled with pores, or spaces between the fibres, and it is into these that the glue works, reaching from the cavities in one surface into the cavities in the other, thus getting a firm grip on the wood. Therefore the pieces should be pressed or clamped together as tightly as possible to force the glue into the wood, and not leave it in a layer between the two pieces, where it would be more exposed to the atmosphere. The wood should be warm, as well as the glue hot, so that

the pores may be thoroughly penetrated before the glue "sets." Gluing should be done in a warm room of an even temperature.

With hot glue the positions of the pieces must not be changed after putting them together, but with cold glue considerable time can be taken to get them into position. Where several parts of the work have to be glued at the same time it may be hard to apply all the hot glue before that first put on begins to set, unless you have help. In such cases, cold glue is better. Again, if the shop is not warm or if you cannot have the glue hot, use the other. This takes much longer to set than the hot glue. In cold weather it should be slightly warmed and it is best to warm the wood also. It may be thinned with vinegar or acetic acid (which keeps it liquid without putrefaction), or with water if you are to use it at once; but do not pour water into the stock-can of liquid glue.

Before beginning to glue have everything laid out, fit the pieces together, clamp them up as if you had put on the glue (see *Clamps*, page 72), and be sure that everything comes together right. It is particularly necessary thus to rehearse the process when there are several pieces to be glued, for there is no time to be lost when once you have begun to glue, and it will then be too late to correct mistakes in the fitting. Brush all dirt from the surfaces to be joined. Do not spread the glue on too thick. While applying it to one piece, let the other be warming near the fire.¹ The moment the glue on the brush leaves the pot it begins to cool. If it fairly begins to set before you get the two pieces together, the joint will not be good. Do not wipe off the glue which oozes from a glued joint, but let it harden, as it will protect the joint. After the piece has set several hours the surplus can be cleaned off. If necessary to remove it while fresh, wet a cloth with hot water, wring it dry, and wipe the joint. Glued joints should not be planed until the water in the glue has had time to evaporate.

No exact time limit can be set for leaving the clamps on glued work. This should depend on the kind of work, the kind of wood,

¹ To warm small pieces, a large box warmed by steam or other heat is convenient.

and other circumstances. Twelve hours is usually long enough for common work in soft wood and with hot glue. Although glue dries quickly to the touch, it takes some time for it to become actually hard. More time should be allowed for hard wood than for soft. Large blocks and pieces glued flatways require more time than thin stuff. Liquid glue sets more slowly, and twenty-four hours is usually as short a time as should be allowed. Warm, dry air assists the hardening. Under unfavorable conditions cold glue may not harden for several days. Rub wax, soap, or tallow on any part which must not be stuck by the surplus glue, as in the case of a panel (see page 167).

In gluing pieces where the surface is to be finally planed, glue first and plane afterwards, taking care to have the grain of both pieces run in the same direction if possible. The best way is to glue up the rough boards before they have been planed at all, and then have the whole planed as one piece, by machine, to the required thickness.

To glue the ends of pieces (end-wood) together, first size with thin glue to stop the pores, else the glue will be soaked up too quickly. Then, after allowing this coat to stand, smooth off to the wood and glue in the ordinary way. But glued joints in end-wood are to be avoided.

It is easier to make good joints in soft wood than in hard, for the former is more easily planed and fitted. When the grain of the pieces is similar and runs in the same direction the joint is usually best. Fine-grained and coarse-grained pieces do not glue together so firmly as pieces of similar fibre. It is best to do gluing either on horses or on a special cheap bench used for gluing only, to save the regular work bench. A great deal of glued work comes apart sooner or later. Remember that wood changes shape with the heat, cold, and moisture.

Wide pieces of very thin stock, as veneers, can be successfully glued flatways, with the grain of the different pieces running at right angles, as is seen in the prepared chair-seats made of layers of veneering, but when the stock has any considerable thickness this cannot be done with safety, as the expansion and contraction will cause breaking or splitting. It is not necessary, however, for the grain of two pieces to be exactly parallel.

In gluing two pieces to make a thicker one, as in Fig. 511, where warping would be very undesirable, the rear piece can be turned slightly as in Fig. 512, and this difference in direction of the grain will often help much to prevent warping.

Although two pieces properly glued together are stronger than a single piece, glue is apt to deteriorate. It is safer to use a

whole piece where you can, except where, to prevent warping, it may be better to build up the desired shape of pieces selected for the purpose. It is safest to place no reliance upon glue where the work is to be exposed to dampness or to the weather.

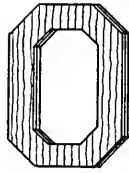


Fig. 511

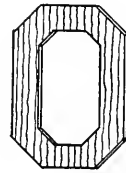
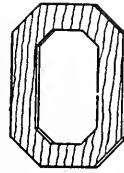


Fig. 512

145. Hardware Fittings.—It is well to have the hardware on hand, or selected, when laying out a piece of work.

146. Hinge-fitting.—Common hinges, as in Fig. 513, look neatest when narrower than the thickness of the stock (unless the

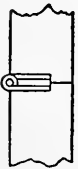


Fig. 513

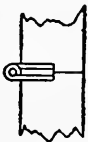


Fig. 514

latter is quite thin), so as not to extend across the edge, and should be sunk in the wood, one half in each of the parts to be hinged. In the case of a box, Fig. 643, for example, place the lid exactly in position (shut), and mark with a knife directly from each hinge, on both box and cover at the same time, the points from which to lay out the recesses for the hinges. Remove the

lid and with knife or square and gauge outline on box and lid the recess in which the hinge is to fit, so that the centre of the pin of the hinge will be in line with the back of the box (Fig. 513), or sometimes a little outside (Fig. 514). Set the gauge for the width to be cut as in Fig. 515, gauging to the centre of the pin, and for the depth close the hinge until the flaps are parallel and gauge to the middle of the space (Fig. 516). A butt-gauge is made for such work. Re-

move the wood with the chisel. Cross cuts can be made first, as in Fig. 451, or notch as in Fig. 517, and then pare the wood to the line with the chisel. The router can be used in fitting hinges. Bore

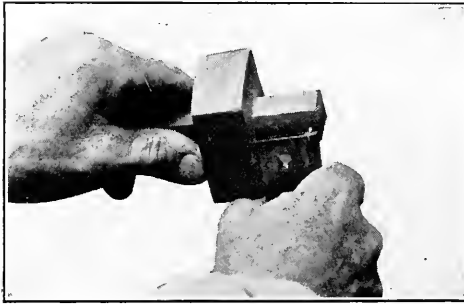


Fig. 515

with bradawl, drill, or bit, for the screws. Hold the hinges in place with two or three screws each and see whether the cover opens and shuts properly. If it does, put in the rest of the screws. If it does not, it is easier to make alterations before all the screws have been inserted. The position of the hinge can be changed a trifle, as it is screwed

in place, by boring the screw holes nearer the requisite edge of the hinge. Strap or surface hinges, T-hinges, or the like are placed so that the centre of the pin is exactly opposite the crack and then screwed on.

147. To Hinge or "Hang" a Door.—Put the door in place, fitting snugly against the frame or casing on the hinge side and on top. Mark with the knife the places for the hinges on both door and frame. The places for hinges can also be marked on

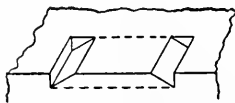


Fig. 517

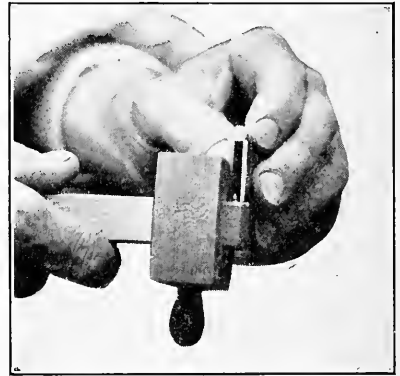


Fig. 516

a stick. Mark the outlines, on both door and frame as already described, cut the gains, and put on the hinges. If the door and the casing are not flush, allowance must be made for this in gauging for

one side of the hinge. Some door hinges or butts have the pin loose so that each half of the hinge can be fitted and screwed on separately and then the pin put in or withdrawn at will.

148. Locks.—Use locks of good quality. There are so many varieties, some to be screwed on the outside of the wood, others to be sunk in recesses cut in the side of the wood, others still to be let into mortises, chest-locks, door-locks, cupboard-locks, drawer-locks, etc., that it will be well to examine a well-fitted lock like the one you have to fit.

To fit a chest- or box-lock (not a mortise-lock), place it in position. Determine the place for the keyhole, and bore it. Mark around the part to be sunk in the wood, and cut it out with gouge and chisel. Trim the keyhole to a neat outline to conform to the shape of the key. When the lock has been screwed in place, put the “hasp,” or part to be fastened to the lid, into its place in the lock, where it will be when the chest is closed. Then shut the lid, and press slightly to make a mark to help show where to put the hasp, or transfer-paper can be put between the hasp and the wood, or blackened grease rubbed on the plate of the hasp. Sometimes the hasp has points to prick the wood. Outline the place for it with knife, square, and gauge, sink the plate into the lid flush with the surface, and screw it in place. A mortise-lock is fitted in a similar way, but let into a mortise.

To fit a common drawer-lock, determine the place for the keyhole and bore it. Hold the lock in position on the inside and with a pencil mark the outline of the box-part of the lock, which bears against the wood, and cut the recess for it. Put the lock into place and mark the outline of the outer plate on the inside of the drawer front and on the top edge. The thickness of the metal must be allowed for both on the inside and on the edge, that the surface of the plate may be flush with the wood. Pare away the wood carefully with the chisel to let the plate sink flush. When the keyhole is shaped, see if the lock works before screwing it on. Close the drawer and turn the key hard to raise the bolt (the top of which has been previously rubbed with blackened grease, such as can be scraped from an oilstone), which, pressing against the wood, will mark the place for the mortise into which it is to slide. Cut this mortise and the drawer can be locked.

149. Mirror-plates, screw-hooks, etc.—*Mirror-plates* are to fasten mirrors, cabinets, etc., to the wall, and should be sunk flush with the back-side of the wood (Fig. 518). They are usually of brass. The points for boring in fitting a *screw-hook* and *screw-eye* can be determined as suggested in Fig. 519. *L-* or *corner-irons* are often useful, as to strengthen a sled. *Casters*.—The way to put casters on is usually obvious. Use strong ones.

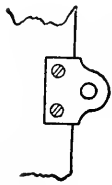


Fig. 518

Those with ferrules or outside sockets are serviceable for good work. A great variety of casters is made with ball bearings. *Escutcheons* are plates screwed, nailed, or set in holes, at keyholes, for ornament. They are commonly fastened with round-headed escutcheon pins or screws. Slip the key through the escutcheon, put it in the lock, and you can readily find the position for the escutcheon.

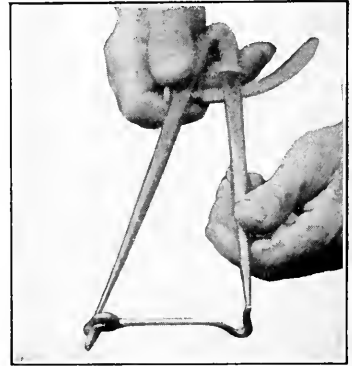


Fig. 519

150. Finishing.—Before applying any finishing coat to nice work, see that the surface of the wood has been thoroughly smoothed, and all hardened glue carefully removed. Try to take out any bruise or dent in the wood by wetting with warm water—or even cold—and rubbing down with sandpaper. The operation can be repeated until it has no further effect. If that is not sufficient, cover the bruise with wet blotting paper or several thicknesses of wet brown paper and apply a hot flatiron. This will often swell the compressed wood sufficiently to remove a large dent. Where a piece of wood has been taken out, as when a notch has been cut, this process can not be depended on.

Small holes or cracks can often be filled with wood-dust and glue. Put a daub of hot glue on the smooth end of a piece of wood of the same kind as the article, and with a sharp chisel, held nearly at right angles to the surface, scrape off fine wood-dust, which, mixed with the glue,

will form a paste with which the cracks can be more than filled. When hard, smooth off. Plaster of Paris (calcined plaster), mixed with shellac or thin hot glue, and colored if desired, can be used to fill cracks and holes. Mixed with water only, it is not so good. Shellac, in stick form, can be melted over a candle and dropped into holes or cracks.

A hole or defective place can often be filled best with a plug of wood, with the grain running the same way as that of the main piece. Make the plug and taper it slightly, so that when driven it will fit tightly and project above the surface (Fig. 520). Cut or trim the hole to fit the plug. Dip the plug in hot glue, and drive well in. If it is liable to be injured by the hammer, place a block on it and strike the block. When dry smooth off. In nice work the plug should match the color, texture, and grain of the rest of the wood. Round plugs can be bought or made with a cutter, to fit holes bored with the bits. Cracks at the end of a piece can often be plugged, and also secured against further splitting, by making a straight saw-kerf in the crack, into which a slip of wood can be fitted and glued.



Fig. 520

After the surface is in proper condition, decide whether the wood is to be left of the natural color (which always darkens more or less with exposure, and is darkened slightly by even the most transparent finish), or to be darkened or stained.

Staining.—Good wood of a handsome color, left to mellow with age, is, as a rule, preferable to stained wood, but staining is often desirable.

There are a number of ways of staining, dependent upon chemical processes carried on in the wood itself, which do not obscure the grain of the wood, but tend to make it more conspicuous. The surface can also be washed with some thin stain which colors the wood to some distance below the surface, so that it will take considerable bruising to expose its original color. This method sometimes enhances the

beauty of the grain. The poorest way to stain, but a common one with amateurs and in cheap work, is to cover the surface with colored varnish, "varnish stain," or colored shellac. Of course, no coating of color put on outside can be so durable as color imbedded in the substance of the wood, and scarring or injury to the coating exposes the original color beneath. Besides, the grain and character of the wood are obscured by a colored coating, and the work usually has a cheap, artificial appearance. To change the color entirely,—to make pine wood red or green, or cherry black,—you must use some chemical process, or apply a colored stain.

Before using stains, test them on planed and smoothed pieces of waste wood of the same kind as the article to be finished.

If you do not care about deepening the color greatly, one or two applications of linseed oil allowed to stand a week or two before finishing, will take off the raw, fresh look peculiar to recently cut wood.¹ To hasten the process requires something stronger than oil. If the work is of oak, shut it up for some time in a box or *tight* closet, with a dish of strong ammonia on the floor. A simpler way is to wash the work with ammonia, more than once if necessary. Have the room well ventilated, and do not inhale the fumes. Wetting the wood, however, tends to soften the glue, and also "raises the grain," which must be rubbed down with fine sandpaper before finishing. In case of quartered oak, if it is desired to make the "flashes" especially prominent they can be rubbed carefully with the finest sandpaper after staining.

To deepen the color of mahogany or cherry, wash with lime-water (a solution of common lime in water). Repeat the operation until the desired shade is obtained. This is cheap and effective and preserves the natural appearance of the wood. Clean out all cracks and corners thoroughly, for lime deposited on the surface will injure the

¹ Repeated applications of raw linseed oil at intervals of several days or weeks, with a light rubbing down with fine sandpaper before each oiling, will in time give a surface of beautiful color and soft lustre. But this takes too long for most people and a finish of oil alone is apt to collect dust.

appearance of the work when finished. Getting the work so wet is an objection. It must be thoroughly dry and be sandpapered before finishing. To get a darker shade, use a solution of bichromate of potash in water. Dragon's blood in alcohol gives a color similar to mahogany. Vandyke brown or burnt umber can be added. Alkanet root in raw linseed oil will give a warm and mellow hue to mahogany or cherry.

Any pigment or coloring substance that can be dissolved in water, or even mechanically mixed with it, can be used for staining. Such stains raise the grain of the wood, so that the surface has to be sandpapered after it is dry. To lessen this trouble it is sometimes dampened with water and, after drying, sandpapered before applying the stain. Water stains are as a rule not so good for nice work as turpentine, oil, or alcohol stains, but they are inexpensive and do well for much work. For a brown stain a little extract of logwood dissolved in hot water and applied hot can be used. For black or ebonizing, apply solution of logwood and wash with vinegar in which iron filings have been soaked, or a black aniline dye in ammonia or alcohol can be used.

Oil stains are easy to apply, and do not raise the grain of the wood much. They should be wiped off and, after thoroughly drying, the surface sandpapered with "00" sandpaper.

Many excellent stains are made with alcohol. These penetrate the wood well.

Turpentine stains are good for ordinary work. Any pigment or coloring substance which can be dissolved in turpentine, or mechanically mixed with it can be used. Turpentine penetrates the wood well and dries quickly. Mix pigment of the desired color with a little oil, and a very little Japan, and thin with turpentine. For black work, ivory black or bone black, thinned with turpentine, is superior to lamp black, but the latter can be used. After staining, rub with a soft cloth before finishing. A great variety of prepared stains, many of which are excellent, can be bought ready for use.

Fillers.—After the matter of color has been attended to, if the

wood is of coarse open grain, as oak or chestnut, the pores should be filled with some "filler." This can be bought in the form of paste (different colors—either light or dark), and used according to the directions on the can. Rub the filler into the wood thoroughly, let it stand until it begins to set, or stiffen, and then rub it off with a bit of burlap or any coarse material, *across the grain* (lest you wipe it out of the pores). After it has become hard enough, sandpaper carefully until no filler remains on the surface. A second coat can be used if necessary. The filler can be as light as the wood, or often, as in oak, the figure of the grain can be brought out best by using a filler darker than the wood. Clean off the filler thoroughly, using a blunt tool to clean out the angles and corners, or the finished surface will have a cloudy appearance. The rags used should be burned. Liquid fillers can be put on with a brush, allowed to dry for a day, and then rubbed down with fine sandpaper. Thin shellac makes an excellent filler for fine-grained wood.

Use of shellac, wax, varnish, etc.—Final finishing coats may be applied in various ways. For furniture and articles for indoor use there is no better way for the beginner than to use shellac or wax. Shellac forms a hard and durable coating which can be given a high polish or a soft lustre and dull finish. The surface dries quickly and the coat hardens more rapidly than varnish.¹ A good simple finish is to oil the wood (raw linseed oil slightly thinned with turpentine), let it dry thoroughly, and then apply shellac.

Shellac is cut (dissolved) in alcohol, and can be bought prepared, but to cut it yourself lessens the chance of adulteration. Orange shellac will do for most work. Into an open-mouthed bottle put some of the shellac (which comes in flakes and looks somewhat like glue) and pour over it enough grain alcohol (95 per cent. grade) to somewhat more than cover it. Cork the bottle and leave in a warm place until the shellac is cut. Shaking will hasten the process. Wood alcohol can be used and is cheaper, but

¹ Shellac is, strictly speaking, a kind of varnish, but it is so different from many kinds of varnish in common use that it is usually spoken of as shellac, in distinction from what is popularly known as varnish.

work done with it is not so good. It is a deadly poison, and on account of the fumes it is best not to use it long in a closed room. Denatured alcohol is much better than wood alcohol, but is also poisonous. If the tawny tint of orange shellac is objectionable, white (bleached) shellac can be used. It is well to buy this already prepared. It is a little harder to use than the colored kind. Shellac keeps better in glass than in tin.

Use a flat bristle brush and not a soft camel's-hair brush, unless for the last coat. One inch to two inches in width is suitable for small work. For large surfaces, a larger brush is better. After using, clean the brush thoroughly with alcohol.

The shellac should be quite thin, and should flow freely from the brush. It is better to have it too thin than too thick. Three or four thin coats give a much better result than two coats of thick, gummy shellac. Never thin it with anything but alcohol. Keep the bottle corked to prevent evaporation and to keep out dust.

Shellac in a warm, dry place, free from dust,—never where it is cold and damp; but do not leave the work close to a hot stove or in the hot rays of the sun, or it may blister. Before beginning to shellac see that the work is free from dust. Pour a little shellac into a small dish. Before applying to the wood, wipe the surplus shellac from the brush on the edge of the dish, or better, on a wire stretched across it. Face the light, so that you can see what you are doing, and lay on the shellac as evenly and smoothly as possible, working from the top or from one end or side, and with the grain.¹ Work lengthways



Fig. 521

¹ In shellacking doors or panel-work, first shellac the panels, then the rails, and finally the stiles (see Fig. 480), because daubs or "runs" can be wiped off and covered better when you thus follow the construction of the work.

(as in Fig. 521) rather than across the surface. It is better to have the surface in a horizontal position when possible, but if that cannot be arranged, begin at the upper part and work downward. Do not apply the brush at first quite at the edge of the surface, lest the shellac collect too thickly there. Work quickly and carefully. Begin and end each stroke of the brush gradually and lightly, so as to avoid a "lap" where the strokes meet. If surplus shellac collects and spreads over any part of the surface, wipe the brush quickly, as dry as you can, and lightly and quickly take up the surplus liquid; but do not work over the coat after it has begun to set, or try to patch up spots. Lay it on as well as you can and let it go. You will know how to do better the next time.

Give each coat plenty of time to harden before applying another,—twenty-four hours is not too long. The outer coat hinders the drying of the shellac underneath, by keeping the air from it. Shellac dries very quickly to the touch, but does not get really hard for some time. If there are holes, cracks, or defects not yet filled up, they can be filled with wax colored to match the wood. Melt the wax and add a small quantity of whatever dry color—burnt umber, for instance—may be required. Another way is to hold a hot iron close to a piece of shellac directly over the hole, which will be filled with the melted shellac. This is better for dark-colored wood than for light. The surplus can be carefully pared off after it is hard. Use putty for painted work only.

When the first coat is hard, skim over the surface with very fine sandpaper (00) to remove any roughness, and apply a second coat. This is sometimes sufficient. If not, sandpaper and shellac again, and a fourth time if necessary. When you have a sufficient "body" of shellac on the wood, you can much improve the surface by rubbing it down with powdered pumice and oil, which will remove the "shiny" effect and leave a softer surface. Take a bit of felt or haircloth, wet it with thin oil (kerosene, or petroleum or linseed oil thinned with turpentine), take up a little of the pumice on the felt, and carefully rub over the surface, with the grain, renewing the oil and pumice

as may be needed, or they can be sprinkled on the work. Pumice can be sprinkled on from a can with perforated top. Rub evenly and not too long on any one spot, for it will be almost impossible to repair the damage if you rub through to the wood. Wipe off thoroughly with a soft cloth.¹

This process is sufficient for ordinary work. For some work simply rubbing down with the finest sandpaper wet with oil is enough. The general principle is that as the surface becomes finer, finer rubbing material should be used. Pumice as well as sandpaper is of different grades, but the distinction concerns the expert finisher only.

In using sandpaper for rubbing down nice work, split it by removing the outer layer of paper, which by leaving the sanded layer thin and pliable will make it less likely to scratch or rub through the finish. A handful of tightly squeezed curled hair, or a piece of haircloth, can be used instead of felt or sandpaper. If the shellac has collected too thickly at the edges or corners, the surplus can sometimes be taken off with the scraper; but this is hard to do without scraping too much.

The general directions given for shellacking also apply to the use of varnish, but varnishing is in some respects harder for the beginner to do well. When a good article is to be varnished it is best to give it a coat of thin shellac first. This tends to prevent the wood being darkened by the varnish. Varnishing should be done in a warm room, free from dust, and the surface of the wood should be clean. There are many kinds of varnish and for many purposes. The final coat can be rubbed down with pumice or tripoli and water. Rotten-stone used with oil (petroleum is good) is excellent for giving a soft polish. If varnish is to be used over shellac, as in case of a boat, simply sandpaper the shellac and do not rub it with pumice and oil.

French polishing is often attempted by the beginner, but should be learned from a practical polisher. A wad or pad of woollen cloth or cotton wool is made, and on this is poured thin shellac, adding whatever alcohol may be necessary. This wet pad is then covered with a piece of clean linen, a drop of linseed oil put on the outside to prevent the shellac from sticking, and the pad quickly passed over the surface with a circular motion, or with longer strokes in the form of the figure 8. After doing this for a while a

¹ Fine sawdust of soft wood is good for removing oil and cleaning the surface, following with a soft cloth.

very thin coat will have been deposited. This is allowed to dry for a short time, when the process is repeated, until a sufficient body of the polished finish has been formed. The details vary with different finishers. It is quite easy to polish a small flat surface, the arm of a chair, for example; but it is hard for a beginner successfully to polish a large flat surface, like a table-top. A coating of shellac is usually put on in the ordinary way first and skimmed over with sandpaper, to save labor in the polishing process.

Before refinishing old work it should, if the surface is in bad condition, be scraped down to the wood, using the scraper and finishing with sandpaper. A chisel (used like a scraper) is sometimes good to remove a thick body of old varnish. If the surface does not need scraping, it should be cleaned, either by washing with soapsuds or by scrubbing with the finest split sandpaper, using oil. The work must be wiped off clean and be perfectly dry before applying a new coat. Pumice can be used, as already described. A stiff brush, such as a nail- or tooth-brush, is excellent for cleaning out corners and carved work. A piece of haircloth can be tightly rolled, wound with string, and the end used as a brush.

For simply brightening and cleaning furniture, a mixture of equal parts of linseed oil and turpentine with a very small quantity of Japan is excellent. It should be well rubbed in and carefully cleaned off. This will make scratches and bruises less conspicuous, and the article will look fresher for a time; but it is not a substitute for refinishing.

An old-fashioned way to finish, but still in vogue, is to apply a mixture of turpentine and beeswax, which can be bought in cans, ready for use, rubbing it long and thoroughly. To prepare it, melt beeswax in a can or saucepan and, when taken from the stove, pour in enough turpentine to make it the consistency of paste. The surface of the wood must be very smooth for successfully finishing with wax. Apply with a brush or cloth, rub in well, and clean off the excess, scrubbing the work thoroughly. This makes a beautiful finish, soft and lustrous. It shows spots, however, and though it is easily applied, requires renewing and rubbing to be kept in good condition. A thin coat of shellac rubbed down with sandpaper when dry makes an excellent filler before applying a wax finish to coarse-grained wood.

Painting.—Use the best paint throughout for good work. It

is particularly important that the first or "priming" coat should be of good quality. Be sure that wood is thoroughly seasoned before painting, else it will be liable to decay, or the paint to peel, or both. See that the surface is free from dirt. Knots or streaks of resinous or pitchy matter should have a coat or two of shellac, to "kill" them and prevent colored spots showing later. Try to mix only enough paint for the coat you are about to put on.

The first coat should be thin to soak into the surface, for the oil in the paint will be quickly drawn into the wood. If thick the paint will not be sufficiently absorbed, but the oil will soak in quickly, leaving too much of the pigment on the outside. Work the first coat well into the wood. Take up but little paint on the brush. It is well to have a wire stretched across the top of the pot to draw the brush over to remove any excess of paint.¹ Begin the painting at the highest part of the work, or the part farthest from you, to prevent spattering or dripping on the freshly covered surface. Begin, also, at one end or side of a surface, and work toward the other end or side. Draw the brush back and forth both ways to spread the paint as evenly and smoothly as possible. Try not to leave any part of a surface until another time, or it will be likely to show a "lap." This does not matter in the priming, but will show plainly in the later coats. If you cannot cover the work entirely at one time, leave off where there is some natural line or break in the work.

When the first coat is thoroughly dry, carefully putty the holes and cracks. Never use putty until after one coat of paint has been applied and dried, for the fresh wood will quickly absorb the oil from the putty, leaving it dry and crumbly; while if a coat of paint has been put on first and dried, the pores of the wood will be stopped and most of the oil will remain and harden in the putty.

Paint with the grain of the wood, or the long way of the work, using a large brush for large surfaces and finishing all corners, mouldings, and edges with a small brush. In doors or panel-work, proceed as directed on page 193. Paint joints in outside work, tenons and

¹ It is not well to wipe brushes on the sharp edge of a tin can, as it injures the bristles.

mortises, shoulders, etc., before putting together, with good white lead. It is well to do this in all work exposed to water and the weather, as in buildings and boats, for the wood quickly decays at the joints and seams because dampness collects there.

Prepared liquid paints are the simplest, handiest, and cleanest for the beginner, and (if of the best quality) do very well for most purposes. For work exposed to the weather there is probably no better way than to use the best white lead and oil, and color if desired.¹ These ingredients can be mixed easily and form a durable and economical paint. The white lead can be bought ground in the form of paste ready to be thinned with oil, or, for inside work, with turpentine. The prepared paints of any color can also be bought in the form of paste, to be thinned when used.

The simplest way to buy colored paints is in liquid form or mixed in oil, to be thinned for use. Paint can easily be colored with various dry colors, in the form of powder. It takes but very little of most colors. First mix the color with a little oil or turpentine. Test the shade on a piece of wood. In making paint darker, especially when tinting white paint, be careful to add but very little of the darker pigment at first, and be sure that it is thoroughly mixed, for it is easy to get in too much.

Raw linseed oil is required with which to mix the lead and thin it to the proper consistency, and also sometimes to thin the prepared paints. Turpentine is also used for thinning, but detracts from the durability if used lavishly. It is not customary to use it for outside work, unless to thin the first coat. It is commonly used for inside painting and causes the paint to work more freely and smoothly from the brush and to dry more quickly. It gives the dull, soft, or "dead" appearance often desired in inside work.

It is usual to add a "dryer," as Japan, to paint to hasten the drying. Use very little dryer, as much of it is injurious to the durability of the paint. Add it just before the paint is to be used and only to the quantity to be used at the time. Zinc paints are usually considered inferior. Red lead is commonly used to paint iron and is very durable for that purpose. Black Japan varnish and asphaltum are often used. Iron must be dry, and it is better to have it warm.

¹This seems to be a common opinion among experienced men. There are, however, many painters of experience who prefer the prepared liquid paint.

When leaving paint, pour a thin layer of linseed oil over the top to exclude the air and keep the paint from hardening. If to be used again soon, it will do to leave the brush in the paint, but not standing or resting on the bottom of the can, as that tends to bend the ends of the bristles. Fasten a wire hook on the handle and hang the brush so that the bristles will be covered by the paint, but will not touch the bottom. If the brush is not to be used again for some time it should be cleaned with kerosene or turpentine and put away. Wash out all the paint, as a little left between the bristles will sometimes stick them together so as to ruin the brush. Brushes which are in use can be hung from the handles in a can partially filled with oil, or even water, the can being kept covered.

The first coat especially should be given plenty of time to dry, for the durability of the painting depends much upon it, and each succeeding coat should also be dry and hard before applying another, for excluding the air from an under layer causes it to dry much more slowly than if left exposed. Thus the outside surface may seem to be dry and hard while the paint underneath remains comparatively soft.

Warm canvas before painting it and where it is laid on wood as for a floor, roof, or deck, lay it in a heavy coating of white lead. Paint dries more quickly in a warm and dry atmosphere than where it is cold and damp.

Sandpaper nice inside work after the first coat and between successive coats. Pumice can be used for old inside work to be repainted. Steel wool can be used to clean off old paint. Keep a rag with you when painting, to wipe off any spattering, for it is not easy to remove paint after it is hard. Use kerosene to take fresh paint from the hands, as it is better for the hands than turpentine.

Brushes.—It is essential to have a brush for cleaning off work before finishing. A sash brush is good. Small flat bristle brushes are usually better than large round ones for shellac, varnish, and paint, except for very coarse work. From one to two inches wide is usually large enough, although for a large surface a large brush does better work and saves time. For small or narrow surfaces, the

brushes used for "drawing" sashes are good, and for drawing lines use "pencil" brushes.

Rinse brushes carefully after using,—shellac brushes in alcohol (nothing else will cut shellac), varnish brushes in turpentine, and paint brushes in turpentine or kerosene. The alcohol used for rinsing can be saved and used to thin shellac. If paint or varnish brushes are not to be used again soon they should be thoroughly washed in strong soapsuds and carefully smoothed into shape before laying away. Before using, they can be rinsed clean. Vessels can be bought with covers arranged to protect both the varnish and the brush.

Putty.—Common putty is a mixture of linseed oil and whiting of about the consistency of dough. White lead worked in with the whiting makes it far superior. To color putty, stir the coloring matter in a little oil and then work and knead it into the putty until the whole is colored. Keep putty under water or in a tight vessel, not in paper. If too soft wrap in paper and the surplus oil will soon be absorbed. Use a square-bladed *puttyknife* for flat surfaces.

151. Glazing.—An old chisel is good to clean off old putty before setting glass in old frames. On new work, see that the rabbet or shoulder where the putty is to go is primed with lead paint before putting on the putty; and before setting the glass, spread a layer of putty on the rabbet for it to rest on. "Glazier's points" are best to hold the glass in place under the putty.

Common glass in furniture, as in bookcase doors, can be fastened in place with small strips, not pressed too tightly against it. Strips of plain moulding are good. See also page 253.

APPENDIX

WOOD

THE rings, or circular lines, on the end of a piece of wood (Fig. 523) are called the *annual rings*,¹ and each marks a new layer of wood added to the tree, for the trees used for woodworking grow by adding layers of wood on the outside. Notice that the wood nearest the bark, known as the *sapwood*, usually looks different from the inner wood, called the *heart* (Fig. 523.) In some trees there are rays, radiating from the centre, and known as the *medullary rays* (Figs. 523 and 524), because they spring from the pith (Latin, *medulla*). Sometimes these rays are not noticeable. The layers of wood forming the annual rings also appear in

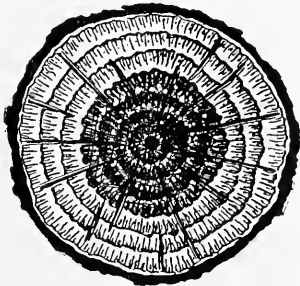


Fig. 523

what is called the “grain” on the surface of a piece of wood cut lengthways (Fig. 524). At the ends of timber, too, after seasoning has begun, cracks can be seen radiating from the centre, showing the natural lines of cleavage or separation.

Green wood contains much water, the quantity depending

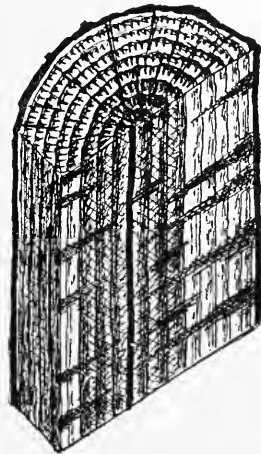


Fig. 524

upon the kind of tree, the season of the year, etc. The more water a green log contains, the more it will shrink in drying. The sapwood shrinks more than the heart because it contains more water; and shrinks faster because,

¹ In the common trees of temperate climes one layer is added each year.

being on the outside, it is more exposed. The log shrinks most in the line of the annual rings, that is, *around* the tree. It shrinks much less in the line of the medullary rays, that is, *across* the tree. Shrinkage lengthways is too slight to be considered¹ (Fig. 525).

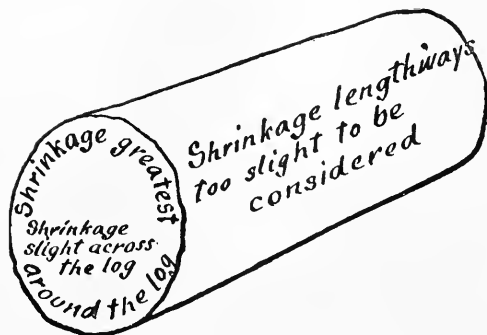


Fig. 525

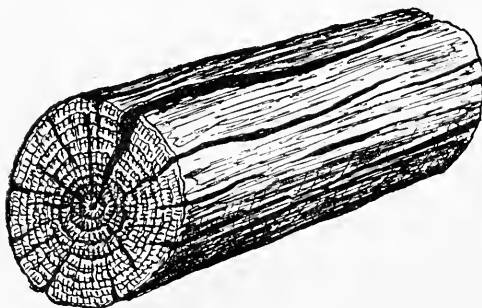


Fig. 526

The result of this unequal shrinking is that the log tends to crack open, at the circumference (Fig. 526), the cracks running in toward the centre, in the line of the medullary rays.

Thus the way the log is sawed is important. If it be halved or quartered, so that the inner parts are exposed, the drying goes on more uniformly, the cracking is not so bad, and the parts of the log will shrink somewhat as shown in Figs. 527 and 528.

The beams, joists, and planks, or boards cut from a log have the same tendency to shrink unevenly that is found in the log itself. This causes them to be irregular in shape and to curl or warp more or less, according to the part of the log from which they are taken. Thus a piece cut from the centre of a log holds its shape better than a piece cut from one side (Fig. 529).

When a log is sawed into boards or planks (Fig. 530) the middle board shrinks but little in width and in thickness at the centre, but becomes thinner toward the edges. It does not curl, because it is cut through the centre of the log and has no more tendency to curl one way than the other.

¹ Although the shrinkage lengthways is not usually noticeable, it shows slightly when pieces become sprung or bowed lengthways, as can be seen in boards which have been left free to bend while seasoning.

The outside board shrinks least in thickness and most in width, and all, except the middle one, shrink differently on one side from the other. They become convex toward the pith, or heart, and concave toward the outside. Different kinds of wood shrink and warp to different degrees. Examine the stock in a lumber-yard.

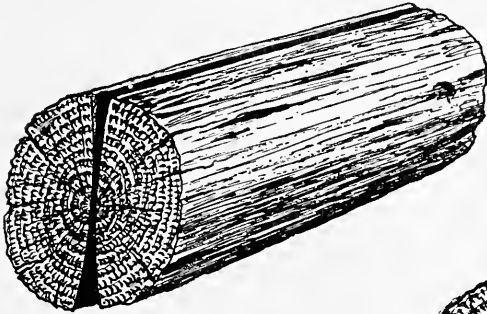


Fig. 527

To get the most from a log in the form of boards or plank, it is sawed in the simple way just shown (Fig. 531). This is the usual way for ordinary purposes. The central boards will be good and the outer ones inferior,¹ as just shown (Fig. 530), but for common work all can generally be used. The highly figured grain² often seen in

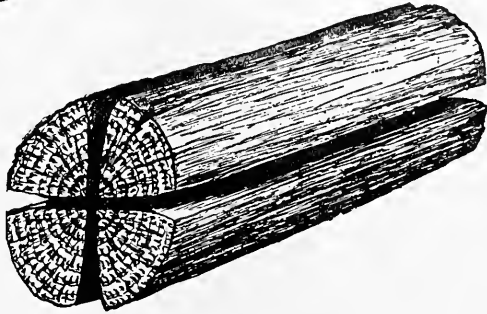


Fig. 528

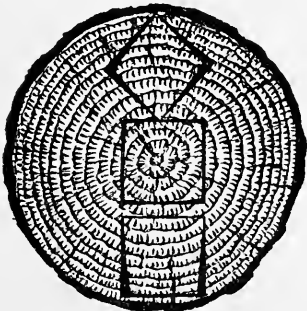


Fig. 529

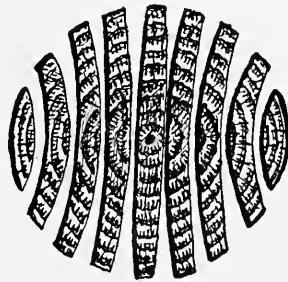


Fig. 530

¹In addition to the curling, the outer boards will be poorer because they contain a greater proportion of sapwood, which is usually inferior to the heartwood.

²By this is not meant the figures or flashes shown by the medullary rays, or "silver

oak, ash, chestnut, etc., results from sawing the log in this way (Fig. 531), and is most marked in the outer boards (Fig. 532), because the annual rings are cut more obliquely than in those at or near the centre.

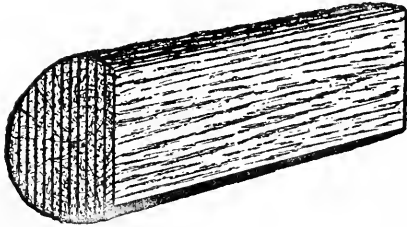


Fig. 531

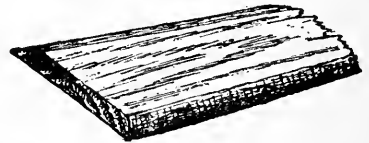


Fig. 532

To get the beautiful figure formed when the medullary rays show on the surface of a board, as in quartered oak, the log should be cut in the direction of the radii, that is, along the lines of the medullary rays (Fig. 533). The nearer a board is cut to the radial line the more richly the figure

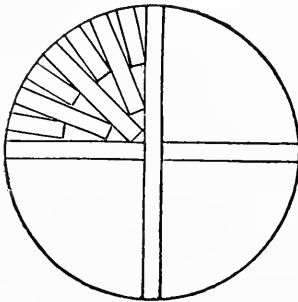


Fig. 533

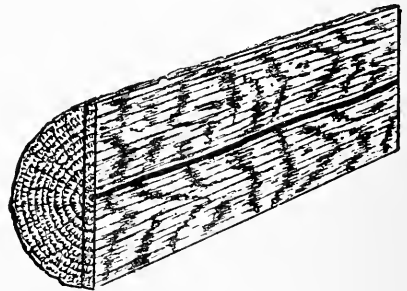


Fig. 534

of the medullary rays will be shown, as in Fig. 534. This method of sawing costs more than the first method as it takes more labor and wastes more wood. The wide board shown in Fig. 534 and either of those in Fig. 535 are examples.

To obtain boards that will shrink the least in width and remain as true as possible, the log should be sawed on the radial lines as just shown.

grain" seen in *quartered* oak and some other woods, but the figure of the grain without the medullary rays, as seen in *plain* oak, etc.

Wood shrinks but little in the direction of the radii, as just shown, and boards thus sawed will be alike on both sides as regards heartwood, sapwood, etc., and, therefore, have the least tendency to change of shape.¹ Various methods of radial sawing, or in which part of the boards are so cut, are shown in Figs. 533 and 539, Figs. 536, 537, 538, and 539 showing the log quartered and different ways of sawing into boards.

Split or rift stock is stronger than sawed. To be especially tough and durable, as for an axe handle or a stout pin, the wood should be split out, unless it is very straight-grained, because

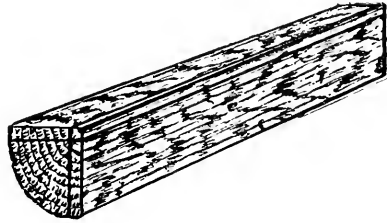


Fig. 535

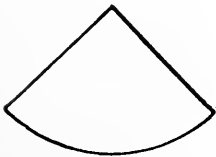


Fig. 536

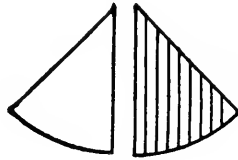


Fig. 537

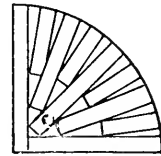


Fig. 538

the splitting is sure to be in the line of the fibres, thus avoiding "cross-grain."

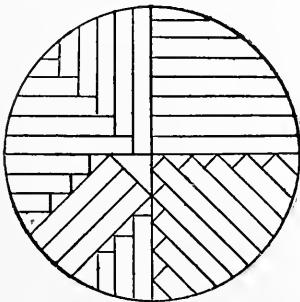


Fig. 539

Well-seasoned wood is necessary for nice work, to prevent cracks, warping, opened joints, and often the entire ruin of the article. It is not easy for the beginner to decide whether stock is properly seasoned, except in case of very green wood, which is of course wet and soggy. Much stock sold as dry is not thoroughly seasoned and care should be taken in buying. Two ways of drying wood are common. One is the old-fashioned method (usually known as *seasoning*, or *air-drying*) in which

¹ Although boards cut through or near the middle are, as a rule, the best, when they contain the pith they are sometimes valueless in the centre, as when, in the case of an old tree, decay has begun at that point.

the wood is gradually seasoned by exposure to the air (but protected from the weather).¹ The second way is that ordinarily used. To save time and money, the wood is dried in a closed room by steam or other heat (called *kiln-drying*) much more quickly than by the old way.

By the natural air-drying process the moisture slowly works out to the surface and evaporates, until the wood is seasoned, though never absolutely dry, and the stock is firmer, more elastic, and less affected by heat and cold, moisture and dryness, than if kiln-dried. The latter process tends to dry the outside and ends of the lumber too fast for the inside. It certainly lessens the elasticity of the wood and weakens its strength. Unless it is at once protected from dampness in some way, it will reabsorb moisture until it gets into a more natural condition²; but that will not fully restore its elasticity.

Hard woods³ should first be air-dried for some months at least, before being put into a kiln. The kiln-drying "takes the life out of the wood." Lumber left for years to season naturally "stands" better than if kiln-dried. The gain by kiln-drying, in time and money, is, therefore, offset by impairment of the quality of the wood. Kiln-dried stock is, however, in most cases the only sufficiently seasoned kind available. Get it from a slow-drying kiln if possible.

There are various other methods of seasoning. Wood is sometimes soaked in water before being seasoned. This helps remove the soluble

¹ The time it takes to season depends on the kind of wood, its shape and size, the condition of the atmosphere, and various circumstances. Oak, for example, takes longer than pine. For some rough work there is no advantage in seasoning at all. For much common work one or two years is enough for some kinds and sizes of wood; for a nicer grade of work two or three years is none too much, while for very nice indoor work even more time will be beneficial. There is little danger of its being kept too long. It never will get perfectly dry, as there will always be from ten to twenty per cent. of moisture left, according to the temperature and the humidity of the atmosphere. Whether it is dry enough depends on what it is to be used for.

² Recent investigation shows that the very fibre or substance of the wood itself imbibes and holds water tenaciously, in addition to that popularly understood to be contained in the pores of the wood.

³ The kinds of wood commonly used are known as either *hard* or *soft*, the former from trees with broad leaves, as the oak, the latter from coniferous or needle-leaved trees, as the white-pine. This distinction is somewhat puzzling in some cases, for the common white-wood of the hardwood class is softer and easier to work than hard pine of the softwood class, but the distinction is based on botanical reasons.

elements of the sap, but it is doubtful whether the process improves the quality of the wood. Smoking and steaming are also resorted to. Small pieces can readily be smoked, which hardens the wood and adds to its durability. Care must be taken not to burn, scorch, or crack the wood.

Even if wood has been well seasoned it is best, before putting it into nice work, to cut it approximately to shape, and leave it in a dry place for some time for a final seasoning, particularly in the case of thick stock. Do this with kiln-dried stock fresh from the dry-house. Let it have time to get into harmony with the atmosphere. Strips cut from wide stock should for nice work be got out in advance and larger than required, to allow for springing and change of shape. Whenever wood has been exposed to damp air, as in a wet shed or cellar, let it stand in the warm shop a while before using it for nice work.

For seasoning, the stock is piled to allow the air to circulate around and between the pieces. A common way is to pile as in Fig. 540. The

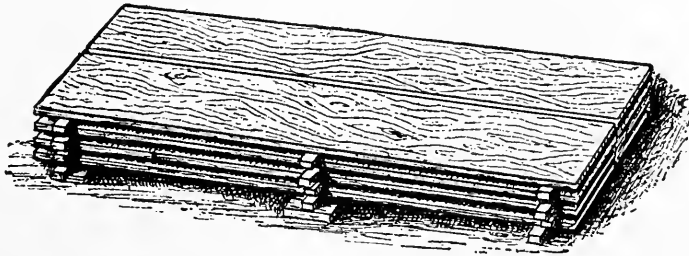


Fig. 540

sticks between the layers should be placed directly over one another, so that the lumber will lie straight, else the weight of the pile will make the boards crooked. If exposed to sun and weather pile with the heart side up. Stock is sometimes stacked upright, and small pieces are occasionally hung up, for such nice work as billiard cues and bows.

Seasoned wood is lighter in weight than green, dryer to the touch, usually has a different odor, cuts differently when you whittle it (the piece you whittle off breaks differently), and it shows a difference when you saw it. These differences cannot be accurately described and must be learned by actual work. It is not always easy even for an experienced person to determine the degree of seasoning in some cases. One test is to rap the

boards sharply with a hammer. A green board and a dry one of the same kind will have a different vibration and give out a different sound. Much can be learned about the character and condition of lumber by sawing or planing or whittling a piece. This is a good test for dryness, toughness, and elasticity (which you can tell about by breaking the shavings).¹

Weather-dried timber is usually somewhat darkened from exposure, whereas kiln-drying lightens the color of some woods. Stock with a bright lustrous appearance and of dark hue is generally superior to that of a lighter color and duller appearance, but such characteristics depend much upon the kind of wood. Green wood is tougher than seasoned, but the latter is more elastic. Applying moisture with heat to seasoned wood brings it back, to a certain extent, to its original condition, and makes it tougher for the time being, hence the process of bending wood by the application of steam or hot water.

Boards and planks are not always sawed to a uniform thickness, and rough stock should be examined for this defect before buying. For plain work avoid "cross-grained" stock; and for nice work avoid that which has knots, since it is harder to work and to smooth, is not so strong, and does not hold its shape so well. Sometimes cross-grained stock is desirable, however, on account of the beautiful figure of the grain, as in mahogany for furniture. Reject wood which smells musty, or has rusty-looking spots, which are signs of decay, or of the attack of fungi, which may spread.

Reject crooked stock. The worst form is winding or twisting. (See page 18.) Even a slight winding may make much trouble in nice work. Look particularly for this defect. Warped or curled stock with the surface rounded or hollowed is also bad. This defect can be detected by the eye or a straight stick. Stock is sometimes sprung or bent lengthways, or wavy (Fig. 541), or both, often due to careless "sticking."

Use caution about stock badly checked or cracked at the ends, where the

¹ There is a distinction between the elasticity needed for such purposes as a bow or spring-board, and the toughness required for the ribs of a canoe, or the wattles of a basket. In the former case the material must not merely bend without breaking, but must spring back (or nearly so) to its former shape when released, as with lancewood or white ash; while in the latter case it must bend without breaking but is not required to spring back to its original form, as with many green sticks which can be easily bent but have not much elasticity. These two qualities are found combined in varying degrees in all woods. Elastic wood must necessarily have toughness up to the breaking point, but tough wood may have but little elasticity.

drying takes place most rapidly. The ends of valuable boards and planks are sometimes painted or cleated, which in a measure prevents this result. Occasionally, when a cleat is removed a crack will suddenly open and even split the board. Freshly cut ends in dry stock are sometimes sized with glue to prevent checking. In some kinds of wood it is impossible to tell before the stock is cut where cracks and splits end. In mahogany, for example, they sometimes are found to extend, or develop, several feet beyond where they appear to stop. Avoid sapwood, because it is usually inferior. In the case of elm, hickory, and young ash the sapwood is, however, sometimes considered superior to the heartwood.¹



Fig. 541

When buying, select the stock yourself. It is better to do this for nice work even if an extra charge be made. The annual rings at the ends of the boards, the sapwood (when visible), the grain, etc., will show from what part of the log the pieces were sawed.

Do not buy thick stock with the idea of sawing it into thinner pieces (unless necessary), for you cannot be sure that these will be so true as the original stock. Suddenly exposing the middle of a piece of wood to the air often entirely alters the shape. If you want to use boards for good work buy those which have seasoned as boards, instead of splitting up thicker lumber; and always try to treat both sides of a board alike. If you have an inch board planed down by machine to three eighths of an inch, for instance, have it planed equally, as nearly as may be, from both sides. It is common to simply smooth off, or "surface" one side, and then plane the board down on the other side, often making it warp badly at once.

Carefully pile and "stick" the stock on hand (Fig. 540), as it will tend

¹As a rule, wood from a young tree is tougher than that from an old one; the best, hardest, and strongest in the young tree usually being nearest the heart, while in an old tree the heart having begun to deteriorate is softer and not so good as the more recently formed growths nearer the sapwood. If the tree is in its prime the wood is more uniformly hard throughout. The sapwood, as a rule, is tougher than the heartwood, though usually inferior in other respects; and timber light in weight is sometimes tougher than heavy wood, though the latter is often stronger and more durable and preferable for many purposes. The growth and structure of trees is a very complex matter, however, and the diversities almost infinite.

to keep the pieces straight and true. Never lay good boards down flat directly upon one another unless they are thoroughly seasoned. The latter is the best of all ways, however, to keep a pile of stock once thoroughly seasoned. The top board will warp. Do not lay a single board of nice stock flat on its side on the bench or floor. Keep short pieces, which it is not worth while to "stick," standing on end where they will be equally exposed on all sides to heat and cold, moisture and dryness.

Stock for nice work must be kept and used in a dry place, or when the work is removed later to a dry place it will shrink or warp, and perhaps be ruined.

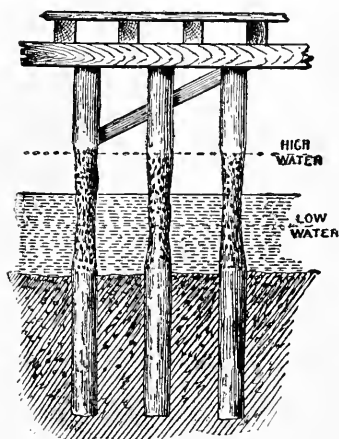


Fig. 542

152. Decay and Preservation.—Timber decays fastest when alternately wet and dry, as in the piles of a wharf, fence-posts, and the like, or when exposed to a hot, moist, close atmosphere, as the sills and floor-timbers over some damp and unventilated cellar. Fig. 542 shows the decay caused by alternate wetness and dryness, while the parts above and below are still sound. Wood lasts the best when kept dry and well ventilated. When kept constantly wet it is somewhat softened, and will not resist so much, but does not decay. Thorough seasoning, protection from the sun and rain, and free circulation of air are the essentials to the preservation of timber.¹

¹ The conditions best for the preservation of the wood, as referred to above, are also the least favorable for the attacks of animal life and of fungi. As soon as the tree has been felled and dies, decomposition begins, as in all organic bodies, and sooner or later will totally destroy the wood. The woody fibre itself will last for ages, but some of the substances involved in the growth soon decay. The sap is liable to ferment, shown by a bluish tint, and decay sets in. Fungi may fasten upon the wood. Worms and insects may also attack it, preferring that which is richest in sap. Decay originates chiefly in the decomposition of the sap (although in living trees past their prime decay begins in the heartwood while the sapwood is sound), so the more the sap can be got rid of the better. There are, however, some substances found in various trees, aside from those elements especially required for their growth, which render the wood more durable, such as tannic acid, which abounds in oak and a number of trees, particularly in the bark, and the turpentine and other volatile oils and resinous deposits found in needle-leaved trees.

Many preparations and chemical processes have been tried for the preservation of wood. Creosote is one of the best preservatives known. Insects and fungi are repelled by its odor. The so-called "creosote stains" are excellent for outside work, not very expensive, and easily applied. Coal-tar and wood-tar or pitch, applied hot in thin coats, are also good and cheap preservatives. Charring the ends of fence-posts by holding them for a short time over a fire is a common method. Various expensive processes for preserving wood are in use where large quantities are required. Painting with oil paint is of course the most common way of protecting wood, but in using any coating, as paint or tar, which interferes with the process of evaporation, the wood should be thoroughly dry when it is applied, or the coating will confine the moisture and favor decay.

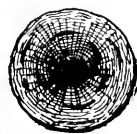
Wet rot is a decay of the unseasoned wood, which may also be caused in seasoned wood by moisture with a temperate degree of warmth. It occurs in wood alternately exposed to dryness and moisture. *Dry rot*, which is due to fungi, does not attack dry wood, but is found where there



HEART-SHAKES



STAR-SHAKES



CUP-SHAKES

Fig. 543

is dampness and lack of free circulation of air, as in warm, damp, and unventilated situations, like cellars and the more confined parts of ships, and in time results in the entire crumbling away of the wood. Creosote is preventive to the extent to which it saturates the wood.

153. Shakes are cracks radiating from the centre of the tree, or else between the annual rings so as to separate the layers, and are due to uneven shrinkage, swaying in the wind, decay, or other causes. Fig. 543 shows the common forms.

154. Effects of Expansion and Contraction.—Besides guarding against damage from the shrinking of green wood, the swelling and shrinking of dry wood has to be borne in mind for many kinds of work.

When taken from the kiln it absorbs moisture from the air, and swells. When the air becomes more damp, the wood swells more. When the air becomes dryer, it draws moisture from the wood, and the latter becomes dryer and shrinks. This continual swelling and shrinking cannot be prevented, and the work must be put together to allow for it.¹

¹ For instance, if you were to glue cleats for their whole length across the side of a

Cracks, curling, warping, winding, or twisting of wood are due to irregular and uneven swelling and shrinking. Some kinds of wood shrink much in drying, others but little. Some, after seasoning, swell and shrink, curl and warp, to a marked degree with the changes of the atmosphere. Stock once thoroughly air-dried, however, alters less under ordinary



Fig. 544

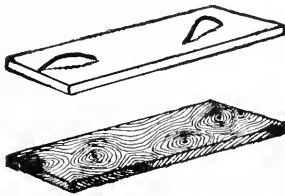


Fig. 545

circumstances. If one part shrinks much faster than another, cracks result. Put one end of a green board into a hot oven. The heated end will crack and split before the rest of the board has fairly begun to dry. Exposure of one side of a seasoned piece to either dampness or heat will cause it to curl, for the dampness swells the side affected or the heat shrinks it. In cutting wood into smaller pieces, unexpected bending and twisting will often develop in the smaller pieces which did not exist in the original stock, due to suddenly exposing the fresh cuts to the atmosphere.



Fig. 546

Frequently the heart of a tree is not in the centre. In some cases it takes such a devious course as to make the grain so crooked that the tendency to warp or twist cannot be prevented by any method of sawing. Figs. 544, 545 illustrate this in an exaggerated way. Such trees may show beautiful variations of grain. Even in straight trees the pith is seldom quite straight, due to the crooked way the tree grew when young (Fig. 546).

In addition, the knots caused by branches, the twisting of the stems, screw-fashion (as seen in cedar), wounds, and other causes, often produce very crooked and tangled grain, and the wood of many broad-leaved trees is sometimes extremely complicated in texture. In some kinds of mahogany, for instance, the fibres are strangely interlaced and run in different directions in layers which are quite near each other.

Warping, twisting, and cracking are obviated in many cases where object-drawing-board three feet wide, it would probably not be many weeks before the cleats would be loosened for at least part of their length, because of the expansion or contraction of the board. In such cases the cleats should be fastened with screws which have play enough to allow for shrinking and swelling. As another example see Fig. 638.

tionable (as in the wooden frames of machines, the tops of benches, etc.) by building up with a number of smaller pieces. These should be selected and put together so that, though the grain will run in the same direction lengthways, the annual rings at the ends will not run together as in a natural piece, but will be reversed or arranged in various combinations, so that the warping and twisting tendencies of the different parts will counteract each other. Thus instead of a single board which would naturally become warped in one large curve, a number of strips can be glued up (Fig. 140), so that the warping will merely result in a slightly wavy line.

Where but one side of a board is seen or used, and where the full strength is not needed, warping and twisting can sometimes be largely prevented by lengthways saw-cuts (easily made with the circular saw) on the back or under surface, as in a drawing-board, the crossways strength required being secured by cleating or other devices. Doors and most forms of panelled work also illustrate various methods of preventing damage from swelling and shrinking (see page 167).

A FEW ELEMENTARY PRINCIPLES OF CONSTRUCTION

155. Importance of Diagonal Members. Strength of Materials.—Nail three strips of wood together to form a triangle (Fig. 547). Nail also four strips to form a square. Whereas a little pushing or pulling will change the shape of the rectangle, you will find that you cannot alter the shape of the triangle without applying force enough to break it. Now, nail a diagonal strip to the rectangle (Fig. 548), making it into two triangles, and you cannot change the shape without breaking it.

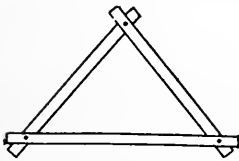


Fig. 547

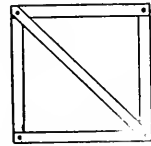
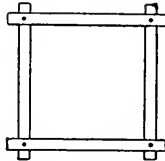


Fig. 548

This very simple principle has innumerable applications in all kinds of constructive work. Where there is no strain upon a structure to alter its shape, diagonal strengthening is not necessary, but in many cases it

is essential, for a lightly built structure properly planned is often much stronger than a heavily built one of poor design.

For example, a driveway gate, made as in Fig. 549, soon begins to get out of shape, as in Fig. 550. If it have a diagonal member it cannot do this, except by the giving way of some part. At first the diagonal distances AD and BC were equal. After the gate has settled out of shape the dis-

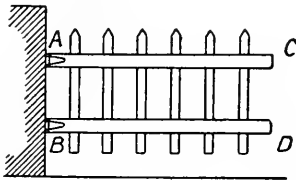


Fig. 549

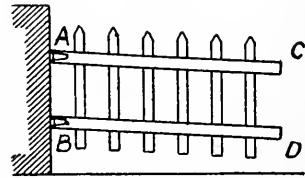


Fig. 550

tance AD will be longer and BC shorter than before, as A and D have been pushed farther apart and B and C drawn nearer together. Now an iron rod is good for a pulling strain (tension),[†] but not for a pushing strain (compression), so if we put a diagonal rod from A to D it will tie the

[†] A piece of wood or metal may be strained or destroyed in several ways: by being stretched or pulled apart,—*tension*; it may be crushed or pushed together,—*compression*; it may be broken across,—*transverse*- or *cross-strain*; or it may be twisted apart by *torsion*. It may be broken or injured by any or several of these strains.

The strength of a piece of wood or metal to resist crushing, tension, or shearing is in proportion to the area of its section. A piece with a section two square inches in area is twice as strong as one with a section one square inch in area. The strength to resist a transverse or cross-strain is *as the width, inversely as the length, and as the square of the depth*. Doubling the width doubles the strength. Doubling the length divides the strength by two. Doubling the depth multiplies the strength by four. That is, a beam four inches wide is twice as strong as one two inches wide. A beam ten feet long is twice as strong as one twenty feet long. A beam eight inches deep is four times as strong as one four inches deep.

In making splices and other joints where strength is required, it should be borne in mind that the strength of any structure is limited by the strength of its weakest part, therefore the aim should be to make a joint or splice as nearly equal in strength to the parts it connects as possible. The joint best for one strain is usually not the best for another, therefore the fewer different strains a joint is subjected to the better. A plain butt joint fastened to prevent movement sideways is sufficient for compression, but often requires strengthening for cross-strain also. Joints to be subjected to tension require careful planning to preserve so far as possible the full strength.

points A and D together, and the gate will hold its shape (Fig. 551), except for the slight sagging which is inevitable in such work. Or, if we wish to put a diagonal member from B to C, it will be under a pushing strain (compression), since the points B and C will tend to come nearer together, and we should not use a rod, but a wooden brace or strut, which will stand the pushing and will not easily bend (Fig. 552).

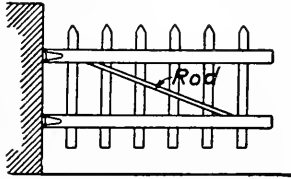


Fig. 551

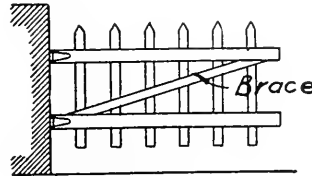


Fig. 552

Lay a twig across two supports, hang a weight at the middle and see what happens (Fig. 553). The bark will pucker on the upper side of the twig, showing that the top is being shortened or *compressed*. The bark will be stretched and perhaps cracked apart on the under side, showing that the lower part is being lengthened or pulled out (or subjected to *tension*). Now, if you lay a piece of timber 2" x 8" across a brook for a bridge, or as a



Fig. 553

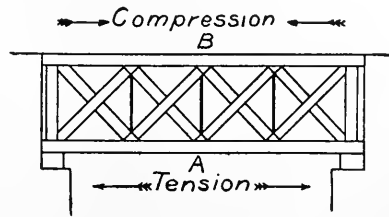


Fig. 554

floor-timber, it will suffer the same kind of strain as the twig, shortening (compression) in the top part and pulling out (tension) in the lower part.

This principle applies to the trusses of a bridge or a roof, although these are made up of many pieces instead of one piece. The upper part is under compression, the lower under tension. If you were told in time of war to destroy a wooden railroad bridge, all you would have to do would be to saw through the lower chords, as they are called (A in Fig. 554), and the

bridge would fall, for the lower part would be under the strain of tension and trying to pull apart all the time. If you were to saw the upper chord (B in Fig. 554), instead, the bridge would still stand, for the top would be under compression and the saw-kerf would immediately close up like any butt joint that is being pushed together. In fact the pressure would bind the saw unless the kerf were forced open. The bridge would not be so strong, since an unsecured butt-joint might work out of place, but it would not fall of itself.



Fig. 555

In order that the material may resist the compression and tension to the best advantage it is placed with reference to these strains, as, for example, in a common I-beam of iron (Fig. 555), in which a good deal of the metal is purposely arranged at the top and bottom. Bridge trusses illustrate this also. A beam will bear twice as much weight equally distributed over its length as when applied at the centre.

The simplest way to bridge over a short distance is to lay a beam on edge. For a wider distance the beam (or girder) can be supported by braces as in Fig. 556. The weight on the beam, bearing downward, will push or thrust on them, and they will be under compression, one half the thrust being put upon each

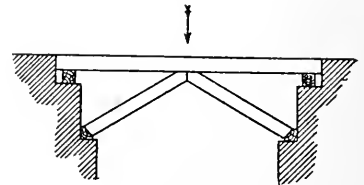


Fig. 556

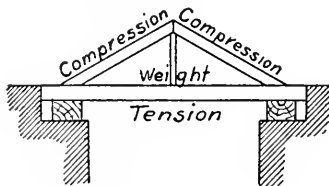


Fig. 557

brace which in turn pushes against the abutment, or the braces can be put on top, and the middle of the beam hung from their apex (Fig. 557). When the beam begins to bend with the weight applied, it pulls on the rod at the middle. This rod, hanging from the apex, pushes the braces, and the braces, being fastened to the beam, in turn put the beam under tension. As another illustration, it is common to strengthen or stiffen a beam as in Fig. 558. The weight at W bending the beam, pushes the strut or block A, and this pulls on the rod, which applies compression to the beam. These crude illustrations give the clue to the general principles which, often carried much farther, apply to the construction of many comparatively simple pieces of work, as well as roofs, bridges, and the like.

Have a few hundred little strips of soft pine perhaps $\frac{1}{8}$ " x $\frac{1}{2}$ " x 12" prepared. Very little force will break one of these pieces. Nail them together to form a simple lattice bridge as shown in Fig. 559, making it perhaps 6' or 8' long and each side or truss several strips in thickness.

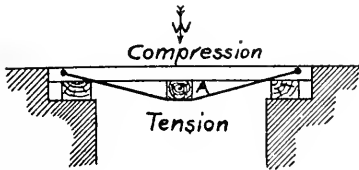


Fig. 558

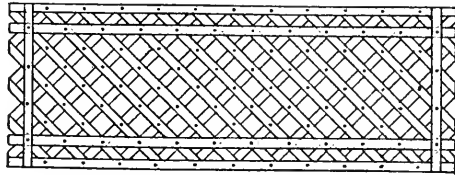


Fig. 559

Though a very slight-looking affair, it will support an enormous weight. Bridges of this kind made by pupils of the writer have supported the weight of entire classes (several thousand pounds), and long levers have sometimes been necessary to break them. Such experiments show the strength derived from combination, and also that the strength of a model is much greater proportionately than a larger structure.

SOME PRACTICAL PROBLEMS IN DRAWING AND LAYING OUT WORK

While a photograph or picture shows how an object looks, we cannot take accurate dimensions from it with a rule. To do so we must have drawings which show at once the exact shapes, sizes, and positions of the various parts.

The view of what you would see if you stood directly in front of an object is called the *front elevation*. Stand opposite either side or end and you have the *side* or *end elevation*. In the same manner the *rear elevation* is shown. Next, imagine yourself directly above the object. This view is called the *plan*.¹ If the sides or ends are not alike, as is sometimes the case, two side or end views may be needed.

¹ This definition of elevations and plan as being representations of what you would see if you stood opposite the sides or above the top of the object, is merely a rough explanation of the meaning of the terms. The elevation is, strictly speaking, not the way the front or side would appear if looked at from one position, but the way it would appear if you could look at it from directly opposite every point of it—as if you could have an infinite number of eyes, one opposite every point of the object.

All important work should be made from working drawings, which should show not only exactly what is to be made but exactly how to make it. Every detail and measurement should be accurately drawn to scale. This requires that the work be thought out to the end and thoroughly understood, rough preparatory sketches being made first when necessary.¹

Elevations are taken at right angles to the plan. If the object is quite simple, one elevation and the plan, or two elevations without the plan, may be sufficient. Make drawings full-sized when the object is not too large. Mistakes are less likely to be made, and it gives a better idea of how the object is to look. In making a drawing which is symmetrical, it is a safeguard to lay it out from a centre line, and labor and space are usually saved by drawing on one side of the centre line only.

If each line of a drawing is one half the length of the same line in the real object, it is called a "half-size" drawing, and is said to be drawn on a scale of 6" to the foot. If "one-fourth size," the scale is 3" to the foot. The scale is often expressed as an equation, viz.: 2 in. = 1 ft., or $\frac{1}{4}" = 1'$. If the drawing is not made with accuracy, it is necessary to put the dimensions upon it. This is often done for convenience with drawings which are accurate.

Details inside of an object,—that is, such parts as cannot be seen or properly shown in the elevations or plan,—are often shown by dotted lines, as in Fig. 662. Sometimes dotted lines are used in the same way to show the back of an object, to save making extra drawings. Yet since too many dotted lines are confusing, it is frequently best to make another kind of drawing to show such details. This is called a "section" (Lat., *sectio*, from *secare*, to cut), and shows what would be seen if the object were cut apart. The surface supposed to be cut is usually indicated by parallel lines crossing it. Independent parts, as those of different pieces, are frequently shown by changing the direction of the parallel lines, as in

¹ It is the custom in all practical work for which drawings are used, first to design the object, expressing the design with the details in working drawings,—in fact, if drawings are required at all they must obviously be made before the object is begun. That this is the necessary and logical mode of procedure in professional work does not necessarily prove it to be always the logical or sensible way for the beginner. The drawing must come before the work; but whether it should be made by the pupil, or be provided for him, should depend upon his knowledge of the construction of the object he is to make. To make working drawings properly, one must understand the construction of the object to be made.

Fig. 479. A half-elevation and half-section can sometimes be combined in one drawing.

It is often a help to have a picture of the object to be made as well as a working drawing, in forming a correct idea of something you may never have seen. Where the appearance of the object is of consequence, as in the case of a house or bookcase, the picture is important. An idea in the mind is not always sufficient from which to make working drawings, although the first step in the process. When the idea is put into the form of a picture, it often does not look as you thought it would, and if you had started at once on the working drawings the result would have been unsatisfactory and sometimes impracticable. Even after making a satisfactory sketch or picture the completed object often looks quite different from what was expected.

Oblique or *parallel projections* are often used, from which measurements can be made. Such projections are not true representations of the objects as they appear to the eye, but they are easily drawn and readily understood. (See page 221.)

Another way of representing objects for practical purposes is shown in Figs. 571, 661, and is known as *isometric¹ projection* or isometric perspective. This method is incorrect so far as giving an accurate picture is concerned, but is often useful because by it all that is required can frequently be expressed in one drawing. Isometric perspective will not readily give the correct dimensions except in the lines which are vertical or which slant either way at an angle of 30° with the horizontal,—*i.e.*, you cannot take the other dimensions off with a rule as from a plan. Therefore, so far as obtaining correct dimensions is concerned, it is practically not useful for other than rectangular objects; though even with objects having curved parts it may advantageously be used to show the general shape. (See page 221.)

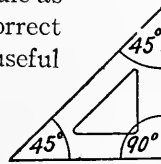


Fig. 560



Fig. 561

156. Drawing Instruments.—The most important for common pencil work are a drawing board, two triangles (Figs. 560 and 561), T-square, lead pencil (rather hard), dividers (with pencil point), rule or scale, and thumb tacks.

157. Use of the T-square.—Slide the head up or down, as may

¹ Greek, equal measure.

be required, against the left side of the drawing board only as in Fig. 578.

158. Use of Triangles.—Slide them against the T-square and against one another. Celluloid triangles are very convenient.

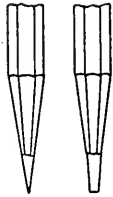


Fig. 562

159. Pencils for common use can be sharpened with a round point; for careful drawing, with a flat or wedge-shaped edge (Fig. 562).¹

Many kinds of lines are often used by draughtsmen. Parts not seen are designated by dotted lines, and parts between which dimensions are given by $\leftarrow 10'' \rightarrow$. Fig. 564



Fig. 563

offers suggestions for practise in the use of T-square, pencil, knife, rule, and straight-edge.

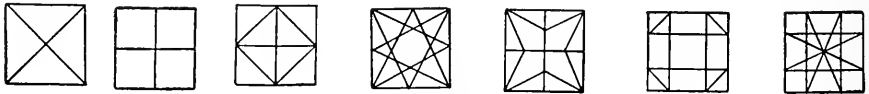


Fig. 564

To make a working drawing of a simple block, a front view and top view are required. These are enough to give all the dimensions of the block in Fig. 565. Hinge three boards together as shown in Fig. 566. Place the block on the bottom board, mark around it and you have the top view or *plan* (Fig. 566). Place the block against the board at the back, mark around it, and you have the front view (Fig. 566). Place the block against the board at the left (it could be at the right, of course),



Fig. 565 mark around it, and you have the end view

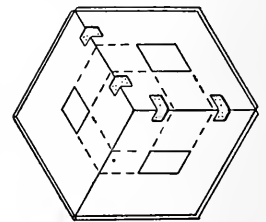


Fig. 566

¹ To draw a line accurately through given points, in mechanical drawing, the ruler should not quite touch the points, but be pushed nearly up to them and equally distant from each (Fig. 563). This gives a view of both points so that the line can be drawn as accurately as possible through each. The pencil point can be slanted until it coincides with one of the given points. Then, keeping the same inclination, move the pencil along until it passes through the second point. This applies to a ruler with a thin edge, as a T-square, or triangle, and to fine work only. See page 17.

(Fig. 566). Turn the upright board down and you have these three views displayed on a flat surface (Fig. 567).

In oblique perspective (Fig. 568), the front of the object is drawn of the

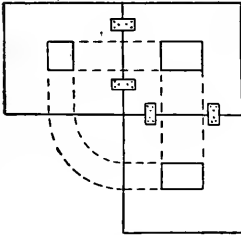


Fig. 567

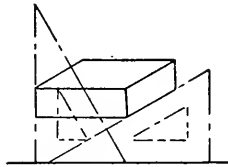


Fig. 568



Fig. 569



Fig. 570

correct shape and size and then, from the angles, lines of the right length are drawn at the same angle. By connecting the ends of these lines the shape of the block is shown. Figs. 569 and 570, are examples.

Fig. 571 illustrates isometric perspective, in which all the measurements are taken either vertically or at angles of 30° with the horizontal, as shown.

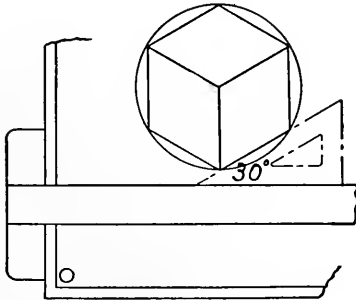


Fig. 571

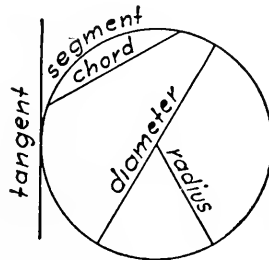


Fig. 572

An *arc* is measured by the number of degrees it includes, as the arc DB in Fig. 596. An *angle* is also measured by the number of degrees of the arc included between its sides, as the angle DOB in Fig. 596.

16. Geometrical problems in common use in practical work:

1. *To bisect a straight line* (Fig. 574).—Let AB be the given straight

line. From A and B as centres, with radius greater than half of AB, describe arcs cutting each other at C and D. Draw CD cutting AB at E. AB is then bisected at E.

2. *From a given point in a given straight line to erect a perpendicular* (Fig. 575).—Let AB be the given straight line, and C the given point.

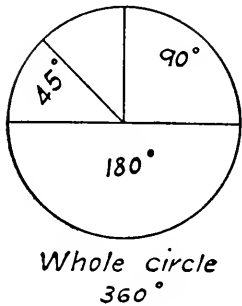


Fig. 573

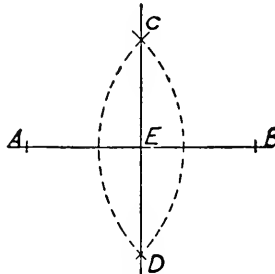


Fig. 574

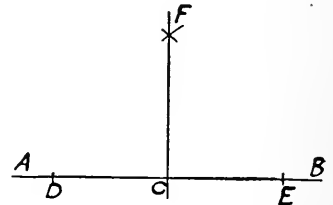


Fig. 575

From C as centre, with any radius, describe arcs cutting the line at D and E. From these points with any radius greater than CD or CE, describe arcs cutting each other in F. FC will be the perpendicular required.

3. *To draw a perpendicular from a point at the end of a line* (Fig. 576).—Let AB be the given straight line, and B the given point. Take any point C above the line, and with the radius CB describe an arc DBE cutting AB at E. Draw ECD; then draw DB, which will be the required perpendicular.

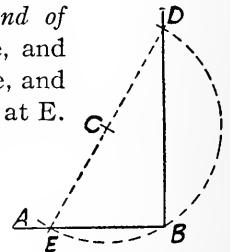


Fig. 576

4. *To draw a perpendicular to a given straight line from a point without the line* (Fig. 577).—Let A be the given point and BC the given straight line. From the point A describe an arc cutting BC at D and E. From D and E as centres and with any radius describe arcs cutting each other at F. AF will be the perpendicular required.

The methods given above are the most accurate, but for common work the T-square and triangles can be used. Draw a horizontal line with the

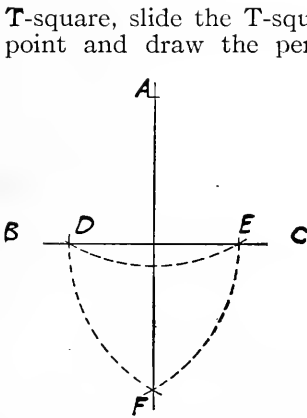


Fig. 577

T-square, slide the T-square down a little, place a triangle at the desired point and draw the perpendicular (Fig. 578). The reason for lowering the T-square is that by so doing the perpendicular can be more accurately drawn at the required point. Two triangles, without the T-square, can be used in a similar manner (Fig. 579). Any straight-edge can be used in place of the lower triangle shown in Fig. 579. With the T-square in its normal use only vertical perpendiculars can be erected with the triangles, but it can of course be used merely as a straight-edge.

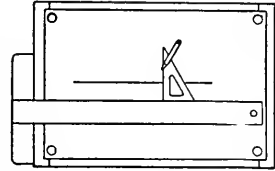


Fig. 578

With triangles, or straight-edge and triangle, perpendiculars can be erected in any position (Fig. 580).

On the mathematical principle that the square of the hypotenuse is equal to the squares of the other two sides, a right angle can always be

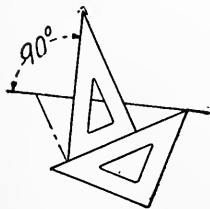


Fig. 579

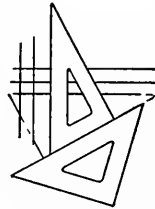


Fig. 580

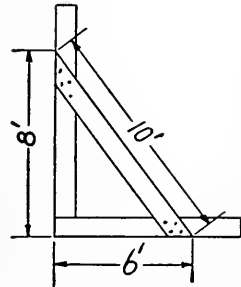


Fig. 581

obtained by making a triangle of those proportions. Triangles with sides which are respectively three, four, and five feet, or multiples of those figures, are constantly being made of strips of wood by workmen to secure right angles in their work. Thus a triangular frame of narrow boards (Fig. 581) is used by masons and carpenters to square foundations and sills.

5. Through a given point to draw a line parallel to a given line

(Fig. 582).—Let AB be the given line and C the given point. With C as a centre draw an arc to cut AB in D. With the same radius and D as a centre, draw an arc to cut AB in F. With D as centre and CF as radius draw an arc to cut the first arc in E. Draw a line through C and E and it will be parallel to AB.

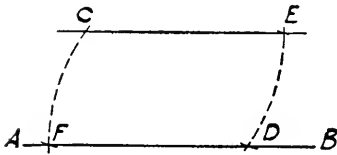


Fig. 582

This is the most accurate way, but for common work, where the lines are horizontal or vertical, move the T-square up or down (Fig. 583) or slide a triangle to the right or left against the T-square (Fig. 584). Slanting parallel

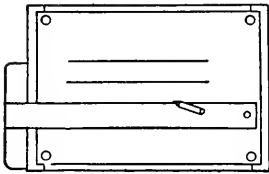


Fig. 583

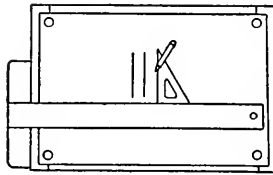


Fig. 584

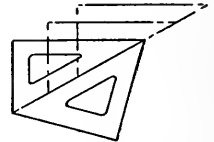


Fig. 585

lines can be drawn with the slanting edge of a triangle or, with two triangles, parallel lines can be drawn in any direction (Fig. 585). Any straight-edge can be used in place of the lower triangle in Fig. 585.

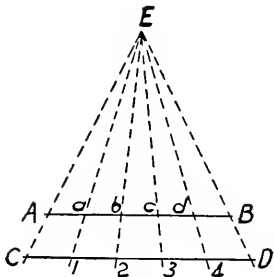


Fig. 586

6. *To divide a given line into any number of equal parts* (Fig. 586).—Let AB be the given line. Draw CD parallel to AB at any convenient distance from it. On CD lay off any distance as many times as the required number of equal parts. This may be done by dividers or with a measure. Through C and A and through B and D draw lines meeting in E. From the points 1, 2, 3, and 4 draw lines to E cutting AB in the points a, b, c, and d, which will divide AB into five equal parts. Or (Fig. 587): from one end of the line AB draw the indefinite line AC. From the

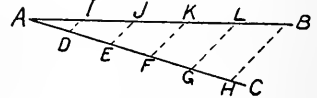


Fig. 587

in E. From the points 1, 2, 3, and 4 draw lines to E cutting AB in the points a, b, c, and d, which will divide AB into five equal parts. Or (Fig. 587): from one end of the line AB draw the indefinite line AC. From the

point A lay off any convenient equal distances AD, DE, EF, FG, and GH. Draw HB, and from G, F, E, and D draw GL, FK, EJ, and DI parallel to HB. Then AB will be divided into equal parts at I, J, K, and L.

For ordinary small work these parallel lines can be quickly drawn by sliding a triangle against a straight-edge (Fig. 585).

7. To bisect a given angle (Fig. 588).—Let ABC be the given angle. From B describe an arc DE cutting AB and BC at D and E. From D and E, with any equal radii, describe arcs intersecting in F. Draw BF and it will bisect the angle ABC. That is, the angle ABC is divided into two equal angles ABF and FBC.

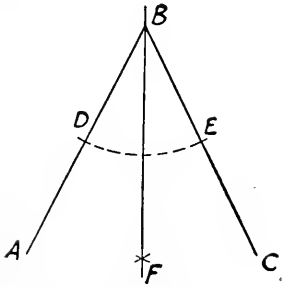


Fig. 588

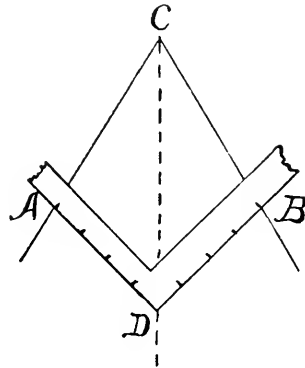


Fig. 589

To bisect an angle with the framing or steel square (Fig. 589).¹—From the point C lay off points A and B equally distant from C. Place the steel square with one leg touching the point A and the other the point B, and so that DA is equal to DB. Mark the point D. The line CD will bisect the angle ACB.

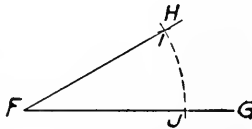
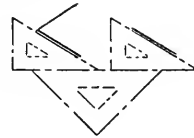
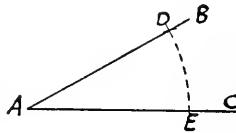


Fig. 590

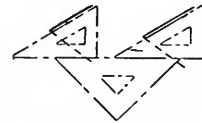


Fig. 591

8. To construct an angle equal to a given angle (Fig. 590).—Let BAC be the given angle. From A describe an arc DE cutting AB and AC at the points D and E. Draw the line FG. From F as a centre, with

¹ A special tool is made for bisecting angles.

the same radius, describe an arc IJ cutting FG at J. From J as a centre, with radius equal to ED, draw an arc cutting the arc IJ at H. Draw FH and the angle HFG will be equal to BAC.

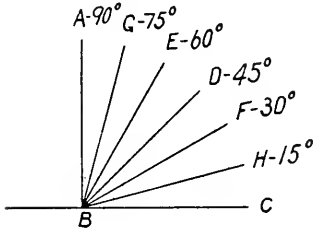


Fig. 592

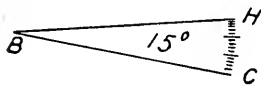


Fig. 593

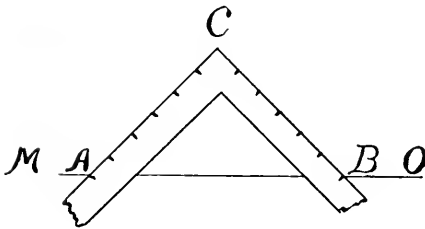


Fig. 594

bisect it (Prob. 7). To draw it with a triangle use the triangle having two angles of 45° each.

To mark an angle of 45° , or a mitre, with the steel square.—Place the square as in Fig. 594, so that the same divisions on each blade of the square will fall on the line MO. Then the lines AC and BC will be at 45° with the line MO. Fig. 595 shows laying out the angle from the edge of a board.

This can often be done by so adjusting a triangle and a straight-edge (T-square blade, another triangle or ruler) that when the triangle is slid against the straight-edge the angle can be drawn (Fig. 591). If the sides of the angles are not respectively parallel, try a combination of triangles.

9. *To lay out a protractor for obtaining certain angles* (Fig. 592).—Draw the right angle ABC (Prob. 2). Bisect it with the line BD (Prob. 7), and trisect it with the lines BE and BF (Prob. 14). Bisect ABE and FBC with the lines BG and BH. This divides the right angle into divisions of 15° each, which is as far as the process can be carried with geometrical accuracy. Each of these divisions can be divided into degrees, with approximate accuracy, by first dividing the arc HC (Fig. 593) into three parts with dividers, as nearly as can be done by eye, and then dividing each of these thirds into five parts.

10. *To draw an angle of 45° .*—Draw a right angle (Prob. 2) and

11. To draw angles of 30° , 60° , 120° , and 150° with dividers (Fig. 596).— On one side of a straight line, with any radius, draw a semi-circumference. With the same radius, and A and B as centres, strike arcs inter-

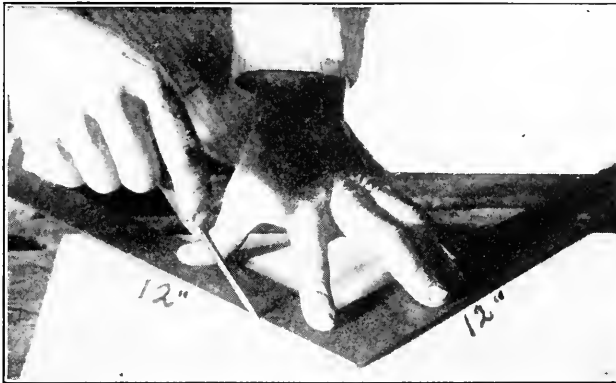


Fig. 595

secting the semi-circumference at C and D. Draw OC and OD. Angles AOC, COD, and BOD will be 60° . Bisect AOC (Prob. 7) and AOF will be 30° . FOD will be 90° . COB will be 120° . FOB will be 150° . Either of the other angles can be bisected in the same way.

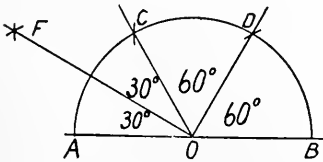


Fig. 596

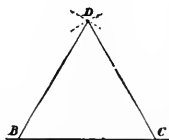


Fig. 597

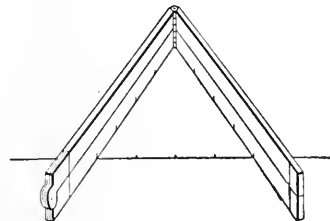


Fig. 598

To draw these angles with a triangle, use the corresponding angles of the triangle (Figs. 560 and 561).

The angles of an equilateral triangle (Fig. 597) are 60° , and 120° is made by projecting either of the sides, so these angles can be accurately found by drawing an equilateral triangle with dividers (Prob. 15), or approximately with the rule (Fig. 598).

If the bevel be applied to the steel square so that the distance intercepted on the bevel is twice that on one of the arms of the square, the angles which the blade of the bevel makes with the square will be 60° and 30° .¹

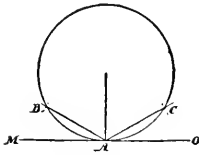


Fig. 599

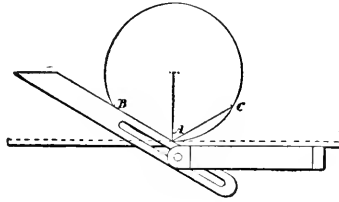


Fig. 600

12. To draw angles of 30° and 150° .

—Describe a circle tangent to a straight line MO (Fig. 599). Draw a line from the centre of the circle perpendicular to the line MO at the point

A. From the point A, with radius equal to the radius of the circle, strike arcs cutting the circle at B and C. Draw the lines AB and AC, which will give angles of 150° and 30° with the line MO.

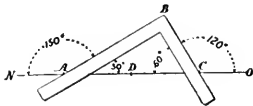


Fig. 601

This method can be used at the edge of a board to set the bevel as in Fig. 600.



Fig. 602

To draw an angle of 30° , 60° , 120° , or 150° with the steel square. — Lay off on a straight line (Fig. 601) the distances AD and

DC equal to each other. Place the square as shown with the edge of the blade on the point C, and so that the distance BC equals DC. Then the angle BAD equals 30° , and the angle BCA equals 60° . The exterior angles BCO and BAN, being supplements of these angles, will equal 120° and 150° .

To set the bevel at any required angle.—The angle can be laid out with compasses on a straight-edged board, to which the bevel can be applied.

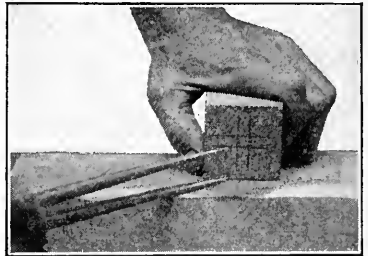


Fig. 603

¹ In a right-angled triangle the hypotenuse of which is twice the length of the short side, the angles adjacent to the hypotenuse will be 30° and 60° , therefore by laying out a triangle of such proportions, with drawing tools, or by using the bevel set by means of the steel square (see below), these angles can be obtained.

Lay out the angle from a line drawn parallel to the edge, as in Fig. 600, so that there will be no need to try to set the point of the compasses at the exact edge of the board.

13. *To find the centre of a square or rectangle* (Fig. 602).—Draw diagonal lines from the opposite angles and they will intersect in the centre.

The centre of a piece of wood can often be found by using compasses as in Fig. 603 or a gauge. This way can also be used for irregular shaped pieces, as the compasses will trace a small copy of the outline (Fig. 604).

14. *To trisect a right angle* (Fig. 605).—Let ABC be the right angle. With B as a centre and any convenient radius draw an arc DE. With D and E as centres and with the same radius, draw arcs to cut DE in F and G. Draw BF and BG and these lines will trisect the right angle ABC.¹



Fig. 604

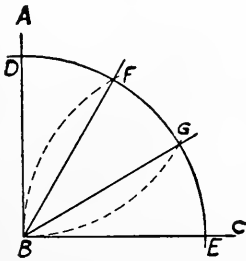


Fig. 605

15. *To construct a triangle, its three sides being given* (Fig. 606).—Make DE equal to C. From D as a centre, with radius equal to B, describe an arc at F. From E as a centre, with radius equal to A, describe another arc, cutting the former at F. Join FD and FE; and DEF is the triangle required.

To find the length of the hypotenuse of a right-angled triangle, approximately, with the framing square and rule, when the lengths of the other two sides are given; lay off on the blades of the square

the lengths of the given sides, as 6 and 9. By applying the rule, the distance between these points can be measured and will be the length of the required side (Fig. 607). Inches, quarter-inches, or any equal divisions can be taken as the unit of measurement. This method can be used to find the length of a brace approximately.

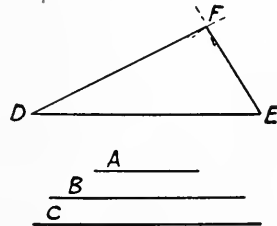


Fig. 606

To draw an equilateral triangle with the steel square (Fig. 608).—Let AB be the length of one side of the required triangle. Place the square as shown, with the division 7 on the edge of one blade at the point A and the division 12 on the other blade touching the given line. Draw AC. In the same way, place the square against the point B

¹ This applies only to a right angle.

and draw DB. Produce AC and DB to meet in E. AEB will be the

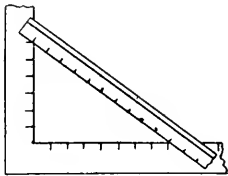


Fig. 607

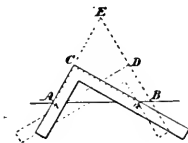


Fig. 608

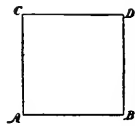


Fig. 609

equilateral triangle required. This method is not so accurate as to use compasses.

16. *To describe a square on a given line AB (Fig. 609).*—Make the angle CAB a right angle, and AC equal to AB. Draw CD and BD parallel to AB and AC, and ABDC is the square required.

This is most accurately done with dividers, but a square can be drawn for ordinary purposes with T-square and triangle.

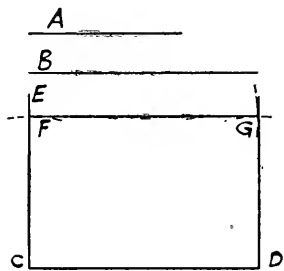


Fig. 610

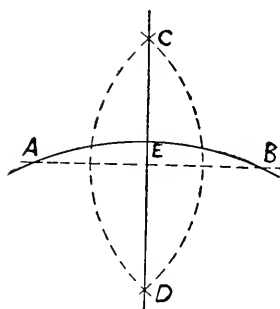


Fig. 611

17. *To draw an oblong or rectangle with given sides, as A and B (Fig. 610).*—Make CD equal to B. At C erect a perpendicular CE. From C with radius equal to A describe an arc cutting CE in F. From D with radius equal to B, and from

F with radius equal to B, draw arcs intersecting at G. Draw FG and GD. Then CFGD is the oblong required.

18. *To bisect an arc and its chord (Fig. 611).*—Let AB be the arc. CD, the perpendicular bisector of the chord, bisects the arc.

19. *To draw a circle or an arc tangent to a straight line at a given point (Fig. 612).*—At the given point A erect a perpendicular AB (Prob.

2). With radius equal to that of the required circle or arc, and with the point A as centre, describe an arc cutting the perpendicular at C. C is the centre of the required circle or arc.

20. *To inscribe a circle in a square* (Fig. 613).—Draw diagonals within the square. Their intersection will be the centre of the required circle. Take radius equal to one half the length of the side of the square.

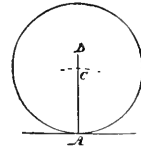


Fig. 612

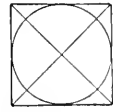


Fig. 613

21. *To inscribe a square in a given circle* (Fig. 614).—Let ABCDEFGH be the circle. Draw diameters A E and C G at right angles to each other. Draw AC, CE, EG, GA; and ACEG will be the square required.¹

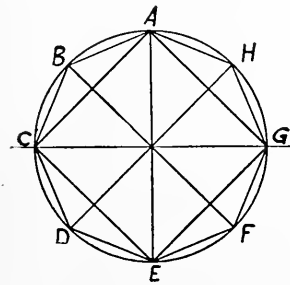


Fig. 614

should be opposite each other on a cylindrical stick, as required for boring. From a given point lay off the radius three times on the circumference, and the last point should be opposite the first. But in all such work it is impossible to be absolutely accurate, therefore it is well to also measure around the other way and, if the points do not coincide, take a point midway between.

The accuracy of a semi-circular hollow can be tested by applying the square as in Fig. 617, when the angle of the square should touch the curve at any point. It is on this principle that the core-box plane is constructed for working out semi-circular hollows.

22. *To inscribe an octagon in a given circle*

¹ Thus in a semi-circle chords drawn from any point in the circumference to the ends of the diameter will form a right angle with each other. In Fig. 615 DAE, DBE, and DCE will be right angles. Consequently the diameter of a circle can be found approximately by applying a square with the angle touching the circumference of the circle as at C (Fig. 616), and measuring the distance between the points A and B where the edge of the square cuts the circumference. Conversely: if the diameter of a circle be given, the circumference can be found by applying the square to the ends of the diameter. In whatever position

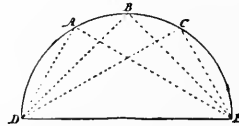


Fig. 615

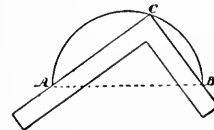


Fig. 616

(Fig. 614).—Proceed as in Prob. 21; then by bisecting the angles by diameters, or bisecting the chords, the circumference will be divided into eight equal parts. Draw AB, BC, CD, DE, EF, FG, GH, HA; and ABCDEFGH will be the octagon required.

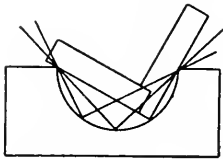


Fig 617

23. To inscribe a hexagon or an equilateral triangle in a given circle (Fig. 618).—With the radius of the circle describe a succession of arcs cutting the circle in the points A, B, C, D, E, F. Join these points

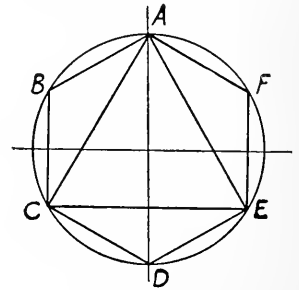


Fig. 618

and ABCDEF will be the hexagon required. Join every other point, as A, C, E; and ACE will be the equilateral triangle required.

24. To inscribe a circle in a triangle (Fig. 619).—Bisect two of the angles, as BAC and ABC (Prob. 7), producing the lines to intersect in D. From D as a centre, with radius equal to the perpendicular distance from D to any of the

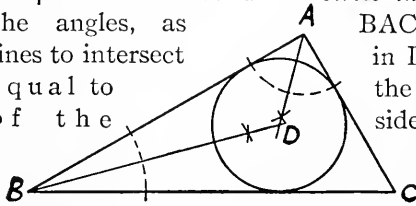


Fig. 619

25. To inscribe a pentagon in a given circle (Fig. 620).—Let ABCDE be the given circle. Draw diameters

AF and GH at right angles. Bisect GO at I. With I as centre and IA as radius describe an arc AK cutting GH at K. From A as centre, with AK as radius, describe an arc KE cutting the circumference at E. With AE as radius describe a succession of arcs cutting the circumference in D, C, and B. Join these points and ABCDE will be the pentagon required.

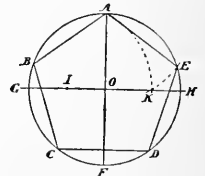


Fig. 620

26. To inscribe a polygon of any number of sides within

applied, the point (angle) of the square will touch the circumference. Nails can be driven at A and B, and by sliding the square around with its edges bearing against the nails, the angle or point of the square will describe the semi-circumference required. Such methods can be used in practical work where exactness is not required, but are apt to be somewhat inaccurate. See also Fig. 628.

a given circle (Fig. 621).—Draw a diameter AD and divide it into many equal parts (6 for example) as the required polygon has sides (Prob. 6). From A and D as centres, with AD as radius, draw arcs to intersect in G. From G draw a line through the second point (2 or 4) cutting the circumference of the circle in C. With radius CD draw a succession of arcs cutting the circumference in B, A, F, E. Join these points and ABCDEF will be the polygon required.

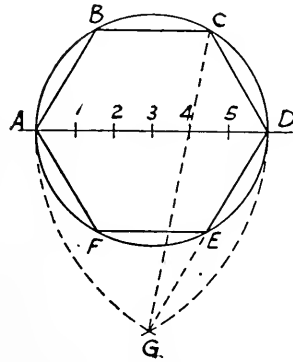


Fig. 621

27. To construct a regular pentagon one side being given (Fig. 622).—From A and B as centres, with radius AB, draw arcs intersecting in G and H. With H as centre, and with radius HA, draw an arc cutting the other two arcs in D and F. Draw GH cutting the last arc in I. Draw lines from D and F, through I, cutting the first two arcs in C and E. Draw AC and BE. From C and E as centres, with radius AC, draw arcs intersecting in J. Draw CJ and EJ. ABEJC will be the pentagon required.

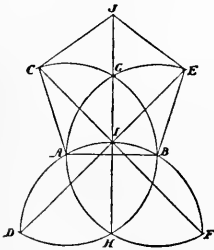


Fig. 622

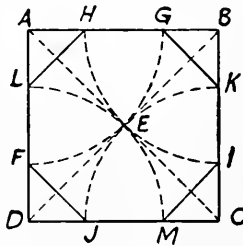


Fig. 623

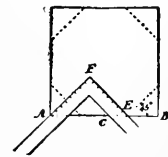


Fig. 624

28. To construct an octagon within a given square (Fig. 623).—Let ABCD be the given square. Draw the diagonals AC and DB intersecting at E. From A, B, C, D, as centres, with radius AE, or BE, etc., describe arcs cutting the sides of the square in F, G, H, I, J, K, L, M. Draw LH, GK, IM, and FJ; and LHGKIMJF will be the octagon required.

To lay off an octagon in a given square, with the steel square (Fig. 624).—Bisect side AB of the square at point C. Place the square as shown

so that the distance AC taken on the edge of one blade comes at the point A, and the same distance on the other blade touches the line AB at E.

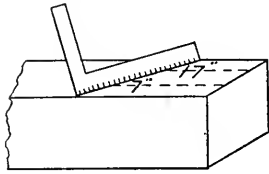


Fig. 625

The point E is at one angle of the octagon. The exterior angle, to form an octagon, is 45° , so that the rest of the figure can be laid off either by repeating the process or by the gauge and angles of 45° .

To lay out the lines approximately—hold the square or rule so that there will be 24 divisions (inches or fractions of an inch, according to the size of the stick) between the edges of the wood.

Mark points 7 divisions from each edge. Gauge lines through these points parallel to the edges (Fig. 625).

29. *To construct a hexagon on a given side* (Fig. 626).—From A and B, with radius AB, describe arcs cutting each other in C. With C as centre and radius CA or CB, describe a circle whose circumference will pass through A and B. Apply the distance AB around the circumference as chords, AD, DE, EF, FG, GB. ADEFGB will be the required hexagon.

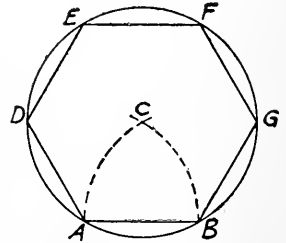


Fig. 626

To lay out the lines for making a square stick hexagonal, first lay out a hexagon on the end of the stick as in Fig. 623. Then with the gauge mark lines on the sides of the stick, as in Fig. 452.

30. *To find the centre of a circle of which the whole circumference, or an arc, is given* (Fig. 627).—Draw the chords AB and BD. Bisect the chord AB at E and the chord BD at F. From E and F draw lines perpendicular to AB and BD, intersecting at C. C will be the centre of the circle.

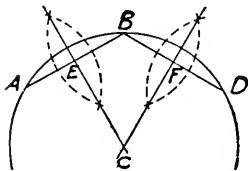


Fig. 627

31. *Through three given points to draw an arc* (Fig. 627).—Let A, B, and D be the given points. Draw AB and BD. Bisect them at E and F. Erect perpendiculars at E and F intersecting at C. C will be the centre of the arc passing through A, B, and C. This problem is essentially the same as Prob. 30.

To draw this arc when the centre is out of reach, drive nails at A and C, make a triangular frame of strips of wood (Fig. 628), and slide it around with a pencil or marking point at B, keeping the frame pressed against the nails as it is moved. The pencil will describe the required arc.

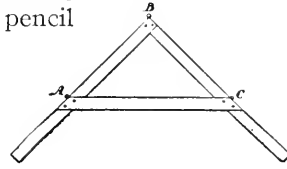


Fig. 628

32. To draw an ellipse, the two diameters being given (Fig. 629).—Let AB (Fig. 629) be the longer diameter and DE the shorter diameter, drawn perpendicular to each other and intersecting at their middle points. From the point E with radius equal to one half the longer diameter, describe arcs cutting AB in F and F. These points are called the *foci* of the ellipse. At these two points drive pins or nails; also a third at point D, and tie a string quite tightly around the points D,

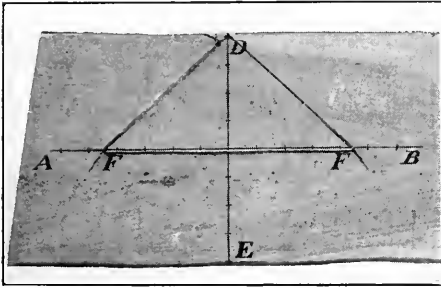


Fig. 629

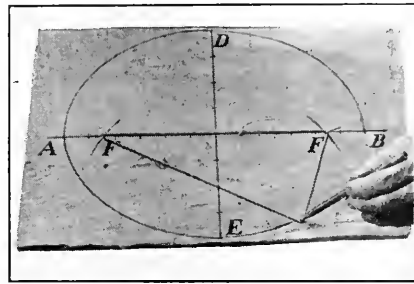


Fig. 630

F, and F. Withdraw the pin at D and substitute a pencil. The pencil, when moved around so as to keep the string taut, will trace an ellipse (Fig. 630). The string should be of a kind that will stretch as little as possible.¹

An ellipse can be drawn approximately by constructing a rectangle of the length and width of the required ellipse, as ABCD in Fig. 631. Divide AE into any convenient number of equal parts, and AG into the same number of equal parts. Draw lines joining these points as shown. Do the

¹ In an ellipse the sum of any two lines drawn from any point in the curve to the foci is the same, hence the method just given. On the same principle an instrument called a *trammel* can be used.

same with the other corners of the rectangle. Draw a line through the inside intersections of the slanting lines and it will be very nearly an ellipse.

Another method: mark on a strip of cardboard or wood from a given point A (Fig. 632) the lengths of the long and short diameters of the required ellipse. Place the marking point at A and move the points B and C along the long and short diameters. The marking point (A) will trace the required ellipse. Or, a series of points can be marked and the curve drawn through them by hand. A square can be placed on the diameters as shown to help guide the points.

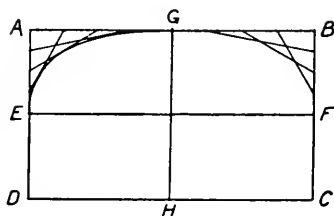


Fig. 631

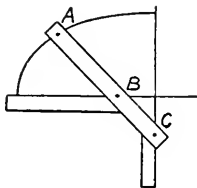


Fig. 632

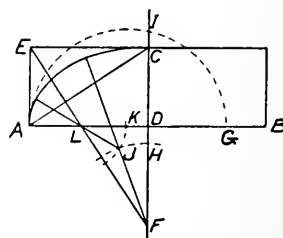


Fig. 633

There are other methods of describing an ellipse, but the one first given is the most convenient for ordinary work. All methods of drawing ellipses with compasses are inaccurate, because an ellipse is not a circular curve in any part.¹

For curves which are not arcs of circles, in cases where free-hand drawing will not do, French curves are used. These are made of thin material like the triangles, with the edges cut in various curves. These curved edges are moved around until a part or parts are found which will fit the curve desired.

¹ For much common work compound curves formed of a number of circular curves of different radii are used. Fig. 633 shows a curve with 5 centres, for an arch, which for ordinary work does not differ essentially from half of an ellipse. Let AB be the long diameter, or span, and CD one half the short diameter or rise. Draw AC. Draw EF perpendicular to AC. Lay off DG equal DC, and describe a semi-circle on AG. Lay off DH equal IC and describe the arc JH. Lay off AK equal DI, and from L as a centre describe the arc KJ, cutting JH at J. L, J, and F will be the centres for half the curve. The other half is drawn in the same way.

To draw symmetrical curves free-hand the simplest way for practical work usually is to lay out a centre line on a piece of paper, draw one half of the curve, fold the paper at the middle and trace the other half from the first half,—or the first half can be cut out and the paper reversed (Fig. 634).

SOME TYPES OF CONSTRUCTION

These few simple examples are not given as a course of work. Different workers will prefer many different designs, but these typical forms are simply to show workmanlike modes of construction and some principles of wide application to many common objects.

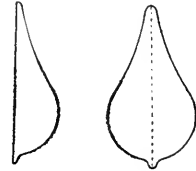


Fig. 634

160. Boxmaking.—Common boxmaking is now done almost entirely by machinery, but the beginner should learn to make a good box by hand. The making of nice boxes is largely a matter of accurate joints. Fig. 635 shows a common type, in which the sides are first nailed to the ends and then the bottom and top put on. In the majority of boxes the sides and ends should be got out with the grain of the wood running horizontally, that is, around

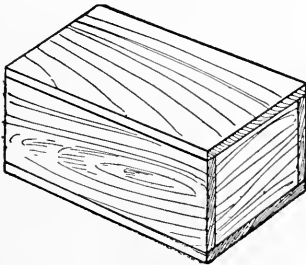


Fig. 635.

the box. This gives a strong edge all around at the top and bottom, and when the sides and ends swell and shrink the change will be the same in each.

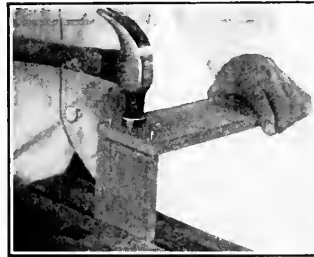


Fig. 636

With certain joints this arrangement allows the use of glue, which would be of little use if the grain of the wood should run in different directions. The best way to fasten such a box as that in Fig. 635 is with nails. Toeing the nails adds strength. (See page 64.) To nail together, first mark the places for the nails so that they will neither be too near the edge of the sides, nor be in danger of coming out through either side of the ends. Bore holes in the sides, and drive the nails until they just prick through. This will help in placing the parts in position (Fig. 636). In hard wood it may be necessary

to bore holes in the ends, slightly smaller than the nails. Glue is of little use with such joints, and screws do not hold very strongly in endwood, *i.e.*, when driven with the grain. Other more difficult joints are shown in Figs. 384, 385, 391, and 431.

Fig. 637, shows other ways of arranging the sides, ends, bottom, and top.

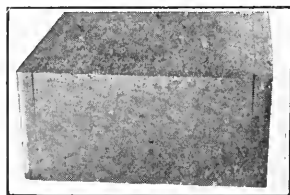
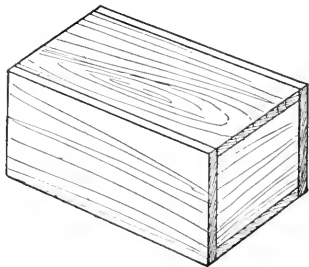


Fig. 638

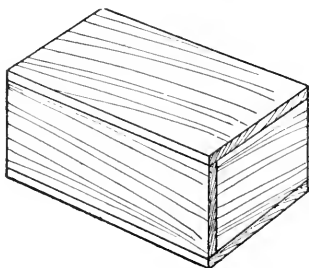


Fig. 639

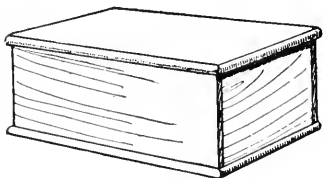


Fig. 637

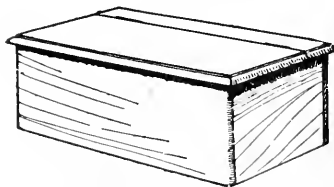


Fig. 640

The bottom is often fitted between the sides and ends, so as not to show; but as it afterwards swells, or shrinks, or both, it may either open a crack at the side or perhaps force the joint apart (Fig. 638). A better way for nice work is to fit the bottom into a rabbet (page 159), cut in the lower edge of the sides and ends (Fig. 639 showing box bottom up). Thus the bottom can be loose enough to allow for expansion and contraction. The lid or cover can be hinged to the top edge of the back of the box or arranged as in

Fig. 640. Plain lids, for everything but rough or temporary work, should be strengthened either by cleats at the ends (page 157), by cleats on the under side (page 157), or by framing (page 167).

Box joints are sometimes mitred (page 142). It is, however, a poor way in point of strength and only a skilful mechanic can make a box with nicely fitted mitred joints that will hold permanently. Mitred joints can, however, be strengthened by splines or keys—pieces let into saw-kerfs. (See page 143.)

Various joints can be made by machine. A rabbeted joint (Fig. 641) can be made by hand, but much quicker with a circular-saw. It is a strong

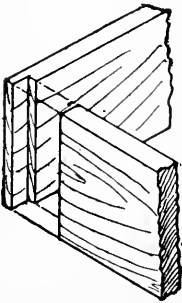


Fig. 641

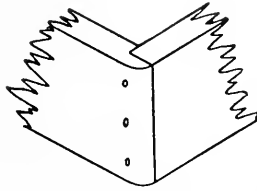


Fig. 642

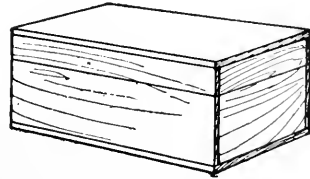


Fig. 643

neat joint, and shows less end-wood than the common butt-joint. If the corner be rounded (Fig. 642), the joint is quite inconspicuous. Glue can also be used to advantage with this joint on account of the shoulder.

Where the box does not open at the top but lower down, as in Fig. 643, the best way is to put the box tight together and then saw it apart. Gauge the line by which to saw it open, and do not drive nails too near this line. Saw the box open carefully on the line. Some people gauge two lines and saw between them. The sawing can be done first from one corner and then from another. This can be done best with the circular saw, letting the saw project above the saw-bench only a trifle more than the thickness of the side of the box. (See page. 91) Joint the edges carefully with the jointer or jack-plane. Let the plane rest on two edges (Fig. 644), for accuracy and to lessen the danger of tearing the edges. That is, while planing one edge, let the plane also rest on the adjacent edge.¹

¹ This applies also to planing any edges or surfaces fastened at an angle, as in various kinds of framed work.

If the box cover must slide in and out careful grooving (see page 159) is required if done by hand, but it can be quickly done by machine. (See



Fig. 644

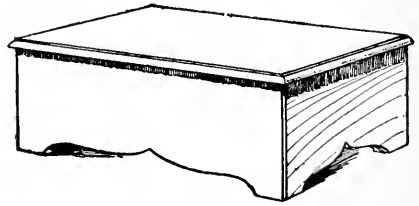


Fig 645

page 96.) A good form for a plain chest is shown in Fig. 645. The bottom can be fitted to a groove cut around on the inside.

Care must be taken to test the angles with the square, and so guard against winding, in making a nice box, as with all framed work. If the bottom and top are got out accurately they will help to make the box square. With glued joints waste pieces should be placed over the joints (across the grain of the sides) to prevent the work being marred by the clamps and to distribute the pressure (Fig. 194).

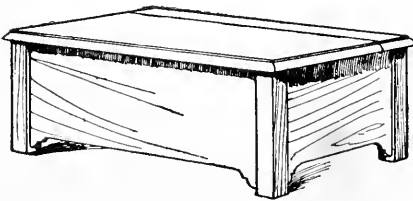


Fig. 646

The final smoothing of the outside should be done after the box has been permanently put together, and plenty of time allowed for the glue to dry. The inside must, of course,

be smoothed before putting together.

Where several boards are required to cover the top or bottom of a large box, if you wish to have as few cracks as possible and to avoid the swelling and shrinking across the grain as much as you can, lay the boards lengthways, but if you merely wish for strength, lay them crossways. The sides and ends of chests or large boxes are often panelled, and sometimes fitted to grooves or rabbets cut in posts at each corner (Fig. 646).

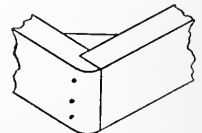


Fig. 647

There is no better or more workmanlike way to put boxes together than by dovetailing (see page 154), but this should not be undertaken until one

has acquired considerable skill. Box corners are sometimes doweled, but this is by no means a strong joint, unless made with unusual skill. The principal advantage of dowelling is to prevent having nail holes show. Corners can sometimes be reinforced inside to good advantage by triangular corner-pieces or posts, glued or screwed in place (Fig. 647).

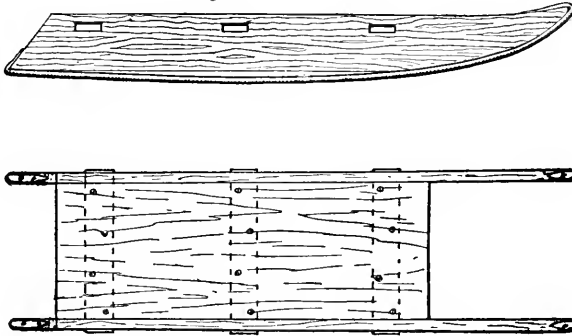


Fig. 648

161. Sled Making.—The runners and cross-bars of a sled (Fig. 648) should be of straight-grained oak, maple, ash, or other strong wood. $\frac{7}{8}$ " stock will do for the runners of a common hand-sled. Saw the curved parts of the runners with the band-saw, jig-saw, turning-saw, or compass-saw; or remove most of the waste wood with the common hand-saw, and trim to the line with drawshave, spokeshave, or plane. Get out the cross-bars about 2" wide and 1" thick, making a tenon with one shoulder at each end (Fig. 649).¹ In marking these tenons and the length of the cross-bars, lay the pieces flat upon the bench, clamp them together, and mark all at once (Fig. 4). To lay out the mortises, place the runners together on edge (Fig. 651) and square lines across both on the top edges at the points where the cross-bars are to go, 2" apart (or the width of the cross-bars). Continue these lines upon both sides of each runner. Set the gauge at $\frac{3}{4}$ " and mark the line AB (Figs. 652 and

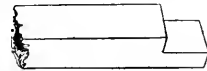


Fig. 649

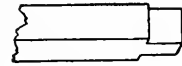


Fig. 650

¹ If the sled is large and heavy it may be better to make the cross-bars $1\frac{1}{4}$ " thick and to have two shoulders (Fig. 650).

653) upon both sides of each runner. Set the gauge again at $1\frac{1}{2}$ " and mark as before CD. Cut the mortises and tenons. (See page 144.)

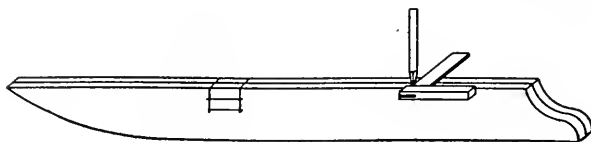


Fig. 651

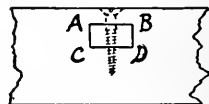


Fig. 652

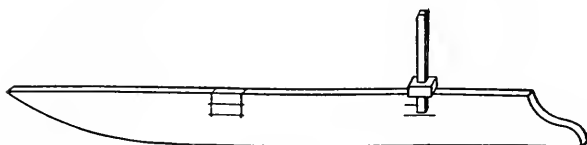


Fig. 653

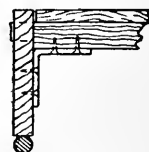


Fig. 654

After fitting, fasten each tenon with a screw driven down from the top edge of the runner. A small L-iron at each joint adds much to the strength (Fig. 654). The seat should be screwed to the cross-bars. $\frac{1}{2}$ " is thick enough for a common hand-sled seat. Apply a coat of linseed oil (hot is best) and finish with paint or with one coat of shellac followed by two or more coats of varnish.¹

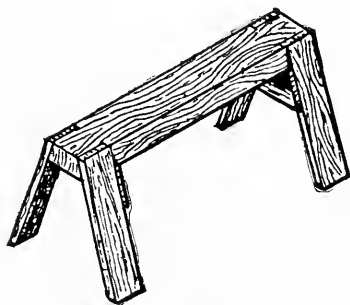


Fig. 655

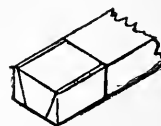
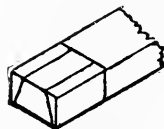


Fig. 656

162. Horses or Trestles (Fig. 655) may be from 18" to 2' 3" in height, or even more, as may be required. For the tops get out and square up pieces of pine from $1\frac{1}{2}$ " x 3" to 3" x 6". in section, and from 2' to 3' long.

¹ It is best to have the iron or steel runners put on before finishing, as the finish might be burned in fitting the hot ends of the runners.

Select the best sides for the tops and mark each end like Fig. 656 (showing top and bottom) with the pencil, square, and gauge, using the bevel, or

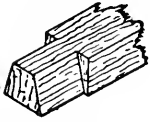


Fig. 657



Fig. 658

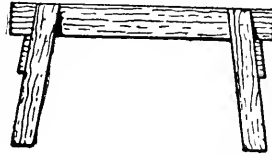


Fig. 659



measuring carefully that the slant may be the same for both legs. With saw, or saw and chisel, remove the parts marked (Fig. 657). Trim accurately to the lines. Get out eight legs of $\frac{7}{8}$ " stock, 4" or 5" wide (according to the size of the horses), and of such length as will give the required height, marking and squaring all together. Nail or screw the legs in place with 2" nails or $1\frac{3}{4}$ " screws, keeping the inner edges of the tops of the legs even with the tops of the horses (Fig. 658). Get out the cross-braces of $\frac{7}{8}$ " board and saw the ends at the same bevel as the legs. Use the bevel or measure the angle. Nail on the cross-braces. Saw or plane off the

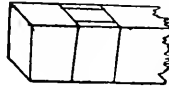


Fig. 660

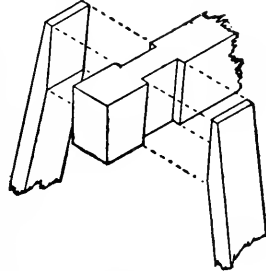


Fig. 661

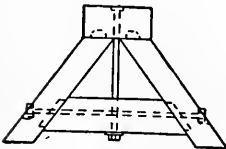


Fig. 662

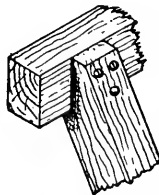


Fig. 663

projecting ends of the legs on top. If the horses do not stand evenly on a true floor see page 256. Smooth the tops carefully.¹

163. A Kennel, if small, can be made much like a common

¹ Fig. 659 shows a nicer form. Take two pieces of pine, or any wood not likely to warp, 2" x 3" (or 4") x 2½' or 3', mark the shallow gains (Fig. 660) for the legs, with rule, square, bevel, and gauge, and cut them with saw and chisel. Get out eight legs, and cut the upper ends to the required bevel (Fig. 661). Nail or screw them in place. The joints can also be glued. Fit on cross-braces as described above. Horses for heavy work can be made of plank or joist (Figs. 662 and 663).

box, but for a larger structure, as in Fig. 664, it is well to make a frame. Use small joists or strips of plank of any size from $1\frac{1}{2}$ " to 2". First get out the sills or bottom pieces, halving (see page 140) and nailing the corners. Fasten

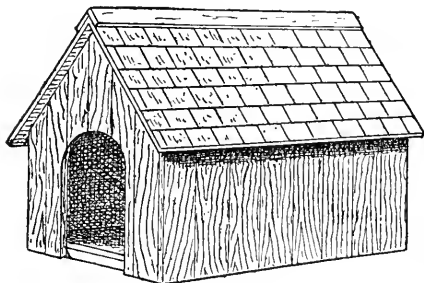


Fig. 664

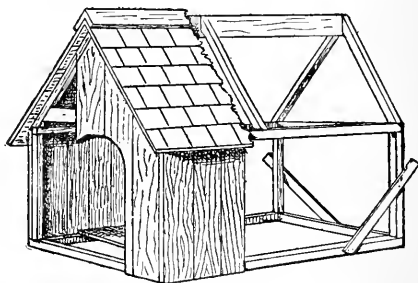


Fig. 665

the corner posts in place, and on top of them the plates (a second horizontal frame corresponding to the sills). Square the framework and see that it is free from winding. Hold it in place temporarily, until the boarding is put on, by diagonal strips (Fig. 665). Next get out rafters for the roof, with their ends cut at an angle of 45° , or whatever pitch is desired. Use a strip of board at the top for a ridge-pole. Lay the floor before the sides are put on. Cover the sides and ends with sheathing or matched boards laid vertically, and cut a doorway and a small window in the back gable. The roof-boards can be laid horizontally and shingled, or covered with other roofing material. Matched boards laid up and down and painted make a good roof, in which case a square stick about 2" square should be used for a ridge-pole. Put saddle-boards on the ridge. Paint with three coats. Another doorway is shown in Fig. 666.



Fig. 666

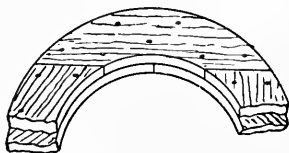


Fig. 667

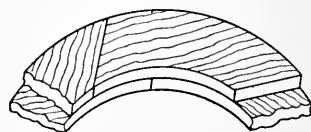


Fig. 668

164. Curved Forms.—Circular work is often built up in layers (Figs. 667 and 668), each made of several sections, "breaking joints" in the different

layers, and screwed or nailed or glued together. The ends can be cut squarely or obliquely. Sometimes a single thickness is halved, or otherwise joined, at the ends (Fig. 669). The grain of the pieces should cross as shown and the sections be fastened firmly, particularly near the ends. These methods apply both to small work, as picture frames, and to large forms, as cistern curbings. Even circular houses have been built in this way. More complicated methods are sometimes used.

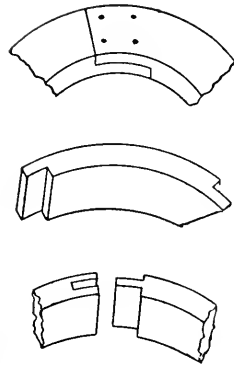


Fig. 669

To make a curved table-leg, for example, as in Fig. 670, the best way is to work it out of a solid square post.¹ This is best done with band-saw or jig-saw. After it has been cut to shape from one side (Fig. 671), the pattern must be marked again, but in transferring a flat pattern to a curved surface, the curves must either be drawn directly upon the wood to match the other side, or points in the curve projected from the pattern to the wood, as the shape will not be correct if the pattern be bent to fit the wood. The waste pieces can be used to block up the main piece if necessary (Fig. 672), so that it will rest firmly on the saw-table while sawing the second



Fig. 670



Fig. 671



Fig. 672



Fig. 673

time. If done by hand it is a good plan to make saw-cuts nearly to the line first, which lessens the danger of cutting or splitting beyond the line. (See page 33). Cabinet makers often build up such crooked forms by gluing on pieces where required, as in Fig. 673. This takes more time but less wood, and usually is the cheapest way. A solid piece is better, however, in most cases. To hold odd-shaped pieces for shaping, contrive some combination of clamps, hand-screws, or vise, with blocks if necessary. Fig. 199 gives a suggestion suitable to some cases.

¹ Baluster stock or "squares" can be bought of different sizes, suitable for such work.

165. A Canoe Paddle.—Spruce is a good wood, light, tough, and easy to work. Birch, maple, and ash are used. Select a very straight-grained piece, $1\frac{3}{8}$ " or $1\frac{1}{2}$ " thick. Draw a centre line along the side before marking the pattern (Fig. 674) as a help in making the outline symmetrical. From 5" to $6\frac{1}{2}$ " is a good width and from 5' to 6' a good length, but the exact dimensions are matters of individual preference. Saw the outline with band-saw, jig-saw, bow-saw, or compass-saw; or remove most of the wood with the hand-saw; or make saw-cuts nearly to the line (Fig. 91), and finally trim to the line with spokeshave, drawshave, chisel, or plane. Next draw a centre line along the edge, lay off the thickness at different points, and draw the outline of the edge. Taper the thickness of the blade toward the end, keeping the required midrib thickness along the centre line. Then gradually shave the sides from the middle to the edges with drawknife, plane, or spokeshave. Round the shaft with plane or spokeshave (see page 160), and shape the handle or knob with spokeshave, plane, gouge, chisel, and file. Smooth the whole paddle with scraper and sandpaper. Finish with one coat of linseed oil, one of shellac, and two or more coats of varnish rubbed down.



Fig. 674

166. Hull of Toy or Model Boat.—If the hull is not too large, it is best to cut it from a solid block; but if quite large, it may be necessary to build it in layers (Fig. 680), or to build up a block of several pieces, for it is hard to get suitable wood in large blocks and it has become very expensive. The wood should be thoroughly seasoned, straight-grained, and free from knots and checks. Nothing is better than white pine. Straight-grained mahogany is good, but costly for a large boat.

Take, for example, a simple model of the fin-keel type (Fig. 675).¹

¹ Three views are usually drawn for a boat: the *sheer plan*, the *body plan*, and the *half-breadth plan*. These correspond to the front or side elevation, end elevation, and plan in ordinary drawings (see page 217), and give side, end, and top views of the boat,—or of one half of it, as the sides are alike. Several equidistant horizontal lines are drawn across

To cut it from a solid block, square the block to dimensions, and draw upon the sides the sheer plan, or side view (Fig. 676). To remove the wood to this line with hand tools, either saw off most of the waste wood with the hand-saw

(Fig. 677), and then trim to the line with draw-shave, plane, chisel, or spokeshave; or make a series of saw-cuts nearly to the line (Fig. 91) and then trim as before. The shape can be

accurately and quickly cut with a band-saw or jig-saw. The surface need not be smoothed, as it will be cut away in rounding the hull later. Next, make a centre line lengthways on the top of the block and transfer the half-breadth plan on one side of this centre line (Fig. 676). Turn the pattern over and mark again on the other

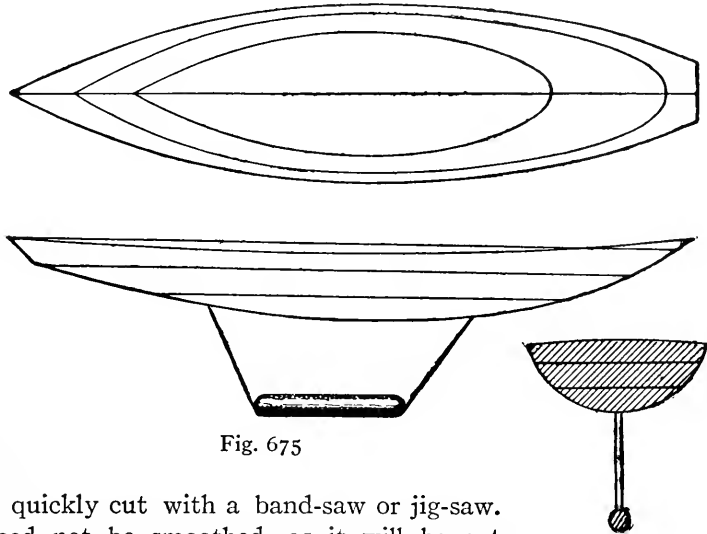


Fig. 675

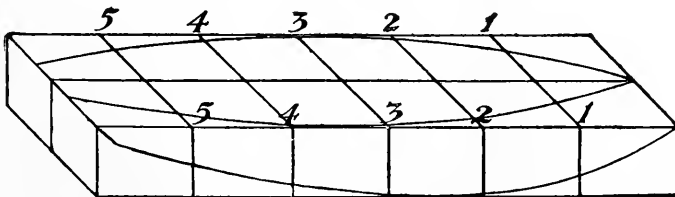


Fig. 676

the plans. One of these represents the line of the water when the boat has its proper load, and is called the load water-line. The other lines parallel to it represent other levels, at equal distances apart. Other lines also show vertical, horizontal, longitudinal, and cross sections, at regular intervals. These details are fully described in works on yacht (and model yacht) building.

side of the line. The centre line can be made on the bottom also. Cut the top outline as before. If band-saw or jig-saw are used, save the waste pieces cut off in sawing the sheer-plan and use them to block up the ends so that the piece can be held firmly while sawing the top outline. (See page 245.) The deck-sheer (Fig. 675) can now be cut or be left until later.



Fig. 677

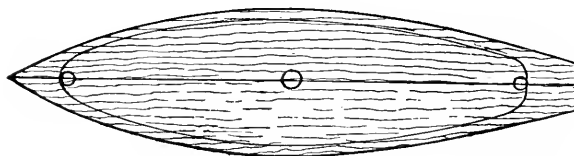
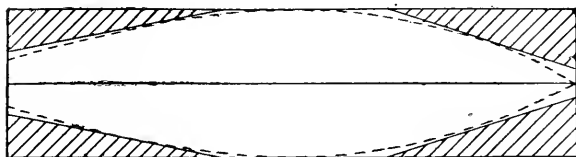


Fig. 678

different sections, and test the work by them. Before hollowing the inside, gauge a line around the top, $\frac{1}{2}$ " from the edge, except at the bow and stern, where a greater distance should be allowed (Fig. 678). The hull should be held firmly by clamps or in some way, so that both hands can be used in cutting. Bore one or more holes (according to the size of the boat) downward from the top (Fig. 678), but leave at least $\frac{1}{2}$ " of wood below them. Run a groove with a small gouge inside of the line marked (Fig. 678), and hollow out the hull with a larger gouge, cutting toward the middle. The holes will help.

Finally cut straight down from the line marked on the top, until the thickness of the sides is about $\frac{1}{4}$ " (Fig. 679). The gunwale should be

Fasten the block bottom side up in the vise, or upon the bench top and cut the outside roughly to shape, with the draw-shave, wide chisel, or spokeshave, working from the centre toward the ends, as a rule. The chisel can often be used across the grain (Fig. 92). Finish most of the shaping with spokeshave or plane. To make the two sides alike, and of the correct shape, cut templates, or patterns, of cardboard of the shape of the hull at

thicker than the rest, to stiffen the sides and give a bearing for nailing the deck. Below this point, make the thickness of the sides as uniform as you can, except that a thicker place can be left at the bottom where the keel is to be fastened (Fig. 679). One fourth of an inch is thin enough for any but a skilled workman to make the sides. Make templates for the inside. A good deal can be told by the sense of feeling, gauging the thickness between the thumb and finger. Use a flatter gouge for smoothing the inside. If the sheer of the deck has not yet been cut, mark it now, using a thin strip or flexible ruler (see page 21), and trim to the line. Sandpaper the outside, first with No. 1 or $1\frac{1}{2}$ and finally with No. 00. Apply at least two coats of paint inside and three outside. It is a good plan to use a coat of hot linseed oil first.¹



Fig. 679

Unless the boat is quite small it is well to fit in two or three deck beams to connect the sides and support the deck (Fig. 679). These can be of thin stuff (perhaps $\frac{3}{16}$ " thick and $\frac{1}{2}$ " wide), set on edge and slightly arched,

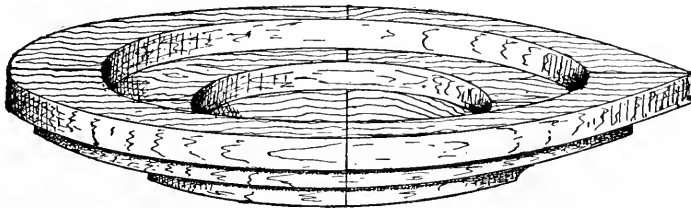


Fig. 680

with the ends fitted into gains cut in the sides, and nailed with fine brads. The deck should be thin ($\frac{1}{8}$ " or $\frac{3}{16}$ "). Mark the deck outline and cut it just outside of the line. Fasten small blocks of wood to the under side of the deck where attachments for the rigging are to be fastened. Paint the

¹ To build with layers a sufficient number of boards are sawed as in Fig. 680, glued together, and then trimmed to shape. This is not so safe a way as to use a solid block, for the joints are liable to separate after a while. In laying out the pieces, draw a centre line along each side and end, and a midship line across each side and edge, so that the layers can be put together accurately. The outside curves can be sawed by either hand-saw or jig-saw, but the inside ones require a jig-saw or bow-saw. In gluing the layers together use plenty of clamps or hand-screws, and put pieces between the jaws and the wood to distribute the pressure.

lower side, smear the top edge of the hull with thick white lead, and nail the deck in place with fine brads, perhaps $\frac{1}{2}$ " in length, or fine brass screws can be used. Trim the edge of the deck, and paint the outside. The deck can be set in a rabbet cut in the gunwale.¹

167. Furniture.—Begin with simple articles. First attend to the block-form or general proportions of the object. No amount of carving or inlaying, however beautiful in itself, will make an ill-shaped, badly-proportioned article a thing of beauty; while a well-shaped and well-proportioned object will be pleasing to the eye if free from decoration of any kind.

In undertaking a really nice piece of cabinet-work, you must hold yourself to a higher standard, as to accuracy of detail, than is necessary for much of the other work often done by amateurs. Many slight inaccuracies, of little consequence in the rougher kinds of work, become such conspicuous defects in cabinet-work as to detract much from the satisfaction which should be taken in home-made articles. Choose therefore simple forms, easily put together, for your first attempts.

First and foremost, when you come to the actual work, use thoroughly seasoned wood. This is an essential of making permanently satisfactory furniture. Be content with the more easily worked woods. Begin with plain, straight-grained material.

White pine is suitable for many things. It is one of the best woods to "stand" or hold its shape, and if not desired of the natural color it can be painted or stained. Whitewood, like pine, is easy to work, durable, can be obtained in wide boards, can be painted, and takes stain exceedingly well. Cherry, when soft and straight-grained, is easy to work and to finish, and is (when highly figured or wavy) one of the most beautiful woods. Mahogany is a wood of great beauty and durability, and holds its shape exceedingly well; but the beginner should confine himself at first to the lighter, softer, straighter-grained varieties. Oak in its softer, straight-grained forms is well suited to the work of the beginner. It is durable and an article made of oak will stand more abuse without serious defacement than if made of almost any other wood used for furniture. Quartered oak is a very satisfactory wood. It can be stained if desired. Many other woods are

¹ The fin can also be made of wood and screwed on, or be cut from sheet metal (brass or sheet-iron). The rudder can be fixed in a brass tube, the ends of which can be set in lead. The mast can also be stepped in a brass tube, or simply passed through the deck to the bottom, where it can be stepped in a smaller hole, or in a block.

used, as chestnut, sycamore, ash, birch, beech, maple, butternut. Buy stock that is as true as you can find and see that it is planed as true as possible.

The pieces, when fitted, should come together easily, and not require to be sprung, twisted, or bent in order to put the article together. It is the practice with skilled workmen to put a piece of furniture completely together once (without glue or nails) to see that everything fits right, before putting together permanently. This precaution should not be neglected. Put a piece of case work together horizontally upon horses or flat on its back or face, not in an upright position.

After fitting the parts of a piece of furniture and before gluing, smooth such parts as cannot readily be smoothed after putting together, as in tables and chairs where the rails are often below the surface level of the legs and had best be smoothed first. Surfaces which can be smoothed as well after the article is put together can be left until the end, because there is always the liability of injury during the process of the work. Adjoining surfaces which are to be flush, as door-frames (Fig. 479), should not as a rule be finally planed and smoothed until after gluing. Clamp the parts of the work together thoroughly when using glue. Allow time enough before removing the clamps.

It is surprising how much "out of square" and how winding the result of careful work will sometimes be if it is not tested as the parts are put together. In addition to applying the square to the angles, using the large steel square when you can, there are many cases in which measuring diagonals is a good test. Alter the angles of the work until the two opposite diagonals are equal, when the work will, of course, be rectangular. This is a good way for large case work, using a stick, or fitting two adjustable sticks (Fig. 9) between the angles, when the latter can be altered until the diagonals are equal. While testing for squareness, also look for winding, by sighting across the front or back, using winding-sticks (Fig. 228) if necessary. When the work has a back fitted in, as in the case of a bookcase or cabinet, this will help much in the final adjustment. It is well to use corner-blocks freely in the angles of furniture where they will not show (Fig. 200).

Furniture should always be finally hand-planed and scraped. You cannot get the surface too smooth, for slight defects become very noticeable in the finished work. For the work of the amateur no finish is better than shellac or wax. When the work is made of parts which can be readily separated—such as are joined without glue or nails—it is best to take the

work apart before finishing. Unhinge doors and take off locks, escutcheons, mirror-plates, handles, and the like. Take out removable shelves, backs, and all detachable parts. Finish all these parts separately and then put the work together again.

168. Picture and Mirror Frames made of prepared moulding will, in most cases, have to be mitred at the corners. This can be best done with mitre-box (see page 85), circular-saw (see page 89), or trimmer (see page 61). If the moulding is even slightly sprung or twisted this is hard to do and trimming with the plane is often necessary. The mitre shooting-board is sometimes useful (Fig. 85). None of the joints should be sprung or twisted to fit. Also guard against winding by sighting across the face, and test the angles with the square. The mitred joints are usually glued and nailed. (See page 142.) It is well as a rule to fasten the pieces in pairs—two corners diagonally opposite, and then the remaining corners. In some cases the

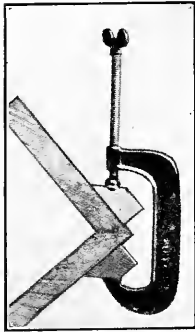


Fig. 681

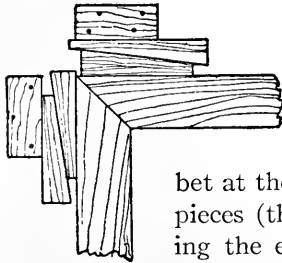


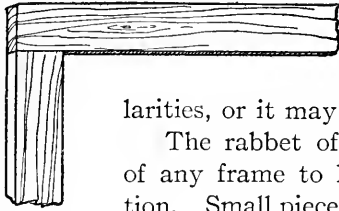
Fig. 682

work should also be clamped together. If the wood has not been finished blocks can be glued near the ends of the pieces and hand-screws applied (Fig. 681).¹

For a plain frame nothing is better than a joint with mortise and tenon (Fig. 683), the rabbet at the back being cut through to the ends of the shorter pieces (those having the tenons), but stopped before reaching the ends of the longer ones which have the mortises. (See *Circular-saw*, page 97.) The latter pieces should be got out too long, so as to overlap a little at the ends. The inside edge should be smoothed before putting together, but the final planing and smoothing of the rest should be done after the frame is glued together.

¹ Another way is to lay the frame flat, nailing strips a short distance outside of each of the corners and driving wedges between these strips and the frame (Fig. 682). Also by putting blocks at the corners, passing a doubled cord around and inserting a stick, the cord can be twisted until the frame is held tightly. Picture-frame makers have clamping devices.

In mitring a frame of rabbeted moulding, measure at the inner corner of the rabbet, so that the size will be right for the picture or glass. The rabbet is usually about $\frac{3}{8}$ of an inch square, and in laying out the dimensions of frame to fit glass, or of glass to fit frame, allow as much as $\frac{1}{8}$ of an inch for irregularities, or it may be necessary to trim either rabbet or glass.



The rabbet of mirror frames must be colored black—also of any frame to hold plate glass—on account of the reflection. Small pieces of plate glass can be held in place by strips,

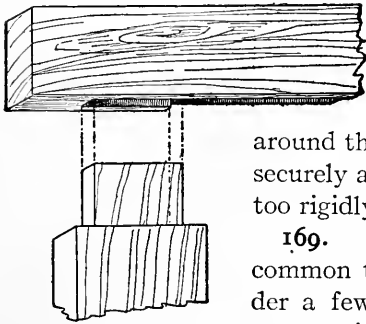


Fig. 683.

but large plates, as for a mirror, should be fastened by little pieces of soft pine, one or two inches long, bevelled on one side. These short pieces, glued on one side, and lightly pressed into the crack around the glass (Fig. 684), wedge the glass in place securely and, owing to the softness of the wood, not too rigidly.

169. Tables.—Most common tables come under a few types of construction. Fig. 685 shows a simple form.

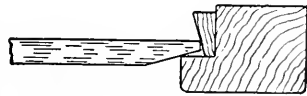


Fig. 684

The legs should be of plank and can be halved where they cross. (See page 140.) The rest can be of $\frac{7}{8}$ " stock. Extra cleats can be put under the top if needed for stiffness.

Figs. 686 and 687 show common forms, although

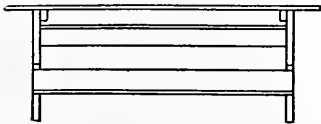


Fig. 685

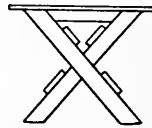
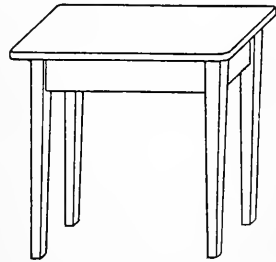


Fig. 686



the details of shape and design vary greatly. For a small or medium-sized table the legs can be from $1\frac{1}{2}$ " to $2\frac{1}{2}$ " square. Square them and cut to

length. The height of an average table is about 30", although many are made lower. If the legs are to be tapered toward the bottom, the tapering should not extend to the top but to a point a little below the rails, or cross-bars which, connect the legs. A good way is to taper the insides only,

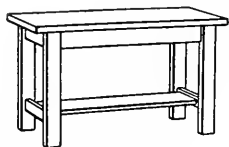


Fig. 687

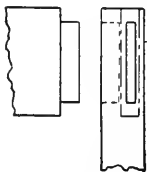


Fig. 688

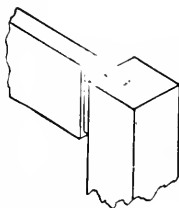


Fig. 689

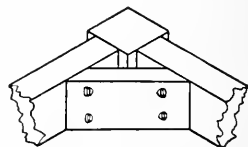


Fig. 690

leaving the outside surfaces straight. If to be tapered on all four sides, plane down two opposite sides and then the other two. Cut mortises on the two inner sides of the legs to receive tenons cut on the ends of the rails (Fig. 688. See page 144).¹ $\frac{7}{8}$ " stock

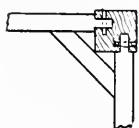


Fig. 691

is thick enough for rails for ordinary cases. When the parts are fitted, put together two legs and the connecting rail, using glue and clamping the joints securely until dry. Put the two opposite legs together in the same way,

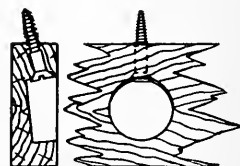


Fig. 692

and finally join these two sides with the remaining rails, gluing and clamping as before. Glue and screw corner-blocks in the angles (Fig. 690). The joints can also be pinned (Fig. 691. See page 148).

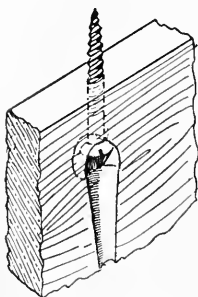


Fig. 693

To fasten the top of a table to the framework beneath, and in similar cases, first bore a large hole or "screw-pocket" on the inside of the rail, in a case like Fig. 692, an inch or so from the top, and bore down into this

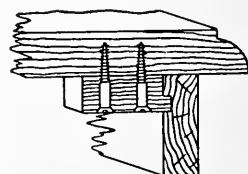


Fig. 694

¹ The mortises in heavy legs can be open at the top (Fig. 689), but this tends to weaken a slender leg.

hole with a slight slant from the top edge. A slanting cut can be made

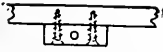


Fig. 695

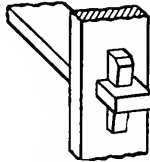


Fig. 696

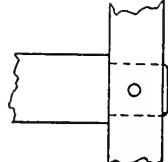


Fig. 697

from below with the gouge if necessary to allow the screw-head to pass (Fig. 693).¹ See *Counterboring*, page 177.

To put on the top, lay it face downward on the horses, place the frame of the table in position and screw to the top. It is well to leave the final scraping and sandpapering of the top until the table is put together.

Tables are often fastened partly by keys, wedges, or pins (Fig. 696), as explained on page 150. In some, all of the tenons run through and can be trimmed to protrude slightly (Fig. 697).

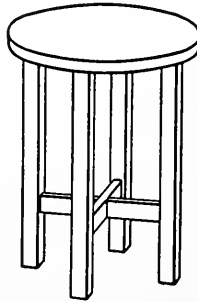


Fig. 698

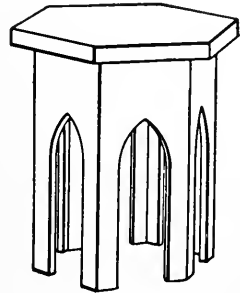


Fig. 699

The variety of small stands and tabourets is great. Designs like Fig. 698, and with the keyed construction referred to, are common. The cross-pieces are halved where they cross and a similar arrangement is used at the top, to which the top of the table is screwed. Octagonal or hexagonal tabourets (Fig. 699) require especial care in making the vertical bevelled joints where the sides meet. First bevel the edges, then saw the pattern required to form the legs. Some device must be used to prevent the joints, and the clamps also, from slipping after the glue is applied. Blocks of soft pine can be glued on temporarily for the hand-screws to press against on the principle shown in Fig. 700. A tongue or spline is sometimes in-

¹ Another method is to fit small blocks into mortises in the rails and screw these blocks to the under side of the table (Fig. 694), or blocks can be screwed to the inside of the rail (Fig. 695). Metal fastenings and L-irons are also in common use.

serted (Fig. 701). Where the hand-screws are to be applied to the edges of the legs, pieces of soft pine can be fitted to receive the pressure. Glue two sides at a time, and then glue these joined sections together. Fit and glue in corner-blocks inside wherever they will not show. Screw and glue blocks inside at the top, and screw the top on through these blocks without glue (Fig. 702).

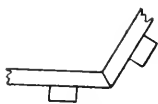


Fig. 700

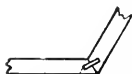


Fig. 701

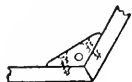


Fig. 702

Fig. 475 shows a few simple mouldings used for the edges of table-tops. To shape the ends of table-legs where they project through or above the top, see page 263.

If a table, or other four-legged object, does not stand evenly on all four legs, place it on a true surface, level the top by wedging under the legs

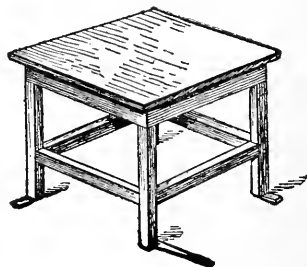


Fig. 703

until the corners of the top are equally distant from the surface on which the object stands. Then set the compasses at a distance equal to that at which the end of the shortest leg is raised (Fig. 703), and scribe around the other legs, which can then be cut off. See also page 87.

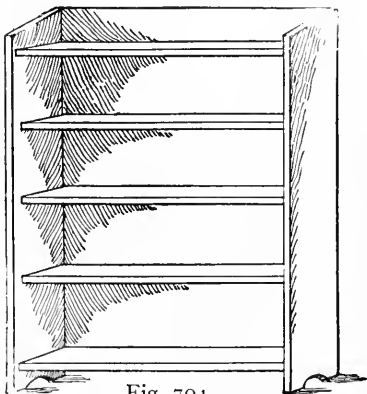


Fig. 704

170. Bookcases, Cabinets, and similar work. A plain case (Fig. 704) can be nailed together,

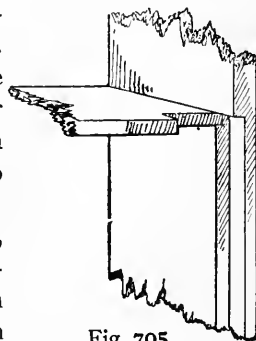


Fig. 705

but it is more workmanlike to groove the shelves into the sides¹ (Fig. 705),

¹ In nice work, as fitting a shelf in a bookcase, do not fit the entire end of the shelf into a groove, but cut a tongue or wide tenon on the end of the shelf, with a shoulder at

or the top and bottom shelves can be grooved into the sides and those between be movable. The back can be fitted by cutting a rabbet on the back edge of each side for the entire length and making the shelves of such a width that they will not project beyond it (Fig. 707). A narrow piece can be screwed on the back of the case to show above the upper shelf. The back can then be screwed in place. The back for little cases,

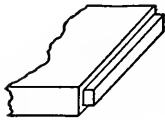


Fig. 706

such as hanging wall-cabinets, etc., can often be best made of a single board, but this should only be done for small work as the expansion and contraction of a wide board, or of several glued together,

is liable to injure the case (see page 211). A back made of a single board should be firmly screwed at the middle of the top and bottom, but a little play allowed at the sides. A back can be made of $\frac{7}{8}$ " matched boards or sheathing, or halved (Fig. 708) for a plain case of this kind. Another way is to make the back of upright pieces alternately thicker and thinner, giving a panelled effect (Fig.

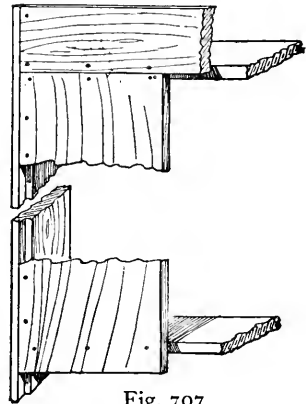


Fig. 707

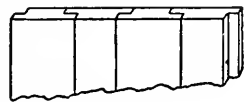


Fig 708

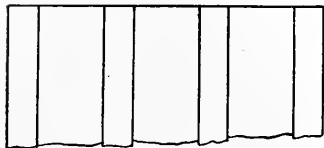
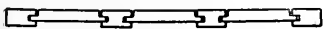


Fig. 709

709). Do not force the back tightly into place but allow a little room for expansion and contraction sideways, and use screws of only medium-sized wire, passing through holes in the back large enough to allow a little play—except for the pieces at each side, which can be screwed in place as firmly as possible. (See also page 211.)

Bookcases of the type shown in Fig. 710 involve no new principles. The shelves should be grooved as just de-

each side and the front edge, to fit into a corresponding groove, as in Fig. 706. See *Dadoing*, page 159.

scribed. Corner brackets under the lower shelf will stiffen an open case. In low open cases, like this, a thin plank ($1\frac{1}{8}$ " to $1\frac{1}{2}$ " thick) is often best for the upright sides.

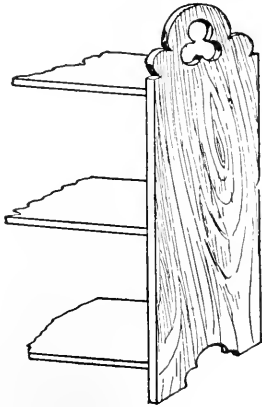


Fig. 710

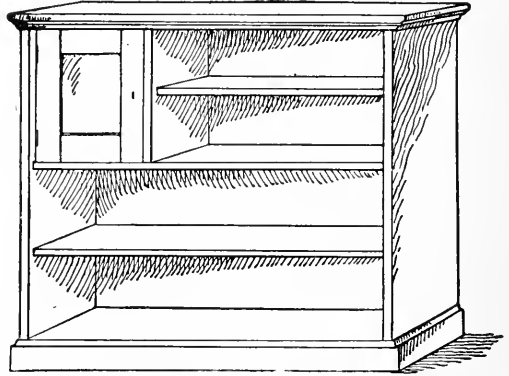


Fig. 711

A common form of case is shown in Fig. 711. The upright sides can well be of plank thickness, but $\frac{7}{8}$ " stock will do for a small case. The rest can be of $\frac{7}{8}$ " stock. It is best to groove the sides into the top, and the bottom shelf into the sides. The other shelves can be movable if desired. The baseboard can be bevelled or moulded on the top edge, and mitred at the corners. The piece in front can be glued and also the mitred joints. Fine nails can also be used but the side pieces should be glued at the front ends only. A moulding, mitred at the corners, can be nailed around under the top board as shown, glued in front and at the corners only. The sides of such cases are often made of $\frac{7}{8}$ " stock and the front edge faced with a strip glued on, from $1\frac{1}{4}$ " to 2" wide, according to the size of the case (Fig. 712). This gives a heavier appearance to the sides, and the shelves can fit behind the facing strip.

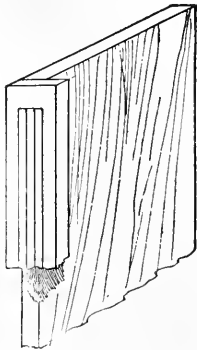


Fig. 712

Reeds can be worked on the facing strip (Fig. 712). For moulding at the edge of the top, it is the most workmanlike way to work all mouldings on the solid wood, using as thick wood for the top as may be

required. This avoids putting on moulding across the grain of the piece to which it is fastened, which is not a scientific way. A common way is to make the top of two thicknesses and to mould the edges before the two are glued together.

The best way to make the back for nice work is to make a panelled frame,

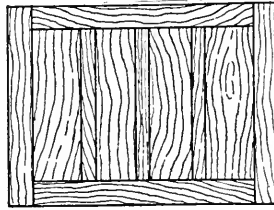


Fig. 713

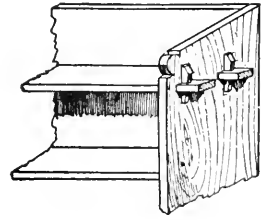


Fig. 714

ly in place as one piece (Fig. 713), the size and arrangement of the panels depending upon the size and shape of the back. (See also page 257.)

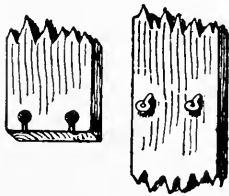


Fig. 715

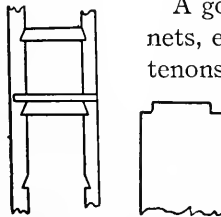


Fig. 716

A good way to put bookcases, cabinets, etc., together is with projecting tenons fastened with keys or pins. (Fig. 714. See also page 150.)

These few principles to be observed in making bookcases apply also to many cabinets, music-cases, magazine-cases, and the like.

171. Shelves.—Where the wood is expensive it is common to make shelves of whitewood or pine, and to face the front edge with a strip of the same wood as the rest of the case. Removable shelves can rest on cleats at the ends, but this does not always look well, and the position of the shelves cannot be readily changed. Movable metal supports are cheap. Screw-eyes can be screwed into the sides under the shelves (Fig. 715), and recesses cut on the under side of the shelves to fit the screw-eyes. Fig. 716 shows a common way. The vertical strips can be laid on edge side by side, clamped together, and the notches laid out and cut as if there were but one piece, but it is quicker to cut the notches on the side of a narrow piece of board, which is then sawed into the desired strips or "ratchets," with the circular-saw. Or holes can be bored in a strip and the strip then sawed apart (Fig. 717), and cleats with rounded ends used.

172. Drawers.—It takes a very good workman to make well-fitting and smoothly-running drawers, but the beginner should understand the operation, even if he may not attain the highest degree of skill in its execution.

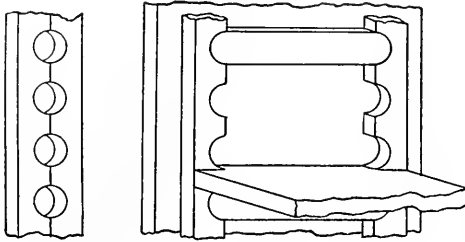


Fig. 717

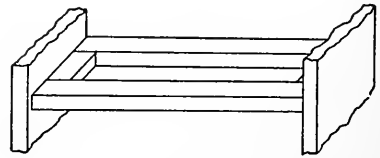


Fig. 718

The more accurately the case which holds the drawers is made, the easier it is to fit the drawers. In good work, a horizontal frame (Fig. 718) is fitted beneath each drawer for it to run on and can be grooved into the sides of the case like a shelf (see page 256). These frames, as well as the whole

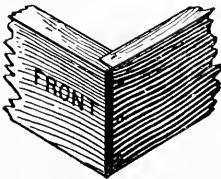


Fig. 719

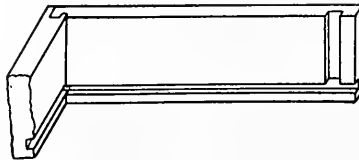


Fig. 720

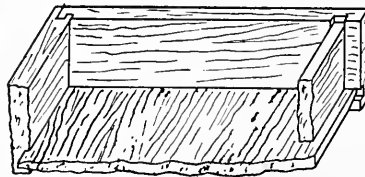


Fig. 721

case, should be free from winding, and the stock for the drawers should be true. The front and sides of a drawer should be got out to fit very snugly. The front piece is nearly always thicker than the sides, back, and bottom. If the front is $\frac{7}{8}$ ", the sides are usually about $\frac{1}{2}$ " or $\frac{3}{8}$ ",

but the dimensions are governed by the size of the drawer. The front of the drawer should be of the same kind of wood as the outside of the article,

but the sides, back, and bottom are often made of whitewood, pine, maple, etc., though sometimes the same wood is used throughout.

The order of the process is: 1st, to get out the pieces to the required dimensions; 2d, to make the joints for the sides, front and back; 3d, to cut the grooves for the bottom in the sides and front; 4th, to fit the parts together. The piece for the back is narrower than the front piece, to allow for the bottom (Fig. 721), and is often cut off at the top also. Dovetailing (see page 154) is the best joint for a drawer, but is difficult for the beginner. The joints shown in Fig. 719 can be used for ordinary work. These can be quickly made by machinery (see *Circular-saw*, page 95). Cut the groove for the bottom on the inside of the front and of the sides (Fig. 720) with the plow or circular-saw.¹ Smooth the insides of the pieces before putting the drawer together. When these parts are glued and put together, slip the bottom (previously fitted) into place. It should be got out with the grain running across the drawer, or parallel with the front (Fig. 721). Glue it at the front edge only, so that the rest may be free to swell and shrink without injuring the drawer.

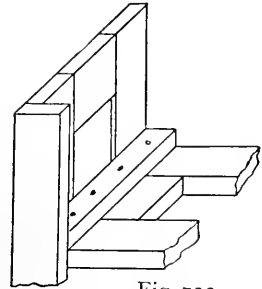


Fig. 722

Be sure that the drawer is rectangular (putting in the bottom will assist in this) and free from winding. Test with the framing square. When put together and dry, carefully smooth the front and the sides. A little trimming with the plane may be required to make the drawer run freely, but care should be taken not to plane away too much. When there is a space at the sides of the drawer, small slides for the drawer to run between are fastened at each side next to the drawer at the bottom (Fig. 722), and must be adjusted carefully to fit.

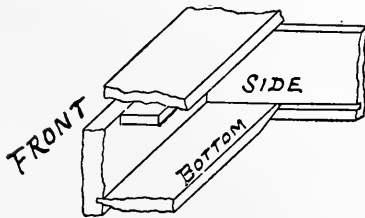


Fig. 723

Thin blocks or "stops" (Fig. 723) can be fastened on the under side of the cross-frame so that the inside of the drawer front will strike against

¹ It is common to bevel the under side of the bottom at the edges to fit the groove (Fig. 723). Thus the groove need not be so wide as the thickness of the bottom.

them when pushed in as far as it should go; or the drawer can be stopped at the back. It is easier to make a drawer which is narrow and long (from

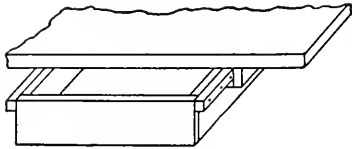


Fig. 724

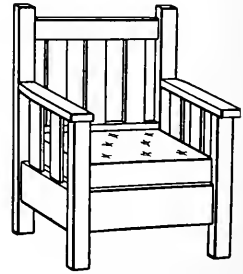
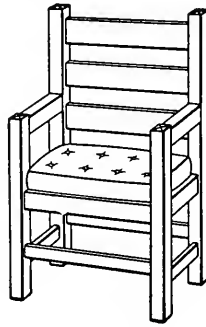


Fig. 725

front to back) run smoothly than one which is wide across the front, but short from front to back. A drawer which is a trifle larger at the back than at the front will run best, as it will be less likely to bind or catch. A simple way to attach a drawer under a shelf, bench, or table is shown in Fig. 724. Bayberry tallow is excellent to rub on the sides of drawers.

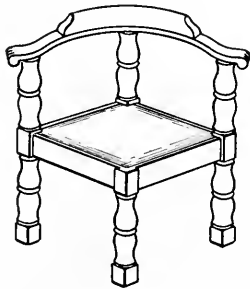


Fig. 726

173. Chairs.—Many kinds of chairs are too hard for a beginner to undertake, unless he has unusual skill, particularly those forms in which the legs, backs, rungs, etc., are fitted at odd angles. A plain rectangular type (Fig. 725), does not require more than ordinary skill. The joints should be mortised, glued, and pinned.¹ The height of the seat of an ordinary chair of this kind is about 18".

The joints of the frame of a corner-chair, as in Fig. 726, should be mor-

¹ Dowelling is a common method of making the joints of cheap chairs, and of many which are not cheap in price, and is used in most chairs in the market because easily and cheaply done by machinery. It is not to be recommended, however, in most cases, for it is not so well calculated as mortise and tenon to withstand the severe strain to which chairs are subjected. Of course where rungs or other members are used of such shape that the ends would naturally be rounded into pins or dowels, the same method of fitting is used as in fitting a dowel into one of two pieces.

tised, except that dowels can be turned at the tops of the posts for the curved back and arms. The back and arms are got out in three pieces, on the principle of the circular work shown on page 244, glued, and screwed together from the under side. A rabbet can be cut for a seat-frame to be upholstered, or rush- or cane-seated, or covered with leather. Seats of odd chairs like this are often less than 18" in height.

A plain Morris-chair (Fig. 727), simple-framed stools, crickets, and the like, involve the same principles of careful and accurate planning and mortising already described. If a chair does not stand evenly, see page 256.

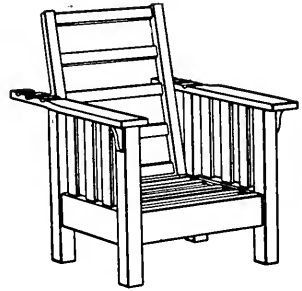


Fig. 727

Rocking-chairs can well be avoided by the beginner, not merely because of the angular character of the work, but also because it calls for skill and experience to design a rocking-chair so that it will balance and rock properly.

The ends of chair posts and legs, table legs, and other square posts are often finished like flat pyramids (Fig. 728), sometimes with the four faces



Fig. 728



Fig. 729



Fig. 730



curved (Fig. 729). In each case plane first two opposite sides and then the other two. Sometimes the edges are simply bevelled or rounded (Fig. 730).

For seats which are to be upholstered, a shallow rabbet is sometimes cut around the top rail of the seat on the outside (Fig. 731) to receive the cloth or leather covering. Sometimes

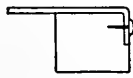


Fig. 731

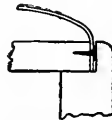


Fig. 732

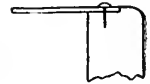
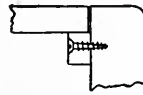


Fig. 733

a frame is made, upholstered independently, and placed on a rabbet cut around the inside of the seat-frame or upon a ledge screwed on inside (Fig. 732). Seats of leather or other material can also be fastened

in a shallow rabbet cut as in Fig. 733.¹ For rush seats, or woven leather, cord, or the like, round or rounded rungs should be used. A seat can be of wood fastened on top of the seat rails, either fitted between the legs (Fig. 738) or on top of them, and with the grain of the wood running from front to back. If fitted around the legs, lay the chair wrong side up upon the seat, and scribe the corners to be cut out with knife and square. Cut out the corners and screw on from underneath up

¹ Upholstering is a trade in itself. The woodworker should, however, know how to upholster a plain seat for a chair or the top of a box. First, in the case of a chair, stretch

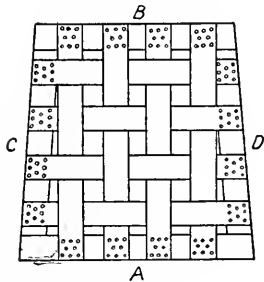


Fig. 734

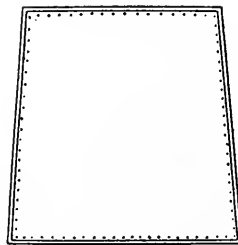


Fig. 735

webbing made for the purpose tightly across the frame and tack securely (Fig. 734) turning the ends under. Tack over this burlap (Fig. 735). On this spread the curled hair or whatever material is used, and then a sheet of cotton-batting (cotton-wool), and cover the whole with cambric or other cloth, (Fig. 736). This prevents the

hair working through the

cover. To put this on evenly, stretch from the middle of one side to the middle of the opposite (A and B, Fig. 734), tacking over the edge. Next at the middle of the two other sides (C and D, Fig. 734). Then work by degrees toward the four corners, finally folding, and cutting off if necessary the surplus cloth at the corners. The edges, unless selvaged, should be turned under. The final covering is put on in the same way. In nailing on leather, etc., with ornamental headed nails, first tack the material in position with small nails and then drive the ornamental nails so as to cover the heads.



Fig. 736

Where strips of reed, or whatever similar material is used, can be simply wound around as on a reel, a strip can be carried around in one direction, as from side to side of the seat, and then

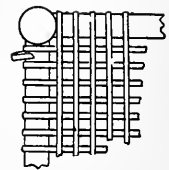


Fig. 737

woven over and under the other way from the front to the back of the seat. It can also be wound around in two or three directions, leaving regular spaces (Fig. 737), and then weaving over and under until the spaces are filled. The ends can be held by driving in pegs. A bent needle, made of a little strip of metal with an eye in one end, is used for the weaving. Where the cane passes through holes, as in the common cane-seated chair, and is woven in various patterns pegs are driven into the holes to keep the material already woven taut while the weaving progresses.

through the rails, or if the latter are quite deep, counterbore (Fig. 505). A frame with holes bored near the inner edge, and cane-seated or covered with leather or other material (Figs. 731 and 732), can be fastened on in this way. All edges against which rushes, leather thongs, or cord bear should be cut slanting or rounded, to prevent undue wear. Frames for seats should be made with mortise and tenon (see page 144).



Fig. 738

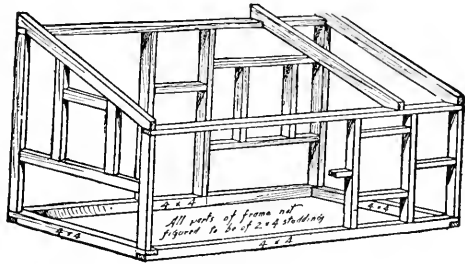


Fig. 739

174. **A Small Building with "Lean-to" Roof.**—Fig. 739 shows the construction of a small building with "lean-to" roof—a form of roof suitable for small buildings and easy to construct. Halve the ends of the sills, or horizontal timbers at the base of the build-

ing. Toe-nail the upright corner posts, and also the other upright members or studs, to the sills. The plates, or lengthways horizontal members



Fig. 740

at the top, can be nailed down on top of the posts and studs. The remaining pieces can be nailed through or toed as may be required. Use $3\frac{1}{2}$ " and 4" nails. Level the sills (see page 19). Square them also. Applying the steel square is usually sufficient for a small structure. (See also p. 223.) Plumb the corner-posts (see page 19). To keep them in place nail on lath-strips.

The roof timbers or rafters are easily fitted as shown. The boarding on the roof must run lengthways. Begin to lay the roof-boards at the

lower side. They can overlap a little to shed the water, and can have a strip nailed on at the edge if desired, but flush at the top. The roof can be covered with shingles (see page 178), with tin or other metal, or with one of the numerous roofing fabrics. If desired to have the roof overlap more, the rafters can be made longer than shown. To have the roof boarding run the other way omit some of the middle rafters and run roof timbers (purlins) lengthways on top. Saw the ends of the boards off after they are laid,

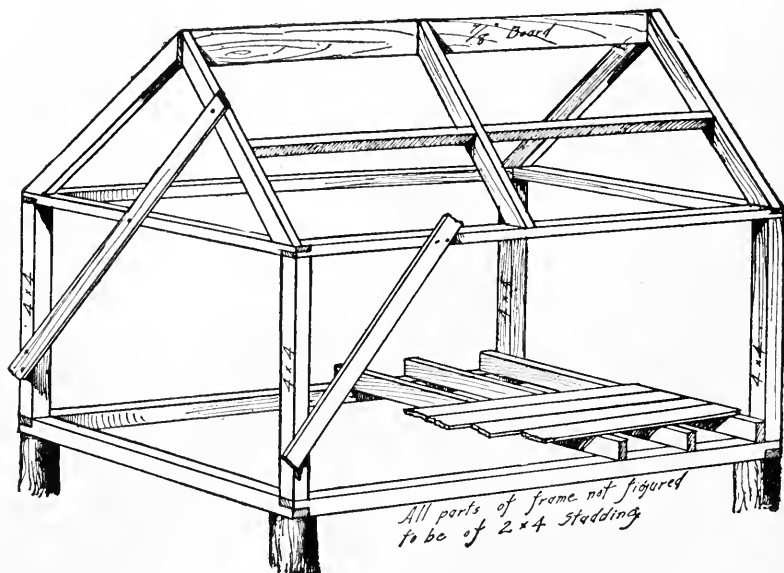


Fig. 741

marking with a chalk line (see page 19), or with a straight-edge and pencil. Two-inch nails will do for the boarding. A very flat roof is not advisable for shingling.

The sides can be boarded vertically. Matched boarding is good and can be painted, or rougher boarding¹ can be used and covered with shingles or clapboards. (See pages 178 and 179).

175. The Framing of a Small One-story Building.—First get out the

¹ If you need to pound the edge of matched boarding or flooring, fit to the edge a waste piece of the same kind and strike that (Fig. 740).

sills, halving the ends as shown; also the plates (the horizontal members at the top over the sills) and the corner posts. Then put these together as shown in Fig. 741, squaring and plumbing carefully and holding



Fig. 742



Fig. 743

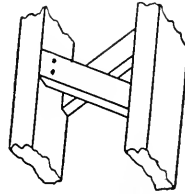


Fig. 744

temporarily by the stay-laths shown. Fit vertical studding at each side of the door-space and window-spaces, allowing a little more than the actual widths of the door- and window-frames. Also fit horizontal pieces above the door-space and above and below the window-spaces, and anywhere required to stiffen the frame or for nailing the boarding. It is well to nail in short corner braces with the ends cut at 45° where the posts meet the sills and plates, to stiffen the frame (Fig. 742).

It is easiest to lay the floor next. Floor-beams can be laid on the sills as shown. If the building is very small, 2" x 4" may do, but if 6' or more in width the floor-beams should be 6" or 8" in depth, for a floor of moderate size. Place one floor-beam at each end next the posts, to which it can be nailed. The floor-beams should be about 18" apart or less, according to size and the stiffness of floor required.

Toe-nail them to the sills, and afterwards nail to the studding where practicable. "Size" them on the under edge at the ends (Fig. 743) before laying, if they are not of exactly the same



Fig. 745

width. Unless sized to equal width the floor will be uneven. If the floor-beams are more than 6' or 8' long, they should be "bridged" every six or eight feet (Fig. 744), to distribute the pressure upon them.

Next lay the floor boards lengthways of the building. For all but very cheap buildings it is best to lay a double floor. The lower layer can be of cheap boards. Between the two floors lay sheathing or roofing paper. The best floor boards are matched not merely at the edges, but at the ends also, and are hollowed or "backed out" on the under side. Pry each board tightly against the one last laid with a chisel (Fig. 745) before nailing.¹ Under boards which are not the full length must be sawed so that the ends will be butted over the middle of a floor-beam, and such joints should be arranged to alternate or come at different points of the floor.

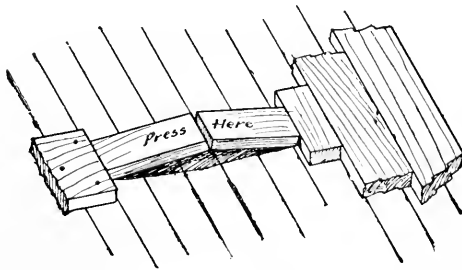


Fig. 746

The upright studding can now be put in, or this can be done before laying the floor. Studs must be placed at each side of the door- and window-spaces, leaving a little more than the width of the frames to allow for irregularities and to ensure getting them plumb. If the windows are to run with weights, enough extra must be allowed to form the "pockets" in which the weights can run. The doors, window-frames, and casings can all be bought ready made, and it is well to have them on hand before setting the studding, to prevent mistakes. Also put heading pieces of studding across above the door-space and above and below the window-spaces. Place the rest of the studding 16" apart (centre to centre) if the building is to be lathed and plastered. If it is to be unfinished inside, the studding can be arranged at other distances if thought best. The sides can now be boarded up. Begin at the bottom.

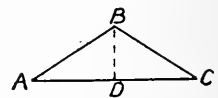


Fig. 747

If the building is quite small 2" x 4" studding will do for the roof timbers.

¹ If more force is required a toggle-joint arrangement (Fig. 746), or other similar device can be contrived.

But if 12' or more wide, 2" x 6" is as small as should be used. To lay out rafters (Fig. 747): AD is the "run" of the rafter, and BD the "rise." If the height of the roof is one half the width, it is called one-half pitch; if one third the width, one-third pitch; if one fourth the width, one-quarter pitch.

In laying out with the steel square it is usual to take the run as one foot and the rise as some number of inches, according to the pitch of the roof, which for one-half pitch is twelve, for one-third pitch is eight, for one-quarter pitch is six. To lay out one-third pitch, take distances twelve on the tongue and eight on the blade, and place the square as in Fig. 748, moving it along as many times as there

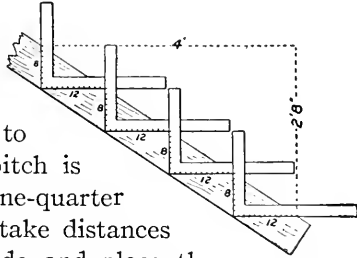


Fig. 748

are feet in one half the span. In this case four times, which gives the right length for a rafter for an eight-foot span, and the angles for cutting the ends can be marked directly by the square, the blade being at the right angle for the vertical or "plumb" cut, and the tongue for the horizontal or "foot" cut. If the half span is not an even number of feet, in moving the square the last time

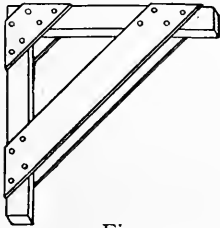


Fig. 749

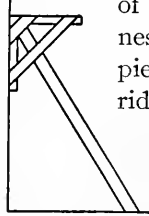


Fig. 750

take the number of inches on the tongue instead of twelve.¹ Allow for one half the thickness of the ridge board (for which a piece of $\frac{7}{8}$ " board on edge will do). The ridge-board is often omitted. The end rafter and the ridge-board can easily be raised and nailed in place by two persons, being temporarily stayed by a board or "stay-lath" (Fig. 741).

Ladders can be used for the construction of the upper part of a small building, but a staging will facilitate the work. The construction of a plain staging is so simple that it can be learned at a glance where any building operations are going on. Always use as many as two nails at each nailing place in a staging. Fig. 749 shows a good form of bracket to hold a staging,

¹ All such problems can be figured out mathematically, or can be laid out on a small scale on paper or full size upon a floor, but it is much quicker to use the steel-square as shown.

easily made, and held in place by a brace (Fig. 750), or by bolting to the building.

After the rafters are all in place, board the roof, beginning at the bottom. The roof can then be shingled (see page 178), or covered with any other roofing material, finishing with saddle-boards along the ridge. It is common to put a narrow board or moulding where the roof overhangs, as will be seen by inspecting other small structures.

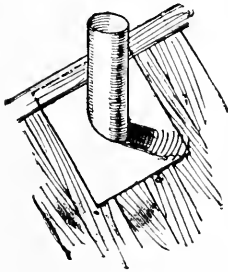
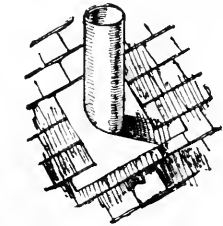


Fig. 751

At the door-space put a threshold and door-frame and casing. The arrangement of these details will be readily understood by examining them in almost any wooden building. Between the casings and the boarding lay strips of sheathing paper, projecting a few inches all around, so that cold and dampness will not come in through the cracks between the casing and the clapboards or other outside covering. Corner-boards and water-table can next be put on. The top edge of the water-table is usually bevelled (Fig. 507), and the water-table is sometimes omitted. The sides can now be clap-boarded or shingled. It is a great protection to cover the walls with sheathing paper first. The door- and window-casings must be "flashed" (see

page 180), and there must also be flashing where the chimney comes through the roof. If a pipe is used for a chimney, see Fig. 751.

If the inside is not to be plastered or sheathed, the timbers of the frame can be planed by machine, in cases where appearance is an object. If the roof is to overhang, use longer rafters and cut the ends as in Fig. 752. Floor timbers are often let into gains in the sills or girders, and sometimes hung by stirrups, but for simple work [the way shown is good. Rafters can be braced by collar beams,—horizontal pieces of board nailed across in the upper part of the roof (Fig. 752). Fig. 753 shows an arrangement of

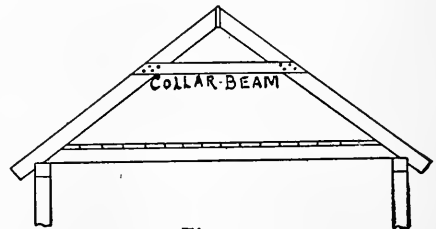


Fig. 752

floor timbers for a garret, nailed to rafters and plates. Upright sheathing of matched boards is suitable for the walls of small buildings. Vertical boarding, with the cracks covered with battens (Fig. 754), is sometimes used.

For stairs, take two pieces of plank 2" x 9" or 10", and having determined the points for the top and bottom of the stairs, mark the notches with the steel square on a similar principle to that used in laying out rafters. (See page 269.) You can mark on a stick the height from the top of the lower floor to the top of the upper. Divide this distance on the stick into as many parts as you wish to have steps, and you can use this stick as a gauge to determine the points for the notches for the steps.¹ After these notch-boards or string-pieces have been cut

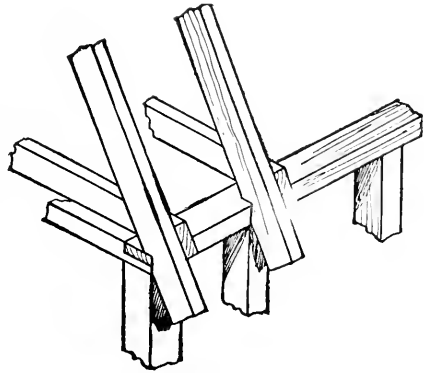


Fig. 753

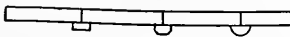


Fig. 754

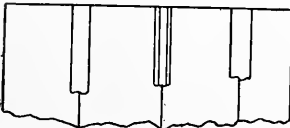


Fig. 755

and put in place, you can easily get out and nail on the "risers" or upright boards, and the "treads," or horizontal ones. It is best to have the treads not less than 9" wide when you can, and 10" is better, while 7½" or 8" will do for the risers.

A "header" or cross-piece (Fig. 755), must be securely fastened between the second story floor-beams where they are cut off to make the opening at the head of the stairs. The same thing must be done wherever timbers are cut off for the chimney, allowing an air space to prevent the wood becoming overheated by the chimney.

In a two-story building a common way to arrange the framing for the second floor is shown

¹ To find the number of steps for a given situation, find the height, as just shown, from floor to floor, 102" for example. Assume for trial a satisfactory height for each step as

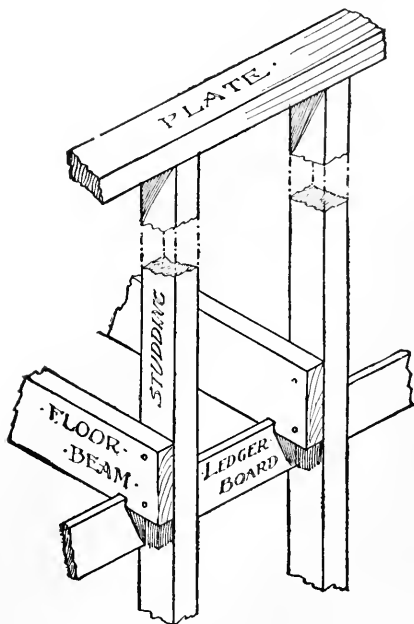


Fig. 756

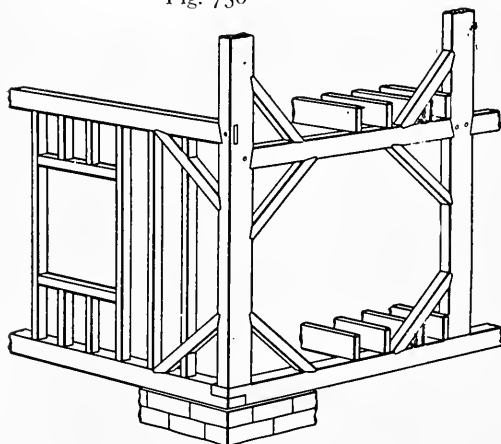


Fig. 757

in Fig. 756. This does very well for a small, cheap structure, but for an important or large building, the floor timbers should bear on beams which are a part of the frame (Fig. 757). Fig. 757 shows a frame for a good-sized building.

176. A Flat-bottomed Row-boat.

—(Fig. 758). Use straight-grained stock, free from large knots, checks, or other defects. Pine is excellent, or cedar. First cut out the sides of $\frac{7}{8}$ " stock, as is Fig. 759, cutting the ends at a slant to give whatever rake may be desired at stern and stem. Get out a stern-piece (Fig. 760), which can well be somewhat thicker than the boards used for the sides. Make a middle mould (Fig. 761)

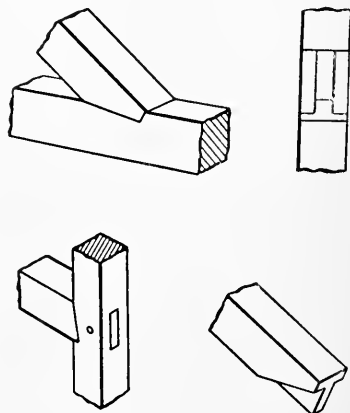


Fig. 757a

7". Divide 102 by 7, which gives $14\frac{4}{7}$ for the number of steps. To make the number even, call it 14, and you have only to divide 102 by 14 to get the exact height of each step.

of the same length as the width of the boat at the widest point, and of the general shape shown in Fig. 761. The slant at the ends should correspond to the flare which the sides of the boat are to have.

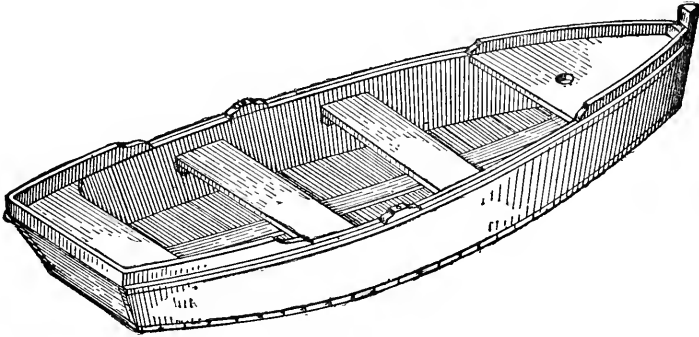


Fig. 758

Cut a bow-piece or stem of the general shape shown in Fig. 762, taking especial care to cut the rabbets accurately. Arrangements like Figs. 763 and 764 are sometimes used.



Fig. 759

The sides are bent around the middle mould and nailed to the stern-piece (which will require bevelling at the edge to make a close fit) and to the



Fig. 760



Fig. 761



Fig. 762

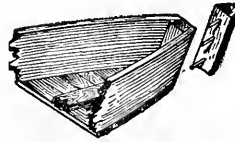


Fig. 763



Fig. 764

stem (the rabbets of which can be trimmed to fit if necessary). These joints should be painted with white lead before nailing. Use copper or galvanized iron nails.

The lower edges of the sides must be bevelled with the plane for the bottom boards. The amount to plane off can be determined by laying a

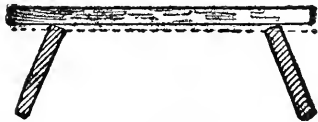


Fig. 765

board across (Fig. 765). Get out the bottom boards of $\frac{7}{8}$ " stock, with the edges carefully jointed, and nail carefully to the sides with $2\frac{1}{4}$ " or $2\frac{1}{2}$ " nails, first painting the edges of the sides with white lead. Get the bottom boards out a little too long and saw off the ends after nailing. It is well to bore holes

for all nails which come near edges. The edges can be fitted as accurately as possible, trusting to the swelling, which is sure to occur, to make water-tight joints.

To caulk the joints, make them slightly open on the outside, run white lead into the cracks, and then force into them oakum, cotton-batting, wicking or something of the kind. Roll the material into a loose cord, unless already in that form, and force it into the cracks with a putty knife, or anything of the kind. A regular caulking iron is not necessary for a boat of this kind. Force the material in firmly and thoroughly, and then apply white lead plentifully to the joints. On the same principle wicking or strips of flannel can be laid in white lead along the edges of the sides before nailing on the bottom boards. If the boat is not very large, plain sheathing, or matched boards, can be used satisfactorily.

If the middle mould will be in the way if left in place, it can be removed as soon as you have put in enough seats and any other braces necessary to keep the sides in position. Fasten wale strips along the gunwale. A strip can be nailed along the bottom inside or outside and clinched. Paint thoroughly with at least three coats.

INDEX

	Page		Page
Adjustment of plane.....	36, 37	Band-saw.....	102-104
Air-dried stock.....	205, 208	Setting and filing.....	138
Alcohol.....	192, 193	Basil.....	33
Stains.....	191	Battened sheathing.....	271
Alkanet root.....	191	Bayberry tallow.....	262
Ambidexterity.....	176	Bead cutters.....	86
Ammonia (for staining).....	190	Beading.....	108, 109, 165
Angles.....	221	-Planes.....	43
Bisecting.....	225	Beads, to turn.....	117
Constructing equal.....	225, 226	Beam-compass.....	16
Of 45° and 135°, to construct, 10,	226	Beams, floor.....	267, 268
Of 30°, 60°, 120°, and 150°, to con-	227, 228	Strains.....	213-216
struct.....	227, 228	Bearings, oiling.....	128
Of edged-tools. See <i>Bevel</i> , etc.		Beeswax. See <i>Wax</i> .	
Angle-blocks. See <i>Corner-blocks</i>	181	Bell-faced hammer.....	63
Annual rings.....	201	Belt-lacing.....	127
Anvil.....	88	Belts.....	126, 127
Arc.....	221	To find length of.....	127
Or circle, to strike.....	15, 16	Speed of.....	127
Bisecting.....	230	To slip on.....	128
Tangent to straight line.....	230	Width of.....	127
To draw through three points.....	234	Bench. See <i>Workbench</i>	5, 80, 81
To draw when centre is out of		Carving.....	171
reach.....	235	-Hook.....	27, 40, 83
Arkansas stone.....	135	-Stop.....	82
Arm of chair, to mend.....	180, 181	-Vise.....	82
Corner chair.....	176	Bending wood.....	162
Asphaltum.....	198	Bevel.....	10, 11
Assembling furniture.....	251	To lay out with square.....	9
Astragal.....	165	To plane.....	108
Auger.....	53	For obtaining angles.....	228
Bit.....	53	Cutting with circular-saw.....	94
To sharpen.....	135	-Edged chisels.....	34
Automatic drill-stocks.....	54	Of edged-tools.....	129-131, 136
Screw-drivers.....	69	Bevelling. See <i>Chamfering</i>	158
Awl, brad.....	52	Edges (boat).....	274
Marking-, or scratch-.....	9	Bichromate of potash.....	191
Back for case work.....	257, 259	Binding of saws.....	25, 92
Background (carving).....	174	Bisecting an angle.....	225
Back-mitre.....	164	An arc and chord.....	230
-Rest.....	115	A straight line.....	221
-Saw.....	27	Bit-brace.....	53
Baluster stock.....	245	Bits.....	53-55
		Auger.....	53

	Page		Page
Bits, centre-	53	Building (small one-story)	266, 272
Dowel-	53	"Built up" constructions	156, 213, 245
Expansive-	54	Bull-nosed plane	42
Forstner-	54	Burnishers	133
German-	54	Butt-gauge	185
Gimlet-	54	Butts. See <i>Hinge-fitting</i>	186, 187
Plane-	35	"Buzz" planer	108
Pod-	54	Cabinet-file	77
Spoon-	54	-Maker's bench	80, 81
Twist-	54	-Rasp	78
Twist-drill	54	-Work. See <i>Furniture</i>	250-265
To sharpen	135	Caliper-rule	7, 21
Black stain	191	Calipers	21
Blind dovetailing	155	Testing with	115, 119
Mortising	148	Canoe paddle	246
Nailing	65	Canvas, to paint	199
Block-plane	39	Cap (plane)	35-37
Blocks, corner-	76	Carborundum	135
Board foot	2	Card, file-	77
Measure	2	Carpenter's square	9
Boards, measurement of	2	Carriage clamps	70
Boarding	266, 268	Carved work, elementary	170-177
Boat, flat-bottomed row	272-274	Finishing	176
Toy hull	246-250	Sandpapering	176
Body plan	246	Carving-tools	63, 171, 177
Bolts	67	Slips for	135
Bone black	191	Casings (door- and window-)	268
Bookcases	256-259	Casters	188
Boring-machines	110	Caul	177, 178
Tools	52-57	Caulking	274
Bow-piece	273	Centre-bit	54, 135
Bow-saw	28-30	Centre of circle, to find	234
Box-lock, to fit	187	Irregular shape	229
Box-making	237-241	Square or rectangle	229
Corner	267	Centres for dowelling	152
Brace and bit	55-57	Of lathe	112
Brace, bit-	53	Centring for turning	113
Joint for	Fig. 757a	Chair arm, to mend	180, 181
Braces	216	-Seat, height of	262, 263
Bracket-saw	30	Chairs	262-265
Bracket for staging	269	Levelling	256
Brackets	76	Chalk	19
Bradawl	52	Chalk-line	19
Brads	67	Chamfering	158
Bridge, lattice	217	Charring wood	211
Strains	214-217	Chattering (plane)	44
Bridging of floor beams	268	(Saw)	27
Bristle brushes	199	Checking (ends)	208, 209
Broad surfaces, planing	50, 51	Cherry	250
To make	156	Chest. See <i>Box-making</i>	237-241
Brown stain	191	Chest-locks	187
Bruises, to remove	188	Chimney (opening)	271
Brushes	193, 199, 200	Chip (wooden plane)	37
Building (small "lean to")	265, 266		

- | | Page | | Page |
|-------------------------------------|----------------------|---|----------|
| Chisel | 31-35 | Construction, some types of | 237-274 |
| Bevel-edged | 34 | Contraction, expansion and | 211-213 |
| Carving | 63 | Control of tool | 176 |
| Control of | 31 | Coping | 164 |
| Corner | 35 | -Saw | 28, 30 |
| Firmer | 31 | Copper for flashing | 180 |
| Framing | 31 | Cord ("twister") for clamping | 75 |
| Mortise | 34 | Core-box plane | 231 |
| Paring | 34 | Coring work, to saw | 105 |
| Sharpening | 128-131 | Coring (inside) work, saws for | 28-30 |
| Skew | 35 | Corner-blocks | 76, 181 |
| Socket | 34 | Corner-boards | 270 |
| Straight-bent | 34 | Corner-braces | 257 |
| Turning | 113 | Corner-chisel | 35 |
| Chopping-block | 88 | -Irons | 188 |
| Chord, bisecting | 230 | Cornering tool | 159 |
| Chord (strains) | 215, 216 | Counterboring | 177 |
| Chuck | 125 | Countershaft | 112, 126 |
| Chute-board | 85 | Countersink | 55 |
| Circle or arc, to strike | 15, 16 | Cracking. See <i>Checking</i> | |
| Circle, inscribed in triangle | 232 | Cracks, to fill | 188 |
| Inscribed in square | 231 | Flashing. See <i>Flashing</i> | |
| Tangent to straight line | 230 | Creosote | 211 |
| Circular-plane | 42, 43 | Crickets | 263 |
| Circular-saw | 89-102, 138 | Cross-cutting saw and its use | 22-24 |
| Position of | 126 | Cross-cutting (circular-saw) | 94 |
| Setting and filing | 138 | Crossed belts | 127 |
| Speed | 101 | Cross-grained surface, smoothing | 42 |
| Circular work | 244, 245 | Cross-strain | 214-216 |
| Circumference, semi-, to find | 231, 232 | Crushing strain (compression) | 214-216 |
| Clamping | 72-75, 183, 184, 245 | Cup-shakes | 211 |
| Clamps | 72-75 | Cups, to turn | 121 |
| Cabinet | 72, 73 | Curled-hair for rubbing | 195 |
| Carriage- or C-shaped | 70 | Curved forms | 244, 245 |
| Filing | 137, 138 | Built up | 245 |
| Clapboarding | 179, 180 | Curves, compound | 236 |
| Clawfoot | 176 | Curves, cutting with band-saw | 102 |
| Cleaner (for furniture) | 196 | Curves, drawing irregular | 21 |
| Cleating | 157 | Symmetrical | 237 |
| Cleats | 211, 212 | Saws for cutting | 27-30 |
| Cleavage, lines of | 201 | Curves, to cut with chisel | 32, 33 |
| Clinching | 65 | Cut nails (shingling) | 179 |
| Coal-tar | 211 | Cuts and bruises | xiii |
| Cold-glue | 181 | Cutter-heads (circular-saw) | 99 |
| Collar-beams | 270 | Cutting-edges, 31, 32, 136. See <i>Sharpening</i> | |
| Collars (for wobbling circular-saw) | 96 | Cutting-gauge | 14 |
| Combination-planes | 43 | Cylinder, to cut off | 118 |
| Compass-saw | 28 | To square | 9 |
| Compasses | 14, 15 | To find opposite points | 231 |
| Compound curves | 236 | To turn | 113-115 |
| Compression | 214 | (With steps), to turn | 115 |
| Concave curves, to turn | 119, 120 | Dadoing | 159, 165 |
| Cone pulley | 112 | With circular-saw | 97 |
| Construction, a few principles | 213-217 | | |

	Page		Page
Dado-plane.....	159	Drill, twist.....	54
Daniels' planer.....	107	Dryer.....	198
Dead centre.....	112	Drying wood.....	205-208
Finish (painting).....	198	Dry rot.....	211
Decay and preservation.....	210	Dull finish (painting).....	198
Deck-beams.....	249	Duplicate parts, to lay out.....	4
Denatured alcohol.....	193	Ebonizing.....	191
Dents, to remove.....	188	Edge, joint.....	51
Diagonal members.....	213-215	Edge of tools.....	31, 32
Diameter of circle.....	231	Grooved with spline.....	156
Diameter of curved object.....	21	Edges, planing and jointing.....	45-50, 239
Driven pulley.....	127	Matched.....	156
Driving pulley.....	127	Rabbeted.....	156
Dimensions, rough.....	2	Edge-tools, principle.....	136
Squaring stock to.....	51, 52	Eight-sided stick.....	160
(Working-drawings).....	218	Elasticity.....	208
Disk, to turn.....	122	Elevations.....	217
Dividers.....	219	Ellipse.....	235, 236
Dividing line into equal parts.....	224, 225	Emery wheel.....	128
Dog-house. See <i>Kennel</i>	243, 244	End cleating.....	157
Dogs.....	68	Elevation.....	217, 218, 220
Door- and window-spaces.....	267, 268	-Grain, planing.....	39, 40
Door-frame.....	270	Joints.....	155
Locks.....	187	Of post or leg.....	263
Door- and panel-making.....	167, 170	-Pressure.....	163
Door, to hinge, or "hang".....	186	-Wood, gluing.....	184
Doors and casings.....	268	Equal angles, to construct.....	225, 226
Double-cut file.....	77	Parts, dividing line into.....	224, 225
Double-ironed planes.....	36	Equilateral triangle.....	227, 229
"Double-surfacer" planer.....	106	Escutcheons.....	188
Double wedges.....	140	Estimating.....	1
Dovetailed cleats.....	157	Expansion and contraction, 184, 185, 211- 213, 238	
Dovetailing.....	154, 155	Expansive-bit.....	54
Dowel-bit.....	53	Extension or slide rule.....	7
Dowelling.....	152, 153, 262	Eye, training of.....	18
Dowel-plate.....	153	Face (of plane).....	35
Dowels.....	152, 153	-Plate.....	121
Dowel sharpener.....	153	-Surface.....	4
Dragon's blood.....	191	Working.....	51
Draw-boring.....	149	Facing edges of case work.....	258
Draw-dogs.....	68	Feather-edge.....	129, 130, 131
Drawer dovetailing.....	154	Felt for rubbing.....	194
Drawer-locks.....	187	Fence pickets.....	178
Drawers.....	260	Figured grain.....	203, 204
Draw-filing scraper.....	133	File.....	76, 77
Drawing-board.....	219	-Card.....	77
Instruments.....	219	Rounding with.....	162
Problems.....	217-237	Filing saws.....	136-138
Drawings, working.....	216-221	Fillers.....	191, 192
Drawknife.....	59	Fillet.....	165
To sharpen.....	133	Finger and pencil, gauging.....	13
Drawshave. See <i>Drawknife</i>		Finishing.....	188-200
Drill-stock.....	54		
Metal for.....	54		

	Page		Page
Finishing, cabinet-work	251, 252	Glass, to wedge plate	253
Carved-work	176	Glazier's points	200
Turning	125, 126	Glazing	200
Firmer-chisel	31, 34	Glue and its use	181-185
Fish-plates	156	-Brush	182
Fitting together (cabinet-work)	251	-Joint, dowelling	153
Flashing	180, 270	(Jointing)	47-50, 100, 108
Flat-faced hammer	63	-Pot	182
Flexible ruler	21	Rubbed joint	72
Floor-beams	267, 268, 272	Testing	182
-Boards, laying	268	Gouge	58
-Timbers	270, 271, 272	Carving	177
-Strains	214, 215	Sharpening	131, 132
Foci of ellipse	235	Turning	113
Foot, board	2	Grain alcohol	192
"Foot" cut	267	Of wood	201, 203, 204, 212
Foot-power machines	100-110	Green wood	201
Square	2	Grinding. See <i>Sharpening</i> .	
Fore plane	38	Grindstone	128, 135
Forms for bending	163	Grooving	108, 159
Forstner-bit	54	Saws and cutters	96, 97
Forty-five degrees	226	Guards for circular-saw	93
Frame, pinned and braced	272	Guides for planing	46
Frames, picture and mirror	252, 253	Hack-saw	88
Window and door, spaces for	267, 268	Hair-cloth for rubbing	194
Framing (small one-story building)	266-272	Half-bead, to turn	117
(Second story)	271, 272	Half-breadth plan	246
(Pinned and braced)	272	-Round file	77
-Chisel	31, 34	Halved splice	156
-Square	9	Halving	140, 141
-Square (various uses)	225, 226, 228, 229, 233, 234	Hammer (and nailing)	63-67
French curves	236	Veneering	178
Polishing	195, 196	Handle, tool, to turn	119
Front-elevation	217	Hand-screws	70, 71, 181
Furniture	250-265	Hanging a door	186
Polish or cleaner	196	Hardware fittings	185
Repairing	180, 181	Hard wood	206
Gain, to pare out	33	Hatchet	57
Gauge	11-14	Header	268, 271
Butt	186	Head-stock	112
For turning	118	Heart	212
For special work	13, 14	-Shakes	211
Setting	12	-Wood	201, 209
Stop-, for boring	57	Hexagon, inscribed in circle	232
Gauging for hinges	185, 186	To construct	234
Geometrical problems	221-237	Hexagonal stick, to square	9
German-bit	54	Tabourets	255, 256
Getting out stock	1	Hinge-fitting	185, 186
Gimlet	53	Hinges (loose-pin)	187
-Bit	54	Strap	186
Glass, measuring for	253	T-	186
Setting	200	Hinging a door	186
		Holes or cracks, to fill	188, 189, 194

	Page		Page
Hollow and round planes.....	43	Knots, sawing through.....	26
Hollows and rounds, to turn.....	119, 120	To "kill" with shellac.....	197
Hook, screw and eye.....	188	Lacing of belts.....	127
Horizontal moulding-machine.....	108, 109	Lag-screw.....	69
Horses.....	82, 242, 243	Lap- or drawer-dovetailing.....	154
Hot glue.....	181	Lathe.....	110-126
Housing.....	148	Position for.....	126
Hull of toy or model boat.....	246-250	Lath, stay.....	269
Hypothenuse, to find.....	229	Strips.....	265
I-beam.....	216	Lattice bridge.....	217
India stones.....	135	Lattice bridge work.....	178
Inlaying.....	178	Laying out work.....	1, 3
Inside calipers.....	21	Tools for.....	6
-Gouge.....	58	(Mortising).....	151, 152
-Mitre.....	164	(Framing panels).....	168, 169
Work.....	28-30, 105	Lead for flashing.....	180
Instruments, drawing.....	219	Red.....	198
Iron, plane.....	35-37	White, and oil.....	198
To paint.....	198	"Lean-to,".....	265, 266
Irregular moulding-machine.....	109	Leather seats.....	263, 264
Isometric projection or perspective.....	219, 221	Ledger-board.....	272
Ivory black.....	191	Leg for table, curved.....	245
Jack-board.....	83, 84	Length of belt, to find.....	127
Mitre.....	85	Level.....	19, 20
Jack-plane.....	38	Levelling tables, chairs, etc.....	87, 256
Japan.....	198	Lime-water.....	190
Jig-saw.....	104, 105, 138	Lines, drawing.....	220
Joint-edge.....	4, 51	Linseed oil (for darkening).....	190
Grooved, with spline.....	156	Lips, cutting.....	53
Joint, for brace.....	Fig. 757a	Liquid fillers.....	192
Halved.....	140, 141	Paints.....	198
Mitred.....	142, 143	L-irons.....	188
Scarfed.....	156	List of materials, lumber, etc.....	3
Jointer.....	39	Live centre.....	112
Or "buzz" planer.....	108	Locks.....	187
Jointing.....	47-50, 100, 108	Log, methods of sawing.....	202-205
Face of wooden plane.....	37	Logwood.....	191
Sawteeth.....	137, 138	Long jointer.....	39
Joints, end-.....	155	Loose pulleys.....	126
Glue, planing for.....	47-50	Lumber, care of.....	207, 209, 210
"Sprung," for gluing.....	50	Measurement.....	2
Etc., painting.....	197	Order.....	3
Keen edge, testing.....	131	Seasoning.....	205-208
Kennel.....	243, 244	M (lumber measurement).....	2
Kerfing.....	164	Machines, placing.....	126
Keyed tenons.....	150, 151	Woodworking.....	88-128
Keyhole-saw.....	28, 29	Mahogany.....	250
Keys, to make.....	150, 151	Stain.....	191
Kiln-drying.....	206-208	Mallet.....	76
Knife.....	9, 58, 132, 133, 139	Maple.....	251
Knives, planer.....	106, 107	Marking-awl.....	9
		Lines.....	17

	Page		Page
Marking, rough.....	19	Nails, ornamental.....	264
Spaces (turning).....	115, 116	To withdraw.....	67
(Straight-edge).....	220	Nail-set.....	68
Mason's square.....	223	Narrow surfaces, planing.....	45-50
Masts and spars.....	161	Needle (weaving).....	264
Matched-boards.....	156, 165, 268	Nibs, scoring.....	53
Nailing.....	65	Nippers, cutting.....	88
To strike.....	108, 266	Notch-boards.....	271
Matching-planes.....	43	Oak.....	250
Maydole hammer.....	63	Quartered.....	204
Measurements.....	3, 6, 7	Oblique projection.....	219, 221
Of lumber.....	2	Oblong, to draw.....	230
Measurements with two sticks.....	7	Octagon (in circle).....	231
For picture or glass.....	253	(In square).....	233
Medullary rays.....	201	Octagonal stick, to mark.....	9
Mirror-frames.....	252, 253	To make.....	108, 160
Plates.....	188	Octagonal tabourets.....	255, 256
Mirrors, to wedge.....	253	Ogee.....	165
Mitre, back- or inside.....	164	Oil (for darkening).....	190
-Box.....	85, 86	(For oil stones).....	136
-Dovetailing.....	155	Oiling bearings.....	128
Jack-board.....	85	Oil stains.....	191
Shooting-board.....	85	Oil stones.....	130, 131, 132, 135
-Square.....	10	Open mortise and tenon.....	151
To draw.....	226	Orange shellac.....	192
Mitred-joint, to nail.....	142	Outlining carving.....	172, 173
Mitring.....	142, 143	Outside calipers.....	21
Model boat (hull).....	246-250	Gouge.....	58
Modelling or shaping (carving).....	175, 176	Pad for polishing.....	195
Model, strength of.....	217	Paddle.....	246
Morris-chair.....	263	Painting.....	196-199
Mortise and tenon.....	144, 252, 254, 262	Panel gauge.....	14
Open.....	151	Panelling and doormaking.....	167-170
Pinned.....	148, 149	Parallel lines, to draw.....	223, 224
Mortise-chisel.....	34	Projections.....	219, 221
Gauge.....	14, 145	Paring, 140. See also <i>Chisel</i> .	
Locks.....	187	-Chisel.....	34
To cut.....	145, 146, 147	Parting-tool (carving).....	63, 172
Mortising-machines.....	110	(Turning).....	116
Motors.....	126	Sharpening.....	177
Moulding or shaping (carving).....	175, 176	Paste fillers.....	192
Moulding-machines.....	108, 109	Pencil.....	10, 219, 220
Nailing around panel.....	170	Gauging with rule and.....	13
Strips of.....	108, 109	Marks, to remove.....	17
Mouldings.....	165	Sharpening.....	10
For case work.....	258, 259	Pentagon (in circle).....	232
Roughing out.....	99	To construct.....	233
Moulds for bending.....	163	Perpendicular, to erect.....	222, 223
Mouth of plane.....	35, 36	Perspective, isometric.....	219, 221
Nailing.....	63-67	Pickets.....	178
Mitred-joint.....	142	Picture and mirror frames.....	252, 253
Nails.....	67	Picture, measurements for.....	253
For shingling.....	179		

	Page		Page
Pincers.....	88	Pockets for window weights.....	268
Pine, white.....	250	Pod-bit.....	54
Pinned mortise and tenon.....	148, 149, 150, 151	Points, glazier's.....	200
Pins.....	149	Sawteeth.....	24
Pitch.....	211	Polishing, French.....	195, 196
Of roof.....	269	Polygon (in circle).....	232, 233
Sawteeth.....	24	Pony planer.....	108
Placing of machines.....	126	Posts and legs, ends of.....	263
Plan.....	217, 218, 220	Potash, bichromate of.....	191
Plane.....	35-52	Power-saws, setting and filing.....	138
Beading.....	43	Preservation of wood.....	210
-Bit.....	35	Process, the, in woodworking.....	1
Block.....	39	Processes for preserving wood.....	211
Bull-nosed.....	42	Projection, isometric.....	219, 221
Circular.....	42, 43	Oblique or parallel.....	219, 221
Combination.....	43	Protractor.....	11, 226
Core-box.....	231	Pulleys, setting up.....	126
Double-ironed.....	36	And belts.....	126
Fore.....	38	Pumice.....	194, 195
Hollow and round.....	43	Punch. See <i>Nail-set</i>	68
-Iron.....	35, 36, 37	Purlins.....	266
-Iron cap.....	35	Putting together, (cabinet-work).....	251
Jack.....	38	Putty.....	197, 200
Jointer.....	39	-Knife.....	200
Long jointer.....	39	Quartered oak.....	204
Matching.....	43	"Quarter"-sawing.....	204, 205
Plough.....	43	Quick-action vise.....	82
Rabbet.....	42	Rabbet, colored black.....	253
Router.....	43	-Plane.....	42
Scraper.....	62	For seats.....	263, 264
Sharpening.....	128-131	To cut with circular-saw.....	95, 97, 98
Smoothing.....	39	Rabbeted joint.....	156
Toothed.....	41, 42	Rabbeting.....	108, 159
Trying.....	38	Radial drills.....	54
Universal.....	43	Sawing.....	204
Wooden, adjustment of.....	37	Rafters, to lay out.....	268, 269
Wooden, to hold.....	46	Rags, oily.....	5
Planer.....	106	Rails.....	168
Jointer, or "buzz".....	108	Rake, sawteeth.....	24
-Knives.....	106, 107, 135	Rasp.....	78
-Marks.....	45, 107, 108	Ratchet-brace.....	53
Planing.....	43-51, 209	Ratchets for shelves.....	259
Broad surfaces.....	50, 51	Raw linseed oil (painting).....	198
Edges.....	45-50, 239	Rays, medullary.....	201
Traversing.....	50, 51	Reamers.....	55
Planks.....	2	Rear elevation.....	217, 218, 220
Plaster of Paris.....	189	Rectangle, to draw.....	230
Plate-glass, to wedge.....	253	To find centre.....	229
Plates.....	265, 266, 267, 272	Red lead.....	198
Pliers.....	88	Reed scrapers.....	86
Plough.....	43, 159	Reeding.....	108, 109
Plugs, to fill holes, etc.....	189	Reeds.....	165
Plumb.....	19, 20		
"Plumb" cut.....	269		

- | | Page | | Page |
|----------------------------|---------------|--|------------------|
| Refinishing old work | 196 | Saw, circular | 89-102, 138 |
| Relishing | 148 | -Clamp | 137, 138 |
| Removing paint from hands | 199 | Compass | 28 |
| Repairing furniture | 180, 181 | Coping | 28, 30 |
| Resinous matter, to "kill" | 197 | Cross-cutting | 22-24 |
| Ribs, stock for | 163 | -Filing | 136-138 |
| Ridge-board | 269 | For cutting curves | 27-30 |
| Rift-stock | 161, 205 | Jig | 104, 105, 138 |
| Right angle | 222, 223, 231 | Keyhole | 28-29 |
| Rings, annual | 201 | Ripping | 25 |
| Ripping-saw | 25-27, 138 | -Set | 137 |
| "Rise" of rafters | 269 | Splitting- or ripping- | 25-27 |
| Risers | 271 | Swing | 101 |
| Rivets | 67 | Turning | 28-30 |
| Rocking-chairs | 263 | Teeth, rake or pitch | 24 |
| Roof-boards | 265, 266 | Sawing inlaying | 178 |
| Roof-boards "Lean-to" | 265 | Of log | 201-205 |
| Strains | 214-217 | Round stick | 161 |
| -Timbers | 268, 269 | To fit (end-joints) | 155 |
| Rosettes, to turn | 121 | Scale. See <i>Rule</i> . | |
| Rot, wet and dry | 211 | (Working-drawings) | 218 |
| Rotten-stone | 195 | Scarfed joint | 156 |
| Rough dimensions | 2 | Scarving or Splaying | 155 |
| Roughing out carving | 175 | Scraper | 61, 62 |
| Round stick, to make | 160, 161 | -Plane | 62 |
| To saw | 161 | To sharpen | 133, 134 |
| To square | 161 | Scraping-machines | 109 |
| Router | 43, 159 | Old work | 196 |
| Row-boat | 272-274 | Tools | 122 |
| Rubbed glue-joint | 72 | Scratch-awl | 9 |
| Rubber-headed mallet | 76 | Screw-cutting | 126 |
| Rubbing-down | 194, 195 | -Driver | 68, 69 |
| Rule | 6, 7, 219 | -Hooks | 188 |
| Extension or slide | 7 | -Pocket | 254 |
| And pencil, gauging | 13 | Screws | 69 |
| Ruler, flexible | 21 | Hand- | 70, 71 |
| For marking | 220 | Scribing with compasses | 16 |
| "Run" of rafters | 269 | Scroll-saw. See <i>Jig-saw</i> | 104, 105 |
| Saddle-boards | 179 | Seasoned wood | 205-208 |
| Sandpaper | 78-80 | Seasoning | 205-208 |
| Blocks | 78 | Tests for | 207-208 |
| Splitting | 80, 195 | Seats | 263, 264 |
| Sandpapering carving | 176 | Height | 262, 263 |
| -Machines | 110 | Covering | 264 |
| Rounded surfaces | 161 | Secret dovetailing, nailing, mortising, etc. | |
| Shellac | 194 | See <i>Dovetailing, Nailing, Mortising</i> . | |
| Turned work | 119, 120, 121 | Section | 218 |
| Sapwood | 201, 209 | Selection of stock | 208, 209 |
| Saw | 21-31 | Semi-circular hollow, testing | 231 |
| Back | 27 | Semi-circumference, to find | 231 |
| Band | 102-104, 138 | Set, nail- | 68 |
| Bow | 28-30 | Sawteeth | 21, 25, 137, 138 |
| Bracket | 30 | Setting nails | 68 |
| | | Shafting, setting up | 126 |

- | | Page | | Page |
|-------------------------------|--------------------|--|--------------|
| Shakes | 211 | Spirit-level | 19 |
| Sharpening pencils | 10 | Splaying or scarfing, bevelled | 155 |
| Tools | 128 | Splice, halved | 155 |
| Sharpness, testing | 131 | Splicing | 156, 214 |
| Shavings and dust (polishing) | 121 | Spline | 21, 255 |
| Shearing stroke | 31, 61 | Split and wedged dowels | 152 |
| Shears | 88 | Split or rift stock | 205 |
| Sheathing | 271 | Splitting-gauge | 14 |
| -Paper | 270 | Sand paper | 194 |
| Sheer-plan | 246 | -Saw | 25-27 |
| Shellac | 192-196 | With circular-saw | 91-93 |
| As filler | 192 | Wood | 140 |
| For holes and cracks | 189 | Spokeshave | 59 |
| Shelves | 256-259 | Spoon-bit | 54 |
| Shingle-nails | 179 | "Sprung" joints for gluing | 50 |
| Shingles | 179 | Spur-set (for nails) | 68 |
| Shingling | 178, 179 | Square | 8, 9 |
| Shooting-board | 83, 84 | Square foot | 2 |
| Mitre- | 85 | (In circle) | 231 |
| Shop | 5 | Mason's | 223 |
| Shrinkage | 201-207, 211, 213 | Members (turning) | 120 |
| Lengthways | 201 | Mitre | 10 |
| Side elevation | 217, 218, 220 | Steel (various problems) | 225, 226 |
| Siding | 180 | 228, 229, 233, 234, 269 | 230 |
| Sighting surfaces and edges | 18 | To describe | 230 |
| Sills | 265, 266, 267 | To find centre | 229 |
| Silver-grain | 203, 204 | Squaring a round stick | 161 |
| Similar parts, laying out | 4 | Squaring stock to dimensions | 51, 52 |
| Single-cut file | 77 | Staff-bead | 165 |
| Single-ironed plane | 36 | Staggering | 65 |
| "Single surfacer" planer | 106 | Staging | 269 |
| "Sizing" dowels | 153 | Staining | 189-191 |
| Floor-beams | 267, 268 | Stairs | 271 |
| Sketch or picture | 219 | Stands. See <i>Tables</i> . | |
| Skew-chisel | 35, 113, 177 | Star-shakes | 211 |
| Slanting cut (gouge) | 58 | Stay-laths | 267, 269 |
| Stroke | 31, 33 | Steam-chest | 162 |
| Sled-making | 241, 242 | Steaming wood | 162, 207 |
| Slicing-stroke | 31 | Steel-square | 9 |
| Slides for drawers | 261 | (Various problems). See <i>Square, Steel</i> . | |
| Slipping on a belt | 128 | Steel-wool | 80, 199 |
| Slips | 132, 135, 177 | Steps, number of | 271, 272 |
| "Sliver" nailing | 66 | Stern-piece | 272 |
| Smoking wood | 207 | Sticking stock | 207 |
| Smoothing-plane | 39 | Stiles | 168 |
| Soaking wood | 162, 163, 206, 207 | Stock, air-dried | 205-208 |
| Socket-chisels | 34 | Bit | 53 |
| Soft wood | 206 | Care of | 207-209, 210 |
| Sole (of plane) | 35 | Getting out | 1 |
| Spars and masts | 161 | Selection of | 208, 209 |
| Speed of belts | 127 | Stools | 263 |
| Circular-saws | 101 | Stop, bench- | 82 |
| Lathe | 112, 113 | -Chamfer | 158 |
| Pulleys | 126 | -Gauge for boring | 57 |

- | | Page | | Page |
|--|------------|---|-----------------------|
| Stop, for circular-saw | 94, 95 | "Toe" nailing | 64 |
| Stops, for drawers | 261 | Tonguing | 108 |
| Straight-bent chisel | 34 | Tonguing and grooving (flashing) | 180 |
| Straight-edge | 16-18, 220 | Tool handle, to turn | 119 |
| Strap for bending | 163 | Tools, arrangement of | 5 |
| Strap-hinges | 186 | Care of | 5 |
| Strength of materials | 213-217 | Control of | 176 |
| String-pieces | 271 | Edge of | 31, 32 |
| Strop | 136 | Edge, principle | 136 |
| Stropping | 131 | For carving | 171, 177 |
| Studding | 268, 272 | For laying out and testing | 6 |
| Surface, cross-grained | 42 | For turning | 113, 121 |
| Planing broad | 50, 51 | Toothed plane | 41, 42, 50 |
| Swaged sawteeth | 138 | Knife | 109 |
| Swelling and shrinking. See <i>Expansion and contraction</i> | 211-213 | Toothing vencers | 177 |
| Swing saws | 101 | Torsion | 214 |
| Symmetrical curves | 237 | Toughness | 208, 209 |
| Table, height | 254 | Toy boat (hull) | 246-250 |
| Leg, curved | 245 | Trammel | 16, 235 |
| To level | 87, 256 | Transverse strain | 214-216 |
| Top, to fasten | 254, 255 | Traversing | 39, 50, 51 |
| Tables | 253-256 | Treads | 271 |
| Tabourets | 255 | T-rest | 112 |
| Tacks | 67 | Treenails | 149 |
| Thumb | 219 | Trestles | 82, 242, 243 |
| Tail-stock | 113 | Triangle, equilateral | 227 |
| -Vise | 82 | Triangle (in circle) | 232 |
| Tannic acid | 210 | Triangle, to draw | 229 |
| Taper, to cut (circular saw) | 99 | Triangles, use of | 219-224, 226, 227-230 |
| To plane | 108 | Trimmers | 61 |
| Tar, coal- and wood- | 211 | Trimming. See <i>Paring</i> | 140 |
| Teeth, saw- | 25 | Tripoli | 195 |
| Compass-saw | 29 | Trisecting right angle | 229 |
| Ripping-saw | 27 | True surface, to determine | 18 |
| Templates | 125, 248 | Truing grindstone | 135 |
| Templets. See <i>Templates</i> | | Oilstone | 135 |
| Tenon. See <i>Mortise and tenon</i> | 144 | Surfaces | 165, 166 |
| Tenon, to cut (circular saw) | 100 | Trusses | 214-217 |
| To wedge | 149, 150 | Try-square | 8 |
| Enlarging | 181 | Trying-plane | 38 |
| Tenoning-machines | 110 | T-square, use of, 219, 220, 222, 223, 224, 226, 230 | |
| Tension | 214 | Turkey stones | 135 |
| Testing surfaces and edges | 18 | Turning | 110-126 |
| T-hinges | 186 | -Chisel | 113 |
| Three points, arc through | 234 | Finishing | 125, 126 |
| Threshold | 270 | -Gouge | 113 |
| Throat of plane | 35, 36 | -Saw | 28-30 |
| Thumb-tacks | 219 | Turpentine | 198 |
| Tight and loose pulleys | 126 | Stains | 191 |
| Timbers, floor or roof | 214-216 | Twist-bit | 54 |
| Tin for flashing | 180 | -Drill | 54 |
| | | "Twister" | 252 |
| | | Types of construction | 237-274 |

	Page		Page
Undercutting in carving.....	175	White, pine.....	250
End-joints.....	155	Shellac.....	193
Shoulders.....	151	White wood.....	250
Unit of lumber measurement.....	2	Whittling.....	139
Universal planes.....	43	Wide surfaces, to make.....	156
Upholstering.....	263-264	Planing.....	50, 51
		Width of belt.....	127
"V-" (or parting) tool.....	63, 135, 172	Winding.....	251
Varnish, etc.....	192-196	Sticks.....	86, 87
Stains.....	190	(Bending).....	163
Vessels.....	200	Winding surface.....	18
Varnishing, 195. See also <i>Shellacking</i> .		Testing for.....	87
Veining tool.....	63, 177	Window frames.....	268
Vencering.....	177	And door-spaces.....	267, 268
Veneers.....	177	Wing compasses.....	15
Gluing.....	184	Wire-edge.....	129-131
Vise, bench.....	82	-Nails.....	67, 179
For metal.....	88	Withdrawing nails.....	67
		Witness-marks.....	145
"Wabbling" circular-saw.....	96	Wood, 201-213. See also <i>Lumber</i> .	
Warped board, to true.....	165, 166	Wood alcohol.....	192, 193
Warping of boards.....	167	Wooden plane, adjustment.....	37
Warping, twisting, etc., obviated.....	212, 213	Holding.....	46
Washita stones.....	135	Wood turning.....	110-126
Water-stains.....	191	Woodworking-machines.....	88-128
Table.....	179, 270	Work, laying out.....	1
Wax (finishing).....	196	Work-bench.....	5, 80, 81
(Filling holes, etc.).....	194	Working-drawings.....	218-221
Weather drying. See <i>Air-dried stock</i> .		Working-face and edge.....	4, 51
Webbing.....	264	Workshop.....	5
Wedge, principle (edged-tools).....	136	Worm.....	53
Wedge dowels.....	152	Woven seats.....	264
Tenons.....	149-151	Wrench.....	88
Wedges.....	139, 140, 150, 151, 253		
Wet rot.....	211	Zinc for flashing.....	180
White lead and oil.....	198	Paints.....	198

*A Selection from the
Catalogue of*

G. P. PUTNAM'S SONS



**Complete Catalogue sent
on application**

Excellent Books for Boys

The United States Naval Academy

Being the Yarn of the American Midshipman (Naval Cadet), showing his life in the old frigates and ships-of-the-line, and then at the Naval School in Annapolis, and how that institution became a famous Naval College, meanwhile making him into the most accomplished and versatile young seaman in the world; together with some reference to the boys best suited for the Navy, and what they must do and know to get into the Naval Academy, and what they have to expect while there; and also many pictures, all properly stopped to the yarn as it is handsomely paid out. By PARK BENJAMIN, of the Class of '67. *Fully illustrated.* 8vo. 494 pages. *Net, \$2.50.*

A history of the Naval Academy written by an expert on naval affairs, who is thoroughly competent to deal with his subject. The book describes the education of our young naval officers in the past, as well as at present. Mr. Benjamin is a brilliant writer, and has treated his subject in a sympathetic manner.

Life at West Point

The Making of the American Army Officer. His Studies, Discipline, and Amusements. By H. IRVING HANCOCK, author of "Japanese Physical Training," "Physical Training for Women by Japanese Methods," etc. With an Introduction by Col. A. L. Mills, Superintendent of the U. S. Military Academy. 12mo. *Fully illustrated.* *Net, \$1.40. (By mail, \$1.50.)*

"The book is an admirable and thorough presentation of the life of the Cadet and the purposes of the Academy. It shows us the experiences of a Cadet from the time he first presents himself for examination till he finishes his course."—*N. Y. Tribune.*

How to Swim

A Practical Treatise upon the Art of Natation, together with Instruction as to the Best Methods of Saving Persons Imperilled in the Water and of Resuscitating those Apparently Drowned. By Captain DAVIS DALTON, late Champion Swimmer of the World. *With 31 Illustrations.* 12mo. \$1.00.

The author won wide renown by swimming across the English Channel. In this passage he was in the water 23½ hours. He swam upon his back and, being carried out of his course by the tide, he covered 60 miles. Captain Dalton saved 281 persons from death by drowning, and received 169 medals for gallant conduct in his profession. He is aware of the difficulties which confront the beginner in the art of swimming, and he shows in his book how each may be overcome. For the instruction of the swimmer already able to keep afloat, Captain Dalton includes descriptions of racing strokes and of fancy movements.

G. P. Putnam's Sons

New York

London

Wood-Working for Beginners

A Manual for Amateurs

By Charles G. Wheeler

With over 700 Illustrations. 8vo., pp. 562. \$2.50

PART I. contains chapters treating on tools, wood, laying out of work, etc., and gives detailed directions and suggestions for fitting up workshops, including benches, bench hooks, tool cabinets, etc., together with matters of general importance to the beginner.

PART II. gives the detailed directions, with illustrations, for making many objects of interest to the amateur; such as toboggans, sleds, gymnastic apparatus, book-cases, dog-houses, etc.

PART III. treats of simple house-building for beginners, and includes a variety of camping-houses, boat-houses, etc., with directions and designs for simple summer-cottage building.

PART IV. treats of boat-building, including punts, flat-bottom canoes, skiffs, iceboats, small sail-boats, etc.

PART V. is alphabetically arranged, and gives descriptions of common tools and their uses, and also of such subjects as bending wood, boring, doors, frames, planing, rounding sticks, and the like.

“Wood-working for Beginners’ has my hearty indorsement. The subject is treated in a masterly manner. It shows in its plan a thorough acquaintance with the subject. It is best of its class of which I have any knowledge. After showing the work to several of the Faculty of Girard College they all gave it their unqualified approval.”—*D. Eavenson, Manual Training School, Girard College, Philadelphia, Pa.*

G. P. Putnam’s Sons

New York

London



MAY 31 1914

One copy del. to Cat. Div.

MAY 31 1911

LIBRARY OF CONGRESS



0 013 960 327 8