

SISI

1962

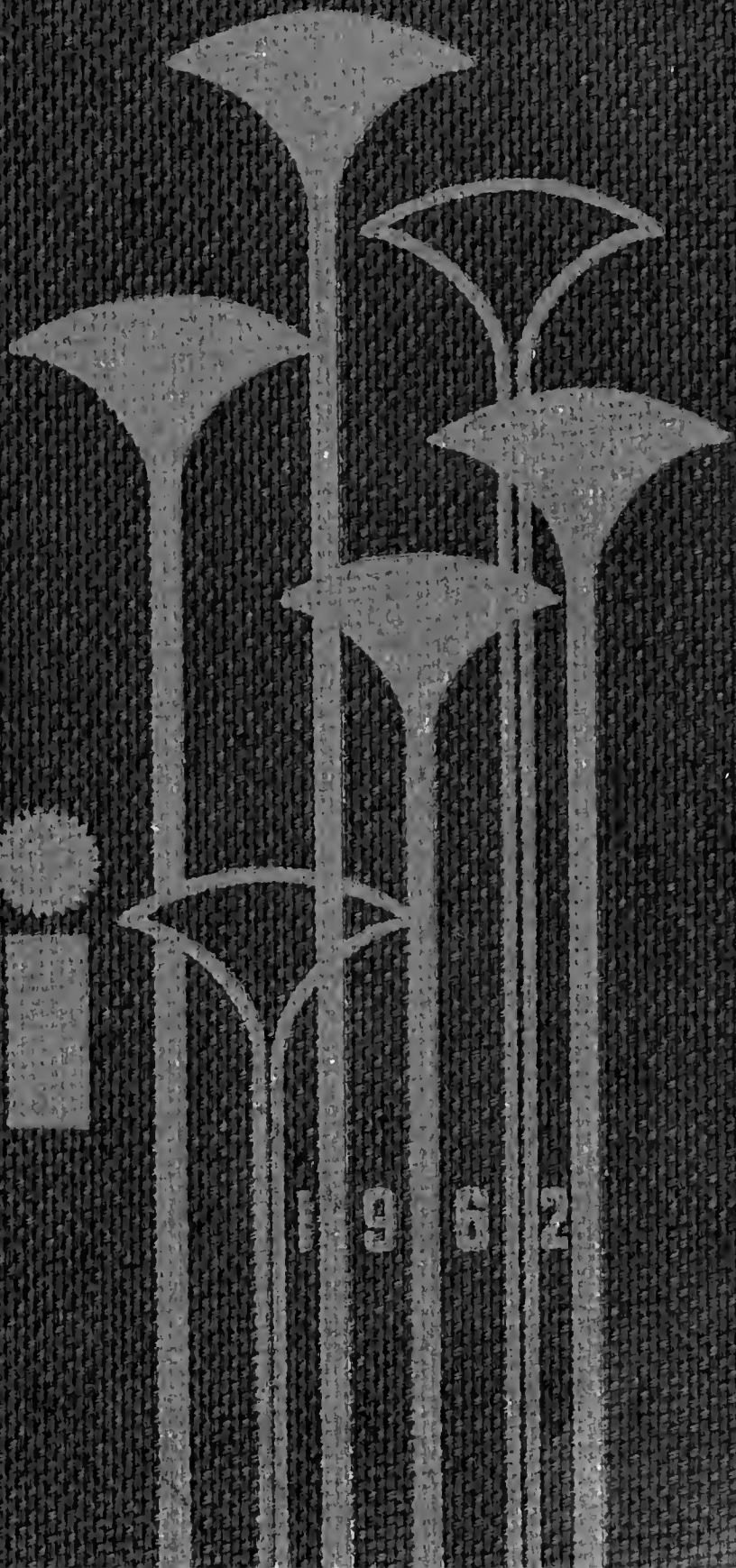

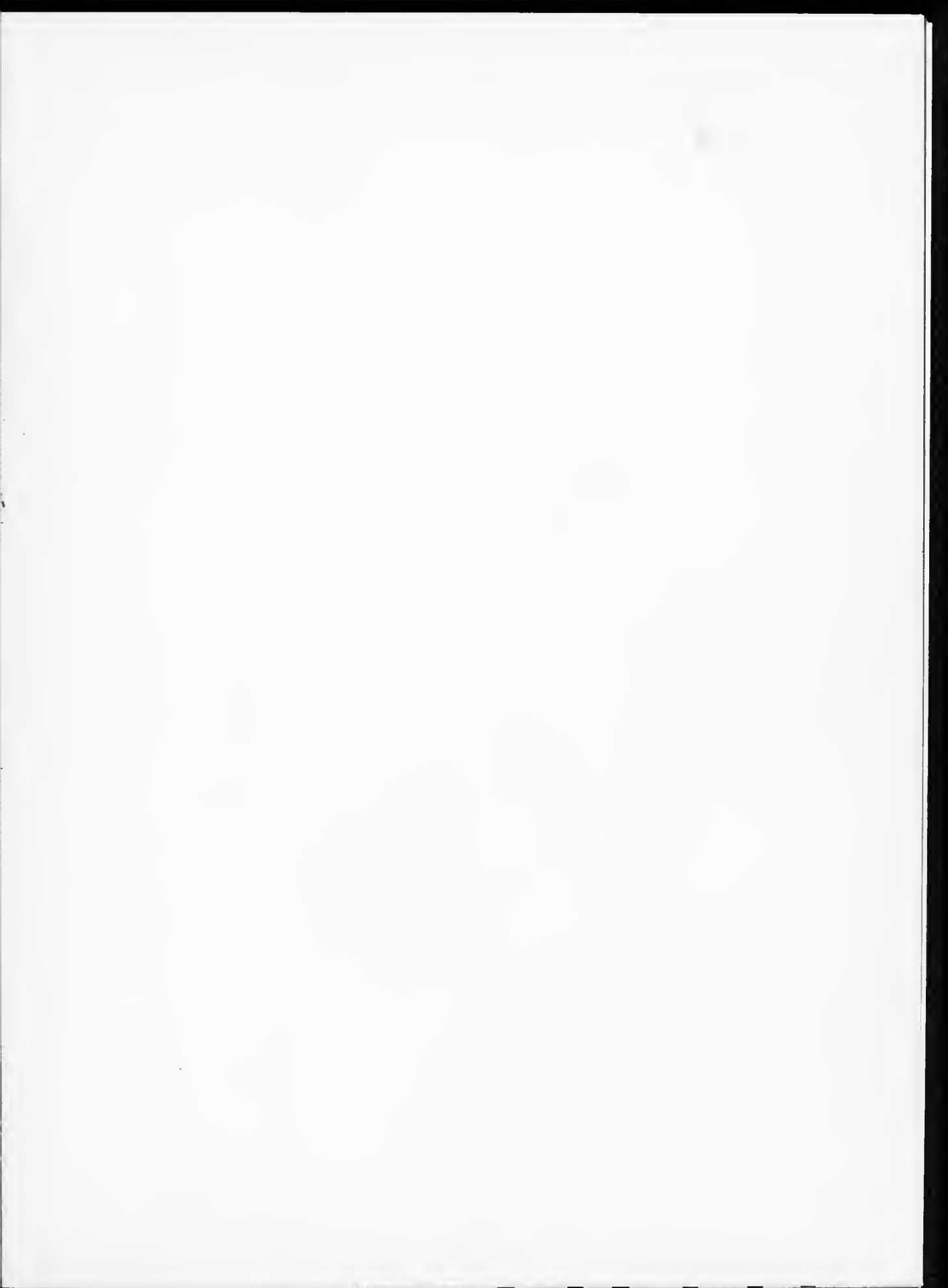





SISI

REGGIE YORK, EDITOR • LARRY CRUSE, BUS. MGR.

1 9 6 2





CHAR



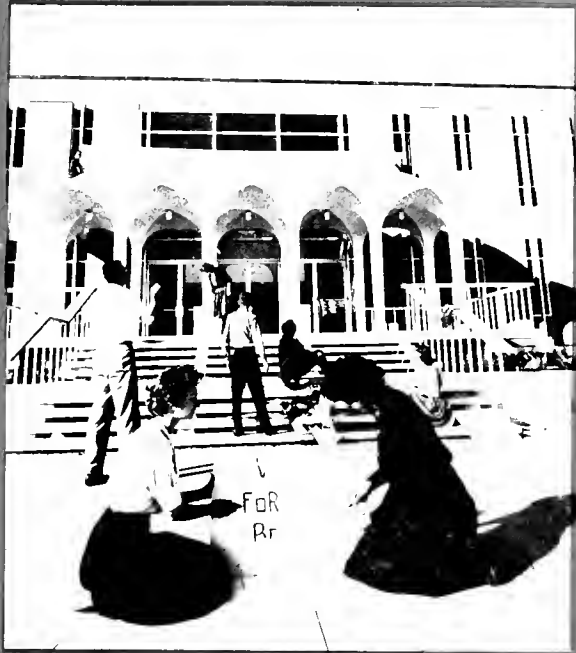

LOTTE COLLEGE

A CO-EDUCATIONAL JUNIOR COLLEGE, LOCATED ON HIGHWAY 49, CHARLOTTE, N. C.

FOREWORD

The Charlotte Center of the University of North Carolina was established in 1946 in the Central High School building.



In 1947, Miss Bonnie E. Cone was named director of the school, and remained as director when the center became Charlotte College in 1949.

At the beginning, organizations,



MISS CONE — 1947

and a large sports program for its three hundred students. The faculty has

grown from one full-time instructor, Miss Mary Denny,



MISS DENNY — 1947

and several part-time instructors to thirty full-time and thirty-one part-time instructors.



A. G. ODELL, JR.

In the fall of 1961, the College moved to its new campus, designed by noted architect A. G. Odell, Jr. Located on Highway 49 North, the college, under the direction of its President, Dr. Cone, now serves over nine hundred students.



THE CHARLOTTE



Charlotte Collegian staff of 1950 at work.



Charlotte Collegian staff of 1962 at work.

ORGANIZATIONS



C. C. U. N. C. football team of 1947.



Charlotte College basketball team of 1961-62.

SPORTS



C. C. students doing the "Bunny Hop" in 1954.



Queen and court during Christmas Dance of 1961.

FEATURES

COLLEGE STORY



Classroom of old campus.



Classroom of new campus.

CLASSES



Miss Cone when C. C. U. N. C. became C. C. in 1949.



DR. CONE IN 1961.

ADMINISTRATION & FACULTY



Old campus.



New campus.

ADVERTISEMENTS

DEDICATION



For his service to Charlotte College, his sincere devotion and unselfish work, the staff of the *Si Si* dedicates this twelfth edition to Dr. Herbert Hechenbleikner.





**DR. HERBERT
HECHENBLEIKNER**



ORGANIZATIONS



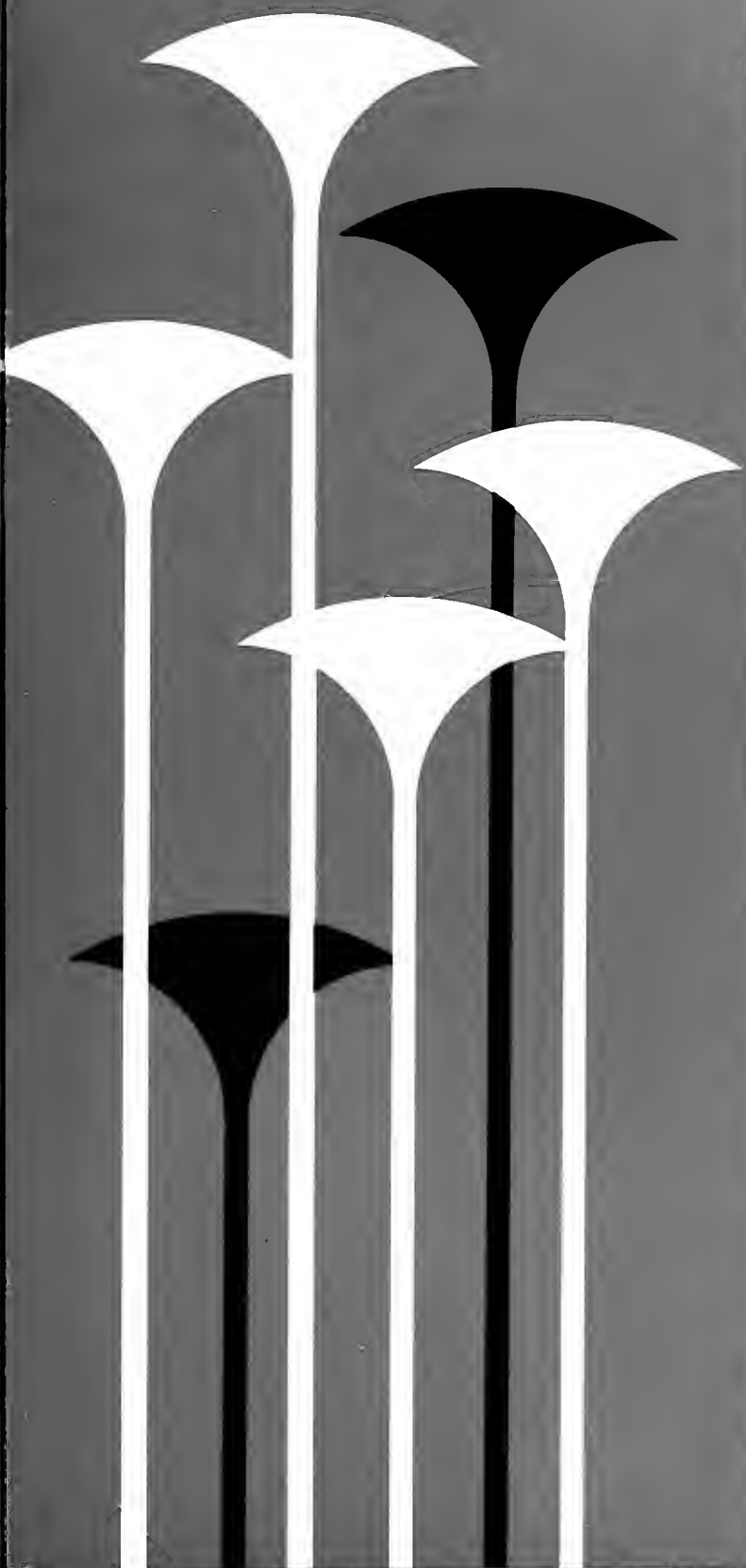

STUDENT COUNCIL



BILL FERGUSON
President

JEANNIE GLASGOW
Secretary

JOHNNY SAYERS
Vice-President

FRANCIS CLINE
Treasurer

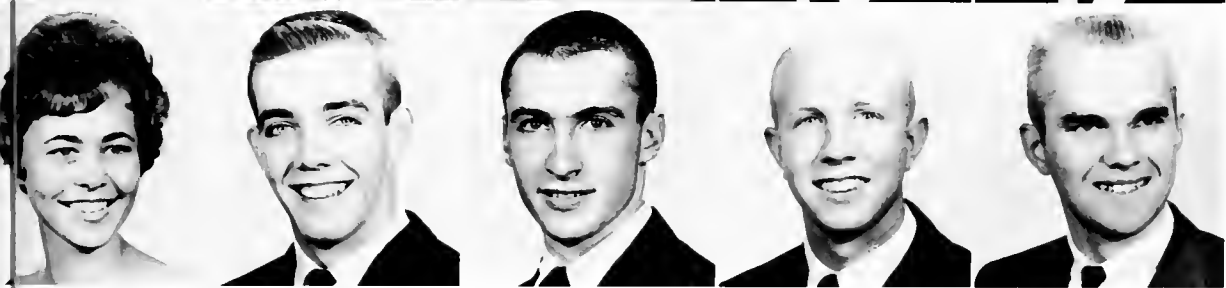
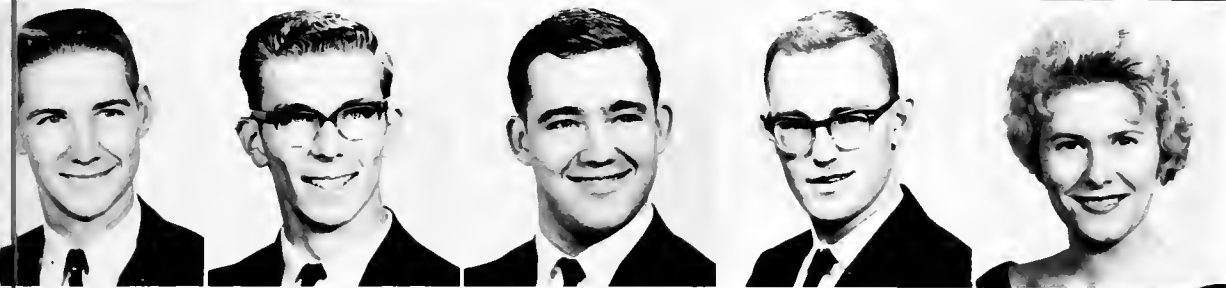

Bob Andrews
Eddy Crump
Mary Helms
Brenda Long
Mary Sadler

Herbert Baker
Larry Cruse
Carol Holden
Rodney Love
Mike Sellers

John Boling
Murray DeYoung
Gene Horne
Florence Morrow
Gayle Smith

Clinton Canaday
John Duckworth
Mildred Hunter
Robert Owens
Dan Thigpen

Chris Collins
Janice Giles
Lloyd Lane
Larry Reynolds
Reggie York



Mrs. Winningham
Student Council Advisor

STUDENT COUNCIL COMMITTEES



The Student Council is the voice of the students of Charlotte College. The purposes of the Council are to develop leadership and character among the students, to keep them informed of all school activities, and to administer the business of the Student Government Association.



FINANCE COMMITTEE

Approving budget requests, making financial reports, and managing all funds pertaining to student activities, are the responsibilities of the Finance Committee.

Seated: Francis Cline, *Chairman*
Standing: Bobby Crump, Mary Helms, Johnny Sayers.

ASSEMBLY COMMITTEE

The Assembly Committee is in charge of all arrangements for Student Government assemblies.

Seated: Mike Sellers, *Chairman*
Standing: Johnny Sayers, John Jolly, Mary Fisher, Linda Mayhew, Ira Madans.





SOCIAL COMMITTEE

The Social Committee has the responsibility of planning social activities for the students. This year the committee planned three major dances as well as coffee hours, picnics and other activities. Florence Morrow, *Chairman*, John Duckworth, Doris Jarrett, Judy Idol, Mildred Hunter, Doris Ann Hoover, Bill Newman, Rodney Love.

PUBLICITY COMMITTEE

The Publicity Committee is responsible for the release of all publicity connected with basketball games, dances and other school functions. Posters, radio announcements and newspapers are some of the media used by the committee to publicize these activities.

Seated: Brenda Long, *Co-Chairman*
Not Pictured: John Duckworth, *Co-Chairman*
Standing: Alona Stewart, Connie Marley, Barry Hinson, Doris Ann Hoover, Barbara Blythe, Carol Holden.



ELECTIONS COMMITTEE

Being responsible for all Student Government elections, the Elections Committee makes preliminary preparations for voting, counts the votes and publicizes the results.

Seated: Bobby Crump, *Chairman*
Standing: Larry Reynolds, Bob Owens, Francis Cline, Clinton Canaday, John Boling.





LARRY CRUSE
Business Manager

REGGIE YORK
Editor-in-Chief



1962

SISI

MARY FISHER
Associate Editor





ALONA STEWART
Class Editor



JOHN DUCKWORTH
Sports Editor

RODNEY LOVE
Feature Editor



JUDY IDOL
Organizations Editor



BILL FERGUSON
Art Editor

STAFF ASSISTANTS

CAROL HOLDEN



BILL NEWMAN
Photographer



BRENDA LONG

CONNIE MARLEY



MIKE KELLY



FLORENCE MORROW





JIM IRELAND
Photographer



PAT NORMAN



THE CHARLOTTE COLLEGIAN



CHRIS COLLINS
Editor-in-Chief



GENE HORNE
Associate Editor



CHARLES HAIR
Production Manager

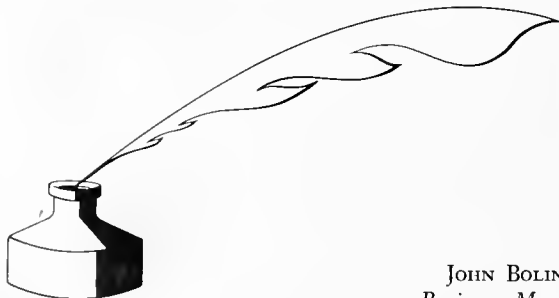

JOHN BOLING
Business Manager





Seated: Chris Collins. Standing: John Boling, Brad Keistler, Charles Hair, Charlotte Gibson, Dennis Whitaker.

The *Charlotte Collegian*, re-organized each year under new leadership, is "the newspaper voice of Charlotte College."





RODNEY LOVE
Co-chairman

REGGIE YORK
Co-chairman

FRESHMAN ADVISORY COUNCIL



The members of the Freshman Advisory Council orient new students to Charlotte College, help them with registration and assist faculty advisors in counseling during Orientation Week and throughout the year.



Dan Thigpen, John Boling, Mike Sellers, Larry Cruse, Florence Morrow, Francis Cline, Lloyd Lane, Bob Andrews, Johnny Sayers, Bobby Crump, Larry Reynolds.

GLADYS ALLGOOD PORTER
Chief Marshal



FITZHUGH LEE AUSTIN



MARSHALS

The Commencement Marshals are rising sophomores who have maintained the highest scholastic averages. They usher for commencement, the Baccalaureate Sermon, and special events.



CHRISTIAN CURTIS COLLINS

GARTH MICHELE FERGUSON



JOHN HUNTER MCCOY

WILLIAM EDWARD MORRISON



CHRISTIAN CURTIS COLLINS

GARTH MICHELE FERGUSON

MILDRED HUNTER

GLADYS ALLGOOD PORTER

PHI THETA KAPPA

Phi Theta Kappa is a national honorary scholastic society. Students who have the highest academic averages and who display sound moral character are eligible for membership.

FITZHUGH LEE AUSTIN
Chairman





CHARLOTTE COLLEGE CHORUS

Highlights of the year for the Charlotte College Chorus were the Christmas and spring concerts and two half-hour programs on WSOC-TV.

First row: Florence Morrow, Mary Helms, Doris Ann Hoover, Cleveland Beacham, Judy Murdoch, Doris Jarrett.

Second row: Rodney Love, Francis Cline, Vann Trapp, Gene Knott, Bill Ferguson, *Accompanist*, David Lindeman, Bobby Crump, Morris Spearman, Jerry Poplin.

Third row: Elaine Carriker, Charlotte Gibson, Judy Morgan, Jan Shive, Kitty Lacy, Dianne Howard, Lorna Byers, Reggie York, Mr. Woodruff, *Director*.





BILL PIPKIN
President

M. W. GRASS
Vice-President

SIDNEY LINKER
Secretary

JOE MURDOCH
Treasurer

SIGMA LAMBDA CHI

Sigma Lambda Chi provides wholesome social activities for its members and serves the college. The Sigma Lambda Chi Scholarship is awarded annually to a freshman. The fraternity raises the money by sponsoring various projects throughout the year.



Larry Allen, Edward Blanton, Gary Brewer, Lloyd Burris, John Crump, John Furr, Marty Garmon, George Greenoe, Barry Hinson, Charles Holland, Ronnie Joyce, Lloyd Lane, Jeff Marshall, Lane Mullis.





Contributing to United Appeal.



Picking up rocks on campus.

Ronald Polk, Gordon Richards, Gary Russell, Darrel Russo, Edwin Scott, Herbert Smith, Kapp Smith, Wallace Smith, H. B. Staton, Heath Strawn, Jerry Vassey, Hugh Walker, Roger Walker, Steve Watts.





Pledges

Initiation





SWEETHEART OF SIGMA LAMBDA CHI

LINDA PIPKIN

NATIONAL EDUCATION ASSOCIATION



Seated: Miss Denny, Advisor
First row: Pat Norman, Petronella Coulter, Marilyn Holmes, Jan Shive.
Second row: Mary Fisher, Rodney Love, Larry Lynn.



The Charlotte College Student National Education Association serves students interested in the teaching profession.

EFFIE BISHOP
President
PETRONELLA COULTER
Vice-President
PAT NORMAN
Secretary
BILL FERGUSON
Treasurer



COLLEGIATE CIVITAN CLUB

JOHN COCHRAN
President
CLINTON CANADAY
Vice-President
REGGIE YORK
Secretary



The purposes of the Collegiate Civitan Club are to serve the College and community and to promote good citizenship. Through various projects, the Collegiate Civitan Club achieves these purposes.

Seated: John Cochran.

Standing: Larry Reynolds, Bobby Crump, Clinton Canaday, Francis Cline, Dave Douglas, John Duckworth, Harry Holden.





JOHN COCHRAN
President



PETRONELLA COULTER
Secretary-Treasurer

COLLEGIATE COUNCIL FOR THE UNITED NATIONS



The Collegiate Council for the United Nations has become one of the most active clubs on campus. Representatives attended model U. N. General Assemblies and a conference

in New York, where Prime Minister Nehru of India was the principal speaker.

A "dinner of world-wide foods" was given for foreign students attending nearby colleges.



Petronella Coulter, Larry Dewhurst, Doris Ann Hoover, Gay Porter, Bob Andrews, John Cochran, Reggie York, Larry Lynn, Mary Jane Gosline, George Thomas, Diana Morrow, Dianna Horne.



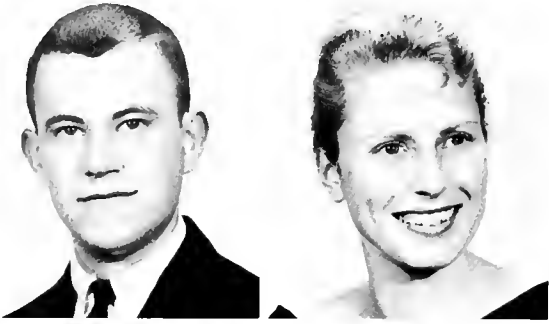

BILL STARR
President

PETRONELLA COULTER
Vice-President



CHARLOTTE GIBSON
Secretary

LE CERCLE FRANCAIS

Through *Le Cercle Francais* the students receive a better understanding and appreciation of the French civilization.

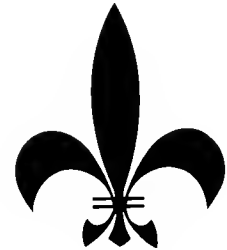

Carol Holden, Jimmy Dutton, Bill Ferguson, David Allen, Joyce Almon, Bill Duckworth, Jim Flowers, Dr. Macy, *Advisor*, Mike Sellers, Reggie York, Charlotte Gibson, Bill Starr, Nicky Kommas, George Burkhalter, Petronella Coulter, Jim Clark, Johnny Sayers.





ENGINEERS' CLUB

The Engineers' Club is designed to give the student engineer a greater understanding of all phases of engineering.



FRANCIS CLINE
President

CLINTON CANADAY
Vice-President

BOBBY CRUMP
Secretary

LARRY REYNOLDS
Treasurer

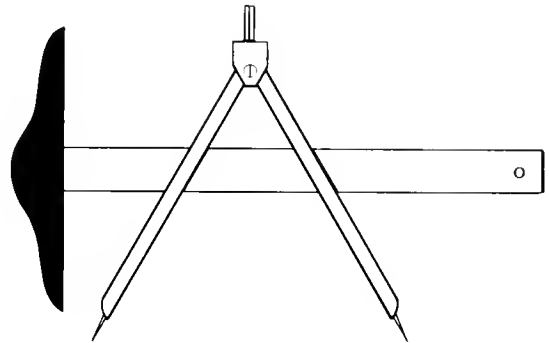

Seated: Francis Cline

Standing: Mr. Darholt, *Advisor*, Bob Alexander, Sandy Stokes, Bill Logan, Clinton Canaday, Bobby Crump, Larry Reynolds, Murray DeYoung.



BOND RALLY



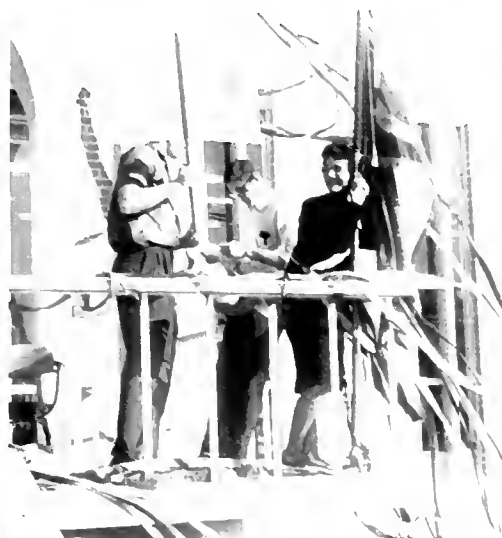

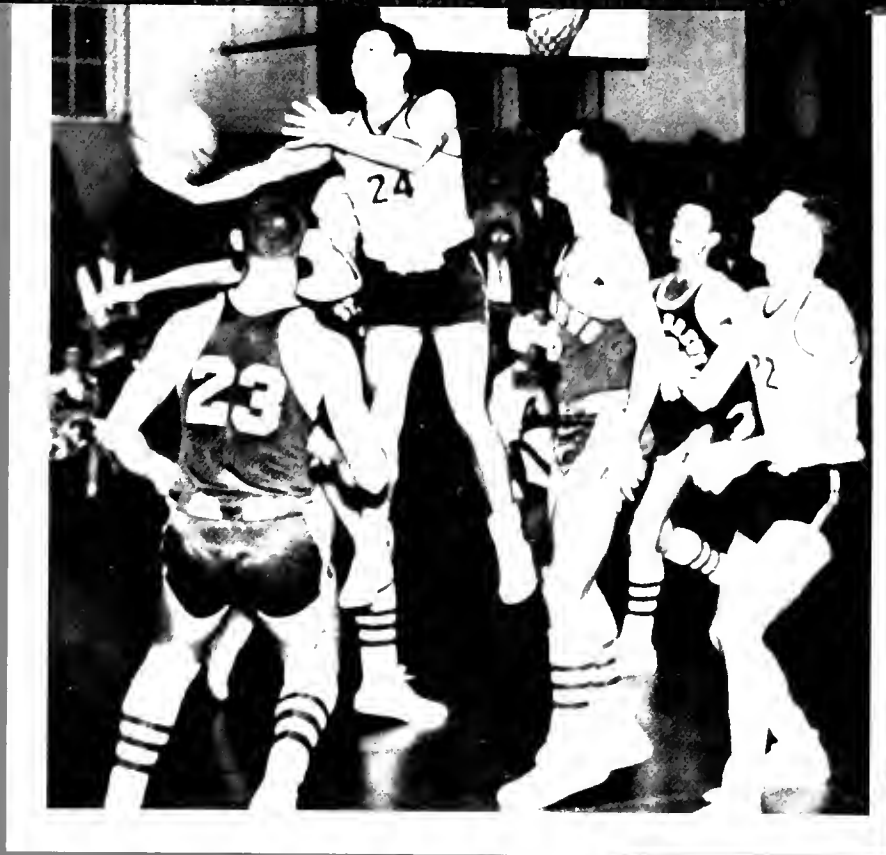

SPORTS

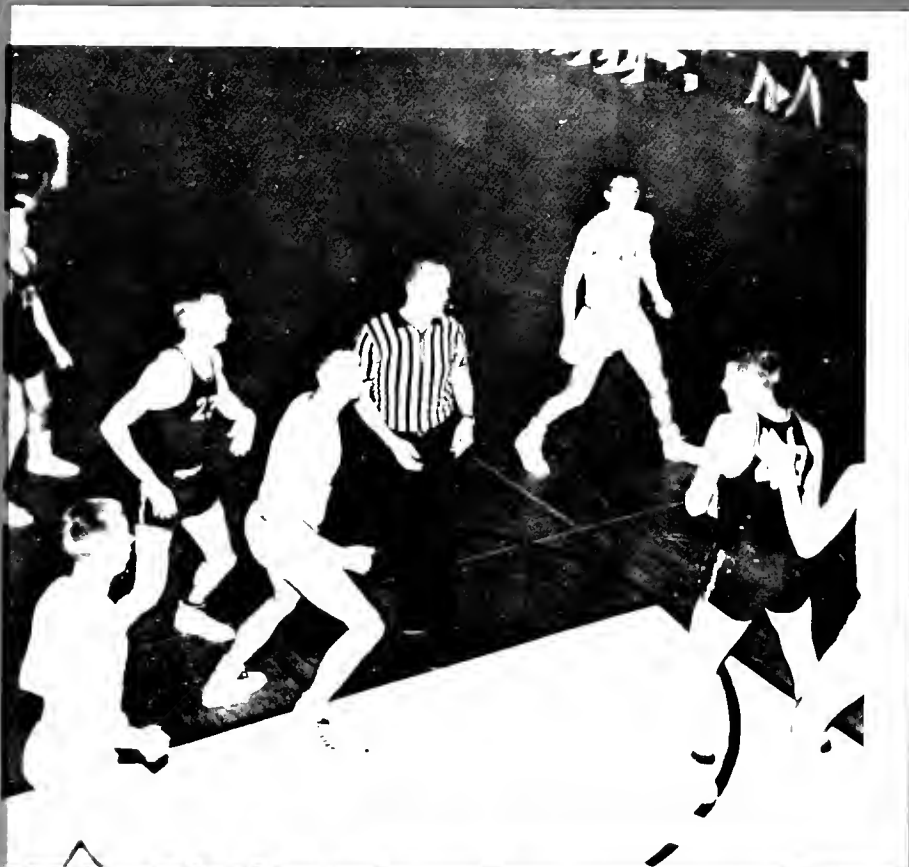





Front row: Ed Owens, Jimmy James, Butch Gilbert, Bubba Rion, Eugene Todd, Coach.
 Back row: Sam Dunlap, Assistant Coach, Gordon Richards, Marshall Greene, Ronnie Greene, Ken Bailey, Sammy Payne; not pictured: Broadus Taylor.

BASKETBALL '62



BUBBA RION
 Captain



EUGENE TODD
 Coach



SAM DUNLAP
 Assistant Coach

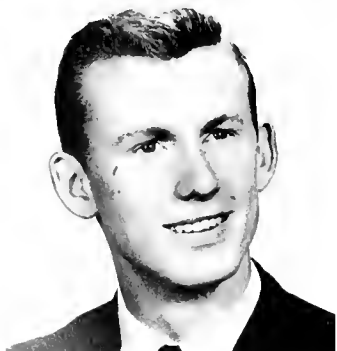

RONNIE GREENE
 Co-Captain



JIMMY JAMES



BUBBA RION



RONNIE GREENE



BUTCH GILBERT

MARSHALL GREENE

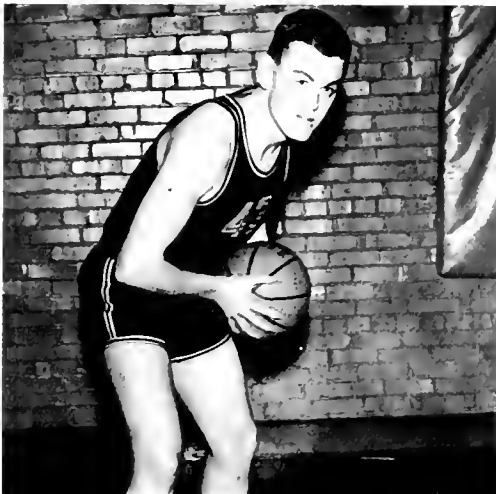

GORDON RICHARDS





RONNIE GREENE ALL-CONFERENCE

For his outstanding ability throughout the season, climaxed by a thirty-two point effort in the last game of the Virginia-Carolina Tournament, Ronnie Greene was chosen as center for the All-Conference Team. Since he is the first Charlotte College player selected for the All-Conference Team, Ronnie has added prestige to the Owls.







DORIS ANN HOOVER



BAIBA LUKEVICS



TOR SMITH



CAROL HOLDEN



CONNIE MARLEY





CHEERLEADERS

MILDRED HUNTER
Head Cheerleader

This year the cheerleaders have added tremendously to the school spirit at Charlotte College. They have attended almost every basketball game and have proved themselves worthy of much praise.

BARBARA BLYTHE
Co-head Cheerleader





FEATURES



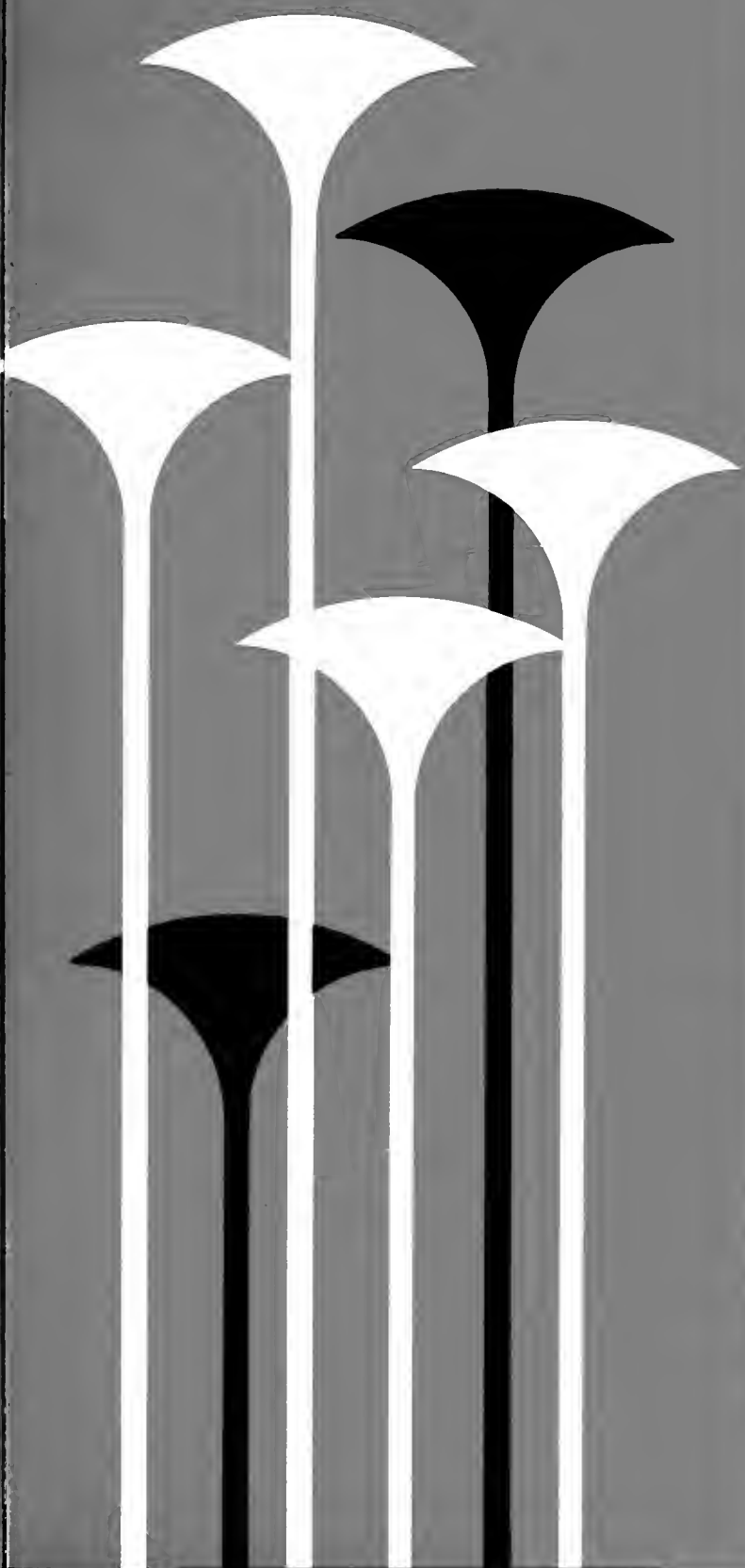



CHRISTMAS QUEEN

BARBARA BLYTHE



CAROL HOLDEN



MARY SADLER

CHRISTMAS COURT



LINDA MAYHEW



BRENDA LONG



FLORENCE MORROW



CONNIE MARLEY

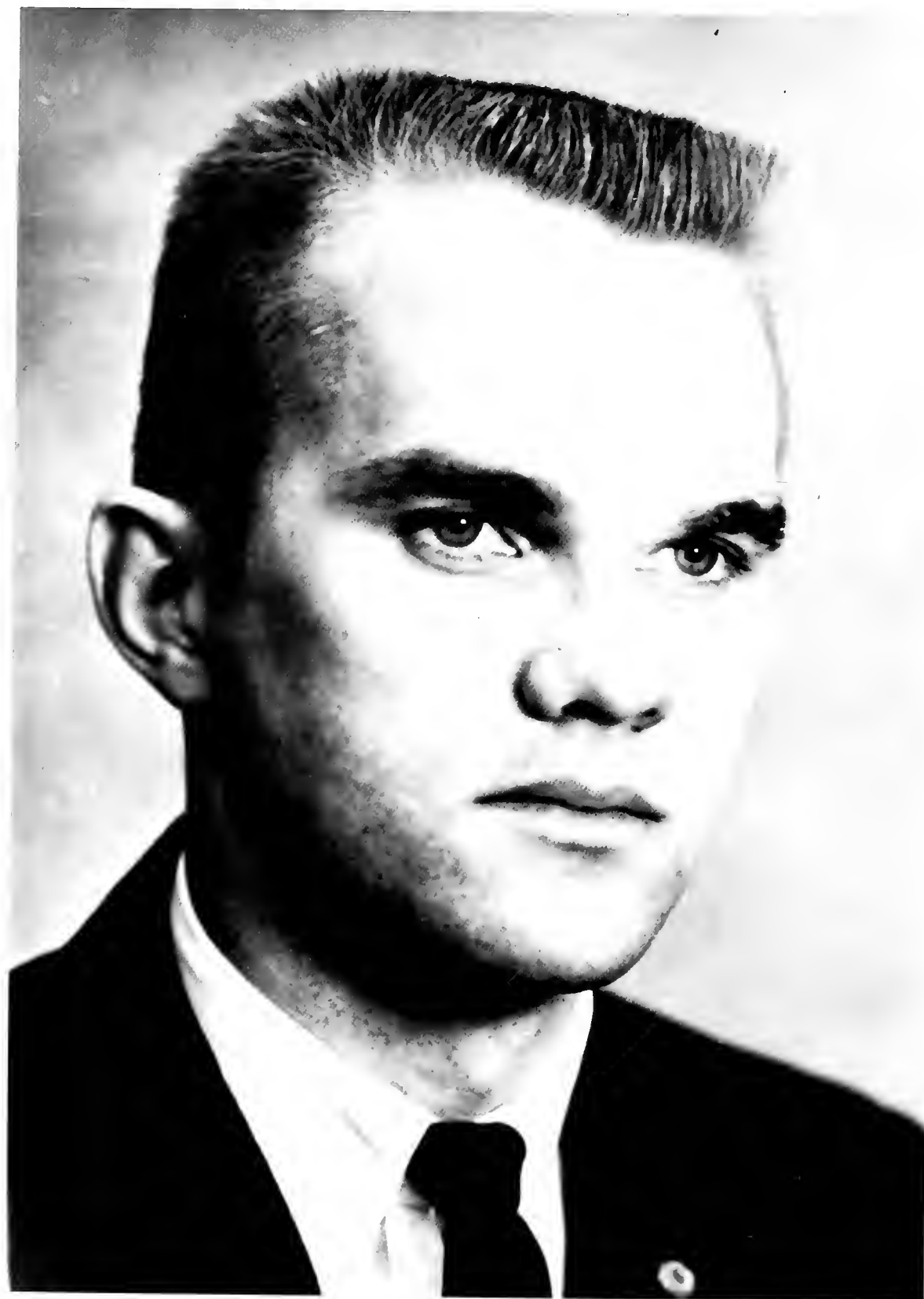

KING OF HEARTS

REGGIE YORK



QUEEN OF HEARTS

CAROL HOLDEN

VALENTINE COURT



ROBERT OWENS



CONNIE MARLEY



RODNEY LOVE



MARY FISHER



VANN TRAPP



MILDRED HUNTER

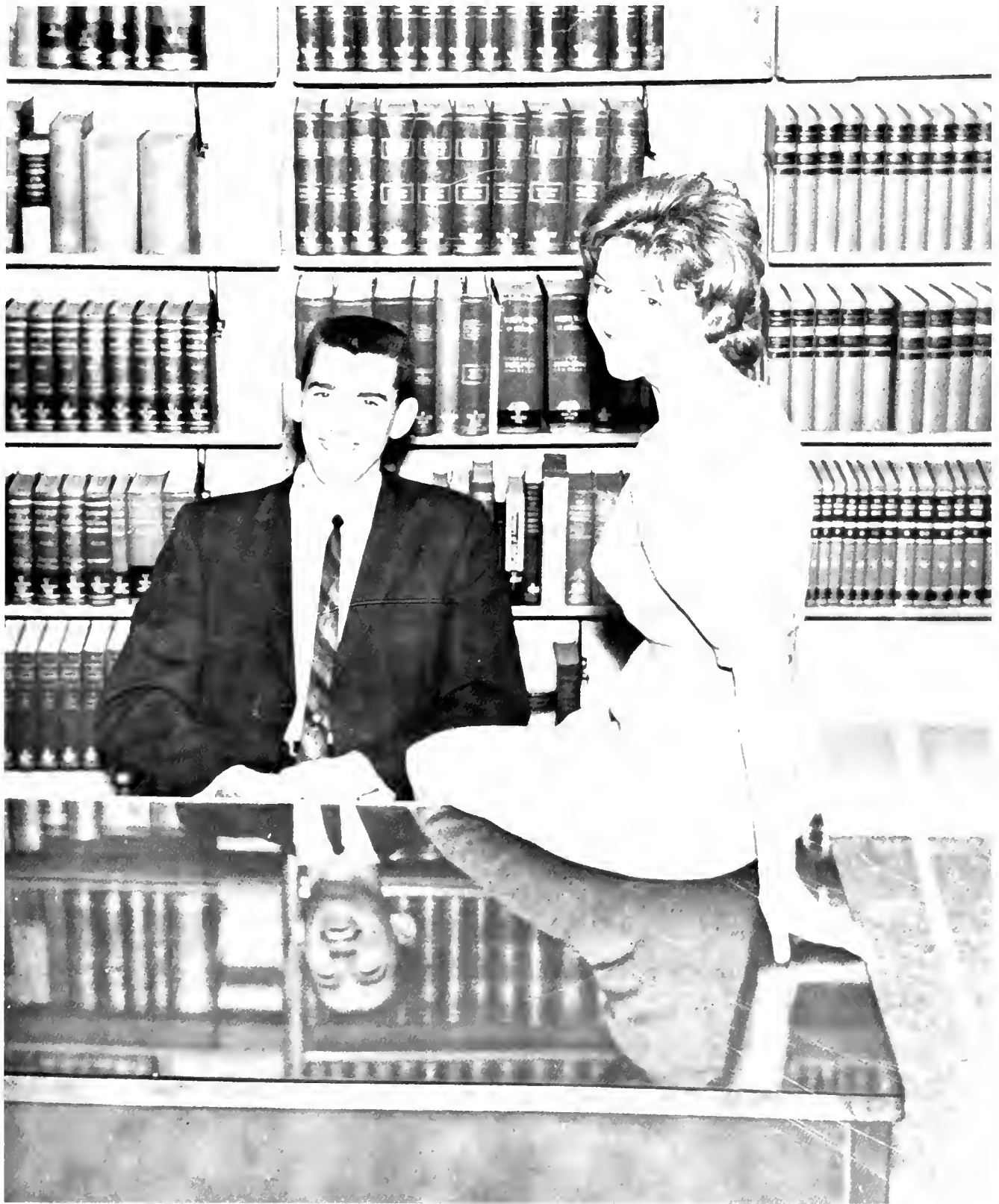

MR. & MISS CHARLOTTE COLLEGE

DWIGHT CHRISTENBURY

FLORENCE MORROW



MARY FISHER

CAMPUS QUEENS



SARAH FREEMAN



MILDRED HUNTER

CAMPUS QUEENS



BRENDA LONG



DIANA MORROW

CAMPUS QUEENS



MARY SADLER





CLASSES





SOPHOMORE CLASS OFFICERS



RODNEY LOVE
President



BOB OWENS
Vice-President

DAN THIGPEN
Secretary-Treasurer



SOPHOMORES



GEORGE ELBERT ALLEN
LARRY DONALD ALLEN



CAROLE LOUISE BLEIMEYER
JOHN WALTER BOLING



DONALD RAY ALLRED
ROBERT POWELL ANDREWS



JOHN FRANKLIN BOST, III
CARL PLOTT BURRUS



FITZHUGH LEE AUSTIN, III
DAVID CRANFORD BARNES, JR.



WILLIAM CLINTON CANADAY
MELVIN DOUGLAS CARSON



JESSY DAVID BAUGHAN
GARY LYNN BELL



DONALD LEE CARTER
LOYD EDWIN CHAMBERS



JOHN HENRY BELL, JR.
JAMES FRANKLIN BENNETT



GLENN FRANCIS CLINE
JOHN THOMAS COCHRAN



LARRY WAYNE BENTON
ROY T. BLANTON



CHRISTIAN CURTIS COLLINS
RICHARD DALE CONRAD

SOPHOMORES



PETRONELLA MAYER COULTER
WALLACE E. COWAN



JOHN HENRY DUBOSE
SAMUEL JOHN DUCKWORTH

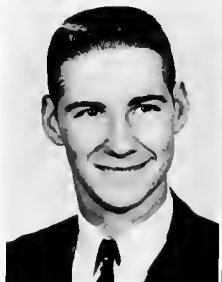

ROBERT SYLVESTER CRUMP, JR.
LARRY ORLIN CRUSE



SAMUEL JAMES EARNHARDT
WILLIAM CROKER EASON



BRUCE ALFRED CURLEE
JERRY STEWART CURRY



JOHNNY ALBERT FAULKENBERRY
GARTH MICHELE FERGUSON



JAMES CLIFTON DAVIS
WILLIAM JAVAN DAVIS



JEANNIE MCKAY GLASGOW
MARY JANE GOSLINE



BARBARA ANN DENSON
JAMES MURRAY DEYOUNG, JR.



M. W. GRASS, JR.
MARSHALL STEELE GREENE



JOHN HERBERT DEYTON
CHARLES WELDON DIXON



RONALD THOMAS GREENE
WILLIAM WENDELL GREENE

SOPHOMORES

STEVE WILEY HAAS
ANTHONY REED HANNA



MILDRED ANN HUNTER
JAMES PATRICK JACKSON



ROY LEE HARTIS, JR.
MARVIN FLAY HENDERSON, JR.



JAMES MARTIN JEWELL
WILLIAM JOSEPH KORBLES

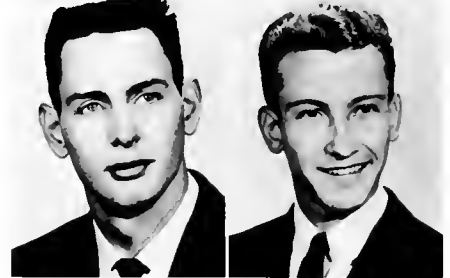

ROBERT ALLEN HENSEL
LAURIN KENNETH HINSON



FRANK AUGUST KRETSCHMER
RICHARD ALLEN LATTY



CHARLES EDWARD HOLLAND
KATY CONNOR HOLLINGSWORTH



JOHN H. LEE, JR.
WILLIAM CARLSON LOGAN



DORIS ANN HOOVER
DIANNA LEE HORNE



GEORGE EARL LONG
RODNEY RAEFORD LOVE



WILLIAM EDWARD HORNE
JEAN MONTGOMERY HUDGINS



JOHN HUNTER MCCOY
JAMES THOMAS MANNING, JR.



SOPHOMORES



HENRY BARNES MARSHALL
ROBERT MILTON MARTIN



PATRICIA ANN NORMAN
ROBERT JULIAN OWENS



LINDA MARION MAYHEW
KENNETH ROSS MEREDITH



CHARLES EMORY PETTY, JR.
JUDITH BLACKWELL POPE



JAMES BERNARD MILLER
MARSHALL DEAN MOORE, JR.



JERRY MELVIN POPLIN
GLADYS ALLGOOD PORTER



ROBERT LEE MOORE
WILLIAM EDWARD MORRISON



ANN ELIZABETH POTTS
WILLIAM KRESS QUERY



DIANA LEE MORROW
DONNIE CLIFTON MULLIS



SIDNEY BLAIR RAYFIELD
LARRY CLIFFORD REYNOLDS



FRANCIS JOHNSTONE MURDOCH
WILLIAM DENVER NEELY, JR.



EDWARD WHALEY RION
BILLY FORNEY ROSEMAN

SOPHOMORES



THOMAS WALLACE ROSS, JR.
GARLIN JAMES RUSSELL



WILLIAM WORTHINGTON STARR
JAMES CARL STEWART



JOHNNY GORDON SAYERS
EDWIN ROBINSON SCOTT, JR.



MILFORD FRANKLIN STUMPF
GEORGE JACOB SWART



JERRY LEE SHURIG
JAMES EDWIN SINCLAIR

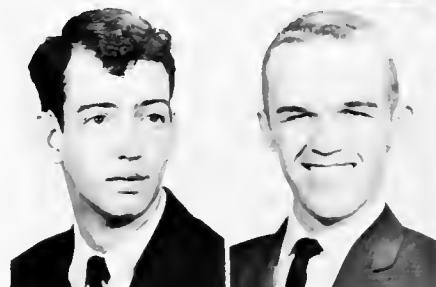

WILLIAM DENNY SWING
DENNIS GERARD WHITAKER

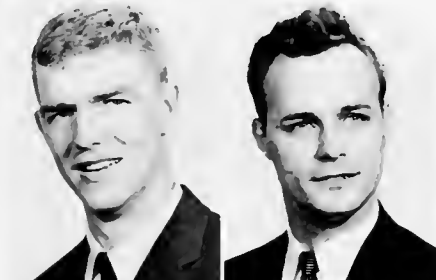

FREDERICK WARREN SING
JOHN PETER SMELIK



KENNETH WILLIAM WILKINSON
ROSS BRASWELL WILLIAMS



HERBERT WILFORD SMITH
THOMAS PATTERSON SMITH



THOMAS DONALD WILLINGHAM
JAMES DALE YANDLE



JAMES MORRIS SPEARMAN
JOE LEE STARNES



REGINALD OSCAR YORK
RAY EVERETT YOUNG









FRESHMAN CLASS OFFICERS



RONNIE JOYCE
President

CAROL HOLDEN
Vice-President



BRENDA LONG
Secretary-Treasurer



FRESHMEN

David Lawrence Adams
 LeRoy Hammond Adams, III
 Alan Gordon Aitken
 Howard Walton Aldred
 Robert Earl Alexander



David Huggins Allen
 George Milton Allen
 Victor Roy Allison, III
 Joyce Etta Almon
 Wallace L. Ammons

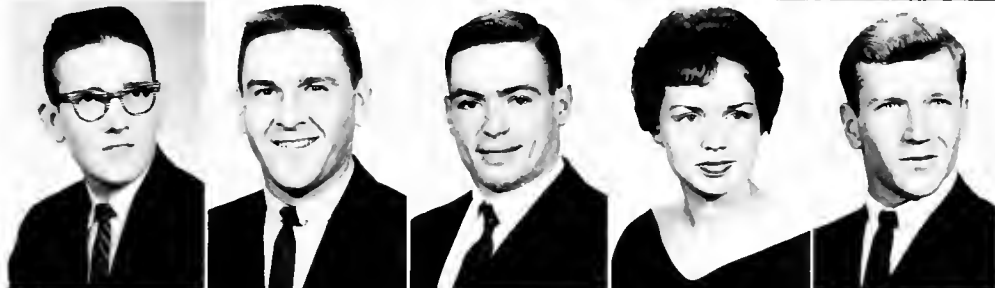

John Steen Arthur
 Larry James Atkinson
 John Lee Atwell
 Roy Franklin Atwell
 James Clyde Aycock



Glenn Edward Bailey
 Kenneth Edward Bailey
 Herbert Hoyle Baker
 Carolyn Maner Barnett
 Julian Henry Barnett



James William Barnette, Jr.
 Cleatus Barron Bartlett, Jr.
 Maurice Randolph Batts
 Cleveland Eula Beacham
 Calvin Hugh Beckwith



James Brent Belton
 Richard Grathwol Bernish
 John Miller Berry
 Joyce Elizabeth Berryhill
 Marilyn Ann Beskie



FRESHMEN



Paul Bjorneboe, Jr.
 Albert Walton Black
 Marjorie Elizabeth Blackman
 Beverly Blankenship
 Lucile H. Blanton



Barbara Eubanks Blythe
 Rolland Lee Blythe
 Charles Walter Boone
 Linda Mae Bost
 Violet Lamm Bost



George Harold Bowers
 Jackie Roland Bradshaw
 Gwenette Gail Brafford
 Richard Lynn Braswell
 William Edward Brewington, Jr.



James Andrew Brock, II
 Edward William Brody, Jr.
 Donald Alfred Brooks
 Robert Eugene Brooks
 Gary Artford Broome



Vernon Cresswell Brotherton
 Charlotte Lee Brower
 Jerry Marshall Brown
 Robert Monroe Brown
 Robert Thomas Brown



Doris Lorene Burdette
 Betty Stanford Burger
 George Anton Burkhalter
 Charles Gordon Burn
 Henry Owens Burns

FRESHMEN

Lloyd Richard Burris
 Richard Albert Cabaniss
 James Fredrick Caldwell, Jr.
 Sammy Moffett Caldwell
 Emmett Allen Canaday



Julian Edwin Carnes, Jr.
 Keith Edward Carpenter
 Samuel Eugene Carpenter, Jr.
 Elaine Laurette Carriker
 Richard Edward Carroll



Stuart Pierce Carroll
 Hugh Durant Cashion, Jr.
 Carris Manley Caudle, Jr.
 Edwin Gene Caveness
 Robert Weightstill Chambers

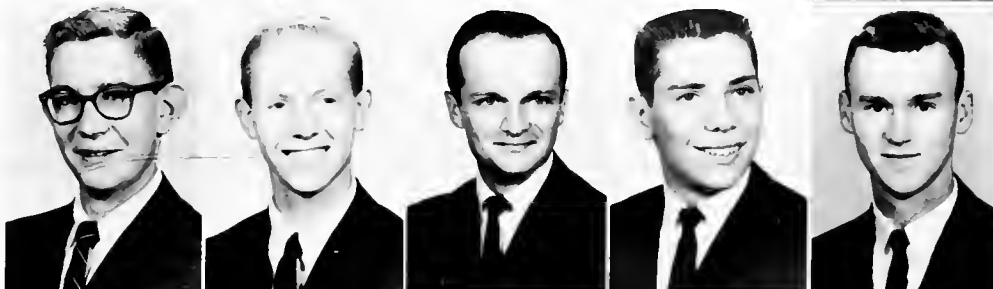

John Carroll Chipley
 John Olen Christenbury
 James Robert Clark
 Roger Glynn Cleaver
 Carl R. Cline



Wanda Jeanne Cline
 Raeford Warren Clontz
 Curtis Lowe Cloud, Jr.
 Billy Elmer Coggins
 Brian Donald Cole



Rosemary Conchita Collins
 Thomas Alvin Corbett, Jr.
 Mary Ellen Cornelius
 Hiram Archie Costner, III
 Larry Roy Cox



FRESHMEN



Robert Whitney Craver
John Edward Crosby
John Hugh Crump
William Smart Darsey
Dean Jackson Davis



Larry Jerome Davis
Hoyle Jones Deason, Jr.
James Flinn DeRamus
Lawrence Harry Dewhurst
Helen Dianne Dorton



David Ronald Douglas
Harold Franklin Douglas
William Clyde Duckworth
Dorothy Anne Duff
William Foster Dugan



William Wayne Duncan
Thomas McDonald Dunn
James Morton Durham
James Ralph Dutton
Thomas Clark Dutton



James Allen Earnhardt
Lois Ellen Earnhardt
Charles Dwight Edwards, Jr.
Margaret Ann Ellis
William Henry Ennis, III



Clarence Hugh Ewing
Ralph Yates Faulk
Michael Brown Field
Daniel Sloan Fincannon
Mary Jane Fisher

FRESHMEN

Aubrey Merrill Fleming
James Ray Flowers, Jr.
William Lawrence Flowers
Donald Ray Foster
John Roberts Foster



Sarah Elizabeth Freeman
Linda Carole Frisby
John Wesley Furr
Frank Wilson Futrell, Jr.
Judy Diane Gable



Paul Martin Garmon, Jr.
Young Edward Garrison
Henry Elliott Gatehouse
Louise Ann Gathings
Eric Flynn George



Iraj Ghaemmaghami
Charlotte Ann Gibson
Foy Ralph Gilbert
Janice Elizabeth Giles
Kenneth Eugene Gilleland



David Richard Goode
Harvey Wilson Gouch
George Washington Graham, Jr.
Larry Reed Greene
Malachi Jerome Greene



George Patterson Greenoe
John Elmore Grentzer
Benjamin Franklin Grier
William Jeffers Griffin
Richard Steven Groner



FRESHMEN

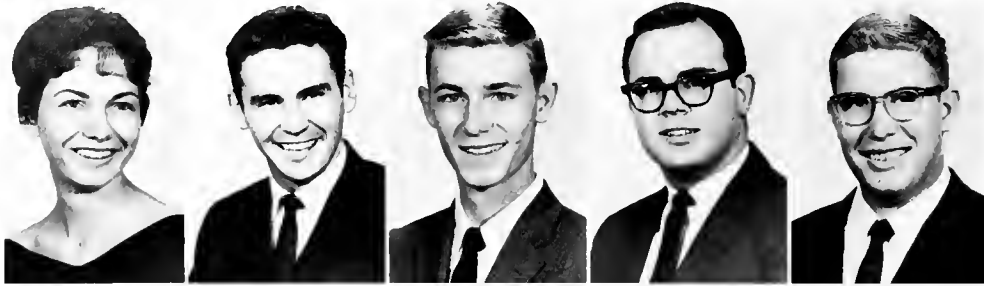

Beth Sue Groom
 John William Gwinn
 Thomas Allen Harcharik
 Aldridge Kirk Hardee, III
 Richard McCalla Hardesty

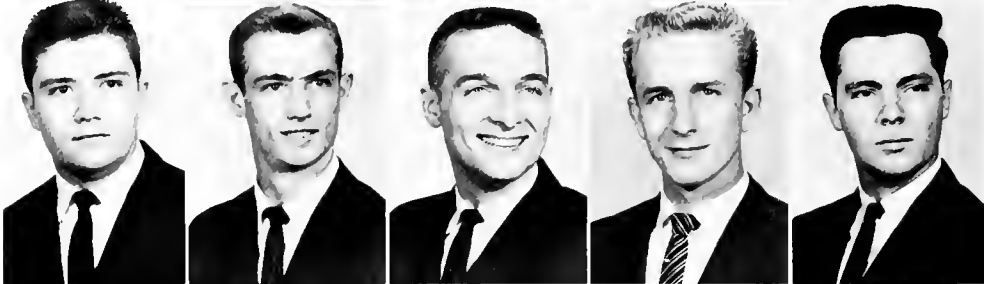

Conley Cooper Harris
 Richard Hunter Harris
 James Allen Harris
 James Robert Harris
 William Parker Harris



Alice Craddock Harrison
 Robert Everett Hartman, Jr.
 Calvin Bennett Hasty
 Marvin Luther Helms
 Mary Alice Helms



Nancy Elma Helms
 Van Eugene Helms
 Walter Lee Helms, Jr.
 Charles David Helton
 Edward Lynn Hicks



David Lynn Hill
 Winfred Norman Hill
 Barry Franklin Hinson
 Clarence W. Hobbs
 Daniel Melvin Hoffman



Carol Jean Holden
 Harry Richard Holden
 David Lee Holmes
 Marilyn Ann Holmes
 Joe Glenn Honeycutt

FRESHMEN

Wayne Harris Hooks
 Laurent Novikoff Horne
 Phyllis Jean Horne
 Robert Eugene Horne
 Ray Jackson Hough



Rebecca Dianne Howard
 Thomas Jackson Howard
 Kermit Michael Howard
 James Van Howell, Jr.
 Boyce William Howie



Heath Brewer Howie, Jr.
 James Gilmer Howie
 Milton Lee Hubbard
 Don Richard Hughes
 Jon Randell Hughes



Bill Barnes Hunnicutt
 Barbara Marian Hunter
 Anna Mariah Hyder
 Judy Lynn Idol
 James W. Ingram



Jimmy Lee James
 Ronald J. Janott
 Dudley Marvin Jarnagin
 Doris Annette Jarrett
 Bennie Gerald Johnson



Charles Vance Johnson, Jr.
 Donald Ray Johnson
 John Russell Jolly, Jr.
 Finley Herman Jones
 Gerald Miller Jones

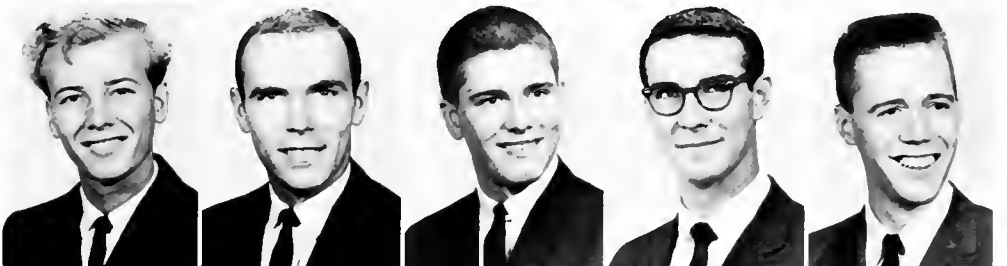

FRESHMEN

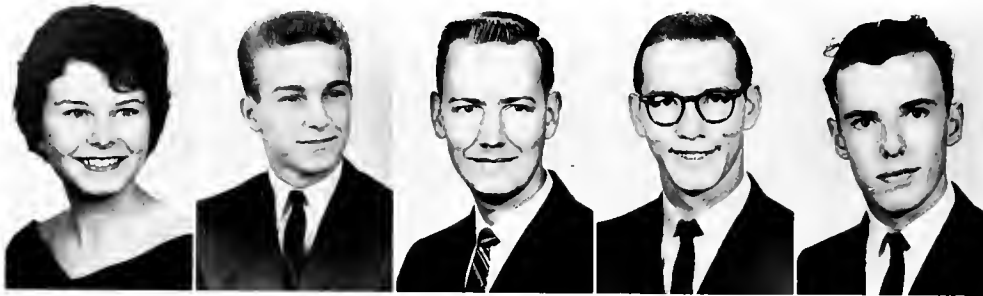

Judith Ellen Jones
 James Ronald Joyce
 Edward Pou Keen, Jr.
 John Michael Kelly
 George Manuel Kennedy



Vaudry Max Kennemore
 Emily Marcia Kerns
 Joe Rodney King
 Michael Paul Kinnard
 Patricia Reville Kinnard



James Peter Kistler, III
 Earle Eugene Knott, Jr.
 Nicolas John Komas
 Noah Morris Kraft
 Lloyd George Lane



Ann DeBerry Lanning
 James Franklin Lavender
 Phyllis Jo Leazer
 William Roosevelt Ledford
 Jerry Guy Leedy



Philip Arlen Levine
 David Morley Lindeman
 Henrietta Linker
 Sidney Jackson Linker
 Darrell Gene Little



Larry Eugene Little
 Mary Alice Little
 John Edward Livingston
 Brenda Anne Long
 Jerry Wilson Long

FRESHMEN

William Marshall Long
 Larry Dale Loving
 Wayne Thomas Lowery
 Baiba Lukevics
 Larry H. Lynn



William Edward McArver
 Ellis MacDonald McCorkle
 Priscilla Blanton McCrorie
 David Fetzer McDonald
 William Eugene McDonald



Calvin Luther McGowan
 Jerry Reid McGraw
 Myron David McGuirt
 LaVerne McIlwaine
 Alfred Welch McIntosh



James Robert McKeel
 Donald David McLeod, Jr.
 Al Hendrix McNeely
 Malcolm Jerome McSwain
 Thomas Franklin McWhirter



Ira Michael Madans
 Connie Jane Marley
 Joyce Ann Marlowe
 Charles Jeffory Marshall
 Robert Edgar Martin



Joan Francine Meacham
 John Franklin Meacham
 Charles Thomas Melton
 Hugh Gary Miller
 James Campbell Miller



FRESHMEN



Joseph Robert Miller
 Ronald Christopher Miller
 Daniel Bruce Mills
 Lou Jean Mills
 John Sherrill Monahan



Philip Toler Montgomery
 James Joseph Moore
 Judith Kay Morgan
 Lloyd Glen Morris, Jr.
 Florence Margaret Morrow



Richard D. Morton
 Richard Lane Mullis
 Robert Winston Mullis
 Judith Fitzjohn Murdoch
 Harry Clifton Murr



William MacArthur Nance
 Nathan Tomlinson Neely, Jr.
 William Marshall Newman
 Jerry Arthur Nichols
 Peggy Hilker Noreen

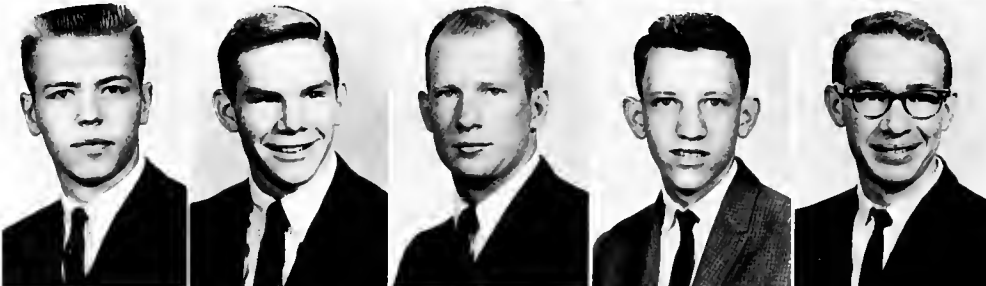

Norman Davis Norwood
 Ronald Lewis Oates
 Young Michael O'Connor
 Eugene Franklin Oliver
 Edward June Osborne



Orion Taylor Osborne
 Edgar Allen Owen, Jr.
 Doyle Wayne Owens
 George Richard Parker, Jr.
 Samuel Norcum Payne

FRESHMEN

Charles C. Peach
 Robert Alfred Pearson
 Jerry Monroe Pender
 Judy Gail Penegar
 Enrique Percal

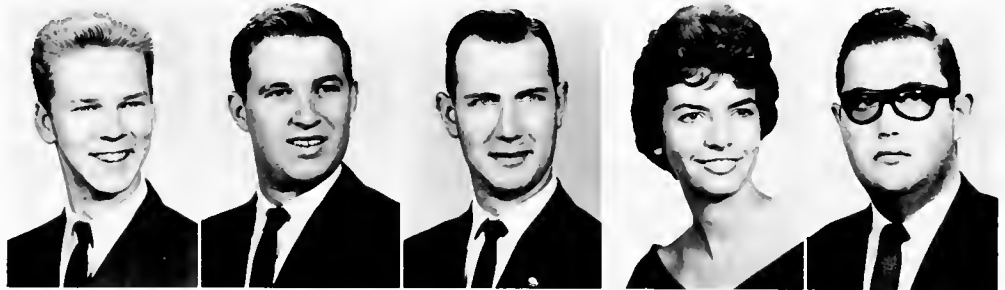

Frank Thomason Pharr
 Edward Lee Philemon
 John Christopher Phillips, III
 Perry Thomas Phillips
 James DeArmon Philmon

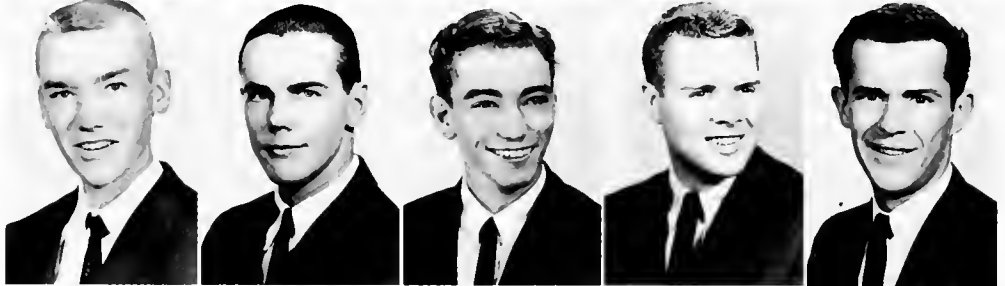

Linda Schubert Pipkin
 Jerrie Lynn Pittard
 Ronald Kenneth Polk
 John Frank Potts, Jr.
 Melvin Glenn Preston

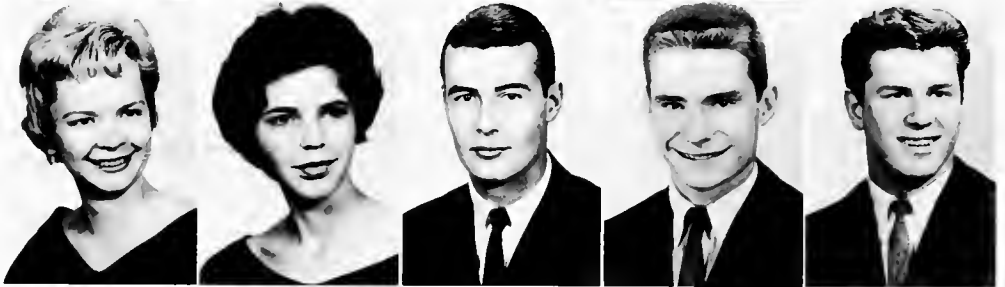

Samuel Kendrick Price
 Claude Ervin Raby, Jr.
 James Barry Ranson
 Baxter Sanford Reavis, Jr.
 Alexander Phipps Reddeck



Tommy Clarence Reep
 James Monroe Rhyne, Jr.
 Gordon Smith Richards
 Guy Nelson Riggs
 Ronald Fred Ritter



Jane Russell Robertson
 Richard Charles Robeson
 Alexander McAuley Robinson, Jr.
 Franklin Wayne Rogers
 Frank Elwood Rohleder, Jr.



FRESHMEN



Margaret Ellen Ross
Joseph Curtis Royal
William Tandy Royster, Jr.
Kenneth Edward Rubin
James Paul Rudisill, Jr.



Gary Franklin Russell
Bruce Ludvig Russo
James Darrel Russo
Mary Louise Sadler
Ronald Hendrix Sadler



Drew Paschal Saunders
John Anthony Schachner
Maurice Clinton Scruggs
Edna Lucille Seaman
Ruth Carolyn Secrest



David Porter Shaffner
Jan Carol Shive
Patrick Dinkins Shue
Calvin Lester Sigmon
David Vann Simpson



George Orville Simpson
Harold Wayne Simpson
Melanie Anne Simpson
Edgar Basil Sisson, Jr.
Charles Edward Sizemore



Jack Cannon Sizemore
Margaret Mildred Sloop
Ernest Glenn Smart
Gayle Little Smith
Howard Carlyle Smith, Jr.

FRESHMEN

Miriam Paxton Smith
 Philip Alexander Smith
 Shirley Kapp Smith, II
 Wallace Edward Smith
 William Marcellus Smith, Jr.



Glenda Sharon Smothers
 William Austin Soiset
 Carl Caughman Sox, Jr.
 William Albert Springs
 Kenneth Arnold Squires



Gary Edward Stakes
 Herman Burnell Staton, Jr.
 William Wheeler Sternbergh
 Alona Junice Stewart
 Garold Allen Stewart, III



John Niles Stewart
 Mary Lou Stilwell
 James Boyd Stokes, Jr.
 Heath Lee Strawn, Jr.
 Zebulon Carson Strawn, Jr.

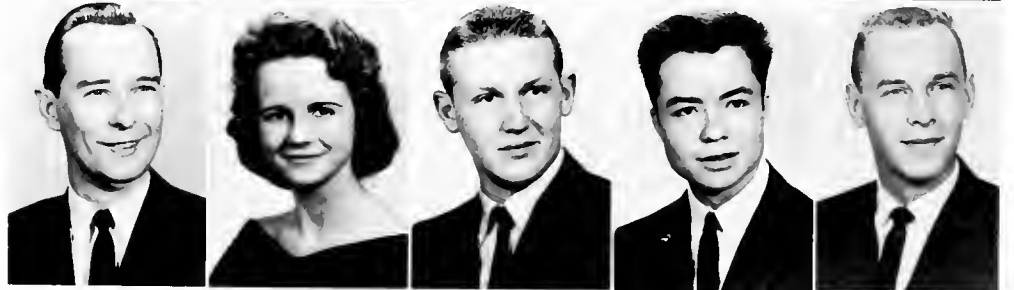

John Joseph Sutherland
 Gerald Howard Talbert
 Fredric Lee Tathwell
 James Broadus Taylor, Jr.
 Robert Tilden Taylor



Daniel Grover Thigpen, III
 George Thomas
 Hattie Rebecca Thomason
 David J. Carter Thomasson, Jr.
 Michael Wayne Thomasson



FRESHMEN



William Archie Thompson, Jr.
Melvin Douglas Threatt
Ida Jane Tidwell
Roy Wilton Tiller
Carl Clifford Tinch, Jr.



Vann Owen Trapp
Larry Gene Tucker
Sarah Marie Tucker
Charles Perry Turnipseed
Clarence Michael Underwood

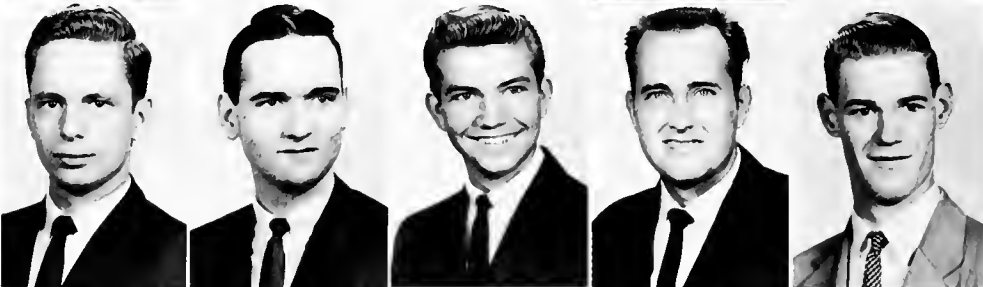

Edwin Ray Van Camp
James Douglas Vanderburg
James Jerry Vassey
Lawrence Edward Vinson
Edward Ray Walden



Hugh Anderson Walker, Jr.
James Hervey Walker
Robert Lochlin Walker
Roger Lee Walker
Phillip Lee Wally



Russell Gary Walters
Parris Mills Warwick
Mary Wilson Waterstradt
Harry Davis Watson, Jr.
Michael Roy Watts



Steven Franklin Watts
Belve Royster Weathers, II
Richard Fiske Wegner
William Pierce Wells, Jr.
James Orville Wentz

FRESHMEN

Barney Ray West

Barnie Franklin Whitley, Jr.

Robert Wayne Whitton

Richard Stanley Wilkinson, Jr.

Donald Terry Williams



Maxie Ralph Williams

William Burke Wills

George Addison Wilson

George Arnold Wilson

Johnny Edgar Wilson



Richard Deems Wilson

Robert Edwin Wilson, Jr.

William Albert Wilson, Jr.

Ernest Smith Wood

John Andrew Wood, Jr.



Stephen Smith Woodrow

Jane Hester Wyndham

William Clayton Yancy

Donald Gene Yandle

Francis Anthony Zieverink



Leo Johannes Zoutewelle

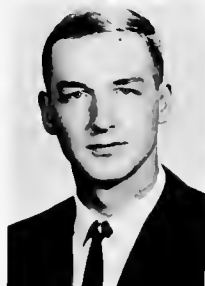



ADMINISTRATION



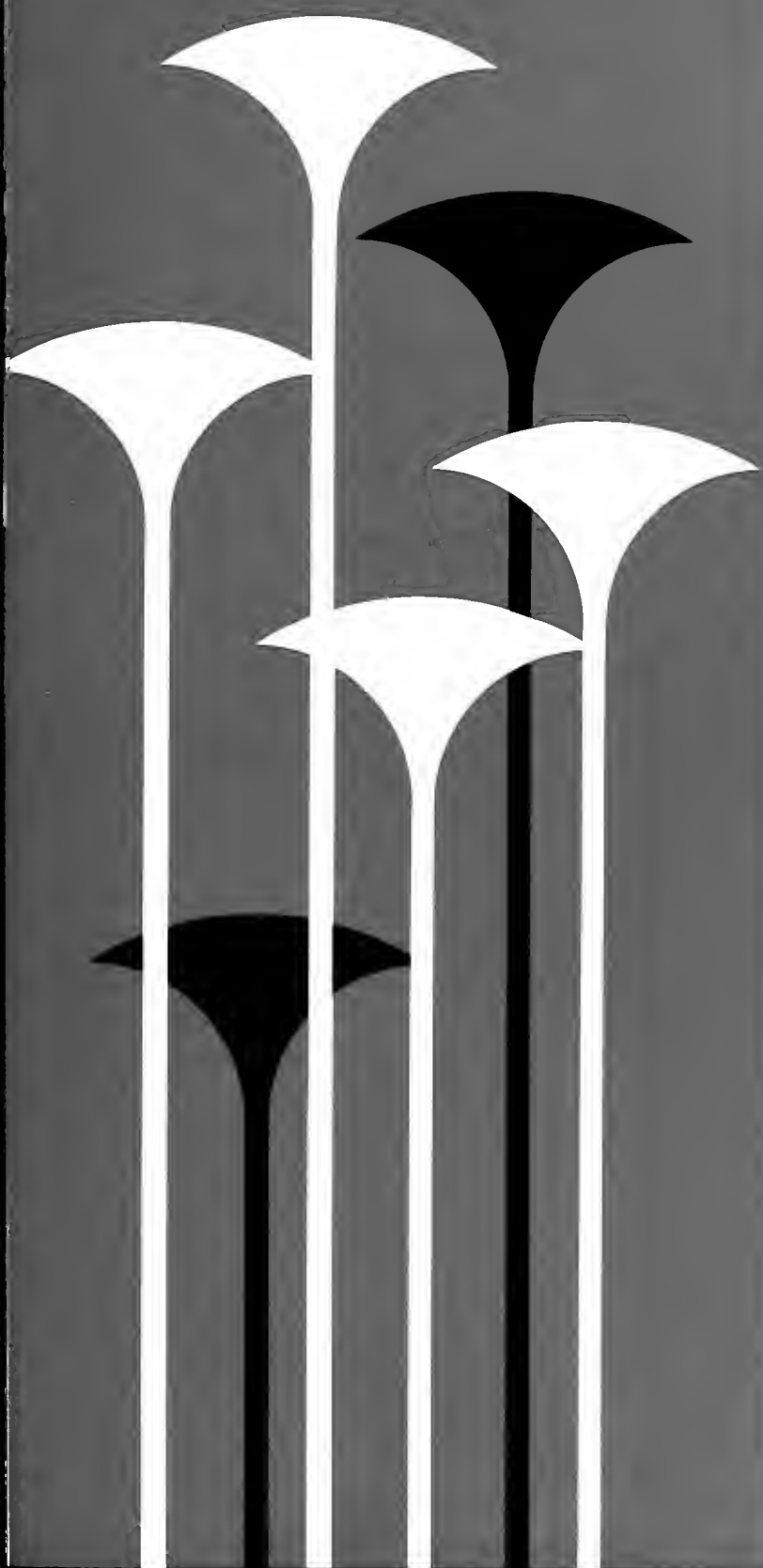



BONNIE E. CONE
President
B.S., Coker College
M.A., Duke University
LL.D., Davidson College
Litt.D., Coker College



W. L. YARBROUGH
Business Manager
B.S., Appalachian State Teachers College

MILDRED ENGLISH
Director of Student Personnel
B.S., Richmond Professional Institute
M.A., Syracuse University



H. T. HIGGINS, JR.
Registrar
B.S., Presbyterian College
M.Ed., University of North Carolina

ROMONA F. POTTER
Public Relations Coordinator
Alumni Secretary
A.B., Ripon College





JUANITA SIMS



FAYE MCCURRY

SECRETARIES



BETTY ADKINS



THELMA CATHEY

LINDA PATTERSON



LISSETTE CONNER



FACULTY

L. Evelyn Baker *English*
A.B., Winthrop College
A.M., Duke University

Percy L. Bernstein *Mathematics*
B.E., Tulane University
M.A.T., Duke University

Warren D. Blair *Shorthand*
A.A., Charlotte College
A.B., University of North Carolina
LL.B., University of North Carolina



W. B. Harold Corkey *Philosophy,
Psychology and Religion*
A.B., Queens University

Jerome O. Darholt *Engineering Graphics,
Mechanical Technology*
B.M.E., North Carolina State College

Mary R. Denny *English*
A.B., Salem College
A.M., Duke University



Mary S. Fore *English*
A.B., Winthrop College
A.M., Columbia University

Cloyd S. Goodrum, Jr. *Mathematics*
B.A.E.E., Rensselaer Polytechnic Institute
A.M., University of North Carolina

Philip J. Green *History*
A.B., M.A., University of Alabama
Ph.D., University of Chicago



Jane E. Harrison *Accounting*
A.B., Randolph-Macon College
M.B.A., Indiana University

Herbert Hechenbleikner *Botany,
Geology and Zoology*
A.B., University of North Carolina
A.M., Ph.D., Harvard University

Frances B. Hoyle *Spanish*
A.B., Woman's College, University of
North Carolina
A.M., New York University



FACULTY



Flora S. Huntley *History*
B.A., University of New Zealand

Oma C. Lafferty *History*
B.A., Tulane University
M.A., University of Chicago

Martha E. Lawrence *Mathematics*
B.A., Winthrop College
M.A., Duke University



Pierre Macy *French*
Bachelier ès lettres, Université de Nancy
Licencie ès lettres, Université de Dijon
Agrégé des lettres, Docteur ès lettres,
Université de Paris

Eleanor M. Markham *Mathematics*
A.B., A.M., Duke University

John H. Norman *Chemistry*
A.B., Erskine College
M.A., University of North Carolina



Donald G. Ousley *Accounting*
B.S., Pfeiffer College

Verne R. Ploger *Economics
and History*
B.G.E., M.A., University of Omaha

Emily S. Rountree *Mathematics*
B.S., University of South Carolina



Mozelle S. Scherger *Librarian*
B.S., Appalachian State Teachers College
B.S.L.S., University of North Carolina

DeWitt H. Scott *Journalism*
A.B., University of Florida
M.S., Boston University

Sina Serinken *Surveying*
B.S.C.E., Robert College
M.S., Duke University

FACULTY

Jadwiga Solecka *German and Spanish*
"Magister," University of Lwow

Maurice J. Stoughton
Electrical Engineering
A.B., Harvard University
M.S., Princeton University

Clyde Swofford *Mathematics*
A.B., Wake Forest College



Shirley Tarlton *Assistant Librarian*
A.B., Queens College

Mark F. Tinkham *Physics*
A.B., M.Ed., University of North Carolina

Joseph B. Whitener *Chemistry*
A.B., M.A., Trinity College
(Duke University)



Sadie H. Williamson *Business Law
and Accounting*
A.B., Woman's College, University of
North Carolina
M.S., University of North Carolina

Edyth F. Winningham *History
and Political Science*
A.B., University of North Dakota
A.M., University of North Carolina

Nancy S. Womack *Typing
and Shorthand*
B.S.S.A.-T., Woman's College,
University of North Carolina



Harvey L. Woodruff *Choral Director*
B.S., New York University
M.A., Teachers College,
Columbia University



WILLIAM F. HUTCHISON
Building Superintendent



RUTH HOLDEN
Manager of Bookstore and Snack Bar

ADVERTISEMENTS



For Over 67 Years ...

Your Home of Better Values

AIR CONTROL, INC.

2826 Griffith Street
CHARLOTTE, N. C.
Phone 332-3086

Commercial—Industrial
Air Conditioning and Heating

Sheet Metal Fabrication
Dampers and Louvers

Roy White's Flowers

"Finest in Flowers"

1933 E. Seventh St.

Phone ED 3-8846

CARRIKER EMPLOYMENT SERVICE

112 Builders Building

Phone EDison 4-1697

We congratulate the graduates
of Charlotte College and wish
for each of you much success.

R. H. BOULIGNY, INC.

433 West Morehead Street

CHARLOTTE, NORTH CAROLINA

Garibaldi & Bruns

Leading Jewelers

Since 1896



104 South Tryon Street
813 Providence Road

Compliments of

CHARLOTTE

CHEMICAL

LABORATORIES

Refreshment to You
Through the Years



BARBRE REALTY COMPANY

REAL ESTATE SALES

1512 Central Avenue

ED 4-3049

20 Years In East Mecklenburg

REAL ESTATE

Compliments of

Established 1885

Haverty's



"THERE'S NO PLACE LIKE HOME"

CHARLOTTE'S LARGEST
HOME FURNISHERS

227 North Tryon Street

ED 2-7144

We are enthusiastically watching Charlotte College grow!

DAVIS AND DAVIS REALTY COMPANY, INC.

Suite 901
201 South Tryon Building

Telephone EDison 3-0564

CHARLOTTE, N. C.

BIGGERS BROTHERS, INC.

WHOLESALE

Fruits, Produce and Eggs
Institutional Size Canned Foods

2800 South Boulevard — P. O. Box 2356
CHARLOTTE 1, N. C.

JERRY'S

**DRIVE-IN
RESTAURANT**

101 North Independence Boulevard

OPEN 24 HOURS

Compliments of

STANLEY'S Super Drug Store, Inc.

Phone EDison 3-5103

1949 East 7th Street

CHARLOTTE, N. C.

Compliments of

**McEwen
Funeral Service**



Charlotte Mobile Home Sales, Inc.

Phone 332-3914

5801 N. Tryon St.

CHARLOTTE 6, N. C.

KILLIAN OIL CO.

5328 North Tryon

Killian Super Service No. 1

5328 North Tryon

Killian Super Service No. 2

At The By-Pass

Fuel Oils Home Deliveries

ED 2-9437 — FR 6-5234

John Killian, Owner

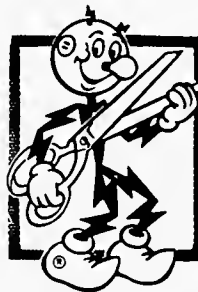

ELECTRIC COMFORT HEATING

TROUBLE-FREE

No burners to clog, no fuel to store
No tanks or pipes to check
Fewer parts to wear out

ECONOMICAL

Duke's all-electric heating rate provides savings
Individual room thermostats provide economy
of zoned heat

SAFE as an ELECTRIC LIGHT

No flame-hot surfaces to scorch or burn
No flames or fumes

CUTS CLEANING COSTS

No smoke, soot or other combustion products
Furnishings, walls and woodwork stay clean

Duke Power neither sells nor installs Electric Comfort Heating, but will provide full information and the name of qualified heat dealers

DUKE POWER COMPANY

Serving the Piedmont Carolinas

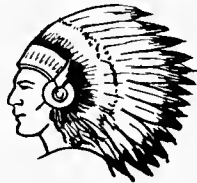

- BARBECUE PLATES & SANDWICHES
- FRENCH FRIED ONION RINGS
- CHICKEN
- SEAFOOD
- PICNIC & LUNCH BOXES

BIG CHIEF DRIVE-IN RESTAURANT

BIG CHIEF HAMBURGERS

TAKE HOME SERVICE
AT NO EXTRA COST



Dial

375-6044

3904 N. Tryon

VISIT

CAMP GREENE BARBER SHOP

On The Corner Camp Greene & Freedom Drive
1536 Camp Greene St.

Business Phone

EX 9-9332

JOE T. RUSH

Res. EX 9-0372

SPORTING GOODS
ATHLETIC EQUIPMENT

the *Sportsman* inc.

376-3548

230 Charlottetown Mall
CHARLOTTE 4, N. C.

Three Brothers Tavern



CHUCK, TED, and SAM FODEL
Owners

DINE AND DANCE

Seven days a week

Open 3:30 Till

FR 7-2254 & ED 2-9453

5100 North Tryon Street

CHARLOTTE, NORTH CAROLINA

PHOTOGRAPHERS FOR
1962 SI SI PORTRAITS

BRUMFIELD STUDIOS

CHARLOTTE, N. C.

Phone 334-7415

325 East Boulevard

BURGER HOUSE NO. 2



2301 The Plaza

Phone 375-7676

The OWLS Meet

For PIZZA

AT

The Famous OPEN KITCHEN

1318 W. Morehead St.

FR 7-9166

Flowers For All Occasions

Corsages — Cut Flowers — Funeral Designs



Tuxedos For Rent

Sizes—3 Years to Men's 58L



American Beauty Florist, Inc.

1506 South Boulevard

EDison 3-4177

PARK DRIVE IN



Highway 29 North

Charlotte, N. C.

Phone 596-0341

CAROLINA INSURORS (INC.)

H. GILMER HOWIE, Manager

Insure Today—Be Sure Tomorrow

221 S. Church St. Phone ED 4-2824
CHARLOTTE, N. C.

Compliments of

PATHWAY BOOK STORE

A Religious Book Store

Serving Ministers and Churches of All Faiths

Mail Orders Promptly Filled

CHARLOTTE, NORTH CAROLINA

231 S. Church St. Phone 375-7856

HOWARD JOHNSON'S RESTAURANT

DELICIOUS FOOD
EXCELLENT SERVICE

3314 N. Independence Boulevard

Phone 376-4577

**PATRONIZE
YOUR ADVERTISERS**

BABE MALOY'S DRIVE IN

2721 N. Independence Boulevard

(Across From Coliseum)



Now under new ownership

Visit us often

For fast service and good food

NORMAN'S MARKET

2843 Razzell's Ferry Road

Phone EX 2-5161

BUTLER SEAFOOD

919 S. McDowell Street

CHARLOTTE, N. C.

Phone FR 5-4409

MINIT CAR WASH

1121 E. Fourth St.

ED 3-8801

2511 S. Boulevard

JA 3-5426

YOUNCE GULF SERVICE

Corner Morehead and Graham Sts.

Compliments of

SHONEY'S NO. 2 SHORT ORDER



Jim Odell and James Terrell

Compliments of

WESTERN ELECTRIC COMPANY INCORPORATED

CHARLOTTE, NORTH CAROLINA

HARRY'S Super  SERVICENTER

EXpress 9-7725

3911 Wilkinson Blvd.

CHARLOTTE, N. C.

ROAD SERVICE

Harry J. Shaheen, Owner

SHOPPING CAN BE FUN AT

Charlottetown Mall

Forty Merchants Invite You To Shop **EVERY NIGHT TILL 9
SATURDAY TILL 6**

Colonial Food Store
Roses 3-10-25c
Cakery Bakery
Singer Sewing Center
Hastess Shop
Charlottetown Pet Center
Kay Jewelry
Ferrell's Optician
Mall Barber Shop
Faith Shoe Repair
Charlottetown Beauty Salon
Hard's Studio
Gentry House
The Sportsman

Best Shops
Phillips Shoes
Franklin Simon
Bon Marche
Lerner Shops
Brittains
Tats to Teens
Tham McAn
Stark Center
Charlotte Bookshop
Elaine's Underfashions
Silver Grill (S&W)
North Carolina Notional Bank
Tweed Shop

Sherwin Williams
Sandwich Shop
Hi-Fi Camera Center
Piedmont Floor Covering
Western Auto
One Hour Valet
Eckerd Drug
Shoe Heel Bar
Key Shop
S&W Cafeteria
Roseland Floral Co.
Charlottetown ESSO
(Corner Kings Dr. and Baxter St.)

Independence Boulevard & Kings Drive—

PLENTY OF FREE PARKING

"I believe that every right implies
a responsibility; every opportunity,
an obligation; every possession, a
duty."

John D. Rockefeller, Jr.

Compliments of

ROBERT L. TAYLOR



SOUTH 21

3631 South Boulevard
3101 N. Independence Boulevard

NOW IT'S PEPSI



FOR THOSE WHO THINK YOUNG

Compliments of

A FRIEND



Compliments of

PLAZA THEATRE

Compliments of

KING CHEVROLET CO.

531 East Trade Street

CHARLOTTE, NORTH CAROLINA

Phone ED 2-3131

Payne Furniture Company



COMPLETE HOME FURNISHINGS

118 South College Street

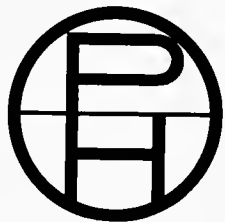

OBSERVER PRINTING HOUSE
CHARLOTTE, N. C.





