









SMITHSONIAN  
MISCELLANEOUS COLLECTIONS

VOL. 56



"EVERY MAN IS A VALUABLE MEMBER OF SOCIETY WHO, BY HIS OBSERVATIONS, RESEARCHES,  
AND EXPERIMENTS, PROCURES KNOWLEDGE FOR MEN" -SMITHSON

(PUBLICATION 2091)

CITY OF WASHINGTON  
PUBLISHED BY THE SMITHSONIAN INSTITUTION  
1912



## ADVERTISEMENT

---

The present series, entitled "Smithsonian Miscellaneous Collections," is intended to embrace all the publications issued directly by the Smithsonian Institution in octavo form; those in quarto constituting the "Smithsonian Contributions to Knowledge." The quarto series includes memoirs, embracing the records of extended original investigations and researches, resulting in what are believed to be new truths, and constituting positive additions to the sum of human knowledge. The octavo series is designed to contain reports on the present state of our knowledge of particular branches of science; instructions for collecting and digesting facts and materials for research; lists and synopses of species of the organic and inorganic world; reports of explorations; aids to bibliographical investigations, etc., generally prepared at the express request of the Institution, and at its expense.

In the Smithsonian Contributions to Knowledge, as well as in the present series, each article is separately paged. The actual date of its publication is that given on its special title-page, and not that of the volume in which it is placed. In many cases works have been published and largely distributed, years before their combination into volumes.

CHAS. D. WALCOTT,  
*Secretary of the Smithsonian Institution.*





## CONTENTS

---

1. COCKERELL, T. D. A. The scales of the African characimid fishes. Published May 7, 1910. 10 pp., 2 pls. (Publication number 1929.)
2. HOLLISTER, N. Mammals collected by John Jay White in British East Africa. March 31, 1910. 12 pp., 2 pls. (Pub. No. 1930.)
3. COCKERELL, T. D. A. The scales of the mormyrid fishes, with remarks on *Albula* and *Elops*. May 7, 1910. 4 pp. (Pub. No. 1931.)
1. SCHMITTER, FERDINAND. Upper Yukon native customs and folklore. May 26, 1910. 30 pp. (Pub. No. 1933.)
5. CLARKE, FRANK WIGGLESWORTH. A preliminary study of chemical denudation. June 29, 1910. 19 pp. (Pub. No. 1935.)
6. BECKER, GEORGE F. The age of the earth. June 29, 1910. 28 pp. (Pub. No. 1936.)
7. ELLIOT, D. G. Description of a new subspecies of African monkey of the genus *Cercopithecus*. June 11, 1910. 1 p. (Pub. No. 1937.)
8. BUSCK, AUGUST. Notes on a horn-feeding lepidopterous larva from Africa. July 28, 1910. 2 pp., 2 pls. (Pub. No. 1941.)
9. HELLER, EDMUND. Descriptions of seven new species of East African mammals. July 22, 1910. 5 pp., 3 pls. (Pub. No. 1942.)
10. DALL, WILLIAM HEALEY. New land shells from the Smithsonian African Expedition. July 22, 1910. 3 pp. (Pub. No. 1945.)
11. REESE, ALBERT M. Development of the digestive canal of the American alligator. October 29, 1910. 25 pp., 15 pls. (Pub. No. 1946.)
12. RITTER, WOLFGANG. Hodgkins Fund. The flying apparatus of the blow-fly. A contribution to the morphology and physiology of the organs of flight in insects. May 11, 1911. 76 pp., 20 pls. (Pub. No. 1947.)
13. HOLLISTER, N. Two new African rats. October 10, 1910. 3 pp. (Pub. No. 1988.)
14. MEARNS, EDGAR A. Descriptions of ten new African birds. December 23, 1910. 7 pp. (Pub. No. 2003.)

15. HELLER, EDMUND. New species of insectivores from British East Africa, Uganda, and the Sudan. December 23, 1910. 8 pp., 1 pl. (Pub. No. 2004.)
16. HRDLIČKA, ALEŠ. Some results of recent anthropological exploration in Peru. April 26, 1911. 16 pp., 4 pls. (Pub. No. 2005.)
17. HELLER, EDMUND. New species of rodents and carnivores from Equatorial Africa. February 28, 1911. 16 pp. (Pub. No. 2006.)
18. STEARNS, MARY R. Bibliography of the scientific writings of R. E. C. Stearns. With biographical sketch by William Healey Dall. April 11, 1911. 15 pp., 1 pl. (Pub. No. 2007.)
19. ABBOT, C. G. The silver disk pyrheliometer. March 31, 1911. 10 pp., 1 pl. (Pub. No. 2008.)
20. MEARNS, EDGAR A. Descriptions of fifteen new African birds. April 17, 1911. 11 pp. (Pub. No. 2010.)
21. NELSON, E. W. Description of a new genus and species of humming bird from Panama. July 8, 1911. 2 pp. (Pub. No. 2015.)
22. NELSON, E. W. Two new subspecies of birds from Panama. September 7, 1911. 1 p. (Pub. No. 2053.)
23. CHRIST, H. On *Psomiocarpa*, a neglected genus of ferns. November 21, 1911. 4 pp., 1 pl. (Pub. No. 2054.)
24. MAXON, WILLIAM R. A remarkable new fern from Panama. November 22, 1911. 5 pp., 3 pls. (Pub. No. 2055.)
25. MEARNS, EDGAR A. Descriptions of seven new African grass-warblers of the genus *Cisticola*. November 23, 1911. 6 pp. (Pub. No. 2056.)
26. HOLLISTER, N. Four new mammals from the Canadian Rockies. December 5, 1911. 4 pp. (Pub. No. 2062.)
27. GOLDMAN, E. A. A new kingfisher from Panama. December 1, 1911. 2 pp. (Pub. No. 2058.)
28. MEARNS, EDGAR A. Description of a new species of sunbird, *Helionympha raineyi*, from British East Africa. November 28, 1911. 1 p. (Pub. No. 2059.)
29. MAXON, WILLIAM R. Three new club-mosses from Panama. January 6, 1912. 4 pp., 3 pls. (Pub. No. 2064.)
30. BENT, A. C. A new subspecies of Ptarmigan from the Aleutian Islands. January 6, 1912. 2 pp. (Pub. No. 2066.)
31. WILLIS, BAILEY. Report on an investigation of the geological structure of the Alps. February 7, 1912. 13 pp. (Pub. No. 2067.)

32. BENT, A. C. Notes on birds observed during a brief visit to the Aleutian Islands and Bering Sea in 1911. February 12, 1912. 29 pp. (Pub. No. 2068.)
33. STANDLEY, PAUL C. Three new plants from Alberta. February 7, 1912. 3 pp. (Pub. No. 2069.)
34. STANDLEY, PAUL C. A new leather flower from Illinois. February 7, 1912. 3 pp., 1 pl. (Pub. No. 2070.)
35. HOLLISTER, N. New mammals from Canada, Alaska, and Kamchatka. February 7, 1912. 8 pp., 3 pls. (Pub. No. 2072.)
36. GOLDMAN, E. A. Descriptions of twelve new species and subspecies of mammals from Panama. February 19, 1912. 11 pp. (Pub. No. 2073.)
37. NELSON, E. W. Descriptions of two new species of nun birds from Panama. February 16, 1912. 2 pp. (Pub. No. 2074.)



SMITHSONIAN MISCELLANEOUS COLLECTIONS

VOLUME 50, NUMBER 1

# THE SCALES OF THE AFRICAN CHARACINID FISHES

WITH TWO PLATES

BY

T. D. A. COCKERELL

University of Colorado, Boulder, Colo.



(PUBLICATION 1929)

CITY OF WASHINGTON  
PUBLISHED BY THE SMITHSONIAN INSTITUTION  
May 7, 1910

WASHINGTON, D. C.  
PRESS OF JUDD & DETWEILER, INC.  
1910

# THE SCALES OF THE AFRICAN CHARACINID FISHES

By T. D. A. COCKERELL

UNIVERSITY OF COLORADO, BOULDER, COLO.

(WITH TWO PLATES)

As primitive relatives of the Cyprinidæ, confined to the Neotropical and Ethiopian regions, the Characinidæ (or Characidæ) are of more than usual interest to students of the evolution of fishes. After having spent much time in the investigation of the scales of the Cyprinids, I was very anxious to see those of the Characinids, and the opportunity was offered during a recent visit to the British Museum. For all the material used in the preparation of the present paper I am indebted to the kindness of Dr. G. A. Boulenger, who has in his custody at the British Museum a truly wonderful collection of African freshwater fishes, as every ichthyologist knows. It was an extraordinary privilege to have access to these rich materials, which had been gathered with so much difficulty and sometimes danger, and had formed the basis of classical researches.

The sculpture of an ordinary fish-scale includes two important elements, the circuli and the radii. The circuli are circular lines, sometimes referred to as "lines of growth," while the radii are lines or grooves radiating outward from the nuclear area, which may or may not be in the center of the scale, but is practically always in the middle line. The most primitive fish with scales resembling those of the Teleosts is *Amia calva*, and through the kindness of Dr. B. W. Evermann I have been able to examine specimens of this fish from the Yellow River at Plymouth, Indiana. There are no radii, but the scales are made up of longitudinal strands which are really separable elements, and will fray out basally. These appear on the scale as very fine striæ which in the apical field are directed toward a broad rugulose nuclear area. There is no doubt, I think, that these are the circuli of the Teleosts, and indeed they are nearly repeated in various forms, though I know no scale which as a whole can be said to closely resemble that of *Amia*.<sup>1</sup> This view

---

<sup>1</sup> I placed a scale of *Polypterus endlicheri* (from the White Nile) in acid to ascertain the structure of the organic basis, which proved to be rather scanty and of a sponge-like consistency.

suggests the probability that the Teleosts with very fine and dense circuli (*e. g.*, the majority of the Old World Cyprinids) are so far more primitive than those in which the circuli are fewer (*e. g.*, the New World Cyprinids, but *not* the Catostomids), as had already been assumed on other grounds.

The radii, according to this theory, are of secondary origin. In some cases they may lose their radial arrangement, and more or less simulate circuli. This is seen in *Alosa sapidissima* Wilson (fig. 1), the circuli of which are extremely fine and delicate, while the radii of the basal field actually take the form of widely spaced transverse, almost concentric lines. In some of the scales (the larger and broader ones) this development is so complete as to conceal its origin, but in other scales on the same fish the various transitional states can be perceived.



FIG. 1. *Alosa sapidissima*  
Wilson

Drawn by Miss E. V. Moore

On the other hand the circuli may also become transverse, losing the appearance of concentric lines. This is excellently shown in *Scomber chrysozonus*, from Massauah (pl. I, fig. 1); that the lines really are circuli is proved by the scale of *Scomber pneumatophorus* (Table Bay, Cape of Good Hope), (pl. I, fig. 2), in

which they are still obviously circuli.

The African Characinidæ have scales of two main types, which seem to be wholly distinct. The first, including the Hydrocyoninæ and Citharininæ, may be called the Cyprinoid type, showing a distinct—often strong—resemblance to the scales of the Cyprinidæ. In this type the nuclear area is central, or nearly so, and the scales are usually cycloid, rarely ctenoid, and when so not at all like the ctenoid scales of the other group.

The second or ctenoid group proper includes the Ichthyoborinæ and Distichodontinæ, which cannot be separated on the squamation. In this series the apical teeth are very regular and numerous, united laterally, and the nuclear area is almost at the apex, the base being thrown more or less into folds. This basal folding appears to lead to the very distinctive system of basal radii found in the Acanthopterygian and allied fishes; *e. g.*, in *Tilapia nilotica* (Cichlidæ), (pl. I, fig. 3), *Apomotis cyanellus* (Centrarchidæ), *Cyprinodon fasciatus* (Cyprinodontidæ), and *Anabas munii* (Anabantidæ).



This type of basal radii thus runs through the Haplomi, Acanthopterygii and Percesoces; yet it is wholly absent in the Scombrids, so far as I know, and *Gadus* (*cf.* H. W. Maretts, Quart. Journ. Micr. Science, Oct., 1905) shows nothing of it. (The scale of *Gadus* is curiously like that of *Catostomus*.) The ctenoid features found in *Anabas* seem to be traceable to a Berycid source. It is evident, of course, that no Acanthopterygian fish can be derived from any Characinid stock, but it is suggested that the basal folding was developed among the Malacopterygians (*Alosa* shows it sufficiently well) and carried thence to the Characinid and Acanthopterygian (or Haplomid) ancestors.

I hope in some later contribution to compare the South American Characinid scales with the African. At present I cannot do this for lack of material, but the little I know suggests that there may be little resemblance between them. (Figure 2 (drawn by Miss Evelyn V. Moore) shows the scale of *Cheirodon insignis* Steindachner from Panama; this fish is placed by Boulenger in the Hydrocyoninæ, but it will be seen that there is no resemblance to the scales of any of the African members of that subfamily. The scale of *Luciocharax* is quite unlike anything African, but this belongs to an exclusively American subfamily (Xiphostominæ).

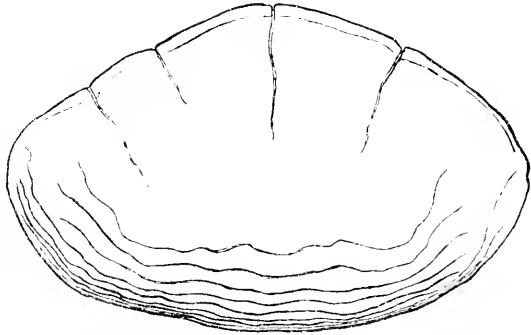

FIG. 2. *Cheirodon insignis* Steindachner

For the means of obtaining the photographic figures (the work of Mr. T. C. Black, of Boulder, Colorado) I am indebted to a grant from the American Association for the Advancement of Science. It may be worth while to state that in order to get good photographs the scales must be mounted dry. When placed in balsam many of the characters are obscured.

#### HYDROCYONINÆ

The scales of the African Hydrocyoninæ fall naturally into three groups:

- (1) *Sarcodaces* group, in which the approximately circular scales have fine and rather numerous radii, and the circular sculpture is very distinct, the apical circuli very coarse and quite different from the basal and lateral. *S. odoë* examined.

- (2) *Alestes* group, including *Alestes*, *Microlestes*, and *Petersius*, in which the radii are few but very strong, the sculpture is often weak in the apical region, and the scales are frequently much broader than long.
- (3) *Hydrocyon* group, in which the apical field is more or less rugose, and the radii are evanescent, the basal radii usually absent. The dorsal scales of *Hydrocyon* show numerous but very weak apical radii, which produce some crenulation of the very thin margin, indicating a slight approach to a ctenoid condition. *H. forskalii* examined.

It appears probable that *Sarcodaces odoë* (River Benue, north of Ibi, *H. L. N. Traill*) has the more primitive type of scale. *Hydrocyon forskalii* (River Nile) can be derived from this by the general weakening of all the structures; while the *Alestes* group represents a reduction of the radial system, with a much stronger development of what remains. Thus three fairly distinct tribes would appear to be indicated: Sarcodacini, Alestini, and Hydrocyonini, their typical genera *Sarcodaces*, *Alestes*, and *Hydrocyon* respectively. The term Hydrocyonini was used by Bonaparte as early as 1838 (*Nuovi Annali delle Sci. Nat.* 2, p. 132). *Bryconathiofs* I have not seen.

#### ALESTES

**Group A.** Scales very large, the transverse diameter over 15 mm.

- (1) Scales very much broader than long.

*Alestes taniurus* Günther. Kribi River, Cameroon (*G. L. Bates*).

Scale about 10.5 mm. long and 16.5 broad; basal radii about 12; discal region divided into many polygonal areas.

- (2) Scales not much broader than long.

*Alestes rhodopleura* Boulenger. Mtondwe Bay, Lake Tanganyika (*Cunnington*).

Scale about 18 mm. long and 21 broad; basal radii two; lateral radii two on each side, more or less inclined to be divided or delta-like marginally; apical radii few and quite irregular; apical region rugose; circuli of basal region extremely fine.

*Alestes macrolepidotus* Cuvier and Valenciennes. River Nile. Structure essentially as in *A. rhodopleura*; rugosity of apical region, resulting from modified circuli, very pronounced. The discal region may be reticulate.

**Group B.** Scales smaller, the transverse diameter much less than 15 mm.

Owing to individual variation and the small amount of material available it is impossible to determine the precise specific characters in this group. Some of the species probably cannot be separated on the scales. In no case are the scales of the very broad *taniurus* type.

- (1) Comparatively large reddish scales, with the apical rugosity poorly developed.

*Alestes macrophthalmus* Günther. Lake Tanganyika (*J. E. S. Moore*).

Radii very few and feeble, in the single scale examined there is only one basal; scale about 7.5 mm. long and 9 broad.

*Alestes liebrechtsii* Boulenger. Coquilhatville, Upper Congo (*Delhez*).

Radii more numerous, about six basal, but two of these incomplete; discal region with some polygonal areas; scale about 8.5 mm. long and 10.5 broad. The characters separating these two are doubtless variable.

- (2) Rather large white scales, with the apical circuli forming conspicuous strong ridges; the basal circuli, as usual, very fine.

*Alestes affinis* Günther. Wabbi System (*O. Neumann*).

- Only one basal radius; apical region with the radii branching and anastomosing quite irregularly, all very strong; scale about 7 mm. long and 8 broad.

*Alestes imber* Peters. Lake Nyassa (*Capt. E. L. Rhoades*).

- Thinner scales than those of *A. affinis*; basal radii three; apical region quite as in *A. affinis*. Scale about as broad as long.

- (3) Rather small (6 to 7 mm. diameter) whitish scales of a rather broad type, having the outline of a little more than a half circle; apical sculpture feeble; basal radii three or four. There is no sign of the apical structure described under *A. affinis*. These scales are certainly nearer to the *macrophthalmus* group than to the *affinis* group.

*Alestes (Brachyalestes) longipinnis* Steindachner. Sette Cama, Gaboon (*Gerrard*).

*Alestes chaperi* Sauvage. Kotchwah River (*R. B. N. Walker*).

- These two were united by Günther, and certainly there is no difference in the scales.

- (4) Small scales about 6 mm. diameter or less, without very marked characters.

*Alestes sadleri* Boulenger. Entebbe, Lake Victoria (*Degen*).

- Polygonal areas present or absent; apical circuli rather strong.

*Alestes lateralis* Boulenger. Kafue River, Upper Zambesi (*T. Codrington*).

- Scale small, but not from a fully-grown fish. Only one basal radius.

*Alestes intermedius* Boulenger. Kribi River, Cameroon (*G. L. Bates*).

- Scale rather broad, with five basal radii; apical sculpture very feeble; lateral circuli, especially in the subdiscal region, much less dense than usual, and minutely wavy or zigzag.

*Alestes nurse* Rüppel. River Nile.

- Basal radii variable up to about six; polygonal areas present or absent.

*Alestes baremose* Joannis. River Nile.

- Basal radii one or two; polygonal areas not observed; scale in general similar to that of *A. nurse*, but differing in important details, as shown below.

The scales described above were all taken from the vicinity of the lateral line, about the level of the beginning of the dorsal fin. The following notes describe the variation observed on the different parts of the fish.

*Alestes macrolepidotus*. This species is remarkable for the very large scales, and the posterior situation of the first dorsal fin. The borders of the scales are beautifully purplish-iridescent, but the fish is not silvery like *A. nurse* and *baremose*. The coarse apical circuli become entirely longitudinal, suggesting the corresponding structures in *Ania calva*, in which the progenitors of the circuli are longitudinal strands. The apical radii largely anastomose transversely, resulting in the formation of very irregular transverse markings, few in number. In the ventral region the sculpture is more profuse, and the apical field develops a sort of cancellation, in which the *longitudinal* lines appear to represent modified circuli, and the *transverse modified radii*. The anterior dorsal scales are again quite different, with

a curiously *Amia*-like sculpture, composed almost altogether of elements representing the circuli, but consisting of coarse longitudinal striae or strands, which are, however, continuous with the usual extremely fine and regular circuli of the concealed portion of the scales, the latter having about three strong basal radii and one on each side.

*Alestes nurse*. Very similar in appearance to *A. baremose*, but deeper-bodied. The strong apical circuli are mainly longitudinal, meeting at an acute angle in the middle line. The apical radii often have transverse branches, more or less in the manner of a spreading tree; usually there is a single apical radius, with branches leaving at right angles, but in the dorsal and ventral regions there are more.

*Alestes baremose*. The sculpture, on close comparison, is really very distinct from that of *A. nurse*. The apical circuli, instead of forming regular grooves, are evanescent, reduced to a fine rugosity; the apical field is sparsely punctate; the one to three apical radii are usually incomplete, and show no lateral branches. The ventral and dorsal scales show many thin, weak, parallel apical radii.

*Alestes opisthotenia* Boulenger, from Efulen, Cameroon (*G. L. Bates*) has rather large (about 8 mm. long and 10 broad) white scales, resembling those of the *affinis* group; with four basal radii, discal polygonal areas, and coarse apical circuli. The interesting feature of the scale is, however, that it is subctenoid, with small but very evident apical denticulations. The teeth are broader than long, and indicate the beginning of such structures as are found, much better developed and much reduced in number, in *Citharidium ausorgii*. The ctenoid scales of *Distichodus*, *Xenocharax*, etc., are entirely different. There are slight indications of apical denticulation in some other *Alestes*, as *A. rhodopleura* and *A. imberi*.

#### MICRALESTES

The scales of this genus cannot be distinguished from those of *Alestes*: that is to say, there is no *generic* difference, though *specific* distinctions may be found to separate any particular species of *Micralestes* from any particular *Alestes*. The scales are always conspicuously broader than long.

**Group A.** Apical circuli strong, coarse, and complete, those of the two sides meeting at an obtuse angle.

*Micralestes holargyreus* Günther. Roma (*Delhez*).

Scale 3.5 mm. long, 5.33 broad; six radii, all strong and complete, one apical, one basal, and two on each side; no polygonal areas. In *Alestes* it comes near to *A. longifinnis*, but it is a shorter scale, with much better developed apical sculpture.

**Group B.** Apical sculpture feeble, the circuli ill-defined, although the basal circuli are very distinct.

*Micralestes altus* Boulenger. Lindi, Congo (*Brussels Museum*).

Scale about 5 mm. long and 7 broad; basal circuli much denser than lateral; three basal radii, one apical, one or two on each side; no polygonal areas. (These characters will vary; I doubt whether there is any constant difference in the radii between the species of *Micralestes*.)

*Micralestes humilis* Boulenger. Ja River, S. Cameroon (*G. L. Bates*).

Scale about 4 mm. long and 5.33 broad; structure as in the last. Basal radii one to six; apical one to two; polygonal areas present or absent.

*Micralestes interruptus* Boulenger. Stanley Pool, Congo Free State.

Scale small, only about 3.33 mm. wide; structure as in the others, but basal circuli less dense. Five basal and three apical radii; polygonal areas present.

None of the *Micralestes* show any branching of the apical radii.

PETERSIUS

The scales of *Petersius* are quite as in *Micralestes*, having the same broad form, with few radii, the apical never branching.

**Group A.** Scale relatively large, about 6 mm. long and 9 broad; apical sculpture very feeble.

*Petersius major* Boulenger. Nyong River, Cameroon (*G. L. Bates*.)

Basal radii four, apical two.

**Group B.** Scale smaller, diameter about 5 mm. or rather less. Apical circuli better developed.

*Petersius occidentalis* Günther. Infoan (*Walker*).

Basal radii about four, variable; sides of scale flatter than in the next.

*Petersius hilgendorfi* Boulenger. Kutu, Lake Leopold II (*Delhez*).

The scale examined has only four radii, one basal. Its outline is that of a half circle.

*Petersius caudalis* Boulenger. Boma (*Delhez*).

Basal radii two or three; small polygonal areas sometimes developed.

The smallest of the *Petersius* scales.

CITHARININÆ

Herbivorous fishes, with the teeth minute or absent. Gill (*Proc. U. S. Nat. Mus.* 18, p. 207) suggests that this group should perhaps constitute a distinct family, Citharinidæ. The scales are subcircular to transversely oval, without basal radii, wherein they differ from the African Hydrocyoninæ, excepting *Hydrocyon*.

The following table separates the scales of the species studied:

Scales ctenoid, with large, sharp apical teeth, but these few and far apart, wholly unlike those of *Distichodus*, etc.; nuclear area nearly central, and with circuli to middle; circuli very strong, only moderately dense; scales about 2.33 mm. long and 3.67 broad.

..... *Citharidium ansorgii* Boulenger,  
Lake Oguta, Nigeria (*Ansorge*).

Scales cycloid ..... 1

1. Apical area with fewer and coarser circuli, abruptly marked off from lateral ..... 2

Apical area not, or not very abruptly, marked off from lateral ..... 4

2. Broad scale with very many apical radii; nuclear area granular; scale about 7 mm. long and 10 broad, the largest of the *Citharinine* scales.....*Citharinus gibbosus* Boulenger. Niamkolo, Lake Tanganyika (*Cunnington*).  
Rounder scales, with fewer apical radii; nuclear area with circuli to middle ..... 3
3. Scale larger, nearly 6 mm. long, about 7 broad; character of sculpture entirely as in *C. gibbosus*.....*Citharinus macrolepis* Boulenger. Boma, Lower Congo (*Delhez*).  
Scale smaller, about 5 mm. broad; otherwise practically the same..  
..*Citharinus latus* Müller and Troschel. Beni Souef (*Loat*).
4. Nuclear area with circuli to middle; apical area with very large, coarse circuli, but not quite abruptly separated from lateral; scales small, a little over 3 mm. wide....*Citharinus citharus* Geoffroy (*geoffroyi* Cuvier). White Nile (lake near) (*Loat*).  
Nuclear area broadly granular; apical circuli coarse; scale 4.33 mm. broad..  
..*Citharinus congicus* Boulenger. Bolobo, Congo (*Greufell*).

The above key is not wholly satisfactory, because the scales of *Citharinus* are really of a very uniform type, without very obvious specific characters. Two tribes are indicated: *Citharidiini* for *Citharidium*, and *Citharinini* for *Citharinus*.

Boulenger places two American genera in this subfamily, but Gill separates them as *Curimatinae*. I have not seen their scales.

*Hydrocyon forskalii* runs in the above table near *Citharinus congicus*, but the resemblance is merely superficial.

#### ICHTHYOBORINÆ

Carnivorous forms with ctenoid scales. There is nothing to distinguish their scales from those of the *Distichodontinae*. The apical teeth are numerous and close together, having little in common with those of *Citharidium*. The species examined are:

*Phago boulengeri* Schilthuis. Monsembe, Upper Congo (*J. H. Weeks*).

The scales are hard, bone-like plates joined together, but the apical densely-set spine-like teeth are quite as in the other forms.

*Eugnathichthys cetveldii* Boulenger. Monsembe, Upper Congo (*J. H. Weeks*).

Small subquadrate scales, with the nucleus apical, just below the row of teeth; no radii, but the basal region is broadly plicate.

*Ichthyoborus besse* Joannis. Fashoda (*Loat*).

Scales practically as in the last.

*Neoborus ornatus* Boulenger. Monsembe, Upper Congo (*J. H. Weeks*).

Scales also as in *Eugnathichthys*, except that the apical region is coarsely rugose.

*Paraphago* and *Mesoborus* have not been examined.

## DISTICHODONTINE

Herbivorous (or partly herbivorous) fishes with ctenoid scales, which resemble those of the Ichthyoborini. The fact that *Eugnathichthys* and *Ichthyoborus* have quite similar scales, and the absence of any characteristic difference between the scales of the Ichthyoborine and Distichodontine fishes, show that after the development of this type of squamation differentiation took other directions; hence the scales fail to afford any adequate clue to the minor subdivisions of these groups.

In some *Distichodus* (*notospilus*, *sexfasciatus*, *atroventralis*, *engycephalus*) the subapical (exposed) part of the scale is more or less grooved or sub-reticulate, but otherwise there are no substantial differences between the genera and species examined, which are as follows:

*Nannocharax fasciatus* Günther. Kribi River, Cameroon (Bates).

*Nannocharax niloticus* Joannis. River Nile.

The *Nannocharax* scales are the smallest of the series, less than 2 mm. broad. This accords with the small size of the fishes.

*Neolebias unifasciatus* Steindachner. Ja River, Cameroon (Bates).

Scales about 2.33 mm. broad.

*Nannethiops uniteniatus* Günther. Sette Cama, Gaboon (Gerrard).

Scales about 4 mm. broad; basal plication very strong. The scales are longer in proportion to their breadth than those of *Neolebias*.

*Xenocharax spilurus* Günther. Ibali, Lake Leopold II (Delhez).

Scales about 4.25 mm. long and 5 broad.

*Distichodus antonii* Schilthuis. Monsembe, Upper Congo (Weeks).

In this species and *D. atroventralis* the scale is unusually broad in proportion to its length.

*Distichodus atroventralis* Boulenger. Kutu, Lake Leopold II (Delhez).

I do not know how to distinguish the scale definitely from that of *D. antonii*.

*Distichodus engycephalus* Günther. River Nile at Cairo (Loat).

Scales not quite 5 mm. long, about 5 broad; apical (exposed) area reticulate.

*Distichodus fasciolatus* Boulenger. Monsembe, Upper Congo (Weeks).

Scales about 3 mm. broad; nuclear area more or less rugose.

*Distichodus brevipinnis* Günther. Fashoda, White Nile (Loat).

Scales little broader than long, shaped as in *D. niloticus*, but larger.

*Distichodus niloticus* Linnæus. Fashoda, White Nile (Loat).

*Distichodus rostratus* Günther. Gondokoro, White Nile (Loat).

Scales quite as in *D. niloticus*; dermal pigment-spots also the same.

*Distichodus lusosso* Schilthuis. Banzyville, Ubangi (Capt. Royaux).

Scales small, less than 3 mm. diameter; subapical field broadly rugulose.

*Distichodus mossambicus* Peters. Loangwa River, N. W. Rhodesia (S. A. Neave).

Nuclear area very broadly rugulose; a subdorsal scale is broader in proportion to its length than one from near the lateral line.

*Distichodus sexfasciatus* Boulenger. Coquilhatville, Upper Congo (Delhez).

Scale rather broad; apical field with radiating grooves.

*Distichodus notospilus* Günther. Kribi River, Cameroon (*G. L. Bates*); Komadekke, Ogowe (*W. J. Ansorge*).

The Kribi R. specimen has the largest scales I have seen in this genus, about 8.5 mm. long and 10.5 broad.

Judging from the general characters of the fishes, and especially perhaps from the development of the maxillary, we may infer that the Hydrocyoninae, a carnivorous group, have given rise to the herbivorous Citharininae. Using similar criteria, however, it would seem that the herbivorous Distichodontinae had given rise to the carnivorous Ichthyoborinae.

## EXPLANATION OF PLATES

### PLATE I.

- FIG. 1. *Scomber chrysozonus*. Massauah. British Museum. Gill rakers very long.
- FIG. 2. *Scomber pneumatophorus*. Table Bay, Cape of Good Hope. = *colias* = *japonicus*. British Museum.
- FIG. 3. *Tilapia nilotica*. Birket Karûn, Fayoum. British Museum.
- FIG. 4. *Alestes sadleri*. Entebbe. Lake Victoria (Degen). British Museum.
- FIG. 5. *Micralestes holargyreus* Günther. Boma (Delhez). British Museum.
- FIG. 6. *Petersius caudalis*. Boma (Delhez). British Museum.

### PLATE 2.

- FIG. 1. *Citharidium ansorgii*. Lake Oguta. S. Nigeria (Ansorge). British Museum.
- FIG. 2. *Citharinus congicus*. Bololo. Congo (Grenfell). British Museum.
- FIG. 3. *Eugnathichthys ecteoldii* Blgr. Monsembe. Upper Congo (J. H. Weeks). British Museum.
- FIG. 4. *Xenocharax spilurus*. Ibali. Lake Leopold II (Delhez). British Museum.
- FIG. 5. *Distichodus antonii*. Monsembe. Upper Congo (Weeks). British Museum.
- FIG. 6. *Distichodus scxfasciatus*. Coquillatville. Upper Congo (Delhez). British Museum.
- FIG. 7. *Distichodus notospilus*. Komadekke. Ogowe (W. J. Ansorge). British Museum.



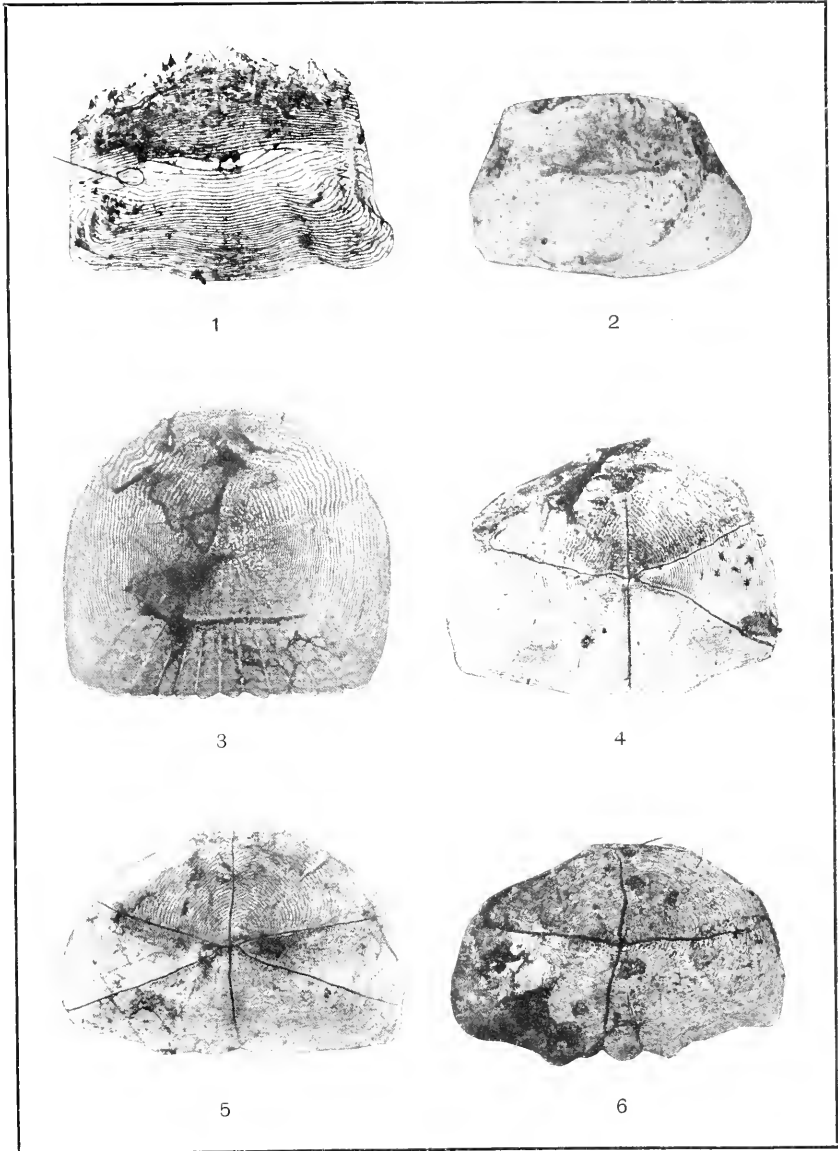

SCALES OF AFRICAN FISHES



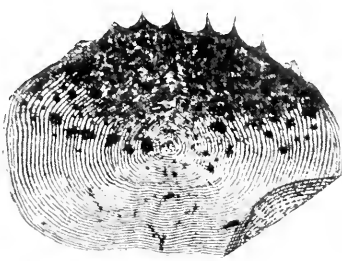

1



2

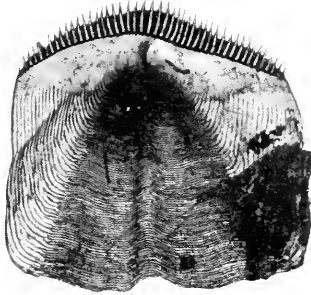

3

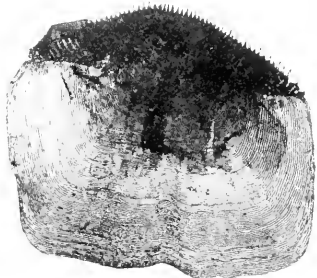

4

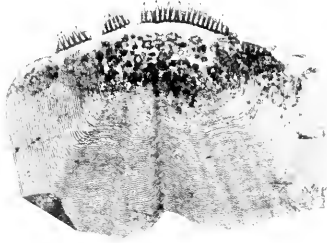

5



6

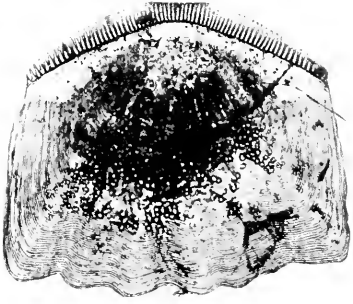

7

SCALES OF AFRICAN FISHES



SMITHSONIAN MISCELLANEOUS COLLECTIONS

VOLUME 56, NUMBER 2

MAMMALS COLLECTED BY JOHN JAY  
WHITE IN BRITISH EAST AFRICA

WITH TWO PLATES

BY

N. HOLLISTER

Assistant Curator, Division of Mammals, U. S. National Museum



(PUBLICATION 1930)

CITY OF WASHINGTON  
PUBLISHED BY THE SMITHSONIAN INSTITUTION  
March 31, 1910



# MAMMALS COLLECTED BY JOHN JAY WHITE IN BRITISH EAST AFRICA

BY N. HOLLISTER

ASSISTANT CURATOR, DIVISION OF MAMMALS, U. S. NATIONAL MUSEUM

(WITH TWO PLATES)

Mr. John Jay White, of Washington, D. C., has presented to the United States National Museum a number of large mammals collected by himself in British East Africa during the summer of 1908. Several of the specimens are of special interest, and the collection as a whole is of considerable importance.

On May 8, 1908, in company with Dr. W. S. Rainsford, Mr. White left Nairobi for Nakuru, at which point the party left the railroad on the following day and traveled northward, by way of Ravine Station, to Sirgoit Rock, where they arrived May 21. From this date until the first of July the time was spent in hunting over the Guas Ngishu Plateau. July 8 they arrived at Ravine on the return, and traveled east and north for the Laikipia Plateau. About six weeks were spent in hunting over the region to the north of Laikipia Boma and Mount Kenia, and, on the return to the railroad, three days—September 6 to 8—were devoted to the game on the Elmenteita Plains. September 18 the party again left Nairobi, and another month was spent on the Guas Ngishu Plateau.

Mr. White has furnished some interesting information about many of the species. The substance of this is included, throughout the list, after the technical notes on the specimens.

## **GIRAFFA CAMELOPARDALIS ROTHSCILDI** Lydekker

Body skin and mounted head of an adult male (No. 155438) from the Guas Ngishu Plateau, June 22. This specimen is a topotype and therefore of special value to the Museum. The mizzen horns are only slightly developed.

This animal was almost a record specimen for the form. Measured rather hurriedly in the rain, without the front legs fully stretched, it exceeded seventeen and a half feet in height. The dry skin measured twenty-one and one-half feet from tip of nose to end of tail, and exactly the same distance between the edges of the fore hoofs across the shoulders. Giraffes were found to be fairly plen-

tiful on the Guas Ngishu Plateau, and herds numbering up to a dozen or fifteen animals were frequently seen. One herd of about seventy-five was noted, but this group later divided, about twenty-five animals going in one direction and the remainder in another.

#### BUBALIS COKEI (Günther)

Skull and skin of head and neck of a large male, given to Mr. White by Dr. W. S. Rainsford. Probably killed on Dr. Rainsford's last trip to the Thika River region, northeast of Nairobi, in December, 1908.

The skull is a remarkable specimen in many ways, and differs from any in the large series before me from neighboring regions to the north and south. Compared with skulls of old males from Taveta, Kapiti Plains, and the Guaso Nyiro River, it differs in its greater length, greater breadth, relatively short distance from anterior end of premaxilla to first premolar, wide interpterygoid space, and small teeth. The horns are massive, wide spreading, and the first ascending section is much longer than in any other specimen. The terminal section is short, and the horn is therefore divided into almost equal thirds, the outward ascending, horizontal, and terminal parts being of equal length. The measurements of this skull (No. 155430) are: Condylbasal length, 410 millimeters; palatal length, 235; greatest breadth, 142; facial length, 405; muzzle to orbit, 302; upper tooth row, 88; length of horns, 390; circumference at base, 254; greatest spread, 430; spread at points, 395; length of backward terminal point, 120.

These animals were noted by Mr. White on the Laikipia Plateau, in the Elmenteita and Naivasha Lake country, and on the Athi and Kapita plains. None were seen on the Guas Ngishu Plateau.

#### BUBALIS JACKSONI Thomas

Skull and head skin of adult male from the Guas Ngishu Plateau, about June 15. This specimen, from only a short distance north of the type locality of *jacksoni*, agrees with the descriptions of that species, and the specimens in the Museum, in most particulars. The points of the horns, however, incline inward, after the style of *B. nicdeckeri*, from the White Nile region. Another specimen from the same locality, a mounted head in Mr. White's collection, has the horn tips nearly parallel, or but slightly turned outward; and others were killed, as shown in photographs taken by the party, in which the horns distinctly turned outward. This illustrates the instability



of such minor horn characters, as a large series would evidently show considerable variation in the angle of the terminal section of the horn.

The measurements of this skull (No. 155431) are: Condylbasal length, 426 millimeters; palatal length, 241; greatest breadth, 138; facial length, 438; muzzle to orbit, 312; upper tooth row, 100; length of horns, 553; circumference at base, 304; greatest spread, 250; spread at points, 112; length of smooth backward terminal section, 210.

The skin of the head is a rich red in color with a faint stripe of black down the back of the neck from between the ears to the point where it was severed from the body.

This hartebeest was very abundant on the Guas Ngishu Plateau, where hundreds were seen almost daily, in herds of from three or four up to fifty or more each. Many other animals, especially the zebra and topi, and sometimes the giraffe and eland, take advantage of the abundance of the kongoni and graze among the herds, apparently depending upon them to give the first alarm of approaching danger. The breeding season for many of the British East African ungulates appears to extend over the greater part of the year, and, in large herds of Jackson's kongoni, young of several ages, from small calves to nearly grown, were often seen.

#### CONNOCHÆTES TAURINUS ALBOJUBATUS Thomas

Skin of head and neck to withers. Killed by Dr. Rainsford on the Athi Plains, in December. Practically a *topotype* of *albojubatus*. The color represents the dark phase and is much darker than in any of six heads in the Museum collection from "Masailand," the yellowish-white throat fringe being especially conspicuous.

This animal was seen only in the Athi Plains country and apparently does not occur on the Laikipia or Guas Ngishu plateaus.

#### OREOTRAGUS OREOTRAGUS SCHILLINGSI (Neumann)

In the collection presented by Mr. White were the feet of one of these antelopes from the Laikipia Plateau. In his collection of trophies Mr. White has two heads of old bucks which differ greatly in color. One from Elmenteita has the head gray, with almost pure white markings, while the head from the Laikipia country is everywhere deeply suffused with an ochraceous color, giving a very different appearance to the animal.

Klipspringers were frequently seen on the Laikipia Plateau, usually in small groups of two or three individuals. At one time five were seen on the same hill, but this was probably a chance gathering of two lots. None were seen on the Guas Ngishu Plateau.

### OUREBIA COTTONI Thomas

#### PLATE I, FIG. 1, SKULL

Three skulls and head skins from south of the Nzoia River, on the Guas Ngishu Plateau, June. These are practically topotypes of *cottoni*, described from Sirgoit Rock, and show the species to be very distinct from *O. kenyae*, from the region northeast of Nairobi, though closely related to *O. montana*. From the latter it is, however, readily distinguished by the larger horns. The skins agree with the series examined by Thomas in the absence of a distinct dark frontal blaze. The skulls agree in all important measurements and characters with the description of the type. They measure:

	155415	155420	155421
	Adult male.	Young male	Young male.
	mm.	mm.	mm.
Greatest length .....	168	165	163
Condylbasal length.....	157	155	154
Greatest breadth .....	75	73	73
Interorbital breadth .....	54	45	40
Muzzle to orbit.....	87	85	85
Upper tooth row.....	53	— <sup>1</sup>	— <sup>1</sup>
Length of horn.....	123	100	93

<sup>1</sup> Last molars not entirely in place.

### OUREBIA MICRODON, new species

#### PLATE I, FIGS. 2, 3, SKULL

*Type*.—Skull of adult male, Cat. No. 155422, U. S. N. M., collected south of the Nzoia River on the Guas Ngishu Plateau, British East Africa, summer of 1908, by John Jay White.

*Diagnostic characters*.—Size large; rostrum long; teeth small; horns short, stout, and heavily ringed.

*Color*.—External characters unknown.

*Skull and teeth*.—Compared with skulls of *O. cottoni* the type skull of *O. microdon* is much larger, with longer rostrum, narrow interpterygoid fossa, and smaller teeth. Though the skull is larger, the teeth are actually smaller. The basioccipital is nearly square, with surface almost flat; very different from the deep-pitted, triangular basioccipital of *O. cottoni*. From *O. montana* it differs in

much larger size; horns stouter and heavily ringed; rostrum heavier; basioccipital square and flat. It may be distinguished from skulls of *O. kenya* by its larger size, longer rostrum and nasals, narrow interpterygoid fossa, square and flat basioccipital; and shorter, stouter, more heavily-ringed horns. The skull of *O. microdon* differs also from skulls of all the above-mentioned species in the straight line of the inner edge of the upper tooth row, which in all of these is decidedly concave. The palate, therefore, is almost oblong, and the distance across between the first premolars almost equals the distance across between the last molars.

*Measurements.*—See table below for measurements of the type skull.

*Remarks.*—As known from the skull alone this new oribi is very different from *O. cottoni*, inhabiting the same region. It appears to be more closely related to *O. kenya*, from the headwaters of the Tana River.

A comparison of measurements of skulls of adult males of the four species of *Ourebia* from the region is given in the following table:

<i>Ourebia</i> skulls. Adult males	<i>O. microdon.</i>	<i>O. cottoni.</i>	<i>O. kenya.</i>	<i>O. montana.</i>
	155422	155415	162857	112098
	Guas Ngishu Plateau. Type.	Guas Ngishu Plateau.	Near Nairobi.	120 mi. east of Lado.
	mm.	mm.	mm.	mm.
Greatest length .....	175	168	165	164
Condylbasal length .....	163	157	154	153
Basal length .....	152	146	143	144
Palatal length .....	98	94	88	89
Greatest breadth .....	77	75	75	74
Interorbital breadth .....	51	54	49	44
Muzzle to orbit .....	95	87	85	86
Length of nasals .....	60.5	61	51	58
Upper tooth row .....	48	53	49	50
Length of horn .....	168	123	115	102
Circumference of horn .....	55	50	47	47

#### KOBUS DEFASSA UGANDÆ (Neumann)

Skull and head skin of adult male, killed on the Guas Ngishu Plateau, south of the Nzoia River, summer of 1908. The specimen agrees with Neumann's description in its large size and colors, the bright rufous face contrasting decidedly with the paler color of the cheeks and neck.

Measurements of the skull (No. 155414) are: Greatest length, 420 millimeters; condylbasal length, 408; greatest breadth, 166;

nasals, 153; palatal length, 220; interorbital breadth, 123; upper tooth row, 114; muzzle to orbit, 246; length of horn, 692; circumference of horn at base, 249; distance between points, 420; greatest spread, 507. In this skull the premaxillæ fail to reach the nasal bones by a distance of ten millimeters.

#### CERVICAPRA REDUNCA WARDI Thomas

Skull and head skin of adult male from the Guas Ngishu Plateau, June. Measurements of skull (No. 155429): Greatest breadth, 103 millimeters; length of nasals, 92; interorbital breadth, 63; upper tooth row, 58; length of horn, 217; distance between points, 135.

The reedbuck was common on the Nzoia River; singles, pairs, and small herds of up to seven or eight animals were seen.

#### GAZELLA THOMSONI NASALIS Lonnberg

Three skulls of adult males, two of them accompanied by skins of head and neck to shoulders, from Elmenteita, September 7. The skins exhibit a very distinct black patch on the nose, and appear to represent the northern race. The skulls show no appreciable characters to separate them from skulls of typical *thomsoni* from the Kilimanjaro region. Measurements of skulls:

	155427	155428	155426
	<i>mm.</i>	<i>mm.</i>	<i>mm.</i>
Condylbasal length .....	108	106	183
Greatest breadth .....	84	88	85
Muzzle to orbit.....	101	105	98
Length of nasals.....	54	50	42
Interorbital breadth .....	49	55	50
Upper tooth row.....	54	55	57
Length of horn.....	300	315	281
Distance between points.....	100	86	104

Very abundant about Elmenteita. Comparatively few were seen on the Laikipia Plateau and none were found on the Guas Ngishu Plateau.

#### GAZELLA GRANTI GRANTI Brooke

Skulls and head skins of two adult males, killed on the Elmenteita Plains about September 7. Skull measurements are as follows:

	155424	155425
	mm.	mm.
Greatest length .....	115	114
Condylbasal length .....	264	261
Palatal length .....	134	132
Muzzle to orbit.....	141	137
Interorbital breadth .....	70	65
Upper tooth row.....	88	85
Length of horn.....	565	580
Distance between points.....	290	263

Grant's gazelles were quite plentiful at Elmenteita, though by no means so abundant as the Thomson's gazelles.

#### GAZELLA GRANTI NOTATA Thomas

Skull and head skin of adult male, shot near the upper waters of the Guaso Nyiro River, on the Laikipia Plateau, July 28.

The general color of the skin of head and neck is much darker than in specimens of *Gazella g. granti* from the Kilimanjaro region. The horns are very different, also, spreading but little at the points and with much less of the graceful gazelle curve of typical *granti*. There appear to be no constant cranial characters by which skulls without horns of the two forms can be separated. Measurements of the skull: Condylbasal length, 260 millimeters; palatal length, 129; greatest breadth, 111; muzzle to orbit, 138; interorbital breadth, 61; upper tooth row, 81; length of horn, 512; distance between points, 160.

This gazelle was seen by the expedition only on the Laikipia Plateau, where it was not especially plentiful.

#### ORYX ANNECTENS, new species

*Type*.—Skin, Cat. No. 155436, U. S. N. M., collected in the vicinity of the Guaso Nyiro River, Laikipia Plateau, British East Africa, about August 8, 1908, by John Jay White.

*Diagnosis*.—In general like *Oryx beisa*, but lateral stripe narrower and head markings somewhat approaching those of *O. callotis*; skull as in *O. beisa*, but molars conspicuously larger, their size nearly as in *O. callotis*.

*Color*.—The skin differs in color and markings from a Berbera, Somaliland, specimen and all plates and descriptions of the Abyssinian and Somaliland animals. The main body color is an ecru drab with a buffy tint and a decided vinaceous cast. The lateral stripes, which in *beisa* are broad bands about 30 mm. wide in the

middle and about 50 mm. wide near the posterior end, are reduced to narrow streaks from 8 mm. wide in the middle to 10 mm. wide near the posterior end. The stripe is nowhere pure blackish brown, as in *beisa*, but is everywhere mixed with hairs of the body color. In *beisa* the lateral stripe sharply divides the area of color of the side from the white of the belly. In the Laikipia animal the white below the stripe is suffused with the darker color of the side, the stripe really passing across the lower edge of the side color nearly an inch above the white of the belly, which gradually becomes purer below it, instead of being sharply defined. The dorsal stripe is also less distinct.

The markings of the head differ somewhat from a head of *beisa* also. The black stripe passing through the eye extends down and forward nearly to the corner of the mouth, and the face patch is broader at the lower end, the two black areas thus reaching within less than 25 mm. of each other, much after the pattern of coloration in *O. callotis*. In another example, a mounted head in Mr. White's collection, also from Laikipia, the eye stripe passes down to join the black throat stripe. This head, as well as another head skin, accompanied by the skull, presented to the Museum by Mr. White, agrees with the type skin in the general peculiar color.

*Skull and teeth.*—Skull as in *O. beisa*, but with much larger teeth; molars nearly as broad as long; lacrymal vacuities greater.

From a Taveta specimen of *O. callotis* the skull of this new species differs in many particulars. It is smaller and much narrower in front of orbits. Ends of premaxillæ square, very different from the tapering, pointed ends in *callotis*. Median palatal notch shallow, not reaching to plane of last molars. Upper tooth row much shorter, about equaling the length of last five teeth of *callotis*; molars about as broad as long. Lacrymal capsules much less inflated. Audital bullæ small and flattened; alisphenoids smaller.

*Measurements.*—The skull of an adult male (No. 155413) from the type locality measures: Condylbasal length, 356 millimeters; greatest breadth, 152; muzzle to orbit, 219; least interorbital breadth, 103; length of nasals, 142; upper tooth row, 105; length of horn, 685; spread at points, 210.

*Remarks.*—This new oryx apparently needs no special comparison with *O. b. gallarum*. From *O. callotis* it differs in its lack of ear tufts and the position of the parting of the hair on the back. These and other general characters place it in the *beisa* group. The skull differs so greatly from a skull of *O. callotis* that it would cer-

tainly seem that Lydekker<sup>1</sup> was in error when he considered *callotis* a subspecies of *beisa*.

This antelope was first seen soon after leaving Laikipia Boma. It was generally distributed over the Laikipia Plateau and was fairly abundant. Reported as especially plentiful about forty or fifty miles north of Mount Kenia.

#### TRAGELAPHUS DAMA Neumann

Complete skin of old buck. The tag was lost from this specimen, but it was almost surely killed on the upper Nzoia River. It agrees well with the description of *T. dama*, differing only in the lack of numerous white spots along the sides of the body. As it is well known that the white body spots on bushbucks tend to disappear in males with old age, this specimen can well be called *dama*. This skin has four faint body spots on each side, formed by only a few white hairs each, and a yellowish-white streak in front of each eye. These are about the only characters to distinguish it from the descriptions of *Tragelaphus sylvaticus meruensis* Lönnberg and *Tragelaphus tjaderi* Allen, between which I can find no appreciable difference. It would hardly seem that both of these latter forms are entitled to recognition.

Mr. White tells that the Kikuyu natives explain the presence of the peculiar short-haired collar in this group of bushbucks by a story to the effect that the Great Spirit ties the animals up each night.

#### BOOCERUS EURYCERUS ISAACI Thomas

The collection contains two skins of the rare East African bongo. They were purchased from natives at Nairobi, and were supposedly killed in the vicinity of the Mau Escarpment. The skins differ greatly in color and are both quite unlike a mounted bongo in the Museum, also from East Africa.

No. 155435, skin of body, is of a bright, glossy hazel color, shading to dark chestnut and black on the shoulders and chest; a faint black dorsal stripe from withers to rump; twelve white vertical stripes on each side, all but one pair practically meeting on the dorsum; white spots on legs very large. A mounted head in Mr. White's private collection, presumably from this same individual, and which I have had the pleasure of examining, has the face and muzzle all around, from level of the eyes to near the lips and chin,

<sup>1</sup>The Game Animals of Africa, p. 285, 1908.

blackish; forehead dark chestnut red; lips and chin white; eyes encircled with tawny; a broad white face stripe and the two white spots under the eyes greatly enlarged, the upper one twice as long as wide; throat blackish to within eight inches of the white crescent on the lower neck.

No. 155434, complete skin, is of a glossy chestnut bay; neck, chest, and lower sides black; a distinct black dorsal stripe from neck to rump, the hair forming a short, stiff mane to middle of back; eleven white stripes on right side, thirteen on left; face blackish; upper forehead dark chestnut; a broad, dark fawn stripe from eye to end of white streak across face; face streak greatly reduced and divided in center by a blackish chestnut stripe; cheek spots large and irregular in shape.

The mounted specimen in the Museum is of about the same general color tone as No. 155435, from which it differs in lack of blackish on the shoulders, neck, and chest, the body being entirely of the bright, glossy hazel color. This specimen has thirteen vertical stripes.

Thus we have three specimens of the bongo, all from British East Africa, and all differing widely from one another. Not knowing the exact locality in which each was killed, it is useless to speculate on the meaning of these great differences. It is hard to believe that the great variation between the pure hazel-colored specimen and the one with the maximum amount of black is explained by individual variation in the same forest.

#### **TAUROTRAGUS ORYX PATTERSONIANUS** Lydekker

Skin of adult male from the Guas Ngishu Plateau, May 17.

Eland, which were greatly reduced in numbers in parts of British East Africa some years ago by the rinderpest, are slowly gaining in numbers. Several herds of from forty to sixty head were seen on the Guas Ngishu Plateau, and one herd of sixty or more animals was found in the Laikipia country.

#### **EQUUS BURCHELLI GRANTI** de Winton

Skin from the Guas Ngishu Plateau, about June 15.

Zebras were found in abundance both on the Guas Ngishu and Laikipia plateaus.



**FELIS LEO SABAKIENSIS** Lönnberg

Body skin and two skulls of adult males from the vicinity of Nairobi. These skulls differ greatly from Abyssinian specimens, and agree in general characters with specimens from the east coast. They differ from skulls of *massaicus* in all the minor particulars mentioned by Dr. Lönnberg, and represent his recently described race. A number of skins in Mr. White's possession vary considerably in color, and the older males show much reddish brown and black in the body color and mane, some being rather dark animals on the whole. The skins of females and young males show faint spotting below.

Measurements of the skulls:

	155442 <i>mm.</i>	155443 <i>mm.</i>
Greatest length .....	365	373
Zygomatic breadth .....	241	234
Length of nasals.....	122	118
Interorbital breadth .....	70	70
Alveolar diameter upper canine.....	27.5	26
Length of upper premolar row.....	77	79.5
Length of upper carnassial.....	38	39
Length of lower molar-premolar series.....	74	77
Length of lower carnassial.....	28.5	29

**ERYTHROCEBUS WHITEI**, new species

## PLATE 2, SKULL

*Type*.—Skin and skull of adult male, Cat. No. 155340, U. S. N. M., collected on the Nzoia River, Guas Ngishu Plateau, British East Africa, September 30, 1908, by John Jay White.

*Diagnostic characters*.—Size large; hair of forward part of body long and shaggy, 175 mm. long at shoulders; back and shoulders grizzly cinnamon-rufous; black stripe from nose over eye and backward, forking to crown and ear; crown, rump, and dorsal stripe from middle of back to past root of tail dark, glossy bay; reddish of back extending down hind legs slightly more than half way to knee; fore arm creamy white.

*Color of type*.—Nose, lips, and cheek beard cream; a black stripe from nose between eyes, turning outward over eyes, back from corner of eye, and forking to crown and ear; crown patch dark chestnut bay; spot in front of ear, nape, and back grizzled cinnamon-rufous; the long hairs of back cinnamon-rufous at roots, shading to bright bay on terminal half, with sub-apical band of buff and tip

of glossy black; shoulders with much more black, giving them a general grizzly appearance, the individual hairs with an extra ring of black. Lower neck and arm-pits white; arms below elbow and hands dirty creamy white. A dark stripe, from middle of back to tip of tail, cinnamon-rufous, richest and darkest on rump and root of tail, where it is pure glossy bay, and shading to pale ochraceous at tip of tail. Rump to callosities and down outer sides of legs slightly more than half way to knees glossy bay; outsides of legs and feet cream; inner sides of legs white; under side of tail cream. Long hair of sides pale cinnamon-rufous, with less black than above; belly thinly haired, the hairs ochraceous to ochraceous-buff with white tips.

*Measurements of type*.—Length of skin from nose to root of tail, 870 millimeters; length of tail (dry skin), 640. Skull: Greatest length, 149; condylobasal length, 120; zygomatic breadth, 99; length of nasals, 22.5; maxillary tooth row, exclusive of canines, 32.

*Erythrocebus whitei* seems to be a very different animal from any of the previously described species. It differs from the plate of the type specimen of *E. pyrrhonotus*<sup>1</sup> in its grizzled back and shoulders, black lines over eye to ears and crown, dark bay frontal patch, and restricted markings on legs. From *E. formosus* it differs in the black brow line extending between eye and ear; hair of lower rump and back not yellow tipped, but black tipped, giving the whole back a very different color—cinnamon-rufous mixed with black, instead of yellowish; sides of neck and chest and outer sides of arms not lemon yellow. From *E. baumstarki* it may be distinguished by the general body color, dark grizzled cinnamon-rufous, instead of pale light red; distinct black forehead band and no white between eye and ear, and many other characters.

Several small groups of these red monkeys were seen on the Guas Ngishu Plateau, in the neighborhood of the Nzoia River. Two specimens were killed by the party; both single males shot from low trees. As usually seen, they were in parties of three or four to a dozen animals, traveling on the ground in open country, and were very hard to approach.

---

<sup>1</sup> Geoffroy-St. Hilaire and Cuvier, *Histoire Naturelle des Mammifères*, Tome 7, 1842.

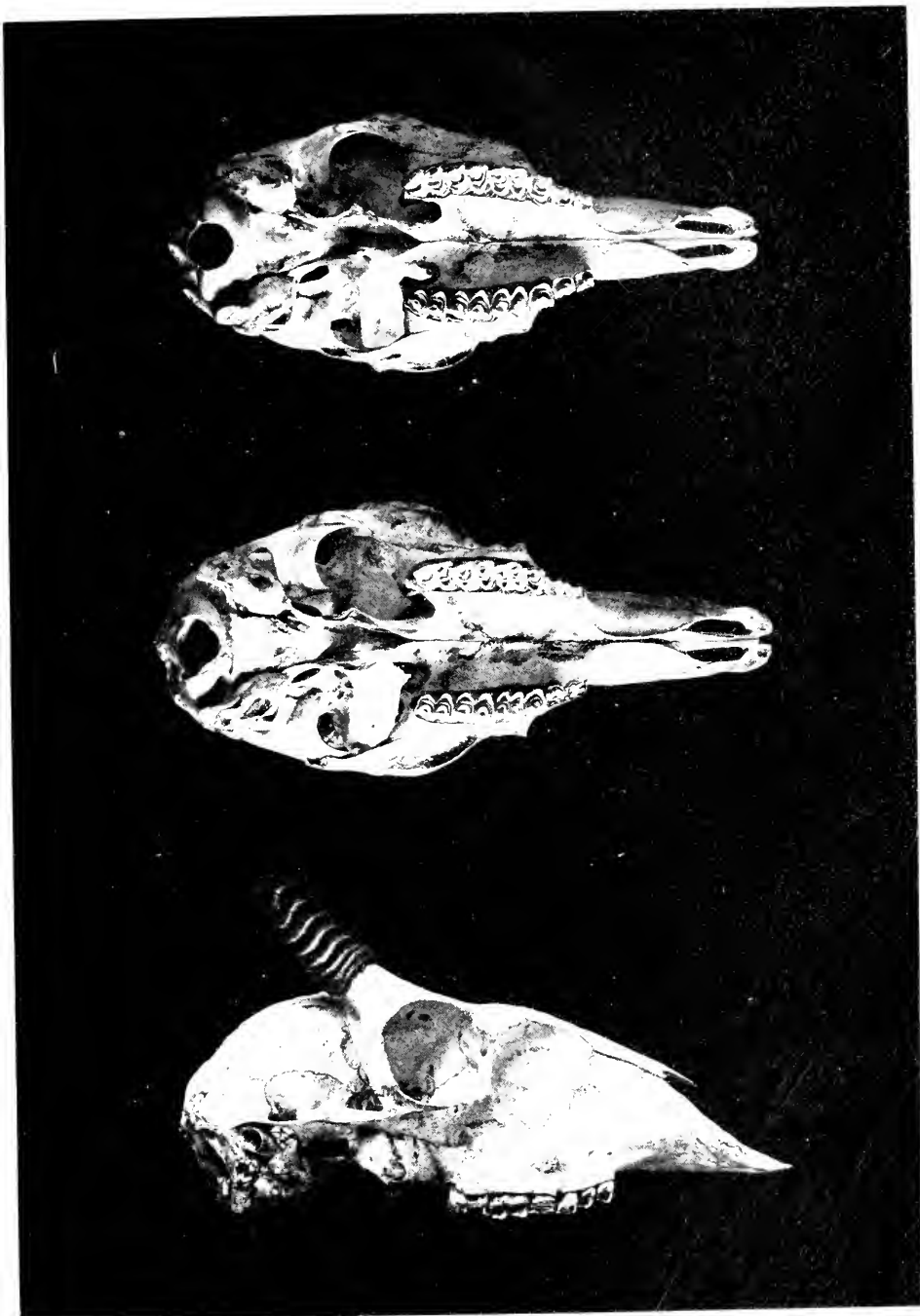

1. OUREBIA COTTONI Thomas

2, 3. OUREBIA MICRODON, NEW SPECIES. TYPE

Reduced about one half



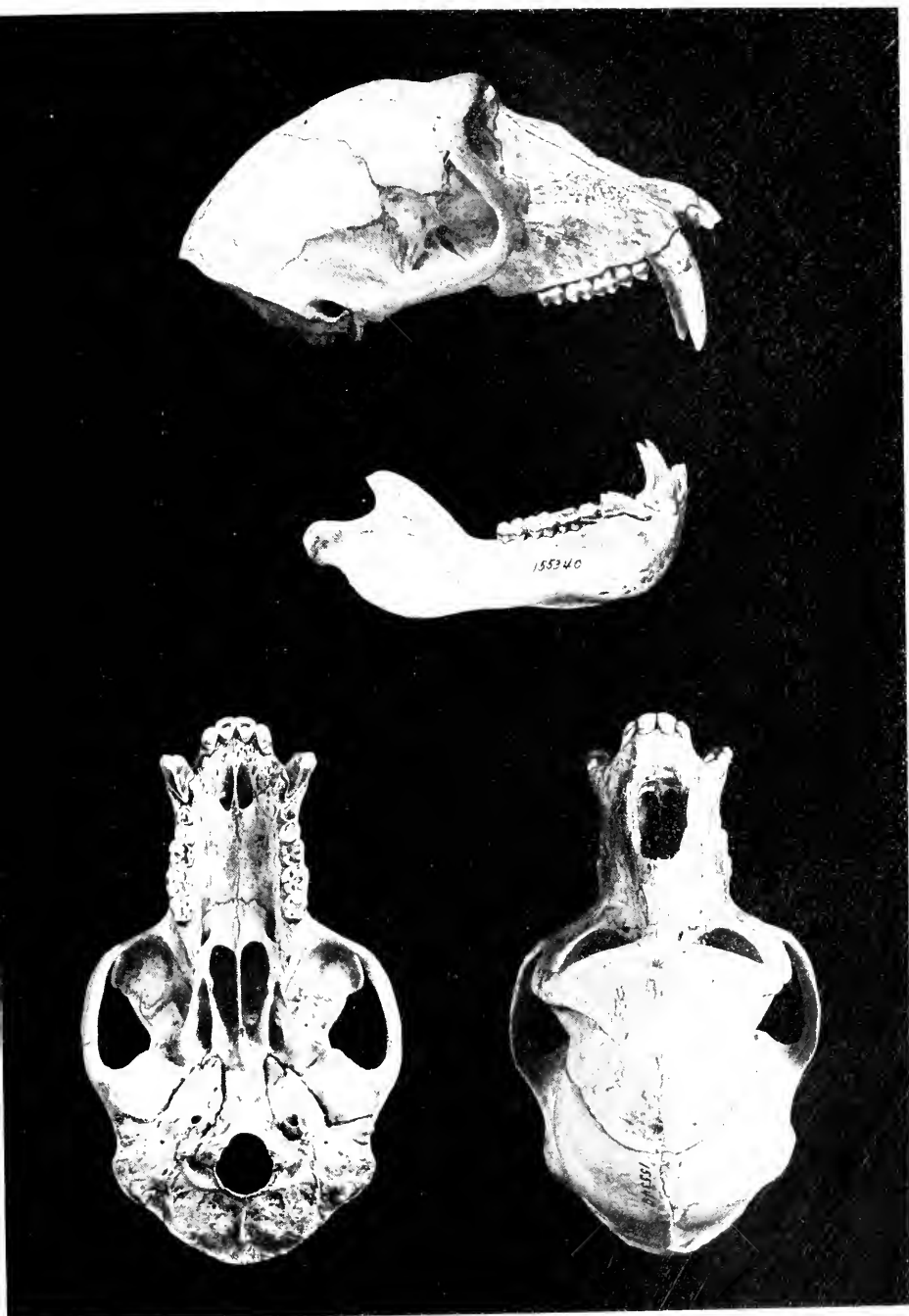

ERYTHROCEBUS WHITEI, NEW SPECIES. TYPE

Reduced about one-half









SMITHSONIAN MISCELLANEOUS COLLECTIONS

VOLUME 56, NUMBER 3

# THE SCALES OF THE MORMYRID FISHES

WITH

## REMARKS ON ALBULA AND ELOPS

BY

T. D. A. COCKERELL

University of Colorado, Boulder, Colo.



(PUBLICATION 1931)

CITY OF WASHINGTON

PUBLISHED BY THE SMITHSONIAN INSTITUTION

May 7, 1910

WASHINGTON, D. C.  
PRESS OF JUDD & DETWEILER, INC.  
1910

THE SCALES OF THE MORMYRID FISHES, WITH  
REMARKS ON ALBULA AND ELOPS

BY T. D. A. COCKERELL

UNIVERSITY OF COLORADO, BOULDER, COLO.

The Mormyridæ constitute a remarkable family of Malacopterygian fishes confined to Africa. The brain is of unusual size and the shape of the head is peculiar, in some forms being produced into a long snout, reminding one of an ant-eater. The Nile system is rich in these fishes, having no fewer than seven genera, as follows: *Mormyrops* (one species), *Petrocephalus* (4), *Marcusenius* (4), *Gnathonemus* (5), *Mormyrus* (4), *Hyperopisus* (one), and *Gymnarchus* (one). The last, *Gymnarchus niloticus*, constitutes a distinct subfamily, having many peculiar characters, in consequence of which Günther treated it as a distinct family, Gymnarchidæ. In Gill's arrangement, published in 1872, the Mormyridæ and Gymnarchidæ constitute the Scyphophori of Cope, and are thought to be nearest related to the Gymnionoti (Gymnotidæ). It is now known, however, that the Gymnotids are really allies of the Characinidæ, and consequently little allied to the Mormyrids. According to Boulenger, the Mormyridæ appear to be nearest to the Albulidæ, but it is recognized that the relationship is not at all close. Thanks to the kindness of Doctor Boulenger and the government of Egypt, I have received specimens of five genera of Mormyridæ proper and scales of *Gymnarchus*. These fishes all have scales of the same general type; cycloid with well-developed circuli and with strong basal radii. The truly remarkable feature is found in the apical radii, which are greatly modified and join irregularly, forming a network, as is well shown in the accompanying drawing by Miss Evelyn V. Moore (figure 1). The apex of the scale is usually broad and blunt, or even subtruncate, while the base is more pointed and narrower.

The following key separates the scales examined:

- Scale elongate, much longer than broad..... 1
- Scale not thus elongate..... 2
- 1. Scales near lateral line 7-7.5 mm. long, about 3.5 broad. Yellowish, sub-opaque, with the circuli extremely fine; reticulation of radii extending down sides, the spaces often diamond-shaped; scales of dorsal region much smaller..... *Gymnarchus niloticus*

- Scales near lateral line about 3 mm. long, 1.66 broad, white, translucent, the circuli not so fine; nuclear area more central (River Nile at Assuan) ..... *Mormyrus kannume*
2. Scales oblong, longer than broad..... 3  
Scales about as broad as long, obtusely subtriangular, about 2.5 mm. diameter, white; sculpture as shown in figure (Lahûn, Fayoum)...  
*Petrocephalus bane*
- Scales broader than long, very small, breadth 1.25-1.33 mm.; reticulation variable, but reduced (near Luxor)..... *Marcusenius isidori*
3. Scales larger, about 2 mm. long or a little over; about 12 basal radii; apical reticulation well developed (Fashoda).... *Gnathonemus cyprinoides*
- Scales smaller, about 1.33 mm. long; about 7 basal radii (near Luxor)..  
*Hyperopisus bebe*

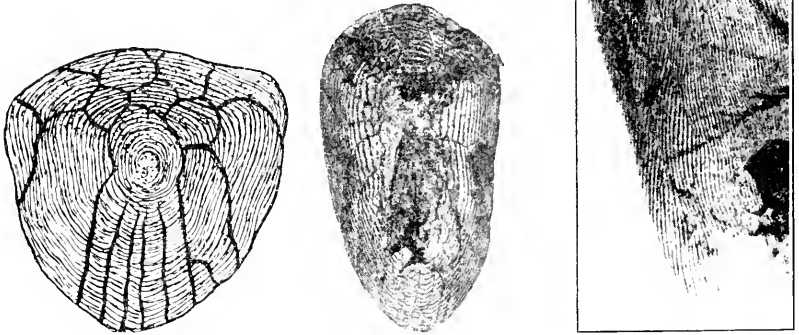

FIG. 1.—*Petrocephalus bane* (Lacep). Lahûn, Fayoum.

FIG. 2.—Scale of *Mormyrus kannume*. Forsk.

FIG. 3.—*Amia calva*. Plymouth, Indiana. Part of base of scale, showing longitudinal fibers which apparently correspond to the circuli of other fishes.

Thus it is seen that, although there are good specific characters, the scales are in general of the same type, and are, so far as I know, very distinct from those of any other fishes. *Gymnarchus*, according to the scales, goes with the Mormyridæ.

In view of the suggested relationship with the Albulidæ, I was anxious to see scales of that family. Doctor Evermann has very kindly sent me scales of *Albula vulpes*, from Woods Hole, Mass. The scales come from just above the lateral line, under front of dorsal. It may be said at once that they show no resemblance to the Mormyrid scales whatever. They are large (about 15 mm. long and 13-14 broad), quadrate in form, opaque, yellowish, with three (rarely four) nearly parallel basal radii, which hardly extend to the middle of the scale, and which reach the margin at the ends of incisions, the base of the scale being coarsely scalloped with four

(rarely five) lobes. The circuli are extremely fine, and are mainly longitudinal, breaking into a roughened area apically, the whole structure of the circuli being extraordinarily like that of *Amia calva*. This is a matter of interest in connection with the known great antiquity of the Albulidæ.

Another ancient family, placed next to the Albulidæ in the system, is the Elopidae. Doctor Evermann kindly sends me scales of *Elops saurus* from Jamaica. They are also subquadrate, about 6 mm. diameter, with fine circuli which are complete basally, and here *transverse*, as in ordinary fishes, whereas *Albula* shows in this region *longitudinal* strands consisting of minute segments.<sup>1</sup> The basal structure of *Elops* is evidently more "advanced" than that of *Albula*—much more like that of Teleosts in general; that of *Albula* (except for the radii and the scalloping) differs little from *Amia calva*. *Elops saurus* has a variable number (about 12 to 22) of strong basal radii, which really do radiate from the central nuclear area of the scale, though failing centrally. The apical region of the *Elops* scale is very thin, and shows numerous parallel radii.

#### *Supplementary Note on the Scales of Hiodon.*

Since writing the above paper I have received through the kindness of Dr. S. Graenicher scales of *Hiodon tergisus*, from the St. Croix River, Polk County, Wisconsin. In Boulenger's arrangement the Hiodontidæ, which are exclusively North American, follow the Mormyridæ. The scales are large (about 12 mm. long and broad), with the nuclear area between 4 and 5 mm. from the apex. The circuli are excessively fine and numerous, the same all around, and of course transverse in the basal region. Rather numerous apical radii are indicated by obscure broken lines, easily overlooked. The basal radii are very distinct, irregularly placed, a group of seven or eight closely adjacent ones going to each sublateral concavity of the basal margin. The basal margin is not crenulate, and the basolateral angles are distinct.

This is wholly diverse from *Albula*, very distinct from the Mormyridæ, but not far from *Elops*. The silvery skin and minute pigment spots are quite as in *Elops*. *Elops* differs by the modification of the apical circuli, which in the subapical field become coarse, wavy, and transverse, actually at right angles to the lateral ones.

---

<sup>1</sup> Compare Tims on scales of *Gadus*; Quart. Journ. Micros. Science, Oct., 1905, pl. vi. See also the structure of apical radii in the Serranids *Apsilus* and *Aprion*, as figured by Sauvage in his work on the fishes of Madagascar.

The basal radii of *Hlops* are also much more regularly spaced, and the laterobasal angles are rounded.

According to the scales, the four families considered are related thus:

- |              |                |
|--------------|----------------|
| A. Albulidæ. |                |
| B. . . . .   | {              |
|              | a. Mormyridæ.  |
|              | b. . . . .     |
|              | 1. Elopidae.   |
|              | 2. Hiodontidæ. |

A remarkable thing about the scales of *Hiodon* is their close resemblance to those of certain old world Cyprinidæ. Comparison may be made, for instance, with *Cyprinus carpio*. The resemblance is such that, if the scales had come to me nameless, I should certainly have guessed them to be Cyprinoid. The Hiodontidæ cannot be directly related to the Cyprinidæ, but I believe that they may stand close to the ancestors of the Characinidæ. I do not know a Characinid scale similar to *Hiodon*, but, of all the South American Characinids, I know scales of only two genera.







SMITHSONIAN MISCELLANEOUS COLLECTIONS

VOLUME 56, NUMBER 4

UPPER YUKON NATIVE CUSTOMS AND  
FOLK-LORE

BY

FERDINAND SCHMITTER

Captain, Medical Corps, U. S. Army



(PUBLICATION 1933)

CITY OF WASHINGTON  
PUBLISHED BY THE SMITHSONIAN INSTITUTION  
May, 1910

WASHINGTON, D. C.  
PRESS OF JUDD & DETWEILER, INC.  
1910

## UPPER YUKON NATIVE CUSTOMS AND FOLK-LORE

BY FERDINAND SCHMITTER,  
CAPTAIN, MEDICAL CORPS, U. S. ARMY

The Indians at Fort Egbert, Alaska, where I was stationed in 1906, are considerably modified by contact with white men, although many old customs remain as they were before the influences of civilization were felt.

An Eagle Indian village of about 200 inhabitants, 3 miles above the post on the south bank of the Yukon River, proved of particular interest in my research and observations of native customs and folk-lore. These Indians are classified as the Vuntakutchin people of the Athapascan family.

My first inquiry was for a medicine-man, but I was informed that there was none now in the vicinity, all of them having died or left long ago. They were very reserved on this subject and it was two years before I won their confidence, which I at last gained by treating their sick and showing sincere interest in their customs and mythology. One day I was told that a certain Indian named Luke was a good medicine-man. Accordingly, securing the services of the Indian Arthur as an interpreter, we visited Luke, who sheepishly admitted that he had been a medicine-man, but had given it up because the missionaries and police opposed the practice. After a brief conversation Luke became enthusiastic and boasted of his ability, making demonstrations which I will describe later. From medicine the conversation soon ran into folk-lore, with which he was intimately conversant. Arthur was of great service to me here, and later furnished most of the folk-lore which he secured from his father Simon and from the old folks of the village.

Many of my notes in the present paper are left in their more or less crude form, so as to illustrate the native way of thinking; for, since they are intended as records of a people, they should remain as nearly intact as possible. In reading the stories one must not be annoyed by inconsistencies, for they are characteristic of the people. Their "because" clauses, for example, are about as satisfactory as those of a child. It will also be noted that most of their stories begin, "Long time ago, when all animals were men," fol-

lowed with an account of certain animals which were evidently not men. For instance, when the bear goes out to hunt bear his daughter puts on a bear-skin to deceive the hunter. Such oddities will be understood when it is realized that they are traditional or folk-lore.

#### PSYCHOLOGY OF THE NATIVE

In order to properly appreciate native customs and stories one must be acquainted with the phases of their mental life, in which they are decidedly oriental. They are fond of mystery and mysticism. They have no idea of logic, but readily accept analogy and suggestion as proof of what they wish to believe, and in making inquiries one has to be careful not to ask leading questions, for they will answer in a way most convenient, with utter disregard of actual facts.

Combined with their child-like simplicity is a cunning secretiveness, prompting them to withhold information of any value, as, for instance, if one asks a native how to tan a bear-skin or where to hunt moose, his comprehension is apparently dulled by an assumed oriental ignorance, and in this state he imparts little information.

Shyness is the chief characteristic of the females, resembling the form of insanity known as negativism, but it seems to disappear promptly after marriage. The women hide at the approach of a stranger, and, when spoken to, conceal their faces, seldom answering a question, though they understand English well.

The native believes in a rather concrete existence of dream life, and he sees spirits as if they were real creatures. Only the medicine-man has access to this dream life, and he alone can transfer animals from real to dream life and vice versa. One might assume from the tricks of the medicine man that he is an impostor, but he is really sincere and believes in himself, although he has the faculty of believing what he must know "isn't so"—the same faculty that we find among hysterics and adherents of various psychic cults.

#### ANNUAL MOVEMENTS

During the winter season they move about wherever game is plentiful. The men go to a place, cache their packs, and then proceed to hunt. The next day the women come, pitch the camp, and prepare to cook. In the spring they go to the river bank, where they make canoes and nets in preparation for salmon fishing, and during the summer dry and cache large quantities of fish. In the early fall the entire family goes hunting and when a good supply of game is accumulated

they cache it on the spot. In October they return to the river for about two months, when they make snow-shoes, toboggans, and other things for winter use. About the middle of January they have a big time—"all same Christmas"—when they get out all their cached meat and bring it to the river. They stay there till the meat is nearly gone, and again go in search of game until the middle of March, when the weather moderates, at which time they return to the river banks.

The native dog proves a most useful domestic animal during their migratory movements. Each man owns a team of about five dogs, employed in winter for pulling toboggans and sleds over the trails and in the summer for hauling boats up the river banks. For inland travel, when there is no snow, packs are tied over the dogs' backs. Dogs are also used in hunting expeditions, as will be described later. There is no affection between dog and master. The animal is simply a beast of burden, never caressed, but thrashed unmercifully to secure obedience. They are wolfish and snap viciously at any attempt to caress; in fact, they are generally three-fourths to seven-eighths wolf and always gaunt, being given very little food and left to pick their own living. They live outdoors, even in the coldest weather. With the thermometer 60 degrees below zero, I have seen them sleeping comfortably curled up in the snow, protected by their woolly hair, their heads hidden under their bushy tails.

#### HABITATIONS

These Indians formerly had no permanent dwellings, but lived in tents of caribou skin covering a wicker framework. There was a fire in the center of the tent, and the smoke escaped through a hole in the roof around the tent-pole. When they moved they took the skins with them, but left the frames, which are sometimes seen still standing where Indians have not been for many years. They are spoken of by prospectors as an "Indian sign."

Most of these people now live in roughly built cabins, usually with only one room, that serves for all purposes. The cabin is built of logs, the chinks packed with moss. The roof is of saplings laid side by side and covered with turf. The floor is laid directly on the ground. There is usually but one window, and this cannot be opened. The only ventilation is therefore from door to stove-pipe. A small iron stove, that requires much attention, serves for heating and cooking. A low home-made bunk in the corner or a mass of dirty rags on the floor usually comprises the sleeping quarters.

Sometimes they have a rickety chair or two, but they seem to prefer to sit on the floor. Enamel ware and tin dishes constitute their dining outfit.

#### DRESS

The original native upper garment was the caribou-pelt "parka," a combination of hood and coat reaching to the knees and without buttons or laces. It was pulled on over the head like a shirt, the hood generally hanging down the back and covering the head only in severe weather. Sometimes sealskin "parkas" were secured in trade from the lower river natives. As far back as any of the present inhabitants can remember, they have worn shirts made of calico which they say traders brought from New York.

With the "parka" they wore a lower garment like the original pantaloons, a combination of trousers and stockings made of moose-skin from which the hair had been scraped.

Moccasins were of moose-skin, with caribou-skin strings to lace and tie them on, and they were of generous size, so that grass or other soft material could be placed in the soles to protect the feet. The moccasins usually reached several inches above the ankle, although low slipper-like moccasins were also worn in camp.

Large moose-skin mittens were made with gauntlet-like wrists, and these are now used and prized by the whites as an article of comfort.

Most of the clothing now worn is that cast off by the white people. Although the skin parka and breeches are still frequently seen, they have been mostly replaced by canvas parkas and other white-man's clothing. The natives, however, do not like shoes. Their moose-skin moccasins are continually wet in damp weather, causing constant headache, and they do not understand that the condition of the feet has anything to do with that of the head.

They wear no head covering in summer, but marten or rabbit skin caps are worn in winter. The old method of hair dressing was to allow the hair to grow long and tie it in a bunch behind with a small bunch over each temple. Swan feathers were chopped fine and applied with grease to the rear bunch daily until it became a large mass. Another custom was to pierce the nasal septum and through it insert rings of small bones from birds. These ornaments were worn especially at dances or other ceremonies, and most of the adult natives still have these holes in their noses.

Porecupine quills, which are used for decorating their clothing were dyed red by boiling in cranberry juice, or blue by boiling in

huckleberry juice. When any quills were found which were pure white, they were left so. Various colored flowers were also boiled and their coloring matter used in dyeing the quills. Small geometrical figures were made by sewing the flattened-out quills to a backing of skin, and long stripes were made by rolling the quills into spirals about a sixteenth of an inch in diameter and sewing them side by side. The backs of mittens and insteps of the moccasins were decorated with these quills. Flat strings of caribou-skin one-fourth of an inch wide were sometimes wound with porcupine quills. These strings were either sewed to, or tied about the coat wrists and about the breeches below the knees. The coat of a chief was decorated down the front and back, and had a special collar, significant of his office, which consisted of a strip of moose-skin about two inches wide and nearly a yard long with one margin fringed by cutting it into strips. On this was sewed strands, and strings of quills were suspended from the ends. The collar hung around the neck and down the front like a scarf. A special hunting belt was made of caribou-skin decorated with porcupine quills, and from it hung an ornamented moose-skin sheath containing a hunting knife.

Moose-skin is prepared for clothing by the women. After soaking the skin in water to soften it, the hair is scraped off with the end of a sharp bone spatula. As in primitive times, all sewing is still done with bone awls, bones from the fore leg of the caribou or moose being used for coarse work, and for fine work a bone from the fore leg of the lynx or of a bird is used.

The women do bead-work, which they sell to the local stores. These articles and other curios are sold to travelers. Moose-skin mittens are made for local use and are much in demand, as most white people hereabout wear them in winter.

#### HYGIENIC CONDITIONS

*Early Habits.*—The Indians say that they had very little sickness before the advent of the whites, and George Matlock, who came to Alaska in 1885, and other old prospectors, confirm this statement. Smallpox and diphtheria struck them in epidemics, but they either died or soon recovered. As military hygiene teaches us, a moving command is a healthy command, and, as the Indians were formerly rovers, camping only for short periods, their wandering necessitated the abandonment of much infected material and localities, thus preserving their health. The survival of the fittest was also a factor

in preserving health, as illustrated by the following incident. A few years ago some government packers were traveling from Fort Egbert to Tanana Crossing, and on their way they passed a camp which the Indians had just deserted, leaving behind a sick old woman and a crying baby, but no attention was paid to them, as it was supposed the Indians would return to get the woman and child. The packers on their return trip a few weeks later found the old woman and child dead, evidently left by the Indians to starve.

*Present Habits.*—A great change has taken place and conditions could scarcely be worse than they are now. They never wash more than their face and hands, and are consequently exceedingly filthy. Pediculosis and tuberculosis are ever-present indications of their unclean habits. Their cabins are as offensive as their persons. They have no methods of sanitation.

Tuberculosis far outweighs all other ailments. On entering the village one notices everywhere evidence of tuberculosis in the forms of humpbacks, hip disease, scrofula, and consumptive cough. Very few natives can be given a complete physical examination without disclosing some evidence of tuberculosis. Tonsillitis, respiratory disease, digestive troubles, and myalgia are ever present. Diphtheria, according to hearsay, kills off many in occasional epidemics, but there have been no epidemics this year. Heretofore the natives have been in the habit of obtaining medicine free at the hospital, but it has been found expedient to charge a small fee for prescriptions.

These natives are very undesirable patients; they all like to take medicine, but object to physical examinations. They strongly object to surgery and will permit it only under the most urgent circumstances. The relatives of a boy with hip disease were advised to submit him for operation, but to this their only response was, "No cut; make well quick." They will quite readily accept any magic methods, but modern surgery does not appeal to them.

#### FOOD

The native diet consists chiefly of fish, game, and berries. During July they catch king salmon, which they dry and keep for winter. At all seasons they hunt caribou, moose, bear, and mountain sheep. During the fall, when the caribou run in herds, the natives cache the meat for the cold weather. The other animals are scarcer, and when one is brought in it makes a treat for the village. It is customary, when one native is surfeited with meat, to give what is left



to his neighbor. Ducks are also shot during the fall and spring and make a variety in diet. This meat diet is supplemented by the usual white man's vegetables bought at the local stores. Their nearest approach to vegetable food, is the tuber attached to the root of a pennate-leaved weed that grows on the hillside in the shade of spruce trees in the midst of moss, through which the root extends a few inches, the tuber itself growing in the ground beneath the moss. It is six to nine inches long and from one-half to three-fourths of an inch thick, with fiber strands running through it. It has a slightly sweetish but indifferent taste. The natives originally ate it only when they could get no meat, though they say that it is quite palatable when boiled with grease.

Huckleberries and cranberries grow in abundance on the mountain sides and are gathered in large quantities. "Hootchinoo," the native alcoholic drink, is made from huckleberries, by allowing them to ferment. Raspberries, strawberries, salmon-berries, and currants are also found in favorable localities.

The Indians never eat dog meat or wolf meat; they would rather starve. Neither do they eat ravens, hawks, or eagles. They seldom eat wolverene, though they eat lynx and one kind of owl.

These people have lately learned luxury to the extent that they think they are destitute when they have only animal food to eat, whereas, I am told, they never had anything but animal food ten years ago. A contrast to this particular tribe is found when the Mackenzie River natives visit here. These live almost entirely on a meat diet, and are a robust, healthy people.

#### FISHING AND HUNTING

In July the salmon begin to run up the river, first the king salmon and later the dog salmon. The Indians prefer the latter, for they say the king salmon are too oily. To catch salmon they generally use hand-nets which are let down to the bottom of the river in rather deep places. When the fisherman feels a pull he draws in the net, although sometimes the salmon pulls the Indian into the water. This method, however, is gradually being replaced by fish-wheels. The salmon are brought to the shore where the women, squatting at the water's edge, dress and wash them in the flowing current, split them lengthwise, make transverse cuts about an inch apart through the meat, and put them on pole-racks to dry in the sun until ready for caching.

White-fish is occasionally caught in the nets, and is even preferred

to salmon, which is the staple fish food. Greyling, a kind of trout, is also caught in the mountain streams, and is prized as a delicacy.

The caribou, or Alaskan reindeer, is the staple winter food. During the fall, when a run of caribou is expected, two long rail fences are built converging into a corral. Snares are placed in the fence about fifty yards apart and also thickly interspersed in the corral space where the herd is driven. The Indians line up at the entrance and shoot with their arrows those that try to escape. Some are caught in the fence snares, but most are captured in the corral. The snare consists of a loop of strong braided moose-skin rope, the end tied to a loose log, the loop being held in place by small strings of caribou-skin that break easily. It is set in a natural opening through which it is presumed the animal will try to pass. As the caribou jumps through the loop the strings break, the loop tightens, and, thus caught, he tries to run, dragging the loose log after him, which soon exhausts him. If tied to something firm the rope breaks too readily; hence a loose log is preferred.

Moose are usually stalked and shot with bow and arrow, aim being taken behind the shoulder; but sometimes the dogs get a moose at bay and the Indians attack him with pikes. In the springtime the moose can be caught with snares set in a creek, the dogs chasing him down the creek into a snare. The Indians say that a moose once shot with an arrow never escapes, as they sometimes do after being shot with a gun, for, though they may run for some time, they will finally succumb and be caught.

A pike or spear is nearly always used in hunting bears. The hunter attracts the bear by making a raven-like noise, causing the bear, as the Indians say, to think the raven has discovered a dead moose. They also further explain that the big bears only would come, as the little bears would not know what the croaking meant. As the bear approaches the Indian holds the spear in position, facing the bear as it draws nearer to him, and as the bear springs the Indian sticks the spear into its throat at the top of the breast-bone, at the same time shoving the handle of the pole into the ground, thus causing the bear to spear himself with his own weight. Sometimes three men hunt in this manner, two of them attacking the bear on either side as it rushes forward. The meat of the young bear killed in the fall, when they feed on huckleberries, is considered a great luxury.

Grouse, ptarmigan, ducks, rabbits, owls, hawks, and other small game are killed with a dull, round-pointed arrow, sharp-pointed arrows being used only for big game.

The eagle cannot be shot with an arrow, but is snared. For this purpose a small fence having a snare at one side is built on a mountain peak and baited with a caribou lung. The Indians say that the eagle is very wary and will not go in at the top of the snare, but usually alights near it and inspects it carefully before entering, which he eventually does and is caught.

#### COOKING

Baskets for cooking are made of spruce roots, and, though they leak when new, they soon shrink and the crevices become filled with grease. Each Indian woman keeps near at hand during the winter a stone which is used in cooking, as follows: First it is heated in the fire, and when it is red hot the ashes are brushed off and the stone dropped into a basket of water, making it boil in about a minute. These stones are hard to procure in the winter and are guarded most carefully. Sometimes birch-bark baskets are used, but, since they break easily, are of little service except for cooking and drinking utensils on a hunting trip. The spruce basket is preferred, since it is collapsible and can be rolled into a small package.

Meat is roasted by suspending it on a string from a cross-bar on two supports near the fire, where it is continually twirled until roasted. Salmon is cooked a little differently. Usually it is hung at rest with the flat inner surface toward the fire. Rabbits, ptarmigan, moose-foot, and other small things are roasted in a pit-oven, made by building a fire on the ground in the sand. After the fire has burned for some time it is brushed aside and a hole dug beneath it in the sand. The meat is placed in the pit, covered with hot sand or dirt, and over this the fire is rebuilt and kept burning until the roasting is finished. Ducks, geese, and swans are boiled in a large basket of water by means of the hot stone.

#### NATIVE DEVICES AND IMPLEMENTS

One method of starting a fire was by the flint and iron-pyrites method, in which a piece of flint fastened to a stick about three inches long was struck against a piece of pyrite to produce a spark. Punk to catch the spark was usually secured from a fungus growing on birch trees. The Indian word in the Porcupine language for flint was "vetrih," and pyrites "tshi tlya." Another method of fire-making was with the whirling stick. The stick was braced between the body and a piece of punk. A string was wound round the stick,

so that pulling would revolve the stick rapidly in either direction, starting a friction fire on the punk.

They still have hammers made from a rounded stone fastened to the end of a stick with a string of caribou-skin. These are used to break up bones for cooking, and to make arrow-heads. My interpreter has seen stone hammers in use, and he also says that stone axes for chopping down trees were used some time ago, although he never saw one. Hunting knives are made of bone ground flat and sharp on both edges, and they occasionally have copper knives of the same pattern, which were secured in trade from the White River Indians. One of their most useful weapons, the spear, was made by binding a hunting knife of caribou-horn to the end of a pole about 6 feet long.

Birchwood is used for making bows, arrow-shafts, frames for fish-nets, snow-shoes, toboggans, and canoes, and their woodwork is nearly always painted with red ochre, which is secured from the banks of a creek near the village of Nation, about thirty miles down the river from Eagle. They say that this creek is red from the ochre, which can be gathered in handfuls from the mud in the swampy places along the banks. In former times this pigment represented an important article of commerce, and was carried to a great distance and traded with other tribes. They used it also for painting their faces in the dances.

"Babiche" is a tough string made of walrus hide, secured in trade from the lower river Indians and used for making snow-shoes and fish-nets.

Arrow-heads are about five inches long and made of caribou-horn or bone, and bound into the split shafts with fine sinews.

The natives still build a style of canoe characteristic of the upper Yukon. It is of birch bark, fastened to a frame by lacing with the slender roots of trees. The bark is fitted over the frame, and then about a dozen squaws hold a sort of sewing-bee, as they sit along the sides of the canoe and lace the bark through holes punctured along the edges by a sharp bone awl. The cracks are filled with pitch by the supervisor to make the canoe water-tight. This is a product entirely free from the influence of civilization. White men do not use them, because they tip too easily.

## AGRICULTURE

The natives in this locality pay no attention to agriculture. There is excellent opportunity for it, but they have never been taught. About their village there is much more rich garden land than they can use. The white people grow an abundance of potatoes, carrots, turnips, cabbage, cauliflower, onions, and other vegetables. One man raises wheat, barley, and oats. In a single season a garden 100 feet square will yield five hundred dollars' worth of vegetables (according to Alaskan prices).

There are always a number of natives loafing around the village, many of whom are unable to hunt on account of age or consumption. To give them work in a garden would be an excellent hygienic measure.

## GOVERNMENT

Under their primitive form of government the chief (ha-kkih) had despotic authority. He detailed hunting parties and dictated their duties, and when game was brought into camp he assumed charge of it, apportioning it out to whom he pleased. The chief of the Moosehide Indians near Dawson shows much of the pristine dignity and authority of his rank, and whenever he buys anything in Dawson he does not carry it home, but sends an Indian after it. He shows his genteel extraction by always wearing a pair of fancy decorated gauntlets when he goes on a several days' visit to Eagle during warm weather. During the absence of a chief, or when he is incapacitated, a patriarchal form of government exists, and all important measures are decided by the old men after holding the "big talk." Public opinion is very strong and each individual has great respect for the opinion of the community concerning his personal actions.

For several years the chief of the Eagle Indians did not attend to public affairs on account of age and feebleness; hence the functions were carried on by the old men. At one time a chief from farther down the river came here and assumed to be chief, but he was never generally recognized as such and ended his career when he fled from the village and the police.

Their life is somewhat communal, each family living by itself, but in a small tribe most of the families are inter-related. They occasionally marry into other tribes and sometimes children are adopted into a family. Joseph, the chief at Ketchumstock, has two boys which, it is said, were taken from Tanana when they were

infants, and, strange to say, such kidnapping appears not to be considered a serious offence.

#### POLITICAL AND DOMESTIC ECONOMY

The native idea of money value is very unstable. In this respect they are the victims of unfortunate circumstances. I am told that in 1898, during the gold rush, many natives were hired as pilots and guides at \$10.00 per day. This gave them an exaggerated notion of the value of their labor, to which they cling tenaciously. The smallest piece of money current in any of the Alaskan stores is twenty-five cents, so the native regards a twenty-five-cent piece about the same as a laborer in the States regards a cent. An incident will illustrate: I saw a white traveler take a picture of a native family and give the paterfamilias twenty-five cents as a tip, but he superciliously tossed it to his baby, considering it too trivial a reward for himself.

The wages of a white man in this country average five dollars a day. This compensates him for labor and things incidental to working away from home. The native has a keen appreciation of his own value and will not work for any less than the white.

The lowest price usually assigned by a native to any piece of work is five dollars. I have seen one refuse to tan a small bear-hide (worth about \$4.00) for less than five dollars, although in a few days his wife was seeking destitute rations.

While these people will not come down from a set price, their failure to appreciate comparative values allows them to be cheated. The following incident will illustrate: A native had a pail of berries for which he wanted two dollars; a store-keeper offered him one dollar, which he refused. Then the store-keeper threw down three bars of soap, worth thirty cents, and offered them in trade, which offer was promptly accepted.

The natives are very improvident. They will loaf continually in the summer, gathering no firewood for winter. In cold weather they will huddle together in a poorly heated cabin, and I have known them to tear down cabins for firewood and rebuild when summer comes. When they have much dry salmon in the summer they sell it to the stores, but when winter comes and they run short they buy it back at a higher price.

## MARRIAGE

An interesting old custom was that of the arrangement of marriages during the infancy of the children. The question was settled by the parents, who met in consultation and made all the arrangements for the prospective marriage, choosing for the girl a boy usually about three years older. Between the ages of 10 and 15 the boy left home to live with the girl's parents, although they were not married until the boy was able to hunt and work. The boy became a part of his wife's family and never returned to his own.

Marriage usually took place between the ages of 16 and 20, but sometimes as late as 25 years of age. Although the agreement had been made by the parents of the intended bride and groom, yet their own desires were considered before the actual marriage took place, and they were not forced to marry unless they felt they were suited for each other.

On the death of a wife or husband it was not customary for the survivor to remarry for several years, since the relatives of the deceased might think the survivor was glad of the other's death.

## CEREMONIALS

These Indians are quite strong in tradition, and no household event is passed over without ceremonious observances that usually take the form of "banquets," given by the person immediately interested. Thus, at the birth of a child the father celebrates the event by giving a dinner to the entire tribe. A similar banquet is given when the oldest boy kills his first bit of game, thereby attaining his majority and proving himself a hunter. It is incident to the custom on this occasion for the youth to present a bird to the head man of the tribe, while his father also makes the chief a present in token of his esteem and pleasure at his son's accomplishment.

Corresponding to the feast in honor of the boy's maturity, a similar celebration is held when a girl arrives at the age of puberty. Everybody in the community is informed, and the girl's father gives a dinner in honor of the event. The girl then goes about a mile from home, where she lives in isolation for a year under the care of a relative of her fiancé. She does not eat fresh meat during this year, and if she breaks the rule it is supposed to make the game few in number and hard to get during the ensuing year. As a punishment, in case she violates this tradition, she is compelled to stay away for another year and wear a peculiarly fashioned cap in the

form of a cape which extends to her knees. This is to prevent her from seeing any men, though she may talk to them. She may raise her cap only to do sewing or other work in her tent. This custom is still in vogue, but the length of exile is usually cut down to a few months. A neighboring tribe has a custom of not allowing the girls to drink from anything but a special ceremonial drinking cup made of woven roots. This is not allowed to touch her lips; she drinks by making a gutter of the palm of her hand, through which she pours the water into her mouth.

#### FUNERAL CEREMONY

When a chief, "Ila-kkih," died, men were hired to burn his body, and what was left of bones and ashes was placed in a wooden receptacle hewn from a tree trunk and hung about ten feet high in a tree. The men who burned the body ate no fresh meat for a year, because, according to the law, if those who worked for a dead man should eat fresh meat within a year they would die. They could eat dried meat, but if there was none dried they must wait until some was made.

It is an old tradition that when persons die they go into a woman and are born again as a baby. The man is born again as a male and the woman as a female. They have no notion of transmigration into animals, believing that when an animal dies it is not born again as a man is.

Last winter the Eagle chief died. He had hoarded up much wealth of skins, blankets, traps, rifles, and other property, and, since it is not customary among the Eagle Indians for relatives to inherit the property of the deceased, his kinfolk received nothing of his belongings. By common consent Old Peter took charge of the effects. It was then announced that there would be a "pot-latch" in the spring, when the goods of the deceased man would be given away. Invitations were sent east to the Moosehide Indians up the river, west to the Charlie Creek Indians down the river, and south over the hills to the Ketchumstock Indians. The Porcupine Indians to the north were not invited, because they were not related to the tribe. All the goods were kept intact in the caches until the arrival of the guests. Then Isaac, the Moosehide chief, took full charge of the ceremonies, which lasted several days, during which there was much feasting and dancing. At the dinners, the men first gorged themselves, allowing the women to come in after they had finished and take what was left. Between the ceremonies they assembled



in groups about the village and gossiped or sung to tunes resembling those of Japanese operas. Time was kept by one of the Indians beating upon a caribou-skin drum, while everybody swayed to the time, alternately bending the right and left knee. For the final ceremony a fence about seven feet high was built about an enclosure thirty by sixty feet. The "pot-latch" proper was held in this enclosure during one afternoon, and the people sat about near the fence facing the goods of the deceased, which were displayed at one end by Chief Isaac, who stood in their midst and presided. The first hour of the ceremony was very much like a church meeting, all talking in their native language. The chief then opened with a speech, and when he sat down others rose and spoke as the spirit seemed to move them, apparently eulogizing the great chief. At times the speaker became much wrought up, his gestures showing that he was illustrating a fight with an animal. After the speech-making the goods were distributed one article at a time. The chief would pick up a blanket, walk down the center of the assembly, and with a few remarks toss it to some one, the recipient smilingly responding with brief remarks. Articles were only given to the visitors; the Eagle Indians received nothing.

After watching the ceremony several hours, I was about to leave when the chief called me and handed me a pair of moose-skin moccasins, saying, "This is because you were good to my people."

Next day the food became scarce, so the visitors began to depart for their homes, their toboggans laden with goods from the deceased chief's cache.

#### NAMES

A few of the most important Indian names have been given in the previous paragraphs under other subjects. The Eagle Indians themselves are called "kkwi dyik" in their own tongue. In the Porcupine language they are called "vun tte kwi chin," which means "the people of the Willow Creek," since they came from what is now known as Charlie Creek, where willows abound and from which the creek was named by the natives.

Individuals were given names from incidents of their infancy. Old Simon's name, "Da Hoch," meaning white blood, was chosen from the fact that he had a suppuration in one of his eyes since infancy. The Indians are generally known to the white people by Biblical names which missionaries gave to them.

## SIGNS AND SYMBOLS

The Indians do not write, but make signs of one sort or another, a few of which follow. The sign *a* drawn in the snow means a

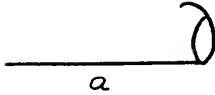

moose in the direction of the end of the line to which the head is attached. The sign *b* in the snow means caribou on the mountain in the direction of the straight line.

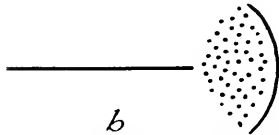

Along a trail, where it divides, if one sees a leaning pole with grass tied to the end, it means no "grub" in that direction, or a pole with willow tied to the end means plenty of "grub."

## GAMES

The Indians had an outdoor game similar to volley-ball in which several took part. A ball the size of a baseball, made of caribou-skin stuffed with hair, with a marten tail attached, was used in this game. A party of about ten Indians would take up their position on each side of a line, batting the ball with bare hands from one side over the line to the other, and every time the ball touched the ground it counted against the side on which it fell.

The boys had a game that not only furnished sport, but gave them practice in throwing the spear as well. One person would roll a hoop made of willow before a number of Indian boys standing in a row, each with a long spear-like stick, which he threw at the hoop as it rolled past him, and when one went through the hoop it counted as a caribou killed.

For an indoor game they had one which is not uncommon nowadays. In this game the men sit on the ground with their legs arched in front of them and the women sit tailor fashion, each person having a cloth similar to a handkerchief. Any small article is started down the row; the men pass it under the knees and the women pass it behind their backs, the object being to conceal the article in the cloth or stealthily pass it on without being caught. It was the duty of one to catch a person with the article in his possession. Men and women sit separate in rows opposite each other and watch the other sex play the game.

The nearest approach to gambling among the natives is an old game, the rules of which are as follows: Two rows of men sit opposite one another, each man holding in his hand a bone marked with a

notch. The bones are secretly passed from right to left and vice versa. Some one on one side would call out which of the opponents' hands contained the bone, and the calling side would get as many sticks, from a pile of about sixty, as the number of opponents' hands guessed correctly. Each side called the other alternately. Sometimes they would hold another unmarked bone in the opposite hand so as to confuse the guesser. The side which lost or got the fewer sticks had to give the other something as a forfeit.

They wrestle "catch-as-catch-can," but they usually try for a hold in the following manner: Putting the right arm around the opponent's waist and grasping the breeches at the thigh with the left hand. It is only necessary to throw a man, for as soon as he falls he is beaten. As a mark of friendship on separating, after this sport, the Indians exchange coats or other articles of clothing regardless of their value.

#### THE MEDICINE-MAN

The word "medicine" should be understood as synonymous with "magic." The medicine-man does not administer potions, but cures by other methods; thus, "make medicine" is synonymous with perform magic; hence, his aid is sought for more purposes than healing the sick, and he can perform to defeat the enemy, to overcome famine, or to make a prospective hunting trip successful. When a man is sick he calls in this Indian doctor, who sings to drive away the disease. Each medicine-man has his own way of singing, though the general form is a chant like those used in dances, in which words are sometimes used, but generally meaningless syllables. The medicine-man goes to sleep and dreams songs, and what he hears in the dream he repeats as an incantation over the sick one.

When Luke, one of these medicine-men, now perhaps forty years old, was a little boy, about 500 Indians encamped in skin houses about a mile up Mission Creek were taken with smallpox and most of them died. The remnant of the band migrated to Forty Mile, where they were attacked in 1897 by an epidemic of coughing and bleeding from the lungs, and many died in from four to six days. The Indians think that each of these epidemics was due to a bad medicine-man from elsewhere sending an evil spirit amongst them. The evil spirit was supposed to enter the man's body in the form of an animal and, by moving about in him, produced sickness.

It seems the medicine-man is still able to do this by taking a weasel skin and causing it to disappear in various ways. Sometimes he

holds it in the fire, whence it disappears without being destroyed, going into its victim; or the weasel skin may be caused to disappear by wrapping it in a cover or holding it between the palms and blowing a puff of breath on it. A medicine-man tried to demonstrate this to me, but the skin did not disappear, though I was assured that it would disappear in actual practice.

The weasel was called a "fetich," and this name applies to other animal skins used in the same manner, such as the marten and wolf, or, in fact, whatever animal the medicine-man sees in his dreams and wishes to employ in his practice. The skull and claws are sometimes removed from the skins, but generally are left on. Formerly they were ornamented about the neck and mouth with porcupine quills, but more recently with glass beads. Although a skin is still most popular, there are many other fetiches in use. A beaver's tooth, wound with beads and suspended on a string, is a useful fetich, and is made to disappear and reappear at the convenience of the medicine-man. Small bones are decorated and used in the same manner. A great many medicine-men dig a certain kind of root from the ground which they carry about in their pockets. It appears to be alive and at times grows larger or smaller. Some medicine-men employ the sun, moon, or stars in their songs instead of an animal, while others call upon the trees, birds, brush, or any convenient object.

The good medicine-man works in the opposite way from a bad one; he cures a sick man by drawing the weasel skin out of the ailing part. I was shown how it was extracted from the ribs, neck, or head. With the skin concealed up his sleeve, or hidden in his clenched hand, the medicine-man reached to the affected part, whence he jerked it forth in the twinkling of an eye. Sometimes in sickness, when all the friends are assembled to assist the medicine-man in singing, he will brush the affected part with his hand as he sings until, with a puff of breath, he blows the disease away. At other times he will firmly grasp at something invisible and appear to pull it out and throw it into the air, driving it away with a puff of breath. The medicine-man, after extracting the evil spirit, returns to the animal its own spirit and sends the evil spirit back to its original sender, whom it kills, because he sent it first.

Whenever a sick man dies the bad medicine-man takes back the evil spirit, and these spirits, which he sees only in the form of animals in his dreams or when he sings, are kept for future use. It is believed that a stronger medicine-man can kill a weaker one's ani-

mal, thus stripping the latter of his power, who thus becomes like any one else and liable to destruction by the stronger one.

If a man wants to become skillful in magic healing he goes to sleep in the same blanket with a medicine-man. When they are asleep and dreaming he is taught the medicine by his instructor. The medicine-man, however, is disinclined to teach others, because he is apt to lose his power and since a stronger one could kill him. A bad medicine-man likes to kill, but a good medicine-man always wants to cure, and it is said the good are apt to live longer.

Their treatment of wounds is most interesting. If a wound bleeds profusely, the medicine-man gets a piece of king salmon skin the size of the palm and cleans it of scales. He takes this between his palms and has another Indian hold his hands together for security; then, as the medicine-man blows, the salmon skin disappears, going into the wound, where it forms a membrane and stops the bleeding. This is extracted again when the wound is healed. This method is also employed when there is a pain but no bleeding.

An odd test used in case of sickness is to put a frog on top of the man's head; if the frog soon jumps away the man dies soon, but if the frog remains on his head for any length of time the man will live a long time.

Last winter one of the Indians had severe tuberculosis, bronchitis, and pleurisy, for which I treated him, unaware that he was a medicine-man, and during the spring he recovered. He has since confided to me that his illness was caused by a bad medicine-man from "Tanana," who sent the quill of a large eagle feather that entered into him and caused his sickness. He insisted that he extracted this quill in the presence of several witnesses, thus defeating with his magic the machinations of his enemy and curing himself. One of the witnesses assures me that this actually happened.

Disease is not always the result of the medicine-man's evil spirit, but sometimes comes of itself, so the Indians have certain actual medical remedies. If they have a cough they chew grass roots or spruce bark to stop the illness, and sometimes the old women boil bark, roots, and brush to make tea, which is drunk for all forms of illness. Originally many kinds of bark were infused in the same mixture, making a sort of general remedy, for it seems probable that the specific use of these herbs was not acquired until later from the whites; at least the medicine-man never used them or any other drug, his practice being limited to psychotherapy.

In war times the medicine-man performs his magic against the

enemy. In experiments of this nature a medicine-man uses for a fetich two pebbles, a few inches in diameter, with natural holes in them, tied to the ends of a string about a foot long, made of caribou-skin wound with porcupine quills. In demonstrating the use of the pebbles, the magician pointed to an imaginary enemy in the distance and, assuming an attitude of forward charge, his countenance showing fierceness and his eyes the glassy, vacant stare of the mystic, he suspended the pebbles by the middle of the string, swung them forward three times, blew on them a puff of breath, and with full strength threw them toward the enemy. Immediately relaxing, with a smile of satisfaction, he said, "They run."

#### INFLUENCE OF CIVILIZATION

There is an Episcopal mission at the village which most of the natives attend faithfully. It is their principal form of diversion from lying about in their squalid cabins. Strange as it may seem, the most stupid ones and those who cannot speak English make the better church-goers, while those who are more intelligent and can talk English associate with and come under the influence of the saloon loafers. Accordingly, the few crimes I have known to be committed by the natives were by the most intelligent members of the community. Even the bad Indians go to church, though they are hypocritical. I have seen a native take communion, get medicine from the hospital as a destitute, and a few days later offer a white man five dollars to get him some whiskey.

These people have learned to be charity-seekers and the church, it seems to me, maintains a weak influence over them by doling out charity. This is undesirable, for charity is not necessary, since there is opportunity for them to be self-supporting provided they are properly taught occupations and to despise instead of to seek assistance.

In view of these conditions, a Government official should be appointed or detailed to teach the natives agriculture, to act as a health officer and to compel them to live in a sanitary manner, to supervise the care of the sick, to establish a commissary where they may buy at moderate prices, to act as police, and to make further recommendations for their benefit.

## FOLK-LORE

The following stories were collected from various individuals, and are presented, as nearly as possible, in the style of the narrator:

## CREATION OF THE WORLD

Long time ago the water flowed all over the world. There was one family and they made a big raft. They got all kinds of animals on the raft. There was no land, but all water, and they wanted to make a world. The man of the family tied a rope around a beaver and sent him down to find the bottom, but the beaver didn't reach bottom; he got only half way and drowned. The man then tied a string around a muskrat and sent him down; he reached bottom and got a little mud on his hands, but he drowned. The man took the mud out of the muskrat's hands into his palm and let it dry, then crumbled it to dust. This he blew out all over the waters and it made the world. (All tribes about here are said to have the same story.)

## ORIGIN OF THE WIND

A long time ago, when all animals were men, there was no wind. There was a bear that used to go about with a bag on his back. Many people were curious to know what was in the bag and they often asked the bear, but he would not tell them. One day another man caught the bear asleep with the bag on his back. The man's curiosity to know what was in the bag was so great that he cut it open. The bag contained the wind, which then escaped and has never since been confined.

## THE OLD MAN AND OLD WOMAN

In the Yukon River between Eagle and Fortymile there are two large rocks which evidently were one before a geological cataclysm separated them. The natives call the one on the north side the "Old Man," and the one to the south the "Old Woman." These were the primogenitors of the Indians in this region. The story follows: These two old folks were once together in the middle of the river, but the old woman pushed the old man to the other side because he left her there. So he went north and she went south, but the children grew up around there. At that time this region was full of all kinds of animals, and they could talk like men. The old man killed off all the bad animals and saved one good one of each kind, which started the families. They have since been unable to talk.

The moose was the head game of the world, because the old man killed the bad moose first. The big swan was once the head of all birds and animals because it was stronger. All animals came together and had wrestling matches. The little teal duck was the strongest animal in the world. First the swan beat the moose, but the teal duck beat the swan after the swan had conquered all others.

## ADVENTURES OF THE OLD MAN

The "Old Man" (rock) in the Yukon went down the river where the bear, when bears were men, was fishing. He put his canoe on this side of the river where no one could see it from a point above where the bear was. Then he made a circuit on foot around the bear and reached the river lower down.

The old man then swam up the river, like a king salmon, to the bear's house, where the bear was spearing salmon. The bear tried to spear him for a salmon, but he grabbed the spear point, broke it off, and swam to his canoe and hid the spear point under the bow. Having disarmed the bear he now knew that he was safe. So he got in his canoe and went down to the bear's house to call. He concealed the fact that he had broken the bear's spear, but the bear believed that he did it, nevertheless. The bear wanted the old man to marry his daughter. The bear pointed to a mountain about a mile away, where there was no timber, and said that it was a good hunting place for bear, since a bear came up there every day. The old man went to the woods to get material to make some arrows. The bear had everything fixed dangerous about there, so that when a man touched a tree stump it would fall on him. The old man was cautious and would touch a stump and dodge when it fell. Then he secured the wood for arrows from the fallen stump. Now he wanted some feathers and the bear took him to a place said to be good for getting them. Here were big eagles that would kill men: The old man went to an eagle's nest in a big tree, where there were two young ones. He asked them which one could talk most. One said that he could talk most, and would tell the father and mother eagle about everything, so the old man killed him so that he couldn't tell. He asked the other young eagle how he knew when his mother was coming, and was told that she always followed a gust of snow. He asked when the father eagle came, and was told that he always followed a gust of hail. Then the old man hid under the nest with his spear. Then came the snow and the mother eagle appeared, carrying the upper half of a man. She asked the young one, "Where is your brother?" and he said, "It was too warm here and he went down where it was cool." She said, "I smell something here; what's the matter?" The young eagle said, "You smell that half a man;" but the mother eagle said, "I smell something different." Then the old man under the nest speared the mother eagle, piercing her from belly to crop. Then came the hail, and the father eagle followed and asked the same questions as the mother. He said to the young one, "Where is your mother?" and the young one answered, "She went down to look for brother." The father eagle brought with him the lower half of the man. Then he said, "I smell something," and the young one replied the same as to his mother. The old man was watching from under the nest, and he speared the father eagle too. This father eagle would kill any man he saw. The old man saved the young one. He got enough feathers to make his arrows. When he came back the bear said, "You're all right," which he always said. The old man wanted some pitch to stick the feathers to the arrows. The bear, as usual, led him to a dangerous place, where he told the old man there was plenty of pitch. Here the old man found a lake of pitch boiling like water. The old man wouldn't go near it, but took a long willow switch and dipped it into the lake. With this switch he threw the pitch all over the spruce trees about him. The spruce trees theretofore had never yielded pitch, but have done so all over the world ever since. Then the old man gathered enough pitch from a spruce tree and returned. Now he wanted sinews to bind the feathers and heads to the sticks of his arrows.

The bear led him to a moose lick where there was a bad moose. The moose didn't have much flesh, but was mostly bone and skin. His hide had such stiff hairs that it was hard for an arrow to penetrate. This moose would kill



every man he saw. There was lots of high grass about there and the old man crept up to the moose on hands and knees through the grass, keeping out of sight of the moose. When the old man got near the moose he stopped and wished for a mouse to come along. He told the mouse to go to the moose and chew the stiff hair off behind the left shoulder. The mouse went to the moose and asked to chew the hair off behind the left shoulder, to use for his nest to keep the young warm. The moose refused, but told him he could chew the hair from his hind quarter. The mouse insisted that he wanted the hair from behind the left shoulder because it was soft and warm. So the moose allowed him to take it. As soon as the hair was off, the old man shot the moose through this spot into the heart, killing him. Then the old man got his sinew from the spinal ligaments of the moose. Then he returned to the bear camp and finished making the arrows. The old man made the arrows with birch-bark heads because the bear said the birch bark was the best. The old man knew that this was false, but he did it to please the bear. The bear said that upon the mountain where there is no timber a bear came every evening, and that the old man could get it. The bear was accustomed to kill men by this ruse. He set his daughter up there dressed in a bear skin, and when a man came near she would hold him till her father bear killed him. The old man concealed bone arrow-heads in the back lock of his hair before starting. The old man and the bear started out to hunt bear. The bear said, "Walk slow" but the old man ran away. As soon as the old man approached the hill he saw the other bear and shot twice with his birch-bark pointed arrows, but they didn't penetrate. The bear when hit, instead of running away, as ordinarily, came toward the old man, who pulled the bone arrow-head out of his hair and shot the bear with it. He now saw it was the bear's daughter, for she hollered, "Father, that man hurt me." The bear said to her, "Catch hold of him," and as she tried to catch him she died. Then the old man ran away and the bear chased him all day. Then the old man ran into Ford's Lake. (Calico Bluff, six miles below Fort Egbert, on the Yukon, is called "Long Point" Clavath, pronounced "Klay-vay," and Ford's Lake, near by, is called Clavathmon, meaning Long Point Lake.)

The bear couldn't catch the old man, so he told the frog to drink all the water in the lake, and the frog drank it all. As soon as the water was gone the old man burrowed into the mud. The bear went all around digging in the mud to find the old man. As soon as he got near the old man, the old man wished for a snipe to come along and it came. He asked the snipe to go and hit the frog twice in the belly. The frog asked the snipe, "Did some one ask you to come?" The snipe said, "No, I am hunting for something for my children to eat." As soon as the snipe got near the frog he hit it twice in the belly and flew away. Then the water all ran back into the lake. The bear now was angry, and made a fish trap, which he put in the creek, from Ford's Lake to the Yukon River, to catch the old man. The old man knew this and made a mud man, which he pushed ahead of him, swimming down the creek. The mud man went into the trap, the bear pulled it up, and the old man swam down to the Yukon and down to the bear's house below Calico Bluff, where he got his canoe and went down the Yukon, and the bear never saw him any more.

## THE MIRACULOUS LITTLE MAN

Long time ago, before the "Old Man" and "Old Woman," lots of Indians were together and they fought until all were killed except an old woman and her daughter. This old woman cried every day because there was no man to help her do her work or get her wood. Every day when she had to get her wood from the brush she cried, and each day she had to go a little farther for the wood. One day she heard a sound like a baby crying in the woods. At first she did not go to see what it was, but told her daughter, for she knew there were no people there. Her daughter said, "Next time you hear it; go to it, and if you find a baby bring it." She went for wood again and heard it, and going to it she found a baby boy at the foot of a spruce tree. The boy was not born, but found by the old woman in the brush. When she brought it mother and daughter rejoiced, for bye and bye they would have a man. As soon as they got him home he became strong and could work. As a joke the old woman told him to take their dog and go out hunting, thinking that he didn't know how. She told him to tie a rope around the dog's neck. He tied it on the dog, then went out hunting, and on the way he pulled so hard that he choked the dog and dragged it back with him.

The old woman still had friends in another place. So she and her daughter and the little man went amongst these Indians again. The boy was small and didn't grow. When he went hunting he would put on an eagle-skin like a coat and fly. He was a pretty good hunter. People asked him, "How do you cut moose with a knife? You are too small." He said that when he kills a moose he is like a big man, but is small when he comes home again. He does all miracle work. He does not bring his eagle-skin home again, but leaves it two miles away on a tree. The daughter found the eagle-skin and took one tail feather to stick in her hair. The boy found it out and was angry, so he said to his sister, "I wish all your friends would be killed again." Then she said, "What are you going to do with your mother?" (the old woman), and he said, "I will put her in the corner of the birch-bark basket." In a little while war came and all were killed except the old woman and the daughter and the little man. Then the little man made lots of very small arrows and made a few from a bear's ribs. He worked all the winter making these arrows, because he was going to fight the people all by himself. These people who killed his friends lived by a big lake. The old woman was with the little man, but the daughter had been captured by these people. He got lots of bags for arrows, and, being small, he walked under the snow and hid a bag of arrows about every 50 yards apart, so that when he shot away his arrows in fighting them he could run back to get some more. When he came near, the people thought that he was a raven because he was such a small black thing. His sister said, "You people didn't kill the little man with the old woman." There was one man who wasn't in the fight, so he was selected to kill the little man. The man took a small stick to kill the little man, thinking it would be easy, but the little man threw a small object at him, striking him in the chest and killing him. Then all the people, thousands in number, ran after him without their arrows, because he was too small to shoot. He ran back the same trail on which he came. He would come out of his hole and shoot some; they would rush after him, and back he would go and come up elsewhere and shoot again. Every time he shot he killed. He killed all those people in a day. He brought his sister back to the old woman at home.

After the fight he said he would make a big pot-latch (a celebration with feasting and giving of presents), because he had wounded and killed lots of people. Then he went hunting every day, and killed all kinds of game and saved the hide and meat. The mother and daughter tanned all the skins, dried the game and cached it. The little man said he was going to give the skins as presents to other people. The old woman said, "All the people are killed, so who can you give them to?" and he said, "Bye and bye lots of people will come." This was on a big island just this side of the Old Woman rock. When he collected his meat and fur he began to sing every day that he wished that lots of people would come from up and down the river to the pot-latch on the island, and they came without being told. They all moved about together and sung as usual at a pot-latch. When they did it the island cracked in two parts, because too many people were on it. The people feasted every day. After the feasting he gave away all kinds of skins and furs. He made the big time because he killed lots of people and was sorry for it. He killed the people because they killed his friends first.

#### THE BOY IN THE MOON.

See the mark in the middle of the moon like a man? That was a little Indian boy when nobody had anything to eat. During the famine this boy dreamed that they were going to kill lots of caribou.

The boy said that when they killed all the caribou he wanted the leader caribou. The boy's uncle gave him the wrong caribou, because the uncle did not believe the boy dreamed it. Then the boy cried for two nights because he didn't get the right kind of caribou. The boy told his father, who brought home the hind quarter of caribou, to never cut the flesh off it to the bone, but to cut off what he needed, wrap it in a skin, and put it under his head to sleep on. The father did this and when he awoke he found a whole hind quarter, and thus forever he could eat caribou from this leg and always have it whole. Next night the boy, who always slept between his father and mother, was gone and nobody could find him. The boy wore marten-skin pants. In the morning the left leg of the pants was found on the tent-pole where the hole is in the roof for the fire. Hence they concluded that he went up through the hole and the left pants' leg was torn off going through. He went up to the moon and was seen there the next night, and it was proved, for he had a larger right leg than left, because the right leg has pants on. From his right hand hangs a little round bag with the wrong caribou meat in it. That night a big storm came and snowed all over where the caribou was cached. Then all the killed caribou came to life and went away, and the Indians couldn't find their meat. Then they all starved to death except the boy's father and mother. During the fall and winter with clear sky, one who has been properly instructed can readily make out the outline of this boy in the moon.

#### THE CAMP ROBBER

The camp robber is a slate-colored Alaskan jay, well known for its habit of stealing food from camps.

When all animals were men the camp robber was a medicine-man. One time the people had nothing to eat, and they asked the medicine-man to get them some food. For six nights a different man each night dreamed to find a way to get something to eat. The camp robber was the last and sixth man.

He dreamed and called all the people together to bring their snares with them. He made a pack of the snares and put them on his back. The people made the snow in a big heap. Around this he went, chanting and saying, "Bye and bye meat will come." Then he reached into the snow heap and pulled a caribou's head out by the horns. He did not kill it, for it was not a real caribou; only a spirit. So he painted the horns and tail red, with red ochre, and let it back into the snow heap. Next day they got lots of caribou, and the one with red horns and tail was amongst them. That is why an Indian never kills a camp robber when he steals grub, but lets him go because he helped them in the days when he was a medicine-man.

#### THE RAVEN

The raven lies more than any other game. Long time ago all the animals were good except the raven. He was an habitual liar and robbed everybody. Whenever he found dead game he ate the eyes first. Once when the raven was like a man he came to a strange camp and told a man to kill his old dog and throw it into the river. The man did so. Then the raven followed the dog down the river and pulled it out and ate its eyes. Thus he went from camp to camp as a deceiver.

#### THE RAVEN RESTORES THE SUN TO THE SKY

The raven was the cleverest deceiver of all animals, but has one good deed to his credit. At this time, when all animals were men, a bear, who was a bad man, did not want the people of the world to have light, so he took the sun down from the sky and hung it with a string on his neck and kept it covered with his coat. The raven came to his house and pretended to be a friend, and soon married the bear's daughter. They very soon had a child who could walk as soon as born, and grew up in a very short while. The raven told the boy to get the sun from the bear, so the boy cried for it very much and finally the bear allowed the boy to play with it, but watched him carefully. There was no hole in the roof, but the raven made one, and when the bear's attention was away for a moment the boy threw the sun up through the hole into the sky and the bear couldn't get it any more. The raven then ran away and never came back, for the bear would like to kill him.

#### THE RAVEN AND THE COOT (MUD HIEN)

The raven wanted all the birds to look nice and he painted them with their various hues. He painted the coot last. The coot was then in turn to paint the raven, who wanted to be very richly variegated with colors. The coot was painting the raven gorgeously with his right hand, but had charcoal concealed in his left hand. Then, for a joke, while the raven's attention was away, he smeared the raven all over with charcoal. The raven was angry and chased but couldn't catch the coot, so he grabbed and threw a handful of white mud, spattering it over the coot. That is why the coot has white spots on his head and back. The coot flew away and the raven has remained black ever since.

#### THE WOODPECKER

The woodpecker was a very domestic sort of a man-bird. He used to get married lots of times. When he would get married he would go away from

the people with his wife. After a while he would come back without his wife. He would say that she died. Then he would get another wife. One girl was very smart, so she married him to find out what he did with his wives. They went away together. When he found a good hunting ground he stayed there. Whatever game he got he only gave fat and grease to his wife and ate the meat himself. Whenever she wanted a drink of water he gave her grease to drink. Every time he went hunting he took about ten days, and brought back fat and grease and blueberries and cranberries and all kinds of berries, but no meat. The girl knew by this that he was going to make her so fat that she couldn't walk, for already when she would lie down she could hardly get up. Then, before he went hunting again, at her request, he prepared a dugout on the bank of a creek. She told him she was lonesome and wanted to be where she could see the creek running. This dugout was to be her home while he was away. The door was covered with brush. She told him to make a small, sharp spear for her, so she could keep the mice away with it. As soon as her husband went she took the spear and dug a tunnel from the dugout to the creek for her escape, for she knew he would kill her when she became very fat. She was too fat to walk, so she rolled down to the creek through the tunnel, and stayed in it a whole day, until the fat came off from her. Then she went into the woods and watched till her husband came back. As he approached she saw that he was picking a lot of berries. When he reached the dugout, where the hole was covered with brush for concealment, he ran his spear through the brush so as to kill her; but she wasn't there. Every time he jabbed the spear in and withdrew it he tasted of the point to see if it stuck her. Then he said aloud to himself, "Some spirit must have taken her away." The woman now was sure that he wanted to kill her, so she ran away back to her family. She told them all about it, saying that he killed his wives and ate them, and that he fed them berries to flavor their meat. The man came back then. His wife's mother previously put her in a sack and hid her. He cried much, pretending to be sorry for the death of his wife. He said to the mother, "My wife has died again." Everybody else cried, to deceive him into thinking they believed him. Next day everybody moved again. The old woman gave him a heavy sack to pack along and told him it belonged to his brother-in-law, who needed it. She told him to hang it high on a tree, so the dogs couldn't get it. She told the other men not to help him lift it up. He tried so hard to lift it up that he broke his back-bone.

When the man was injured nobody took care of him. The hunting party went away without him. When they returned and saw that he was sure to die, they let him see his wife, so that he would know that he was found out. His wife was in the sack. Her mother then arrived with other Indian women, untied the sack, and let her out, and she was safe. He died then. They preferred to let him kill himself in this way.

#### THE ROBIN

The robin had a husband, but she loved another man. She had a family of four—a husband, son, daughter, and self. When she sat on a tree she would laugh. Because she loved another man, she wanted her husband and son to die, so that she and her daughter could live with this man. Every time she sang she would say, "I wish my husband and son would die," then she would laugh. Then she would say, "I wish I and my daughter would live," then she

would laugh. Her husband did whatever she said, and he died. The boy died too. Her husband and son died because she wished them to die. She wished this, so she could get the man she wanted.

The native still chants the words in his own language, meaning, "I wish my husband and son would die," to the tune of a robin whistling. The laugh referred to is the clattering noise which a robin makes when excited.

#### THE MARTEN

The marten has a white or reddish bridge across his breast. Whenever he was in an Indian camp and they were sitting around the fire eating he always looked hungry and watched every one eat, looking greedily for something for himself. One Indian didn't like being ogled, and threw a chunk of king salmon grease which struck him on the breast and made this bridge-mark.

#### THE WOLVERENE AND THE TRAVELER

The wolverene is supposed to be the marten's uncle and the wolf's brother-in-law.

One time a man was walking down along a creek. It was winter. He met a wolverene coming up. The wolverene had no sled nor toboggan nor anything except a caribou-skin blanket on him. As soon as the man saw him, the wolverene went into the woods and filled his blanket with brush from spruce trees and made believe he had a load of utensils. His family was following a few miles back. The wolverene sat on his load and made the spruce sticks break. Then he told the man that he had broken his utensils. The man sat on his snow-shoes. The wolverene was bad and reached a long copper hook under the snow to catch hold of the lower snow-shoe and trip him. The wolverene would eat men. The man watched the wolverene because he knew what the wolverene would do. The wolverene, after tripping the man, would kill him with his copper ax. The man put his rabbit-skin cap under himself, so when the hook came under him it caught the cap and pulled it out instead of catching his leg. Immediately then the man jumped on the wolverene, grabbed the wolverene's ax, and killed him with his own ax. The man built a camp. He cut off the wolverene's right leg at the shoulder and hung it over the fire to cook. Then he laid the wolverene on his right side to conceal the cut-off shoulder. He put the hook in the wolverene's left hand, giving him the appearance of poking up the fire. This was to deceive the wolverene's family that, coming soon, would think he had something and was cooking it. Then the man hid in the snow about fifty yards away and watched. When the wolverene's family came the young ones tried to wake him up to tell him that the shoulder was cooked, but they could not wake him up. Then they ate up the shoulder, not knowing it was their father's. Then they tried to wake him up more, and found out that he was dead and his shoulder off. Then they knew that they had eaten their father's shoulder. They took their spears and hunted all around for the man. They knew he had come down the river to the camp by his snow-shoe tracks, but he concealed his last tracks. They went about stabbing their spears into the snow to find him. When they came near him he jumped up on his snow-shoes and they all ran after, trying to catch him. The man could not run fast enough, so he wished for a warm wind to come so that the young wolverenes would get overheated and have to throw their coats away. The mother wolverene followed them, and every time one

would throw his coat away she would pick it up and eat it. The man now knew that the young wolverenes had no coats, so he wished that a cold storm would come. Then the storm came and they called to the man, "Partner, come and build a fire for us, because it is cold and we won't kill you." The man started to build a fire. He got wood together and started a fire under it. He didn't want it to burn right away, so he put a little snow on the fire. Then he told the young wolverenes to sit in a row and all blow the fire at once together. As they bent to blow it he struck all of them over the heads with a long pole, killing them all with the one blow.

#### THE WOLVERENE AND THE HUNTER

The wolverene used often to go out hunting with a man, but every time he would return without his partner. One man decided to go out with him and find out what he did with them. They traveled together all day. Every time they saw a moose track the man wanted to follow it, but the wolverene said, "That's no good; we must go long way to get good hunting." At dark they made a camp. There was plenty of wood about, but wolverene said that he would get a hollow rotten stump and a large squirrel's nest (the kind built on pine-tree branches). The man had stripes about his pants below the knees, made of porcupine quills. The wolverene didn't have any stripes on his pants. They both got wet. The man knew that the wolverene was going to do something bad with the rotten wood. They stretched a pole across the fire and hung their pants on it to dry.

The man turned his pants inside out, so the wolverene did the same way. The wolverene sat on the left of the fire and the man sat on the right, with their pants on their respective sides, so that they would know whose pants each were. They both went to bed without pants on, beside each other. This man was smarter than the wolverene. The man did not sleep, but pretended to. He would snore; then the wolverene would go to get up quietly; then the man would move a little and the wolverene would lie down. The man did not go to sleep, but kept awake till the morning hours, when he was sure the wolverene was asleep. Then the man got up and changed the place of the pants and went back to bed. The wolverene now woke up and took the pants which he thought was the man's. He put them inside the hollow stump and laid the squirrel's nest over it. Then he put it in the fire and burned it. At daylight the man got up. The fire was out, so he built another fire. After that he took his pants down. Then the wolverene got up and said, "Partner, that's my pants." The man said, "No, they are my pants." The wolverene tried to take them away, but the man said, "You haven't any stripes on your pants; there are the stripes, so they're mine." The wolverene was sorry he lost his pants, and said they must have fallen on the fire and burned. The man got lots of small wood, no large pieces, so that it would burn up quickly; then he told the wolverene he would go home to get a pair of pants and come back after him. When he started he got a few hundred yards away; then he called to the wolverene and said, "I have found out now what you do with your partners. I won't come back to you any more." Then the man went home and let the wolverene freeze to death.

## A FAMILY ANECDOTE

When Arthur, my interpreter, was a little boy, a lot of youngsters used to get together and some old man or old woman would tell them anecdotes and folk-lore stories. One of them is as follows:

Arthur's mother narrowly escaped death by a big moose once. The moose kills dogs by stamping with the fore feet or kicking with the hind feet. The Indian women went out with the dogs to bring home a lot of cached caribou meat. They dragged the meat over the snow, wrapped up in caribou-skin. A moose appeared at the cache and all the dogs went after him. The women did not want to kill the moose, but they tried to do so because they could not get the dogs away. So they fastened a knife to a stick and tried to spear it. The moose ran toward Arthur's mother and planted both fore feet in front of her but she sat humped up and kept perfectly motionless, and the moose turned away without harming her. If she had moved he would have trampled her to death.



SMITHSONIAN MISCELLANEOUS COLLECTIONS

VOLUME 56, NUMBER 5

# A PRELIMINARY STUDY OF CHEMICAL DENUDATION

BY

FRANK WIGGLESWORTH CLARKE

CHIEF CHEMIST, U. S. GEOLOGICAL SURVEY



(PUBLICATION 1935)

CITY OF WASHINGTON  
PUBLISHED BY THE SMITHSONIAN INSTITUTION  
JUNE, 1910

The Lord Baltimore Press  
BALTIMORE, MD., U. S. A.

# A PRELIMINARY STUDY OF CHEMICAL DENUDATION

BY FRANK WIGGLESWORTH CLARKE

CHIEF CHEMIST U. S. GEOLOGICAL SURVEY.

In 1876 the late T. Mellard Reade delivered a remarkable address before the Liverpool Geological Society,<sup>1</sup> which was afterwards separately printed under the title, "Chemical Denudation in Relation to Geological Time." In this address Reade attempted to measure the solvent action of surface waters in England and Wales, and to estimate the amount of dissolved solids annually carried by British rivers to the sea. His conclusion was, in brief, that the annual run-off in England and Wales transported 8,370,630 tons of mineral matter in solution; a quantity which would represent a lowering of the area in question at the rate of one foot in 12,978 years. Evenly distributed, the amount of material so removed from the land amounted to 143.5 tons per square mile of surface, a figure which is surprisingly large. Reade also, from such data as he could obtain, made similar but rough estimates for several European river basins; which, in British tons per square mile, may be tabulated as follows:

Rhone .....	232.
Thames .....	149.
Garonne .....	142.
Seine .....	97.
Rhine .....	92.3
Danube .....	72.7

The average for the entire land surface of the globe he put at 100 tons per square mile, a figure that was not much better than a guess.

About eight years later, in another address before the Liverpool Society, Reade discussed the subject of denudation in the two Americas.<sup>2</sup> For the Mississippi, on the basis of a single old and imperfect analysis, he computed a solvent lowering of the drainage basin at the rate of 120 tons per square mile per annum and for the Amazon his figure was 50 tons. For the St. Lawrence and the River Plate his figures are less explicit, but the St. Lawrence he considers as having a greater chemical activity per square mile than the Mississippi. His former average of 100 tons for all the river basins of the globe he regarded as confirmed.

<sup>1</sup> Proc. Liverpool Geol. Soc., vol. 3, p. 211, 1876.

<sup>2</sup> See "The Evolution of Earth Structures," pp. 255-252. London, 1903.

In 1887 Sir John Murray<sup>1</sup> published a careful discussion of the relations between rainfall and run-off for the entire globe, and incidentally, from the average composition of nineteen rivers he estimated that the saline matter annually carried into the ocean amounted to nearly 5,000,000,000 tons. The rivers taken for this estimate were not named, but must have been in great part European. American data were at that time very meager, and, except for the Nile, there was little material to be had relative to the rivers of Africa and Asia. Reade and Murray both were handicapped by the defectiveness of their data; and yet their conclusions were so important that they have since been made the basis of several attempts to compute geological time. These attempts will be considered in due course later. It is now time to revise some of the fundamental figures.

Within the past year, 1909, two noteworthy reports have been published by the United States Geological Survey.<sup>2</sup> In one of them Dole and Stabler have summarized a great number of observations upon the discharge, drainage areas and salinity of many American rivers, and in the other Dole has given detailed analyses of the waters east of the hundredth meridian. These analyses are numbered by thousands, and in each case the composition of a river water represents the average composition during an entire year. For example, the water of the Mississippi, taken just above New Orleans,<sup>3</sup> was collected daily. Each week the seven samples were mixed and analyzed, and this was repeated regularly during the year. The average of the fifty-two weekly composites gave the mean composition of the river; and, combined with the known discharge, the amount of dissolved matter contributed annually by the entire drainage basin of the Mississippi to the Gulf of Mexico. With evidence of this kind the problem of chemical denudation can now be attacked systematically; and to do so is the purpose of this paper.

First of all, let us try to determine the average composition of the inorganic matter held in solution by river waters, taking into account as far as possible the entire surface of our globe. This is a subject of fundamental importance; for upon its details the estimates of geological time, to which reference has already been made, must be based. For the rivers of the United States the material, although not exhaustive, is adequate; for Europe a fair average can be computed; but beyond these areas the evidence is still very imperfect. Something, however, can be done even with the scanty data which now exist; by comparing the analyses of Asiatic or African waters with those of similar areas elsewhere. The com-

---

<sup>1</sup> Scottish Geographical Magazine, vol. 3, p. 65, 1887.

<sup>2</sup> Water-Supply Papers 234 and 236.

<sup>3</sup> The river was also studied with great thoroughness at several other points, and so too were its more important tributaries.

position of a river water shows marked climatic features, and the magnitude of the load carried is affected in the same way. In the Temperate Zone, alternations of freezing and thawing tend to break up the rocks and so to render them more easily decomposed by percolating waters. With even moderate humidity the activity of the waters is great, and large amounts of material are transported by them. The rivers of Europe and of the eastern United States are marked by more than the average salinity of flowing waters, and estimates based upon them exclusively are sure to be excessive. In an arid region, although salinity may be high, the run-off is small, and much of an ostensible drainage area will contribute little or nothing to the mineral matter of a stream. Arctic rivers flow to a considerable extent over tundra, which is frozen during the greater part of the year. They, therefore, have comparatively small influence in rock solution, and much of their flow must be mere surface run-off. So also tropical rivers like the Amazon carry relatively light loads in solution, for their courses are largely through swamps and forests where the soil, unreplenished by fresh rock decomposition, has been leached for centuries and so deprived in great part of its soluble matter.

To illustrate some of these differences in the composition of stream waters a few typical examples may be taken. The analyses represent, in ionic form, the percentage composition of the dissolved mineral matter, and under the caption of *denudation factor* I give the number of metric tons annually removed in solution from each square mile of a drainage basin. The following waters have been chosen for this purpose:

- A. The St. Lawrence at Ogdensburg. Annual average as given by Dole, the denudation factor by Dole and Stabler.<sup>1</sup>
- B. The Mississippi at New Orleans. Annual average; Dole and Stabler. Analyses by J. L. Porter.
- C. The Rio Grande at Laredo, Texas. Annual average as given by Dole from analyses by W. H. Heileman. Denudation factor from Dole and Stabler.
- D. The Colorado at Yuma. Mean annual composition as given by Forbes and Skinner. Bull. 44, Arizona Agric. Exper. Station, 1902. Denudation factor by Dole and Stabler.
- E. The Amazon. A single analysis by P. F. Frankland, used by Reade. Two analyses by Katzer give lower salinities, and, therefore, a smaller transport of material. For the total discharge of the river I have taken the data given by Murray in the memoir already cited.

---

<sup>1</sup> Dole and Stabler's figures for denudation are given in tons of 2000 lbs. They are here reduced to metric tons of 2205 lbs. The analyses are recalculated to two decimal places.

F. The Uruguay. Mean of two analyses by Kyle and Schoeller.<sup>1</sup> Denudation computed from Murray's figures for the discharge and drainage area.

G. The Nile. Annual average as shown by Letheby's analyses.<sup>2</sup> Drainage area from Murray. Total dissolved matter, 20,772,400 metric tons per annum according to Chélu.<sup>3</sup>

	A.	B.	C.	D.	E.	F.	G.
CO <sub>2</sub> .....	45.69	35.21	11.55	13.02	34.75	22.91	36.50
SO <sub>4</sub> .....	9.08	15.36	30.09	28.61	7.37	5.02	17.44
Cl .....	5.82	1.60	21.65	19.92	3.85	2.87	4.47
NO <sub>3</sub> .....	.23	6.21	....	....	....	2.75	trace
Ca .....	23.45	20.49	13.73	10.35	21.12	9.91	20.10
Mg .....	5.45	5.38	3.03	3.14	2.57	2.91	4.01
Na .....	4.77	8.33	14.78	19.75	1.94	4.84	3.04
K .....	4.99		.87	2.17	2.31	1.56	7.97
SiO <sub>2</sub> .....		7.04	3.83	3.04	18.80	45.27	6.47
Al <sub>2</sub> O <sub>3</sub> , Fe <sub>2</sub> O <sub>3</sub> .....	.52	.38	.47	....	7.29	1.96	....
	100.00	100.00	100.00	100.00	100.00	100.00	100.00
Denudation factor....	105.	98.	22.7	46.2	53.	50.4	16.

These analyses tell a consistent story. The St. Lawrence represents a humid area, and every square mile of it contributes something to the salinity of the waters. Hence a solvent activity of 105 tons per square mile. The Mississippi is a blend of waters from humid regions on the east and arid or semi-arid plains to the west, and its load is, therefore, proportionately lowered. The Colorado and Rio Grande are typical of areas which are largely arid, and many square miles of their nominal drainage basins add nothing to the saline burdens. The Amazon and the Uruguay show the low salinity of the tropical forest regions, and the Nile flows for a thousand miles of its course through a desert. The saline matter of the Nile comes in great part from the regions south of Khartoum. It has no tributaries worth considering north of the Atbara.

Even on the purely chemical side the analyses are instructive. The water of the St. Lawrence is essentially a calcium carbonate solution; in the Colorado and Rio Grande sulphates and chlorides predominate, and calcium is relatively low; the Mississippi has an intermediate character. As a rule the waters from arid regions resemble the Colorado; those from humid areas are more like the St. Lawrence. This, of course, is not an absolute rule, but it holds fairly well in a broad general way. It is a distinct aid in discussing the larger problems of chemical denudation.

<sup>1</sup> See "Data of Geochemistry," Bull. 330 U. S. Geol. Surv., p. 75.

<sup>2</sup> *Ibid.*, p. 82.

<sup>3</sup> Le Nil, l'Egypte, le Soudan. Paris, 1891.

In an essay of this kind it is impracticable to give all the details of the discussion. It is enough to indicate their nature briefly, for the results can only be approximations to the truth, with no claims to finality. Taking the several continents in order, the composition of their waters tributary to the ocean may be estimated as follows:

For the United States the data given by Dole and Stabler in Water-Supply Papers 234 and 236 are taken, together with those of Forbes and Skinner for the Colorado. The river basins considered are the St. Lawrence, Hudson, Delaware, Susquehanna, Potomac, James, Roanoke, Neuse, Cape Fear, Pedee, Santee, Savannah, Altamaha, Apalachicola, Alabama, Pearl, Mississippi, Brazos, Colorado of Texas, Rio Grande, Colorado of Arizona, and Sacramento.<sup>1</sup> Each average composition is roughly weighted proportionally to the total amount of dissolved matter transported by the river in a year, and in that way the mean for the United States is obtained; a mean which is not likely to be much altered by any future analyses. According to Dole and Stabler the quantity of saline matter carried from these basins is 87 short tons or about 79 metric tons per square mile annually.

For the rest of North America only an estimate is possible. Eleven analyses of river waters from the Saskatchewan system, one from the Yukon, and one from the Ottawa, give a mean composition of the dissolved matter resembling that of the St. Lawrence. So much for British North America and Alaska. For Mexican and Central American waters no data are at hand, but it is probable that they would be, for northern Mexico, at least, similar to those of Arizona, New Mexico and Texas. That is, the waters north of the United States and south of it would vary from the mean obtained for the United States, in opposite directions, and so tend to balance each other. In short, the average for the United States will probably represent fairly well the average for the entire continent. If we assume that six millions of square miles of North America lose 79 metric tons in solution per square mile per annum, and that the composition of the saline matter so transported is that found for the United States alone, we shall not be very far from the truth.

Analyses of South American river waters are not numerous. For the great rivers north of the Amazon I have found no data at all. We may assume, however, that they will resemble the Amazon in their general features, and taking the analysis and denudation factor of that river as typical, we can regard its composition as representing the waters of about three millions of square miles. Figures for the Uruguay, draining 151,000 square miles, I have already given. There is also an analysis by

<sup>1</sup> Average of 20 composite analyses of 10 daily samples each, furnished by Mr. R. B. Dole. Not in Dole's memoir.

Schoeller of water from the Rio Negro, which I assign equal weight with that of the Uruguay. The data for the River Plate are unsatisfactory, for the analyses suggest a strong probability of tidal contamination. South of the Plate the streams show a resemblance to those of our own southwestern areas, of which the Colorado is the type. I have averaged together twelve analyses, including two Chilean rivers, and so obtained the results given in the following table. In combining the analyses they are weighted as indicated at the foot of each column.

	<i>Amazon.</i>	<i>Uruguay.</i>	<i>Negro.</i>	<i>12 rivers.</i>	<i>Weighted mean.</i>
CO <sub>2</sub> .....	34.75	22.91	39.10	19.82	32.48
SO <sub>4</sub> .....	7.37	5.02	1.23	17.22	8.04
Cl .....	3.85	2.87	4.43	19.14	5.75
NO <sub>3</sub> .....	....	2.75	1.95	2.65	.62
Ca .....	21.12	9.91	17.82	10.77	18.92
Mg .....	2.57	2.91	1.96	2.82	2.59
Na .....	1.94	4.84	10.24	21.01	5.03
K .....	2.31	1.56	....	1.67	1.95
Fe <sub>2</sub> O <sub>3</sub> , Al <sub>2</sub> O <sub>3</sub> ....	7.29	1.96	1.52	.36	5.74
SiO <sub>2</sub> .....	18.80	45.27	21.75	4.54	18.88
	100.00	100.00	100.00	100.00	100.00
Weight .....	12.	1.	1.	2.	

This mean I shall assume as representing the waters of four millions of square miles, with a denudation factor, as shown by the Amazon, Uruguay, and, for comparative purposes, the Colorado also, of 50 tons per square mile annually. This is only a rough estimate, but it is a probable one and the best I can make with the existing material. The Amazon dominates the combination, just as the Mississippi does in the United States. Data relative to the Magdalena, Orinoco, Demerara, San Francisco, and Plate, the latter at some point far above the possibility of tidal contamination, are much to be desired.

Analyses of European river waters are abundant, but rarely numerous enough for any one stream to give conclusive evidence as to its denudation value. I have, however, averaged together 300 analyses of European lakes and rivers,<sup>1</sup> first by groups and then weighting each group proportionally to its drainage area. In that way I have obtained a highly probable mean for the composition of the waters, which will appear in a table to be given later. The denudation factor I can only estimate roughly. According to Geikie<sup>2</sup> the Thames carries in solution past Kingston 548,230 British or 556,930 metric tons dissolved inorganic matter annually. The drainage area is 6100 square miles; hence a denudation factor of 91.3 tons; an estimate much lower than that of Reade. For the Meuse above Liège, the

<sup>1</sup> Not 300 rivers. Some streams, like the Elbe and Danube, are represented by numerous analyses.

<sup>2</sup> Text-book of Geology, 4th ed., vol. 1, p. 489.



figures published by Spring and Prost<sup>1</sup> give a factor of 139 tons per square mile. Reade's estimate for all Europe is 100 tons, and that seems to be fairly probable. For Europe, then, I shall assume that 3,000,000 of square miles suffer solvent denudation at the rate of 100 tons per mile, a figure which is much like that of the St. Lawrence. Europe is generally well-watered, and its waters have all the characteristics of those from the humid areas of the United States. In the latter the denudation factor is lowered by the arid regions of the southwest.

The African material is very scanty. In addition to the figures already cited for the Nile, with a drainage area estimated at 1,293,050 square miles, I have found only analyses of three small Algerian rivers which exhibit all the peculiarities of waters from other semi-arid districts. Ignoring the latter I shall estimate that 1,500,000 square miles in Africa are represented by the Nile with the denudation factor of 16 tons. I shall also assume that 6,500,000 square miles are fairly equivalent in character to South America, with the same composition of the waters and the same denudation factor of 50 tons. The desert regions, like the Sahara, of course count for nothing. Analyses of water from the Niger, Congo, Orange, and Zaiobesi are much needed.

The data relative to Asiatic waters are still more defective. I have found analyses by Schmidt of water from Lake Baikal and the river Om in Siberia, and one by Nicholson of the Mahanuddy in India. Waters of saline lakes, not tributary to the ocean, I of course leave out of account. The water of Lake Baikal is closely similar in character to that of the Yukon and St. Lawrence; that of the Mahanuddy more resembles the waters of tropical South America. With these feeble clues I can only make a very rough estimate for Asia, as follows: Assume three millions of square miles to average like Europe; three millions like the United States; and one million like South America. Large areas in Asia obviously are left out of consideration; the Caspian depression, the deserts of Central Asia, and the Arabian peninsula. The streams which reach the sea from Arabia are too insignificant to carry any weight in the general discussion. For Australia I have no data.

To sum up, the crude figures upon which to base further discussion are as follows, beginning with a summary of the denudation values for each continent:

North America	6,000,000 sq. miles, at 79 tons.....	474,000,000 tons
South America	4,000,000 " " " 50 " .....	200,000,000 "
Europe	..... 3,000,000 " " " 100 " .....	300,000,000 "
Asia	..... 7,000,000 " " " 84 " .....	588,000,000 "
Africa	..... 8,000,000 " " " 44 " .....	352,000,000 "
Total	.....	1,914,000,000 "

<sup>1</sup> Ann. Soc. Géol. Belg., vol. II, p. 123.

The total area accounted for is 28,000,000 square miles, with a mean solvent denudation of 68.4 tons. The incompleteness of the figures is due to the fact that large areas of the earth's land surface either do not drain into the ocean, or, as in the cases of Arabia, the coast of Peru, etc., contribute little or nothing to it. There is, of course, local denudation in areas like the Great Basin of the United States and the Caspian depression; but that does not fall within the scope of the present discussion. Furthermore, the circumpolar regions such as Greenland and the Antarctic continent have no large rivers, and must be left out of account. The total land area to be considered, that is, the area which contributes to the salinity of the ocean, is, according to Murray, 39,697,400 square miles, or 40,000,000 in round numbers. Assuming that the figures so far given for 28,000,000 square miles represent a fair average, the total amount of saline matter carried into the ocean by the river drainage of the world is 2,735,000,000 metric tons, an estimate only a little more than half that given by Murray.

The composition of the saline matter thus carried into the ocean is given in the next table. The averages for Asia and Africa are made up in the manner already indicated: the final general mean roughly weights the individual means proportionally to the number of tons given in the last column of the foregoing table:

	<i>N. America.</i>	<i>S. America.</i>	<i>Europe.</i>	<i>Asia.</i>	<i>Africa.</i>	<i>General mean.</i>
CO <sub>2</sub> .....	33.40	32.48	39.98	36.61	32.75	35.15
SO <sub>4</sub> .....	15.31	8.04	11.97	13.03	8.67	12.14
Cl .....	7.44	5.75	3.44	5.30	5.66	5.68
NO <sub>3</sub> .....	1.15	.62	.90	.98	.58	.90
Ca .....	19.36	18.92	23.19	21.23	19.00	20.39
Mg .....	4.87	2.59	2.35	3.42	2.68	3.41
Na .....	} 9.23	5.03	4.32	6.42	4.90	6.40
K .....		1.95	2.75	1.54	2.35	1.51
R <sub>2</sub> O <sub>3</sub> .....	.64	5.74	2.40	1.96	5.52	2.75
SiO <sub>2</sub> .....	8.60	18.88	8.70	9.51	17.89	11.67
	100.00	100.00	100.00	100.00	100.00	100.00
Weight ....	10.	4.	6.	11.	7.	

The final mean, regardless of possible corrections, is curiously near the average figures for three great rivers, the Mississippi, Amazon, and Nile. It is probably rather high in silica, but on the whole it is as near to the truth as can be determined from the existing data. The greater rivers of Africa and Asia are yet to be studied, and much more should be done in South America. In the analyses reported by Dole, sodium and potassium are rarely discriminated, and hence the two radicles are given together as sodium alone. This error, however, is compensated by the excessive and evidently erroneous determinations of potassium in the Nile

and in some European rivers, so that the final figures are not far out of the way. Dr. Chase Palmer, working in co-operation with Dole in the study of American waters, made more than one hundred careful determinations of the ratio between sodium and potassium in over forty rivers, and found it to be very nearly 4.2 to 1. This ratio is practically identical with that given in my general mean, namely, 4.21 to 1, and the latter is, therefore, satisfactory.

In order to apply the foregoing averages to the discussion of either chemical denudation or geological time, certain other data are needed. Some of these are general, others are of the nature of minor corrections. Professor J. Joly,<sup>1</sup> in order to determine the age of the ocean, divided its total content of sodium by the amount annually carried into it by rivers, and so deduced an uncorrected value of 97,600,000 years. The computation is simple enough, and is based upon the fact that sodium is less removed from the waters than other substances; if, indeed, it is appreciably removed at all. Calcium and magnesium are precipitated as carbonates; potassium is absorbed by clays, silica goes to form siliceous oozes. Sodium alone, among the basic elements, tends to accumulate in the ocean with little loss, and so to give some indication of its geological age.

Joly, however, employed data of a defective character. Murray's estimate of the sodium in rivers was taken, which, as we have seen, needs serious modification. For the volume of the ocean he combined Wagner's, or rather Karstens', estimate of its area with Murray's figure for its average depth, and used Dittmar's analyses for the proportion of sodium in it. The last datum is satisfactory; the others need revision.

The best estimate of the volume of the ocean is probably that of Karstens,<sup>2</sup> 1,285,935,211 cubic kilometers. This, with Murray's figure for the mean density, 1.026, gives the ocean a mass of  $1,319,650 \times 10^{12}$  metric tons. Assuming an average salinity of 3.5 per cent., the total saline matter in the ocean amounts to  $46,188 \times 10^{12}$  tons; which, according to Dittmar's analyses, is distributed as follows:

	<i>Per cent.</i>	<i>Metric tons <math>\times 10^{12}</math>.</i>
Cl .....	55.292	25,538.
Br .....	.188	86.8
SO <sub>4</sub> .....	7.692	3,553.
CO <sub>2</sub> .....	.207	95.6
Na .....	30.593	14,130.
K .....	1.106	510.8
Ca .....	1.197	552.8
Mg .....	3.725	1,721.
	100.000	46,188.0

The small traces of other substances in the ocean only represent insignificant corrections to these figures.

<sup>1</sup> Trans. Roy. Soc. Dublin (2), vol. 7, p. 23, 1899. Rep. British Asso. Adv. Sci., 1900, p. 369.

<sup>2</sup> Eine neue Berechnung der mittleren Tiefen der Oeane. Inaug. Diss., Kiel, 1894.

From the figures previously given, for the average composition of river waters and the total chemical denudation of the globe, 175,040,000 metric tons of sodium are annually discharged into the sea. The crude quotient,

$$\frac{\text{Na in ocean}}{\text{Na in rivers}} = 80,726,000;$$

the time in years needed to furnish the entire amount of marine sodium; assuming a sodium-free ocean at the start and a uniform rate of supply throughout all geological time. Any probable change in either of these assumptions will reduce the quotient, although other considerations may tend to increase it. The first correction to be examined operates in the latter direction.

A part of the sodium found in the discharge of rivers is the so-called "cyclic sodium": that is, sodium in the form of salt lifted from the sea as spray and blown inland to return again to its source in the drainage from the land. Near the sea coast this cyclic salt is abundant; inland its quantity is small. For example, by careful analyses of rainfall, continued over long periods of time, the following amounts of cyclic salt have been determined. The figures represent pounds per acre per annum of sodium chloride.

<i>Locality.</i>	<i>NaCl in rain.</i>
Rothamsted, England.....	24.
Cirencester, England.....	36.1
Perugia, Italy.....	37.95
Barbados .....	193.

In central Massachusetts, according to Mrs. Ellen S. Richards,<sup>1</sup> the cyclic salt, at distances of 50 to 100 miles from the coast, amounts to 23.2 pounds per acre per annum.

The Rothamsted figures are very suggestive. Rothamsted lies in the Thames valley, and if its figure for sodium chloride in rain be taken as a fair average for the entire drainage basin, 6100 square miles, the quantity there brought down amounts to 41,732 British tons annually, or 16,445 tons reckoned as sodium alone. Analyses of the Thames give sodium as 3.26 per cent of the total inorganic matter in solution, or, in terms of the discharge already cited, 11,872 tons. Here the cyclic sodium is nearly as much as the total amount carried by the stream; but of course one cannot assume that all of the cyclic portion finds its way back to the ocean in any brief or relatively brief time. It is enough to say that in the British islands the correction for cyclic salt must be large; while for the great continental rivers like the Mississippi, St. Lawrence, Amazon, Danube, or Nile it is very much smaller.

<sup>1</sup> Private communication. For the other figures, see Data of Geochemistry, p. 47.

It is difficult, with existing data, to evaluate the correction for cyclic sodium with any great approach to accuracy. It probably varies for different regions, but from the well-known "chlorine maps" of New England and New York, with their "isochlors," a good estimate for the United States can be made. This part of the work has been done by Dr. Becker, whose discussion of the subject appears elsewhere. Another, cruder estimate may be made as follows: If we assume with regard to the United States that the salt brought down in rain is represented by the Rothamsted figures for a strip 100 miles wide following the coast line, an area, roughly, of about 450,000 square miles, the quantity of sodium thus found amounts to 1,231,300 metric tons. Regarding the correction for the interior of the United States as zero, an assumption which is justified by a study of the isochlors, the final result may be obtained as follows: The total sodium carried by the rivers of the United States to the sea, after correcting the crude value already given in the table of analyses by Palmer's value for the Na-K ratio, amounts to, roughly, 17,500,000 tons. The cyclic sodium is only 7 per cent. of the latter quantity, whereas Joly allows 10 per cent., but the smaller figure is probably a maximum. Subtracting 7 per cent. from the total sodium carried by the rivers, 175,040,000 metric tons per annum, the remainder is 162,787,200 tons: which, divided into the sodium of the ocean gives a quotient of 86,800,000 years. Joly's correction of 10 per cent. is very nearly equivalent to the assumption that the entire run-off of the globe, 6524 cubic miles, according to Murray, carries on an average one part per million of chlorine. The chlorine maps, so far as they have been made, show this figure to be excessive.

The foregoing correction for "cyclic salt" is, however, not final. It has already been suggested that the wind-borne salt is only in part restored to the ocean, at least within reasonable time. Some of it is retained by the soil, if not permanently, at least rather tenaciously; and the portion which falls into depressions of the land may remain undisturbed almost indefinitely. In arid regions, like the coasts of Peru, Arabia, and parts of western Africa, a large quantity of cyclic salt must be so retained in hollows or valleys which do not drain into the sea. Torrential rains, which occur at rare intervals, may return a part of it to the ocean, but not all. Some writers, like Ackroyd<sup>1</sup> for example, have attributed the saline matter of the Dead Sea to an accumulation of wind-borne salt: an assumption which contains elements of truth, but is probably extreme. A more definite, but equally striking instance of the sort is furnished by the Sambhar salt lake in northern India, as studied by Holland and Christie.<sup>2</sup> This lake, situated in an enclosed drainage basin of 2200 square miles and

<sup>1</sup> Chem. News, vol. 89, p. 13, 1904.

<sup>2</sup> Records Geol. Survey India, vol. 38, p. 151, 1909.

over 400 miles inland, appears to receive the greater part, if not all of its salt from dust-laden winds which, during the four hot, dry months, sweep over the plains between it and the arm of the sea known as the Rann of Cutch. Analyses of the air during the dry season, showed a quantity of salt so carried which amounted to at least 3000 metric tons over the Sambhar lake annually, and 130,000 tons into Rajputana. These quantities are sufficient to account for the accumulated salt of the lake, which the authors were unable to explain in any other way.

Examples like this of the Sambhar lake are of course exceptional. In a rainy region salt dust is quickly dissolved and carried away in the drainage. Only in a dry period can it be transported as dust from its original point of deposition to points much further inland. It appears, however, that some salt is so withdrawn, at least for an indefinitely long time, from the normal circulation, and should, if it could be estimated, be added to the amount now in the ocean. Such a correction, however, would doubtless be quite trivial, and, therefore, negligible; and the same remark must apply to all the visible accumulations of rock salt, like those of the Stassfurt region, which were once laid down by the evaporation of sea water. The saline matter of the ocean, if concentrated, would represent a volume of over 4,800,000 cubic miles; a quantity compared with which all beds of rock salt become insignificant.

But although the visible accumulations of salt are relatively insignificant, it is possible that there may be quantities of disseminated salt which are not so. The sedimentary rocks of marine origin must contain, in the aggregate, vast amounts of saline matter, widely distributed, but rarely determined by analysis. These sediments, laid down from the sea, cannot have been completely freed from adherent salts, which, insignificant in a single ton of rock, must be quite appreciable when cubic miles are considered. The fact that their presence is not shown in ordinary analyses merely means that they were not sought for. Published analyses, whether of rocks or of waters, are rarely complete, especially with regard to those substances which may be said to occur in "traces."

It is perhaps not possible to estimate the quantity of this disseminated salt, and yet a maximum limit may be assigned to it. In a former publication<sup>1</sup> it was shown that 84,300,000 cubic miles of the average igneous rock would, upon decomposition, yield all the sodium of the ocean and the sedimentaries. This estimate involved the maximum, not the mean salinity of the ocean, and also a different value for the mass of the latter from that now adopted. In order to revise the estimate, which must be considerably reduced, it is desirable first to consider the average composition of the two classes of rocks, especially since the data are applicable to other phases of the discussion than that now under consideration.

---

<sup>1</sup> *Data of Geochemistry*, pp. 28-29.

For the average composition of the igneous rocks there are two principal estimates: Clarke's,<sup>1</sup> based upon analyses made in the laboratories of the United States Geological Survey alone, and Washington's,<sup>2</sup> which includes analyses from all parts of the world. These two composites, reduced to 100 per cent, and condensed by union of minor and unimportant constituents, assume the following form:

	<i>Clarke.</i>	<i>Washington.</i>	<i>Mean.</i>
SiO <sub>2</sub> .....	59.99	57.78	58.88
Al <sub>2</sub> O <sub>3</sub> .....	15.04	15.67	15.36
Fe <sub>2</sub> O <sub>3</sub> .....	2.59	3.31	2.95
FeO .....	3.34	3.84	3.59
MgO .....	3.89	3.81	3.85
CaO .....	4.81	5.18	4.99
Na <sub>2</sub> O .....	3.41	3.88	3.65
K <sub>2</sub> O .....	2.95	3.13	3.04
H <sub>2</sub> O .....	1.92	1.78	1.85
Minor constituents..	2.06	1.62	1.84
	100.00	100.00	100.00

In the mean the Survey analyses, of which many are included in Washington's average, evidently receive double weight.

When the average igneous rock decomposes, it loses some substances by leaching, and gains others, such as oxygen, water, and carbon dioxide. The products of decomposition, as nearly as can be estimated, are 5 per cent. limestones, 15 per cent. sandstones, and 80 per cent. the residues which consolidate to form slates and shales. The composite analyses of sedimentary rocks, made in the laboratory of the United States Geological Survey,<sup>3</sup> are given in the next table, with their weighted average recalculated to 100 per cent.

	<i>Shales.</i>	<i>Sandstones.</i>	<i>Limestones.</i>	<i>Weighted mean.</i>
SiO <sub>2</sub> .....	58.38	78.66	5.19	58.51
Al <sub>2</sub> O <sub>3</sub> .....	15.47	4.78	.81	13.07
Fe <sub>2</sub> O <sub>3</sub> .....	4.03	1.08	.54	3.40
FeO .....	2.46	.30	....	2.00
MgO .....	2.45	1.17	7.90	2.52
CaO .....	3.12	5.52	42.61	5.42
Na <sub>2</sub> O .....	1.31	.45	.05	1.12
K <sub>2</sub> O .....	3.25	1.32	.33	2.80
H <sub>2</sub> O .....	5.02	1.64	.77	4.28
CO <sub>2</sub> .....	2.64	5.04	41.58	4.93
Minor constituents.....	2.33	.45	.31	1.95
	100.46	100.41	100.09	100.00
Weight .....	80.	15.	5.	

<sup>1</sup> U. S. Geol. Surv., Bull. 419, pp. 4-9, 1910.

<sup>2</sup> U. S. Geol. Surv. Bull. 419, p. 10.

<sup>3</sup> U. S. Geol. Surv. Prof. Paper, No. 14, p. 106, 1903.

In the ocean, as previously shown, there are  $14130 \times 10^{12}$  metric tons of sodium. This amount would be supplied by the *complete* decomposition of 48,225,000 cubic miles of an igneous rock having the composition shown by Clarke's average, or 42,385,000 cubic miles on the basis of Washington's figures. Some sodium, however, is retained by the sedimentary rocks, for the reason that decomposition is rarely, if ever, perfect. Fragments or particles of feldspar are especially common in the sedimentaries. On comparing the average composition of the latter with that of the igneous rocks, assuming that alumina has remained constant, the following ratios appear:

	Clarke.	Washington.
Na <sub>2</sub> O retained, per cent.....	1.29	1.38
Na <sub>2</sub> O lost, per cent.....	2.12	2.50
	<hr style="width: 50px; margin: 0 auto;"/>	<hr style="width: 50px; margin: 0 auto;"/>
	3.41	3.88

Hence, for the total volume of igneous rock needed to furnish all the sodium of the ocean and of the sediments, assuming that the sodium lost represents the marine portion, we have:

From Clarke's average.....	77,570,000 cubic miles
From Washington's average.	65,782,000 " "

These figures correspond, respectively, to a shell of igneous rock, completely enveloping the globe, 2050 feet thick in one case, or 1740 in the other. For present purposes the higher estimate will be taken, in order that the deductions may be maxima.

If, now, the sedimentary rocks were of the same volume as the igneous rocks from which they were derived, and if the sandstones form 15 per cent. of the 77,570,000 cubic miles, the bulk of the latter will be, very roughly, 10,635,500 cubic miles. The assumptions thus made are of course not exact, but they will suffice for the computations now in hand. The errors are negligible, so far as present needs are concerned. Assume further that the sandstones, the most porous of the rocks, contain an average pore space of 20 per cent., or 2,127,100 cubic miles, and that all of it was once filled by sea water, representing 99,861,000,000,000 metric tons of sodium. If all of that sodium were now present in the sandstones, and erosion began at the rate now assigned to the rivers, namely, 175,040,000 tons of sodium annually, the entire accumulation would be removed in 570,000 years. This, compared with the estimate already reached for geological time, is an almost negligible quantity. Even if the entire volume of the sedimentary rocks carried the same proportion of sodium as is here assigned to the sandstones, it would be exhausted in about 3,800,000 years. The correction for disseminated salt is, therefore, in all probability small, and not likely to exceed 1 per cent.



The foregoing calculations, so far as geologic time is concerned, imply the assumption that rivers add sodium to the sea at an average uniform rate, slight accelerations being offset by small temporary retardations. This subject is to be discussed by Mr. G. F. Becker; but one phase of it demands consideration here. The present rate of discharge has been hastened during modern times by human agency, and that acceleration may be important to take into account. The sewage of cities, the refuse of chemical manufactures, etc., is poured into the ocean, and so disturbs the rate of accumulation of sodium quite perceptibly. The change due to chemical industries, so far as it is measurable, is wholly modern, and that due to human excretions is limited to the time since man first appeared upon the earth. Its exact magnitude, of course, cannot be determined; but its order seems to be measurable, as follows:

According to the best estimates, about 14,500,000 metric tons of common salt are annually produced, equivalent to 5,700,000 tons of sodium. If all of that was annually returned to the ocean, it would amount to a correction of about 3.25 per cent. on the total addition of sodium to the sea. The fact that much of it came directly or indirectly from the ocean in the first place is immaterial to the present discussion: the rate of discharge is affected. All of this sodium, however, is not returned; much of it is permanently fixed in manufactured articles. The total may be larger, because of other additions, excretory in great part, which cannot be estimated; but we may assume, nevertheless, a maximum of 3 per cent. as the correction to be applied. Allowing 7 per cent., as already determined, to cyclic or wind-borne sodium, and 1 per cent. to disseminated salt of marine origin, the total correction is 11 per cent. This reduces the 175,040,000 tons of river sodium to 155,785,600 tons, and the quotient representing crude geologic time becomes 90,700,000 years.

The corrections so far considered are all in one direction, and increase, by a roughly evaluated amount, the apparent age of the ocean. Other corrections, whose magnitudes are more uncertain, tend to compensate the former group. The ocean may have contained primitive sodium, over and above that since contributed by rivers. It receives some sodium from the decomposition of rocks by marine erosion, which is estimated by Joly to be a correction of less than 6 per cent. and more than 3 per cent. on the value assigned to geologic time. Sodium is also derived from volcanic ejectamenta, from "juvenile" waters, and possibly from submarine rivers and springs. The last possibility has been considered by Sollas,<sup>1</sup> but no numerical correction can be devised for it. These four sources of sodium in the sea may be grouped together as non-fluvialite, and reduce the numerator of the fraction which gives the age of the ocean. Whether

---

<sup>1</sup> Presidential address, Quar. Journ. Geol. Soc., May, 1909.

they exceed, balance, or only in part compensate the other corrections it is impossible to say. The rough quotient at first obtained, 80,726,000 years, is as probable as any other value that might be chosen. That value, as will be shown by Mr. Becker's calculations, is certainly a maximum. It represents, in its essential features, Joly's method of computing the age of the ocean, but takes, with one minor exception, no account of changes of rate in the annual additions to the marine salinity. Joly's final estimate of the age is 90,000,000 years, with a possible increase of 6 per cent. due to a revision of the mass of the ocean.

Reade, in the investigation cited at the beginning of this paper, estimated the solvent denudation of England and Wales at 143.5 British, or 146 metric tons per square mile per annum, or one foot in 12,978 years. The smaller denudation factors now found lead to different results. For the United States, excluding the Great Basin, the factor of 79 tons gives, for a lowering of one foot, 23,948 years. For South America the figures are 50 tons and 37,751 years; for Europe, 100 tons and 18,875 years and for the Nile Valley, 16 tons and 93,924 years. For the 40,000,000 square miles of the globe, which drain into the ocean, the average values are 68.4 tons and 27,660 years, estimates that are subject to large corrections, which Reade did not take into consideration. The foregoing figures only apply to his method of computation.

On critical examination of the data it is clear that the total apparent amount of solvent denudation is not a true measure of rock decomposition. In the general mean of all the river analyses now under discussion, 0.90 per cent. of  $\text{NO}_3$  and 35.15 per cent. of  $\text{CO}_3$  appear. The  $\text{NO}_3$  came entirely or practically so from atmospheric sources; the  $\text{CO}_3$  was derived partly from the atmosphere and partly from the solution of limestones. Dealing now only with the existing discharge of rivers, we must subtract these atmospheric additions from the total annual load of dissolved inorganic matter, before we can compute the real amount of rock denudation.

The land surface of the earth is covered, nearly enough for present purposes, by 75 per cent. of sedimentary and 25 per cent. igneous and crystalline rocks;<sup>1</sup> and it is on or near this surface that the flowing waters act. The limestones, as shown in my former discussion, constitute only one-twentieth of the sediments, or 3.75 per cent. of the entire area; but the proportion of carbonates derived from them must be very much larger. The composite and average analyses of rocks give, for lime, 4.81 per cent. in the igneous, and 5.42 in all the sedimentaries, equivalent to 3.78 and 4.26 per cent. of  $\text{CO}_2$  respectively. Assuming that all the surface rocks yield lime at an equal rate, which is obviously not quite true, and multiplying these figures by the areas represented as 1 to 3, the

---

<sup>1</sup> Estimate by A. von Tilló, actually 75.7 and 24.3.

relative proportions of the CO<sub>2</sub> radicle become 3.78:12.78, or 1:3.4 nearly. The last figure should be higher, because of the more rapid solution of the limestones, but if we accept the ratio as it stands we may use it to determine the approximate proportions of the CO<sub>2</sub> radicle derived from limestones and from the atmosphere acting upon crystalline rocks. On this basis, 8 per cent. of CO<sub>2</sub> should be deducted from the percentage in the river waters, together with the 0.9 per cent. of NO<sub>3</sub>. Making the subtraction from the total river load of dissolved matter, 2,735,000,000 tons, there remains 2,491,585,000 tons, or about 62.3 tons per square mile on the average, for the 40,000,000 of square miles of land which are assumed to drain into the ocean. This implies a lowering of the land by solvent denudation at the rate of one foot in 29,941 years, or 30,000 in round numbers. The last estimate may be subject to large future corrections, but probably it is correct to within 10 per cent.

It is possible, with the data now in hand, to take still another step and determine approximately the quantity of *chemical* sediments annually precipitated in the ocean. For this purpose we may first, knowing the average composition of river waters, and also their total load of dissolved inorganic matter, compute the actual amount of each radicle poured into the ocean in one year. The total amount so added is 2,735,000,000 metric tons, distributed as follows:

CO <sub>2</sub> .....	961,350,000 tons
SO <sub>4</sub> .....	332,030,000 "
Cl .....	155,350,000 "
NO <sub>3</sub> .....	24,614,000 "
Ca .....	557,670,000 "
Mg .....	93,264,000 "
Na .....	175,040,000 "
K .....	41,299,000 "
R <sub>2</sub> O <sub>3</sub> .....	75,213,000 "
SiO <sub>2</sub> .....	319,170,000 "
	2,735,000,000 "

If, from each of these quantities we subtract the amount annually retained in solution by the sea, the difference will represent the amount precipitated. To do this, an assumption must be made as to the age of the ocean; but whatever probable figure is thus assumed, the results will be of the same order of magnitude. For example, the ocean contains  $552.8 \times 10^{12}$  metric tons of dissolved calcium, which quantity, divided by the assumed age, gives the annual increment. If the age of the ocean is 100,000,000 years, the annual addition of calcium is 5,528,000 tons; if only 50,000,000 years it is 11,056,000 tons. Subtracting these quantities from the total calcium of the river waters the remainders become 552,-142,000 and 546,614,000 tons respectively, the difference being much less

than the actual uncertainties of the computation. If, for the sake of uniformity, we take as the crude age of the ocean the quotient first obtained, 80,726,000 years, the chemical precipitates are represented by the following annual quantities:

SO <sub>4</sub> .....	288,017,000	metric tons
Ca .....	550,822,000	" "
Mg .....	71,945,000	" "
K .....	34,971,100	" "
R <sub>2</sub> O <sub>3</sub> .....	75,213,000	" "
SiO <sub>2</sub> .....	319,170,000	" "

Combined, the radicles thus precipitated in the ocean, yield the following substances:

Gypsum, CaSO <sub>4</sub> . 2H <sub>2</sub> O.....	516,020,000	metric tons
Calcium carbonate, CaCO <sub>3</sub> ..	1,077,030,000	" "
Magnesium carbonate, MgCO <sub>3</sub>	249,587,000	" "
Limonite, <sup>1</sup> 2 Fe <sub>2</sub> O <sub>3</sub> . 3H <sub>2</sub> O..	87,505,000	" "
Silica, SiO <sub>2</sub> .....	319,170,000	" "

The potassium remains unaccounted for. Part of it is taken up by the clay-like substances in the oceanic silts, and part goes to form glauconite; but it is not worth while to speculate upon the relative proportions of potassium withdrawn by these two processes from solution.

The figures given above for the quantities of the five chemical precipitates annually deposited in the ocean can, of course, make no pretense to accuracy. They are merely rough approximations to the truth, but they tell something of the relative magnitudes. Even if we knew precisely the age of the ocean, it would not be practicable to reckon backward and so to determine the total mass of deposits formed during geological time. The figures tell us what is happening to-day, but are inapplicable to the past. The reason for this statement is, that apparently the different deposits have formed at different rates. In the beginning of chemical erosion fresh rocks were attacked, and relatively more silica and less lime passed into solution. At present, limestones, laid down in previous geologic ages, are being dissolved, and calcium is added to the ocean more rapidly than in pre-Cambrian times. This is not mere speculation. A study of river waters with reference to their origin, whether from crystalline or sedimentary rocks, fully justifies my assertions.

The vexed question as to the source of oceanic chlorine, I have so far left out of consideration. Dr. Becker has shown that volcanic agencies are adequate to account for it. Some, however, may have come from ferrons chloride, lawrencite, a compound which is common in meteoric irons. If our planet is analogous to a great meteorite, lawrencite must

<sup>1</sup> Assuming R<sub>2</sub>O<sub>3</sub> to be all Fe<sub>2</sub>O<sub>3</sub>. It is certainly, in part, Al<sub>2</sub>O<sub>3</sub>.

exist in it, and was possibly, in early geologic periods, leached into the ocean in large amounts. Its iron would be precipitated by the alkaline carbonates of river waters, while chlorides of the alkaline metals were produced. Dr. Becker, however, inclines to regard deeply buried lawrencite as the origin of volcanic chlorine, and it is possible that the great mass of this ferrous chloride underlay the specifically lighter primeval rocks. It is also conceivable that the earliest crystalline rocks were richer in easily decomposable minerals like sodalite than the surface rocks of to-day, and, therefore, added more chlorine to the ocean than is leached into it now. Such rocks, if they existed, would be more rapidly eroded than the less soluble species, and, consequently, less abundant at the present time. A primitive atmosphere, rich in chlorine, and an ocean of weak hydrochloric acid may have once existed, but their assumption is by no means necessary in order to account for the known facts.

This memoir is entitled "A Preliminary Study of Chemical Denudation." It has been written in order to make existing data more available for discussion, and to point out the deficiencies in our knowledge. If it stimulates investigation; if it leads others to the examination of the greater Asiatic, African, South American and Australian rivers, or to more extended studies of the chemistry of rainfall, its main purpose will be fulfilled. The assumptions which it is now necessary to make ought to be replaced by definite evidence of a sort which is easily obtainable.<sup>1</sup>

---

<sup>1</sup> Published by permission of the Director of the United States Geological Survey. Becker's memoir, to which references have been made, appears simultaneously with this paper.

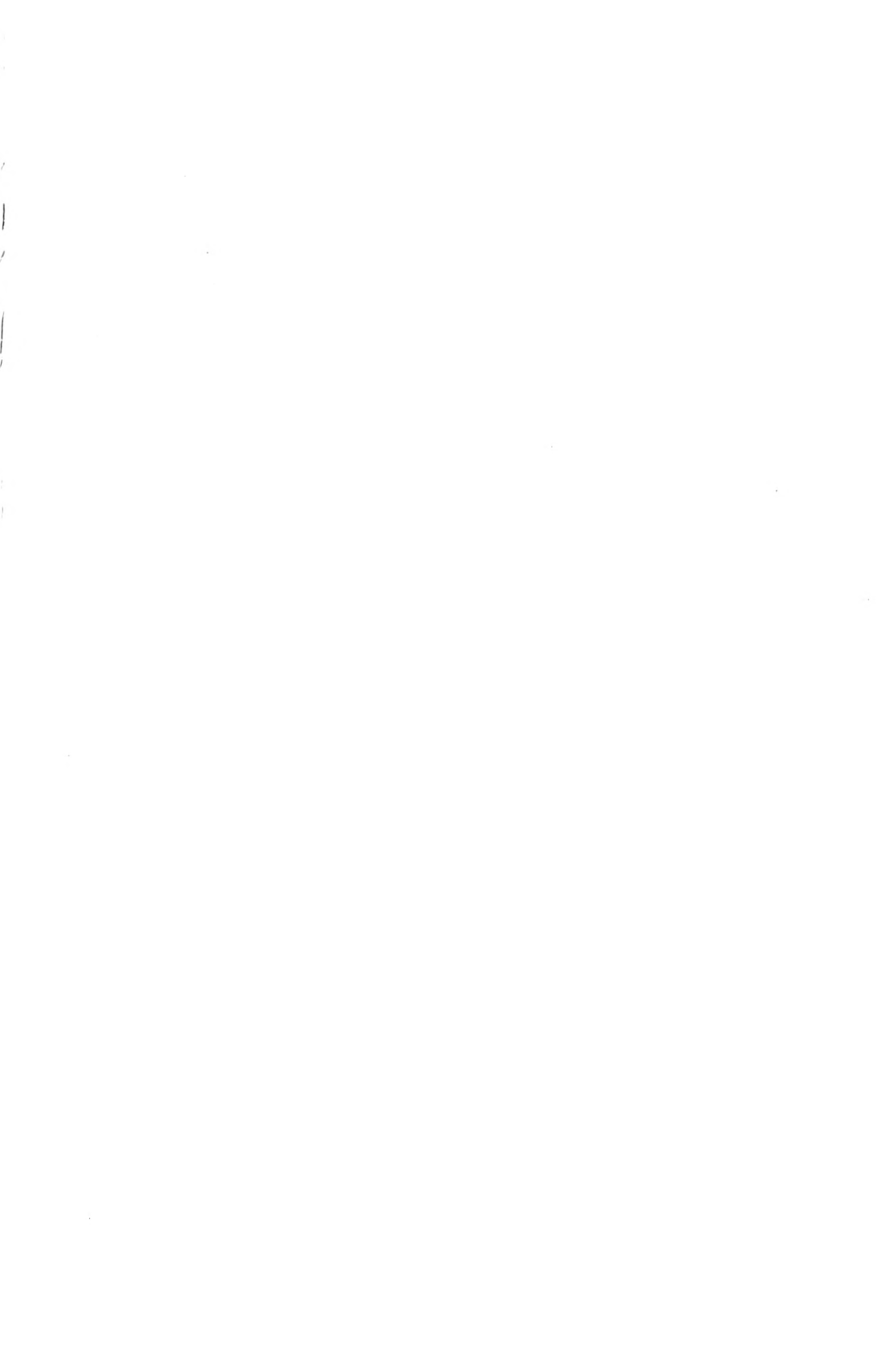



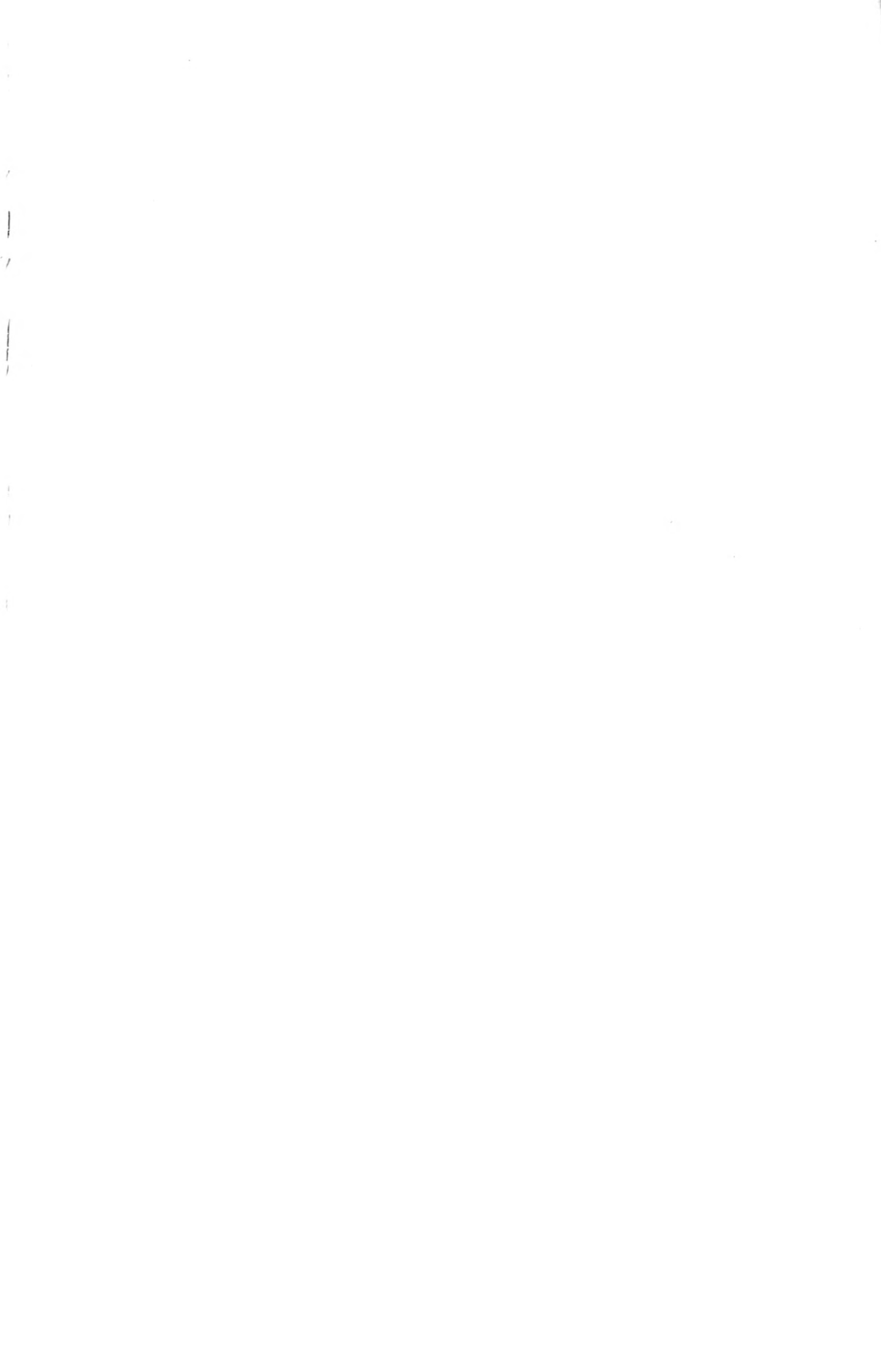



SMITHSONIAN MISCELLANEOUS COLLECTIONS

VOLUME 56, NUMBER 6

# THE AGE OF THE EARTH

BY

GEORGE F. BECKER



(PUBLICATION 1936)

CITY OF WASHINGTON  
PUBLISHED BY THE SMITHSONIAN INSTITUTION  
JUNE, 1910

The Lord Baltimore Press  
BALTIMORE, MD., U. S. A.

# THE AGE OF THE EARTH

BY GEORGE F. BECKER

## CONTENTS

	PAGE
Introductory Review .....	1
Age from Sodium Accumulation.....	6
The data .....	6
Increment of oceanic sodium.....	6
Results of asymptotic accumulation.....	11
Age from Refrigeration.....	17
Historical note .....	17
Modified problem .....	19
Numerical results .....	24
Conclusions .....	27

## INTRODUCTORY REVIEW

The birthday of the world known to us is commonly regarded as coinciding with the epoch of Leibnitz's *consistentior status*.<sup>1</sup> This great philosopher believed that the earth solidified from a state of fusion by stages similar to those he had observed in the refrigeration of large masses of metal: cavities analogous to blow-holes developed and burst; thin partial crusts formed and broke; in some cases such crusts were extensive enough and sufficiently cool to receive bodies of water, but were not strong enough to support the accumulated liquid and presently gave way, so that fresh convulsions ensued. At length, through the progress of refrigeration, the globe emerged into "a state of greater consistency." Then chaos was at an end and permanent oceans became possible.

It is interesting to note that Leibnitz seems to have had in mind not merely dry fusion, but fusion with the co-operation of water, or what would now be called aqueigneous fusion.

Three methods have been devised for ascertaining the age of the ocean: one from the accumulation of stratified rocks; another from chemical denudation; and the third from the progress of refrigeration. Closely allied to these is Sir George Darwin's discussion of the lapse of time since the earth and the moon parted company.<sup>2</sup>

<sup>1</sup> Protogaea, 1749. A sketch of this posthumous work appeared in the *Acta Eruditorum*, Jan., 1693.

<sup>2</sup> *Phil. Trans.*, London, vol. 170, 1879, p. 511; and vol. 171, 1880, p. 882.

A faultless mode of arriving at the ocean's age is perhaps unattainable, though better ways than are now available may possibly be elaborated hereafter. All that can be hoped for at present is that diverse methods may lead to estimates of the same order of magnitude; and such a result is more important just now than ever before. By physical reasoning geologists have been compelled to adopt a moderate estimate of geological time. Of late, however, physicists engaged in studies of radioactivity have reached the conclusion that certain uranium minerals are of an enormous age, which is estimated by simple though tremendous extrapolation. If geologists can now give convincing reasons for adhering to ages within a hundred million years, or even within two hundred, they may partly repay the heavy debt due by them to Kelvin and his intellectual heirs.

So long ago as 1860 John Phillips,<sup>1</sup> the originator of the mechanical theory of slaty cleavage, estimated that the time required for the deposition of the stratified rocks lay between 38 and 96 million years. So far as my reading goes, this was the only reasonable estimate prior to Kelvin's truly epoch-making paper of 1862.<sup>2</sup> During the last 20 years much energy has been expended upon the study of the maximum thickness of strata and the time-rate of their deposition. In 1890 de Lapparent thus estimated a period of from 67 to 90 millions of years.<sup>3</sup> The most careful investigation of this kind yet made is due to Mr. Charles D. Walcott who, in 1893, carried out minute and cautious studies of the rate of deposition and of the amount of accumulation, both mechanical and chemical.<sup>4</sup> His estimate for the lapse of time since the base of the Cambrian is 27,640,000 years and he allows for the Algonkian a period of 17,500,000 years. As a matter of course this last figure rests on extremely imperfect data and should probably be increased. Mr. Walcott considered 70 millions the maximum age. In 1899 Sir Archibald Geikie stated that, so far as he was able to form an opinion, 100 million years would suffice for the formation of the stratified rocks,<sup>5</sup> and in 1900 Mr. W. J. Sollas, assuming a constant rate of deposition, reached an age of 26½ million years.<sup>6</sup> In 1909 Mr. Sollas increased this estimate to nearly 34 million years,<sup>7</sup> but in view of erosions and the uncertainties involved he inclines to believe, as do many others, that the pre-Cambrian sediments took as much time for their deposition as those from the base of the Cambrian to the top of the column. Making also an allowance for gaps, he thinks the stratigraphical column, if complete, might indicate 80 million years. He draws especial

<sup>1</sup> "Life on the Earth," etc., 1860, p. 119.

<sup>2</sup> Trans. Roy. Soc. Edinburgh and Thomson and Tait, Nat. Phil., Pt. II, p. 468.

<sup>3</sup> Bull. Soc. Géol. de France, vol. 18, 1890, p. 351.

<sup>4</sup> Journal of Geol., vol. 1, 1893, p. 675.

<sup>5</sup> Brit. Assoc. Adv. Sci., 1899, p. 727.

<sup>6</sup> Brit. Assoc. Adv. Sci., 1900, p. 711.

<sup>7</sup> Mr. Sollas assumes a constant rate of deposition of one foot per century and thinks most geologists would incline to a higher rate. Quart. Jour. Geol. Soc. London, vol. 65, 1900, p. CXII.

attention to the discrepancy between stratigraphical estimates and those from sodium accumulation in the ocean. If Mr. Walcott's estimate for time since the base of the Cambrian be doubled, in accordance with the opinions stated above, it gives 55 million years.

The introduction into modern geology of estimates founded on chemical denudation is due to T. Mellard Reade,<sup>1</sup> but Mr. J. Joly was the first to show that sodium is the only element which can be trusted to afford good estimates of the lapse of time involved in denudation. Adopting the hypothesis that the sodium content of the ocean is derived at a constant rate from that of the rocks, Mr. Joly, in 1899, arrived at an age of between 80 and 90 million years, and this he increased by 10 million in 1900.<sup>2</sup> In 1909 Mr. Sollas made a very searching inquiry into this subject, availing himself of much material published since Mr. Joly's papers, and, on the same hypothesis of uniformity, placed the age of the ocean between 80 million and 150 million years.<sup>3</sup>

Very curiously, the great astronomer Edmund Halley nearly 200 years ago devised a method of determining the age of the ocean from the amount of salt which it contains.<sup>4</sup> He recognized that the means he proposed for determining the annual increment of salt were impracticable and, writing long before Lavoisier was born, could not have guessed that analysis of river waters would become a simple matter. It is not strange that Halley's paper was completely forgotten, but it is now of such interest and is so inaccessible to a majority of geologists that an extract from it will not be regarded as out of place here.

*A short Account of the Cause of the Saltness of the Ocean, and of the several Lakes that emit no Rivers; with a Proposal, by help thereof, to discover the Age of the World.*

There have been many attempts made and proposals offered, to ascertain from the appearances of nature, what may have been the antiquity of this globe of earth; on which, by the evidence of sacred writ, mankind has dwelt about 6000 years; or according to the Septuagint above 7000. . . . This inquiry seeming to me well to deserve consideration, and worthy the thoughts of the Royal Society, I shall take leave to propose an expedient for determining the age of the world by a medium, as I take it, wholly new, and which in my opinion seems to promise success, though the event can not be judged of till after a long period of time; submitting the same to their better judgment. What suggested this notion was an observation I had made, that all the lakes in the world, properly so called, are found to be salt, some more some less than the ocean sea, which in the present case may also be esteemed a lake; since by that term I mean such standing waters as perpetually receive rivers running into them, and have no exit or evacuation. . . .

<sup>1</sup> Proc. Liverpool Geol. Soc., vol. 3, 1876, p. 211.

<sup>2</sup> Trans. Roy. Soc. Dublin, vol. 7, 1899, p. 23; and Brit. Assoc. Adv. Sci., 1900, p. 334.

<sup>3</sup> Quart. Jour. Geol. Soc. London, vol. 65, 1909, p. CXII.

<sup>4</sup> Phil. Trans., vol. 29, 1715, p. 296. See also Science, vol. 31, 1910, p. 459.

Now I conceive that as all these lakes do receive rivers and have no exit or discharge, so it will be necessary that their waters rise and cover the land, until such time as their surfaces are sufficiently extended, so as to exhale in vapor that water that is poured in by the rivers; and consequently that lakes must be bigger or lesser, according to the quantity of the fresh they receive. But the vapors thus exhaled are perfectly fresh; so that the saline particles that are brought in by the rivers remain behind, while the fresh evaporates; and hence it is evident that the salt in the lakes will be continually augmented, and the water grow salter and salter. . . .

Now if this be the true reason of the saltness of these lakes, it is not improbable but that the ocean itself is become salt from the same cause, and we are thereby furnished with an argument for estimating the duration of all things, from an observation of the increment of saltness in their waters. For if it be observed what quantity of salt is at present contained in a certain weight of the water of the Caspian Sea, for example, taken at a certain place, in the driest weather; and after some centuries of years the same weight of water, taken in the same place and under the same circumstances, be found to contain a sensibly greater quantity of salt than at the time of the first experiment, we may by the rule of proportion, take an estimate of the whole time wherein the water would acquire the degree of saltness we at present find in it.

And this argument would be the more conclusive, if by a like experiment a similar increase in the saltness of the ocean should be observed: for that, after the same manner as aforesaid, receives innumerable rivers, all which deposit their saline particles therein; and are again supplied, as I have elsewhere shewn, by the vapors of the ocean, which rise therefrom in atoms of pure water, without the least admixture of salt. But the rivers in their long passage over the earth do imbibe some of the saline particles thereof, though in so small a quantity as not to be perceived, unless in these their depositories after a long tract of time. And if upon repeating the experiment, after another equal number of ages, it shall be found that the saltness is further increased with the same increment as before, then what is now proposed as hypothetical would appear little less than demonstrative. But since this argument can be of no use to ourselves it requiring very great intervals of time to come to our conclusion, it were to be wished that the ancient Greek and Latin authors had delivered down to us the degree of the saltness of the sea, as it was about 2000 years ago; for then it can not be doubted but that the difference between what is now found and what then was, would become very sensible. I recommend it therefore to the Society, as opportunity shall offer, to procure the experiments to be made of the present degree of saltness of the ocean, and of as many of these lakes as can be come at, that they may stand upon record for the benefit of future ages.

If it be objected that the water of the ocean, and perhaps of some of these lakes, might at the first beginning of things, in some measure contain salt, so as to disturb the proportionality of the increase of saltness in them, I will not dispute it; but shall observe that such a supposition would by so much contract the age of the world, within the date to be derived from the foregoing argument, which is chiefly intended to refute the ancient notion, some have of late entertained, of the eternity of all things; though perhaps by it the world may be found much older than many have hitherto imagined.

Ever since the publication of Mr. Joly's papers Mr. F. W. Clarke and I have been deeply interested in his method and in chemical denudation. A

portion of the large mass of data accumulated during the past decade has been determined at our suggestion, though most of the hydrological work of the U. S. Geological Survey, including the very numerous analyses executed under the charge of Mr. R. B. Dole, has formed part of a systematic effort to develop the mineral resources of the Commonwealth. In pursuance of our common aim Mr. Clarke has now completed a review of all available data, not only for the United States but for the world, and his paper is published by the Smithsonian Institution under the title, "A Preliminary Study of Chemical Denudation."<sup>1</sup> His results form the basis of a discussion of the age of the ocean which will be presented below.

Kelvin in 1862 first discussed the age of the earth considered as a cooling body. His results were for some years received with sorrow and indignation by most geologists and especially by evolutionists, who then desired unlimited time in which to effect the development of species. More mature study has convinced the scientific world that there is no necessary discrepancy between Kelvin's 20 to 400 million years, with a probable 98 million, and the conclusions of geologists or paleontologists. In 1893 Clarence King, with the aid of Mr. Carl Barus, introduced the important criterion of tidal stability and reached the conclusion that 24 million years best represented the conditions.<sup>2</sup> This result was accepted by Kelvin in 1897<sup>3</sup> and he then placed the limits at 20 and 40 million years. The earths considered had uniform initial temperatures. In 1908 I showed that such a distribution of temperature necessarily involved a prolonged period of tidal instability and discussed a globe the initial temperature of the outer shell of which increased in simple proportion to the distance from the surface.<sup>4</sup>

Only Sir George H. Darwin has discussed the age of the earth from a purely astronomical point of view. From his theory of the earth-moon system he derived an estimate of more than 56 million years which for a long time stood rather alone between groups of higher and lower figures.

In the succeeding pages will be found my discussion of Mr. Clarke's data and also a revised edition of my paper on the age of the earth as determined from refrigeration. The two arguments accord remarkably well.

---

<sup>1</sup> Smithsonian Miscellaneous Collections, vol. 56, No. 5, 1910.

<sup>2</sup> Amer. Jour. Sci., vol. 45, 1893, p. 1.

<sup>3</sup> Trans. Victoria Inst., vol. 31, 1899, p. 11.

<sup>4</sup> Science, vol. 27, 1908, p. 227.

## AGE FROM SODIUM ACCUMULATION

## THE DATA

For comparison with the results of radioactive studies age determinations from chemical denudation have an advantage over those from refrigeration, because decomposition of the rocks is only remotely affected by thermal action and radioactivity. Mr. Joly's method of finding the age of the ocean consists substantially in dividing the total sodium content of the ocean by the amount of sodium annually poured into it by the the rivers. The result is corrected for wind-borne sodium and marine denudation. I cannot agree that this quotient is the required age, but before discussing that matter it is essential to ascertain as nearly as possible the numerator and the denominator of Mr. Joly's ratio.

Mr. Clarke's new discussion has already been referred to and he has been kind enough to furnish me with the following data. The total sodium content of the ocean is  $14,130 \times 10^{12}$  metric tons. The annual uncorrected sodium increment escaping from the rivers is  $175 \times 10^6$  tons. The river-borne unchloridized sodium is  $62.57 \times 10^6$  tons. The amount of average igneous rock needed to supply the total sodium of the ocean is  $48.225 \times 10^6$  cubic miles, while the amount of rock necessary to supply both this and the sodium retained as silicates (mostly feldspars) in the sedimentaries would occupy  $77.510 \times 10^6$  cubic miles. This would make a shell 2,050 feet thick enveloping the globe. These figures I shall accept.

## THE SODIUM INCREMENT.

To the order of accuracy required for the purposes of this paper there is little difficulty in finding a correction for wind-borne sodium. The normal distribution of chlorine throughout New England and New York has been studied in considerable detail and the results are stated in Mr. Daniel D. Jackson's paper on this subject.<sup>1</sup> Nearly all of the normal chlorine of this region is due to wind-borne sea-salt and I find by examination of typical cross-sections of the chlorine charts that the total chlorine is fairly represented by supposing the coastal value of six parts per million to be constant for 20 miles inland and there to vanish.<sup>2</sup> The waters examined for normal chlorine were by preference surface waters, and since the region has a rainfall of 45 inches with no excessive evaporation, it seemed probable that if the rain from appropriate rain gauges had been bottled periodically, the collected precipitation would show substantially

<sup>1</sup> Jackson, D. D., The normal distribution of chlorine in the natural waters of New York and New England: Water-Supply Paper U. S. Geol. Survey, No. 144, 1905.

<sup>2</sup> The means employed was to plot a typical cross-section, adapt to the observed points a logarithmic curve, and take its area from the shore to a distance theoretically infinite. The section selected as representative passed through Rye, N. H., and bore N. 65 W. The method is capable of much elaboration.



the normal chlorine. Inquiry of Mrs. Ellen S. Richards as to the chlorine of the rainfall in Massachusetts confirmed this view. The assumed relation leads at once to the amount of wind-borne sodium along a length of coast of about 500 miles; and supposing the total length of the coast of the United States (without counting indentations) to be 4,500 miles, the order of magnitude of the correction required is 6 per cent. Mr. Clarke from different data and by a different course of reasoning estimates this correction at 7 per cent.

Applying a 6 per cent. correction reduces the annual river-borne sodium of the world an eighty-six millionth part of the oceanic sodium, or to  $164.5 \times 10^6$  tons, of which more than half is combined with chlorine.

The origin of oceanic chlorine has long been regarded as mysterious. Average rock contains less than 2 per cent. of the chlorine needed to convert the accompanying sodium into chloride, and this has led to hypotheses of a primitive atmosphere heavily charged with chlorine or to an original solid surface containing great quantities of ferrous chloride. It may still be needful to seek such explanations, yet they seem to me highly unsatisfactory. From the base of the Cambrian onward some animal forms, such as *Lingula*, have persisted practically without change, and there is every paleontological indication that Paleozoic sea-water was a medium substantially like that of to-day. Had the sea been overcharged with chlorine in any form, consequences of this fact would almost certainly have manifested themselves in the composition of sediments and the decomposition of rocks, but nothing known to me indicates any unfamiliar chemical conditions. In the absence of such proofs it seems unreasonable to assume a Cambrian ocean essentially different from that of to-day. Now the ordinary geological estimate of the age of Cambrian strata is something like 30 million years; and during that period some 30 million times 63 million tons of unchloridized sodium, or perhaps considerably more than this, has been poured into the sea. All of this sodium has found chlorine to saturate it, once and a half its own weight of chlorine. Where can all this have come from?

We all know definitely that volcanoes and solfataras emit free chlorine, chlorhydric acid, ammonium chloride, calcium chloride and sodium chloride. Hot springs and certain cold springs also emit some of these, especially calcium chloride. So abundant is chlorhydric acid in the emanations of Vesuvius that according to Mr. Suess<sup>1</sup> vegetation has been blasted over large areas by acid rain, and according to Mr. Stoklasa<sup>2</sup> the greater part of the "pine-tree" clouds above the crater of Vesuvius during eruptions consists of chlorides, mainly ammonium chloride. Other volcanoes send out similar emanations and since there are hundreds of

<sup>1</sup> Ueber heisse Quellen: Verhandl. Gesell. deutsch. Naturf. und Aerzte, 1902, p. 113.

<sup>2</sup> Ber. Deutsch. chem. Gesell., vol. 39, 1906, p. 3530.

volcanoes and thousands of solfataras the total output must be very large. Cold chloride springs are not uncommon and are widely distributed at points far distant from volcanic centers.

Thus the question arises whether it is absurd to suppose that the chlorine product of volcanoes and solfataras is sufficient to saturate the unchloridized river sodium. It may be fanciful to subject such an hypothesis to computation, but this seems to me the only way to judge whether or not an absurdity is involved. Suppose then that all the chlorine were emitted as chlorhydric acid. The unchloridized river sodium being taken at  $62.57 \times 10^6$  metric tons each year would require very nearly  $100 \times 10^6$  tons chlorhydric acid. If this amount of gas were to issue from a single vent, at a temperature of  $200^\circ$  and a corresponding pressure of 6.62 kilograms per square centimeter into atmosphere at  $0^\circ$ , the opening would emit  $29 \times 10^6$  metric tons per square meter per annum.<sup>1</sup> Thus the area of the vent required would be  $100/29$  or less than  $3\frac{1}{2}$  square meters, so that (neglecting friction) 1000 vents each of  $6\frac{1}{2}$  cm. diameter working continuously would emit it all.<sup>2</sup> Considering the many violent eruptions of volcanoes and the large number of solfataras, a chlorhydric acid production of 100 million tons does not seem at all impossible. If the entire amount were uniformly distributed over the globe and reached the surface in a rainfall of one meter, this precipitation would contain less than a fifth of a millionth part of chlorine. Such an amount of chlorine would be recorded by hydrologists as "a trace."

Since the only known sources of chlorine are volcanoes and juvenile waters and these sources of supply are not manifestly insufficient, I consider it fair to conclude that the juvenile chlorine is and has been since the Cambrian about equivalent to the sodium set free from the rocks. Doubtless there have been variations in the relations between these two elements which were considerable from the point of view of the hydrologist, but they were, apparently, not great enough to unfit the ocean for the abode of a salt water fauna,<sup>3</sup> or to characterize its geochemical behavior.

What the conditions were which prevailed before the Cambrian is naturally more uncertain, but I do not believe that a primitive acid ocean should be invoked until probable explanations involving juvenile chlorine have been exhausted. If the earth is an aggregate of meteorites, many of them siderolites, charged, as Mr. Clarke has suggested, with lawrencite, it seems to me natural to suppose that most of this chloride, whose density is nearly 3, would be deeply buried beneath the lighter

<sup>1</sup> Cf. Ch. Briot, *Théorie Méc. de la Chaleur*, 2d ed., 1883, Section 113.

<sup>2</sup> The present pig-iron production is about 60 million long tons and the weight of air which must be blown into the blast furnaces producing this amount of pig is about 320 million long tons.

<sup>3</sup> Possibly fluctuations in the composition of sea-water may have affected the rate of evolution of organisms or limited their survival.

siliceous rocks. Its gradual decomposition might yield chlorine, and no other equally probable origin for the chlorine of volcanoes or deep springs is known.

Assuming that the supply of juvenile chlorine not combined with sodium is sufficient to maintain the present ratio of chlorine to bases in the ocean, it is possible to account for a part of the river-borne sodium chloride. Of the volcanic chlorine substantially 3/4 must fall into the sea and if this were exactly equivalent to the unchloridized river sodium, the volcanic chlorine precipitated on the continental areas would suffice to chloridize one-third as much sodium as escapes chloridation until it reaches the ocean. Furthermore, in the present ocean there is about one and a seventh times as much chlorine as is needed to combine with oceanic sodium. On the hypothesis suggested this should also be the case on land. Thus if the unchloridized river sodium is  $62.57 \times 10^6$  tons, the volcanic chlorine should be equivalent to the following amount of sodium:

$$\frac{8}{7} \times \frac{4}{3} \times 62.57 \times 10^6 = 95 \times 10^6 \text{ tons}$$

The chlorine equivalent of this sodium equally distributed over the earth's surface and dissolved in a rainfall of  $R$  meters would give a normal chlorine content

$$C = \frac{0.2864}{10^6 R}$$

so that if the rainfall were one meter, the normal chlorine content at inland stations would be less than 3/10 of one part per million. It is to be desired that analyses of the rainfall should be made at a well distributed set of stations for many purposes, one of them being to ascertain what is the normal chlorine of the rainfall. This, however, may vary from year to year.

The total river-borne sodium less 6 per cent. for cyclic sodium is  $164.5 \times 10^6$  tons. About 2 per cent. of this amount is covered by the chlorine of the rocks and, according to the hypothesis of volcanic chlorine set forth above,  $95 \times 10^6$  tons more is thus accounted for. The sum of the two items amounts to over  $98 \times 10^6$  tons, but leaves no less than  $66 \times 10^6$  tons of river-borne sodium, or 40 per cent. of the total, which is chloridized but the chlorine of which has not yet been traced.

There is no doubt that a part of this sodium chloride is juvenile and that another portion is what may be called *secular*. Sediments at their first emergence from the ocean are saturated with salt water and any porous rocks, particularly sandstones, if temporarily submerged are recharged with salt water. Well compacted sands contain approximately 20 per cent. of interstitial space, and it is easy to compute that the whole mass of sandstones must originally have contained highly important

quantities of sodium chloride. On the other hand, a large part of the strata have been exposed to the leaching of vadose waters for so many million years that it is difficult to imagine how they can still retain any secular salt. The subject of juvenile sodium chloride is perhaps even more obscure. That many volcanic springs and many springs originating far below the stratified rocks bring ready-made sodium chloride to the surface is certain. Even where there are now no springs of this description, there may have been such at comparatively recent geological dates.

That sedimentary rocks do actually carry large quantities of disseminated salt seems to me fully established by the recent work of the hydrologists, in particular that of Mr. Dole. They have left no doubt that waters flowing through stratified rocks carry far more chlorine than those from massive drainage basins, and it is beyond question that this excess of chlorine is combined with alkalis. I have only very lately learned to appreciate the facts, and have previously erred in supposing the disseminated salt of the sedimentaries unimportant.

There seems to me the best reason to suppose that the origin of disseminated salt in strata is open to investigation. Careful chemical work on sufficiently numerous specimens should show whether the compounds associated with the salt are those to be expected from sea-water or those characteristic of deep springs, and at least a rough estimate of the proportion of secular sea-salt should be attainable.

At present I see but one way in which to form any opinion as to the division of the questionable  $66 \times 10^6$  tons of sodium into secular and juvenile portions. Mr. Clarke has shown that a shell of average igneous rock enveloping the globe and 2050 feet thick would yield all the sodium of the ocean and the unchloridized sodium of the sedimentaries, and this result is confirmed by computation from the magnesium contents. If the continental area has always been as large as now, Clarke's shell would make a continental layer four times as thick, or 8200 feet. Thus if there were no juvenile sodium the total denudation of massive rocks, since the waters under the heaven were first gathered together unto one place and dry land appeared, would slightly exceed a mile and a half. Considering the vast well-demonstrated erosions, this figure is by no means startling. If the whole  $66 \times 10^6$  tons were juvenile, the layer would reduce to 60 per cent. of 8200 feet, or to 9/10 of a mile, a depth considerably smaller than that of the deepest part of the Grand Cañon of the Colorado. As a field geologist I should unhesitatingly reject any train of reasoning however plausible which led to so low an estimate as this of the total denudation. Some juvenile sodium there certainly is, but it seems to me that this must form but a small part of the  $66 \times 10^6$  tons.

To be on the safe side I shall estimate the age of the ocean on two

hypotheses each of which seems extreme, first that all of the questionable amount of sodium is secular and second that two-thirds of it are juvenile.

Before proceeding to these estimates, however, it is necessary to consider other uncertainties. At the present day the continent of North America stands above its average level, and this state of things appears to prevail in the other continents as well. The effect is to increase the potential of the streams and to hasten erosion. Again, the last glacial period is recent; and the ice has laid bare great areas of feldspathic rocks, which are thus more open to weathering than they were during the Tertiary. For this reason the yield of sodium per unit area must be above the mean for drainage basins including glaciated areas. Corrections for these conditions would tend to increase estimates of the earth's age. Finally, marine erosion needs consideration. The abrasive effect of the waves and tides on rock fragments and pebbles between high and low water marks is intense and world-wide, but the average width of beach is very small, much smaller than it would be were the continents to subside even a couple of hundred feet, and smaller than the mean width for the ocean's history. The sodium extracted by the waves is not represented in the figures for the rivers and a correction for marine erosion would tend to decrease estimates of the earth's age, or to offset the corrections for glaciation and high level. It is to be hoped that means may be found of evaluating the algebraic sum of these corrections, but I know of none; I cannot even guess its sign and must assume it to be zero.

Supposing none of the river-borne sodium to be juvenile the annual sodium increment is  $98 \times 10^6$  tons and the ratio of the total oceanic sodium to this increment is  $144.2 \times 10^6$ . This number of years would be the corresponding age of the ocean if Mr. Joly's method of estimation were adopted. Strictly speaking, the age should be somewhat greater, because the whole of the secular sodium still remaining in the rocks ought to be credited to the total oceanic sodium; but it is difficult to imagine that this could have any substantial influence on so huge a total as  $14 \times 10^{15}$  tons. On the second hypothesis, that  $44 \times 10^6$  tons of sodium are juvenile, the increment would be  $142 \times 10^6$  tons and the ratio  $99.5 \times 10^6$  provided that no allowance is made for juvenile additions to the oceanic sodium by submarine springs. Any such additions would be equivalent to primitive salinity of the ocean and imply a further reduction in age.

#### RESULTS OF ASYMPTOTIC ACCUMULATION

To find the age of the ocean from the total oceanic sodium and its annual increment, it is manifestly indispensable to know or to assume a definite time relation between them. Mr. Joly's hypothesis is that the total sodium of the ocean is the annual increment of sodium multiplied by the age of the ocean in years; but another relation not less simple

seems to me much more probable and better fitted to give a first approximation to the truth.<sup>1</sup>

Oceanic sodium is at least chiefly derived from lime-soda feldspars which as essential constituents are practically confined to Archean and later igneous rocks. The original surface of the earth must have consisted of such rocks to the exclusion of all others, while at the present day the greater part of the land area is covered with sedimentaries. Now the rate of decomposition of rocks is chiefly dependent on exposure. Even in areas of ancient feldspathic massives decomposition does not seem to penetrate to great depths. Thus in the southern Appalachians great areas of gneiss and allied rocks are now covered with a blanket of saprolite (rotten rock in place) which is in many localities 50 feet in thickness, but at all the points where I have observed it, less than 100 feet thick. Immediately below the saprolite blanket there is incipient decomposition and the feldspars are milky, but not many yards lower down the feldspars are characteristically translucent and the rock bluish in tint. A layer of decomposition products 100 feet thick seems to arrest decay. Corresponding statements are true of tertiary volcanics, excepting where the decomposition is solfataric. On the other hand mesozoic and paleozoic massive rocks deeply buried under sediments are in many cases found to be very free from decomposition. In short, buried massives decompose at a rate which is scarcely sensible.

It is quite imaginable that in the far distant future all the massive rocks might be thoroughly decomposed down to sea level or a trifle below. The continents would then be exclusively detrital. Under such conditions there could be no further important additions to the sodium content of the ocean, for there would then be no leaching; while mere diffusion to any considerable distance is too inordinately slow to produce any noteworthy result even in millions of years.

Thus in the distant past there must have been a time when a far greater mass of massive rock was decomposed each year than now decays in the same period; and a limit to this process can also be foreseen. The total area of exposed massives has surely diminished and will continue to diminish. Climate and temperature may perhaps have been in the past much what they are to-day; the rate of chemical denudation per unit area may not have changed considerably, but the most rigid uniformitarian would not maintain that the total area of exposed massive rocks has been constant. The inference seems unavoidable that sodium accumulation is an asymptotic process which progressed more rapidly (though possibly not with greater intensity) in the distant past and will come substantially to an end when a certain very finite layer of surface material has been ex-

---

<sup>1</sup> Vide Science, vol. 31, 1910, p. 509.

hausted. It seems worth while to attempt some estimates based on this conception of the saltness of the ocean.

There is a great deal of evidence for the elder Dana's generalization as to the permanence of continental areas, and it is accepted by most physical geologists. Assuming its truth it should be possible to arrive at a mean value for the exposed land surface throughout geological time, and this would be a constant of the same order of magnitude as the present continental area.

The simplest law compatible with the conditions set forth is that, at any given time, the decrease per unit of time in the area of the sodium-producing exposures has been simply proportional to the temporary area of the exposures. This is equivalent to the hypothesis that the area of the feldspathic rocks can be represented approximately by the descending exponential; for if  $y$  is the exposed area at a given time,  $t$ , and  $c$  a constant, the decrease is represented by

$$dy/dt = -y/c, \text{ whence } y = Ae^{-t/c}$$

Here  $A$  is the extent of the exposure when  $t = 0$ , or when erosion is supposed to begin. On the strength of Dana's law  $A$  may be taken as the mean land area of the globe.

Suppose the total sodium content of the ocean at time  $t$  to be  $N$ , and let  $m$  be the annual yield of sodium per unit area, so that  $my$  is the increment of  $N$  in one year from time  $t$ . Then,  $m$  being constant,

$$N = \int_0^t my dt = Amc (1 - y/A)$$

or

$$c = \frac{N/my}{A/y - 1}$$

while the formula for the age of the ocean is

$$t = c \log_c \frac{A}{y}$$

This hypothesis takes no account of a primitive saline ocean, though that condition could be included by merely adding another constant. When  $t$  becomes infinite,  $y$  reduces to zero and, therefore, the limiting value of  $N$  is  $Amc$ .

The selection of the exponential to represent the phenomena under discussion is neither a random one nor dictated by mere convenience. This function is well known to play a leading part in the theory of those natural operations which may be classed generically as processes of absorption or gradual extinction,<sup>1</sup> just as it also expresses the gradual accumulation of money at compound interest. The descending exponential ex-

<sup>1</sup> Cf. Cournot, *Théorie des fonctions et du calcul infinitésimal*, vol. 1, chap. 2.

presses the decay of velocity of a body moving in a resisting medium; or the gradual extinction of light in an absorbing medium; the loss of electricity or of heat by radiation from a conductor; the decay of radio-activity, and an endless number of similar phenomena. Whenever the loss of an entity during any instant is simply proportional to the amount of the entity then present, the process must be expressed by the exponential.

It does not follow that the decomposition of feldspathic rocks is accurately represented by a single exponential term. Were the whole history of these rocks known it might very probably appear that the process is complex and should be expressed in some such manner as

$$y = Ae^{-t/c} + A_1e^{-t/c_1} + \dots$$

one term expressing, for example, the decay of albite; another that of anorthite, etc.

There is no close analogy between the asymptotic diminution of the area of those feldspathic rocks which are subject to erosion and the process of refrigeration of a globe or that of the diffusion of solutions, although these also are asymptotic. In the diffusion of solutions the molecular flow across a plane during an instant of time is proportional to the difference of concentration of the two thin layers divided by the plane. If one of them is devoid of solute, the process commences at immense speed; but it soon becomes very slow because the layers tend to acquire the same concentration.<sup>1</sup> Beneath areas in which there is no erosion, such as the ocean floor or lake bottoms, decomposition by diffusion is probably in progress; but the amount of sodium thus contributed to the rivers or the sea must be negligible in comparison with that yielded by denudation.<sup>2</sup>

At present it appears useless to speculate on sodium accumulation as represented by a series of exponential terms, nor can I think it needful. Precisely as a cubic mile of granite may be regarded as isotropic because the mass is so large compared with that of the single aeotropic grains of which it is composed, so local inequalities of chemical denudation disappear in the average of innumerable diversities. There must be some descending exponential which will fairly represent the process and the problem reduces to making a judicious selection of constants.

The earlier portion of this paper is devoted to a discussion of the value of  $N/my$ , or the ratio expressing the earth's age on Mr. Joly's hypothesis, and limiting values have been found for it. To compute the age on the exponential hypothesis it only remains to find a value of  $y/A$  for the present time. From Mr. Charles Schuchert's valuable memoir on paleo-

<sup>1</sup> For examples of the extreme slowness of diffusion see Amer. Jour. Sci., vol. 3, 1897, p. 27. For definition of the process, see Everett's c. g. s. system of units, 1902, p. 151.

<sup>2</sup> Although the hyperbola is an asymptotic curve, its equation would not express the course of the extraction of sodium from the outer shell of massive rocks, for that would imply that this shell would in time yield an infinite quantity of the metal.



geography<sup>1</sup> it appears that the mean area of the continent of North America has been about 8/10 of its present area. While the paleogeography of no other continent seems to have been so satisfactorily treated, it is generally acknowledged that the continents have grown more stable and the ocean deeper. So far as existing continents are concerned, therefore, it is fair to conclude that the mean land exposure has been somewhat less than the actual land area. Many paleontologists, however, think themselves driven by zoölogical reasoning to believe in the former existence of extensive continents bridging the great oceanic basins of the present day. This seems to me mechanically improbable and some great authorities such as Sir Archibald Geikie<sup>2</sup> refuse to concede the point. If the existence of such sunken continents of unknown extent were to be assumed, there would be no such thing as approximating to a mean land area. All I can do, therefore, is to point out that the effect of such bodies of land would be greatly to reduce the appropriate estimate of the earth's age by the method under discussion.

Assuming the permanence of continental areas, the uncertainty of the mean area is partially offset by marine denudation; for when shallow seas invaded the continents, breakers and the tidal wave must have triturated far more rock than is ground up on the shores of present continents.

A careful study of the areas of exposure of the principal geological formations was made by the late distinguished physical geographer, Lieutenant-General Alexis von Tillo. This includes the Archean and the younger eruptives, the results being expressed in hundredths of the total surveyed area. The following is an extract from von Tillo's table:<sup>3</sup>

<i>Continent.</i>	<i>Archean.</i>	<i>Eruptives.</i>	<i>Total.</i>
Europe .....	20.6	1.3	21.9
Asia .....	17.7	4.7	22.4
Africa .....	18.4	2.2	20.6
Oceanica .....	20.0	4.8	24.8
North America .....	27.2	5.5	32.7
South America .....	18.7	4.6	23.3
Mean .....	20.3	4.0	24.3

The most recent geological map of North America (compiled by Mr. Bailey Willis) shows that the relative area of exposed feldspathic rocks on this continent is not so large as was supposed when von Tillo wrote, and, though I have made no minute measurements, this exposure as now mapped seems not to exceed 25 per cent. With this emendation, von Tillo's table shows a truly remarkable uniformity throughout the world, all the figures lying between a fourth and fifth of the total area, the average

<sup>1</sup> Bull. Geol. Soc. Am., vol. 20, 1910, p. 427.

<sup>2</sup> Text-book of Geology, 4th ed., 1903, p. 1365.

<sup>3</sup> Comptes Rendus, Paris, vol. 114, 1892, pp. 246, 967.

being 23 per cent. He too was impressed by the smallness of the variation in the relative areas of Archean exposures.

If the present continental area were the mean land area von Tillo's data would give at once  $y/A = 0.23$ , but since the land now stands at a high level the true value of  $A$  is smaller than the actual area and the quantity 0.23 must be modified accordingly.

The greater part of the area of massive rocks lies at a considerable distance from the sea, so that a partial submergence would diminish the continental area much more in proportion than the exposure of feldspathic rocks. In order to include, if possible, the true mean value of the land area, I shall take  $y/A$  first at three-tenths and again at one-fourth; the latter exceeding the 0.23 derived from von Tillo's data by a proportion relatively trifling while, closely enough,  $0.3 = 0.23/0.8$ , the denominator representing the mean taken from Mr. Schuchert's memoir.

With these data the results are as follows:

$y/A$ .....	0.30	0.30	0.25	0.25
$N 10^{-6}/my$ .....	144.2	99.5	144.2	99.5
$c/10^6$ .....	61.80	42.64	48.07	33.17
$Amc$ .....	$10N/7$	$10N/7$	$4N/3$	$4N/3$
$t/10^6$ .....	74.4	51.3	66.6	46.0

Here the second line gives the ages on Mr. Joly's hypothesis in millions of years, and the last that computed from the logarithmic relation. The fourth line gives the ultimate amount of oceanic sodium calculable from the equations, and inferentially the thickness which Clarke's shell may reach,  $10/7$  or  $4/3$  of its present value. With the larger fraction this shell, now measuring 2050 feet, would ultimately attain a thickness of 2930 feet, or if it were all piled onto our continents, 2.2 miles. The difference between this estimate of the ultimate size of Clarke's shell and its present dimensions represents a volume  $2\frac{1}{2}$  times as great as that of the present continents above sea level. Such, then, on this rather extreme assumption, would be the volume of massive rock, still fresh, but doomed to eventual decomposition. Thus the hypothesis leaves an ample margin for future igneous effusions and epirogenic uplifts without putting an excessive strain upon the imagination.

Of the ages computed, the greatest, 74 million years, is the most valuable. It is indisputable that the process of rock decomposition is an asymptotic one and at least roughly represented by the simple exponential, while every effort has been made to select for the first computation the highest reasonable values for  $N/my$  and  $y/A$ . All the estimates would be greatly reduced if a primitive salinity of the sea or the former existence of land areas in the great oceanic basins were assumed. Those who do not feel obliged to accept either of these hypotheses may perhaps agree in my

opinion that the age indicated is between 70 and 50 million, probably closer to the upper limit than to the lower one.

The extreme values of Mr. Joly's ratio,  $N/my$ , which I am led to adopt, do not differ greatly from those preferred by Mr. Sollas, viz., 80 million and 150 million, while the ages computed from the logarithmic expression fall in very well with Mr. Sollas's results from stratigraphic reasoning. Again, if Mr. Walcott's estimate is amended by making the age of the earth twice as great as the lapse of time since the beginning of the Cambrian, the resulting 55 million years accord with the result here reached. Stratigraphy and sodium denudation as here discussed thus give results which are at any rate of the same order of magnitude.

## AGE FROM REFRIGERATION

### HISTORICAL NOTE

Kelvin's famous and epoch-making paper on the secular cooling of the earth was published in 1862.<sup>1</sup> His problem was to find the time which would elapse before a globe completely solid from center to surface and having throughout a certain uniform initial temperature would cool so far as to reduce the surface gradient of temperature to any given value. He assumed an initial temperature of 3900° C., a diffusivity of 0.01178 in c. g. s. units and a final surface gradient of 1° C. in 27.76 m. or 1° F. in 50.6 feet. These data discussed by one of Fourier's theorems give for the age of the earth  $98 \times 10^6$  years. Kelvin, however, expressly directed attention to the fact that the effect of temperature in modifying diffusivities is almost unknown, and that the original distribution of temperature is uncertain. He also referred to the great differences in the surface gradient of temperature, which varies with the locality, as he stated, from 1° F. in 15 feet to 1° F. in 110 feet. He, therefore, allowed very wide limits in his estimate and placed the age between 20 million and 400 million years.

In 1893 Clarence King made a very important contribution to the subject<sup>2</sup> by introducing the criterion of tidal stability. Mr. Barus determined for him the melting point of diabase in terms of depth. If in any hypothetical earth consisting solely of diabase the temperature in any couche were to exceed the melting point of diabase, then tidal instability would set in, the crust would break down and chaos would reign for the time being. In a real earth the same result would follow provided the couche were in a region where diabase or equally fusible rocks are to be expected. Excluding such cases, King found that the age of the earth could not exceed 24 million years when Kelvin's values for diffusivity and

<sup>1</sup> Trans. R. S. Edinburgh, reprinted in Thomson and Tait, "Natural Philosophy," Pt. II, p. 468.

<sup>2</sup> Am. Jour. Sci., vol. 45, 1893, p. 1.

surface gradient are assumed. He also found that the corresponding initial temperature of such a globe would be  $1950^{\circ}$  C.

Kelvin's last paper on a cooling earth<sup>1</sup> was read in 1897, and he there stated that after having worked out the problem of conduction of heat outwards from the earth by an elaborate method, he was not led to differ much from Clarence King's estimate. This he adopted as the most probable age and reduced his limits to between  $20 \times 10^6$  and  $40 \times 10^6$  years.

While King's earth is tidally stable, I confess that his solution of the problem seems to me to be fatally defective. He himself gives a temperature curve for the same earth at an age of 15 million years, and this earth shows a couche at a temperature above the melting point of diabase, this layer extending from a depth of 34 miles below the surface to 66 miles. According to Laplace's law of densities these two levels correspond respectively to densities of 2.85 and 2.93, and it seems certain that the material must consist chiefly of basaltic rocks. Thus the 15-million-year earth would be unstable and this instability would only just disappear at 24 million years. I am obliged to conclude that if an earth could cool in this way—if the crust could be prevented from breaking—the 24-million-year earth would only just have reached the "consistentior status" or the epoch of solidity.

The real earth, however, has been in a condition of tidal stability at least since the beginning of the Cambrian: for the strata are full of ripple marks, sands and pebbles rearranged by tidal currents, beach footprints and similar evidence of tides. Now oceanic tides would not exist upon a tidally unstable earth and, therefore, the consistentior status occurred long ago. It was the remoteness of this epoch that Kelvin attempted to calculate.

King gives data for only one earth which is satisfactory from this point of view. It had an initial temperature of  $1230^{\circ}$  C. and reached a surface gradient of  $1^{\circ}$  F. in 50.6 feet in 10 million years. It was solid almost from the beginning. But apart from the excessive brevity of the age, it seems to me that this earth must likewise be rejected. The temperature was insufficient to melt even diabase a few miles below the surface, much less andesites and rhyolites, while there is a mass of well-known evidence that the earth has been fluid at least to depths of many miles from its growing surface. This is shown by the general dependence of gravity on latitude, the nearly spheroidal shape of the earth, the oblateness of the interior layers of equal density and the conclusion reached by Kelvin,<sup>2</sup> Roche<sup>3</sup> and Wiechert<sup>4</sup> that a nucleus of constant high density (approx-

<sup>1</sup> Trans. Victoria Institute, vol. 31, 1899, p. 11.

<sup>2</sup> "Natural Philosophy," Pt. II, p. 429. This article also appeared in the first edition of the "Natural Philosophy," 1867.

<sup>3</sup> Mém. Acad. Montpellier, 1882.

<sup>4</sup> Göttingen Nachrichten, 1897, p. 221.

mately the density of iron) surrounded by a shell of much smaller density (near 3) will satisfy the observations on precession, ratio of surface density to mean density and the ellipticity of sea level.

Considering the materials of which the earth is composed and the high pressures which must have existed at some distance from the surface at any stage of the earth's growth, it seems clear that very high temperatures must have prevailed within its mass, while for the reasons stated above, tidal instability at any epoch since the ocean came into existence is inadmissible. Hence the hypothesis of a constant initial temperature will not satisfy the conditions.

The question thus arises whether the initial temperature may be supposed to have been graduated in such a manner as to satisfy known conditions. I believe that this question may be answered affirmatively. Kelvin himself contemplated a very different distribution of temperature from the uniformity assumed in his equations. The earth, he said, "did in all probability become solid at its melting temperature all through or all through the outer layer"; "convective equilibrium of temperature must have been approximately fulfilled until solidification commenced"; and "the temperature of solidification will, at great depths, because of the great pressure there, be higher than at the surface if the fluid contracts . . . in becoming solid."

#### MODIFIED PROBLEM.

If the initial temperature at the consistentior status increased with distance from the surface, it was probably according to some complex law intimately related to that of convective equilibrium, but the thickness of the shell which has been sensibly affected by cooling is very small. At a distance of 80 miles below the surface the temperature is probably now very near 99 per cent. of what it was at the consistentior status. Hence if a layer double this thickness is considered, the conditions which prevailed in the remainder of the earth are of no consequence. The inner part, with a radius of say 3840 miles, may have been originally at the temperature of ice or of the electric arc; it may conduct heat as well as silver or as ill as magnesia; in any case the influence on the outer surface would be insensible even after scores of millions of years. Now, though the temperature at the consistentior status did vary with distance from the surface according to a highly complex law, it is altogether probable that for so short a distance as 2 per cent. of the radius this law may be adequately represented by a straight line. This would be comparable with the superficial portion of Mr. Barus's curve, which is nearly rectilinear. Mr. Barus's experiments indicated that the relation between pressure and the melting point of diabase is a linear one, so that, had he confined his conclusions to a shell whose thickness was small relatively to

the radius, his melting point curve would have reduced to a straight line. Such a restriction in the circumstances is not objectionable and corresponds to the limitation of the problem of refrigeration as solved by Kelvin, whose formulas, strictly speaking, represent the cooling of a solid of indefinite extent bounded by a plane surface and not the cooling of a sphere. It can be and has been shown that the error introduced by neglecting the earth's curvature is insignificant.

It will be sufficient, therefore, to assume that the initial temperature of the earth increased in simple proportion to the distance from the surface, and this simplification renders it easy to modify the Fourier equation employed by Kelvin to satisfy this condition. In his solution an infinite homogeneous solid is supposed divided by a plane on one side of which, at the initial instant, the temperature has one uniform value, while on the other side it has another uniform value. The object of the second mass is to replace outer space and preserve a constant temperature in the dividing plane. This device may seem at first sight too artificial, but Kelvin proved that after a comparatively brief period the temperature of the surface of the globe would be affected to an entirely negligible extent by internal heat. Radiation and convection, or briefly "emissivity," accomplish substantially the same end as the hypothetical conducting solid, in that they dispose of the heat as fast as it reaches the surface excepting for a period of possibly a few thousand years after the surface of the globe solidified.<sup>1</sup>

Fourier's partial differential equation for the linear conduction of heat is

$$\frac{dv}{dt} = \kappa \frac{d^2v}{dx^2}$$

where  $v$  is temperature and  $x$  distance from a plane, while  $\kappa$  is the diffusivity which is assumed to be constant and known. Any value whatever of  $v$  which will satisfy this equation is a solution of some problem in conduction. In general the problem of finding a value of  $v$  which satisfies given boundary conditions is difficult, but in the particular case under discussion the appropriate form of  $v$  is easily arrived at. The equations

$$\frac{dv}{dx} = \frac{V}{\sqrt{\pi\kappa t}} e^{-x^2/4\kappa t} + c \quad (1)$$

and

$$v - v_0 = V \frac{2}{\sqrt{\pi}} \int_0^{x/2\sqrt{\kappa t}} e^{-z^2} dz + cx \quad (2)$$

<sup>1</sup> So far as the earth is concerned, the evaporation of water is the most important factor in the removal of heat from the surface to the upper regions of the atmosphere, or in what may be regarded as the emissivity of the globe. According to Sir John Murray's figures (*Geochemistry*, p. 53), the average annual rainfall less the run-off is about 70 centimeters, and substantially all of this is evaporated. The evaporation of 1 cubic centimeter absorbs about 591 gram calories and thus the total evaporation removes from the earth's surface some 13 times as much heat as the earth emits, the large residue being of course derived from the sun.

satisfy the partial differential equation when  $c$ ,  $v_0$  and  $V$  are constants, as may easily be tested by differentiation. If  $c = 0$  they reduce to the forms used by Kelvin. Here  $v_0$  represents the constant temperature at the surface of the cooling mass and  $V$  the initial temperature of the cooling mass at an infinitesimal distance from the surface. As will be proved in the next paragraph,  $c$  is the constant initial temperature gradient.

From the equations themselves it can be at once determined what boundary conditions are implied. When  $t=0$ , the upper limit of the integral in (2) becomes infinite, and the value of the integral itself is then  $\sqrt{\pi}/2$ ; consequently when  $t = 0$  and  $x$  is a positive quantity, the initial distribution of temperature in the real solid is represented by

$$v - v_0 = V + cx$$

while in the imaginary solid replacing outer space at the same instant

$$v - v_0 = - (V + cx)$$

Hence equations (1) and (2) fulfil the conditions demanded by the modified problem under discussion, and represent the cooling of a body in which the initial temperature increased from the surface value,  $V$ , in simple proportion to the depth,  $x$ .

The superficial temperature gradient at any time is found by making  $x = 0$  in (1) and is expressed by

$$\left(\frac{dv}{dx}\right)_0 = \frac{V}{\sqrt{\pi\kappa t}} + c \quad (3)$$

In Kelvin's solution this quantity as well as  $\kappa$  and  $V$  is regarded as known, while  $c$  is made equal to zero, so that (3) gives the required age. In 1862 it seemed both unobjectionable and inevitable to rely on the surface gradient determined by observation in determining the age of the earth; but it is now known that this gradient is affected by radioactivity, and, therefore, that it cannot be trusted. It is the special purpose of this paper to dispense with the employment of the surface gradient. This will be accomplished by taking advantage of Mr. John F. Hayford's level of isostatic compensation, which lies far below the level at which radioactivity can affect the supply of heat.

If appropriate values of the constants can be found, equations (1) and (2) can be computed for any desired age, and this computation is an easy task because the value of the definite integral in (2) has been tabulated by various mathematicians, the most complete table being by Mr. James Burgess and printed in 1900.<sup>1</sup>

Kelvin employed a diffusivity,  $\kappa$ , of 400, using the British foot and the year as units. In c. g. s. units this would be 0.01178. This value was obtained from experiments on the trap rock of Calton Hill, the sand of an

<sup>1</sup>Trans. R. S. Edinburgh, vol. 39, 1900, p. 257.

experimental garden and the sandstone of Craigeleith quarry, all at Edinburgh. Different weights were given to these observations, but how is not explained. Now, in considering the diffusivity of the earth it does not seem to me that the ragged pellicle of detrital matter on its surface need be considered. Over large areas it is absent and in most places the sedimentary rocks are saturated with water, so that their own intrinsic diffusivity is a minor feature of the flow of heat. The great bulk of the rocks in the shell affected by cooling are massive and at least comparable with the trap of Calton Hill, which is chiefly composed of Carboniferous basalt and andesite. The conductivity of this rock was observed by Forbes and Thomson (Kelvin) for no less than eighteen years: the thermal capacity was determined by Regnault, so that the value of the diffusivity, 0.00786, is undoubtedly very accurate. It does not stand alone. A committee of the British Association,<sup>1</sup> Herschel and Lebour, reported for whin and traps  $\kappa = .0067$ , and for serpentine from .00594 to .0073, while Ayrton and Perry got for porphyritic trachyte .0103. I do not think a better choice can be made than the Calton Hill trap, and its diffusivity with the meter and year as units is the value which will be assumed here, *i. e.*,  $\kappa = 24.8037$ .

That  $\kappa$  varies with temperature and with pressure is probable. That in iron it decreases with increasing temperature is known and analogy would point to the conclusion that it should increase with pressure. Possibly diffusivity is simply related to density and for the same or similar rocks tends in the earth to a nearly constant value. At present it seems unavoidable in this problem to regard it as constant.

The outer portion of the earth is composed of various rocks which are believed to be arranged roughly in the order of density. If so the peridotites underlie the basaltic rocks, while the andesites and rhyolites overlie them. These latter are less fusible than diabase. How deep the level lies which would answer to the upper surface of the basaltic rocks cannot be told with certainty. The best that can be done is to assume that Laplace's law of density is valid for a few score miles from the surface and to consider roughly the effects of heat and pressure. In this way I have reached the conclusion that at about 40 miles, or 0.01 times the radius, where the density should be 2.86, the temperature perhaps 1300° C. and the pressure 17,400 atmospheres, basaltic rocks may begin to appear in place. A pressure of 13 or 14 atmospheres per degree centigrade is probably of the order of magnitude needful to preserve constancy of volume in a heated solid, while at atmospheric pressures the densities of basaltic rocks are from 2.85 to 3.10, with minor exceptions. The outer crust to a depth of 40 miles is thus probably less fusible than basalt.

<sup>1</sup> Brit. Assoc. Ad. Sci., 1881.



As was pointed out above, the line representing the melting point of diabase in terms of depth as determined by Mr. Barus may be taken as rectilinear for depths up to a hundred miles, and is then represented by what I may call the diabase line,

$$y = 1170^\circ + \frac{430}{.01r} x = b + \rho x$$

where  $r$  is the radius of the earth, and according to the results of the last paragraph the original temperature distribution in the globe must be such that only the layer of rock within 40 miles of the surface was heated to a higher point than that at which diabase would melt. Thus  $V$  being the original surface temperature and the original temperature at distance  $x$  being represented for distinction by  $u$ ,

$$u = V + cx$$

According to a preceding paragraph it is probable that  $y$  and  $u$  should have the same value at  $0.01r$  or 63,710 meters from the surface, but the discussion can be made a little more general by supposing the intersection to be at a depth  $nr$ . Then

$$c = \rho - \frac{V - b}{nr} \quad (4)$$

It is easy to perceive that whatever values of the constants and the age are chosen, the temperature curve will have one and only one tangent which is parallel to the diabase line. Of course the point of tangency is that at which the curve approaches the melting point of diabase most closely or at which the additional temperature which would be required to melt diabase is a minimum. It is at this level of tangency that any access of temperature due to the dissipation of mechanical energy or to other causes is most likely to produce fusion at depths where the rock is diabolic. If the constants are assumed at any value and the courses of the curves are considered for various periods of time, it is easily seen that the point of nearest approach to the diabase line sinks to greater depths as time elapses.

Now, strains must exist in the earth at all times. They may be and are partially relieved by rupture and by solid flow, but most completely by fusion. Thus in an earth the cooling of which is represented by (2) such strains as may be incident to upheaval and subsidence and to orogeny will probably be most completely relieved at the slowly sinking surface of easiest fusion.

Messrs. Tittmann and Hayford have recently discussed the whole body of geodetic data for the United States and have shown that the deflections of the vertical are best accounted for by the hypothesis that isostatic com-

compensation is uniformly distributed and is complete at a depth of 114 kilometers or 71 miles from the surface.<sup>1</sup>

I, therefore, adopt the hypothesis that the tangent of the temperature curve, or equation (1), is parallel to the diabase line at 114 kilometers from the surface.

$V$  is the value of the original temperature of the earth at its surface. As was pointed out above, this must have been high enough to fuse rocks more refractory than diabase and was probably about equal to the temperature of the hottest eruptions which now reach the surface of the earth. It seems to me that  $1300^\circ$  is a reasonable estimate. This is considerably below the melting point of pure iron and lower than the blast furnace, but above the melting point of copper ( $1065^\circ$ ), which lavas are known to fuse, and of Barus's diabase ( $1170^\circ$ ). So far as I know, no precise determinations have yet been made of the temperatures at which lavas issue from their vents.

To make the use suggested above of the level of isostatic compensation let its depth be represented by  $x$ , and in equation (1) let  $(dr/dr)_1 = p$ , the gradient of the diabase line. Then since  $p$  also appears in the value of  $c$ ,  $p$  disappears and  $(dr/dr)_1 - c =$

$$\frac{V-b}{nr} - \frac{V}{\sqrt{\pi\kappa t}} e^{-x^2/4\kappa t}$$

On the assumptions here made this equation determines the age of the earth and this age is independent either of the gradient of Mr. Barus's diabase line or of the initial temperature gradient. The constants involved are the initial surface temperature ( $V$ ), the melting point of diabase at the earth's surface ( $b$ ), the diffusivity ( $\kappa$ ), the distance from the surface of the top of the diabase couche ( $nr$ ) and the depth of the level of isostatic compensation ( $x_1$ ). The surface temperature gradient does not in any manner enter into this expression, which is thus wholly distinct from that employed to determine the age by Kelvin.

#### NUMERICAL RESULTS.

Solving for  $V$  and substituting the numerical values for  $\pi$ ,  $\kappa$ ,  $r$  and  $x_1$  gives

$$V = \frac{1}{1170^\circ} \left( 1 - \frac{721.720n}{\sqrt{t}} e^{-\frac{130.99 \times 10^6}{t}} \right)$$

in which  $n$  is left indeterminate to facilitate any variations in the depth of the top of the diabase couche thought desirable. The form of the equation is such that  $t$  is almost necessarily taken as the independent variable, but that is of no consequence.

<sup>1</sup> Rep. to 15th general conference of the International Geodetic Assoc., Washington, 1906.

In the Coast and Geodetic Surv. Report on the Figure of the Earth and Isostasy, 1909, Mr. Hayford gives the depth of compensation ("solution G") at 113.7 kilometers. In my paper in *Science*, vol. 27, 1908, p. 227, this depth was stated by a blunder in copying at 140 kilometers, but the correct value was used in the computations.

When  $T$  is computed or assumed  $c$  may be found from (4) and the surface gradient is then ascertained from (3). Taking  $n$  at 0.01 as indicated by Laplace's law I now get the following table of related values:

$T$ .....	30.	50.	55.	60.	65.	100.
$V$ .....	1190. <sup>o</sup>	1264.	1286.	1307.	1329.	1453.
$c$ .....	0.00644	0.00527	0.00493	0.00459	0.00426	0.00231
$1/c$ .....	155 <sup>m</sup>	190.	203.	218.	235.	433.
$G^{\circ} C.$ .....	32 <sup>m</sup> 2	39.2	40.7	42.2	43.6	53.3
$G^{\circ} F.$ .....	58.7	71.4	74.2	76.9	79.5	97.1

$T$  is the age in millions of years;  $V$  is the initial surface temperature;  $c$  is the initial gradient of internal temperature and  $1/c$  gives this gradient in terms of meters per degree centigrade.  $G^{\circ} C.$  is the final surface gradient in terms of meters per degree centigrade and  $G^{\circ} F.$  is the same gradient in terms of feet per degree Fahrenheit.<sup>1</sup>

In all of these earths the upper surface of the diabase couche is supposed to be at one one-hundredth of the radius from the surface, or 63,110 meters, but another assumption will be made below. All of the excess of temperature curves have tangents parallel to the diabase line at a depth of 114,000 meters. Tidal stability is provided for at all times by the equations; for the temperature curves never cross the diabase line excepting within 40 miles of the surface, or within the shell of more refractory rocks.<sup>2</sup>

Of the six earths computed the one whose initial temperature comes nearest to 1300° C. is that of the 60-million-year earth, and it is the one

<sup>1</sup> Mr. Hayford's latest value for the level of isostatic compensation appeared while this paper was in press. It is contained in Supplementary Investigation of the Figure of the Earth and Isostasy, Coast and Geod. Surv., 1910, and is 120,900 meters. This new value would reduce the initial temperature of a 60 x 10<sup>6</sup> globe to 1272°, or give for a globe whose initial temperature was 1300° an age of 68 million years, with a surface gradient of 1° C. in 44 meters.

<sup>2</sup> Immediately after the primitive consolidation of the earth it is almost certain that a period of aqueous fusion supervened, as I pointed out in Bull. Geol. Soc. Amer., vol. 19, 1908, p. 142. This was the period of the formation of the granitoid rocks and it may have been of rather brief duration. The formulæ of the text are applicable to the very early stages of the cooling of a large lava field rather than to the very first part of the refrigeration of the globe, but after a time so brief as to be insignificant compared with the earth's age the equations used would apply. To illustrate this point fancy the hypothetical earth whose initial temperature  $V$  was 1307° with gradient  $c = 0.00459$  to have cooled until it emitted just heat enough to raise the temperature of a sheet of water 1 meter deep 1° in 1 day. This means an emission of 33,324 gram calories per annum, and this would be totally expended by an evaporation of a layer of water about 62 centimeters deep. This is considerably less than the present mean evaporation on continental areas. Hence there is no difficulty in imagining the surface of the earth at this stage kept constant by emissivity, including evaporation, and from that period on the formulæ may be considered as applicable.

Now if the theory held good also prior to this period, the lapse of time since the consistentior status would be only a trifle more than 28 years, the gradient would be nearly 28° per meter and the rock would be red-hot, or at 500°, only 18 meters from the surface. These results depend on the conductivity of the rock (or the diffusivity multiplied by the thermal capacity) which for the Calton Hill trap is 0.00415 in c. g. s. units, the heat emitted per second per square centimeter being the product of the surface gradient and the conductivity. Doubtless the real duration of this initial stage was longer than 28 years. If it were a hundred times as long, or even 1000 times, the age of the earth would be substantially the same as if the formulæ accurately represented the entire process.

which appears to me most probable. The most evident objection to it is the low surface gradient of  $1^{\circ}$  F. in 77 feet, while Kelvin took  $1^{\circ}$  F. in 50.6 feet and King stated that in 1893 the last published value as reduced from all available data by the British Association committee was 64 feet per degree Fahrenheit. King himself considered 75 feet a maximum. To me, however, it does not seem that an average value is what is required. In discussing the cooling of the earth disturbing causes must be eliminated as far as possible. Now several causes must contribute more or less to raise the temperature of rocks near the surface; for example, thermal springs, volcanic heat, the dissipation of mechanical energy by faulting or solid flow, the liberation of heat in the decomposition of minerals and radioactivity. So far as I know, the only causes which can lead to a deceptively low gradient in rocks of a given type are the neighborhood of large bodies of cold water and abnormally high diffusivity. Furthermore, to include gradients observed in sedimentary rocks seems to me to complicate the problem unnecessarily. The gradients which should serve as a guide are those in massive rocks, especially the nearly anhydrous basaltic, andesitic and rhyolitic massives. All cases where there are local evidences of heat due to thermal springs, etc., should be excluded, and when for a normal rock the gradient is unusually high, it should be considered as suspicious. In short, for the present problem the lower gradients in massive rocks are those most likely to give a correct value of the earth's age.

Several writers have made suggestions of this kind, but Mr. Johann Koenigsberger<sup>1</sup> has given the only detailed discussion of the matter known to me, pointing out that the characteristic gradients are those observed in nearly level, inland regions, in chemically unaltered rocks. Of such he gives 26 cases, ranging from  $1^{\circ}$  C. in 27.8 meters to  $1^{\circ}$  in 37.9 meters. Five of these average  $1^{\circ}$  in 37.7 meters, so that, in round numbers,  $1^{\circ}$  in 38 meters seems to me best to represent the true terrestrial gradient. Comparing this gradient with the  $1^{\circ}$  in 42.2 meters computed for the 60-million-year earth leaves a difference of  $1^{\circ}$  in 385 meters to be accounted for by exothermic chemical action. This is no doubt an inaccurate remainder, but it is probably of the order of magnitude of the correction appropriate to radioactivity and similar causes.<sup>2</sup>

Mr. Koenigsberger in the same paper has also shown that the temperatures observed in the Swiss railway tunnels can be computed from Fourier's equations and average superficial temperature gradients when the topographic forms are duly represented in the formulæ. Hence it is not needful to assume radioactivity in order to account for these phenomena.

<sup>1</sup> Congrès géolog. Intern., tenth session, Mexico, Comptes Rendus, 1907, p. 1127.

<sup>2</sup> See "Relations of Radioactivity to Cosmogony and Geology," Bull. Geol. Soc. Amer., vol. 19, 1908, p. 113.

The least satisfactory of the assumptions made in the foregoing discussion of refrigeration is that the depth of the diabase couche is 40 miles or  $0.01r$ . This was estimated from Laplace's law, but that is a mere approximation or at best a mean. In order to test the consequences of a variation in the thickness of the refractory shell ( $nr$ ) I have also computed some cases for  $nr = 0.0075r$ , or say 30 miles. Of these I will give only that appropriate to an initial surface temperature of  $T = 1300^\circ$ . The results are:

$T$ .....	70.
$c$ .....	0.00403
$1/c$ .....	248.
G°C. ....	46.3
G°F. ....	84.3

Thus the age falls out notably greater and the gradient lower, leaving double the margin for chemical heat estimated in the case of the 60-million-year earth. While these results are less probable than those for the younger earth, they do not seem impossible and, in my opinion, 70 million years may be taken as a maximum value of the age of the earth as determined from refrigeration.

With such constants as are now available it seems to me that the age of the globe considered as a cooling body must be between 70 million and 55 million years, limits not differing greatly from those found by other means in the earlier part of this publication.

### CONCLUSION.

In the stratigraphical method of determining the age of the ocean the weak point is the uncertainty of the duration of pre-Cambrian time. The best determination of the date of the base of the Cambrian seems to be that by Mr. Walcott, who places it at 27,640,000 years ago. The order of magnitude of the pre-Cambrian period is probably the same, so that stratigraphy indicates an age of the ocean of, say, between 50 and 65 million years. This is in accord with Mr. Sollas's most recent results, for he regards 80 million as a maximum without being able to give a definite account of nearly so long a period.

Considering sodium accumulation as an asymptotic process, as it unquestionably is, the weak point is the possibility that the primitive ocean was salt, or that there have been continents in the oceanic basin. These possibilities do not affect an estimate of the maximum age, 74 million years, but preclude a definite minimum. Assuming that neither of these possibilities was realized, the minimum would be about 46 million years.

Refrigeration, so dealt with as to exclude tidal instability, and computed on the basis of Mr. Hayford's level of isostatic compensation, with-

out employing as a datum any observed superficial temperature gradient, yields results which can hardly be forced above 70 million or below 55 million years. The weak point here is our ignorance of the depth of the top of the diabase conche; but if Laplace's law of density holds true, the limits would be about 65 and 55 million years.

These three methods seem to be mutually confirmatory and to give results which converge towards some value near 60 or perhaps 65 million years.

This being granted, it follows that radioactive minerals cannot have the great ages which have been attributed to them. Only something like a tenth of the heat emitted by the earth can be ascribed to radioactivity plus all other exothermic chemical transformations; the remaining nine-tenths is heat due to compression.



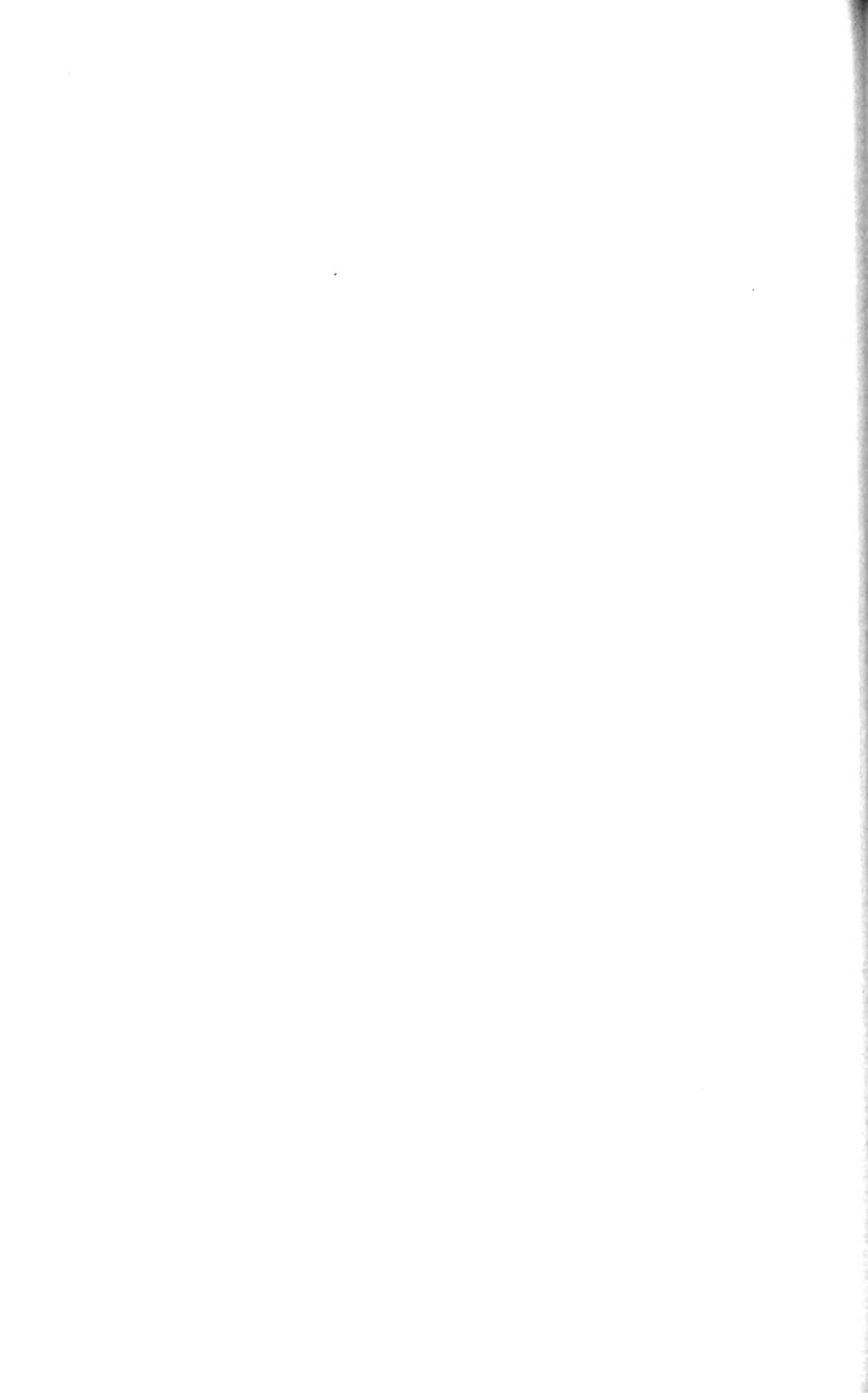



SMITHSONIAN MISCELLANEOUS COLLECTIONS

VOLUME 56, NUMBER 7

DESCRIPTION OF A NEW SUBSPECIES  
OF AFRICAN MONKEY OF THE  
GENUS CERCOPITHECUS

BY

D. G. ELLIOT



PUBLICATION 1937)

CITY OF WASHINGTON  
PUBLISHED BY THE SMITHSONIAN INSTITUTION

June 11, 1910

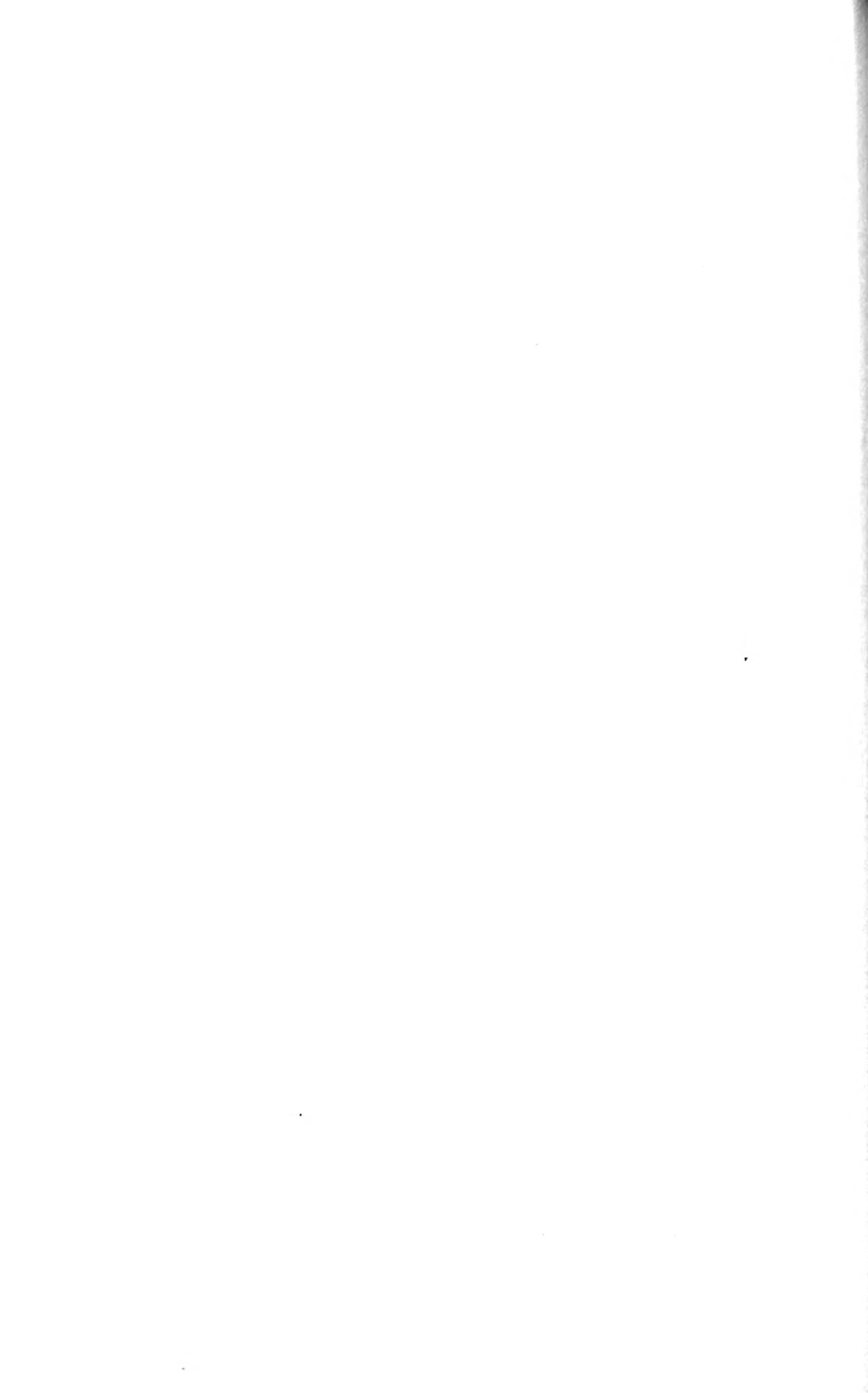

DESCRIPTION OF A NEW SUBSPECIES OF AFRICAN  
MONKEY OF THE GENUS CERCOPITHECUS

By D. G. ELLIOT

The species of monkey here described was obtained by the Smithsonian African Expedition in British East Africa, in 1910, and I am indebted to the authorities of the U. S. National Museum for the privilege of making it known to naturalists.

**CERCOPITHECUS CENTRALIS LUTEUS**, subsp. nov.

*Type locality*.—Wambugu, southwest of Mount Kenia, British East Africa. Type, U. S. National Museum, No. 163086. Original No. 7190.

*General characters*.—Remarkable for the buff underparts of the body.

*Color*.—Black line formed of long hairs over eyes, succeeded by a cream buff broader band; rest of head and upper parts of body ochraceous buff, the hairs being grayish at base, then banded with black and ochraceous buff and tipped with black, but the paler color predominates the dark; flanks paler, outer side of arms and thighs dark gray, the hairs tipped with white; outer side of legs to ankles smoky gray, hairs white tipped; chin black; cheeks, throat, and entire underparts of body and inner side of limbs buff; hands black; feet iron gray; tail at base above like back, then gray rather whitish tips to hairs, and tip black; beneath whitish.

*Measurements*.—Total length, 990 mm.; tail, 570; foot, 120; ear, 28.

*Skull*.—Total length, 90.7; occipito-nasal length, 79.4; hensenel, 60.3; zygomatic width, 61.1; intertemporal width, 43.6; palatal length, 31; median length of nasals, .94; length of upper molar series, 23.8; length of mandible, 67; length of lower molar series, 29.9.

This species is somewhat similar to *C. c. johnstoni*, from the south side of Mount Kilimanjaro, but differs altogether in its buff underparts and inner side of limbs, thus contrasting strongly with the yellowish white of *C. centralis* and the grayish white of *C. c. johnstoni* and *C. c. wchytci*. Two examples, both young adults, females, were in the collection.



SMITHSONIAN MISCELLANEOUS COLLECTIONS

VOLUME 56, NUMBER 8

NOTES ON A HORN-FEEDING  
LEPIDOPTEROUS LARVA  
FROM AFRICA

WITH TWO PLATES

BY

AUGUST BUSCK



(PUBLICATION 1941)

CITY OF WASHINGTON  
PUBLISHED BY THE SMITHSONIAN INSTITUTION  
JULY, 1910

The Lord Baltimore Press  
BALTIMORE, MD., U. S. A.

# NOTES ON A HORN-FEEDING LEPIDOPTEROUS LARVA FROM AFRICA

BY AUGUST BUSCK

(WITH TWO PLATES)

Among the zoological objects secured by the Smithsonian African Expedition, under the direction of Col. Theodore Roosevelt, is a skull of a large Water Antelope (*Cobus* sp.) on the magnificent (over two feet long) horns of which was a large number of curious larvæ tubes of a microlepidopteron, *Tinea vastella* Zellar.

The skull is evidently not of an animal shot by the party, but was picked up on the ground. It bears the label No. 6825 S. N'guasso Nyiro River, British East Africa, June, 1909.

The evidence of moth-infestation on the horns was very striking and is well illustrated in the two excellent photographs, reproduced on plates 1 and 2, for which I am indebted to Mr. T. W. Smillie. It consists of large bunches of dark brown finger-like tubes each about  $\frac{1}{4}$  of an inch in diameter and anywhere from  $\frac{1}{2}$  to  $2\frac{1}{2}$  inches long. These tubes are very tough, being made of silk, into which is incorporated earth and chewed-up fiber of the horn; the interior of the tubes is smooth gray silk. The tubes are closed at their outer end like the fingers of a glove and are connected at their basal end with round holes leading into galleries in the horn, where the larvæ found their nourishment.

Accounts of similar infestations of horns of ruminants have occurred from time to time and they seem particularly common in Africa.

There has been some difference of opinion among the observers about the possibility of the horns of living ruminants becoming infested and some of the evidence seems sufficiently conclusive that such infestation may occasionally occur. The substance of the horn is the same in the living animal as in the dead, and it seems at least possible that the moth may deposit its eggs on the horns of a resting or sleeping animal, and that the larvæ in such case could develop successfully, but this is undoubtedly the exception and the species normally only attacks the horns of dead animals.

Lord Walsingham has given a review of the subject (Proc. Ent. Soc., London, 1881, pp. 238-241) but no figure has been given of this infesta-

tion except the rather primitive sketch accompanying the account of Mr. N. H. Corquodale on the infested horns of a hartebeest in *Nature*, Vol. 58, 1898, p. 140. This sketch differs in some particulars from the present specimens; it figures the larvæ tubes as single and coming from all parts and sides of the horns, while in the present specimen they are more or less bunched and matted together, though a few single tubes were found; more important than this, the present specimens were confined to the side of the horn, which had evidently been toward the ground, and besides particles of the horn they had incorporated in them a good proportion of earth. The explanation of this may be that Mr. Corquodale's horns have become infested while or just before they were boxed for shipment and that the larvæ constructed their tubes in different directions, due to the varying position of the box, which was no doubt frequently changed during transit.

While the present cases presumably are the work of *Tinea vastella* Zellar, which seems to be common everywhere in Africa, and which is credited with all the recorded infestations from Africa, it should be remembered that other species of the genus have similar habits, and that more than one species may be involved. Stainton described one species, *Tinea orientalis*, bred from horns in Singapore, and the writer has seen similar work in horns of domestic cattle lying on the ground at Fajardo, Porto Rico; in fact the habit is parallel with and very similar to those of the common tubemaking cloth moth *Tinea pellionella* Linné.





HORN-FEEDING LEPIDOPTEROUS LARVA



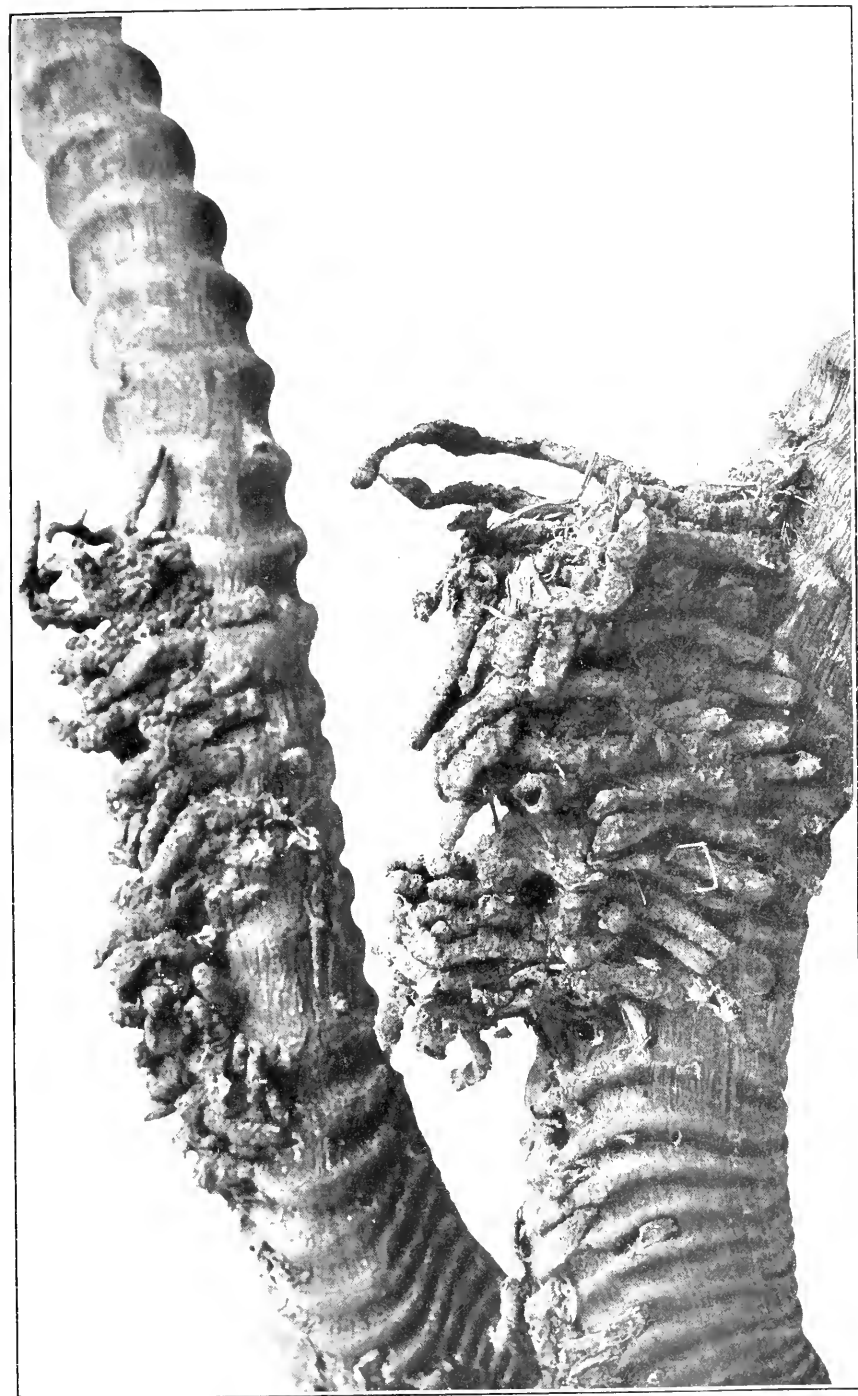

HORN-FEEDING LEPIDOPTEROUS LARVA



SMITHSONIAN MISCELLANEOUS COLLECTIONS

VOLUME 56, NUMBER 0

DESCRIPTIONS OF SEVEN NEW SPECIES  
OF EAST AFRICAN MAMMALS

WITH THREE PLATES

BY

EDMUND HELLER

Field Naturalist Smithsonian African Expedition



(PUBLICATION 1942)

CITY OF WASHINGTON  
PUBLISHED BY THE SMITHSONIAN INSTITUTION  
July 22, 1910

WASHINGTON, D. C.  
PRESS OF JUDD & DETWEILER, INC.  
1910

DESCRIPTIONS OF SEVEN NEW SPECIES OF EAST  
AFRICAN MAMMALS

(WITH THREE PLATES)

BY EDMUND HELLER

FIELD NATURALIST, SMITHSONIAN AFRICAN EXPEDITION

The seven species and subspecies of mammals here described were collected by members of the Smithsonian African Expedition. This paper is the ninth dealing with the results of the expedition.

**TATERA VARIA, new species**

Type from the Loletai Plains, Southern Guaso Nyiro River. Sotik District, British East Africa; adult male, number 162249, U. S. Nat. Mus.; collected by J. A. Loring, June 15, 1909; original number 6338.

*Coloration.*—Dorsal coloration tawny ochraceous overlaid faintly with blackish posteriorly; sides lighter, pure ochraceous without any black intermixture, the ochraceous not very sharply defined from the pure white of the underparts; area between eye and ear, and spot behind ear whitish. Underparts pure white, the hair white to the roots. Feet white. Ears dusky, very sparingly haired. Tail clothed with white hair except the dorsal surface of the anterior half, which is tawny like the back.

*Measurements.*—Head and body, 169 mm.; tail, 239; hind foot, 43. Skull: condylo-nasal length, 45.5; basilar length, 36.5; palatilar length, 22; zygomatic breadth, 24; nasal, 20; interorbital constriction, 8; diastema, 13.5; maxillary toothrow, 7.5.

Most closely allied to *fallax*, from which it is distinguishable chiefly by its longer pencillate tail and the larger audital bullæ.

This species shows great variation in the character and number of the longitudinal grooves of the upper incisors. This variation extends from incisors which show no grooves to specimens showing as many as three grooves to each incisor. In a series of fourteen fully adult skulls from the same locality there are five specimens which show no indication of grooving even under magnification, three which show only one groove, five which have two grooves to each incisor, and one which possesses three grooves. The grooving

in all these specimens is rather shallow, and so faint that usually only one groove is evident without magnification.

#### TATERA POTHÆ, new species

Type from Potha, Kapiti Plains, British East Africa; adult female; number 161716, U. S. Nat. Mus.; collected by J. A. Loring, April 30, 1909; original number 6013.

*Coloration.*—Above tawny-ochraceous lightly lined with blackish hairs posteriorly. Tip of snout black. Eyes narrowly ringed with black; a white spot between eye and ear and a partially hidden one at posterior base of ear. Color of sides of head and body changing from the darker dorsal area through ochraceous to ochraceous-buff, but sharply defined against the pure white of the underparts. Ears thinly haired with blackish. Feet white; inside of hind limbs about ankle blackish. Underparts pure white, the hair white to the roots. Tail above brownish, the color deepening and spreading to under side on tip, where it becomes black; below, anteriorly, ochraceous like sides.

*Measurements.*—Head and body, 152 mm.; tail, 203; hind foot, 40. Skull: condylo-nasal length, 42.5; basilar length, 33; zygomatic breadth, 21.5; interorbital constriction, 7; nasal, 20; diastema, 11.2; maxillary tooththrow, 7.

This form is most closely allied to *vicina* of Kitui, which is a smaller-footed and darker-colored race with smaller teeth. From *mombasæ* it differs in its shorter ears, much heavier and longer hair and the absence of the median dark stripe on the inferior surface of the tail.

#### EPIMYS PANYA, new species

Type from Juja Farm, Athi Plains, British East Africa; adult male; number 161886, U. S. Nat. Mus.; collected by J. A. Loring, May 23, 1909; original number 6220.

*Coloration.*—Above buffy, overlaid by black, the individual hairs medially buffy brown with black tips, interspersed with longer black hairs. Sides purer buff, merging gradually into the grayish of the under parts. Under parts whitish with a faint buffy tinge, the hairs slaty at base. Feet white. Ears blackish and appearing quite naked, but clothed sparingly by minute hairs. Tail naked, uniform dusky.

*Measurements.*—Head and body, 119 mm.; tail, 119; hind foot, 22.5. Skull: condylo-nasal length, 29.5; basilar length, 23.5; zygomatic breadth, 14.4; nasal, 11.8; interorbital constriction, 4; diastema, 8; maxillary tooththrow, 5.1.



Closely allied to *hildebrandti* of the coast lowlands, which is a larger rufous brown form, and to *ugandæ*, which is darker and smaller. This is the most abundant mouse of British East Africa and the only native species which enters houses.

**EPIMYS NIVEIVENTRIS ULÆ, new species**

Type from the Ulu Kenia Hills, British East Africa: adult female; number 162887, U. S. Nat. Mus.; collected by J. A. Loring, November 19, 1909; original number 8221.

*Coloration*.—Above wood brown becoming lighter on the sides, but sharply defined from the pure white of the under parts; hairs of dorsal region wood brown, with dark blackish tips, the median dorsal area darkest. Ears dusky, clothed sparingly with minute brown hairs. Feet and under parts pure white, the hairs everywhere white to the roots. Tail dusky above, whitish below, but not sharply bicolor; clothed with brown hair, which becomes somewhat more abundant at tip, but not distinctly pencillate.

*Measurements*.—Head and body, 88 mm.; tail, 128; hind foot, 19.5. Skull: condylo-nasal length, 26.5; basilar length, 20.8; zygomatic breadth, 14; nasal, 11; interorbital constriction, 4.2; diastema, 7; maxillary toothrow, 4.4.

Allied to *subfuscus*, Osgood, of the Rift Valley, from which form it differs in smaller proportions and the greater extent of the white of the under parts. This mouse occurs abundantly on the rocky kopjes of the Athi Plains.

**EPIMYS ENDOROBÆ, new species**

Type from the western edge of the Mau Forest, 25 miles north of Edoma Ravine, altitude 8,600 ft.; adult male; number 162888 U. S. Nat. Mus.; collected by Edmund Heller, November 27, 1909; original number 1261.

*Coloration*.—Median dorsal area from snout to base of tail hair brown, darkest on mid-line of back and merging on sides of head and body to ochraceous buff; lower sides fulvous, sharply defined from the whitish of the under parts. Ocular region and sides of snout blackish. Under parts white, tinged lightly with buffy, the hair broadly blackish slate at base. Feet white. Ears blackish, clothed sparingly with minute brownish hairs. Tail quite naked at base, dusky, becoming hairy toward tip, the terminal half inch white.

*Measurements*.—Head and body, 100 mm.; tail, 151; hind foot, 20; ear, 19.5. Skull: condylo-nasal length, 28.5; basilar length,

22; zygomatic breadth, 14; nasal length, 10.8; interorbital constriction, 4; diastema, 7.5; maxillary toothrow, 4.8.

Closely allied to *denniae*, Thomas, of Ruwenzori, from which it may be distinguished by its much darker coloration, smaller ears, and larger molars.

This species is found only in the forest region, where it is everywhere associated with *E. peromyscus*.

#### TACHYORYCTES REX, new species

Type from the western slope of Mt. Kenia, altitude 10,000 ft.: adult male; number 163088, U. S. Nat. Mus.; collected by J. A. Long, October 7, 1909; original number 7840.

*Coloration*.—Dorsal coloration brownish fulvous, overlaid faintly with blackish posteriorly, tip of muzzle blackish; hair everywhere dark slate at base. Under parts lighter, more tawny fulvous, with the plumbeous showing through conspicuously; small area about mouth white; throat blackish. Feet broccoli brown, the toes whitish. Tail dusky above, whitish below.

*Measurements*.—Head and body, 232 mm.; tail, 59; hind foot, 31. Skull: condylo-basal length, 54.5; basal length, 51; zygomatic breadth, 39; nasals, 23 x 7.2; length of bullæ, 11.8; diastema, 20; maxillary toothrow, 10.5; diameter of m<sup>1</sup>, 4.

Size large, exceeding all other East African races. This species is most closely allied to *audax*, of the Aberdare Range, in skull characters. Teeth actually larger, but proportionately somewhat less, than those of *audax*. Nasals much longer and with lateral re-entrant angles present. In coloration this form is somewhat lighter than *audax*, and agrees with it further in seldom being subject to melanism. Compared to *annectens*, of Naivasha, which nearly equals it in size, the teeth and nasal bones are markedly larger, the basioccipital is much broader between the bulke and the mandible, has a much larger condyle and coronoid process, with the incisor capsule placed very much farther forward. It is evident that in the alpine races of this genus the teeth are much enlarged.

This is an extremely abundant species on Mt. Kenia, where it inhabits a narrow zone at the upper edge of the bamboo forest where the moorland country first makes its appearance. The species is not found immediately below this area in the bamboo or yew forests, but another species appears on the grassy plains at the base of the mountain.

**CROCIDURA ALPINA**, new species

Type from the west slope of Mt. Kenia, altitude 10,000 ft., British East Africa; adult female; number 163089, U. S. Nat. Mus.; collected by J. A. Loring, October 4, 1909; original number 7728.

*Coloration*.—Dorsal coloration Prout brown, changing on lower sides gradually to the buffy gray of the under parts. Feet lighter, wood brown. Tail above like back; below light buffy, but not sharply bicolor.

*Measurements*.—Head and body, 65 mm.; tail, 39; hind foot, 11. Skull: condylo-incisive length, 16.2; breadth of brain-case, 7.5; depth of skull at bullæ, 4.6; length of upper toothrow, 7.

This species is closely allied to *alex*, from which it may be distinguished by its much flatter skull (one-half millimeter less), relatively small upper middle incisor, and by its bicolor tail and lighter coloration generally.

It is surprising to find this pygmy shrew in the alpine region of Kenia. The closely allied *alex* inhabits the lake district of Naivasha, the intermediate region about the base of Kenia being inhabited by the much larger *hildegardæ*. The range of this species extends from 10,000 to 13,700 ft.—that is, from the upper limit of the bamboo forest to the lower part of the giant *Senecio* zone. Through most of this extent it is associated with the giant *Crocidura*, *C. nyansæ*, attaining, however, a somewhat higher altitude than this species.



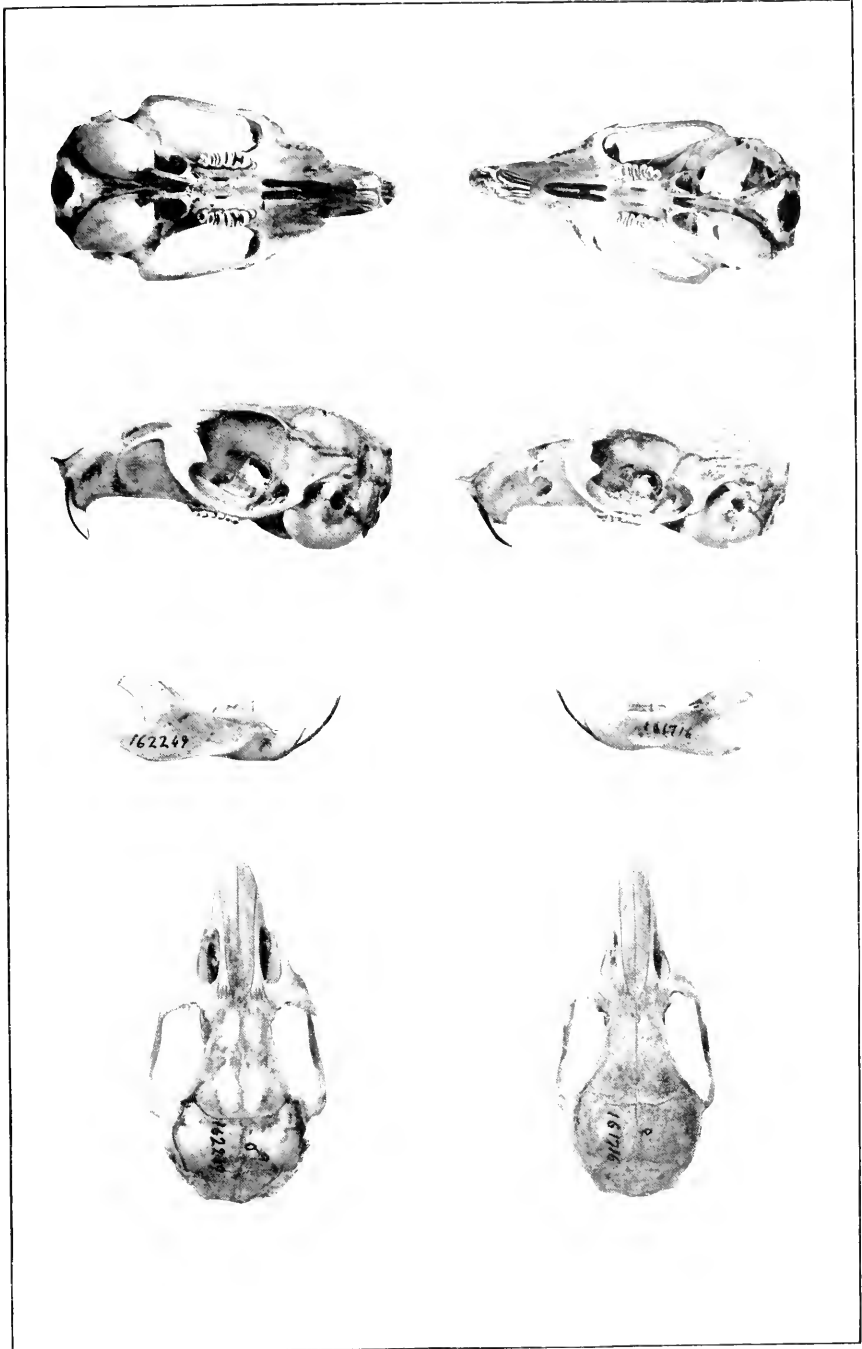

TATERA VARIA HELLER  
Type. Natural size

TATERA POTHÆ HELLER  
Type. Natural size



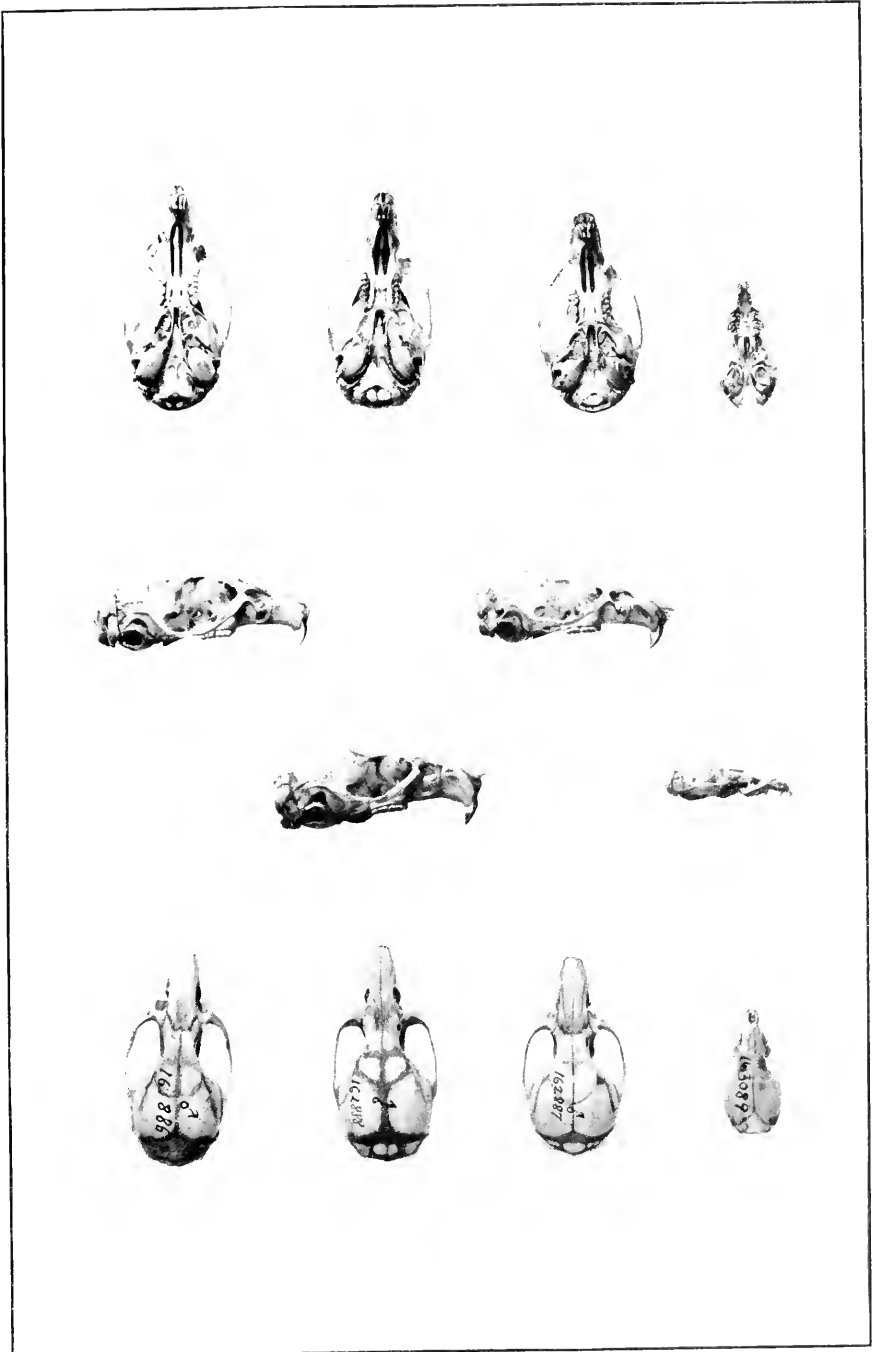

EPIMYS PANYA HELLER  
Type. Natural size

EPIMYS NIVEIVENTRIS ULÆ HELLER  
Type. Natural size

EPIMYS ENDOROBÆ HELLER  
Type. Natural size

CROCJDURA ALPINA HELLER  
Type. Natural size





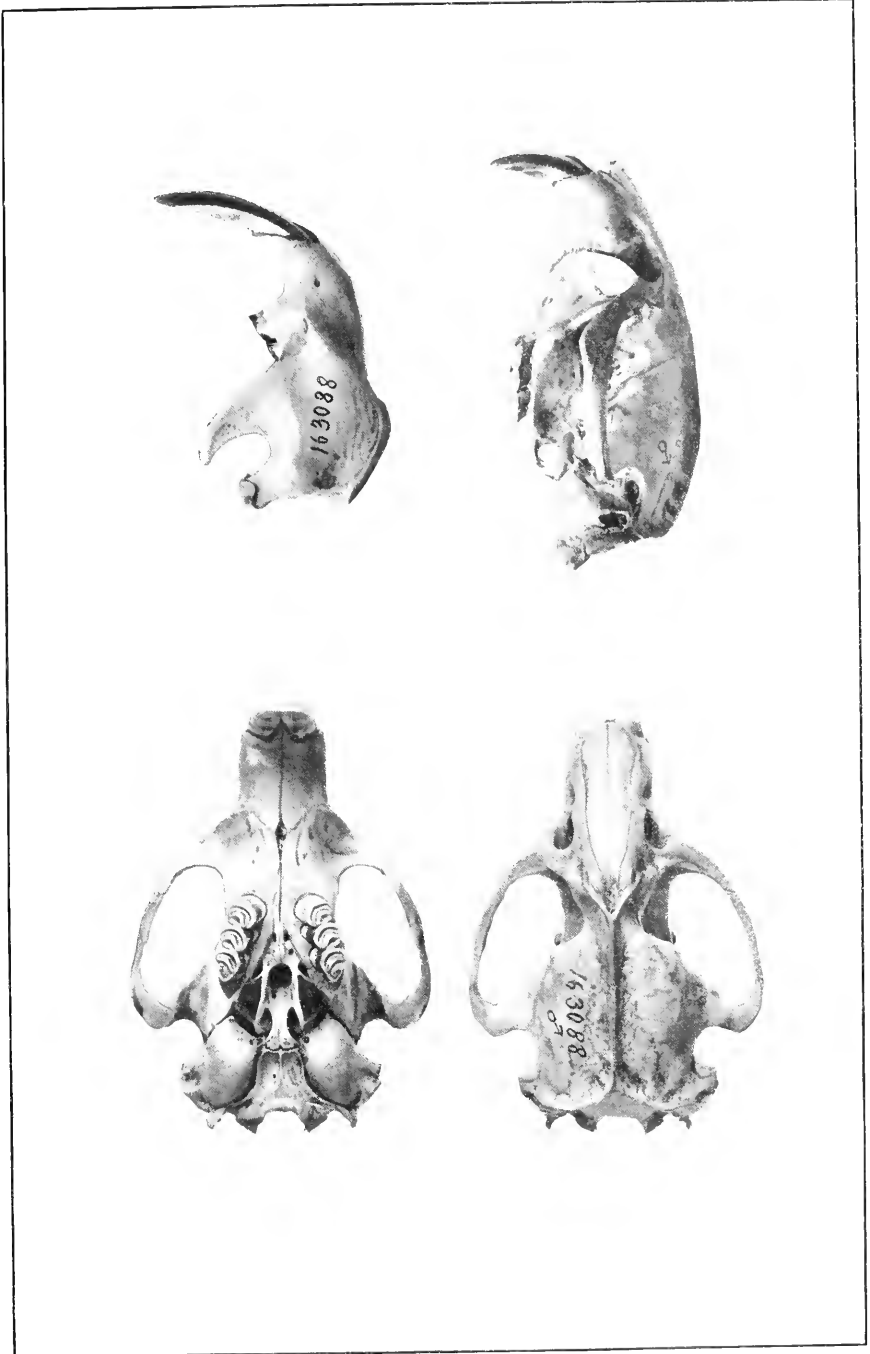

TACHYORYCTES REX HELLER  
Type. Natural size



SMITHSONIAN MISCELLANEOUS COLLECTIONS

VOLUME 56, NUMBER 10

# NEW LANDSHELLS FROM THE SMITHSONIAN AFRICAN EXPEDITION

BY

WILLIAM HEALEY DALL



(PUBLICATION 1945)

CITY OF WASHINGTON  
PUBLISHED BY THE SMITHSONIAN INSTITUTION  
July 22, 1910

WASHINGTON, D. C.  
PRESS OF JUDD & DETWEILER, INC.  
1910

NEW LANDSHELLS FROM THE SMITHSONIAN  
AFRICAN EXPEDITION

By WILLIAM HEALEY DALL.

The landshells collected by the Smithsonian African Expedition, under the direction of Col. Theodore Roosevelt, were chiefly of the characteristic East African types, *Limicolaria* and the like, which will take a good deal of careful study to work out, since the species are variable and many names have been applied to them. It appears, however, that there are three species which are undescribed and sufficiently well marked to render descriptions desirable in advance of the proposed general report on the collection. Two of these belong to a special group under *Buliminus* (sensu lato), and the other is a *Limicolaria*.

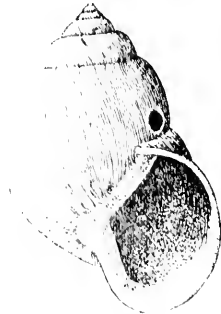

FIG. 1

**BULIMINUS ROOSEVELTI**, new species (Fig. 1)

Shell short, stout, solid, the last whorl much the largest, the color varying from a vinose purple-brown to opaque white; nucleus of about three whorls, smooth and polished, merging, without marked interruption, into the sculpture of the four subsequent whorls; these have minute retractive wrinkles, feebly fasciculated, stronger and more distant on the early whorls, closer and finer on the later ones, with an obscure tendency toward minute puckering at the suture; these axial wrinkles are broken into granules or segments on the last two whorls by spiral depressed lines, to which are added on the last half of the last whorl more or less irregular, sometimes angular.

sharp, short incisions, tending in the same direction; suture well marked, more or less minutely undulated by the sculpture; whorls inflated, the last slightly descending toward the aperture, the base swollen, with no umbilicus; the aperture rounded-quadrate, strongly expanded and reflected, though with only a thin glaze over the body; peristome yellowish white, the throat purple-brown, or both may be lighter in some specimens; pillar short, stout, straight, with no indication of a fold, the lip behind it heavy and folded over on the base. Height of shell, 33.0; of last whorl, 22.0; of aperture, 19.0; max diameter, 20.5 mm.

Collected by Lt. Col. E. A. Mearns on Mt. Kenia, at the height of 8,000 to 10,500 feet above the sea. U. S. N. Mus. No. 214,300.

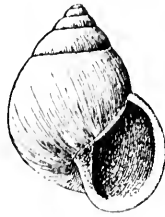

FIG. 2

**BULIMINUS MEARNsii**, new species (fig. 2)

Shell in general resembling the preceding species, but much smaller, having about six whorls in all, with similar but more delicate sculpture, the suture of the last whorl appressed, the color generally paler; the spire with its sides more flattened; the reflected lip is white, the throat pinkish brown; there is a narrow but distinct and deep umbilical perforation, only partially overshadowed by the reflected pillar-lip; height, 25.0; of last whorl, 19.5; of aperture, 14.0; max. diameter, 16.0 mm.

Collected by Lt. Col. E. A. Mearns in the southern part of N'Guaso Nyiro, British East Africa. U. S. N. Mus. No. 214,299.

A section shows that the umbilical perforation expands considerably inside the axis of the last whorl and continues through the axis in the penultimate whorl, though more contracted. The external orifice of the umbilicus is in rare specimens almost covered by the reflected lip, while in *B. roosevelti*, with equal rarity, a minute chink is left exposed by the lip, but the axis is more slender than in *B. mearnsii*, though the latter is much the smaller shell.

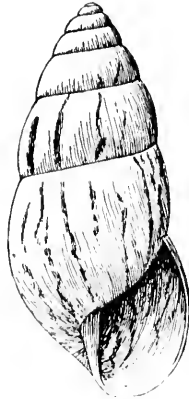

FIG. 3

**LIMICOLARIA CATHARIA**, new species (Fig. 3)

Shell slender, thin, polished, smooth, with a very thin yellowish periostracum (which is usually lost), milky white with narrow, more or less undulated, brown axial lines, with much wider interspaces, usually about fifteen or sixteen in number to the whorl; nucleus glassy, of two or three microscopically pinctate whorls, rather blunt at the apex; followed by five or six subsequent slightly convex whorls; suture distinct, not deep; surface apt to be pitted by weathering, but normally smooth or very faintly, locally, absoletely wrinkled; the individuals vary somewhat in stoutness; aperture comparatively small, a thin glaze on the body, outer lip sharp and thin; pillar short, straight, really white, but frequently having a blackish appearance from dirt being included in the narrow axial perforation which is not quite covered by the reflected pillar. Dimensions of two contrasted individuals in millimeters:

Whorls	Height of shell	Of last whorl	Diameter
7½	42.0	26.5	20.0
7½	46.0	28.0	18.5

Collected by Lt. Col. E. A. Mearns on the Kapiti plains, Uganda Railway, British East Africa. U. S. N. Mus. No. 214,301.

A large number of this species was collected, and the peculiar whiteness of the shell, even when not bleached by the sun, is unusual in the group, and hardly obscured by the delicate periostracum.

In general outline the species is not unlike *L. connectens* Martens, of German East Africa, which has, however, a more or less granulose sculpture.

















SMITHSONIAN MISCELLANEOUS COLLECTIONS

VOLUME 56 NUMBER 11

DEVELOPMENT OF THE DIGESTIVE  
CANAL OF THE AMERICAN  
ALLIGATOR

WITH FIFTEEN PLATES

BY

ALBERT M. REESE

Professor of Zoology, West Virginia University



(PUBLICATION 1946)

CITY OF WASHINGTON  
PUBLISHED BY THE SMITHSONIAN INSTITUTION  
1910

**The Lord Baltimore Press**

BALTIMORE, MD., U. S. A.



# DEVELOPMENT OF THE DIGESTIVE CANAL OF THE AMERICAN ALLIGATOR

By ALBERT M. REESE

Professor of Zoology, West Virginia University

---

In a previous paper (6) the writer described the general features in the development of the American Alligator; and in other papers special features were taken up in more detail.

In the present paper the development of the enteron is described in detail, but the derivatives of the digestive tract (liver, pancreas, lungs, etc.) are mentioned only incidentally; the development of these latter structures may be described in a later paper.

No detailed description of the histological changes taking place during development has been attempted, though a brief description of the histology is given for each stage discussed.

The material upon which this work was done is the same as that used for the preceding researches. It was collected by the author in central Florida and southern Georgia by means of a grant from the Smithsonian Institution, for which assistance acknowledgment is herewith gratefully made.

Various methods of fixation were employed in preserving the material. In practically all cases the embryos were stained in toto with Borax Carmine and on the slide with Lyon's Blue. Transverse, sagittal, and horizontal sections were cut, their thickness varying from five to thirty microns, depending upon the size of the embryos.

The first indication of the formation of the enteron is seen in the very early embryo shown, from the dorsal aspect, in figure 1. The medullary folds and notochord are evident at this stage, but no mesoblastic somites are to be seen.

A sagittal section of approximately this stage, shown in figure 1A, represents the foregut, *fg*, as a shallow enclosure of the anterior region of the entoderm, while the wide blastopore, *blp*, connects the region of the hindgut with the exterior. No sign of a tail fold being present, there is, of course, no real hindgut. The entoderm, which has the appearance of being thickened because of the fact that the notochord has not yet completely separated from it, is continuous, through the blastopore, with the ectoderm. Posterior to the blas-

topore the primitive streak, *ps*, is seen as a collection of scattered cells between the ectoderm and the entoderm, apparently formed by proliferation from the ventral side of the ectoderm.

A slightly later stage is shown in figure 2, a dorsal view of an embryo with five pairs of mesoblastic somites. A sagittal section of this stage is shown in figure 2A. The foregut is here more inclosed, and the notochord, *nt*, having separated from the entoderm, *en*, is seen as a distinct layer of cells extending from the foregut to the blastopore.

A transverse section through the headfold of this stage is shown in figure 2B. The foregut is seen as a wide cavity, *ent*, depressed dorsally, apparently, by the formation of the medullary groove and the notochord; it is wider laterally than in a dorso-ventral direction, and its walls are made up of about three layers of closely arranged, irregular cells; the wall is somewhat thinner on the dorsal side, just below the notochord.

Figure 3 is a dorsal view of the next stage to be described; about fifteen pairs of somites are present.

Figure 3A is a transverse section through this embryo near the anterior end of the enteron, *ent*, which cavity, cephalad to this region, is bluntly pointed. As seen in the figure the enteron is here wide from side to side, and is depressed dorso-ventrally except for a wide groove in the ventral wall. This groove is lined with rather more closely arranged cells, and marks the region where the mouth will break through at a somewhat later stage. A short distance caudad to this region the groove disappears and the pharynx is reduced to a shallow slit extending almost to the superficial ectoderm on either side; then the slit-like pharynx becomes suddenly reduced in a lateral and increased in a dorso-ventral direction, to assume the outline shown in figures 3B and 3C. At a point about one-third of the length of the embryo from the tip of the head, the enteron opens to the yolk-sac, so that what now may be called the foregut has this considerable extent. There is, however, not the slightest indication of a tail-fold, so that there is no inclosed hindgut at all. As is shown in figure 3D, the neurenteric canal, *nc*, still opens ventrally, though the medullary canal, *mc*, has now no dorsal opening to the exterior. The medullary canal continues for a short distance (about fifteen sections of five microns thickness) posterior to the opening of the neurenteric canal.

Figure 4 is a surface view of the next stage to be described. There are here about twenty pairs of somites, though the exact number cannot be determined. Although not visible externally in the surface view shown, the gill clefts are beginning to form, and the first one opens to the exterior as will be seen in sections of another embryo

of this stage. The mouth has now broken through, putting the wide pharynx into communication with the exterior; probably the mouth opening is formed at about the time of the opening of the first gill cleft.

Figure 4A represents a transverse section through the head of an embryo of the approximate age of the one just described; it passes through both forebrain, *fb*, and hindbrain, *hb*; through the extreme edge of the optic vesicles, *ov*, and through the anterior end of the notochord, *nt*. It is just cephalad to the anterior end of the pharynx and to the hypophysis. The chief purpose in showing this section is to represent the two large head-cavities, *hc*. The origin of these cavities may be discussed at a later time. They are irregularly oval in cross section, and extend in an antero-posterior direction for a distance about equal to their long axis as seen in cross section. The two cavities project towards each other in the middle line, and are almost in contact with the notochord, in the region figured, but they do not fuse at any point. These two head-cavities are the only ones to be seen, in this animal, unless the small evaginations from their walls represent other cavities fused with these. Their walls are thin but distinct, and consist of a single layer of cells. These cells are completely filled with their large, round nuclei, so that the wall has the appearance, under higher magnification than is used in this figure, of a band of closely strung, round beads.

Figure 4B represents the eighteenth section caudad to the one just described. It passes through that region of the enteron, *ph*, which may be called the pre-oral gut, since it lies cephalad to the now open mouth. Owing to the plane of the section the upper angle of the first gill cleft, *g*<sup>1</sup>, is seen on the left, although this would not naturally have been expected in a section through the pre-oral gut. The evagination to form the hypophysis, *p*, is seen against the floor of the forebrain, *fb*. The wall of this region of the enteron is comparatively thin, and consists of not more than two layers of compactly arranged cells with round nuclei.

Figure 4C is about forty sections caudad to the one just described. It passes through the mouth, seen as a vertical opening between the two mandibular arches, *md*. The hyomandibular cleft, *g*<sup>1</sup>, the only one which opens to the exterior in this embryo, is very wide, and may be traced through a number of sections; in this section the opening is seen only on the left. The pharynx, *ph*, is very wide; as it is followed caudad its ventral opening is gradually closed by the approach of the two mandibular folds. The dorsal wall of this region of the pharynx is very thin, consisting of a single layer of flat cells with round nuclei; while the ventral wall, leading through

the mouth and lining the mandibular folds, is composed of two or three layers of compactly arranged cells.

Figure 4D is through a plane sixteen sections caudad to the last. In this region, which is just caudad to the otic vesicles, the pharynx has still its rectangular outline, and its walls are of the same character as in the preceding figure. The posterior edges of the hyomandibular clefts are seen projecting in a ventro-lateral direction,  $g^1$ ; while dorsal to these are the wider, second pair of clefts,  $g^2$ . Where the mandibular folds come together posterior to the mouth, they fuse first at their outer or ventral border, which leaves a deep, narrow groove in the anterior floor of the mouth. As this groove is followed caudad its ventral wall is seen to become much thickened,  $tg$ , to form the *anlage* of the thyroid gland. In the present section the walls of the groove are just fusing, to cut off the cavity of the gland from the dorsal part of the groove. The next section caudad to this shows the thyroid as a round, compact mass of cells, with a very small lumen, still closely fused with the bottom of the oral groove. The lumen may, in this embryo, be traced for only a few sections, caudad to which the thyroid is seen as a small, solid mass of cells unattached to the oral groove. Close to the sides of the thyroid are seen two large blood vessels,  $ar$ , the mandibular arches, which unite into the single ventral aorta just caudad to the posterior end of the thyroid. High power drawings of the thyroid just described are shown in figures 4E and 4F.

Figure 4G is about fifty-five sections caudad to the preceding figure, and passes through the middle region of the heart,  $ht$ . The enteron,  $ent$ , is cut caudad to the last gill cleft, but it is nearly as large as in the pharyngeal region described above; its walls are of a more even thickness than in the more anterior sections, though there is an area, just below the aorta, where the wall is still but one cell thick. In the ventral wall of this part of the enteron, and, to some extent, in the lateral walls, there seems to be a tendency for the nuclei to become collected toward the side of the wall away from the digestive cavity; this condition cannot be well seen in the figure owing to the amount of reduction in reproduction.

Figure 4H is seventy-nine sections posterior to the last, and passes through the foregut,  $ent$ , just cephalad to the anterior intestinal portal and caudad to the heart. The outline of the enteron is here almost a vertical slit, and the lining entoderm consists, in its dorsal and lateral regions, of a single layer of columnar epithelium, while in its ventral region, where it adjoins the liver trabeculae, it is made up of several layers of cuboidal or irregular cells. The nuclei in the dorsal and lateral regions of the entoderm are arranged in a very definite layer

at the basal ends of the cells, though an occasional nucleus may be seen near the center of the layer. The mesoderm that extends ventrad from the mesentery, on each side of the entoderm just described, consists of a thick layer of compactly arranged cells. The ventral end of the entodermal wall is fused with the wall of a small cavity, *li*, which may be traced several sections cephalad to this plane. This cavity is a part of the system of hollow liver trabeculae seen as a group of irregular masses of cells ventrad to the enteron at the opening of the anterior intestinal portal. The large blood vessel, *bv*, is the meatus venosus.

Figure 4I is just four sections caudad to the preceding. It passes through the anterior intestinal portal, *aip*. The medial liver trabecula into which the enteron was seen to open, in the preceding figure, now opens ventrally to the yolk-sac as the anterior intestinal portal. A few liver trabeculae are to be seen on either side of the portal, but they show no lumena, and may be traced through only a few sections. The extent of this uninclosed region, the midgut, is very difficult to determine with accuracy, but, at this stage, it comprises about one-half of all the sections of the series. The difficulty is due partly to the unavoidable tearing of the tissues in removing the embryo from the yolk-sac, and partly to the indefiniteness of the posterior intestinal portal, where the walls of the enteron are very thin. As seen in figure 4I the location of the anterior intestinal portal is very distinct.

A short distance caudad to the anterior intestinal portal there is constricted off from the roof of the midgut a narrow diverticulum, figure 4J, *i*, the meaning of which is not apparent; it extends through only ten to fifteen sections, tapering caudad till it disappears. The region of the hindgut, at this stage, is about one-fifth of the entire length of the embryo. Its anterior portion is wide and, as has been said, rather indefinite in outline.

Figure 4K represents a typical section through the midgut region of an embryo of about the age of the one from which the preceding figures were drawn. This and the following figures of this stage were drawn from an embryo in which the posterior region was in better condition than in the embryo from which the other figures of the stage were taken. The mesentery, *ms*, is here of considerable length and continues around the yolk in a layer of diminishing thickness. The epithelium of this region of the enteron consists of a single layer of fairly regular cells, which are columnar in the dorsal region, just beneath the mesentery, and cuboidal or even flattened in regions more distant from the median plane.

Figure 4L, through the region of the hindgut, shows at *i* the completely inclosed intestine; it is a comparatively narrow tube, lined

with columnar epithelium outside of which is a dense layer of mesoblast continuous with the mesentery. In the center of the figure the allantois, *al*, is seen as an irregular cavity, lined with a single layer of columnar or cuboidal cells, and surrounded by a thick mass of loosely arranged, stellate mesoblast cells. The allantois is probably somewhat larger here than in the other embryos used for this stage, in which it was torn away. The tail, *t*, of the embryo is shown at the lower side of the figure, surrounded by the amnion; it is cut in the region of a curve so that the caudal intestine, *i*, is cut longitudinally and has the outline of an elongated ellipse. In this embryo the caudal intestine could be followed to the end of the tail, through several dozen sections; for some distance posterior to the allantois it is extremely narrow, so that its lumen is almost obliterated, and its walls are made up, in any one place, of not more than a dozen cuboidal cells. Towards the posterior end of this region the intestine is considerably enlarged as seen in figure 4L.

Figure 4M passes through the region where both the allantois and the Wolffian ducts open into the hindgut. The union of the allantois and the gut accounts for the elongated outline of the enteron in this section. The openings of the Wolffian ducts, *wdo*, are seen at the lower end of the section of the enteron. The cells lining the Wolffian ducts are smaller than those lining the enteron. In the lower side of the figure are seen the structures of the tail, including the outline of the tiny caudal intestine, *i*, mentioned above. No sign of a cloacal invagination could be made out with certainty.

The next stage to be studied is shown in surface view in figure 5.

Figure 5A represents a section through the head region of this embryo. Owing to the obliquity of the plane of the section the figure is quite asymmetrical. The pharynx, *ph*, is lined with a comparatively thin epithelium and opens, on the left, at two places, one the mouth and the other the second gill cleft, *g*<sup>2</sup>. In the dorsal wall of this cleft, as well as in the corresponding wall of the opposite cleft, is seen a thickening of the epithelium; these thickenings, *ty*, are the rudiments of the thymus gland, whose development may be described in detail in another paper. Compared to the size of the gill clefts the cavity of the pharynx is, at this stage, comparatively small.

Followed caudad the pharynx becomes depressed until, in the region shown in figure 5B, it is a mere narrow slit, *g*, extending transversely across the embryo and opening through the gill clefts to the exterior on each side.

Figure 5C passes through the posterior region of the pharynx, *ph*, the tip of the forebrain, *fb*, the anterior edge of the heart, *ht*, and the curve of the tail, *t*. The chief point of interest in this section is

the thyroid gland, *tg*. It now lies deep in the tissue of the floor of the pharynx, entirely separated from the pharyngeal epithelium. It consists of a compact mass of cells, now showing a bilobed structure in its anterior end, and extending through about twenty-five ten-micron sections. It is solid throughout most of its extent, but, in the section figured, which is near the anterior end, the lobe on the right side shows a small but distinct cavity scarcely visible in the figure.

Caudad to the region just described the pharynx contracts suddenly to form the oesophagus, a narrow, V-shaped slit, which soon divides into an upper and a lower cylindrical tube, figure 5b, *ent*.

Followed caudad the lower of these tubes divides into the two bronchial rudiments, figure 5E, *lu*, which, in the embryo here figured, extend through nearly one hundred sections. In the region shown in figure 5E the three tubes, *oe* and *lu*, lie at the angles of an imaginary equilateral triangle, while in the region of the liver, where the bronchial rudiments end, the tubes lie in the same horizontal plane.

A short distance caudad to the ends of the bronchial rudiments the oesophagus turns suddenly ventrad and becomes much enlarged to form the stomach, figure 5F, *st*, which may be traced through twenty-five or thirty sections in this series. The epithelium of the stomach is fairly thick, and consists of five or six layers of compact, indistinctly outlined cells with spherical nuclei. Ventrad to the stomach is seen, in figure 5F, a section of the duodenum, *i*, which extends, with gradually diminishing caliber, for twenty-five or thirty sections caudad to the posterior limit of the stomach, where it opens to the yolk-sac and is lost.

The section that cut this embryo in the posterior region of the stomach also passed through the hindgut in the region of the posterior appendages, figure 5G. There the intestine, *i*, is a distinct, cylindrical tube which extends, with not much variation in caliber, and with little variation in position, from this point to the cloaca. Followed cephalad, towards the posterior intestinal portal, it gradually diminishes in caliber, as did the foregut on approaching the anterior intestinal portal. The epithelium consists here of three or four layers of compactly arranged cells, and has about the same appearance as in the oesophagus and duodenum.

Figure 5H represents a section through the cloacal region, *cl*, showing the openings into the cloaca of the Wolffian ducts, *wdo*. Just anterior to these openings the cloaca opens ventrally into a small, anteriorly-projecting pouch, the rudiment of the allantois.

Caudad to the openings of the Wolffian ducts the cloaca extends

ventrad as a narrow, solid tongue of epithelium towards the exterior, figure 5I, and fuses with the superficial ectoderm at the caudal end of a prominent ridge that lies in the mid-ventral line between the posterior appendages. In this embryo the cloaca has no actual opening to the exterior; the walls of the part that projects towards the exterior are in close contact, except in the region of the openings of the Wolffian ducts, as is shown in figure 5H.

Owing to the coiling of the end of the long tail the plane of the section, as is seen in figure 5I, passes through the posterior end of the embryo no less than four times. In the most posterior of these four sections of the tail, beginning slightly caudad to the section here shown, is seen a small cavity which may be called the post-anal gut, *pag*. It has thick walls, and extends for about thirty-five sections in the series under discussion. Its lumen is very large in its caudal region, figure 5I, *pag*, and tapers gradually cephalad until it disappears. Posteriorly the post-anal gut ends quite abruptly not very far from the extreme tip of the tail.

Figure 5J is a composite drawing from reconstructions of the enterons of two embryos of approximately this stage. One of these reconstructions was plotted on paper from a series of transverse sections; the other was made in wax from a series of sagittal sections. For the sake of simplicity the gill clefts are not represented, and the pharynx, mouth, and liver are represented in outline only. For the same reason the lung rudiment of one side only is shown.

The relative size of the pharynx, *ph*, as seen in the figure, is smaller than it is in reality because of the small dorso-ventral diameter (the only one here shown) compared to the lateral diameter. The end of the lung rudiment, *lu*, is slightly enlarged and lies in a plane nearer to the observer than that of the oesophagus, *oc*, though this is not well shown in the figure.

The oesophagus, *oc*, diminishes slightly in caliber for a short distance caudad to the origin of the lungs, then gradually increases in caliber until it suddenly bends to the side (towards the observer) and merges into the wide stomach, *st*. The stomach, which is irregularly conical in shape, lies in a place slightly nearer the observer than the end of the lung rudiment mentioned above.

Lying to one side of the stomach and duodenum, and extending cephalad beyond the end of the lung rudiment is the liver, *li*, whose outline is only roughly shown here by the broken line. The stomach opens rather abruptly into the duodenum, *d*, which slopes back towards the plane of the oesophagus (away from the observer).

The projection from the side of the duodenum, *pan*, not well figured here, indicates the position of the pancreas, better shown in



the next reconstruction. The duodenum extends only a short distance caudad to this point and then opens, *ai $\phi$* , to the yolk-sac.

The yolk-stalk, or unclosed region of the enteron, is still of considerable extent, though its exact boundaries are not easy to determine. The distance between the anterior and posterior intestinal portals is approximately shown in the figure under discussion.

The hindgut is cylindrical in cross section and of about the same diameter throughout, except for a slight enlargement in the cloacal region.

The post-anal gut is not shown here; it will be described in connection with the next reconstruction where it is figured.

Figure 6 is a surface view in profile of an embryo of the next stage to be studied. The manus and pes are here well developed, and the general development of the embryo is in considerable advancement over the last stage studied.

Figure 6A represents a reconstruction, from a series of transverse sections, of the enteron of an embryo of about the age of the one shown in figure 6. The outlines of the entire embryo, of the eye, *e*, and of the anterior, *aa*, and posterior, *pa*, appendages are shown by broken lines. Its position being coincident with that of the stomach, liver, and pancreas, the anterior appendage can scarcely be seen. The enteron, including one lung only, for the sake of simplicity, is shaded solid black, while the liver and pancreas, with their ducts, are outlines with unbroken lines. As in the preceding reconstruction no attempt is made to show the gill clefts, and only the dorso-ventral profile of the enteron is shown. Caudal to the pharynx, the enteron being more or less cylindrical in section, this profile gives a good idea of its shape, but in the pharyngeal region, where the lateral diameter is so much greater than the dorso-ventral, the reconstruction gives but a poor idea of the size of that part of the enteron.

The widely-open mouth, *m*, leads, with no line of demarkation, into the pharynx, *ph*, which is of irregular outline and, as has been said, of much greater lateral than dorso-ventral diameter.

The pharynx becomes gradually constricted to form the oesophagus, *oe*, a very long and slender structure, which, as will be seen in cross section, is, at this stage, solid for the greater part of its length. As in the case of the pharynx, the lateral diameter of the oesophagus is generally greater than the dorso-ventral diameter.

From the floor of the caudal part of the pharynx is pushed out the trachea, *ta*. In the reconstruction, especially in the anterior end, the trachea appears several times the diameter of the oesophagus; this is due to the great thickness and indefiniteness of its walls rather than to a greater diameter of its lumen.

At about the position of the line *ta* the trachea divides into the two bronchi (only one shown in the figure), which are somewhat enlarged at the ends to form the lung rudiments, *lu*. While the trachea and bronchi lie ventrad to the oesophagus, the lungs lie laterad and even dorsad to the oesophagus and cardiac end of the stomach. Caudad to the heart and in the region of the anterior appendages, *aa*, the oesophagus suddenly enlarges to form the stomach, *st*, which has now quite the outline of the typical human stomach.

From the stomach the duodenum, *d*, extends, following a sort of V-shaped course, towards the yolk-stalk, *ys*. In the region of the yolk-stalk it is somewhat enlarged and ends in a blind sac like a caecum. At the side of this sac is seen the opening of the enteron to the yolk-stalk; the anterior and posterior intestinal portals are not distinguishable from each other. From this point the hindgut, *hg*, extends cephalad until it lies laterad to the middle region of the duodenum, then bends through 180° and extends, in an almost straight line, to the cloaca, *cl*, lying in the region of the posterior appendage, *pa*.

The allantois, *al*, extends cephalad for some distance from the floor of the cloaca. Some distance caudad to the cloaca, near the end of the much coiled tail, is seen the post-anal gut, *pag*. This structure as has been noted above, is quite distinct from the other parts of the enteron. It is of elongated, pyriform outline, with the pointed end extending cephalad.

In the narrow space between the stomach and the duodenum is the elongated pancreas, *pan*, opening by two or more short ducts into the duodenum.

The liver, *li*, in the figure under discussion, has about twice the area of the stomach. It extends caudad and dorsal about the same distance as the latter organ, but it extends ventrad and cephalad far beyond the boundaries of the stomach.

Extending along the ventral border of the liver is a long narrow duct, apparently the bile duct, *bd*. It connects, caudally, with the anterior end of the pancreas, while at its other extremity, near the antero-ventral corner of the liver; it ends blindly.

The transverse sections now to be described have been selected from the series from which the reconstruction, just described, was made.

Figure 6B represents a typical section through the pharynx. Its plane is approximately shown by the line 400 of figure 6A though the plane apparently does not cut the eye, *c*. The pharynx, *ph*, has here the outline of an irregular V. Its walls, except at the outer

angles of the clefts,  $g^1$ , are composed of but a single layer of cells. In the dorsal wall these cells are flattened, while in the ventral wall they are more rounded. This difference in the shape of the cells accounts for the slightly greater thickness of the floor over that of the roof of the pharynx. The gill clefts no longer communicate with the exterior.

Figure 6C represents the caudal half of the embryo in the plane 475 of figure 6A. The section of the pharynx,  $ph$ , is here crescentic in outline, and the pharyngeal walls, especially the floor, are somewhat thicker than in the more anterior section just described. Lying a short distance dorsad to the pharynx are seen two small, thick-walled openings,  $ty$ ; these are the rudiments of the thymus glands. They are here quite distinct from the enteron, and may be traced through a large number of sections, being in some regions solid and of a smaller diameter than in the present section.

Figure 6D is in the region of the line 500 in figure 6A. The thymus rudiments,  $ty$ , have about the same appearance as in the preceding figure, except that they are somewhat larger. The pharynx,  $ph$ , is much smaller than in the last section, and though somewhat crescentic in outline, its convex side is dorsal instead of ventral in position. The pharyngeal walls are here thicker, and consist of two or three layers of cells, instead of the single layer of more anterior sections.

In the median plane the floor of the pharynx is pushed down, as a solid tongue of cells,  $gs$ , the anterior edge of the glottis. Ventrad and laterad to the glottis a crescentic condensation of mesoblast represents the beginning of the laryngeal cartilages,  $la$ .

Two or three sections caudad to the one just described, the two layers of which the tongue of cells from the floor of the pharynx is composed separate slightly at the bottom to form a small cavity, the trachea,  $ta$ ; this condition is shown in figure 6E, which represents part of a section through the plane 532 of figure 6A.

The oesophagus,  $oe$ , is here a solid, crescentic mass of cells, the lumen being completely obliterated. The dorsal part of the tongue of cells, mentioned above, connects the ventral side of the oesophagus with the trachea, like a sort of mesentery. Above the oesophagus, on either side, is the thymus rudiment,  $ty$ , in this section practically a solid mass of cells instead of a tube. The epithelium of the trachea here consists of three or four layers of compactly arranged cells; this epithelium is surrounded by a dense mass of mesoblast which is responsible for the greater thickness of the trachea as seen in figure 6A. As has been said, the oesophagus here has no lumen, and when examined under high magnification its walls are found to be com-

pletely fused, not merely in close contact. The same is true of the tongue of cells between the oesophagus and trachea. Two or three sections caudad to the one under discussion this tongue of cells loses its connection with the trachea, and the latter structure is entirely independent of the oesophagus.

The solid condition of the oesophagus continues through about fifty sections of this series, the horns of the crescent gradually shortening until only the central part remains as the hollow cylinder seen in figure 6F, *oc*, which is a section through plane 650 of figure 6A. From about this point to its opening into the stomach the oesophagus has essentially the same structure. Its epithelium is of the simple columnar type, the cells being long, with generally basally located nuclei.

In the section under discussion the trachea, *ta*, is of about the same size as the oesophagus, but its epithelium is thicker and consists of two or three layers of cells. The trachea extends, as a separate and distinct structure, through about one hundred and fifteen sections, and then, at a point four or five sections caudad to the present section, it divides suddenly into the two bronchial tubes. Each bronchus, like the trachea, is lined with an epithelium of three or four layers of cells; but the epithelium is surrounded by a thin layer of much condensed mesoblast. The bronchi continue caudad, with slightly increasing caliber, through about fifty sections, when they suddenly enlarge to form the lungs. As seen in figure 6a the lungs are irregularly conical in outline and lie on either side of the posterior end of the oesophagus.

Figure 6G is a section through the plane 750 of figure 6A. The oesophagus, *oc*, is seen as a small, circular opening between two much larger openings, the lungs, *lu*. The epithelium of the oesophagus is the same here as in the more anterior regions described above; that of the lung rudiments is very variable in thickness, even in different parts of the same section, being in some places composed of a single layer of cuboidal or even flattened cells, in other places consisting of four or five layers of cells (not well shown in the figure). Surrounding the epithelium of the lung rudiments is a thin layer of quite dense mesoblastic tissue. A fairly well defined mesentery, *ms*, is now present in this region.

Filling the greater part of the body cavity, below the oesophagus and lung rudiments, is the liver, *li*; and ventrad to the liver the section passes through a loop of the duodenum, *d*.

The epithelium of the duodenum consists of four or five layers of compactly arranged cells, near the center of an oval mass of fairly dense mesoblast. In a lateral projection of this mass of mesoblast

lies a small, circular opening, the bile duct, *bd*. Its epithelium consists of a single layer of columnar cells. In more anterior sections the bile duct is larger in cross section, being about one-half the diameter of the oesophagus. As has been said it ends blindly at a point a short distance anterior to the antero-ventral edge of the liver. A few sections caudad to the one under discussion the bile duct connects with the liver, figure 6A, *bd'*; and some distance caudad to this the duct opens, *bd''*, into the duodenum so close to the opening, *pan'*, of the pancreas that it is difficult to determine whether the latter organ has a separate opening into the duodenum or opens into the bile duct.

At some distance ventrad to the structures just described the intestine is cut, by the plane of the section, in two places, *i*. The more dorsal of these is inclosed and has, under this magnification, the same appearance as the duodenum, *d*; a higher magnification, however, shows that its epithelium consists of a single layer of tall, rather clear, columnar cells. The more ventral of the two sections, above mentioned, which is continuous with the dorsal section a very short distance caudad to this point, is in the region that opens to the yolk—in fact a number of yolk-granules, *y*, may be seen in the opening. The epithelium of this part of the intestine consists of a single layer of clear, columnar cells, which, around the borders of the opening, are thrown into numerous folds and are almost of goblet form.

Figure 6H represents a section through the plane 820 of figure 6A. The section is caudad to one lung and cuts the extreme tip of the other, *lu*. The liver, *li*, and pancreas, *pan*, are seen at the side of the stomach, *st*, here cut through its greatest transverse diameter. The epithelium of the stomach varies somewhat in thickness and consists of two or three layers of cells, the variation in thickness being due to a variation in the length of the cells rather than to a variation in the number of layers.

Ventrad to the stomach the intestine, *i*, is cut in three places, of which the most dorsal section is the largest. The epithelium of these intestinal sections, especially the lower two, consists of usually a single layer of columnar cells which are clearer than those of the stomach. A fairly thin mesentery, *ms*, supports this region of the intestine.

In the region of the posterior appendages, *pa*, the section passes through the hindgut, *hg*, and allantois, *al*. The former is of about the same size as the more anterior sections of the intestine, but its epithelium is less clear and is composed of two or more layers of cells. The allantois is cut near its opening into the hindgut; its walls

are thin, the epithelium consisting of but a single layer of more or less flattened cells.

Figure 7 represents a reconstruction of the enteron of an embryo of .42 mm. crown-rump length. Because of the body flexure and large size of the embryo the head was amputated, in the plane *a-b*, and cut sagittally, while the body was cut transversely in the direction shown by the section planes. In the present figure the outline of the embryo, including the eye, appendages, and umbilical stalk, is shown by fine dotted lines; the outlines of the lungs and liver are shown by heavier, broken lines; while the outlines of the enteron proper and the trachea are shown in solid lines, filled in which fine stippling. For the sake of simplicity only one lung and one bronchus are shown.

Since the head has now quite a reptilian form, the oral cavity, *m*, has more or less of the adult outline. A transverse groove near the anterior end of the lower jaw marks off the tongue, *tn*; and the rudiments of teeth are seen but not shown in the figure because of the low magnification used.

The pharynx, *ph*, is a very extensive cavity that is sharply separated from the mouth by a prominent transverse fold of skin, the velum palatum, *v/p*, just in front of the posterior nares, *pn*, and by a less marked fold from the base of the tongue; it is these two valves that enable the adult alligator to open its mouth under the surface without getting water into the lungs. The mouth and pharynx are lined at this stage with a thin, stratified epithelium, which consists of a basal layer of rather tall columnar cells and one or two superficial layers of flattened cells. The pharyngeal epithelium is rather thicker than that of the oral cavity.

In the embryo from which this reconstruction was made the pharynx was in direct communication with neither the oesophagus nor the trachea, though the separation in each case was by a mere membrane. The trachea, *ta*, opens, except for this membrane, into the pharynx a short distance back of the transverse, dorsal and ventral folds mentioned above, and almost directly ventrad to the posterior nares. The anterior end of the oesophagus, *oe*, is in contact with the extreme postero-ventral wall of the pharynx.

The trachea, which is already surrounded by distinct cartilaginous rings, is long, and of about the same diameter throughout. In the region of the anterior appendage, at the point marked *X*, it divides into the two very short bronchi, which almost immediately open into the lungs, *lu*. The lungs, whose structure will be shown in the sections of this stage, are large, irregular bodies, extending about equal distances cephalad and caudad to their openings into the

bronchi. The caudal ends of the lungs overlap the cephalic end of the liver, *li*.

The oesophagus, *oc*, is large, and is laterally compressed so that its dorso-ventral diameter, the one shown in the present figure, is two or three times as great as its lateral diameter. This gives the impression, in the reconstruction, that the oesophagus is nearly as large as the stomach.

As has been said, the oesophagus does not open directly into the pharynx, but is separated from it by a membrane which consists of the flattened epithelial layers of both cavities separated by a thin layer of mesoblast. This partition between the pharynx and the oesophagus is not a mere fold of mucous membrane, but is a complete, though thin, wall, easily seen in the series of sagittal sections from which this region of the embryo was drawn. The anterior end of the oesophagus is suddenly constricted so that the actual opening closed by this partition is not large.

Followed caudad the dorso-ventral diameter of the oesophagus varies somewhat, as does the lateral diameter, but it remains large throughout and opens into the stomach with no sharp line of demarkation. The character of the epithelium of the enteron caudad to the pharynx will be discussed in connection with the sections to be described below.

The stomach, *st*, is very different in outline from what was seen in the last stage described, figure 6A. Instead of having approximately the form of the typical mammalian stomach it is now so elongated that the opening into the duodenum, the pylorus, *py*, seems to be nearer the anterior than the posterior end. While the position of the pylorus is very distinct it is difficult to distinguish the line of demarkation between the stomach and the oesophagus.

The extreme caudal region of the stomach is enlarged to form a blind sac, representing the gizzard, *gz*. A slight enlargement in the region of the pylorus may represent the glandular region of the adult stomach. The stomach opens, in a rather curious way, into the side of the duodenum, *d*, the anterior end of the latter structure having the appearance of a sort of caecum, to be seen in the next stage of development.

The duodenum, *d*, makes a U-shaped bend at the side of the stomach, and then, in the region of the caudal edge of the gizzard, *gz*, dips suddenly ventrad and caudad towards the umbilical cord, *u*, where it apparently ends blindly, though this appearance is probably due to an artifact in the embryo from which the reconstruction was made. It is likely that, in removing the embryo from the yolk, the connection between the two loops, *i*, of the intestine was broken.

The ascending intestinal loop is of slightly less caliber than the descending loop above mentioned: it passes dorsal and cephalad to the posterior border of the gizzard where its lumen is continuous, for a short distance, with that of the descending loop above described. This unusual condition is probably abnormal, but owing to lack of material only one series of this stage was studied.

At the dorso-caudal angle of the gizzard the small intestine, *i*, opens into the ventral side of a larger tube which may be called the large intestine, *il*. The blind end of the large intestine, cephalad to the opening of the small intestine, projects forward, dorsal to the gizzard, as a sort of caecum, *ce*, though this structure is generally stated to be wanting in the crocodilia, and is not seen in the next stage.

From the caecum the large intestine passes in a ventro-caudal direction, with gradually decreasing caliber, to the cloaca, from whose anterior wall the intromittent organ, *io*, projects.

From the ventral wall of the large intestine, at a point about one-third the distance from the cloaca to the caecum, projects ventrad and cephalad the stalk of the allantois, *al*. Owing to its thin walls and small lumen the allantois was traced only a short distance into the umbilical stalk.

The profile of the liver, *li*, has, at this stage, about the same area and even outline as that of the lung. It lies, of course, on both sides of the enteron proper, and overlaps, anteriorly, as has been said, the posterior end of the lung.

Figure 7A represents a section through the plane 305 of figure 7. A considerable advance in the general development of the organs is seen over the last stage studied. The spinal column is well outlined in cartilage, and the ribs are cut at various places, *r*. In the body wall a considerable differentiation of muscular tissue has taken place, but it is only faintly shown in this series of figures. The scales, especially along the mid-dorsal line, are shown as an area of less closely dotted tissue.

The lungs, *lu*, cut here through their anterior ends, are large, but do not nearly fill the cavities, *bc*, in which they lie; they have the sacculated appearance characteristic of embryonic lung tissue.

The oesophagus, *oe*, is cut through about its middle region, where its caliber is greatest. As was said above, its dorso-ventral diameter is more than twice its lateral diameter, caused partly by the oblique angle at which it was cut. Its wall, figure 7H, is very thin and exhibits a dense layer of mesoblastic tissue, in which circular and longitudinal muscle layers are beginning to differentiate. It is lined by an epithelium which here consists of a single layer of columnar



or cuboidal cells with large nuclei. On the ventral side, where the oesophageal wall is in contact with that of the trachea the epithelium is somewhat thickened by an increase in the number of cell layers. With the low magnification used these details could not, of course, be shown.

The trachea, *ta*, is of much smaller caliber than the oesophagus, especially in its dorso-ventral diameter. While its epithelial lining is not yet appreciably different from that of the oesophagus, its connective tissue wall is much thicker and shows numerous condensations, the rudiments of the cartilaginous rings. In the region represented by this figure the connective tissue layers of the trachea and oesophagus are continuous with each other, but cephalad and caudad to this point they are distinct, though sometimes in contact. Several large blood vessels, *bt*, on each side of the oesophagus probably represent the carotids and jugulars, but they were not worked out to determine with certainty which they were.

Eighty-five sections (figure 7, *X*) caudad to the one under discussion the trachea divides into the two bronchi. These bronchi gradually separate from each other until, at the point at which they open into the lungs, about eighty sections caudad to their point of separation, they lie on either side of the ventral third of the oesophagus.

Figure 7*B* represents a section through the plane 480 of figure 7. The section is just cephalad to the heart, and passes through the caudal third of the lungs, *lu*, which have the same appearance as in the preceding figure; also through the extreme cephalic end of the liver, *li*. The lungs here much more nearly fill the body cavity than in the preceding figure. The section being caudad to their openings into the lungs the bronchi do not, of course, show.

The oesophagus, *oc*, is here of much less diameter than in the preceding figure, but is still laterally compressed. Its wall is somewhat thicker than in the more cephalic region, the increase being mainly due to the greater thickness of the connective tissue layer, though the epithelium is also slightly thicker because of an increase in the length of the lining cells. Instead of lying almost entirely ventrad to the lungs, as in the preceding figure, the oesophagus here lies directly between them.

Figure 7*C* represents a section through the plane 627 of figure 7. The plane of the section passes through the opening of the stomach, *i'*, into the duodenum, *d*. The cross section of the stomach is somewhat larger than that of the oesophagus, but it differs from the more anterior region mainly in the character of its walls. These are much thicker than in the oesophagus; in the mesoblast which

forms the greater part of their thickness, muscle fibers are beginning to differentiate. The epithelial layer also is thicker than in the oesophagus; it consists of tall columnar cells that, at places, are thrown into small folds, figure 7I. These folds, even under the low magnification used, are more evident than is shown in the present figure. The pylorus, *py*, is wide and, as has been noted in connection with figure 7, is situated far cephalad to the caudal end of the stomach. It opens into the side rather than into the end of the duodenum, which projects cephalad as a short blind pouch, *d*. The stomach and duodenum, in this section, are almost completely surrounded by the liver, *li*.

Figure 7D represents a section through the plane 680 of figure 7.

The stomach, *s'*, which is cut through its middle region, is somewhat larger than in the preceding figures, though its walls have about the same character. Its outer walls are continuous, to a considerable extent, with the tissue of the surrounding body wall, especially in the region just caudad to the plane of the present section.

The duodenum, being cut through a double loop (see figure 7), is seen in two places, dorsally where it is cut through the edge of one loop, and ventrally where it is cut square across. In both sections the structure is the same, as might be expected, figure 7J. The surrounding mesoblast is differentiated into muscle fibers, figure 7J, *ml*, which form a fairly distinct layer; inside of this layer is a tall columnar epithelium, *ep'*, which is thrown into prominent folds. A thin layer of mesoblast, probably the submucosa, *sl*, lies beneath the epithelium and projects up into the folds. About ten or twelve folds are seen in any one section; only the larger ones are well seen in figure 7D.

Figure 7E shows a section through the plane 770 of figure 7. It is in the region of the umbilicus, *u*, and the extreme caudal end of the stomach which has been called the gizzard, *gs*. The small size of the gizzard is due to its being cut near its caudal margin. The enteron is here cut in no less than seven places: the reason for this will be evident on examination of the plane of the section as shown in figure 7. Dorsal to the gizzard the section cuts the so-called caecum, *cc*, a little nearer its anterior end than is shown in figure 7. The duodenum, *d*, is cut at five points, and has about the same structure as in the preceding figure. The character of the duodenal loops that causes the rather curious appearance of the present figure will be readily understood by reference to figure 7, though the reconstruction is not mathematically accurate. The ventral projection of the lower loops of the duodenum into the umbilicus is seen both in the present figure and in the reconstruction. The loop of

the duodenum that, in the sections, is seen to lie directly ventrad to the gizzard, in the reconstruction is shown too much to the side of the latter organ. The descending loops of the duodenum are cut in such a way that the surrounding mesoblast forms a continuous mass of tissue.

Figure 7F represents a section through the plane 901 of figure 7. The section passes through the kidneys, *k*, the edge of one posterior appendage, *pa*, the large intestine, *il*, and two regions of the small intestine, *i*.

The large intestine is here a thick walled, cylindrical structure, *il*, hanging from a thin mesentery, *ms*, in the much reduced body cavity. The layers of its wall are much more fully differentiated than in the more anterior regions of the enteron. The epithelium is here stratified instead of simple columnar, and the folds into which it is thrown are broader and less numerous than in the duodenum above described.

Ventrad to the large intestine, and almost in contact with it, is seen the allantois, *al*, whose general outline was noted in connection with figure 7. It is an irregular structure, consisting of a very thin outer layer of mesoderm, lined with a single layer of flattened epithelial cells.

Lying at a considerable distance ventrad to the main body of the section, are seen the two sections of the small intestine, *i*, surrounded by irregular strands of tissue from the umbilicus. The structure of these two intestinal loops is about the same as in the more anterior region described above.

Figure 7G, the last of this series, represents a section through the cloaca, caudad to the urinary openings, in the plane 1060 of figure 7. The epithelium of the cloaca is, of course, simply a continuation of that of the surface of the body, somewhat thickened, perhaps, in the deeper regions.

The intromittent organ, *io*, which projects cephalad from the wall of the cloaca, is here seen as a three-pointed body of considerable size, projecting ventrally from the body.

Figure 8 shows in outline the enteron, from the ventral aspect, of an embryo of 20 cm. total length, or at about the time of hatching. The drawing was made from a dissection and, for the sake of simplicity, only the enteron, respiratory organs, heart, and thymus are shown. The jaw is cut through on the left side and is turned over to the right, thus bringing into view the roof of the mouth, *m*, and the dorsal side of the tongue, *tn*. At the same time the pharynx, *ph*, and the wide anterior end of the oesophagus, *oe*, are cut open, exposing the glottis, *gs*, and vocal cords, *vc*.

The lungs, *lu*, and trachea, *ta*, which are now fully formed, are dissected loose and drawn over to the right side of the animal, together with the heart, *hl*, and the thymus, *ty*; only one side of the thymus is shown, the other half being hidden by the trachea.

The mouth has reached nearly the outline of the adult. The lips are formed and, in the anterior part of the lower jaw, four tooth rudiments, *to*, are externally visible. The mucous membrane of the root of the mouth, *m*, is covered with rounded papillae, easily seen with a lens but not shown in the figure. The tongue, *tu*, is fully formed, and is free anteriorly and laterally to about the extent that is seen in the adult; the papillae with which it is covered are not so prominent as those seen on the root of the mouth. At the base of the tongue is the prominent transverse fold, noted in connection with figure 7, that meets above the velum palatinum, not shown here but shown in figure 7. Caudad to these folds is seen the glottis, *gs*, a triangular opening with the vocal cords, *vc*, at its base.

The mucosa of the inside of the pharynx and the anterior end of the oesophagus, exposed by the dissection, is thrown into numerous longitudinal folds, not shown in the figure; these well marked folds extend throughout the length of the oesophagus.

The oesophagus, *oe*, tapers gradually from the wide pharynx, *ph*, and then continues as a cylindrical tube of uniform diameter to the right side of the anterior end of the stomach, where it opens into the latter organ. Its walls are thick, and its lumen is almost obliterated by the longitudinal folds of the mucosa, mentioned above.

The stomach, *st*, is oval in outline, though somewhat flattened laterally; it is depressed, dorso ventrally, to a little more than half the lateral diameter. As has been said, the oesophagus enters its right anterior border; the pylorus is on the right side, 3 or 4 mm. caudad to the oesophageal opening. The wall of the stomach is comparatively thin except in the region of the oesophageal and pyloric apertures, and at a point, opposite these apertures, on the left side. At the latter point is an oval or disc shaped area that is several times as thick as the surrounding wall; it probably represents the gizzard structure of the adult. The thickening mentioned in the region of the two apertures seems to be mainly due to a wrinkling of the mucosa which, in other parts of the stomach, is nearly smooth, so far as can be seen with the naked eye. A sphincter thickening around the oesophageal and, to some extent, around the pyloric aperture, causes each of these structures to project into the stomach like an ileo caecal valve.

The pylorus, *py*, opens into a small, pointed, thin walled diverticulum, *dt*, and, at the same time, into the duodenum, *d*. The diver-

ticulum noted, also, in connection with figure 7, has relatively thick, wrinkled walls; its significance is not known to the writer. From this diverticulum the duodenum, *d*, leads caudad and laterad for a short distance as a narrow tube, then suddenly expands into the widest part of the entire intestine. Into this wide part of the duodenum, 3 or 4 mm. from the pylorus, opens the bile duct, *bd*. The bile sac, *bs*, is an elongated oval body with thin walls, lying to the right of the pylorus, its connection with the liver was not seen.

Lying between the anterior end of the duodenum and the posterior end of the stomach, and extending caudad for 10 to 15 mm., in the median plane of the animal is the pancreas, *pan*. It is a long narrow body of a whitish color; its duct or ducts could not be determined by dissection. The duodenum extends caudad, with gradually diminishing caliber, from the enlarged region mentioned above. About 10 to 15 mm. caudad to the stomach it makes a sort of double loop to the right, a wide loop, *lp*, and a close one, *lp'*, nearer the median plane. From the latter loop the intestine extends straight to the left, for a distance of about 10 mm., where it makes a small loop cephalad, *lp''*, and then opens to the yolk-sac, *y*. The yolk-sac is shown here simply as an irregular piece of tissue, the yolk having been removed.

The anterior intestinal portal, *aip*, and posterior intestinal portal, *pip*, are in close proximity with each other.

From the posterior intestinal portal the intestine extends straight cephalad to the posterior end of the stomach, dorsal to which it forms a double loop, a wider one, *lp<sup>3</sup>*, and a narrow one, *lp<sup>1</sup>*. From the latter loop, *lp<sup>4</sup>*, the intestine extends straight caudad, parallel and near to the straight region leading from the posterior intestinal portal, until it reaches the region of the loop *lp<sup>2</sup>*, dorsal to which it forms a small loop, *lp<sup>5</sup>*. From loop *lp<sup>5</sup>* the intestine, which is here of very small caliber, extends caudad for about 10 mm., where it forms another indistinctly double loop, *lp<sup>6</sup>*.

From loop *lp<sup>6</sup>* the large intestine, *il*, extends, with gradually increasing caliber, to the cloaca, *cl*, a distance of 10 to 15 mm.

Except in the enlarged region near the pylorus the lumen of the intestine is almost obliterated by the folding of its thick walls, so that little or nothing can be told of its lining with the naked eye.

A distinct mesentery holds the loops of the intestine in position and binds the entire enteron close to the dorsal body wall. Because of the lack of properly fixed tissue no sections of the enteron of this stage were made.

## REFERENCES

1. BRONN, H. G.: Klassen des Thier-Reichs. (Vols. on reptiles.) 1890.
2. CHAFFANJON, V.: Observations sur Alligator mississippiensis (Tractus intestinalis und Mesenterium). Ann. Soc. Linn. Lyon, vol. 28, p. 83 ff., 1881.
3. EISLER, P.: Zur Kenntniss der Histologie des Alligatormagens. Archiv f. Mikr. Anat., vol. 34, pp. 1-10, 1889.
4. HERTWIG, O.: Comparative Embryology of Vertebrates. Especially vol. 2, pp. 1-241, 1906.
5. REESE, A. M.: The Nasal Passages of the Florida Alligator. Proc. Acad. Nat. Sc. Phila., 1901.
6. REESE, A. M.: The Development of the American Alligator. Smith. Misc. Coll., vol. 51, No. 1791, pp. 1-66, 1908.

## DESCRIPTION OF FIGURES 1-8, PLATES 1-15

The surface views were drawn, under the author's direction, by Miss C. M. Reese. The first two of these views were copied, by permission, from S. F. Clarke; the others were drawn from the specimens themselves.

All of the figures of any one stage are given the same number, followed by distinguishing letters, so that it is possible to tell at a glance what figures belong together.

All of the figures except those from Clarke were drawn under a camera lucida.

Figure 1. A surface view of an embryo, from the dorsal aspect, at the beginning of the formation of the enteron.

Figure 1A. A sagittal section of an embryo of approximately the age of the one shown in figure 1.  $\times 43$ .

Figure 2. A dorsal view of an embryo with five pairs of mesodlastic somites.

Figure 2A. A sagittal section of an embryo of the stage shown in figure 2.  $\times 43$ .

Figure 2B. A transverse section through the headfold of an embryo of the stage shown in figure 2.  $\times 43$ .

Figure 3. A dorsal view of an embryo with about fifteen pairs of somites.  $\times 20$ .

Figures 3A-3D. A series of transverse sections through an embryo of the stage of the one shown in figure 3.  $\times 43$ .

Figure 4. A surface view of an embryo with about twenty pairs of somites.  $\times$  (about) 15.

Figures 4A-4D. A series of transverse sections through the anterior end of an embryo of the approximate age of the one shown in figure 4.  $\times 20$ .

Figures 4E and 4F. Two transverse sections through the thyroid gland of this stage; more highly magnified.  $\times 102$ .

Figures 4G-4M. A series of transverse sections caudad to the preceding. Figure 4H,  $\times 43$ ; other figures,  $\times 20$ .

Figure 5. A surface view, in profile, of an embryo at the time of the origin of the limbs.  $\times$  (about) 5.

Figures 5A-5I. A series of transverse sections through an embryo of the age shown in figure 5.  $\times 7$ .

Figure 5J. A composite drawing of reconstructions of the enterons of two embryos of the age of the one shown in figure 5. One reconstruction was in wax, from sagittal sections, the other was a plotted reconstruction from transverse sections.  $\times 14$ .

Figure 6. A surface view, in profile, of an embryo with well developed manus and pes.  $\times$  (about) 5.

Figure 6A. A reconstruction, plotted from transverse sections, of the enteron of an embryo of about the age of the one shown in figure 6.  $\times 14$ .

Figures 6B-6H. Part of a series of transverse sections from which the preceding reconstruction was made.  $\times 7$ .

Figure 7. A reconstruction of the enteron of an embryo of 42 mm. crown-rump length.

Figures 7A-7G. A part of the series of transverse sections from which the preceding reconstruction was made.  $\times 7$ .

Figure 7H. A high power drawing of a portion of the wall of the oesophagus in the region of figure 7A.  $\times 100$ .

Figure 7I. A high power drawing of a portion of the wall of the stomach in the region of figure 7C.

Figure 7J. A high power drawing of a portion of the wall of the duodenum in the region of figure 7D.

Figure 8. An outline drawing, from the ventral aspect, of the enteron of an embryo of 20 cm. length, at about the time of hatching; made from a dissection.  $\times 1$ .

#### LETTERING FOR ALL FIGURES

- |   |  |
|---|--|
| <i>a</i> , head-fold of amnion.                 | <i>cs</i> , embryonic shield.              |
| <i>aa</i> , anterior appendage.                 | <i>f</i> , fronto-nasal process.           |
| <i>ac</i> , anterior cardinal vein.             | <i>fb</i> , forebrain.                     |
| <i>aip</i> , anterior intestinal portal.        | <i>fg</i> , foregut.                       |
| <i>al</i> , allantois.                          | <i>g<sup>1-5</sup></i> , gill clefts.      |
| <i>an</i> , anterior nares.                     | <i>gf<sup>1-6</sup></i> , gill folds.      |
| <i>ao</i> , aorta.                              | <i>gl</i> , glomerulus.                    |
| <i>av</i> , aortic arch.                        | <i>h</i> , head-fold.                      |
| <i>au</i> , auricle.                            | <i>gs</i> , glottis.                       |
| <i>b</i> , bulbus arteriosus.                   | <i>gz</i> , gizzard.                       |
| <i>bc</i> , body cavity.                        | <i>hb</i> , hindbrain.                     |
| <i>bd</i> , bile duct.                          | <i>hc</i> , head cavity.                   |
| <i>bd'</i> , opening of bile duct to liver.     | <i>hg</i> , hindgut.                       |
| <i>bd''</i> , opening of bile duct to duodenum. | <i>ht</i> , heart.                         |
| <i>blp</i> , blastopore.                        | <i>i</i> , intestine.                      |
| <i>bp</i> , basilar plate.                      | <i>i'</i> , stomach.                       |
| <i>bs</i> , bile-sac.                           | <i>il</i> , large intestine.               |
| <i>bt</i> , blood vessel.                       | <i>in</i> , infundibulum.                  |
| <i>c</i> , centrum of vertebra.                 | <i>io</i> , intronittent organ.            |
| <i>ca</i> , caudal artery.                      | <i>ir</i> , iris.                          |
| <i>cc</i> , caecum.                             | <i>it</i> , iter.                          |
| <i>ch</i> , cerebral hemisphere.                | <i>k</i> , kidney.                         |
| <i>cl</i> , cloaca.                             | <i>la</i> , larynx.                        |
| <i>cm</i> , circular muscle layer.              | <i>li</i> , liver.                         |
| <i>cn</i> , cranial nerve.                      | <i>lm</i> , longitudinal muscle layer.     |
| <i>cp</i> , posterior choroid plexus.           | <i>ln</i> , lens.                          |
| <i>cv</i> , cardinal vein.                      | <i>lp, lp'</i> , etc., loops of intestine. |
| <i>d</i> , duodenum.                            | <i>lu</i> , lungs.                         |
| <i>dc</i> , ductus Cuvieri.                     | <i>lv</i> , lens vesicle.                  |
| <i>di</i> , diverticulum of stomach.            | <i>m</i> , mouth.                          |
| <i>e</i> , eye.                                 | <i>ma</i> , manus.                         |
| <i>ec</i> , ectoderm.                           | <i>mb</i> , midbrain.                      |
| <i>ec'</i> , thickening of ectoderm.            | <i>mc</i> , medullary canal.               |
| <i>en</i> , entoderm.                           | <i>mc'</i> , tip end of medullary canal.   |
| <i>en'</i> , endocardium.                       | <i>md.</i> , mandibular folds.             |
| <i>ent</i> , enteron.                           | <i>mes</i> , mesoderm.                     |
| <i>ep</i> , epidermal layer of ectoderm.        | <i>mc's</i> , myocardium.                  |
| <i>ep'</i> , epithelium.                        | <i>mf</i> , medullary fold.                |
| <i>epi</i> , pineal body.                       | <i>mg</i> , medullary groove.              |
|   | <i>mk</i> , Meckel's cartilage.            |



- ml*, muscle layer.  
*mp*, muscle plate.  
*ms*, mesentery.  
*m $\tau$* , meatus venosus.  
*mx*, maxillary fold.  
*myc*, myocoel.  
*n*, nasal cavity.  
*na*, neural arch of vertebra.  
*nc*, neurenteric canal.  
*nl*, nervous layer of ectoderm.  
*nt*, notochord.  
*o*, ear vesicle.  
*oc*, optic cup.  
*oc*, oesophagus.  
*on*, optic nerve.  
*os*, optic stalk.  
*ov*, optic vesicle.  
*p*, pituitary body.  
*pa*, posterior appendage.  
*pag*, post-anal gut.  
*pan*, pancreas.  
*pan'*, opening of pancreas.  
*pc*, posterior cardinal vein.  
*pe*, pes.  
*pg*, primitive groove.  
*ph*, pharynx.  
*pip*, posterior intestinal portal.  
*pl*, pelvis.  
*pn*, posterior nares.  
*pv*, pericardial cavity.  
*ps*, primitive streak.  
*pt*, pecten.  
*py*, pylorus.  
*r*, rib.  
*rt*, retina.  
*s*, somites.  
*sc*, spinal cord.  
*sc*, spenchnoid cartilage.  
*sg*, spinal ganglion.  
*sl*, submucosa.  
*sm*, splanchnic mesoblast.  
*sn* spinal nerve.  
*so*, somatic mesoblast.  
*st*, stomodaeum.  
*sy*, sympathetic nervous system.  
*t*, tail.  
*ta*, trachea.  
*tg*, thyroid gland.  
*tn*, tongue.  
*to*, tooth anlage.  
*tr*, trunculus arteriosus.  
*tv*, *tv'*, third ventricle of brain.  
*ty*, thymus gland.  
*u*, umbilical stalk.  
*v'*, *v''*, *v'''*, first, second, and third cerebral vesicles.  
*va*, vascular area.  
*vc*, vocal cords.  
*vm*, vitelline membrane.  
*vn*, ventricle of heart.  
*vp*, velum palatum.  
*vv*, vitelline blood vessels.  
*w $d$* , Wolffian duct.  
*w $d$ o*, opening of Wolffian duct.  
*w $r$* , Wolffian ridge.  
*w $t$* , Wolffian tubule.  
*x*, point of origin of bronchi.  
*y*, yolk.  
*ys*, yolk-stalk.



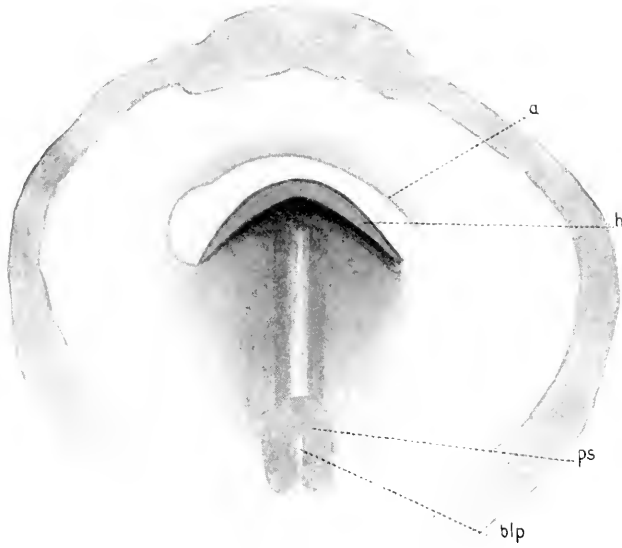

FIG. 1.

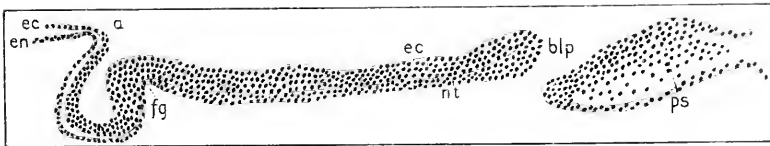

FIG. 1A.



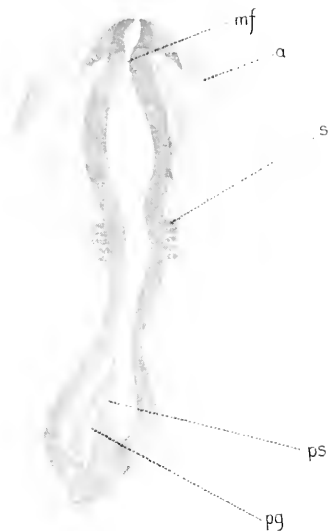

FIG. 2.

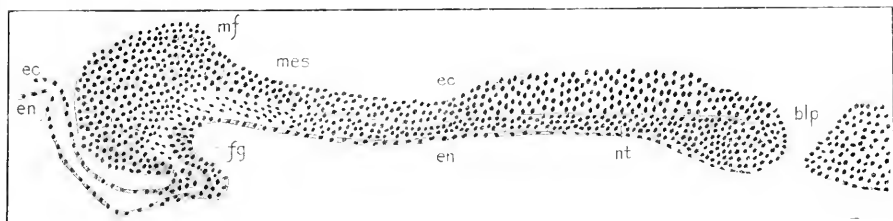

FIG. 2A.

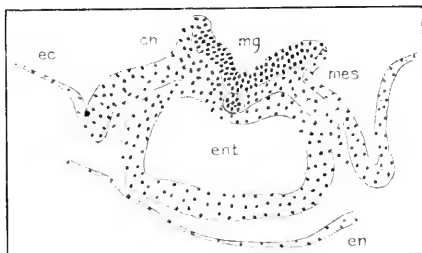

FIG. 2B.





FIG. 3.

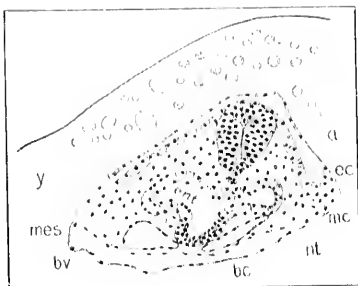

FIG. 3A.

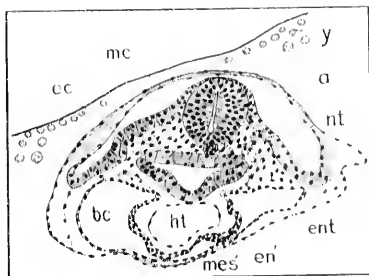

FIG. 3B.





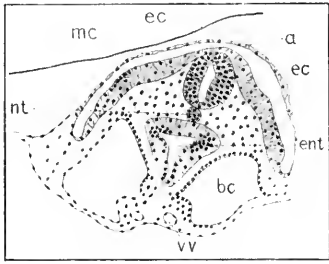

FIG. 3C.

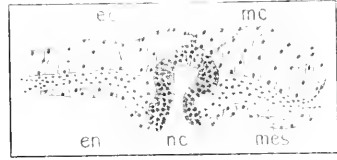

FIG. 3D.

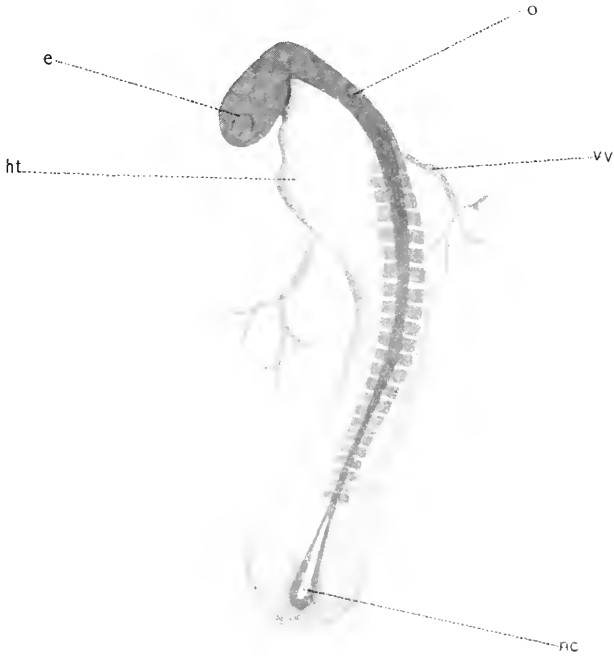

FIG. 4.



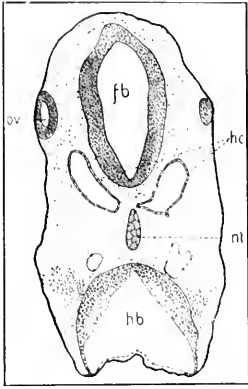

FIG. 4A.

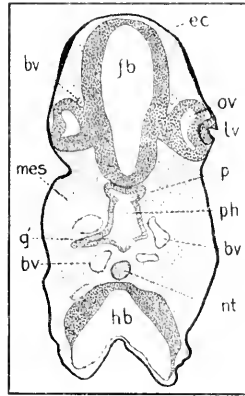

FIG. 4B.

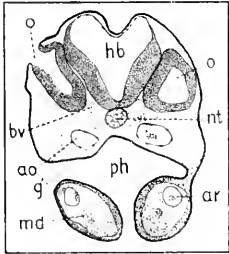

FIG. 4C.

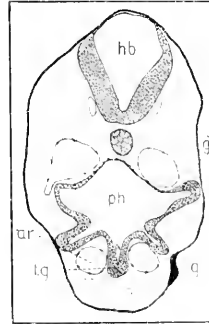

FIG. 4D.

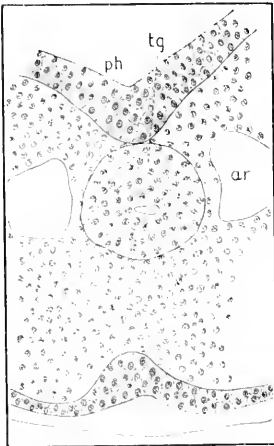

FIG. 4E.

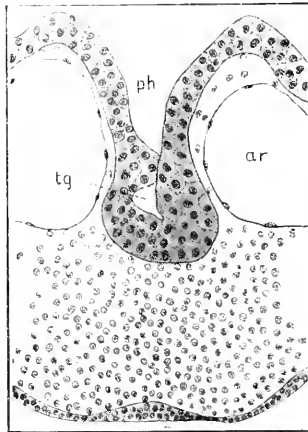

FIG. 4F.



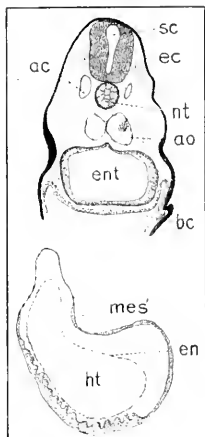

FIG. 4G.

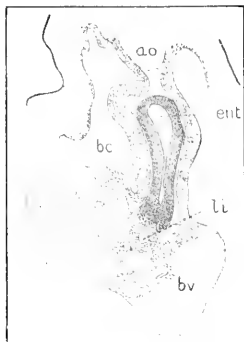

FIG. 4H.

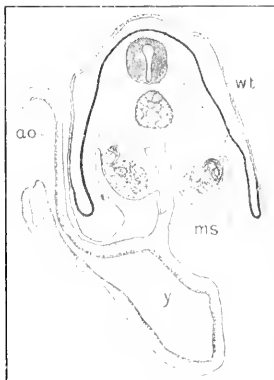

FIG. 4K.

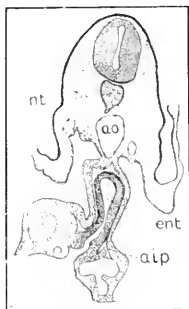

FIG. 4I.

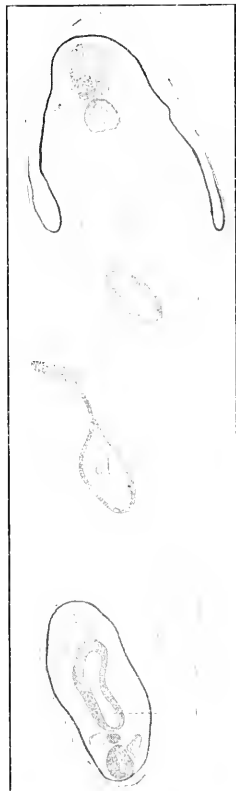

FIG. 4L.

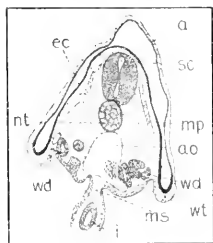

FIG. 4J.

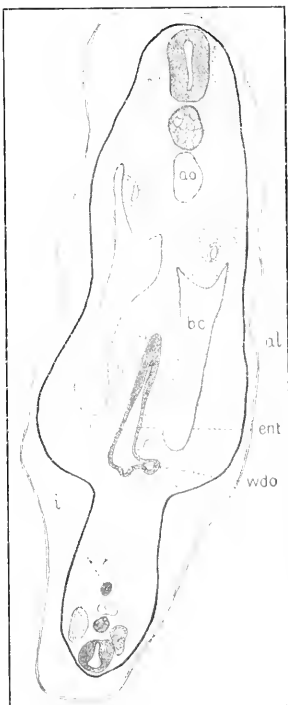

FIG. 4M.



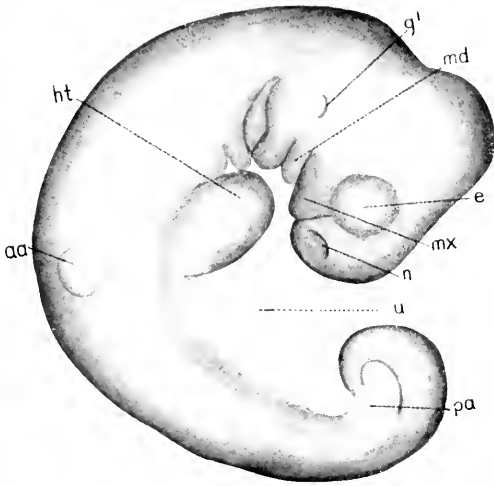

FIG. 5.

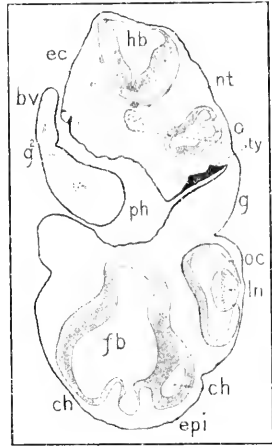

FIG. 5A.

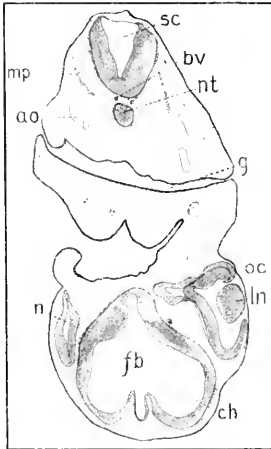

FIG. 5B.

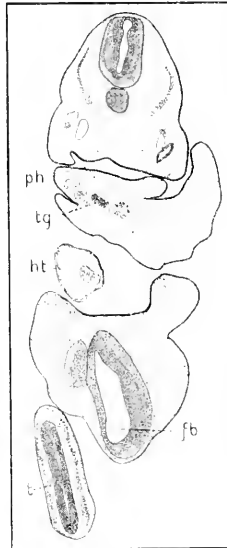

FIG. 5C.

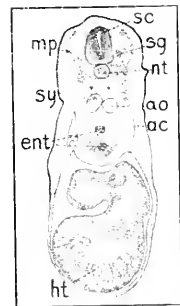

FIG. 5D.





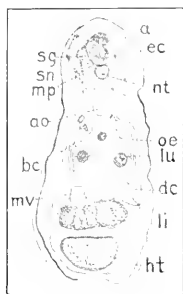

FIG. 5E.

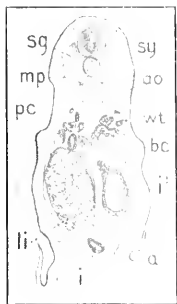

FIG. 5F.

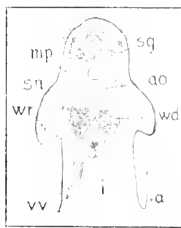

FIG. 5G.

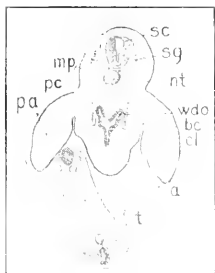

FIG. 5H.

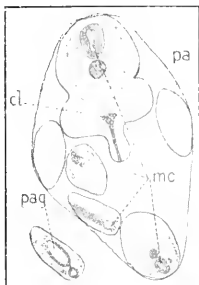

FIG. 5I.

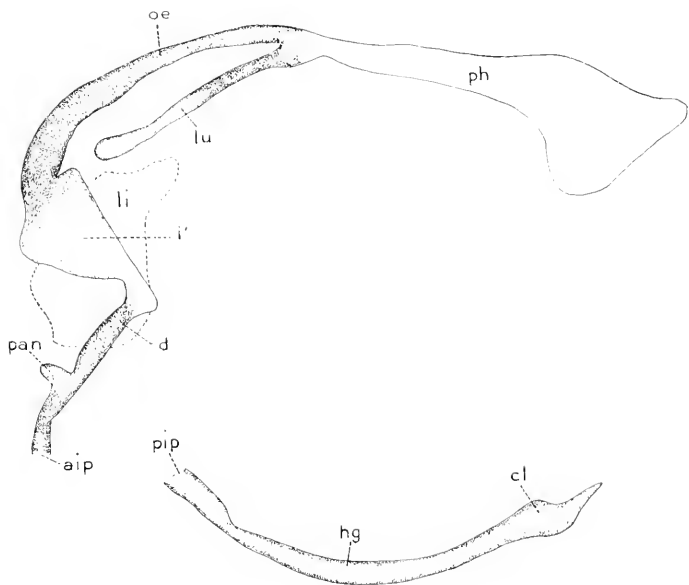

FIG. 5J.



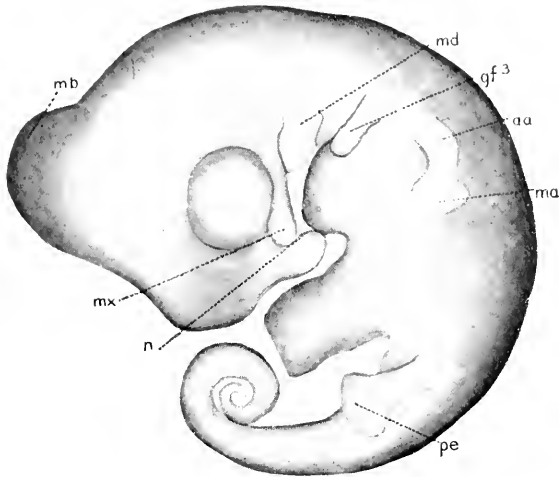

FIG. 6.

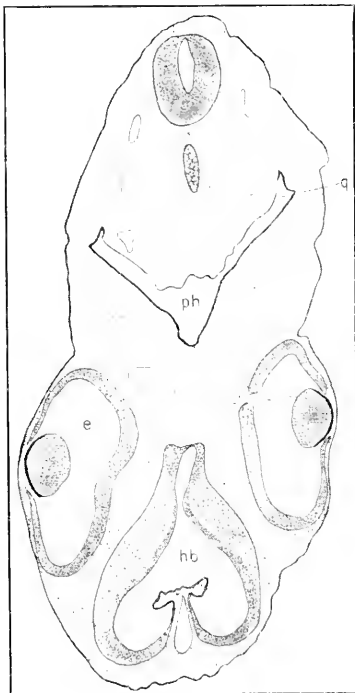

FIG. 6b.

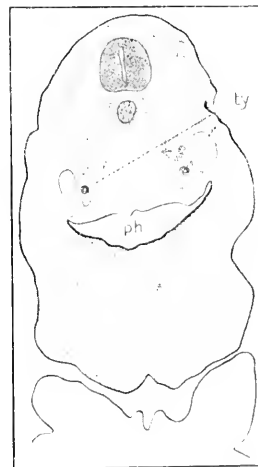

FIG. 6c.



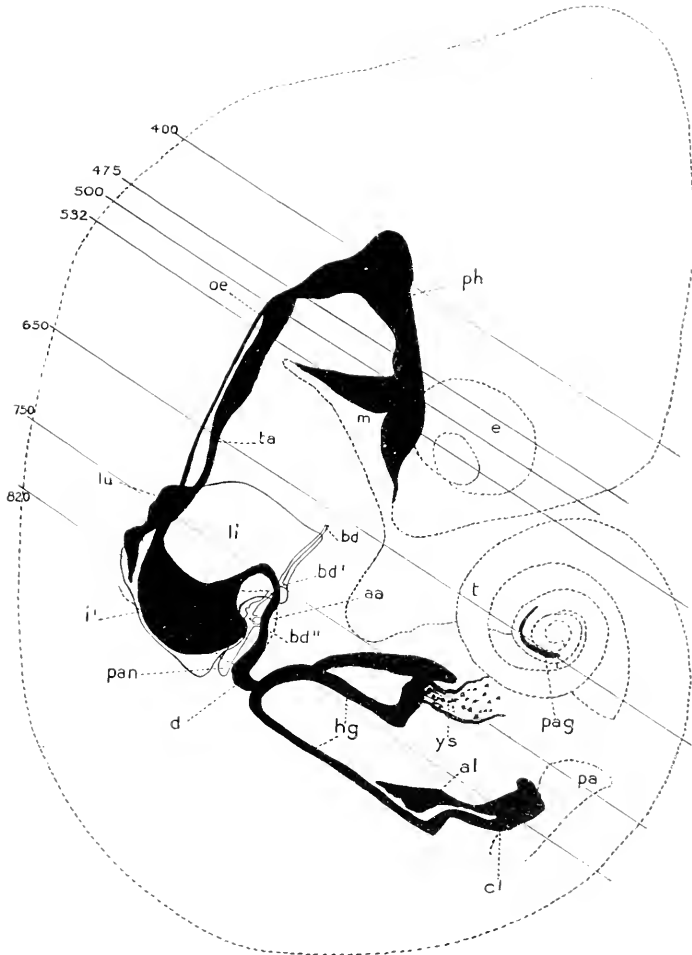

FIG. 6A.



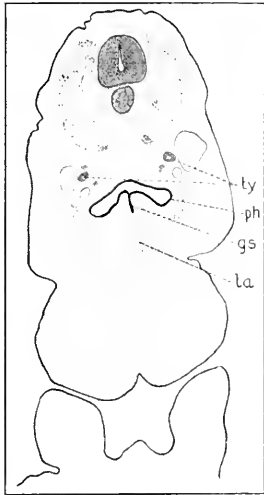

FIG. 6b.

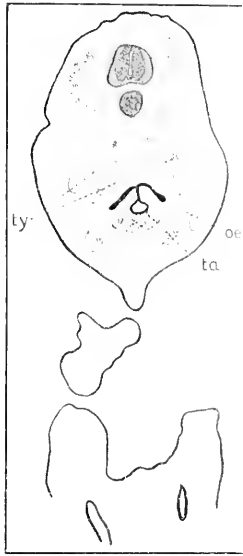

FIG. 6e.

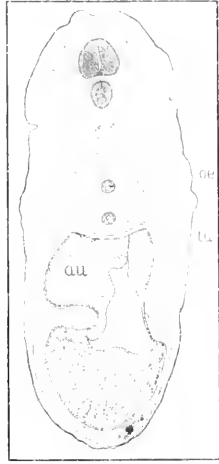

FIG. 6f.

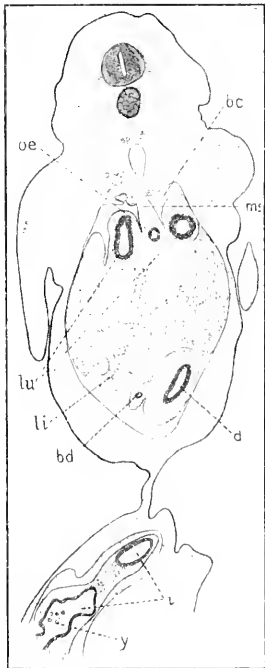

FIG. 6g.

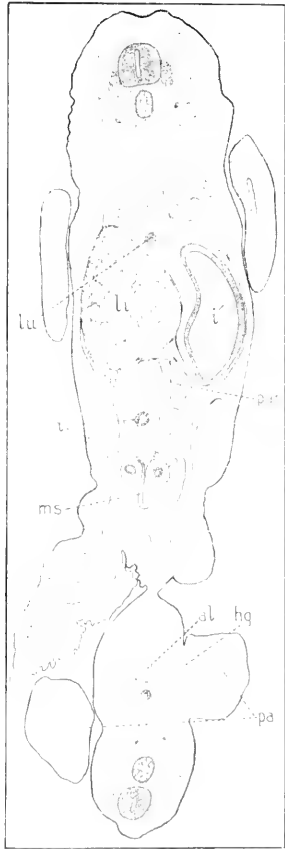

FIG. 6h.





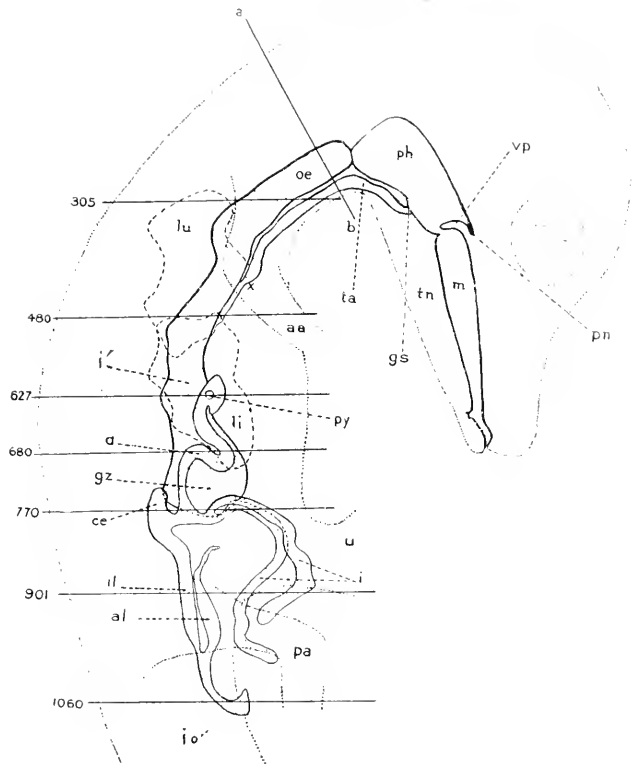

FIG. 7.

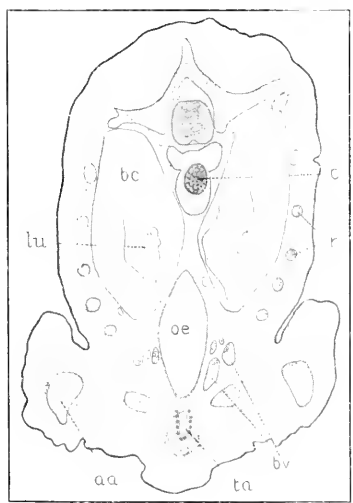

FIG. 7A.



FIG. 7B.

DEVELOPMENT OF DIGESTIVE CANAL OF ALLIGATOR



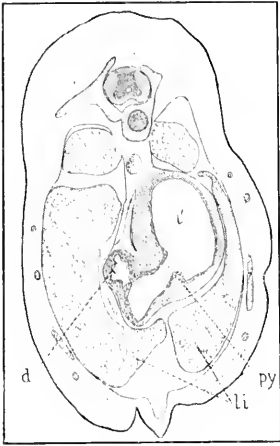

FIG. 7C.



FIG. 7D.

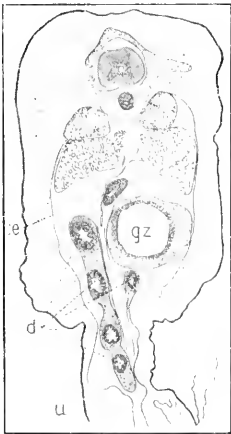

FIG. 7E.



FIG. 7F.



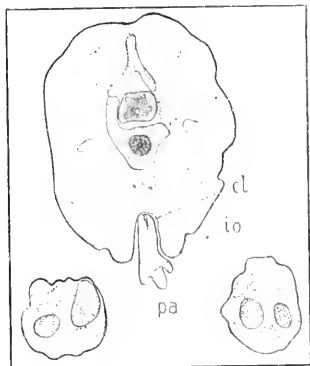

FIG. 7G.

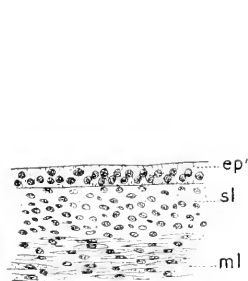

FIG. 7H.

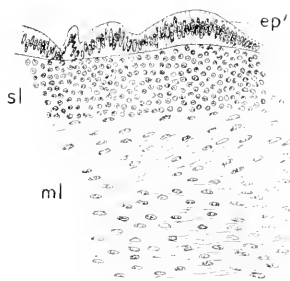

FIG. 7I.

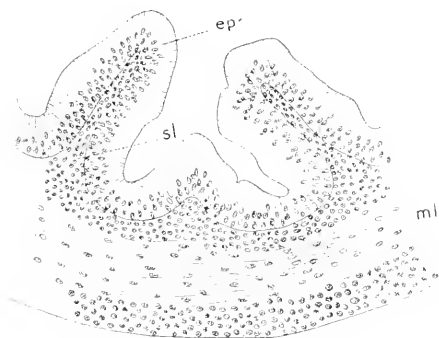

FIG. 7J.



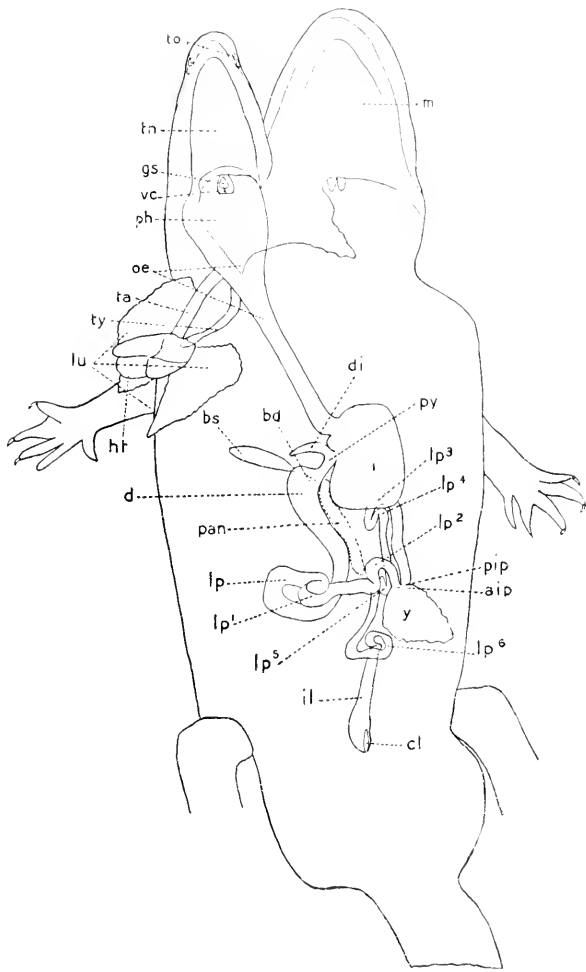

FIG. 8.









SMITHSONIAN MISCELLANEOUS COLLECTIONS

VOLUME 56, NUMBER 12

## Hodgkins Fund

# THE FLYING APPARATUS OF THE BLOW-FLY

A CONTRIBUTION TO THE MORPHOLOGY AND PHYSIOLOGY  
OF THE ORGANS OF FLIGHT IN INSECTS

WITH TWENTY PLATES

BY

DR. WOLFGANG RITTER



( PUBLICATION 1047 )

CITY OF WASHINGTON  
PUBLISHED BY THE SMITHSONIAN INSTITUTION

1911

The Lord Baltimore Press  
BALTIMORE, MD., U. S. A.

## Hodgkins Fund

# THE FLYING APPARATUS OF THE BLOW-FLY

## A CONTRIBUTION TO THE MORPHOLOGY AND PHYSIOLOGY OF THE ORGANS OF FLIGHT IN INSECTS<sup>1</sup>

BY DR. WOLFGANG RITTER

(WITH TWENTY PLATES)

### CONTENTS

- I. Introduction.
- II. Historical survey.
- III. Description:
  - A. Anatomical section.
    1. Material and methods of investigation.
    2. General remarks on the thoracic skeleton of the Diptera.
    3. The thoracic skeleton so far as it relates to flight.
      - a. The exoskeleton.
      - b. The endoskeleton.
    4. The wing.
      - a. General observations.
      - b. The system of veins and folds.
      - c. The pilosity.
      - d. The flexible zone.
    5. The articulation of the wing.
      - a. Thoracic portion.
      - b. Intermediate parts.
      - c. Alar portion.
    6. The muscles of flight.
      - a. Indirect muscles.
      - b. Direct muscles.
  - B. Physiological section.
    1. Methods of investigation.
    2. Flight.
    3. Function of muscles and joints.
- IV. Synopsis of results.
- V. Literature.

<sup>1</sup> The present investigation on the flying apparatus of the blow-fly was carried on at the Zoological Laboratory of the German University at Prague, with the assistance of a grant from the Hodgkins Fund of the Smithsonian Institution. It was under the supervision of Prof. R. von Lendenfeld of that laboratory.

## I. INTRODUCTION

When I began, some two years ago, to investigate intimately the flying apparatus of the Diptera, I intended to make it a *comparative* study; but, on obtaining an insight into the literature on the flying organs of insects, I abandoned this idea because I found the necessary foundation for a comparative work wanting: there does not exist a single exact, perspicuous and well-illustrated description of a Dipterous insect. I determined, therefore, to confine my studies to a careful examination of the organs of flight in a single species.

An examination of the literature of the subject showed me how inexact the illustrations are and how difficult it is to use them to any advantage in determining the parts of the actual object. From the rough and almost useless drawings of Lowne (1890-1895) to the beautifully executed but quite schematic plates of Künckel (1875-1881), there is nothing that really approaches nature.

In order to avoid the mistakes of my predecessors I made use of photography for the graphic representations. This had not hitherto been done, and indeed it seemed unlikely that it would be possible to obtain good photographs of the thorax and wing-skeleton on account of the yellow color of the chitin forming the hard parts, and the apparent impossibility of obtaining sharp definition upon the plate of all parts of such plastic bodies as are found in the skeleton of the flying apparatus.

After many unsuccessful attempts I finally succeeded, by means of plates ("color") sensitive to yellow color and a Zeiss binocular, in producing stereoscopic views true to nature in every particular except that of color (see the section on material and methods of research). Some schematic drawings, especially of muscles, were necessary for further elucidation.

The movement of the wings was studied by means of kymographic curves and serial photographic representations of *Calliphora vomitoria* in the act of flight, made by Prof. von Lendenfeld.

I abandoned my original intention to introduce a nomenclature applicable alike to all higher insects, because I recognized that that could properly be done only by means of very extensive studies in comparative anatomy and embryology. I had, therefore, to content myself with selecting from the names already in use those which appeared to me most suitable; such old appellations as were directly contrary to the truth being replaced by new terms. At the same time I allowed myself, especially in the designation of parts not hitherto named, to be guided, as was F. Voss (1905), by the prin-

ciple that topographic relationship should be considered as of the first importance. In cases where this was not quite practicable, as, for example, in the case of the middle pieces of the wing-joint, I gave to the entire group a collective designation of a topographic character, and distinguished the separate parts by means of letters or figures. For new terms I mostly used Greek stems with Latin terminations.

And now I wish to thank most heartily my honored instructor, Professor von Lendenfeld, for his valuable advice and suggestions. Also I would thank his assistant, Dr. Emanuel Trojan, for his ever ready assistance and his interest in my work.

## II. HISTORICAL SURVEY

I found in the literature but very few papers on the flying apparatus of the Diptera. The principal contributions to this subject are the work of Künckel d'Herculais on the Syrphidæ (1875-1881), in which, however, the flying apparatus is treated quite incidentally, Hammond's work on the thorax of *Calliphora vomitoria* (1879), and the monograph on the blow-fly by Lowne (1890-1895), in both of which the flying apparatus is also described very superficially.

The historical development of our knowledge of the means of flight of insects in general is summarized below.

The first notable works on this subject were published in the first half of the nineteenth century. At that time it was chiefly the French who concerned themselves with this subject, especially Latreille (1819), Chabrier (1822), Audouin (1824), and Strauss-Dürkheim (1828). At about the same time there appeared the works of Kirby and Spence (1823-1833) and Burmeister (1832). All these works treat of the entire insect world or at least of a large portion of it. Only in the second half of the nineteenth century and later have special works on the organs of flight of insects been published. The most important of these are von Lendenfeld's work on the flight of the dragon-flies (1881), Luks' articles on the musculature of insects (1883), Amans' anatomical and mechanical studies on the organs of flight in insects (1883), Adolph's description of the venation of the wings of Diptera (1885), Redtenbacher's comparative studies (1886), Marey's (1869-1872), Pettigrew's (1872-1873), and von Lendenfeld's mechanico-physiological works, and the exact description of the thorax of *Gryllus domesticus* by Voss (1905).

### III. DESCRIPTION

#### A. ANATOMICAL SECTION

##### I. MATERIAL AND METHODS OF RESEARCH

As an object of investigation the blow-fly, *Calliphora vomitoria*, was chiefly used, the Syrphidæ being also studied incidentally. The blow-fly was selected because it is easily procured in large numbers and is of considerable size. Besides, this species appeared as a favorable object because of the very strong development of its skeleton.

The first investigations were made with an ordinary microscope, but the inadequacy of this apparatus soon became apparent, and later only the binocular was used. The skeleton was studied in preparations in which the soft parts had been removed with liquor potassæ. The best results are obtained when the thoracic segments required are left at ordinary temperature about a week in a 50 per cent solution of the alkali. Boiling in the same liquid removes the muscles at once, but this method has the great disadvantage of causing the chitinous parts, chiefly the membranes and ligaments, to shrink. If the preparation appears to be too dark it can be bleached by long immersion in 50 per cent liquor potassæ. Rapid bleaching may be attained by means of a mixture of chlorate of potash and a little hydrochloric acid.

Ordinary Canada balsam preparations of the smaller and thinner parts can be made without any difficulty. The preparations of larger parts, such as median sections of the thorax, were made in the following manner. Small glass dishes with base ground flat were filled with Canada balsam dissolved in chloroform, and this was boiled until bubbles ceased to rise. The specimen was cleared up with oil of cloves and then immersed in the balsam while the latter was still warm and soft. It was then properly oriented and protected with a cover-glass.

Wings, before being placed in the balsam, were boiled in chloroform according to Walter's method (1907), and thus the tracheæ (veins) were freed from air.

Series of celloidin-sections were prepared both of parts previously treated with liquor potassæ and of parts simply hardened in alcohol. From the latter, however, no good sections of the skeleton and the smaller steering muscles could be obtained, because the very brittle chitin, especially in the complicated articular structures, broke before the knife. When the chitin was bleached and softened by



liquor potassæ it could, of course, be cut easily enough, but then it showed deformations. The results of serial sections were satisfactory only in studying the larger muscles (pl. 4A, fig. 10).

Cross-sections of the wings imbedded in celloidin were easily prepared and gave excellent results (pl. 4B, figs. 12, 13, 14).

The stereoscopic pictures which illustrate this paper were photographed with a Zeiss binocular on color plates (Weslendorp and Wehner). The contour drawings, with their lettering were produced as follows: The original stereoscopic photographs were enlarged by means of an episcopes, projected upon transfer paper and copied thereon. These copies were then mounted on cardboard, provided with the lettering, and then again photographed and reduced to the size of the original stereoscopic photographs.

## 2. GENERAL REMARKS UPON THE THORACIC SKELETON OF THE DIPTERA

Apart from the much debated microthorax, the thorax of insects consists of three segments: the pro-, meso-, and metathorax. These three segments are developed very unequally. In insects capable of vigorous flight the segment or segments bearing the wings are better developed than the others. In the Diptera the mesothorax, which bears the single pair of wings, is developed much better than the other two. The prothorax is greatly reduced. In each segment there is to be distinguished: the notum or dorsal portion, usually composed of the three parts, præscutum, scutum, and scutellum; the pleuræ or lateral portions, usually composed of the two parts, episternum and epimerum; and the sternum or ventral portion.

Kolbe (1893) named the endoskeletal processes which extend inward from the notum, the pleura and the sternum: phragmæ, apodemæ and apophyses, respectively. By prefixing the syllables pro-, meso-, or meta- he designated the segment to which each belongs.

In *Calliphora vomitoria* the mesothorax forms by far the greatest part of the whole thorax. The entire back of the thorax is covered by the uncommonly well-developed mesonotum.

I should like here to make some remarks concerning the determination of the limits between the thoracic segments. Künckel d'Herculais (1875) expressed the view that the mesonotum consists of præscutum, scutum, scutellum and postscutellum. The deep notches between the parts he considers as præscutum and scutum, and the parts he considers as scutum and scutellum render it not

improbable, however, that these three pieces are primary segments of the insect's thorax and not, as Künckel and Lowne think, parts of the mesothorax. I will not here pursue this question further, and provisionally accept the ideas of Künckel and Lowne in spite of my doubts as to their correctness.

### 3. THE SKELETON OF THE THORAX, SO FAR AS IT RELATES TO FLIGHT

The part of the thorax most important for flight is the mesothorax. In its skeleton we may distinguish exoskeletal and endoskeletal parts.

#### EXOSKELETAL PARTS

These are the mesonotum, the mesopleura and the mesosternum.

#### *The Mesonotum*

The mesonotum consists of four parts, the præscutum, scutum, scutellum and postscutellum.

*The præscutum* (pl. 1, fig. 1; pl. 2, figs. 3, 4; pl. 8, fig. 23; *p*), together with the scutum, scutellum, parapleurum and mesosternum, forms a group of the largest and strongest chitinous plates of the thorax. Beginning in the region of the cervical opening, the præscutum rises vertically upward, assumes near the limit between the first and second third of its length a horizontal position, and at the same time broadens out. From the angle between these two surfaces backward it is covered with hair. The hairs are directed backward and increase in length toward the scutellum. They are of two kinds: small, fine hairs and coarse bristles. The latter are arranged in irregular, longitudinal, and transverse rows. On the præscutum six longitudinal and three transverse rows of bristles can usually be distinguished. They fall out when the thorax is treated with liquor potassæ, and their places of attachment then appear as circular holes. The hairy covering of the back appears to be especially liable to injury. The small hairs also are often missing in many places, their points of attachment appearing as small dots. Two shallow, longitudinal furrows divide the præscutum into three zones. These are continued on the scutum but are absent on the scutellum. Ventrally, the præscutum is separated from the parapleurum by the pleural cleft. Laterally, toward the scutum, triangular areas, feebly chitinized and clear in appearance (pl. 2, fig. 3), border on the præscutum.

The *scutum* (pl. 1, fig. 1; pl. 2, figs. 3, 4; pl. 8, fig. 23; *s*) is the largest plate of the thorax. It is about twice as broad as long, slightly convex dorsally, and extends downward laterally in an obtuse angle to the root of the wing. Like the *præscutum*, it is provided with bristles which form six longitudinal and three transverse rows. Besides these rows there are usually present on its lateral parts, where the *scutum* bends downward, four bristles, one of which is situated on the tip of the *spina scutalis* (pl. 1, fig. 1; pl. 2, figs. 3, 4; pl. 8, fig. 23, *sp*). It is to be noted that the lateral parts of the *scutum* that slope downward toward the roots of the wings are not so strongly chitinized as the central part. Distally, these parts of the *scutum* are split into several parts, directly connected with the roots of the wings (see below). The *scutum* possesses two lateral, sharp, marginal projections, the *spinæ scutales* (pl. 1, fig. 1; pl. 2, figs. 3, 4; pl. 8, fig. 23, *sp*), which extend obliquely forward and downward into the *cristæ spinales*, which separate the two (right and left) *fossæ præalares* (pl. 8, fig. 23, *f*<sub>1</sub>) from the *fossæ postalares* (pl. 8, fig. 23, *f*). These two pairs of depressions have a special relation to flight. When the wing beats upward and backward, the rigid portions, the marginal veins and the *remigium*, come to lie in the *fossæ præalares*, the flexible, posterior portions in the *fossæ postalares*. When the wing makes its greatest excursion backward and upward the *crista spinalis* adapts itself exactly to the notch between the rigid and flexible portions of the wing. This view is opposed to that held by Lowne. That observer correctly describes (1890-1892) the *spina scutalis* as separating the *fossæ præalaris* from the *fossa postalaris*, but in an illustration (*loc. cit.*, pl. 7, fig. 1) he shows the *fossa postalaris* in front of the spine, nearly in the position of the *fossa præalaris*. He correctly depicts an anterior fossa (pl. 2, fig. 3; pl. 8, fig. 23, *f*<sub>11</sub>) at the boundary between the *præscutum* and the *scutum*, but he omits the special *fossa præalaris*. If the unnamed projection which appears in his drawing farther in front, near the *scutum*, is intended to represent the *spina scutalis*, it is incorrect, as this projection is in reality much nearer the *scutellum*.

The two processes which extend from the *scutum* to the root of the wing, and which articulate with the latter, are the *processus præalaris* (*processus pteralis thoracis I*; pl. 2, figs. 3, 4, *ptI*), corresponding to the *fossa præalaris*, and the *processus postalaris* (*processus pteralis thoracis II*; the great alar apophysis of Lowne; pl. 2, figs. 3, 4, *ptII*), corresponding to the *fossa postalaris*. The first

consists of two lobular parts, of which only the ventral one (the anterior præscutum of Lowne) extends right down to the root of the wing. The boundary between the two processes is formed by the cleft that runs along the crista spinalis. The ventral portion of the processus præalaris passes below into a narrow ligamentous band that thins out distally, and is attached to the inner side of the processus pteralis alæ 2 (the coracoid of Lowne, pl. 8, fig. 23, *pt2*). The processus præalaris and postalaris are connected with each other by a narrow, chitinous bridge which is very tender and easily destroyed in preparing the specimens (pl. 8, fig. 23; in all the other illustrations it is lost). The processus postalaris is a chitinous strip which decreases in size opposite the root of the wing, and has at its end a somewhat deep depression, the sella processus postalaris. In this lies, at an angle of 90 degrees, the proximal notch of the pterale A (pl. 8, fig. 24; pl. 9, fig. 25, *ptA*). Lowne calls the processus præalaris the parascutum. I have found no evidence that it should be considered as a separate piece. At the point of separation of the ventral and dorsal portions of the processus præalaris a small finger-shaped process, the processus dactyloformis (pl. 2, figs. 3, 4, *pd*), is situated. This extends dorsally into the interior of the thorax.

The *scutellum* (pl. 1, fig. 1; pl. 2, figs. 3, 4, *se*) has, when looked at from above, the shape of an equilateral triangle. The sides of this triangle are convex, and one of its corners is anal. The anal portion overhangs. The scutellum is beset with bristles along its edge and also bears two bristles on its back. The scutum is connected with the scutellum by the two scutellar bridges (Lowne). Along the processus postalaris extends a cleft which widens toward the root of the wing to form the foramen postalare (the supratympanic fissure of Lowne; pl. 2, fig. 3, *o<sub>1</sub>*).

The *postscutellum* (pl. 2, fig. 3, *ps*) is cushion-shaped; upon it the scutellum rests. Toward either side it narrows considerably. I doubt whether the postscutellum belongs to the mesothorax, but, since there is not sufficient evidence in favor of any other view, I, for the present, accept this conception.

#### *The Mesopleura*

Each mesopleurum is made up of the parapleurum, episternum, parepisternum, epimerum and parepimerum.

The *parapleurum* (lateral plate of Lowne; pl. 2, figs. 3, 4, *pp*) is nearly quadrilateral. It is separated from the præscutum by the

pleural cleft; extends to the stigma anteriorly and ventrally reaches the mesosternum, with which, and with the paratrema of Lowne, it is connected by a bridge. Towards the anus a cleft, the fissura episternalis, separates the parapleurum from the episternum. A row of bristles runs along this fissure. The entire parapleurum is clothed with hair.

*The episternum* (pl. 2, figs. 3, 4, *e*) is narrow and dorsally reduced to the processus pterales episterni (see *C5*). Ventrally it reaches the mesosternum, analwards the epimerum.

*The epimerum* (pl. 2, figs. 3, 4, *ep*) has an elongated, oval shape, and is closely set with long hairs.

*The parcpimerum* (pl. 2, figs. 3, 4, *pm*) which Lowne calls the costa, lies dorsally between the episternum and the epimerum, leans upon the latter, and like the epimerum is covered with hair.

*The parcpisternum* (pl. 2, figs. 3, 4, *pc*) lies dorsally upon the epimerum. I give it this name because it is closely connected with the episternum. It is triangular and considerably thickened on one side in the form of a pediculated bud. Here, as in the case of the stroma of the processus pteralis thoracis, we may make an exception to the rule that names implying form should not be used, and from its uncommonly impressive and striking bud-like shape, call it the *calyx*.

#### *The Mesosternum*

The mesosternum (pl. 1, fig. 2; pl. 2, figs. 3, 4, *es*) consists of two symmetrical halves, from each of which a process extends to the anterior pair of stigmata. These halves are nearly quadrilateral in shape and strongly curved. With the two metasternums they form the principal part of the central portion of the thorax. They unite in the median plane, bend inwards (upwards), and form, when united, the mesosternal process (furca of the mesosternum, Lowne; pl. 1, fig. 2, *ap*; see also below under Endoskeleton). The "lateral plate of the postscutellum" of Lowne should be mentioned in passing as it is connected with the wing through the squama. It is approximately triangular, strongly convex, and separated from the processus postalaris by the foramen postalare (supratympanic fissure of Lowne).

#### ENDOSKELETAL PARTS

The endoskeletal parts that are here to be considered are the præscutal crest, the mesapodema, which is continued into the episternal border, the mesapophysis and the so-called parapterum.

*The præscutal crest.* A narrow endoskeletal crest arises from the dorsal side and projects inward. This cannot be considered as a phragma. I name this the præscutal crest (pl. 2, fig. 4, *l*). It arises from the boundary between the præscutum and the paratrema, bridges the former, follows the ventral edge of the præscutum, and ends at the boundary between the præscutum and the scutum. Here it is connected by ligamentous attachments with the parapterum (pl. 2, fig. 4, *pn*).

*The mesapodema* (great entopleuron, Lowne; pl. 1, fig. 2; pl. 2, fig. 4, *a*) arises at the ano-dorsal curvature of the mesosternum. It does not wholly correspond to the apodema of Kolbe, but as it belongs almost entirely to the pleural portion of the thorax I will retain the above designation. Farther on the mesapodema follows the curvature of the mesosternum as far as the parapleurum to the anal and ventral corner of which it is attached. From here it extends, in the shape of a crest, above the boundary between epimerum and episternum (pl. 2, fig. 4; pl. 10, fig. 28, *l*<sub>1</sub>) to the root of the wing. I call this crest the *episternal crest* because it is attached to a process of the episternum, the processus pteralis thoracis IV. The episternal crest gradually passes into a tendinous ligament. The mesapodema bends first towards the anus and so forms, with the episternum, the episternal pouch, then it turns toward the head and projects toward the interior as a strong, jagged protuberance, the processus serratus (pl. 1, fig. 2, *a*).

*The mesapophysis* (pl. 1, fig. 2, *ap*) consists properly of two pieces, belonging to the two mesosternums. As already mentioned, the two mesosternums are joined to a single plate which projects vertically upwards into the interior (pl. 1, fig. 2, *ap*). This plate narrows distally, and finally again divides into two stalk-like pieces. These stalks diverge from each other and bear at their ends twisted cup-like enlargements, the processus alveolati (pl. 1, fig. 2, *ap*).

In conclusion, there should be mentioned a peculiar skeletal structure, the so-called

*Parapterum* (Andouin, Lowne; pl. 2, fig. 4, *pn*). This lies near the parapleurum, and is not firmly attached to any portion of the skeleton. It consists of a stalk-like part, the stem, which terminates in an enlargement, the head. The anal portion of the head reaches as far as the root of the wing, while the rostral portion, as already mentioned, is united by a ligament to the end of the præscutal border. The parapleurum serves, as do the above-mentioned endoskeletal

structures proper, as surfaces of attachment for the muscles. (See Chapter VI.)

Near the root of the wing there are found two large openings in the lateral wall of the thorax, through which direct muscles of flight pass to the wing joints: the foramen prealare (pl. 2, fig. 3, *o*) and the foramen postalare (pl. 2, fig. 3, *o*<sub>1</sub>).

#### 4. THE WING

##### A. GENERAL OBSERVATIONS

The wing of *Calliphora vomitoria* (pl. 3, figs. 5, 6; pl. 5, figs. 15-17) is, when fully expanded, irregularly oval. It is, according to the size of the fly, usually 8.5 to 11 mm. long and 3.4 to 4.6 mm. in maximum width. Its horizontal projection (outline) has an extent of from 20 to 40 square millimeters. Its anterior margin appears as a continuous convex line. The curvature is slight at the base and in the middle, but increases distally and is most marked at the tip of the wing. The posterior margin is, on the whole, convex like the anterior, but notched in three places. The most distally situated notch is insignificant and situated a short distance distally from the middle of the wing. The two other notches are deep incisions and situated, proximally, near the root of the wing. They separate two small lobes from the main portion of the wing. The proximal lobe (nearest the body) is the squamula (text figure 2; pl. 5, figs. 15, 17, *Sq*), the distal lobe which lies between the two deep incisions is the lobulus (text figure 2; pl. 5, figs. 15, 17, *lo*).

##### B. THE VEINS AND FOLDS

The wing is, as Marey recognized in 1869, somewhat warped and slightly convex above. Large and small folds, the former up to 100  $\mu$  in height, traverse the wing longitudinally. In the proximal part of the wing 8, and in its distal part 10 folds are to be distinguished. These folds decrease in height distally as they approach the margin of the wing. The anterior large folds are nearly parallel to the anterior margin of the wing, and extend to its end; the posterior smaller folds radiate somewhat in a fan-shaped manner and extend obliquely outward and backward. These folds disappear before reaching the margin of the wing. The posterior portion of the wing is creased by very small folds. These folds are numerous, closely crowded and directed backward and outward (pl. 5, figs. 15-17).

The wing is a thin, colorless, transparent and hairy membrane. It is supported by chitinous tubes, the so-called veins. The "venous" system formed by them consists of eight longitudinal tubes radiating in a fan-shaped manner from the wing-root, and of a number of transverse tubes, here and there connecting the longitudinal ones with each other. All these tubes (veins) diminish distally in width. The first longitudinal vein lies in the anterior margin of the wing. The longitudinal veins extend in the crests of the folds, but not all fold-crests are supported by veins.

The principal contributions to our knowledge of the anatomy of the wings of Diptera are by Redtenbacher (1886) and Adolph (1885). These distinguished investigators described the systems formed by the so-called "veins" and introduced a uniform nomenclature of the same, but they disregarded the other features of the wings. Adolph (*loc. cit.*), especially, has worked out a uniform

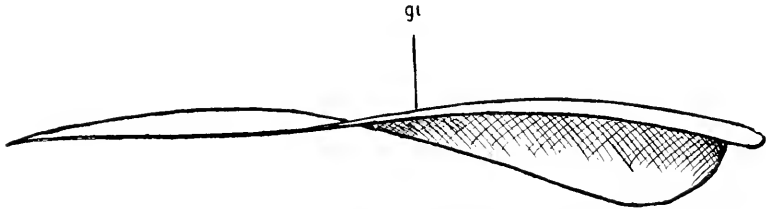

FIG. 1. Diagrammatic profile view of the wing seen from before, showing the warping; *gi*, marginal vein.

scheme for the venation. He says that the wings of all Diptera agree in respect to the venation, and that they differ only by the veins being often replaced by folds, and vice versa. To investigate how far he may be right was foreign to the task before me. I shall use for the veins the designations proposed by Adolph (*loc. cit.*), and append in brackets those of Lowne (1890-1895).

Adolph (1885) divides the wing into three regions: an anterior one, the *antica*; a middle one, the *media*; and a posterior one, the *postica*. The *antica* is indicated by *a*, the *media* by *m*, and the *postica* by *p*. The veins are distinguished by the letters *b* or *a*, according to whether they lie in the crest of folds that rise above (convex folds) or sink below (concave folds) the general wing surface. If more than one vein (or fold) arises in a region the veins (folds) are distinguished by Roman numerals. The most anterior or marginal vein is not included in this system, but has its own designation (*gi*). In this article Adolph's designations will be employed.



I shall now describe the eight longitudinal veins.

*Gi*, the marginal vein (text fig. 2; pl. 5, figs. 15, 17; pl. 8, figs. 23, 24, *gi*), begins with a club-shaped swelling at the processus pteralis alæ I. It is notched in the flexible zone (vide infra), and extends, gradually diminishing in thickness, as far as the medio-marginal transverse vein of Lowne (text fig. 2; pl. 5, figs. 15, 17,  $q_1$ ).

The four following veins are joined basally to a single vein, the remigium (text fig. 2; pl. 5, figs. 15, 17; pl. 8, figs. 23, 24, *rc*), which appears as a short and very strong tube. The remigium is the strongest vein of the entire wing.

*Iaa*, the auxiliary vein (mediastinal) (text fig. 2; pl. 5, figs. 15, 17; pl. 8, figs. 23, 24, *Iaa*) arises at the point where the anterior transverse vein (*at*) touches the remigium. Basally, in the flexible zone, it exhibits a transverse striation (vide infra).

*Iba* (subcostal) (text fig. 2; pl. 5; figs. 15, 17; pl. 8, figs. 23, 24, *Iba*) arises from the remigium and is about its middle strengthened by a swelling.

*IIaa* (radial) (text fig. 2; pl. 5, figs. 15, 17; pl. 8, fig. 23, *IIIaa*) and

*IIIba* (ulnar) (text fig. 2; pl. 5, figs. 15, 17; pl. 8, fig. 23, *IIIba*) arise together from the remigium. They are connected with the latter by a piece which exhibits particularly clearly the transverse striation of the veins in the flexible zone (pl. 7, figs. 20, 21, 22). The place of common origin of these two veins is thickened and set with bristles. Between these two veins there are two high folds, one projecting upward (convex), *IIba*, the other projecting downward (concave), *IIIaa*.

*Iam*. Discoidal vein (median) (text fig. 2; pl. 5, figs. 15, 17; pl. 8, figs. 23, 24, *Iam*). This is the first vein of the median area; it forms, with the *IIbm* and the transverse vein of the knee, the knee of the wing (*fk*). It is connected with *IIba*, proximally, by the transverse vein of the knee (patagio-hypocostal), farther on by the median transverse vein (*q*), and at the tip by the medio-marginal transverse vein  $q_1$  with the end of the marginal vein. Between *Iam* and *IIIba* are found the folds *II'aa* and the *Spuria*, *II'ba*.

*IIbm* (submedian) (same figs.) extends in the crest of a strongly protruding, convex fold right to the posterior margin of the wing. It arises from the knee of the wing and is connected with *Iam* by two transverse veins; the postical transverse (*po*) and the discoidal-

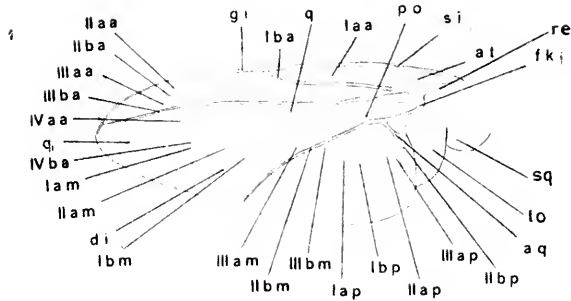

FIG. 2. Scheme of the wing.

Longitudinal folds (longitudinal veins) :

- gi*, Anterior margin, marginal vein.  
*Iaa*, First depressed (concave) fold of the anterior region, auxiliary vein.  
*Iba*, First raised (convex) fold of the anterior region, subcostal vein.  
*IIaa*, Second depressed (concave) fold of the anterior region, radial vein.  
*IIba*, Second raised (convex) fold of the anterior region.  
*IIIaa*, Third depressed (concave) fold of the anterior region.  
*IIIba*, Third raised (convex) fold of the anterior region, ulnar vein.  
*IVaa*, Fourth depressed (concave) fold of the anterior region.  
*IVba*, Fourth raised (convex) fold of the anterior region, spuria.  
*Iam*, First depressed (concave) fold of the middle region, discoidal vein.  
*Ibm*, First raised (convex) fold of the middle region.  
*IIam*, Second depressed (concave) fold of the middle region, division vein.  
*IIbm*, Second raised (convex) fold of the middle region, submedian vein.  
*IIIam*, Third depressed (concave) fold of the middle region.  
*IIIbm*, Third raised (convex) fold of the middle region.  
*Iap*, First depressed (concave) fold of the posterior region, anonyma.  
*Ibp*, First raised (convex) fold of the posterior region.  
*IIap*, Second depressed (concave) fold of the posterior region, anal vein.  
*IIbp*, Second raised (convex) fold of the posterior region, axillary vein.  
*IIIap*, Third depressed (concave) fold of the posterior region.

Other parts :

- aq*, Transverse anal vein.  
*at*, Anterior transverse vein.  
*di*, Discoidal transverse vein.  
*fk*, Knee of the wing.  
*lo*, Lobulus.  
*po*, Posterior transverse vein.  
*q*, Median transverse vein.  
*qi*, Medio-marginal transverse vein.  
*re*, Remigium.  
*si*, Notch of the marginal vein in the flexible zone.  
*sq*, Squamula.

transverse (*di*). Between *Ibm* and *Iam* are found the folds *Iiam* (division vein), *Ibm* and *IIIam*.

*Iiap*, the anal vein (same figs.), does not arise from the knee of the wing, as is shown by Lowne in his illustration (1890-1895, v. I, pl. 10, fig. 1), but reaches as far as the *tau* of Lowne, that is, the inner marginal vein of the lobulus (*l. c.*, pl. 9, fig. 25; pl. 11, fig. 29, *ic*). It articulates with a branch of this vein by a protuberance at its base. This arrangement acts as a stop that prevents the anal portion of the wing from flapping too far downward. The anal vein is connected with the knee only by means of a band of chitin which, however, is not visible from above because it is covered by the knee of the wing. The anal vein is connected with the *IIBM* by the transverse anal vein (*aq*). Between the two last-named longitudinal veins lie the folds: *IIIbm*, *Iap*, the anomya, the boundary between the area media and the area postica, and *Ibp*.

*Ibp*, the axillary vein (same figs.), is very feeble; it can just be made out as a vein. It arises at the tip of the inner marginal vein of the lobulus, with which it forms an acute angle. The last fold is *IIIap*.

The longitudinal and transverse veins divide the wing into the following fields (Lowne, 1890-1895):

- The regio mediastinalis between *gi* and *Iaa*.<sup>1</sup>
- The regio subcostalis between *Iaa* and *Iba*.
- The regio marginalis between *Iba* and *Iaa*.
- The regio cubitalis between *Iaa* and *IIIba*.
- The regio præpatagialis between *IIIba* and *Iam*, proximal.
- The regio subapicalis between *IIIba* and *Iam*, distal.
- The regio apicalis between *q<sub>1</sub>* and terminal border, distal.
- The regio anterior basalis between *Iam* and *IIBM*, proximal.
- The regio discoidalis between *Iam* and *IIBM*, distal.
- The regio posterior basalis between *IIBM* and *Iiap*, proximal.
- The regio patagialis between *IIBM* and *Iiap*, distal.

At the posterior border of the wing, in the regiones subapicalis, apicalis, discoidalis and patagialis there are found numerous small transverse folds, which extend toward the posterior border.

All the veins taken together appear as a net or framework composed of tubes, the meshes of which are occupied by the double hairy lamella that forms the wing plate. The lamella of the wing has a certain firmness. This prevents the posterior part, which is not supported by any veins, from collapsing.

<sup>1</sup>I use the term regio instead of area (Lowne) in order to avoid a confusion with the terms area antica, media, etc.

## THE PILOSITY

The anterior marginal vein bears large and small hairs which are directed obliquely forward, upward and outward. On its distal part the large hairs form two rows; proximally, the large hairs increase in number and size, and inside the notch (pl. 6, figs. 18, 19, *si*) this vein is closely set with large bristles. The small hairs are not nearly so numerous as the large. The wing plate (lamella) is also thickly covered with hairs (pl. 4B, figs. 12-14). These are curved. The direction of their curvature is determined by the direction of the nearest longitudinal vein or fold. The hairs are inclined toward the wing margin, in the same direction as that taken by the nearest veins. Upon the anal portion, which comprises about two-thirds of the entire wing, the hairs are inclined outward and backward toward the posterior wing margin. To each hair of the upper side there is a corresponding hair on the lower side, the places of insertion of the dorsal and ventral hairs lying nearly opposite. It should be noted that the photographs of the sections do not give a reliable representation of the direction of the hairs, as the pressure of the cover-glass in thin sections generally changes their position more or less.

## THE FLEXIBLE ZONE

(Pl. 6, figs. 18, 19, *si*; pl. 7, figs. 20, 21, 22.)

The anterior marginal vein is incised anteriorly by a conspicuous notch (pl. 6, figs. 18, 19, *si*). This is situated just above the anterior transverse vein. Closer examination with higher powers shows that this notch is in truth a transparent, only slightly chitinized and hairless part of the vein. In order to ascertain its significance I grasped the base of a fresh wing with the forceps and then bent the tip backward with a needle. Even with the unaided eye I could see that the wing was then always abruptly bent at the same place, and that this flexible point lies about one-sixth of the length of the wing distant from its base. On repeating this experiment under the binocular I found that the bending always occurred in a slightly curved zone beginning at the notch in the anterior marginal vein. I call this bending zone the flexible zone (pl. 6, fig. 18). It extends from the before-mentioned notch backward over the *Iba*, which there shows a bowl-like depression, parallel to the line formed by the anterior transverse vein and the knee of the wing. Just within (proximally from) this zone the strong re-

migium divides into three separate veins. The parts of these veins, especially of *Ilaa* and *IIIba*, which are here still united, passing through the flexible zone, are lighter colored than their other parts. This lighter coloring is caused by the strong, dark chitin being here restricted to narrow, transverse belts, separated by belts of similar width, composed of weak and pale chitin (pl. 7, figs. 20, 21, 22). This portion of the vein is similar in structure to the ordinary tracheæ within the body, except that the strong and dark chitin does not here form a continuous spiral band, but transverse belts or bars.

### 5. THE ARTICULATION OF THE WING

(Pl. 8, figs. 23, 24; pl. 9, figs. 25, 26.)

The skeletal parts forming the articulation of the wing can be divided into three groups:

- a. The thoracic parts (processus pterales thoracis).
- b. The intermediate parts (pteralia), and
- c. The alar parts (processus pterales alæ).

In naming these parts I have avoided all terms relating to form or function and have designated them by letters and figures. I selected for the processus pterales Roman figures, for the pteralia capital letters, and for the processus pterales alæ Arabic figures (for example Proc. pter. al. 1, etc.). This method is more practical than the application of the terms used for analogous, but in no way homologous, parts of the vertebrate skeleton to the insect skeleton. In certain cases where I have either been able to ascertain the function of a part, or where its form is so striking that it easily impresses itself upon the memory, I propose to substitute, for better orientation, instead of the above-mentioned designations, short terms such as calyx, stroma, etc. For the processus pterales thoracis I and II the well-founded, older names processus præalaris and postalaris will be retained. Besides the parts belonging to the above-mentioned groups there are others found in the articulation of the wing which may be designated as stays.

#### A. THE THORACIC PORTION (PROCESSUS PTERALES THORACIS)

This portion consists of six pieces:

- I. *Processus pteralis thoracis I* (Processus præalaris) (pl. 2, figs. 3, 4; pl. 8, fig. 24; pl. 9, fig. 25, *pII*).

Described above with the scutum.

2. *Processus pteralis thoracis II* (*Processus postalaris*) (pl. 2, figs. 3, 4; pl. 8, figs. 23, 24; pl. 9, fig. 25, *ptII*).

Described above with the scutum.

3. *Processus pteralis thoracis III* (pl. 2, figs. 3, 4; pl. 9, fig. 26; pl. 10, figs. 27, 28, *ptIII*). This process is the præ-epaulet of Strauss-Dürkheim (1828). It arises at the episternum, narrows to a thin band that suddenly broadens distally to a semi-circular piece, and is then drawn out into a delicate band which passes into the membrane (see pl. 9, fig. 26) inserted upon the *processus pteralis alæ* 3 below the *pterale B* (pl. 9, fig. 26, *pt3*).

4. *Processus pteralis thoracis IV* (pl. 2, figs. 3, 4; pl. 9, fig. 26; pl. 10, figs. 27, 28, *ptIV*). This process is the "great ampulla" of Lowne. According to its function and form it may be designated as *stroma* (cushion). It is a protruding cushion-shaped piece, united with the episternum by means of a broad band, and situated in the axillary cavity of the thorax. Between the distal end of this piece and the head of the *processus pteralis thoracis III* there is a triangular stay (pl. 9, fig. 26; pl. 10, figs. 27, 28, *v*).

5. *Processus pteralis thoracis V* (pl. 4A, fig. 11; pl. 9, fig. 26; pl. 10, figs. 27, 28, *ptV*). Four pieces combine to make up this process: the episternum, the parepisternum, the *stroma* and the episternal border. Three strongly chitinized bands arise from the episternum. These finally unite with the episternal border to form a strong chitinous bar which bears at the end the process. The process itself appears as an inflation. It bears, proximally from the *stroma*, three small spines and distally one larger one. The entire process somewhat resembles a comb with a handle.

6. *Processus pteralis thoracis VI* (pl. 8, fig. 24; pl. 9, fig. 26; pl. 11, fig. 29; *ptVI*). This process arises from the crest that runs along the "lateral plate of the postscutellum" (Lowne) and is joined to the squama. It is a short, distally thickened, chitinous piece, which shows a saddle-like depression that corresponds with a similar saddle surface in the *processus pteralis alæ* 4 (pl. 11, fig. 29, *pt4*).

#### B. THE INTERMEDIATE PARTS (PTERALIA)

This group consists of three pieces:

1. *Pterale A* (pl. 3, fig. 8; pl. 4A, fig. 9; pl. 8, figs. 23, 24; pl. 9, fig. 25; *pt1*). This *pterale* is the "dens" of Lowne. It bears four large protuberances, two shorter proximally, and two longer distally directed ones. One of the proximal ones extends into the interior

of the thorax. This protuberance is the *processus duplicatus* (pl. 3, fig. 8; pl. 4, fig. 9, *du*). It is divided into two secondary protuberances by a shallow saddle. The proximal protuberances ride, as it were, on the *sella processus postalaris*. Of the distal protuberances, one, the *processus analis* (pl. 3, fig. 8; pl. 4, fig. 9, *an*), is directed anally, the other rostrally. The former corresponds to the notch in the *processus pteralis alæ 4*; the latter, the *processus rostralis* (same figs., *ro*), clasps the *pterale B* (pl. 8, fig. 24; pl. 9, fig. 25, *ptB*) and extends as far as the *processus pteralis alæ 2*.

2. *Pterale B* (pl. 3, fig. 7; pl. 8, fig. 24; pl. 9, figs. 25, 26; *ptB*). This *pterale* is the *unguiculus* of Löwne. It is situated vertically and connects the upper and under sides of the joint. From the upper side a strong protuberance, the *processus proximalis* (pl. 3, fig. 7, *x*) arises. This protrudes beyond the *processus rostralis* of *pterale A*. From the lower side two important protuberances, the *processus dentales* (pl. 3, fig. 7, *de*), arise. In the space between these two protuberances lies the anal convexity of the *processus pteralis thoracis V*. Besides those mentioned above there are three smaller protuberances which appear to be of minor importance.

3. *Pterale C* (pl. 9, fig. 26, *ptC*; pl. 10, figs. 27, 28, *ptC*). This *pterale* is the *hypopterigium* of Löwne. It consists of a skeletal piece surrounded by a hyaline elastic mass. The skeletal portion has somewhat the form of a pistil with a strongly expanded head and a conical stem. *Pterale C* is in contact with the stay *V*. The head of the *pterale* lies in the deep, strongly chitinized, articular fossa of the *processus pteralis alæ 3* (see pl. 9, fig. 26).

### C. THE ALAR PORTION (PROCESSUS PTERALES ALÆ)

The marginal vein and the remigium form the principal part of the alar portion of the joint. The remaining proximal parts of the wing take hardly any part in its formation.

Four *processus pterales alæ* are to be distinguished:

1. *Processus pteralis alæ 1* (pl. 8, figs. 23, 24; pl. 9, figs. 25, 26; *pt1*). This process appears as a continuation of the club-shaped basal protuberance of the marginal vein. It resembles a hand held hollow, articulates with the *processus pterales alæ 2* and 3, and is separated from the marginal vein by a sharp incision and a clear, feebly chitinized zone. Rostrally, it is covered by a scale-like, hairy piece, the *tegula* (pl. 8, figs. 23, 24; pl. 9, figs. 25, 26, *t*), which extends over the whole joint. The names pre-epaulet, epaulet and sub-epaulet, with which Strauss-Dürkheim designated different portions

of this piece, and which Lowne afterward adopted, I do not consider suitable.

2. *Processus pteralis alæ 2* (pl. 8, figs. 23, 24; pl. 9, fig. 25; *pt2*). This process arises dorsally from the remigium. It has the shape of a rectangle with rounded corners, to which an oval piece is attached proximally. This oval piece extends distally to a notch of the remigium, into which it fits. As already stated the rectangular piece is embraced by the *processus pteralis alæ 1*. The *processus pteralis alæ 2* is connected with the *processus præalaris* by a ligament.



FIG. 3. View of the proximal part of the remigium from below. Diagrammatic. (Magnification 80.)

*pt. 2*, *Processus pteralis alæ 2*.  
*pt. 3*, *Processus pteralis alæ 3*.

3. *Processus pteralis alæ 3* (pl. 9, fig. 26; text fig. 3; *pt3*). This process is attached ventrally to the remigium. Its form reminds one of a compressed cornet or cone with oval base. It might be considered as having arisen from the ventral border of the remigium, which is, in this region, trough-shaped, being bent outward. The anal part of the curved surface is strongly chitinized, the part turned toward the marginal vein only slightly so, and compressed.

The head of pterale C fits into this strongly chitinized cavity, and thus the asymmetrical form of this pterale finds its explanation in the asymmetry of the *processus pteralis alæ 3*.



4. *Processus pteralis alæ 4* (pl. 8, fig. 24; pl. 9, figs. 25, 26; pl. 11, fig. 29; *pt4*). Before taking this processus into consideration I shall describe the inner marginal vein of the lobulus, with which it is closely connected. The deep incision which separates the lobulus (text fig. 2; pl. 5, figs. 15, 17; pl. 11, fig. 29, *lv*) from the wing proper extends as far as the origin of the axillary vein. The proximal part of this vein is a strongly chitinized thickening of the wing-lamella, and connected with the anal vein. This thickening forms at the same time the point of origin of an elevated (convex) fold which extends to the tau of Lowne (1890-1895, vol. I, pl. 10, *t*) and passes into it. The crest of the fold, together with the tau, form the margin of the lobulus, and are together to be considered as its inner marginal vein (pl. 11, fig. 29, *iv*). The proximal end of this vein loosely articulates by means of a sort of ball and socket joint with the posterior (anal) marginal thickening of the squamula (see pl. 11, fig. 29). This marginal thickening bends downward and inward, and passes into the processus pteralis alæ 4, which is, in truth, the proximal, terminal portion of the inner marginal vein of the squamula. As the proximal end of this is strongly chitinized and differentiated as an articulating part, I reckon it among the processus pterales. The processus pterale alæ 4 has a depression into which fits the anal process of pterale A. The surface of the terminal portion of the processus pterale alæ 4 is in one place saddle-shaped. This saddle fits, as already stated (see thoracic portion), onto the saddle of the processus pterale thoracis II. Between the remigium and the processus pterale alæ 4 lies a stay (pl. 9, fig. 25, *v<sub>1</sub>*) which occupies the entire space between these structures and pterale B. It is especially well developed near the processus pterale alæ 4, where it is thickened to a disk. This stay is connected with the remigium by a strip of chitin (pl. 9, fig. 25). The parts of the joint are united by a chitinous membrane, and they can be considered as strong, local thickenings of this membrane. These articulating parts may well be considered as originating, so far as they are independent of the veins, from stimulations acting on the covering membrane so as to induce them to increase in thickness locally. The uniting membrane is flexible, but of considerable tensile strength.

The foramina præalaris and postalaris are bridged over by loose ligaments: the ligamenta præalare and postalare.

## 6. THE MUSCLES OF FLIGHT

The best way to study the muscles of flight is to make a median section of the thorax to work down laterally from this, and to observe with a binocular microscope. The illustrations to this paper relate throughout to preparations made and examined in this way. They show the successive muscular layers thus rendered visible.

Two kinds of muscles of flight are to be distinguished: indirect and direct. The former act indirectly upon the wings by compressing

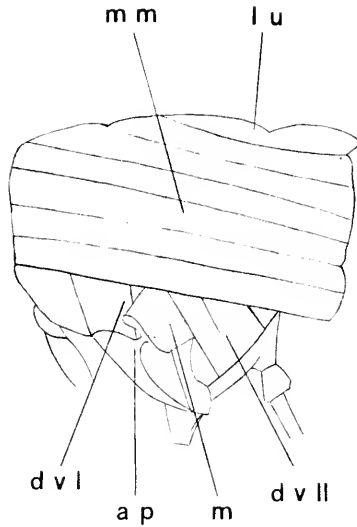

FIG. 4. Diagrammatic view of the median indirect muscles. (Median section of the thorax.)

*ap*, Mesapophysis.

*dvI*, Musculus dorso-ventralis primus.

*dvII*, Musculus dorso-ventralis secundus.

*lu*, Air-sac.

*m*, Musculus latus.

*mm*, Musculus dorsalis.

the breast longitudinally and vertically; the latter are attached to the roots of the wings and move them directly. The number of direct muscles is larger than is generally supposed; in *Calliphora vomitoria* there are no less than ten pairs. In the Libellulidæ, where only direct muscles of flight occur (von Lendenfeld, 1881, p. 344), these muscles are correspondingly strong. In the Diptera, where the chief work of flight is performed by the indirect muscles, these

are very well developed, while the direct muscles which serve chiefly for steering are small and weak.

Künckel (1875, p. 175) divides the entire musculature of the Diptera into three groups, the depressors (abaisseurs), the elevators (elevateurs) and the steering muscles (directeurs). The depressors and elevators are indirect, the steering direct muscles.

#### A. INDIRECT MUSCLES

A pair of powerful muscles, the musculi dorsales (Künckel, 1875, p. 175) (text fig. 4, *mm*; pl. 4, fig. 7, *mm*; pl. 12, fig. 31, *mm*) trav-

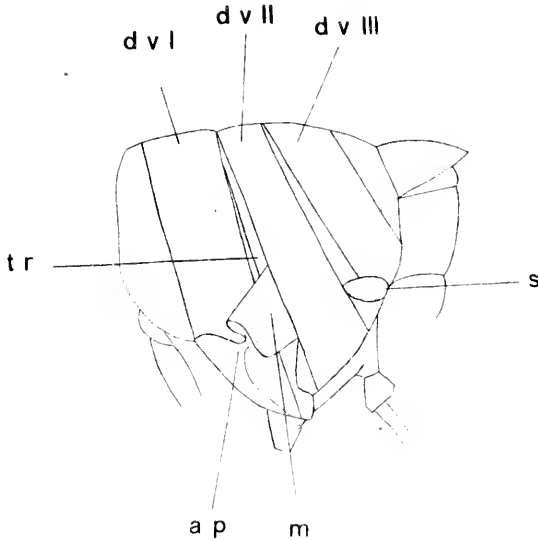

FIG. 5. Diagrammatic view of the more laterally lying indirect muscles. (Median section of the thorax.)

- |   |                                |
|---|--------------------------------|
| <i>ap</i> , Mesapophysis.                             | <i>m</i> , Musculus latus.     |
| <i>d v I</i> , Musculus dorsalis-ventralis primus.    | <i>st</i> , Stigma anterius.   |
| <i>d v II</i> , Musculus dorsalis-ventralis secundus. | <i>tr</i> , Trochanter muscle. |
| <i>d v III</i> , Musculus dorsalis-ventralis tertius. |                                |

erse the entire length of the thorax. Each of these consist of six separate parts of unequal length. The first, dorsal portion, extends from the boundary between the scutellum and postscutellum of the mesothorax to about the middle of the scutum, where it is inserted. Between this muscle, the scutellum and the anal portion of the scutum there is an empty (air-filled) space (pl. 12, fig. 31, *lu*) which is to be regarded as an air-sac.

Laterally from the two dorsal muscles, there are three powerful dorso-ventral muscles (text figs. 4, 5; pl. 4, fig. 32, *dv*), each of which appears to be composed of four parts. The first three I designate with the numbers from I to III. The fourth is apparently not a muscle of flight.

The musculus dorso-ventralis I (text fig. 5; pl. 12, fig. 32; *dvI*) is the strongest. It extends from the dorsal portion of the præscutum to the mesosternum.

The musculus dorso-ventralis II (text fig. 5; pl. 12, fig. 32; *dvII*) extends from the rostral portion of the scutum to the metasternum.

The musculus dorso-ventralis III (text fig. 5; pl. 12, fig. 32; *dvIII*) is attached to the scutum behind the musculus dorso-ventralis II, and extends to the "tympanic plate" of Lowne (s. l., 1890-1892, t. 7, figs. 2, 24), to the thickened margin of which it is fixed.

The fourth dorso-ventral muscle (text fig. 5; pl. 12, fig. 32, pl. 13, fig. 33; *tr*), which is much the weakest of the four, must, from its position, be considered as a leg muscle. It arises from the scutum, at the edge of the præscutum, lies under the turbinate process of the mesapophysis, and is inserted on the trochanter of the second pair of legs.

As an indirect muscle of flight the broad, ribbon-like musculus latus is also to be mentioned. It lies between the mesapophysis and the mesapodema.

#### B. DIRECT MUSCLES

As mentioned above, ten direct muscles are to be distinguished on either side.

1. *The adductor alæ* (text fig. 6; pl. 13, fig. 33; *md*). This muscle arises in the shape of a broad band from the mesapodema. Gradually attenuated, it extends to the foramen postalaris. It then becomes tendinous and passes through this foramen and is continued beyond in the ligamentum postalare, stretched out between the processus pteralis thoracis VI, the processus pteralis alæ 4, the processus postalaris and the pterale A.

2. *The abductor alæ primus* (text fig. 6; pl. 13, fig. 33; *mbI*). This muscle arises from the point where the parapleurum, the stigma anterius and the præscutum come in contact, close under the præscutellar edge. The muscle follows this edge, becomes broader distally, and attaches itself to the parapterum.

3. *The levator alæ primus* (text fig. 7, pl. 11, fig. 30, pl. 13, fig. 34; *ml*). This muscle is delta-shaped. It arises at the ventral,

somewhat thickened edge of the parapleurum and passes into a long, delicate tendon which is attached to the processus duplicatus of pterale A.

4. *The levator alæ secundus* (text fig. 6, pl. 11, fig. 30, pl. 13, fig. 34; *mcII*). This muscle is rhombic in shape. It arises close to the mesapodema, at the boundary between the parapleurum and the mesosternum, and passes into a strong tendon which follows the episternal border alongside the supinator; apparently united with the tendon of that muscle, it passes to the foramen præalare.

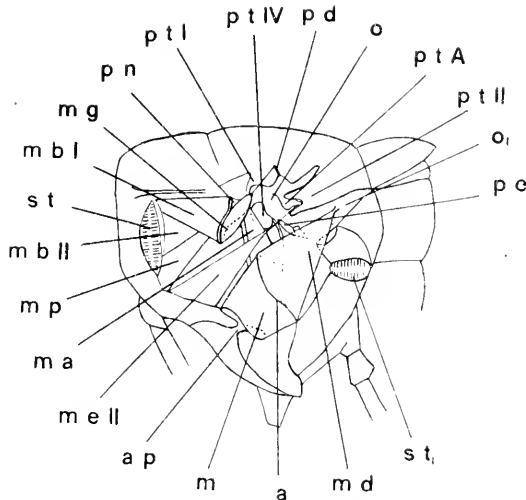

FIG. 6. Diagrammatic view of the direct muscles that lie nearer the median plane. (Median section of the thorax.)

*a*, Mesapodema.

*ap*, Mesapophysis.

*m*, Musculus latus.

*ma*, Musculus anonymus.

*mbI*, Musculus abductor alæ primus.

*mbII*, Musculus abductor alæ secundus.

*meI*, Musculus levator alæ primus.

*meII*, Musculus levator alæ secundus.

*md*, Musculus adductor alæ.

*mc*, Musculus gracilis.

*mp*, Musculus pronator alæ.

*o*, Foramen præalare.

*o<sub>1</sub>*, Foramen postalare.

*pd*, Processus dactyloformis.

*pc*, Pareposternum.

*ptI*, Processus pteralis thoracis I.

*ptII*, Processus pteralis thoracis II.

*ptIV*, Processus pteralis thoracis IV.

*ptA*, Pterale A.

*st*, Stigma anterior.

*st<sub>1</sub>*, Stigma posterior.

There its tendon is joined to the processus duplicatus of pterale A, while the tendon of the supinator alæ passes into the ligamentum anale.

5. *The supinator alæ primus* (text fig. 7, pl. 11, fig. 30, pl. 13, fig. 34; *msI*). This muscle is delta-shaped. It arises from the episternal pouch and passes into a tendon which, as mentioned above, is united with the tendon of the levator secundus. It passes beyond the pterale A, where the levator secundus is inserted, and into the anal ligament.

6. *The supinator alæ secundus* (text fig. 7, pl. 11, fig. 30; *msII*). This muscle is likewise delta-shaped. It arises at the apodema, behind the supinator primus, and is continued in a long tendon which traverses the foramen postalare, and is joined to the liga-

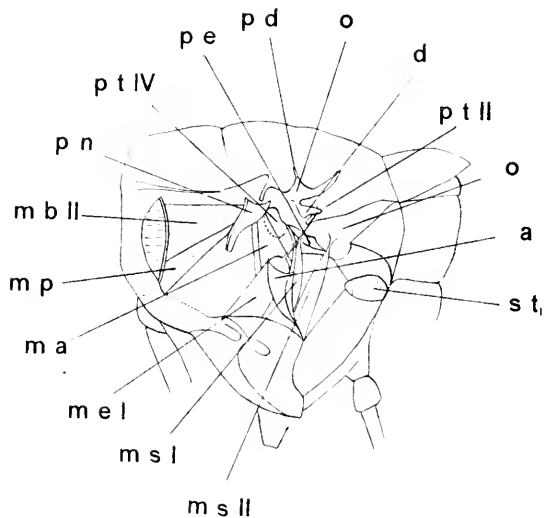

FIG. 7. Diagrammatic view of the direct muscles that lie more laterally. (Median section of the thorax.)

*a*, Mesapodema.

*d*, Processus duplicatus (Pterale A).

*ma*, Musculus anonymus.

*mbII*, Musculus abductor alæ secundus.

*meI*, Musculus levator alæ primus.

*mp*, Musculus pronator alæ.

*msI*, Musculus supinator alæ primus.

*msII*, Musculus supinator alæ secundus.

*o*, Foramen praealare.

*o*<sub>1</sub>, Foramen postalare.

*pd*, Processus dactyloformis.

*pe*, Parepisternum.

*pn*, Parapterum.

*ptII*, Processus pteralis thoracis II.

*ptIV*, Processus pteralis thoracis IV.

*st*, Stigma posterius.

mentum anale near the processus pteralis thoracis VI and the processus alæ 4.

7. *The abductor alæ secundus* (text figs. 6, 7, pl. 11, fig. 30; *mbII*). This is the strongest of the direct muscles. It lies under

the abductor primus, is delta-shaped, arises from the rostral and ventral border of the parapleurum, and is continued in a tendon which extends under the parapterum, traverses the foramen postalare and is inserted on the anterior border of the wing-joint, probably close to the depression of the processus pteralis alæ 3. Lowne's view, that this muscle is attached to the parapterum, is erroneous.

8. *The pronator alæ* (text figs. 6, 7, pl. II, fig. 30; *mp*). This muscle is similar in shape to the abductor secundus, but much more slender. It arises from the ventral border of the parapleurum, passes, together with the abductor secundus, below the parapterum, and is continued into a tendon which passes through the foramen præalare. Its insertion is similar to that of the abductor secundus. The exact spot of attachment could not be determined.

9. *The musculus gracilis* (text fig. 6, pl. II, fig. 34; *mg*). This muscle is small and oval. It arises from the parapterum and is continued in a delicate tendon which is attached to the processus dactyloformis of the scutum.

10. *The musculus anonymus* (text figs. 6, 7, *ma*). As the name implies, I was unable to determine with certainty the points of insertion and the function of this muscle. It covers the episternum, is very delicate and appears to be somewhat rudimentary.

## B. PHYSIOLOGICAL PART

### METHODS OF INVESTIGATION

The experimental study of the movements of the wings is rendered difficult by the small size of the latter and by the complicated nature and rapidity of the former.

Three methods have been employed for investigating the nature of the wing-movement. The oldest of these is the optical method, which has been employed particularly by Pettigrew and by Marey (1886, p. 93). This method is based on making the tip of the wing especially visible by attaching to it a bit of gold leaf and then examining the bright line produced by this glittering point when the insect is held in a beam of strong light and induced to move its wings. The bright line then seen has the shape of the figure 8. Another method is the kymographic, which was likewise employed by Marey. When using this method the insect is held near a revolving blackened cylinder in such a manner that the moving tips of its wings describe points or curves on it. Since the tips of the wings move in spherical surfaces, they either—when the insect is

held far—touch the cylinder only at two points during each beat, or—when it is held closer—produce a curve so blurred that not much can be learned from it. On account of this, Marey's kymographic tracings do not show very much.

The third method is v. Lendenfeld's (1903) photographic method, by means of which series of instantaneous views of flying insects can be obtained (pl. 19, fig. 53).

The above statements show that the problem of applying the kymographic method to the study of insect flight had not been satisfactorily solved. I tried, therefore, to adapt that method better to this end by devising a new kind of flight-kymograph (pl. 14, figs. 35, 36). This consists of a wooden frame 120 cm. long and 20 cm. high. In grooves in the upper and lower parts of the frame there slides a thin board, 50 cm. long. This board can be rapidly shot from one end of the frame to the other by means of a steel spring. To this movable board is attached a horizontal groove, semi-circular in cross-section; the radius of the semi-circle being equal to the average length of a blow-fly's wing. In this groove a strip of glazed, blackened paper is fitted.

A fly in the normal horizontal position is held fast before the groove with the blackened paper so that the root of the wing lies at a point of the axis of the semi-cylindrical surface formed by it. When the fly attempts flight the tip of the wing touches the blackened paper. The stop holding the spring is then withdrawn, the board with its groove and blackened paper slides past the fly and the tip of the insect's wing describes a curve on the latter. Curves procured in this way are shown on plates 16, 17 and 18.

## FLIGHT

If the fly remains at the same place in the air (hovers), as is frequently observed among the Syrphidæ, each tip of the wing describes a figure 8. Although this fact was already known to Pettigrew, the general relations and the special peculiarities of this figure 8 have never been studied in detail. The tracings made with my flight kymograph (see above) show several things that had escaped the attention of Marey. In regard to the inclination of the 8 to the horizon, it was found that the long axis of the 8 is directed from above and behind, downward and forward,<sup>1</sup> and that

<sup>1</sup>The expressions upward, downward, forward, and backward are always used in relation to the body of the fly.



the angle this axis makes with the horizon varies between about 30 and 60 degrees. Also the direction (inclination) of the downstroke varies. The upper observed limit was 90 degrees. The lower loop of the 8 is, as already stated by Lowne (1800-1895, p. 204), considerably larger than the upper loop. I must remark, however, that I have never observed such an inclination of the 8 as Lowne describes, that indeed it would be contradictory to the observations I have made on the mechanism of the wing-beat described below. The direction of the wing-stroke is also incorrectly represented in Lowne's figure; von Lendenfeld's (1881, p. 368) accords better with my observations. As is incontestably shown in my kymographic curves (pl. 16, figs. 42, 43, 44), the movement of the wing whilst describing the lower curve of the 8 is, relative to the insect, a movement forward, and not, as Lowne says, a movement backward. The upper part of the 8, on the other hand, is described by the wing moving backward.

At rest the wings lie back upon the abdomen, projecting about a third of their length beyond it. When the insect wishes to fly it moves the wings (wing tips) somewhat forward,<sup>1</sup> and at the same time raises them. Then it makes a little jump and commences to describe the figure 8 with the wing tips. Both wings are expanded nearly horizontally and moved simultaneously almost vertically downward so that they press downward upon the air with their entire surface. The unsupported anal portion of the wing remains somewhat behind, because it cannot overcome the resistance of the air so easily as the strongly supported anterior portion. That the wings are held nearly horizontally during the downstroke (it being understood that the insect is flying horizontally) is clearly shown by the kymographic figures (pl. 15, fig. 41; pl. 16, figs. 42, 43, 44), particularly in the curves made by a wing, the tip of which had been nipped off. These curves are not described by a point (the tip of the wing), but by a line (the transverse section of the wing along which the tip had been cut off). During the downstroke this line described a broad band, or, since only the veins leave a distinct mark, two parallel lines corresponding to the only two veins, *Iaa* and *IIIba*, which extend so far toward the tip. Arrived below, the wing glides horizontally forward and then turns, the marginal vein being in front, upward and backward. In this phase the torsion of the wing is at its minimum. The anal border follows the path of

<sup>1</sup> See the chapter on the function of the muscles.

the marginal vein, so that in the kymographic figures (pl. 15, fig. 41; pl. 16, figs. 42, 43, 44) only a single tracing is visible. Arrived above the wing glides somewhat forward, not nearly so much, however as in the lower position, and with the marginal vein in front begins anew a downward stroke.

*The modus operandi* of this movement may be interpreted as follows: The downward movement is executed with great force while the surface of the wing lies nearly horizontal, only the anal marginal portion being bent slightly upward. The direction of this movement is nearly vertically downward, or downward and somewhat forward. There can be no doubt that the relief of the wing surface, the longitudinal folds and the hair increase the working pressure during the downstroke. The fly thus obtains during the downstroke a strong impulse upward, which overcomes its weight.

The great breadth of the lower loop of the 8 (pl. 15, fig. 41; pl. 16, figs. 42, 43, 44, 45; pl. 18, figs. 50, 51) shows that the wing moves upward much slower than downward. During this rather slow upstroke the wings become—if, as is usual, the insect flies forward—gliding surfaces, the fly glides forward, the slightest impulse to forward movement being sufficient to make the force of gravity effective for translation. At the same time the fly, of course, also slightly descends.

During the backward movement above mentioned the wing opposes only very little resistance to the air, but still enough to produce the necessary forward impulse. During this phase, also, there is descent. The upper horizontal movement backward is short in comparison with the lower forward one, and is in the main to be considered as the turning and adjustment necessary to make the wing ready for the next downstroke.

The rapidity of the forward progression chiefly depends on the angle of the long axis of the 8 with the horizon, and the insect flies fastest when the downstroke approaches a vertical direction. It can also be said that the progression is the slower the narrower the lower loop of the 8 becomes; and if it once becomes as narrow as the upper loop the beat of the wing will merely overcome the force of gravity and the insect will hover at the same spot, as the Syrphidæ so often do.

#### THE FUNCTION OF THE MUSCLES AND THE JOINTS

The downward movement of the wing is caused by the contraction of the two powerful indirect dorsal muscles. Jurine (1820, p. 95)

describes an experiment proving this, which I have repeated in the following manner: From a recently killed fly whose wings are raised, the abdomen and head are removed and the thorax grasped in a broad forceps so that one of the points of the forceps is at its anterior, the other at its posterior end. On compressing the forceps the thorax is shortened just as it is when the dorsal muscle contracts. Thus the forceps' pressure imitates the action of the muscle, and a very slight pressure suffices to cause the wings to descend. The high development of the dorsal muscles readily explains the great force of the downward stroke of the wing.

That a contraction of the dorsal muscles must lead to a downward movement of the wings follows from a consideration of the anatomy of the skeleton. As the convexity of the back is increased by the contraction of these muscles, the *processus præalaris* (pl. 2, figs. 3, 4, *ptI*), as well as the *processus postalaris* (same figs., *ptII*), will be raised. By means of the *processus postalaris* the *processus duplicatus* of pterale A (pl. 3, fig. 8; pl. 4, fig. 9; *du*) is also raised, and the distal processes (*processus rostralis* and *analis*), acting as levers, correspondingly depressed. These processes then press the wings downward.

The dorso-ventral muscles act as antagonists to the dorsal. They compress the thorax in a vertical direction and accordingly act as raisers of the wings.

The function of the direct muscles was determined as far as possible under the binocular by pulling them with a fine forceps in the direction of their length. In this way the function of most of them could be made out quite clearly.

The adductor *alkæ* (pl. 13, fig. 33, *md*) draws the wing backward toward the body. It serves to bring the wing back from the position of flight to that of rest.

The two abductors (pl. 11, fig. 30, *mbII*; pl. 13, fig. 33, *mbI*) draw the wing horizontally forward. One of these two muscles draws the wing when depressed and causes its forward movement during and after the downstroke.

The two levators (pl. 11, fig. 30; pl. 13, fig. 34, *meI*, *meII*) raise the wing, and at the same time draw it somewhat backward. Their action has a similar effect to that of the dorso-ventral muscles. They are inserted on the *processus duplicatus* of pterale A, and by their contraction depress that process and thus cause the wing to rise.

The two supinators depress the anal portion of the wing, and the pronator depresses its anterior border. By the action of these

muscles the torsion of the wing surface is produced and its degree changed as required. Apparently, in consequence of the action of the pronator, the torsion is increased during the downstroke.

The functions of the *musculus anonymus* and the *musculus gracilis* could not be ascertained.

Like von Lendenfeld (1884, opposed to Marey, 1886), I am of the opinion that the action of the direct musculature of the insect and not the resistance of the air chiefly causes the complicated changes in the shape and degree of torsion of the wings during their movement. The direct musculature serves also for steering. In several cases two muscles appear to perform nearly the same function. In these cases we may suppose that one of the two similar muscles is used in flight straight ahead, the second for steering. If the fly wishes to turn to the right or to the left it can, by means of the adductor, throw one wing back and by means of the abductor direct the other forward, and so turn the side of the contracted adductor.

A few additional remarks should be made about the wing-joint.

Doubtless an important condition for good flight is absence of jerks and an elastic, unhindered, smooth movement of the wing. Independent of the elasticity of the materials, peculiar devices especially adapted for this purpose, make sure of the movement being of this kind. The *processus pteralis thoracis IV*, designated *stroma* (pl. 9, fig. 26, *ptIV*), which is a process of the episternum, occupies the axillary cavity of the wing, and is so situated that it comes to lie under the terminal portion of the *remigium*, the *processus pteralis alæ 3* (pl. 9, fig. 26, *pt3*), during the downstroke. This piece, acting like an elastic cushion, probably mitigates the shock which might otherwise occur at the end of every downstroke.

The *pterale C* (pl. 9, fig. 26, *ptC*), that resembles an articular ball, and that fits into the socket of the *processus pteralis alæ 3*, may serve a similar purpose. It is to be mentioned concerning this that the *pterale C* is actually in the socket of *processus pterale alæ 3* only when the wing is depressed. When the wing is raised, that ball and this socket are far apart. *Pterale C* may, therefore, also be considered as a sort of elastic buffer, serving to mitigate the shocks that might otherwise ensue at the ends of the wing-strokes.

The flexible zone also is a device serving this purpose. The broad wing of *Calliphora vomitoria* may, in view of the rapidity of the wing-beat, not be sufficiently elastic to permit an equable, unhindered movement. The hovering flies, whose wings are long and narrow,

and whose wing-veins are very delicate, have no devices of this kind to prevent jerks during flight. At every rapid change in the direction or velocity of the wing-movement considerable stresses must be produced, particularly in its basal part. The ill effects which these might otherwise have are avoided by the flexibility and elasticity of the wing which bends more or less at every stroke. If, as in the Syrphidæ, the wings are narrow and long, and the elasticity of the veins is sufficient to permit such bending, there is no special flexible zone. If, on the other hand, as in the blow-fly, the wing is short and broad and the veins are hard and inelastic, a special flexible zone is developed (pl. 6, figs. 18, 19, *si*). This view is supported by the serial instantaneous photographs made by von Lendenfeld (pl. 19, fig. 53), which show that just after the down-stroke the distal portion of the wing is markedly bent.

It was not possible to ascertain the function of the curiously shaped processus pteralis thoracis V. Apparently this process can be interposed like a stop between pterale C and the socket of processus pterale alæ 3, and so hinder the buffer action of pterale C.

The processus pterale thoracis III as well as the processus pteralis thoracis I are articular connections. Parts of them are poor in chitin and therefore flexible, and they are firmly attached to the parts of the skeleton to which they belong.

I consider pterale B as a piece that serves to strengthen the joint. Like a clasp it aids in holding the upper and lower portion of the joint together.

The numerous small folds in the anal portion of the wing, already mentioned in the anatomical part of this paper, may serve to strengthen this region, which is but little supported by veins. This part of the wing is comparable to a Japanese paper fan, in which firmness is attained by radial folding.

#### IV. SYNOPSIS OF RESULTS

1. The constituents of the wing-joint can be divided into three morphological groups, quite distinct from each other:

1. The processus pterales thoracis.
2. The pteralia.
3. The processus pterales alæ.

2. The wing-joint is an exoskeletal structure, and therefore fundamentally different from the articular structures of vertebrate animals.

3. This difference is chiefly due to the fact that in insects the flexibility of the material permits some relative movement of differ-

ent parts of the same piece of chitin. The strong chitinous portions of the insect's joint continuously pass into thinner chitinous parts, which unite them with each other, while in vertebrates the different skeletal pieces are isolated and held together by muscles and tendinous structures only. The joints of insects have no capsules like those of vertebrates.

4. Similarities between the articulations of insects and vertebrates can, therefore, never be true homologies.

5. The complicated parts of the joint serve definite ends.

6. The pterale A raises and lowers the wing, working like a single-armed lever.

7. The pterale B strengthens the joint in a vertical direction.

8. The pterale C prevents or softens, like a buffer, the shocks at the end of each downstroke.

9. The processus pterale thoracis IV, the so-called stroma, has a similar function. It also contributes to softening the shocks or jerks of the wing-movement, particularly at the end of the up- and downstrokes.

10. There is in the wing a device, the flexible zone, which prevents the insufficient elasticity of the organ from being injurious.

11. The flexible zone renders possible a free, pendular vibration of the middle and distal parts of the wing at each reversal of the movement.

12. While the indirect muscles produce the elevation and depression of the wings, the direct muscles change the shape and position of the wings themselves, and the course they travel during each beat.

13. The direct muscles are probably also the steerers.

14. The downstroke of the wing is forward relative to the insect, and directed, in ordinary forward flight, downward and forward also relative to the surrounding air. It produces an elevation of the insect's body, which overcomes gravity but retards the forward movement.

15. During the horizontal movement of the wings, when depressed forward and also during the upstroke, the wings act as gliders, counteract gravity and retard horizontal advance, or vice versa. The fly descending glides forward, or ascending loses its horizontal velocity.

16. The torsion of the wing attains its maximum at the end of the downstroke, because its anal portion lags behind the anterior

part during the downstroke in consequence of its flexibility and the resistance of the air.

17. Toward the end of the upstroke the torsion is at its minimum.

18. The folds of the surface and the hairiness of the wing affect and probably heighten its mechanical effect on the air.

19. The numerous small folds of the anal portion of the wing, which is poor in veins, serve to strengthen it.

## V. LITERATURE

ADOLPH, G. E.

1885. Die Dipterenflügel, ihr Schema und ihre Ableitung. Acta Ac.  
Leopoldina, Vol. 47, pp. 271-305, pls. 24-26.

AMANS, P.

1883. Essai sur le vol des insectes. Rev. Montpellier, Vol. 3, pp. 121-139,  
pls. 3, 4.

AUDOUIN, V.

1824. Recherches anatomiques sur le thorax des animaux articulés et  
celui des insectes hexapodes en particulier. Ann. sci. nat. Paris,  
Ser. 1, Vol. 1, pp. 97-135, 416-432.

BURMEISTER, H.

1832. Handbuch der Entomologie, Berlin. Allgemeine Entomologie, Vol. 1.

CHABRIER, J.

1822. Essai sur le vol des insectes et observations sur quelques parties de  
la mécanique des mouvements progressives de l'homme et des  
animaux vertébrés. Paris, 328 pp., 18 pls.

HAMMOND, A. R.

1879. On the Thorax of the Blow-Fly (*Musca vomitoria*). Journ. Linn.  
Soc. London, Zoology, Vol. 15, pp. 9-31, pls. 1, 2.

JURINE, L.

1820. Observations sur les ailes des Hyménoptères. Mem. Accad. Torine,  
Vol. 24 (sc. fis.), pp. 172-240, 6 pls.

KIRBY, W., AND SPENCER, W.

- 1823-1833. An Introduction to Entomology or Elements of the natural  
history of insects, 4 Vols., London.

KLENKER, F.

1883. Ueber endoskelettale Bildungen bei Insekten. Göttingen, 53 pp.

KOLBE, H.

1893. Einführung in die Kenntnis der Insekten. Berlin.

KÜNCKEL D'HERCULAIS, J.

1875. Recherches sur l'organisation et le développement des Volucelles,  
insectes diptères de la famille des Syrphides. Part I, Paris, 208  
pp., pls. 1-11.

1877. Considerations sur le mécanisme du vol chez les insectes lépidoptères  
et hyménoptères. C. R. Soc. Biol. Paris, Ser. 6, Vol. 3, pp. 70-71.

1881. Recherches sur l'organisation et le développement des Diptères et  
en particulier des Volucelles de la Famille des Syrphides. Part II,  
Paris, 1881, pls. 12-26.

LATREILLE, P. A.

1819. De la formation des ailes des insectes et de l'organisation extérieure  
de ces animaux, comparée, en divers points avec celles des  
Arachnides et des Crustacés. Mém. divers sujets histoire nat.  
Insectes, Paris, 44 pp.



## LENDENFELD, R. v.

1881. Der Flug der Libellen. Sitz. Ber. Akad. Wien, Math. nat. Kl., Vol. 83, pp. 298-376, pls. 1-7.  
1885. Notes on the flight of insects. Proc. Linn. Soc. New South Wales, Vol. 9, pp. 986, 987.  
1885. On flight. Proc. Linn. Soc. New South Wales, Vol. 10, pp. 73-75.  
1891. Notiz über die Muskulatur der Halteren. Zool. Anz., Vol. 14, p. 63.  
1903. Beitrag zum Studium des Fluges der Insekten mit Hilfe der Momentphotographie. Biol. Centr., Vol. 23, pp. 227-232, 1 pl.

## LOWNE, B. T.

- 1890-95. The Anatomy, Physiology, Morphology and Development of the Blow-Fly (*Calliphora erythrocephala*). A study in the comparative Anatomy and Morphology of Insects, London, 2 Vols., 350 pp., 21 pls., and 428 pp., 32 pls.

## LUKS, C.

1883. Ueber die Brustmuskulatur der Insekten. Jena. Zeitschr., Vol. 16, pp. 529-552, pls. 22, 23.

## MAREY, E. J.

1869. Mémoire sur le vol des insectes et des oiseaux. Ann. sci. nat. Paris, Ser. 5, Vol. 12, pp. 49-150.  
1869a. Recherches sur la mécanique du vol des insectes. Journ. Anat. Physiol., Vol. 6, pp. 19-36, 337-348.  
1872. Second Mémoire sur le vol des insectes et des oiseaux. Ann. sci. nat. Paris, Ser. 5, Zool., Vol. 15, art. 13.

## PETTIGREW, J. B.

1872. On the Physiology of Wings, being an analysis of the movement by which flight is produced in the insect, bat and bird. Trans. Roy. Soc. Edinburgh, 1871, Vol. 26, pp. 321-448.  
1873. Animal locomotion; or walking, swimming, and flying. With a dissertation on aeronautics. London.

## REDTENBACHER, J.

1886. Vergleichende Studien über das Flügelgeäder der Insekten. Ann. Hofmus, Wien, Vol. 1, p. 153-231, pl. 9-20.

## STRAUSS-DÜRKHEIM, H. E.

1828. Considerations générales sur l'anatomie comparée des animaux articulés, auxquelles on a joint l'anatomie descriptive du *Melolontha vulgaris* (hanneton), donnée comme un exemple de l'organisation des Coléoptères. Paris, 19 pl.

## VOSS, FR.

1905. Ueber den Thorax von *Gryllus domesticus*, mit besonderer Berücksichtigung des Flügelgelenks und dessen Bewegung. (Ein Beitrag zur Vergleichung der Anatomie und des Mechanismus des Insektenleibes, insbesondere des Flügels.) I-IV. Zeitschr. wiss. Zool., Vol. 78, pp. 268-354, 355-521, 697-759, 2 pl., 23 f.

## WALTER, L.

1907. On the Clasping Organs Attaching the Hind to the Fore Wings in Hymenoptera. Smithsonian Miscell. Coll., Vol. 50, pp. 65-87, 4 pl.

## PLATE I

FIG. 1. Stereoscopic view of the dorsal portion of the thorax from without. (Magnified 10 diameters. Photographed with Zeiss binocular; Objective 55, Ocular 3.)

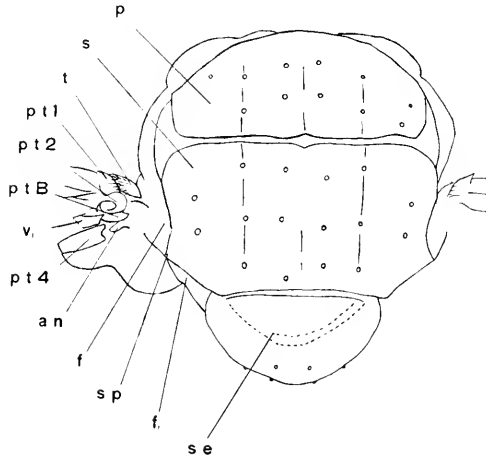

- |  |                             |
|--|-----------------------------|
| <i>an</i> , Processus analis of pterale A. | <i>ptB</i> , Pterale B.     |
| <i>f</i> , Fossa præalaris.                | <i>s</i> , Scutum.          |
| <i>f<sub>1</sub></i> , Fossa postalaris.   | <i>se</i> , Scutellum.      |
| <i>p</i> , Præscutum.                      | <i>sp</i> , Spina scutalis. |
| <i>pt1</i> , Processus pteralis alæ 1.     | <i>t</i> , Tegula.          |
| <i>pt2</i> , Processus pteralis alæ 2.     | <i>v</i> , Stay.            |
| <i>pt4</i> , Processus pteralis alæ 4.     |                             |

FIG. 2. Stereoscopic view of the ventral side of the thorax from within. (Magnified 10 diameters. Photographed with Zeiss binocular; Objective 55, Ocular 3.)

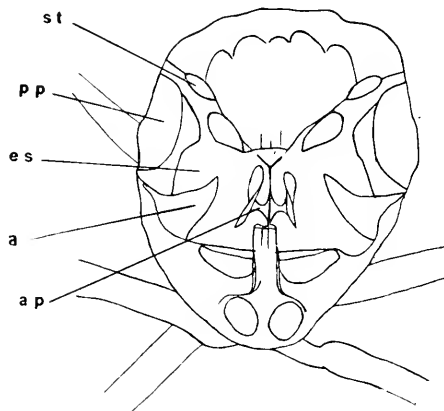

- |                           |                              |
|---------------------------|------------------------------|
| <i>a</i> , Mesapodema.    | <i>pp</i> , Parapleurum.     |
| <i>ap</i> , Mesapophysis. | <i>st</i> , Stigma anterior. |
| <i>es</i> , Mesosternum.  |                              |

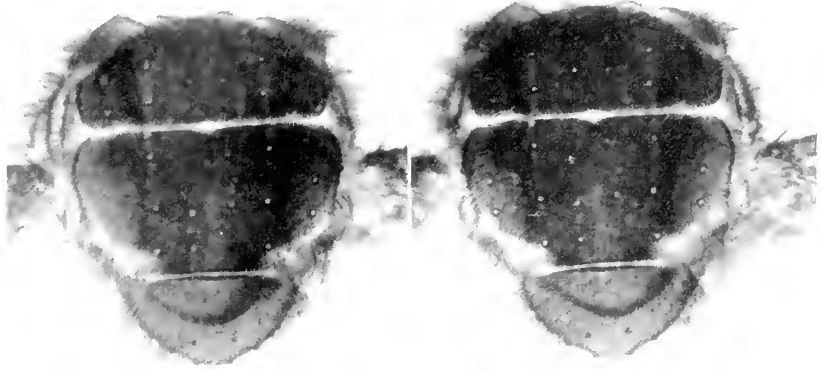

1

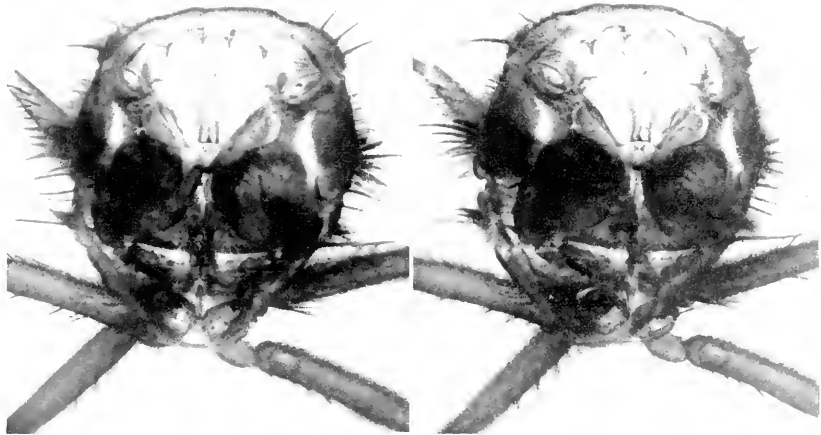

2

THORAX OF THE BLOW-FLY





## PLATE 2

FIG. 3. Stereoscopic view of the lateral wall of the thorax from without. (Magnified 10 diameters. Photographed with Zeiss binocular; Objective 55, Ocular 3.)

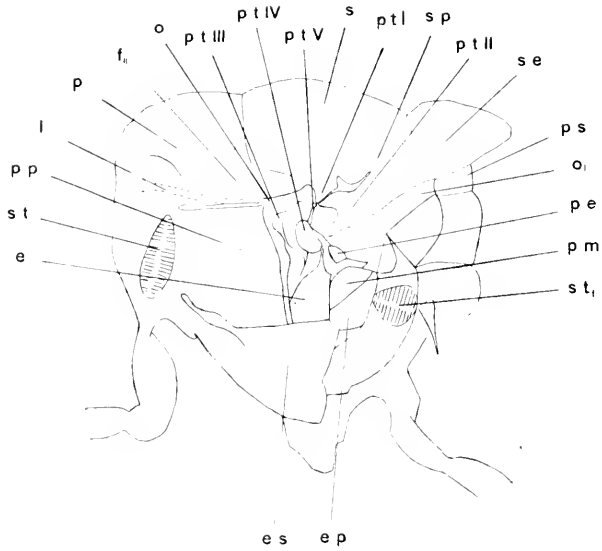

*c*, Episternum.

*cp*, Epimerum.

*cs*, Mesosternum.

*fa*, Fossa anterior.

*l*, Præscutal border.

*o*, Foramen præalare.

*oi*, Foramen postalare.

*p*, Præscutum.

*pe*, Parepisternum.

*pm*, Parepimerum.

*pp*, Parapleurum.

*ps*, Postscutellum.

*ptI*, Processus pteralis thoracis I.

*ptII*, Processus pteralis thoracis II.

*ptIII*, Processus pteralis thoracis III.

*ptIV*, Processus pteralis thoracis IV.

*ptV*, Processus pteralis thoracis V.

*s*, Scutum.

*sc*, Scutellum.

*sp*, Spina scutalis.

*st*, Stigma anterius.

*sti*, Stigma posterius.

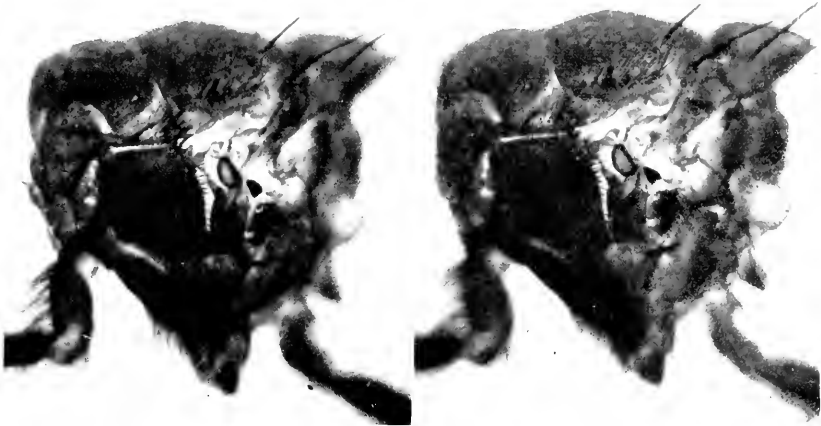

3



4

LATERAL WALL OF THORAX OF BLOW-FLY





## PLATE 2 (Continued)

FIG. 4. Stereoscopic view of the lateral wall of the thorax from within. (Magnified 10 diameters. Photographed with Zeiss binocular; Objective 55. Ocular, 3.)

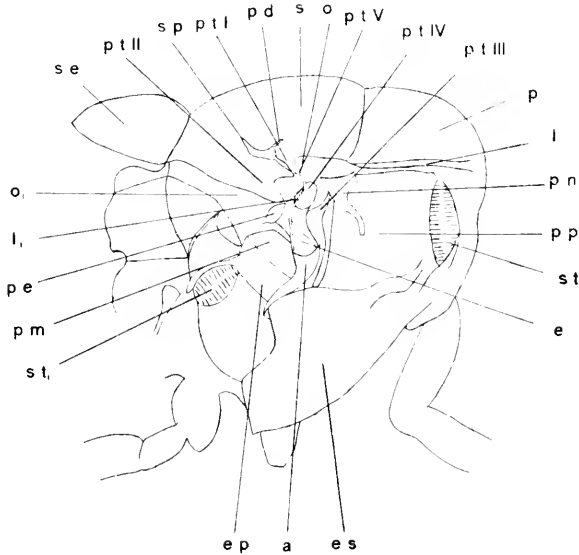

*a*, Mesapodema.

*e*, Episternum.

*ep*, Epimerum.

*es*, Mesosternum.

*l*, Præscutal border.

*li*, Episternal border.

*o*, Foramen præalare.

*oi*, Foramen postalare.

*p*, Præscutum.

*pd*, Processus dactyloformis.

*pe*, Parepisternum.

*pm*, Parepimerum.

*pn*, Parapterum.

*pp*, Parapleurum.

*ptI*, Processus pteralis thoracis I.

*ptII*, Processus pteralis thoracis II.

*ptIII*, Processus pteralis thoracis III.

*ptIV*, Processus pteralis thoracis IV.

*ptV*, Processus pteralis thoracis V.

*s*, Scutum.

*se*, Scutellum.

*sp*, Spina scutalis.

*st*, Stigma anterior.

*st,* Stigma posterior.

## PLATE 3

FIG. 5. Right wing viewed from above. Mounted in Canada balsam. (Magnified 10 diameters. Photographed with Zeiss planar 50 mm.)

FIG. 6. Right wing viewed from below. Mounted in Canada balsam. (Magnified 10 diameters. Photographed with Zeiss planar 50 mm.)

FIG. 7. Pterale B. (Magnified 45 diameters. Photographed with Zeiss achromat A, Ocular 2.)

*dc*, Processus dentales.      *x*, Processus proximalis.

FIG. 8. Pterale A. (Magnified 45 diameters. Photographed with Zeiss achromat A, Ocular 2.)

*an*, Processus analis.      *ro*, Processus rostralis.  
*du*, Processus duplicatus.



5

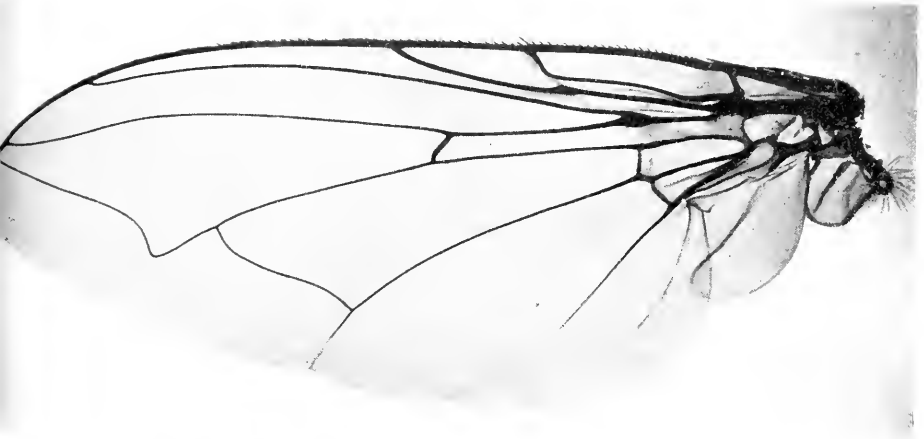

6



7



8

RIGHT WING AND PTERALE OF BLOW-FLY





## PLATE 4A

FIG. 9. Pterale A. (Magnified 80 diameters. Photographed with Zeiss achromat A, Ocular 4.)

*an*, Processus analis.                      *ro*, Processus rostralis.  
*du*, Processus duplicatus.

FIG. 10. Cross-section of the Mesothorax. (Magnified 10 diameters. Photographed with Zeiss achromat A, Ocular 2.)

*dvII*, Musculus dorso-ventralis secundus.  
*mm*, Musculus dorsalis.

FIG. 11. Processus pteralis thoracis V. (Magnified 45 diameters. Photographed with Zeiss achromat A, Ocular 2.)



11

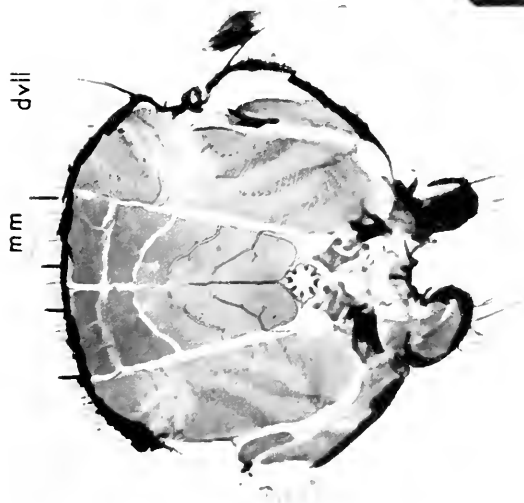

mm  
dvl

ro

du

10

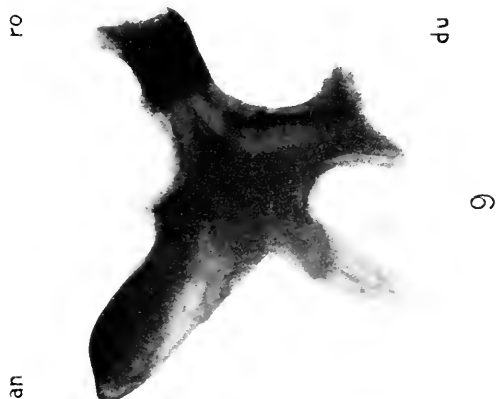

an

9

FLYING APPARATUS OF BLOW-FLY







## PLATE 4B

FIG. 12. Cross-section of the wing. (Magnified 30 diameters. Photographed with Zeiss achromat A.)

*gi*, Marginal vein.

*Iba*, Crest of first raised (convex) fold of the anterior region.

*Iaa*, Second depressed (concave) fold of the anterior region.

*IIIba*, Crest of third raised (convex) fold of the anterior region.

*Iam*, First depressed (concave) fold of the middle region, discoidal vein.

*IIm*, Crest of second raised (convex) fold of the middle region.

*Iiap*, Second depressed (concave) fold of the posterior region, anal vein.

FIG. 13. Part of a cross-section of the wing. (Magnified 100 diameters. Photographed with Zeiss achromat A, Ocular 6.)

FIG. 14. Cross-section of the wing. (Magnified 30 diameters. Photographed with Zeiss achromat A.)

*gi*, Marginal vein.

*Iaa*, Second depressed (concave) fold of the anterior region.

*IIIba*, Crest of third raised (convex) fold of the anterior region.

*Iam*, First depressed (concave) fold of the middle region, discoidal vein.

*Iiap*, Second depressed (concave) fold of the posterior region, anal vein.

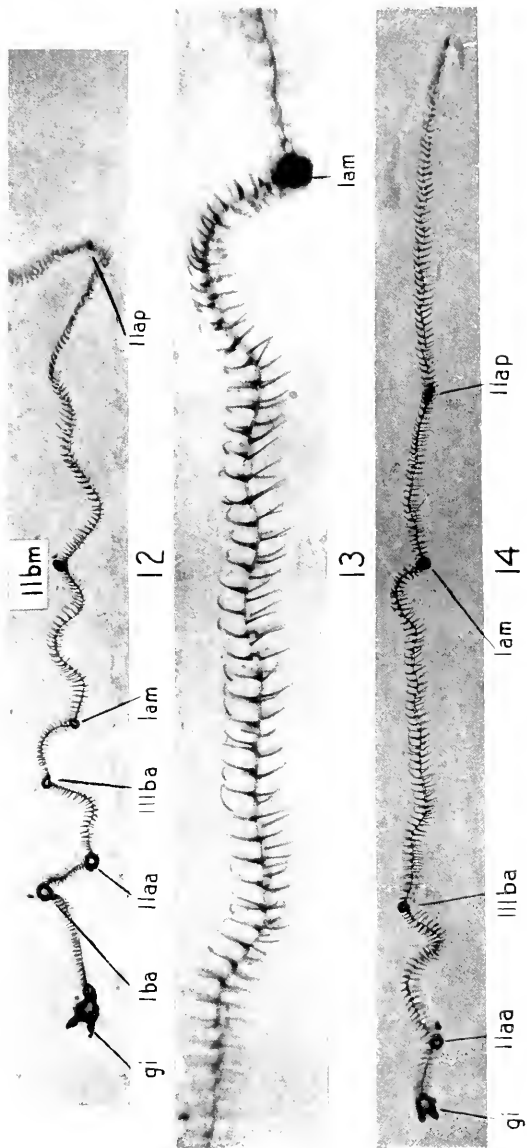

CROSS-SECTIONS OF WING OF BLOW-FLY





## PLATE 5

FIG. 15. Stereoscopic view of the right wing from above. (Dry preparation. Magnified 4 diameters. Photographed with Zeiss binocular; Objective 55. Ocular 1.)

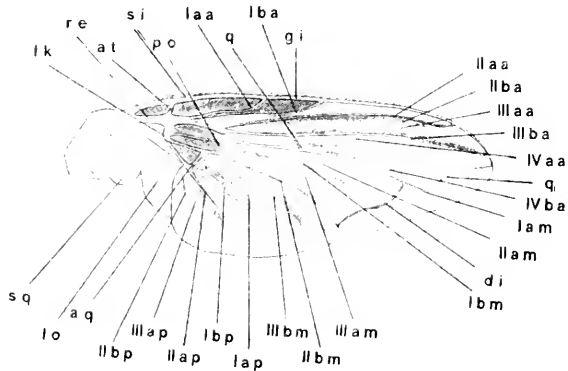

Longitudinal folds (longitudinal veins) :

*gi*, Anterior margin, marginal vein.

*laa*, First depressed (concave) fold of the anterior region, auxiliary vein.

*lba*, First raised (convex) fold of the anterior region, subcostal vein.

*llaa*, Second depressed (concave) fold of the anterior region, radial vein.

*llba*, Second raised (convex) fold of the anterior region.

*lliaa*, Third depressed (concave) fold of the anterior region.

*lliba*, Third raised (convex) fold of the anterior region, ulnar vein.

*llvaa*, Fourth depressed (concave) fold of the anterior region.

*llvba*, Fourth raised (convex) fold of the anterior region, spuria.

*llam*, First depressed (concave) fold of the middle region, discoidal vein.

*llbm*, First raised (convex) fold of the middle region.

*llam*, Second depressed (concave) fold of the middle region, division vein.

*llbm*, Second raised (convex) fold of the middle region, submedian vein.

*lliam*, Third depressed (concave) fold of the middle region.

*llibm*, Third raised (convex) fold of the middle region.

*llap*, First depressed (concave) fold of the posterior region, anonyma.

*llbp*, First raised (convex) fold of the posterior region.

*llap*, Second depressed (concave) fold of the posterior region, anal vein.

*llbp*, Second raised (convex) fold of the posterior region, axillary vein.

*lliap*, Third depressed (concave) fold of the posterior region.

Other parts :

*aq*, Transverse anal vein.

*at*, Anterior transverse vein.

*di*, Discoidal transverse vein.

*fk*, Knee of the wing.

*lo*, Lobulus.

*po*, Posterior transverse vein.

*q*, Median transverse vein.

*qi*, Medio-marginal transverse vein.

*re*, Remigium.

*si*, Notch of the marginal vein in the flexible zone.

*sq*, Squamula.



15

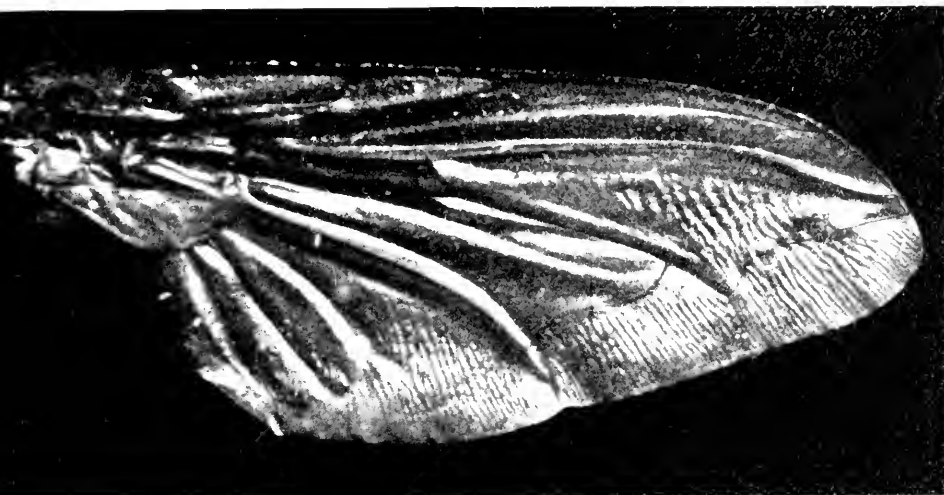

16



17

RIGHT WING OF BLOW-FLY

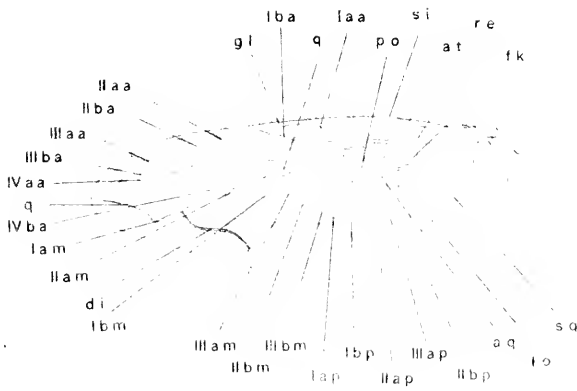



PLATE 5 (Continued)

FIG. 16. Right wing from above. (Magnified 10 diameters. Photographed with Zeiss planar 50 mm.)

FIG. 17. Stereoscopic view of the right wing from below. (Dry preparation.) The enlargement and the designations are the same as in Fig. 15.



## PLATE 6

FIG. 18. Flexible zone. (Magnified 35 diameters. Photographed with Zeiss apochromat 16.)

*gi*, Marginal vein.

*si*, Notch.

*Iaa*, First depressed (concave) fold of the anterior region; auxiliary vein.

*Iba*, Crest of first raised (convex) fold of the anterior region.

*IIaa*, Second depressed (concave) fold of the anterior region.

*IIIba*, Crest of third raised (convex) fold of the anterior region.

*Iam*, First depressed (concave) fold of the middle region; discoidal vein.

*IIm*, Crest of second raised (convex) fold of the middle region.

*IIap*, Second depressed (concave) fold of the posterior region; anal vein.

FIG. 19. Anterior portion of the flexible zone. (Magnified 120 diameters. Photographed with Zeiss apochromat 16, Ocular 6.)

*Iaa*, Auxiliary vein.    *gi*, Marginal vein.    *si*, Notch.

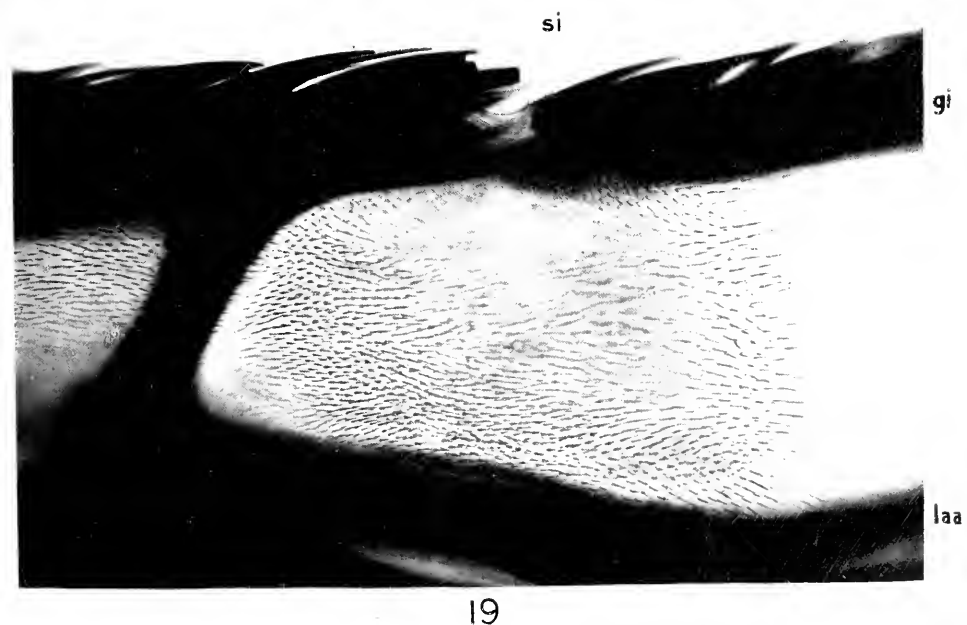
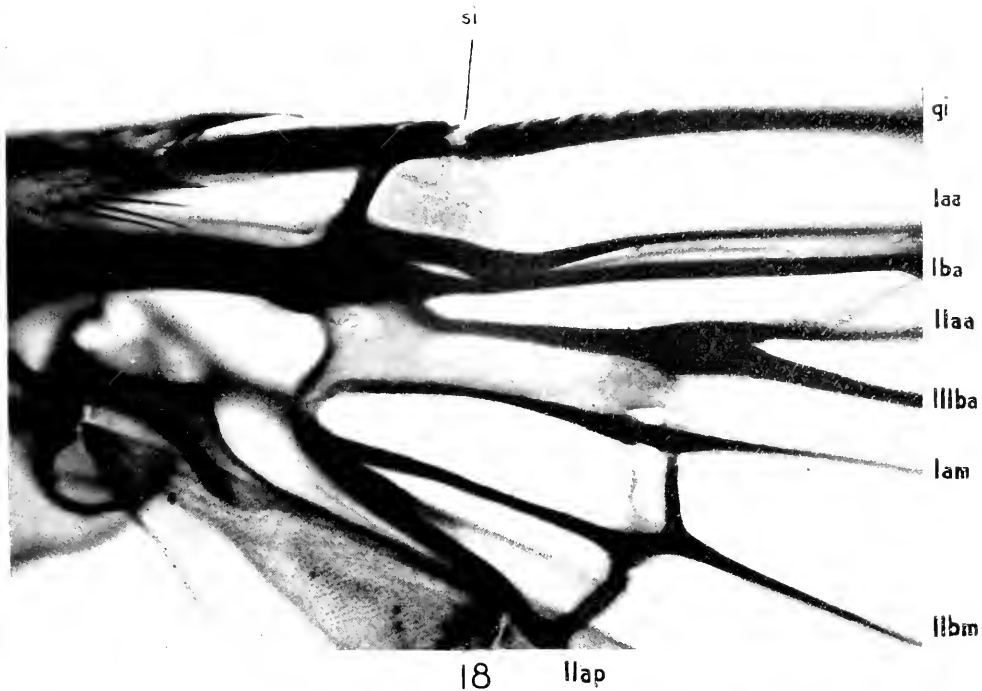

FLEXIBLE ZONE IN WING OF BLOW-FLY





## PLATE 7

FIG. 20. The union of *Haa* and *IIIba* in the flexible zone. (Magnified 350 diameters. Photographed with Zeiss achromat E. Ocular 2.)

FIG. 21. The union of *Haa* and *IIIba* in the flexible zone. (Magnified 200 diameters. Photographed with Zeiss achromat E. Ocular 2.)

FIG. 22. The union of *Haa* and *IIIba* in the flexible zone. (Magnified 100 diameters. Photographed with Zeiss apochromat 16, Ocular 6.)

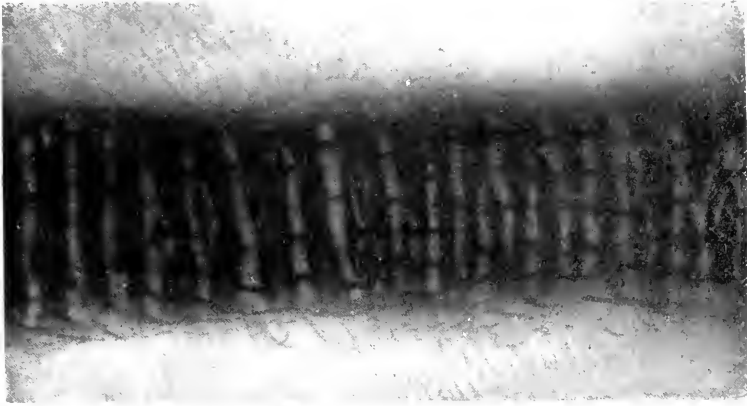

20

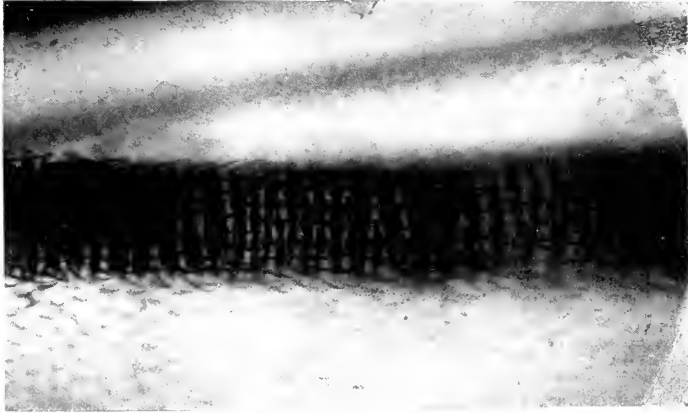

21

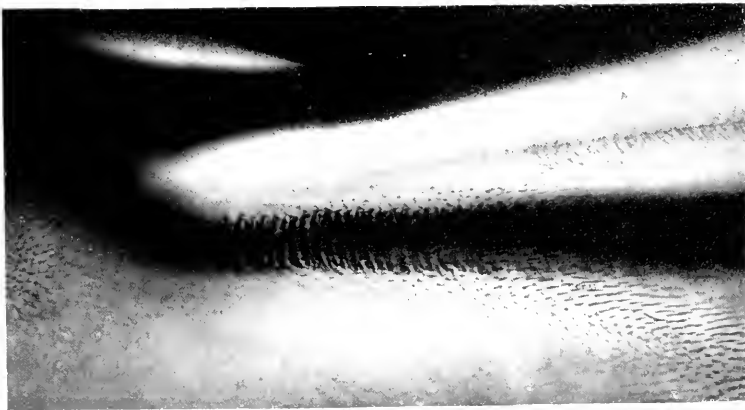

22

FLEXIBLE ZONE IN WING OF BLOW-FLY







## PLATE 8

FIG. 23. Stereoscopic view of the side of the Thorax together with the wing-joint. (Magnified 10 diameters. Photographed with Zeiss binocular; Objective 55, Ocular 3.)

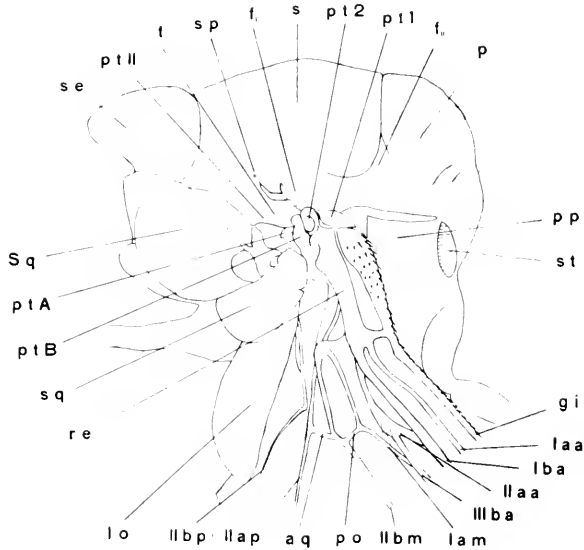

*aq*, Transverse anal vein.

*f*, Fossa postalaris.

*f<sub>i</sub>*, Fossa præalaris.

*f<sub>a</sub>*, Fossa anterior.

*gi*, Marginal vein.

*lo*, Lobulus.

*p*, Præscutum.

*po*, Posterior transverse vein.

*pp*, Parapleurum.

*ptI*, Processus pteralis alæ 1.

*pt2*, Processus pteralis alæ 2.

*ptII*, Processus pteralis thoracis II.

*ptA*, Pterale A.

*ptB*, Pterale B.

*re*, Remigium.

*s*, Scutum.

*sc*, Scutellum.

*sp*, Spina scutalis.

*sq*, Squamula.

*Sq*, Squama.

*st*, Stigma anterius.

*Iaa*, First depressed (concave) fold of the anterior region; auxiliary vein.

*Iba*, Crest of first raised (convex) fold of the anterior region.

*IIaa*, Second depressed (concave) fold of the anterior region.

*IIIba*, Crest of third raised (convex) fold of the anterior region.

*Iam*, First depressed (concave) fold of the middle region; discoidal vein.

*IIbm*, Crest of second raised (convex) fold of the middle region.

*IIap*, Second depressed (concave) fold of the posterior region; anal vein.

*IIbp*, Crest of second raised (convex) fold of the posterior region.



23

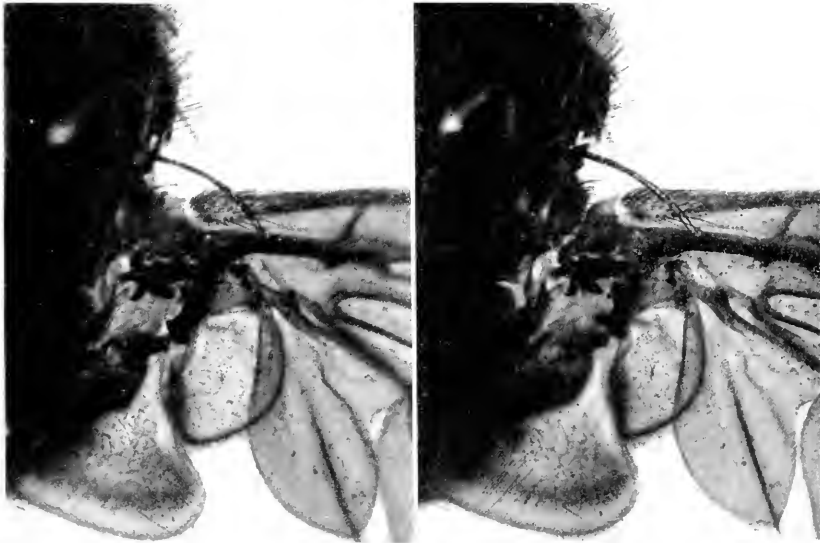

24

THORAX AND WING-JOINT OF BLOW-FLY



## PLATE 8 (Continued)

FIG. 24. Stereoscopic view of the right wing-joint from above. (Magnified 20 diameters. Photographed with Zeiss binocular; Objective 25, Ocular 3.)

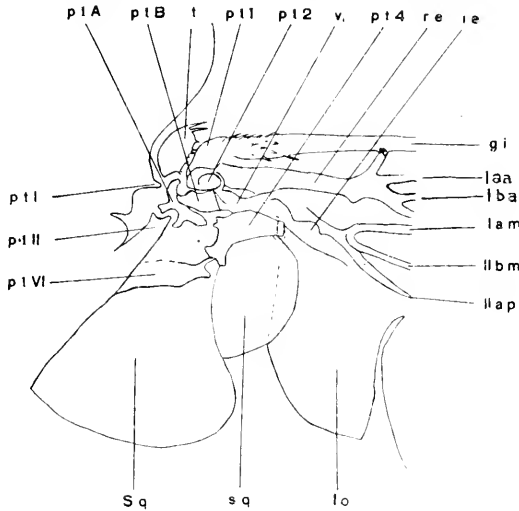

*gi*, Marginal vein.

*ie*, Vein of the inner margin of the lobulus.

*lo*, Lobulus.

*ptI*, Processus pteralis alæ 1.

*pt2*, Processus pteralis alæ 2.

*pt4*, Processus pteralis alæ 4.

*ptI*, Processus pteralis thoracis I.

*ptII*, Processus pteralis thoracis II.

*ptVI*, Processus pteralis thoracis VI.

*ptA*, Pterale A.

*ptB*, Pterale B.

*re*, Remigium.

*sq*, Squamula.

*Sq*, Squama.

*t*, Tegula.

*v*, Stay.

*laa*, First depressed (concave) fold of the anterior region, auxiliary vein.

*lba*, Crest of first raised (convex) fold of the anterior region.

*lam*, First depressed (concave) fold of the middle region, discoidal vein.

*llbm*, Crest of second raised (convex) fold of the middle region.

*llap*, Second depressed (concave) fold of the posterior region, anal vein.

## PLATE 9

FIG. 25. Stereoscopic view of the right wing-joint from above. (Magnified 40 diameters. Photographed with Zeiss binocular; Objective a<sub>2</sub>, Ocular 3.)

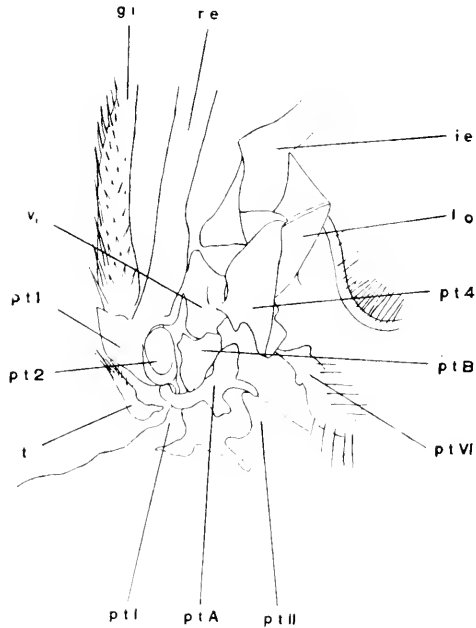

*gi*, Marginal vein.

*ie*, Vein of the inner margin of the lobulus.

*lo*, Lobulus.

*ptI*, Processus pteralis alæ 1.

*pt2*, Processus pteralis alæ 2.

*pt4*, Processus pteralis alæ 4.

*ptI*, Processus pteralis thoracis I.

*ptII*, Processus pteralis thoracis II.

*ptVI*, Processus pteralis thoracis VI.

*ptA*, Pterale A.

*ptB*, Pterale B.

*re*, Remigium.

*t*, Tegula.

*v1*, Stay.

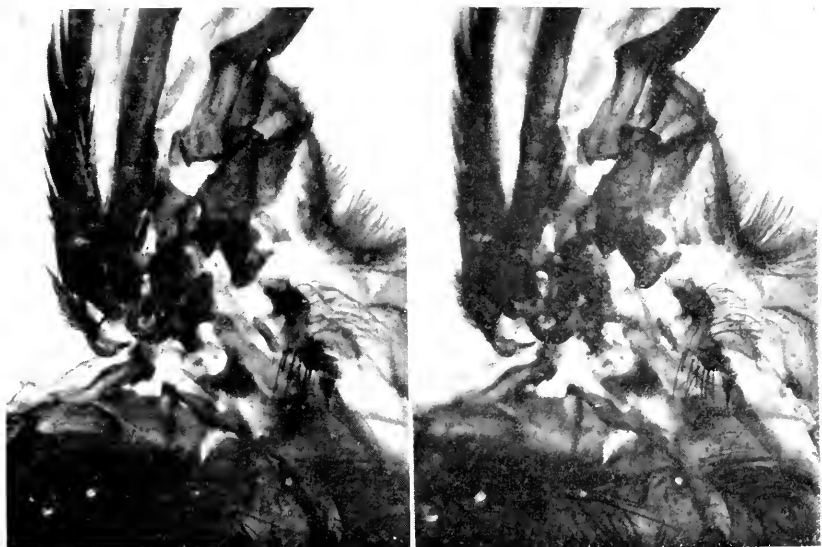

25

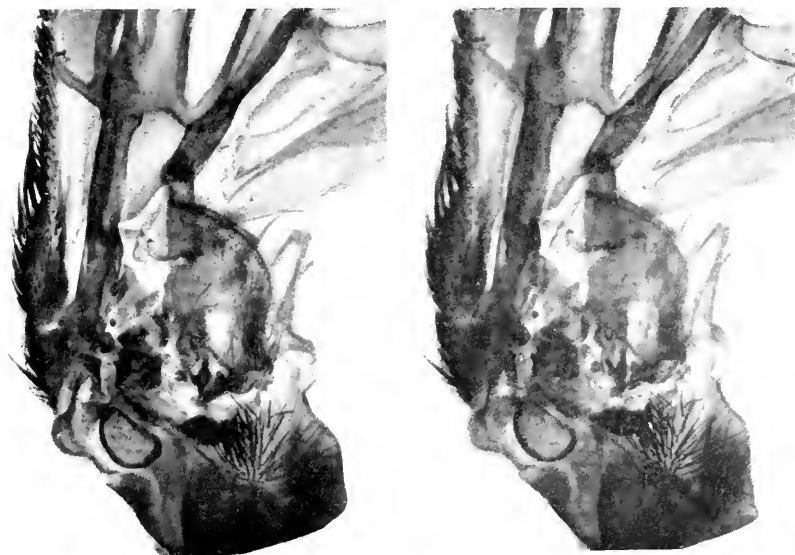

26

WING-JOINTS OF BLOW-FLY





## PLATE 9 (Continued)

FIG. 26. Stereoscopic view of the left wing-joint from below. (Magnified 40 diameters. Photographed with Zeiss binocular; Objective a., Ocular 3.)

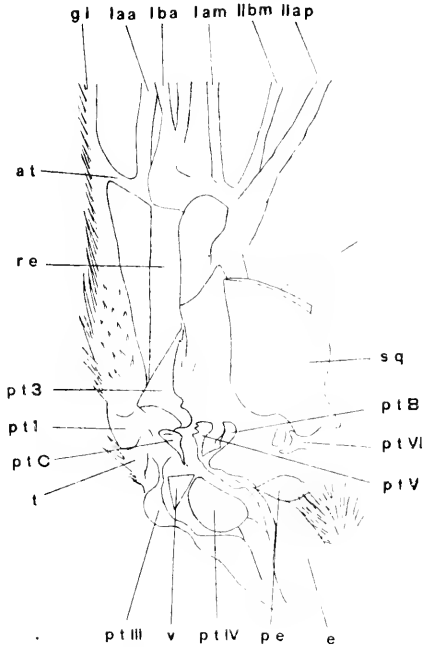

*at*, Anterior transverse vein.

*e*, Episternum.

*gi*, Marginal vein.

*re*, Parepisternum.

*ptI*, Processus pteralis alæ I.

*pt3*, Processus pteralis alæ 3.

*ptIII*, Processus pteralis thoracis III.

*ptIV*, Processus pteralis thoracis IV.

*ptV*, Processus pteralis thoracis V.

*ptVI*, Processus pteralis thoracis VI.

*ptB*, Pterale B.

*ptC*, Pterale C.

*re*, Remigium.

*sq*, Squamula.

*t*, Tegula.

*v*, Stay.

*laa*, First depressed (concave) fold of the anterior region.

*lba*, Crest of first raised (convex) fold of the anterior region.

*lam*, First depressed (concave) fold of the middle region.

*llbm*, Crest of second raised (convex) fold of the middle region.

*llap*, Second depressed (concave) fold of the posterior region.

## PLATE 10

FIG. 27. Stereoscopic view of the episternal process from without. (Magnified 45 diameters. Photographed with Zeiss binocular; Objective  $a_2$ , Ocular 3.)

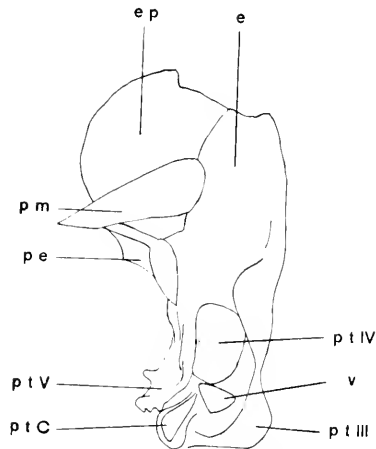

*c*, Episternum.

*ep*, Epimerum.

*pc*, Parepisternum.

*pm*, Parepimerum.

*ptIII*, Processus pteralis thoracis III.

*ptIII'*, Processus pteralis thoracis IV.

*ptIV'*, Processus pteralis thoracis V.

*ptC*, Pterale C.

*v*, Stay.

FIG. 28. Stereoscopic view of the episternal process from within. (Magnified 45 diameters. Photographed with Zeiss binocular; Objective  $a_2$ , Ocular 3.)

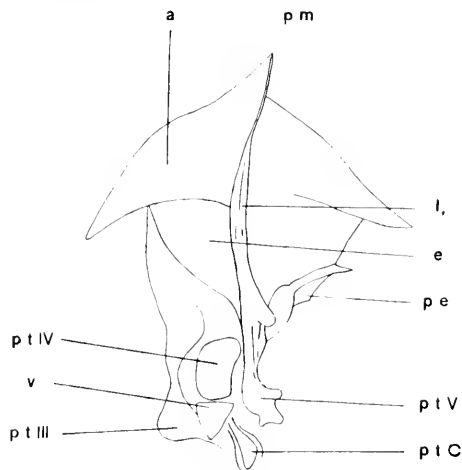

*a*, Mesapodema (processus serratus).

*c*, Episternum.

*l*, Episternal border.

*pc*, Parepisternum.

*pm*, Parepimerum.

*ptIII*, Processus pteralis thoracis III.

*ptIV'*, Processus pteralis thoracis IV.

*ptV'*, Processus pteralis thoracis V.

*ptC*, Pterale C.

*v*, Stay.



27

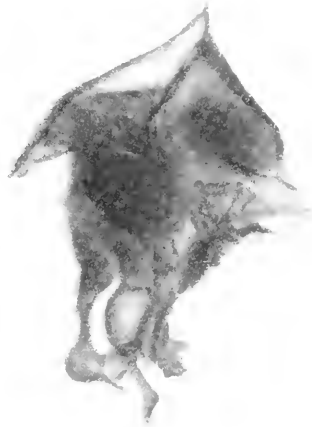
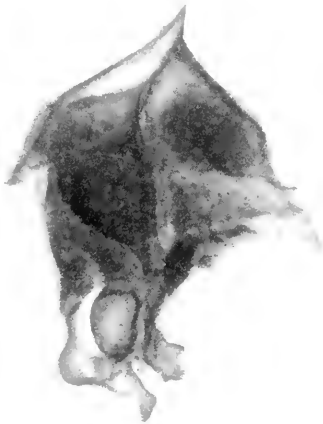

28

EPISTERNAL PROCESS OF BLOW-FLY





## PLATE 11

FIG. 29. Stereoscopic view of the anal part of the wing-joint, from above. (Magnified 14 diameters. Photographed with Zeiss binocular; Objective 55. Ocular 3.)

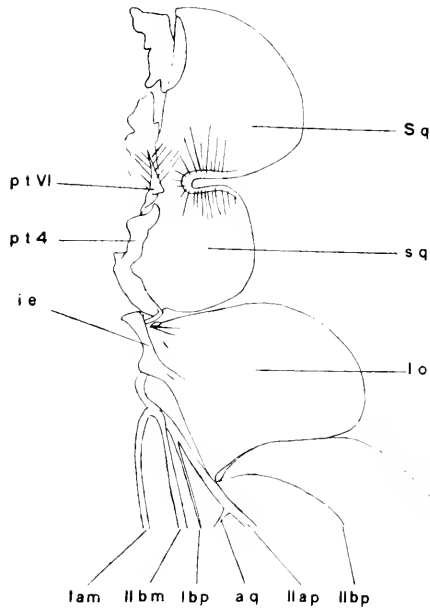

*aq*, Transverse anal vein.

*ie*, Vein of the inner margin of the lobulus.

*lo*, Lobulus.

*pt4*, Processus pteralis alæ 4.

*ptVI*, Processus pteralis thoracis VI.

*sq*, Squamula.

*Sq*, Squama.

*Iam*, First depressed (concave) fold of the middle region, discoidal vein.

*llbm*, Crest of second raised (convex) fold of the middle region.

*lbp*, Crest of first raised (convex) fold of the posterior region.

*llap*, Second depressed (concave) fold of the posterior region, anal vein.

*llbp*, Crest of second raised (convex) fold of the posterior region, axillary vein.



29



30

WING-JOINT AND MUSCLES OF FLIGHT OF BLOW-FLY





## PLATE II (Continued)

FIG. 30. Stereoscopic view of the most external (lateral) direct muscles of flight. (Magnified 20 diameters. Photographed with Zeiss binocular; Objective  $a_5$ , Ocular 3.)

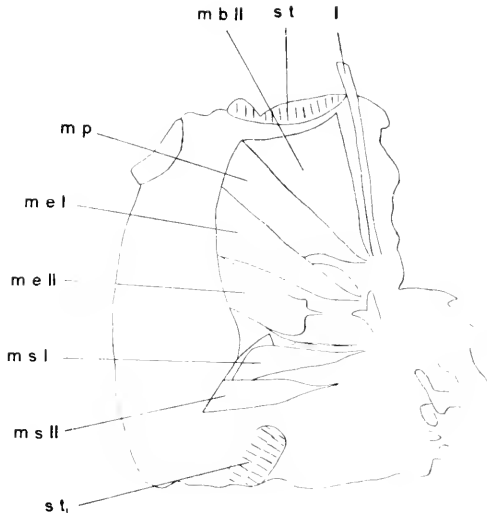

*I*, Præscutal border.

*mbII*, Musculus abductor alæ secundus.

*meI*, Musculus levator alæ primus.

*meII*, Musculus levator alæ secundus.

*mp*, Musculus pronator alæ.

*msI*, Musculus supinator alæ primus.

*msII*, Musculus supinator alæ secundus.

*st*, Stigma anterius.

*st*, Stigma posterius.

## PLATE 12

FIG. 31. Stereoscopic view of the more medially situated indirect muscles of flight. (Magnified 10 diameters. Photographed with Zeiss binocular; Objective 55, Ocular 3.)



*dvl*, Musculus dorso-ventralis primus. *lu*, Air-sac.  
*dvlI*, Musculus dorso-ventralis secundus. *m*, Musculus latus.  
*mm*, Musculus dorsalis.

FIG. 32. Stereoscopic view of the more laterally situated indirect muscles of flight. (Magnified 10 diameters. Photographed with Zeiss binocular; Objective 55, Ocular 3.)

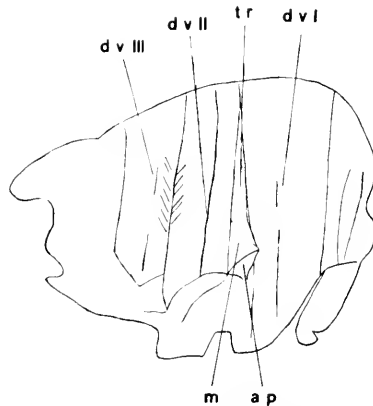

*ap*, Mesapophysis. *dvlIII*, Musculus dorso-ventralis tertius.  
*dvl*, Musculus dorso-ventralis primus. *m*, Musculus latus.  
*dvlII*, Musculus dorso-ventralis secundus. *tr*, Trochanter muscle.



31



32

INDIRECT MUSCLES OF FLIGHT OF BLOW-FLY





## PLATE 13

FIG. 33. Stereoscopic view of the most internal direct muscles of flight. (Magnified 10 diameters. Photographed with Zeiss binocular; Objective 55, Ocular 3.)

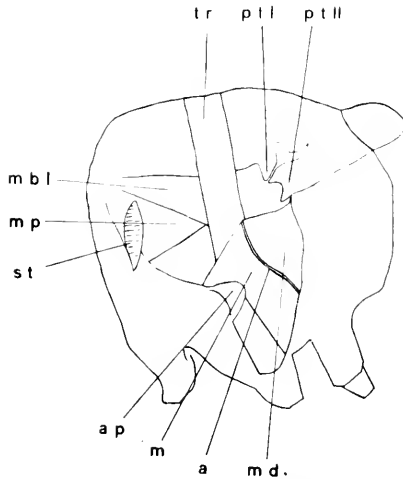

*a*, Mesapodema.

*ap*, Mesapophysis.

*m*, Musculus latus.

*mbI*, Musculus abductor alæ primus.

*md*, Musculus adductor alæ.

*mp*, Musculus pronator alæ.

*ptI*, Processus pteralis thoracis I.

*ptII*, Processus pteralis thoracis II.

*st*, Stigma anterius.

*tr*, Trochanter muscle.

FIG. 34. Stereoscopic view of the intermediate direct muscles of flight. (Magnified 10 diameters. Photographed with Zeiss binocular; Objective 55, Ocular 3.)

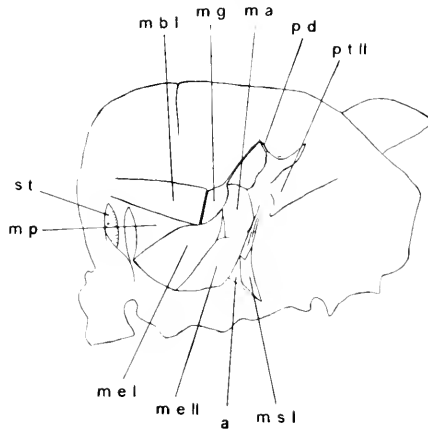

*a*, Mesapodema.

*ma*, Musculus anonymus.

*mbI*, Musculus abductor alæ primus.

*mel*, Musculus levator primus.

*melI*, Musculus levator secundus.

*mg*, Musculus gracilis.

*mp*, Musculus pronator alæ.

*msI*, Musculus supinator alæ primus.

*pd*, Processus dactyloformis.

*ptII*, Processus pteralis thoracis II.

*st*, Stigma anterius.



33

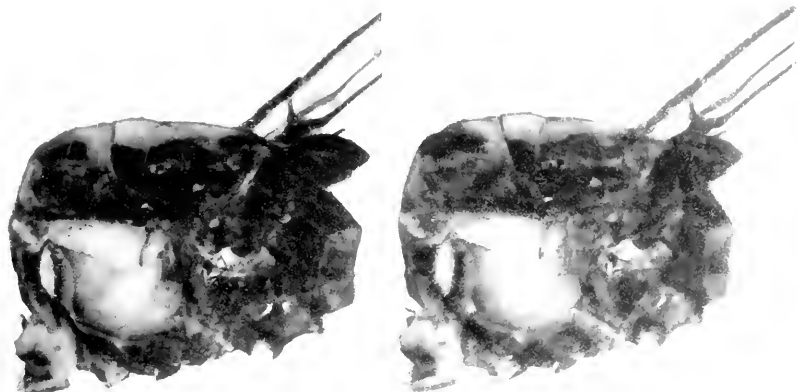

34

DIRECT MUSCLES OF FLIGHT OF BLOW-FLY







## PLATE 14

FIG. 35. Flight-kymograph ready for an experiment.

FIG. 36. Flight-kymograph after an experiment.

FIG. 37. The middle part of the apparatus represented in fig. 35, less reduced.



35



36



37

FLIGHT-KYMOGRAPH





## PLATE 15

FIG. 38. Incomplete Flight-curve obtained by Marey's method on a blackened cylinder. (Natural size.)

FIGS. 39, 40. Incomplete Flight-curves obtained by Marey's method on a blackened cylinder. The cylinder was turned more slowly than in fig. 38, so that the parts of the curve overlap. The fly was held horizontally with the anterior end opposite to the direction of the movement of the cylinder. (Natural size.)

FIG. 41. Flight-curve obtained by means of the flight-kymograph. The fly was held horizontally with the anterior end opposite to the direction of the movement of the board. (Magnified 4 diameters.)

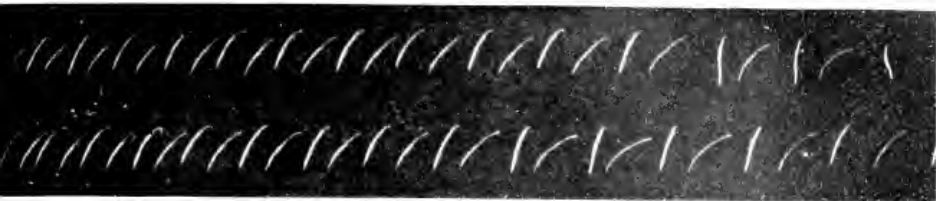

38

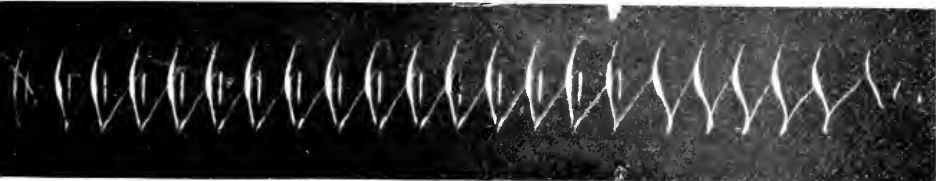

39

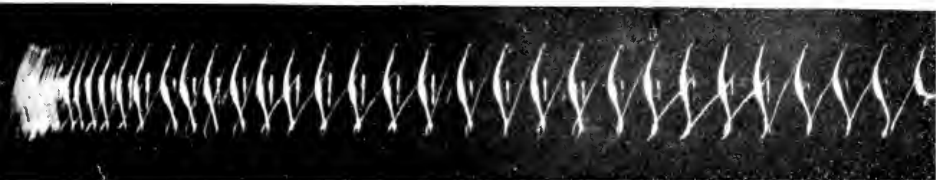

40

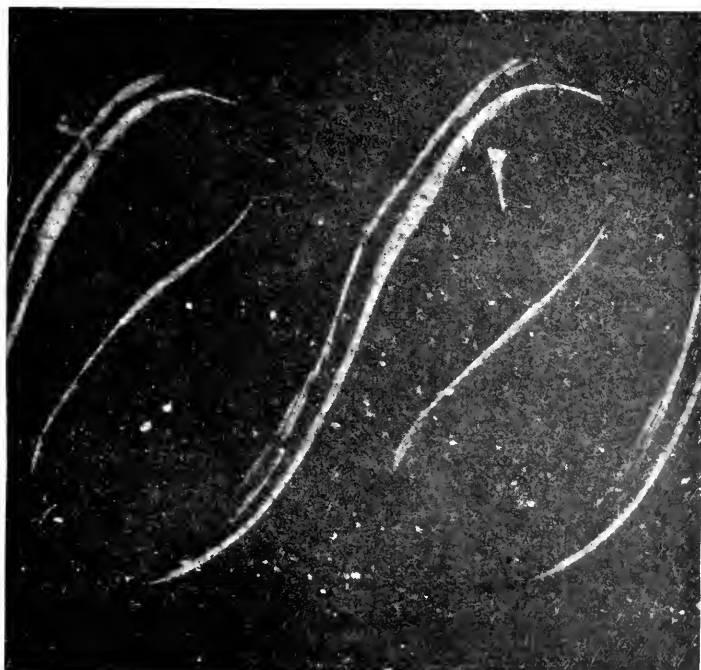

41

FLIGHT-CURVES OF BLOW-FLY







## PLATE 16

FIGS. 42-45. Flight-curve obtained by the flight-kymograph. The fly was held horizontally with the anterior end opposite to the direction of the movement of the board. (Natural size.) Figs. 42-44 are consecutive parts of a continuous curve.



42



43



44



45





## PLATE 17

FIGS. 46-49. Flight-curves obtained by the flight-kymograph. The fly was held horizontally with the anterior end in the same direction as the direction of the movement of the board. (Natural size.) Figs. 46-48 are consecutive parts of a continuous curve.



46



47



48



49







## PLATE 18

FIGS. 50-52. Flight-curves obtained by the flight-kymograph. The fly was held horizontally with the anterior end opposite to the direction of the movement of the board. (Natural size.)



50



51



52





## PLATE 19

FIG. 53. Series of instantaneous photographs of a flying *Calliphora vomitoria*. Direct sunlight. Time of exposure for each individual image  $1/42,000$  of a second. Interval between successive images  $1/2,150$  of a second. The arrows show the succession of time: the upper row running from right to left, the lower row from left to right.

Upper row (the fly seen from behind).

*a*, Lowest position of wings.

*ab*, Raising of the wings (the wing cross-sections are steep).

*b*, Highest position of wings.

*bc*, Depression of wings (the wing cross-sections are at first horizontal and then inclined).

*c*, Lowest position of wings.

Lower row (the fly seen from above).

*d*, Highest position of wings.

*de*, Depression of wings (the wing cross-sections are at first horizontal and then inclined).

*e*, Lowest position of wings.

*cf*, Raising of the wings (the wing cross-sections are steeply inclined, steepest in the middle of this phase of the movement).

*f*, Highest position of wings.

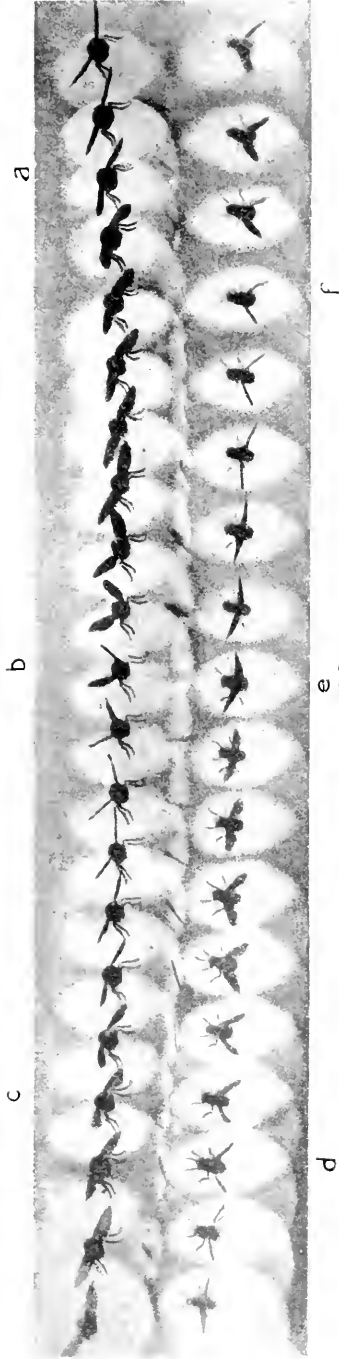

PHOTOGRAPH OF A FLYING BLOW-FLY





SMITHSONIAN MISCELLANEOUS COLLECTIONS

VOLUME 56, NUMBER 13

# TWO NEW AFRICAN RATELS

BY

N. HOLLISTER

Assitant Curator, Division of Mammals, U. S. National Museum



(PUBLICATION 1988)

CITY OF WASHINGTON  
PUBLISHED BY THE SMITHSONIAN INSTITUTION  
October 10, 1910

WASHINGTON, D. C.  
PRESS OF JUDD & DETWEILER, INC.  
1910

## TWO NEW AFRICAN RATELS

By N. HOLLISTER

ASSISTANT CURATOR, DIVISION OF MAMMALS, UNITED STATES NATIONAL  
MUSEUM

Among some interesting Abyssinian mammals, collected and presented to the United States National Museum by the Hon. Hoffman Philip, minister resident and consul general, Adis Ababa, Abyssinia, is a specimen of *Mellivora* which clearly represents a form distinct from any heretofore described. While this specimen was being compared with the material in the Museum collection another undescribed species, represented by specimens from Mount Kilimanjaro and British East Africa, was discovered.

### **MELLIVORA ABYSSINICA, sp. nov.**

*Type* from vicinity of Adis Ababa, Abyssinia. Cat. No. 171876, U. S. Nat. Mus. Old adult female, skin and skull. Collected in 1909 by Hoffman Philip.

*General characters*.—Size medium; mantle complete from between eyes to well on to tail; head and back of uniform color; white marginal line of mantle scarcely distinguishable.

*Color*.—Black, with a uniformly colored dark grizzled iron-gray mantle commencing in a point between the eyes, 45 mm. from nose, widening to ears, and extending in a large oval over entire back, tapering to a point again well out on base of tail. Entire black area with an inconspicuous sprinkling of white hairs. The gray mantle is made up of wholly black and wholly white hairs, and is sharply divided from the black of sides and underparts. A very faint marginal line of lighter gray is barely noticeable along sides of mantle. Width of mantle between shoulders, 115 mm.; at widest point, 175.

*Skull*.—The skull of the type is slightly damaged about the premaxillæ, and one zygomatic arch is broken, making it impossible to get accurate measurements of length or breadth. It is a very old adult and the teeth are much worn. The following measurements have been taken: Post-palatal length, 60; least interorbital breadth, 32.2; greatest breadth of brain-case, 68.5; length of mandi-

ble, 85; upper tooth row, including canine, 36.5; length of upper carnassial, 11.5; lower molar-premolar series, 32.7; length of lower molar, 13.8.

*Measurements of dry skin.*—Total length from nose to end of tail, exclusive of hairs, 960; length of tail, 145; length of longest claw, measured with dividers, 44.5.

*Remarks.*—This ratel is very different from the specimens of *Mellivora ratel* and *M. indica* in the National Museum. From a specimen of *M. ratel* from Cape Colony it most conspicuously differs in its smaller size and the indistinctness of the marginal lines along the mantle. From the descriptions of the type of *Mellivora concisa*<sup>1</sup> from Lake Chad it differs in the completeness of the dark iron-gray mantle, which is unbroken and uniform in color from a point well between the eyes to out on root of tail. It is apparently a slightly larger animal.

#### MELLIVORA SAGULATA, sp. nov.

*Type* from Mount Kilimanjaro, East Africa, at 5,000 feet altitude. Cat. No. 171875, U. S. Nat. Mus. Adult male, skin and skull. Collected September, 1880, by Dr. W. L. Abbott.

*General characters.*—A ratel of largest size with mantle complete from between eyes to tail. Differs conspicuously from *M. ratel* and *M. abyssinica* in the decided ochraceous color of the mantle.

*Color.*—Black, with a mantle of ochraceous tawny from between eyes to well out on base of tail, enclosing a much darker dorsal area. The mantle is pale ochraceous on forehead, darker tawny on nape and along margins; a darker grizzled blackish-brown center begins at neck, and, widening posteriorly, it completely obliterates the marginal line on hips and rump. Width of mantle between shoulders, 135 mm.; at widest point, 245.

*Skull.*—The measurements of the type skull slightly exceed all available measurements of *Mellivora* skulls.<sup>2</sup> Condylbasal length, 152; basal length, 140; palatal length, 71.5; post-palatal length, 70.5; zygomatic breadth, 87; least interorbital breadth, 32.4; upper tooth row, including canine, 44; length of upper carnassial, cingulum, 14.5; length of mandible, 98; lower molar-premolar series, 37.8; length of lower molar, 15.

<sup>1</sup>Thomas and Wroughton, Ann. and Mag. Nat. Hist., 1907, p. 376; Pocock, Proc. Zool. Soc. London, 1909, p. 398.

<sup>2</sup>The basal length of the very largest skull recorded by Welch (P. Z. S., 1909, p. 888), a male from Grahamstown, South Africa, is 135 mm.

*Measurements of dry skin.*—Total length from nose to end of tail, exclusive of hairs, 1220; length of tail, 210; length of longest claw, measured with dividers, 39.

*Remarks.*—The peculiar color of the back is the most striking character in comparing this form with *M. ratel* and *M. abyssinica*, the only neighboring species having the mantle complete from forehead to tail. It also appears to reach the maximum size. A second skin in the Museum collection, from British East Africa, exact locality unknown, agrees with the type in the large size and distinctive color of the back. Doctor Abbott has written on the label of the Kilimanjaro specimen, "Rare upon the mountain."









SMITHSONIAN MISCELLANEOUS COLLECTIONS

VOLUME 56, NUMBER 14

# DESCRIPTIONS OF TEN NEW AFRICAN BIRDS

BY

EDGAR A. MEARNS

Associate in Zoology, U. S. National Museum



(PUBLICATION 2603)

CITY OF WASHINGTON  
PUBLISHED BY THE SMITHSONIAN INSTITUTION  
December 23, 1910

WASHINGTON, D. C.  
PRESS OF JUDD & DETWEILER, INC.  
1910

## DESCRIPTION OF TEN NEW AFRICAN BIRDS.

By EDGAR A. MEARNS

ASSOCIATE IN ZOOLOGY, UNITED STATES NATIONAL MUSEUM

This paper is the eleventh dealing with the results of the Smithsonian African Expedition under the direction of Col. Theodore Roosevelt. It embraces descriptions of ten new species and subspecies of birds, eight of which were discovered by members of the Expedition.

*Francolinus schuetti* Cabanis is represented in East Africa by three slight but quite recognizable forms, from the Mount Kilimanjaro region, from the Mount Kenia region, and from the intervening Kapiti Plains, respectively. Specimens from each of these areas are quite uniform, and are described below.

### FRANCOLINUS SCHUETTI MARANENSIS, new subspecies

Mount Kilimanjaro Francolin

*Type-specimen*.—Adult male. Cat. No. 117819, U. S. N. M. Collected at Maranu, Mount Kilimanjaro, German East Africa, altitude 5,000 feet, April 5, 1888, by Dr. W. L. Abbott.

*Characters*.—Similar to *Francolinus schuetti schuetti*. Crown sepia; feathers of back and scapulars dark brown, edged, except at tip, with pale gray, with chestnut shaft-streaks and coarse marginal black speckles; lower back, rump, and upper tail-coverts vandyke brown vermiculated with black; outer webs of outer primaries mottled and penciled with rusty brown; rectrices vandyke brown broadly banded with black; feathers of chest broccoli brown with broad apical shaft-stripes of prout's brown, without speckles; lower breast, upper abdomen, and flanks broccoli brown with darker brown centers to the feathers and narrow submarginal creamy white stripes.

*Measurements of type* (from skin).—Wing, 168 mm.; tail, 83; exposed culmen, 25.5; tarsus, 54; middle toe (without claw), 42.

*Material*.—Five specimens from Mount Kilimanjaro, German East Africa, collected by Dr. W. L. Abbott.

*Remarks*.—The juvenal plumage of this form has been described by Mr. Oberholser (Proc. U. S. Nat. Mus., vol. 28, 1905, p. 834).

**FRANCOLINUS SCHUETTI KAPITENSIS, new subspecies**

Kapiti Plains Francolin

*Type-specimen*.—Probably adult male (specimen not sexed). Cat. No. 213421, U. S. N. M. Collected at Juja Farm, near the Athi River, British East Africa, altitude about 4,200 feet, May 24, 1900, by J. Alden Loring. Original number, 111.

*Characters*.—Crown brownish olive mixed with gray; feathers of back and scapulars grayish hair brown mixed with black, broadly bordered with hair brown, without chestnut shaft-streaks or conspicuous marginal black spots; general color of lower back, rump, and upper tail-coverts olive-brown; outer webs of outer primaries plain dark brown; rectrices mars brown coarsely vermiculated with black; feathers of chest hair brown with narrow apical shaft-stripes of broccoli brown, thickly flecked with black near the shafts; lower breast, upper abdomen, and flanks hair brown dotted with black near the feather-shafts, and with broad creamy buff submarginal bands.

*Measurements of type*.—Wing, 167 mm.; tail, 85; exposed culmen, 26.5; tarsus, 51; middle toe (without claw), 41.

*Material*.—Three specimens from Juja Farm and Nairobi, British East Africa.

*Remarks*.—Two developed spurs on each tarsus, and its larger size, make it quite certain that the type is a male, as females usually lack developed spurs.

**FRANCOLINUS SCHUETTI KENIENSIS, new subspecies**

Mount Kenia Francolin

*Type-specimen*.—Adult male. Cat. No. 214739, U. S. N. M. Collected at Nyeri (altitude 5,943 feet), base of Mount Kenia, British East Africa, September 16, 1909, by Edgar A. Mearns. Original number, 16828.

*Characters*.—Crown bistre; feathers of back and scapulars bistre thickly vermiculated with black, and narrowly bordered with brownish gray finely mixed with blackish; lower back, rump, and upper tail-coverts bistre vermiculated with black; outer web of outer primaries plain dark brown; rectrices brown, finely vermiculated with black; feathers of chest hair brown with a large apical spot of sepia; lower breast, upper abdomen, and flanks sepia, the feathers broadly edged with buffy white penciled with sepia.

*Measurements of type*.—Wing, 175 mm.; tail, 84½; exposed culmen, 27; tarsus, 40; middle toe (without claw), 40.

*Material*.—Three specimens from Nyeri and Wambugu, British East Africa.

**NECTARINIA JOHNSTONI IDIUS, new subspecies**

Mount Kenia Scarlet-tufted Malachite Sunbird

"*Nectarinia deckeni* Lorenz," HÖHNEL, narrative of Comte Teleki's "Expedition to Lake Rudolf," English translation, vol. 1, 1894, p. 374, note, *nomen nudum*; *Ibis*, 1894, p. 452.

*Nectarinia johnstoni* SHARPE, Bull. B. O. C. No. 12, 1893, p. ix (Mount Kenia).

*Type-specimen*.—Adult male. Cat. No. 215064, U. S. N. M. Collected on Mount Kenia at 14,000 feet, British East Africa, September 26, 1909, by Edgar A. Mearns. Original number, 16009.

*Characters*.—Similar to *Nectarinia johnstoni johnstoni* Shelley, but slightly larger; adult male with metallic feathers of upper parts more golden and less bluish green, this being exactly reversed in the coloration of the under parts; crissum more intense black. Adult female decidedly darker brown than the female of *Nectarinia johnstoni johnstoni*.

*Measurements of type*.—Adult male. Wing, 84 mm.; longest tail-feather, 21.5; culmen (chord), 31.5; tarsus, 19.

*Comparative measurements*.—Average of ten adult males of *Nectarinia johnstoni idius*: Wing, 82.6 mm.; longest tail-feather, 195.7; culmen (chord), 31.3; tarsus, 18.6.

Average of eight adult males of *Nectarinia johnstoni johnstoni* from Mount Kilimanjaro: Wing, 81.2; longest tail-feather, 175.0; culmen (chord), 30.9; tarsus, 17.7.

One adult male (Cat. No. 211029, U. S. N. M.) of *Nectarinia dartmouthi* from Mount Ruwenzori: Wing, 82.5; longest tail-feather, 175; culmen (chord), 26.2; tarsus, 19.5.

Average of seven adult females of *Nectarinia johnstoni idius*: Wing, 74.1; tail, 55.9; culmen (chord), 29.3; tarsus, 17.7.

Average of two adult females of *Nectarinia johnstoni johnstoni*: Wing, 72; tail, 52; culmen (chord), 26.2; tarsus, 16.8.

One adult female (Cat. No. 211986, U. S. N. M.) of *Nectarinia dartmouthi*: Wing, 73; tail, 55; culmen (chord), 26; tarsus, 19.

*Remarks*.—Males of this form require no comparison with *Nectarinia dartmouthi* Grant, but females resemble females of *dartmouthi* more than those of *johnstoni*, although they may be readily distinguished from the former by their longer bill and shorter tarsus.

**CINNYRIS MEDIOCRIS KENIENSIS, new subspecies**

Mount Kenia Double-collared Sunbird

*Type-specimen*.—Adult male. Cat. No. 215737, U. S. N. M. Collected at West Kenia Forest Station, 7,500 feet, British East Africa, September 19, 1909, by Edgar A. Mearns. Original number, 16865.

*Characters*.—Adult male similar to *Cinnyris mediocris mediocris* Shelley, but slightly larger, with metallic feathers of upper parts less golden green; red band across chest paler and more bricky red; lining of wings, and under parts posterior to red chest-band much paler, the latter more yellowish olive-green. Adult female with upper parts paler and more greenish olive-brown; under parts paler and yellower. In both sexes there is much more grayish white on the outer webs and tips of the outer tail-feathers.

*Measurements of type*.—Wing, 56 mm.; tail, 46.5; culmen (chord), 18.2; tarsus, 17.7.

*Comparative measurements*.—Average of ten adult males of *Cinnyris mediocris keniensis*: Wing, 55.1; tail, 48.4; culmen (chord), 18.7; tarsus, 17.6.

Average of nine adult male topotypes of *Cinnyris mediocris mediocris* Shelley: Wing, 52.3; tail, 45.7; culmen (chord), 18.4; tarsus, 17.5.

Adult female (Cat. No. 215733, U. S. N. M.) of *Cinnyris mediocris keniensis*: Wing, 50; tail, 40; culmen (chord), 17.5; tarsus, 17.5.

Adult female (Cat. No. 215733, U. S. N. M.) of *Cinnyris mediocris mediocris*: Wing, 46; tail, 37; culmen (chord), 17; tarsus, 17.

**CYANOMITRA CHANGAMWENSIS, new species**

Changamwe Olive Sunbird

*Type-specimen*.—Adult female. Cat. No. 215725, U. S. N. M. Collected at Changamwe (near Mombasa), British East Africa, November 25, 1909, by Edgar A. Mearns. Original number, 17587.

*Characters*.—Similar to *Cyanomitra olivacea ragazzii* (Salvadori), but much smaller, and paler on the under parts; upper parts olive green of the same shade as in *ragazzii*; under parts pale grayish pea green washed with yellow, most strongly on the throat and upper chest; pectoral plumes canary yellow; bill uniform brownish black.

*Measurements of type*.—Wing, 53 mm.; tail, 54; culmen (chord), 20; tarsus, 14.2.

*Remarks.*—A second female specimen (Cat. No. 215727, U. S. N. M.) is albinistic. The upper parts are whitish drab, washed with yellow; under parts grayish white washed with yellow; bill and feet uniformly brown; wing, 52; tail, 41; culmen (chord), 19.7; tarsus, 13.5.

**ANTHREPTES COLLARIS ELACHIOR**, new subspecies

Lesser Collared Sunbird

*Type-specimen.*—Adult male. Cat. No. 215747, U. S. N. M. Collected at Changamwe (near Mombasa), British East Africa, November 25, 1909, by Edgar A. Mearns. Original number, 17593.

*Characters.*—Smaller and paler than *Anthreptes collaris zambeianus* (Shelley); upper metallic parts less coppery golden green; middle under parts canary instead of lemon yellow; outer webs of secondaries yellowish olive-green instead of bronzy yellowish green; sides paler and grayer.

*Comparative measurements.*—Average of six adult males of *Anthreptes collaris elachior* (five from Changamwe and one from Zanzibar): Wing, 46.7 mm.; tail, 35.8; culmen (chord), 13.7; tarsus, 14.3. Average of seven adult males of *Anthreptes collaris zambeianus* (from Taveta, Juja Farm, and Honi River (in the Mount Kenia district), British East Africa): Wing, 50.3; tail, 42; culmen (chord), 14.7; tarsus, 15.9.

Average of four adult female topotypes of *Anthreptes collaris elachior*: Wing, 45; tail, 33.5; culmen (chord), 13.3; tarsus, 14.5. Average of four adult females of *Anthreptes collaris zambeianus* from Taveta, British East Africa: Wing, 48.3; tail, 37.5; culmen (chord), 14.5; tarsus, 15.6.

*Remarks.*—An adult male (Cat. No. 148951, U. S. N. M.) from Zanzibar is so entirely similar to the Changamwe series that I have no hesitation in referring it to the present form.

**PSEUDONIGRITA ARNAUDI KAPITENSIS**, new subspecies

Kapiti Social-Weaver

*Philetarus emini* SHARPE, Ibis, 1891, p. 249 (Machakos).

*Type-specimen.*—Adult male. Cat. No. 213773, U. S. N. M. Collected at Juja Farm, Kapiti Plains, British East Africa, May 14, 1909, by Edgar A. Mearns. Original number, 15770.

*Characters.*—Differs from *Pseudonigrita arnaudi arnaudi* (Bonaparte) in being decidedly larger, with the colors paler throughout,

excepting the shoulder-patch, which has more black mixed with the gray.

*Measurements of Pseudonigrita arnaudi kapitensis*.—Adult male (type specimen): Wing, 68 mm.; tail, 41; culmen (chord), 14; tarsus, 18. Adult female (average of two topotypes): Wing, 65; tail, 40; culmen (chord), 14; tarsus, 18.

*Measurements of Pseudonigrita arnaudi arnaudi* (from Nimule, Lokko Zegga, and Ledgus, on the Upper Nile).—Adult male (average of four): Wing, 62.5; tail, 37.2; culmen (chord), 13; tarsus, 17.1. Adult female (average of five): Wing, 60.9; tail, 35.4; culmen (chord), 12.3; tarsus, 16.6.

*Description of young* (female; Cat. No. 213774, U. S. N. M.; killed at the same shot with the type).—Differs from the adult in having the crown hair brown like the upper side of the neck and upper back, conspicuously darker than rump and upper tail-coverts; lower back and scapulars blackish drab; shoulder-patch nearly black; black markings of wings and tail as in adults, but with narrow drab-gray tips to the wing-quills; secondaries edged externally with pale russet; bill dark brown above, flesh color on basal two-thirds of mandible, instead of black throughout; feet fleshy brown instead of light yellowish brown.

*Material*.—Three adults and one young from Juja Farm and Kamiti, British East Africa.

#### LAGONOSTICTA INCERTA, new species

##### Vinous Fire-finch

*Type-specimen*.—Adult male. Cat. No. 217311, U. S. N. M. Collected at Gondokoro, on the Bahr el Jebel, Uganda, Africa, February 25, 1910, by Edgar A. Mearns. Original number, 18805.

*Description of type*.—Crown, upper side of neck, back, and wings olive-brown perceptibly tinged with red; forehead in front of eyes, and entire side of head, including supraorbital stripe, and upper tail-coverts burnt carmine; tail black, bordered with carmine on outer webs of feathers at base; under wing-coverts pale buffy gray; under side of wing-quills dusky grayish; chin, throat, and breast vinaceous, fading to smoke gray on abdomen and grayish white on under tail-coverts; breast quite thickly spotted with white, tending to form bars; bill red, striped with black above, below, and along lower edge of maxilla; feet and claws brown.

*Measurements of type*.—Wing, 46 mm.; tail, 42; culmen (chord), 10.6; tarsus, 13.5.



**SPOROPIPES FRONTALIS ABYSSINICUS**, new subspecies

Abyssinian Speckled-fronted Weaver

*Type-specimen*.—Adult male. Cat. No. 100033, U. S. N. M. Collected by Blondeel in Abyssinia. Original number, 25845.

*Characters*.—Differs from *Sporopipes frontalis frontalis* in being larger and much paler in coloration; upper parts instead of ashy brown are pale ecru drab; wings and tail paler brown with broad whitish margins to the feathers; top and sides of neck paler cinnamon, with pale edging to the feathers; forehead and front of crown more brownish black, with broader white tips to the feathers; under parts almost white, with only the barest trace of a drab gray chest-band; under wing-coverts white.

*Measurements of type specimen of Sporopipes frontalis abyssinicus*: Wing, 65 mm.; tail, 52; culmen (chord), 12; tarsus, 19.

*Average measurements of two adult males of Sporopipes frontalis frontalis* (from Gondokoro, Uganda): Wing, 62; tail, 47.5; culmen (chord), 11.5; tarsus, 17.







SMITHSONIAN MISCELLANEOUS COLLECTIONS

VOLUME 56, NUMBER 15

NEW SPECIES OF INSECTIVORES FROM  
BRITISH EAST AFRICA, UGANDA,  
AND THE SUDAN

WITH ONE PLATE

BY

EDMUND HELLER

Naturalist, Smithsonian African Expedition



(PUBLICATION 2004)

CITY OF WASHINGTON  
PUBLISHED BY THE SMITHSONIAN INSTITUTION  
December 23, 1910

WASHINGTON, D. C.  
PRESS OF JUDD & DETWEILER, INC.  
1910

NEW SPECIES OF INSECTIVORES FROM BRITISH EAST  
AFRICA, UGANDA, AND THE SUDAN

(WITH ONE PLATE)

BY EDMUND HELLER

NATURALIST, SMITHSONIAN AFRICAN EXPEDITION

This paper contains descriptions of eleven new species and one new genus of *Insectivora*. The material described is from the collection made in east Equatorial Africa by the Smithsonian African Expedition under the direction of Col. Theodore Roosevelt. The bulk of the species are from Rhino Camp, in the Lado Enclave, Egyptian Sudan. The precise geographical position of this spot is latitude  $2^{\circ} 55'$  north, on the west bank of the Nile, some fifteen miles north of the station of Wadelai.

This paper is the twelfth dealing with the results of the expedition.

**ERINACEUS SOTIKÆ**, new species

Sotik Hedgehog

Type from the Guaso Nyiro River. Sotik District, British East Africa; adult male; number 162112, U. S. Nat. Mus.; collected by J. Alden Loring, June 28, 1909; original number, 6451.

*Characters*.—Nasal bones very long and attenuate posteriorly, reaching to middle of frontal bones; zygomatic arches slender; spines with the dark point so minute that there is no visible terminal speckling to the coloration.

*Coloration*.—General dorsal coloration white, the spinous portion with a speckling due to the dark subterminal rings of the spines showing through. Snout, chin, lips, and head posteriorly to behind eyes, hair brown; fore and hind feet lighter brown; the legs white like the sides. Under parts white, the hair white to the base. Tail white. Dorsal spines annulated with a broad band of seal brown subterminally, the tip broadly white with a minute dark point. Low down on the sides a few wholly white spines are interspersed with the annulated ones. Longest spines on head 20 mm.

*Measurements.*—Head and body, 170 mm.; tail, 26; hind foot,<sup>1</sup> 25. Skull: condylo-incisive length, 42; zygomatic breadth, 27; nasals, 15.5 x 2.3; interorbital constriction, 11.2; palatal length, 25; breadth of palate, including first molar, 17; length of upper tooth-row, 21.8;<sup>2</sup> condylo-incisive length of mandible, 34.5.

This species is closely allied to *hindei* of Kitui in coloration and general proportions. It differs decisively in the greater length and attenuation of the nasal bones, the lighter zygomatic arches, and smaller skull. The type skull shows some asymmetrical peculiarity. On the right side the premaxillary and frontal processes join and shut out the maxillary from the nasal, while on the left side these two bones are separated by the maxillary which borders the nasal for a length of 2 mm. There are four other specimens in the collection from the Sotik. These all agree with the type in the great length and attenuation of the nasals.

#### CROCIDURA SURURÆ, new species

##### Lado Giant Shrew

Type from Rhino Camp, Lado Enclave; adult male; number 164637, U. S. Nat. Mus.; collected by J. Alden Loring, January 18, 1910; original number, 8777.

*Characters.*—Smaller than *nyansæ*, but proportions the same; dorsal color lighter and grayer, without any brownish wash to the under parts.

*Coloration.*—Upper parts broccoli brown, merging gradually on sides to grayish, showing everywhere a grizzled effect, due to the grayish subterminal area of the hair showing through. Limbs whitish. Under parts grayish with a faint buffy wash. Lateral glands conspicuously marked by an oblong patch of short white hairs.

*Measurements.*—Head and body, 111 mm.; tail, 64; hind foot, 17. Skull: condylo-incisive length, 28.5; breadth of brain-case, 12; length of upper tooth-row, 13; condylo-incisive length of mandible, 18.

There are in the collection a series of nine specimens from the type locality. These are remarkably uniform in color and propor-

<sup>1</sup>All measurements of the hind foot given in this paper exclude the claws and were taken from the dried skins, which afford better means of comparison than the collector's flesh measurements.

<sup>2</sup>Some departure from the usual alveolar measurements of the tooth row has been made, the measurement as given throughout the paper being taken from the posterior end of the tooth row to the outside border of the central incisor. In the smaller species this measurement can be taken with greater preciseness than the alveolar length.



tions, which is a very unusual condition in the forms of this variable species. A single specimen from Gondokoro is referable to this form. It is, however, lighter than the Rhino Camp series, with longer tail, and no doubt represents the extreme in size and light coloration.

#### CROCIDURA MUTESÆ, new species

Uganda Large-toothed Shrew

Type from Kampala, Uganda; adult female; number 174636. U. S. Nat. Mus.; collected by J. Alden Loring, December 22, 1909; original number, 8430.

*Characters*.—Somewhat larger than *zaodon*, with much more brownish coloration.

*Coloration*.—Upper parts mummy brown, feet and tail darker seal brown; under parts grayish, with a wash of broccoli brown. Lateral glands marked by a narrow streak of short light brownish hairs.

*Measurements*.—Head and body, 115 mm.; tail, 64; foot, 16. Skull: condylo-incisive length, 25.5; breadth of brain-case, 11.2; upper tooth-row, 11.3; condylo-incisive length of mandible, 16.

Two other specimens from Uganda are in the collection, which are referable to this form. These are much darker, being seal brown in color, and very little larger than *zaodon*.

#### CROCIDURA NILOTICA, new species

Nile Swamp Shrew

Type from Rhino Camp, Lado Enclave; adult female; number 164638, U. S. Nat. Mus.; collected by J. Alden Loring, January 17, 1910; original number, 8768.

*Characters*.—Differs from *provocax*, its nearest ally, in its much shorter tail and pelage.

*Coloration*.—Upper parts dark clove brown; under parts slaty, but very little lighter than upper, but with a sepia wash. Feet, ears, and tail colored like the upper parts, except the long hairs of the latter, which are somewhat lighter brownish. Hair everywhere slaty at base. Hairs covering lateral glands uniform in color with those of sides. Hair short; length on rump, 5 mm.

*Measurements*.—Head and body, 92 mm.; tail, 48; hind foot, 14.5. Skull: condylo-incisive length, 23; breadth brain-case, 10; length tooth-row, 9.5; condylo-incisive length of mandible, 14.5.

There is in the collection a series of seven specimens from the type locality. They are quite uniform in coloration with the excep-

tion of two old adults, which show a few white flecks on the dorsal surface and much white spotting on the chin and throat. Besides the type series, there are in the collection a few specimens from Butiaba, Hoima, and Kabula Muliro, in Uganda.

**CROCIDURA MAANJÆ, new species**

Nyanza Brown Shrew

Type from Kabula Muliro; adult male; number 164639, U. S. Nat. Mus.; collected by J. Alden Loring, December 27, 1909; original number, 8502.

*Characters*.—Darker sepia above and purer gray below than *hildegarda*, the under parts lacking the brownish wash; teeth heavier.

*Coloration*.—Upper parts, including limbs and tail, seal brown, merging gradually on the sides into the grayer under parts, which lack the brownish wash of the sides. Lateral glands conspicuously marked by an oblong patch of silvery white hair.

*Measurements*.—Head and body, 82 mm.; tail, 52; foot, 12.5. Skull (occipital region broken): breadth of brain-case, 8.7; length of tooth-row, 8.5; condylo-incisive length of mandible, 12.

The skull shows somewhat heavier dentition than *hildegarda* and the tooth-row is correspondingly greater.

Only a single specimen of this shrew is in the collection.

**CROCIDURA LUTRELLA, new species**

Enclave Veldt Shrew

Type from Rhino Camp, Lado Enclave; adult male; number 164640, U. S. Nat. Mus.; collected by J. Alden Loring, January 14, 1910; original number, 8729.

*Characters*.—Tail short and heavy; under parts light grayish buffy in marked contrast to the darker dorsal surface.

*Coloration*.—Upper surfaces of head, body, and tail light broccoli brown, this color descending on sides unchanged. Under parts and sides from level of mouth and under side of tail light grayish buff; sides of face nearly to level of eyes whitish. Hair everywhere light plumbeous at base. Feet whitish. Lateral glands large and conspicuously marked by a covering of silky white hair. Tail covered by scattered long white hairs throughout its whole length. Hair fairly dense, but short; length on back, 3 mm.

*Measurements*.—Head and body, 80 mm.; tail, 40; hind foot, 12. Skull: condylo-incisive length, 21; breadth of brain-case, 9.3; length of upper tooth-row, 9; condylo-incisive length of mandible, 12.3.

This species has the general appearance of *hindei*, but is much smaller, with the dorsal and neutral colors sharply marked and contrasted.

**CROCIDURA PLANICEPS, new species**

Flat-headed Shrew

Type from Rhino Camp, Lado Enclave; adult male; number 164641, U. S. Nat. Mus.; collected by J. Alden Loring, January 23, 1910; original number, 8837.

*Characters*.—Skull very different in shape from other *Crocidura*, the brain-case very flat, with a marked depression at its anterior termination in the interorbital region, the profile of the rostrum ascending slightly anterior to this depression; general body size of *hildegardæ*.

*Coloration*.—Above uniform seal brown, this color carried well down on sides, where it merges gradually into the lighter smoky gray of the under parts. Tail seal brown like the upper parts. Feet somewhat lighter brown than the back. Lateral glands distinctly marked by an oblong patch of whitish hair. Hair very short, only 2.5 mm. on rump, and uniform in color to the roots on upper parts. Hair of under surfaces, however, showing a narrow basal band of plumbeous.

*Measurements*.—Head and body, 71 mm.; tail, 53; hind foot, 12.3. Skull: condylo-incisive length, 18.3; breadth of brain-case, 8; length of upper tooth-row, 8; condylo-incisive length of mandible, 11.

This species in bodily size resembles *hildegardæ*, but it has decidedly smaller feet and skull, and darker coloration. From the *bicolor* group, of which *cunninghami* is a form, it differs markedly in shape of skull, dark feet, and greater size. In skull characters it is quite distinct from any described species. The skull has somewhat the posterior elongation and narrowness of *Heliosorex*, but it is much less developed and not at all intermediate between this genus and *Crocidura*.

There are four other adult specimens from the type locality in the collection, and another from Hoima which possesses the skull characters of the species, but is somewhat smaller.

**CROCIDURA LITTORALIS, new species**

Butiaba Naked-tailed Shrew

Type from Butiaba, east shore of Albert Nyanza, Uganda; adult male; number 164642; U. S. Nat. Mus.; collected by J. Alden Loring, January 6, 1910; original number, 8598.

*Characters*.—Tail without longer hairs, as in *maurisca*, but much larger size than this species, with proportionately shorter tail.

*Coloration*.—Upper parts rich sepia, ears and feet somewhat lighter, tail darker blackish brown. Under parts vandyke brown. The chin and throat becoming suffused with grayish. Fur everywhere plumbeous at base; short, only 5 mm. on rump. Hair covering the lateral glands short, but not differentiated by color.

*Measurements*.—Head and body, 96 mm.; tail, 67; foot, 17. Skull: condylo-incisive length, 24; breadth of brain-case, 10; length of upper tooth-row, 10; condylo-incisive length of mandible, 14.3.

This species is one of the *maurisca* group, with a cylindrical, short-haired tail, the longer hairs being present only at the base.

### HELIOSOREX, new genus

Type: *Heliosorex roosevelti* Heller

*Characters*.—Skull with the brain-case very much narrowed and marked by a prominent transverse constriction at its posterior third, well in advance of the lambdoidal crests; sides of interorbital region parallel; brain-case high and inflated, reaching its highest point midway between the constriction and its anterior end; dental formula as in *Crocidura*; first unicuspid about twice the size of second and third, which are of equal size; claws very small—about half the size of those of *Crocidura*.

The skull of this shrew differs more widely in shape from *Crocidura* than any other allied genus; in other words, it is the extreme in narrowness and posterior elongation. Some of the species of *Crocidura* show the constriction, but in all of these it is placed only slightly in advance of the lambdoidal crests, and the brain-case has, moreover, the triangular shape seen in typical *Crocidura*. The small claws are the only external character.

### HELIOSOREX ROOSEVELTI, new species

Roosevelt Short-clawed Shrew

PLATE I.<sup>3</sup> Skull. Twice natural size

Type from Rhino Camp, Lado Enclave; adult female; number 164643, U. S. Nat. Mus.; collected by J. Alden Loring, January 21, 1910; original number, 8812.

<sup>3</sup> An unfortunate accident occurred to the skull after the two views shown on the plate had been taken. In adjusting the camera to take the side view the lens fell, striking the skull and damaging the occipital region to such an extent that further photographic work on the specimen had to be abandoned.



HELIOSOREX ROOSEVELTI HELLER

Type. Twice natural size



*Characters*.—Skull very much narrowed, the brain-case narrow and high, with a marked contraction far in front of lambdoidal crests; claws very small; tail long, nearly equaling head and body.

*Coloration*.—Upper parts broccoli brown, sides slightly grayer; the color sharply marked from the buffy lower parts; under parts and lower sides buffy gray; chin, and sides of face to level of eyes, and feet whitish. Tail seal brown above, whitish below. Lateral glands marked by an oblong patch of silky white hair. Fur plumbeous at base; short, 4 mm. in length on rump.

*Measurements*.—Head and body, 85 mm.; tail, 66; foot, 14. Skull: condylo-incisive length, 21.5; breadth of brain-case, 8.5; length of upper tooth-row, 8.7; condylo-incisive length of mandible, 12.5.

The type is the only specimen in the collection.

I take much pleasure in naming this distinct type of shrew for Colonel Roosevelt, who took a keen personal interest in the collection of small mammals.

#### SYLVISOREX GEMMEUS, new species

##### Long-tailed Forest Shrew

Type from Rhino Camp, Lado Enclave, Egyptian Sudan; adult male; number 164644, U. S. Nat. Mus.; collected by J. Alden Loring, January 14, 1910; original number, 8730.

*Characters*.—Tail very long—much longer than head and body; lower parts of body pearl gray.

*Coloration*.—Color of upper parts, including limbs, seal brown, lower sides becoming slaty, the color encroaching much posteriorly on the gray of the lower parts, where only the median line of belly is light. Chin, throat, chest, and median line of belly pearly gray. Tail seal brown above, basal one-half lighter below. Under fur everywhere plumbeous.

Body rather thinly haired. Ears, limbs, and tail clothed with minute hairs, the latter without any longer hairs near its base, as in *Crocidura*. Length of hair on rump, 7 mm. Tail long and cylindrical, tapering very gradually.

*Measurements*.—Head and body, 69 mm.; tail, 72; hind foot, 15. Skull: condylo-incisive length, 18; breadth of brain-case, 8; length of upper tooth-row, 7.5; condylo-incisive length of mandible, 10.5.

The skull is the same general size as that of *mundus*, but differs in its greater length and narrowness, and is also somewhat flatter. The upper unicuspid shows the same relative sizes.

There is one other specimen in the collection from Rhino Camp beside the type.

**ELEPHANTULUS PHÆUS, new species**

Masai Elephant Shrew

Type from Njoro O Solali, Sotik District, British East Africa; adult male; number 162074, U. S. Nat. Mus.; collected by J. Alden Loring, June 26, 1909; original number, 6441.

*Characters*.—Much darker dorsal coloration than in *pulcher* and with larger body size.

*Coloration*.—Above umber brown, lightly overlaid with black-tipped hairs; sides of body and head gray and lacking the brownish; on the snout the gray color encroaching on the umber, which is confined to a median streak on the snout. Eye-ring white and continued posteriorly as a diagonal postocular stripe, bordered below by a dark-brown streak which breaks through the white eye-ring and reaches the eye. A fulvous patch behind each ear. Upper lip, under parts, and feet white, the white being sharply contrasted where it meets the tawny gray of the lower sides. Hair everywhere dark slate at base. Tail dark brown above, grayish below; the long hair of the rump lacking at the base of the tail, where a triangular naked area is exposed when the hair is disturbed.

*Measurements*.—Head and body, 133 mm.; tail, 133; hind foot, 33. Skull: condylo-incisive length, 36.5; zygomatic breadth, 20; nasals, 14; interorbital constriction, 6; length of palate, 18.8; length of upper tooth-row, 17.5; condylo-incisive length of mandible, 27; length of lower tooth-row, 15.5.

This form is closely allied to *pulcher*, from which it differs in the darker umber-brown color, being "gray-fawn" only on the sides. *Pulcher* is described as having the under fur of the under parts gray, and, if this is correct, *phæus* differs greatly in its dark slate under fur. The series of six topotypes in the collection is uniform in color with the type.







SMITHSONIAN MISCELLANEOUS COLLECTIONS

VOLUME 56, NUMBER 19

SOME RESULTS OF RECENT  
ANTHROPOLOGICAL EXPLORATION  
IN PERU

WITH FOUR PLATES

BY

DR. ALEŠ HRDLIČKA

Curator, Division of Physical Anthropology, U. S. National Museum



( PUBLICATION 2005 )

CITY OF WASHINGTON  
PUBLISHED BY THE SMITHSONIAN INSTITUTION  
1911

The Lord Baltimore Press  
BALTIMORE, MD., U. S. A.

SOME RESULTS OF RECENT ANTHROPOLOGICAL  
EXPLORATION IN PERU<sup>1</sup>

BY DR. ALEŠ HRDLIČKA,

*Curator, Division of Physical Anthropology, U. S. National Museum*

(WITH FOUR PLATES)

Peru may well be regarded, even in its present territorial restriction, as the main key to the anthropology of South America. Due to the numbers of its ancient inhabitants, and to their far reaching social differentiations, indicating long occupancy, a good knowledge of the people of Peru from the earliest times is very desirable, and would constitute a solid basis from which it should be relatively easy to extend anthropological comparison to all the rest of the native peoples of the Southern Continent.

We know already, in a general way, that Peru, shortly before the conquest, was peopled by three or four larger "races" or strains of Indians: The Aymara (d'Orbigny) and the Quechua, in the central and southern highlands; the Huancas (Tschudi), in the north, and the Yungas (Calancha) or Chinchas (Tschudi), along the coast.<sup>2</sup> Besides this, a considerable number of unclassified tribes existed in the northeastern and northern regions of the great territory. These various peoples are known to have spoken a number of different

<sup>1</sup> Paper read before the Seventeenth International Congress of Americanists, City of Mexico, September, 1910, by Dr. Aleš Hrdlička, representative of Smithsonian Institution at Congress of Americanists at Buenos Aires, May 16 to 21, 1910, and at City of Mexico, September 7 to 14, 1910.

<sup>2</sup> Calancha, A. de. *Chronica moralizada del Orden de San Augustin en el Peru*, etc. 2 vols. Barcelona, 1639-1653.

Cieza, P. de. *La Chronica del Peru*. Sevilla, 1553. Anvers, 1554; English Transl., London, 1864-1883 (Hakluyt Soc. Pubs. Nos. 33 and 68).

Garcilasso de la Vega. *Historia general del Peru*. Cordova, 1616; London, 1688.

D'Orbigny, D. A. *Voyage dans l'Amerique meridionale*, etc. 9 vols., 4°. Paris, 1835-1847.

Rivero, E. de, and J. J. v. Tschudi. *Antiguedades Peruanas*. 4°. Vien, 1851; Transl. in English. 8°. New York, 1853.

Tschudi, J. J. v. *On the Ancient Peruvians*. 8°. London, 1884. *Travels in Peru*, etc. 8°. London, 1847.

languages and dialects and to have differed from each other in other respects, but their exact classification has not yet been determined, and from the standpoint of physical anthropology most of the groups are still enveloped in a haze of uncertainty.<sup>1</sup> Even ethnic units of such importance as the Quechua and Aymara are so little known physically that from the literature on the subject alone it would be impossible to form a clear notion as to their main characteristics.

The dearth of knowledge concerning the somatology of the peoples of Peru is due, on the one hand, to an almost complete lack of anthropological observations on the living, and, on the other hand, to the nature of the skeletal material which has thus far been collected. Not that the material is wanting, for there are many hundreds of Peruvian skulls scattered in our collections; but a very large majority of these skulls are more or less deformed, either artificially or accidentally, which renders them unsuitable for anthropological determinations, and other parts of the skeleton have been neglected. As to the skulls, there is no equally extensive territory in the world where cranial deformations, both intentional and unintentional, are as numerous as in Peru. Skulls of normal form from that country have actually thus far been rarities.

The accessions of Bolivian and Peruvian skeletal material in the principal American museums during the past few years have begun to shed more light on the physical characteristics of at least the Aymara and on a portion of the middle coast population of Peru. In consequence, it may be said to-day with comparative certainty that these two groups differ radically, at least so far as the cranial type is concerned; one (the Aymara) representing dolichocephalic, the other (middle coast) brachycephalic stock. Furthermore, we know to-day (due principally to Bandelier's collections) that the Aymara were in the main a people of relatively small stature, of only moderate muscular development, and often of rather small cranial capacity. The coast people from Ancon, Pachacamac, and one or two other localities, were also of rather low stature, but of somewhat stronger build, and had seemingly on the average a perceptibly larger skull. In both groups there was a relatively frequent occurrence of decidedly short and small-headed individuals. Beyond these few facts, however, things were problematical.

It was under these conditions that an opportunity, regrettably a

---

<sup>1</sup>For literature on the physical anthropology of Peru, see the end of this paper.

limited one, presented itself to the writer during the summer of 1910, to visit the Peruvian coast, and as the time at his disposal could not be extended, it was decided to visit the two most important districts on the coast, namely, Pachacamac, and Chan-chan or Gran Chimú. Due to exceptional circumstances, and to kind friends, especially Dr. Max Uhle, the Director of the Museo Nacional, at Lima, and Sr. D. Víctor Larco Herrera of the valley of Chicama, and also to the courtesy of the Peruvian Government, it was not merely possible to make these visits with despatch, but with unlooked for results. The writer was enabled to examine over thirty separate cemeteries, and to gather upwards of 3400 crania, with a large quantity of other skeletal parts. And more fortunately still, a large percentage of the gathered skulls, particularly from the Chimú district, are free from artificial deformation, so that they will show clearly the cranial type of the people occupying and congregating in these regions.

With this material, and the available collections from Ancon and other localities of the Peruvian littoral, it will now be possible to learn definitely the physical characteristics of the population of the Peruvian coast for a distance of over 400 miles, and establish a firm foundation for anthropological comparisons for the rest of the country.

This report, preliminary to a detailed study of the collections, will give only the general results of the writer's observations.

#### THE PACHACAMAC REGION

The great ruins of the temples and city of Pachacamac are situated at the lower end of the valley of Lurin, about 18 miles south of Lima, whence they are reached part of the way by trolley and part horseback. The location is an exceptionally favored one scenically. It comprises a cluster of moderate barren elevations, in proximity to the ocean and its rocky islands toward the west, the highly picturesque, green, narrowing mountainous valley on the south and east, and the desert plain and elevations to the north. The ruins themselves are extensive, as well as impressive in character. They comprise not only remnants of two of the most important of the pre-Columbian Peruvian temples and those of an interesting "Inca" convent, but also an extensive, somewhat fortress-like central structure, and several complexes of habitations spreading over the hill and slopes toward the west and northwest of the principal portion of the ruins.

For a detailed history and description of Pachacamac, the writer must refer to the work of Dr. Uhle.<sup>1</sup> Pachacamac was a famous religious center, comparable to the Egyptian Thebes or the Mohammedan Mecca. It originally contained a shrine of the "creator" god, Pachacamac, to which flocked "pilgrims coming from all parts of Peru, three hundred leagues or more" (Estete), and later, after conquest of the place by the Peruvians of the highlands, it also had a famous Temple of the Sun. It was at the same time a political center, the seat of a chief who ruled over the populous valleys of Lurin, Rimac, Chancay, Huacho, Supe, and Huanan (Garcilasso). Its decline dates from the year of the entrance of the Spaniards (1533) and the destruction by them of the venerated statue of the principal deity of the place (Pachacamac). In the early fifties of the sixteenth century the Augustinian monks transferred the town to the valley, and in the first part of the seventeenth century it was already a desolate pile of ruins (Calancha).

The inhabitants and the pilgrims of Pachacamac disappeared, leaving scarcely a trace in history, but they left behind a vast number of graves. Uhle estimates the total number of burials that existed within and about the ruins at between 60,000 and 80,000. There are six or more aggregations of the graves which may be regarded as distinct cemeteries, but burials, often two deep, existed apparently in every available part of the ground, within the temples, and even about and within the dwellings. The middle part of the region, bounded by the principal ruins, and especially the front of the Temple of Pachacamac, look like one vast burial place.

These cemeteries, with the exception of a smaller one, heretofore unknown, found by the writer on the south side, have been for many years, in common with the majority of other burial places in Peru, the prey of the peons, engaged in searching for pottery and precious metals, which are carried to Lima for sale. Considerable and scientifically conducted work has been done here by Uhle, particularly in the neighborhood of the temples, but the area of depredations is much greater. The result of the peons' work is the destruction of thousands of mummy bundles, and often of the mummies themselves, scattering of the bones, damage to the walls and foundations, and destruction or abandonment of everything that cannot be sold with profit. The skulls, bones, wrappings, damaged fabrics, broken jars, etc., are left to litter the surface of

---

<sup>1</sup>Uhle, M. Pachacamac. University of Pennsylvania Publications, Folio, Philadelphia, 1903.



the sands or are but partly buried by the earth thrown out from the excavations. On the writer's arrival, the place looked like a veritable Golgotha, or some great barbaric battlefield, with skulls and bones whitening the ground and ruins in every direction.

In one sense, of course, these conditions, however they may be regretted, proved of great service, giving an invaluable opportunity for investigation and collection of skeletal material. It made possible the examination on the spot of several thousands of individual skulls, a good proportion of which, however, were not removed because of damage done by the shovel or the elements.

As to collecting the skeletal remains, the writer at first hesitated, because the place was the focus of pilgrimages from a large part of ancient Peru and doubtless the last resting place of numerous visitors from distant sections. But examination of the material soon revealed such a degree of anthropological uniformity, that it was decided to make as extensive a gathering as possible. In consequence, all the well-preserved crania and a large part of the long bones, besides other skeletal parts, were gradually transported to Lima and there packed, with Doctor Uhle's kind help and supervision, to be eventually shipped to Washington. The total collection from this locality (now safely housed in the U. S. National Museum) numbers over 2200 crania, and several thousands of other bones that are of special value for anthropological determinations.

It is not as yet possible to speak of the full scientific value of the collection, but it is not readily overestimated. A number of the more important points which presented themselves during the preliminary work in the cemeteries, are as follows:

It was seen first of all that the remains were derived partly from mummies, which were especially numerous in the neighborhood of the Temple of Pachacamac, and in part from simple burials; also, that in rare instances cremation had been practiced.

The mummies were not only artificial as to their exterior, but there appeared evidence that the bodies themselves, or at least some of their parts, had been specially treated; thus a number of skulls, for the most part such as were damaged by wounds, were found filled with cotton.

All the larger cemeteries contained burials of males, females, and even children, but the last were nowhere very numerous and were in a decided minority near the temples. Males and also a few adult and elderly females were collected from about the Temple of the Sun. On the southeast terrace of this temple, Uhle reports<sup>1</sup> finding

---

<sup>1</sup> Pachacamac, p. 84.

a burial place containing some 90 graves. Forty-six skulls were actually discovered. Objects unearthed with the burials showed pure Cuzco forms of culture. All persons interred in this cemetery were women, and none of these had died a natural death, but were victims of strangulation. All were adults; one of the skulls showed gray hair. It is probable that the victims were strangled as sacrifices to the deity of the temple.

The people buried at Pachacamac were in general of moderate stature and physical development, with shorter and weaker individuals not infrequent.

The crania belong very largely to the brachycephalic type. An unusually high percentage, for Peru, of the crania are free from deformation and show their type perfectly.

The majority of the skulls present either simple occipital, or a fronto-occipital artificial compression, either of which, however, was seldom extreme and such as to prevent the recognition of the real type of the skull. Deformed crania were particularly frequent in the large burial ground in front, that is north, of the old temple (that of Pachacamac).

Besides the more rounded skulls there were found, particularly in front of the old temple, some crania purely dolichocephalic. These were plainly strangers to the original population, visitors or invaders, in all probability part of the Inca Peruvians. The majority of these narrower skulls were without any deformation, while a few showed some occipital compression of accidental or cradle-board origin.

Absolutely no specimen was seen which presented the Aymara type of deformation, which shows that these highland people did not visit the Pachacamac temples, and were not among the conquerors of the place.

A number of submicrocephalic and even microcephalic but otherwise normal crania were found. They have nothing in common with the small skulls of our idiots.

Finally, the long and other bones were found to offer many features of interest, some of which will be touched upon before the conclusion of this paper.

#### CHAN-CHAN<sup>1</sup> (GRAND CHIMU)

The second region visited by the writer exceeds probably in importance even that of Pachacamac. This was the district of Tru-

---

<sup>1</sup>Term used among the local natives and probably more correct than "Chimu."

jillo, with the ruins and cemeteries of Moche, Chan-chan or Gran Chimu, and the extensive, shallow valley of the Chicama.

This region was the main seat of the powerful Chimu people and abounds in their remains, ruins, huacas,<sup>1</sup> and cemeteries. The cemeteries are particularly numerous in the valley of the Chicama, and it was there, at the Estancia Roma, with Señor Victor Larco, the owner of a large part of the valley and one of the most enlightened Peruvians, that the writer made his headquarters.

The valley of Chicama is a large plain, but little elevated above the sea level, traversed by a small river, the Chicama, and bounded on all sides except the west and the northwest, in an irregular and broken way, by hills and mountains. It is incompletely separated from the Chan-chan plain by a mass of hills known as Cerro de Cabra. Over its surface are several isolated rocky elevations, and toward the northwestward it connects with sandy flats which extend along the coast in the direction of Pacasmayo.

The valley shows only a limited number of ruins which, however, include an interesting and relatively well-preserved fortress. These are a short distance south of Chiquitoi, one of the haciendas belonging to Señor Larco. Besides this, however, numerous old huacas are situated southeast, west, and northwest of Chiquitoi, and, lining the bases of the hills within the valley or projecting into the same, as well as in the sands of the sea-shore, there are many cemeteries of the former native population.

The Chicama cemeteries, like those of Pachacamac, have fallen a prey to the greed of the peon, and of the collectors who incite and profit by the peon, with the result that a large portion of the burials, in some places even all, have been destroyed. And, as at Pachacamac so here, the skulls and bones, and such objects as could not well be sold, were left everywhere strewn over the surface of the ground.

In this region the writer was able to remain for nearly two weeks and through the generous aid of Señor Larco, who provided him freely with men, animals, and even the use of his local railroads, he was able to visit over 30 of the cemeteries, to make examination of their skeletal contents and to gather much of the better preserved material. The bones that passed through his hands in this valley amounted to many thousands of specimens, and the collections comprise over 1100 crania, all the skeletal parts from two of the largest cemeteries, and many additional specimens, particularly long bones, from other burials.

---

<sup>1</sup> Mounds, constructed in the main of sun-dried bricks.

Among the cemeteries seen were some quite extensive ones including hundreds of graves, while others were small, with only a few score of burials. In a few cases the cemeteries were confluent, but for the most part they were separated, though the distance between them in some instances was no more than a few yards.

The examination of the skeletal material and other objects made it evident that some of the cemeteries in this valley were more modern than others; that different cemeteries served for the burial places of different groups, clans, or tribes of people; and that in numerous instances late and even recent intrusive burials in small number have taken place in the old cemeteries.

It was possible further to determine that the huacas which dot the lower part of the valley were nothing but construction-cemeteries of the old coast inhabitants. They are burial mounds built of sun-dried brick and earth, instead of earth alone as usually.

Furthermore, higher in the valley, the cemeteries were evidently those of the agricultural populations of the region, while along the coast they were those of fishermen.

The burials were for the most part simple, the body being laid in the ground wrapped in a blanket. More elaborate mummy-bundles, however, were occasionally encountered, but nothing was seen or learned that would point to intentional mummification of the body or any of its parts, as at Pachacamac. In rare instances, also, there was cremation.

As at Pachacamac, so here, too, burials in the contracted position were the rule.

An indisputable fact, applicable to all the Chicama cemeteries, is the relative scarcity of the remains of children. This is not due to the earlier decay of children's bones, for where such were found they were in just as good condition as those of the adults. It indicates either a general scarcity of children, separated interments, or a low infant mortality.

Besides the Chicama valley cemeteries, there were examined that of the Cerro de Virgen, near Chan-chan, as well as that about the Huaca of the Moon near Moche; and skeletal material was seen and in a small part collected from Chan-chan (Gran Chimú) itself.

The large cemetery about the Cerro de Virgen, was found to be a general burial ground for men and women, but there were seen no bones of children. The Huaca of the Moon appears to be mainly, if not entirely, an immense and archeologically important burial mound, built from sun-dried brick.

From the standpoint of physical anthropology, the examination of the skeletal material from the cemeteries in the district of Chiquitoi, and in the rest of the valley of Chicama, proved exceedingly interesting, for the majority of the people were found to have been of exactly the same type as those of the region of Pachacamac, that is, moderate in stature and brachycephalic.

However, it also became evident that the valley of Chicama was peopled, in the course of time, by more than one tribe of natives, though all or nearly all such tribes belonged probably to the same original stock. In some of the cemeteries were found only the undeformed and brachycephalic skulls, with those showing the accidental occipital flattening. In others there were a great preponderance of crania with highly developed occipital flattening and, mixed with these, were individuals with the fronto-occipital, or "flathead," intentional deformation. Finally, besides all these, and as at Pachacamac, there were encountered now and then individuals, or little groups of burials, with the dolichocephalic cranial type. The skulls of these were undeformed, or merely accidentally flattened in the occiput.

The more modern nature of some of the cemeteries and burials was shown especially by the pottery. In two examples in particular a vessel was seen which represented clearly conditions known only after the Spanish invasion.

There was again not a single skull which presented the Aymara type of deformation. It is certain that the Aymara proper did not reach either this valley or Pachacamac, either as pilgrims or as settlers after the conquering Incas. Squier mentions<sup>1</sup> having seen some skulls with the Aymara deformation, possibly the remains of soldiers, about the "Castillo" at Chan-chan, but the many ordinary cemeteries examined by the writer failed to show any such instances.

One or two facts were learned of special interest to archeology. Although only very limited excavations were undertaken, it was nevertheless possible to observe an association of certain types of pottery with definite types of people; and there is also a strong probability that differences in pottery existed at different periods of occupation of the valley. In general, the huacas and cemeteries near the sea and belonging to the original people of the valley, the old coast brachycephals, show pottery of simpler forms and more sombre colors than that found in some of the more inland burial

---

<sup>1</sup> Squier, E. G. Peru. 8°. New York, 1877, p. 123.

grounds. The ware also reminds one of some of the more northern types (pls. 1, 3, and 4).

In several of the more inland cemeteries, on the other hand, the differentiation of form in pottery and also its fineness have reached a high level. Finally, graves which appear to be more modern yield especially vessels with large, flaring borders characteristically decorated in red with various figures, some of which represent natural objects, as animals, warriors, etc., while others are apparently of complex symbolic meaning. Two graves, which yielded undeformed dolichocephalic skulls, contained highly ornamented pottery which probably belongs to the last mentioned period (pl. 2).

### CONCLUSIONS

Although the detailed study of the large series of specimens collected about Pachacamac and in the district of Trujillo will undoubtedly bring out numerous points which can scarcely as yet be foreseen, it is nevertheless possible from the preliminary examination of the material to state certain important facts bearing on the anthropology of the people represented by the collections.

In the first place, it can now be positively stated that the whole coast of Peru, at least from Pisco, well south of Pachacamac, to Pacasmayo, north of the valley of Chicama, was peopled by one and the same type of natives, the brachycephalic Indian of moderate stature. This bears out to a large extent the statement of Calancha (Vol. 2, chap. 29), that "the people of the coast, the Yungas, the dwellers of the plain and of the sandy desert, extended over all the district from Piura to Arica, 300 leagues in length and from 12 to 15 in breadth, according to the width of the coast land."

Chronologically, the earliest people in these regions were evidently those whose remains are found in the huacas and in some of the cemeteries where the pottery is of simpler, though often interesting forms. In these cemeteries metal is scarce and is principally gold.

These people were followed by others of the same fundamental physical type, but of modified habits, shown in part by the pronounced occipital head flattenings, which indicates the use of cradleboards to which the infant was tied for a prolonged period, and especially in the frequent practice of the intentional fronto-occipital skull deformation. These deformations represent apparently a change of habits with the times, or the immigration of people with such customs, rather than a manifestation of caste, though this may not have been without influence. Belonging to this period are large



TWO BOWLS FROM AN ANCIENT HUACA, NEAR THE HACIENDA CHIQUITOY, IN THE VALLEY OF CHICAMA. THE HUACA YIELDED ONLY BRACHYCEPHALIC SKULLS OF THE ORIGINAL CHIMU POPULATION (GREATEST BREADTH OF RIM, UPPER VESSEL 17.6 CM., LOWER 18.8 CM.)





cemeteries, in which the graves yield copper or bronze, with some gold, besides the before mentioned interesting pottery.

At about the time of the greatest prevalence of the deformed crania, there appear individual elements of the dolichocephalic type of the Indian. These are not local developments, for intermediary cranial forms, which in that case would be numerous, are lacking. Nor are they the Aymara who, though dolichocephalic, have since early Tiahuanaco times practiced the peculiar circular head deformation which now bears their name. It seems most probable that these dolichocephals came with or after the invading forces of the central or highland Peruvians and represent some of the more eastern or northern tribes of Peru. It was from the graves of such individuals that the writer obtained the ornamented pottery, shown in pl. 2, which is very distinct from any that occur in the old huacas and the coast burials.

The brachycephalic people seem to have been the first inhabitants of the coast, for there was absolutely no trace of any previous occupants; and the peopling of the coast by the brachycephals, judging from the nature and extent of the cemeteries, could not have been of any very great duration, not over some centuries before the arrival of the whites.

This old type of the coast people is fundamentally the same as a large portion of the inhabitants of Ecuador, Colombia, Panama, Central America, and Yucatan. The present native population was seen by the writer to show this type as far as the southern confines of the Peru of to-day. Farther southward, however, at Arica and along the Chilean coast, there is found an increasingly large proportion of dolichocephalic natives, and from the northern extremity of the central part of the Chilean coast southward this latter type is the only one encountered.

The preliminary examination of the skeletal material at Pachacamac and in the valley of Chicama has brought forth also some interesting evidence of medical nature.

There was not a single instance of rachitis.<sup>1</sup> In only one case (Chicama) was there seen a vertebra that may have been tuberculous, but the evidence was not entirely conclusive and the age of the grave was unknown. Only two burials were encountered in which the bones were surely syphilitic; but both of these graves were among the more recent, in all probability post-Columbian. Besides

---

<sup>1</sup> For comparison, see the writer's *Physiological and Medical Observations*, Bulletin 34, Bureau of American Ethnology, Washington, 1908.

these, there were collected about thirty long bones with more or less marked inflammatory alterations, which may be syphilitic, but the diagnosis cannot be made with certainty. A very large majority of the many thousands of long bones collected or examined showed no lesions whatever. With two uncertain exceptions no single skull out of the 3400 brought away, and the many additional ones that were looked over, presented a case of ulceration or a lesion which could be with confidence attributed to syphilis.

In the Chicama cemeteries, and to some lesser extent in those of Pachacamac, there was a marked rarity of fractures of the bones. The setting of the fractures was generally defective, indicating little if any surgical knowledge of these conditions. On the other hand, wounds of the skull, especially at Pachacamac, were very numerous.

Of trephining no positive example was discovered in the valley of Chicama and but one at Pachacamac; but there are several skulls in which it is impossible to say whether they present a partially healed wound from a club or a scar from trephining. It may also be that some specimens of trephining have been taken by the peons and brought to the local collectors; but numerous cemeteries were examined to which this could not apply.

From an archeological point of view the exploration brought out with special force the fact that the scientific value of such Peruvian collections of pottery and other antiquities as have been or are being made by the untrained local collectors, is very small. It was seen throughout that the peons gather indiscriminately what is salable and dispose of it now to this buyer and now to another according to the amount offered. These buyers make the collections for profit and though some of them are of fair and even professional education, they possess and care for no real archeological knowledge, and generally do not attempt in the least any type or even locality identification. In consequence, every large collection that has been sold from Peru by such collectors, represents a heterogeneous mass of articles proceeding from different epochs and even different peoples, and what it can amount to scientifically, under such circumstances, can easily be imagined. If ancient Peru is to be known properly, it will be necessary, as in Egypt, to re-dig the plundered cemeteries, establish the relations between the articles buried and the type and period of the people, and to collect and note every object the graves offer, not merely such as have commercial value. Perhaps on the basis of such work it will then become possible to properly classify the existing Peruvian archeological collections in our institutions.

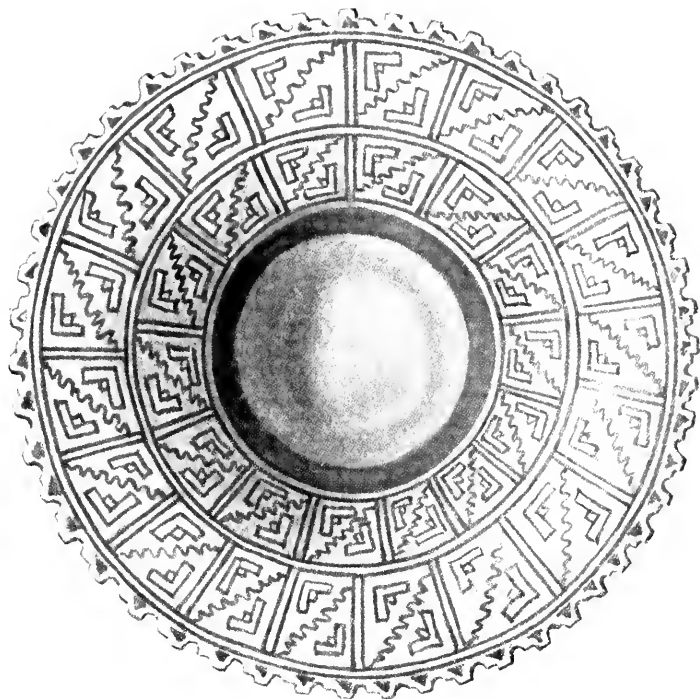

A JAR, 16 CM. HIGH BY 23.5 CM. BROAD, FROM ONE OF THE LESS ANCIENT GRAVES IN THE VALLEY OF CHICAMA, PERU. ONE OF THESE VESSELS OF SAME TYPE, RECOVERED FROM TWO NEIGHBORING GRAVES OF MEN. THE SKULLS OF BOTH WERE DOLICHOCEPHALIC AND FREE FROM ANY DEFORMATION.



One word more as to the skeletal material collected. The quantity of this material, which exceeds that from any other limited region in America or elsewhere, presents a reference series of the highest value, which will be freely open to scientific investigators who may wish to consult it.

To the above brief report, the writer has added a bibliography, which will enable the reader to appreciate what has hitherto been done in Peruvian anthropology. Many of the specimens mentioned separately, however, have been reported upon by two or even more writers, so that the total number of described crania is much smaller than would appear. Moreover, a great majority of the enumerated skulls were deformed; and the measurements or observations in many cases are very inadequate. Contributions of a more general nature, or such as apply to special features (trephining, etc.) are not included.<sup>1</sup>

The four plates of illustrations accompanying this paper show a number of the more interesting specimens from the small archeological collection made by the writer in the valley of Chicama while gathering the skeletal remains.

#### BIBLIOGRAPHY OF THE PHYSICAL ANTHROPOLOGY OF PERU

BLAKE, JOHN H. Notes on a Collection from the Ancient Cemetery at the Bay of Chacota, Peru. Eleventh Annual Report of the Peabody Museum of Archeology and Ethnology, Cambridge, 1878, pp. 277-304.

Notes and some measurements on 7 skulls from Chacota (near Arica).

BLAKE, CHARLES CARTER. On the Cranial Characters of the Peruvian Races of Man. Trans. Ethnol. Soc., N. S., Vol. 2, London, 1863, pp. 216-231. General classification.

BLAKE, C. C. On a Skull from the Chincha Islands. Journ. Anthr. Soc., Vol. 7, London, 1869, pp. lxxvii-lxx.

Notes, a few measurements and a discussion without importance.

BUSK, GEORGE. Remarks on a collection of 150 ancient Peruvian skulls, presented to the Anthropological Institute by T. J. Hutchinson.

In Hutchinson (Thos. J.): Two Years in Peru, Vol. 2, London, 1873, pp. 309-318.

Brief report on 43 skulls from Ancon, 60 from Pasmayo and 46 from Cañete valley.

<sup>1</sup> Historical, ethnographical and other works on Peru are given, to a large extent, but with numerous errors, in Dorsey (Geo. A.): "A Bibliography of the Anthropology of Peru," Field Columbian Museum Publication No. 23, Chicago, 1898.

- DAVIS, J. BARNARD. On Ancient Peruvian Skulls (with pl. 9). Journ. Anthr. Institute Great Britain and Ireland, Vol. 3, London, 1874, pp. 94-100.  
Also in Hutchinson (Thos. J.): Two Years in Peru, Vol. 2, 8°, London, 1873, pp. 318-320.  
No new observations on undeformed skulls. Contests, on the basis of a small series of deformed specimens, D. Wilson's opinion that there are in Peru, besides the naturally brachycephalic, also naturally dolichocephalic crania.
- DAVIS, JOSEPH BARNARD. Thesaurus Craniorum. 8°, London, 1867, pp. 240 *et seq.* Supplement, 8°, London, 1875, pp. 51 *et seq.*  
Principal measurements and some observations on 7 Aymara, 9 Quichua (without locality), 6 Arica, 3 Tucua, 8 Cerro di Oro, 4 Cañete valley, 10 near Callas, 3 Pachacamac, 2 Chinchá islands, and several other skulls from different localities.
- DORSEY, GEO. A. Crania from the Necropolis of Ancon, Peru. Proc. Amer. Assoc. Adv. Sci., Vol. 43, 1894, pp. 1-12.  
Notes and measurements on 123 skulls from Ancon.
- FLOWER, W. H. Catalogue of the Specimens . . . in the Museum of the Roy. Coll. of Surgeons of England. 2d ed., Vol. 1, 8°, London, 1907, pp. 281 *et seq.*  
Measurements and notes on 36 skulls from Pasmayo, 7 from Santos, 27 from Ancon, 30 from Cerro del Oro, 5 from Huacho, and a number from other localities.
- FORBES, DAVID. On the Aymara Indians of Bolivia and Peru. Journ. Ethnol. Soc., London, Vol. 2, 1869-1870, pp. 193-305.  
Observations and measurements on living Aymara.
- GOSSE, L. A. Dissertation sur les races qui composaient l'ancienne population du Perou. Mém. Soc. d'Anthr., Vol. 1, Paris, 1861, pp. 149-176.  
Criticism of Tschudi's statements.
- MEIGS, J. AITKEN. Catalogue of Human Crania in the Collection of the Academy of Natural Sciences of Philadelphia, 8°, Philadelphia, 1857.  
Notes and a few measurements on 14 skulls from Arica, 77 from Pachacamac, 44 from Pisco, 5 from Santa, 5 from Lima and 7 miscellaneous. Largely the same as in Morton's Crania Americana.
- MEIGS, J. A. Observations upon the Cranial Forms of the American Aborigines. Proc. Acad. Natur. Sci., Phila., 1866; separate 8°, pp. 1-39.  
Brief anthropometric notes on 104 crania from Pachacamac, 63 from Pisco, 31 from near Arica, 14 from near Lima, 9 from Paraccas bay, 8 from Santa, 2 from Payta, and 1 each from Gyamay and Chimu.
- MORTON, SAMUEL GEORGE. Crania Americana. Philadelphia, fol., 1839, pp. 96-133.  
Observations and measurements on 23 skulls from Pachacamac, 3 from near Arica, and 1 each from Gran Chimu and Santa.
- DE QUATREFAGES, A., and E. T. HAMY. Crania Ethnica. 4°, Paris, 1873-1882, pp. 467, 474-475.  
Brief notes and principal measurements on about 60 undeformed crania from Bolivia and Peru (Ancon, Chancaay, Pachacamac, etc.).



1. CLAY FIGURE FROM AN OLD NATIVE GRAVE IN THE VALLEY OF CHICAMA, PERU (MAXIMUM BREADTH OF HEAD, 6.8 CM.).  
2. CAST OF A FIGURE FROM A MOLD FOUND IN THE VALLEY OF CHICAMA, PERU (MAXIMUM BREADTH OF PART ABOVE THE HANDS, 5 CM.).





- RANKE, JOHANNES. Ueber Alperuanische Schädel von Ancon und Pachacamac. Abhandlungen der mathematisch-physikalischen Classe d. München. Academie der Wissenschaften, Bd. 20, 1899-1900, pp. 631-750, and plates.  
Report on 17 skulls from Pachacamac and 12 from Ancon.
- RETZIUS, A. Ueber die Schädelform der Peruaner. Ethnologische Schriften. Fol., Leipzig, 1864, pp. 94-98.  
Remarks on 8 skulls, 5 of which from Pisco, with measurements of two.
- RICCARDI, DR. PAOLO. Memoria del crani e Oggetti de gli antichi Peruviani appartenenti al Museo Civico di Modcna e al Museo di Anatomia Umana de la R. Universita di Modena. Archiv Anthr. & Ethnologia, Firenze, Vol. 16, 1886, pp. 305-405.  
Measurements and description of 17 skulls from Ancon, 1 from Arica; some data on additional 12, partly from Ancon, partly?
- RIVERO, M. E., and J. J. v. TSCHUDI. Antiguédades Peruanas. 4°. Vienna, 1851; Transl., 8°, New York, 1855.  
Includes dissertation on types of Peruvian crania. Repeated in several of Tschudi's works.
- RÜDINGER, N. Ueber künstlich deformirte Schädel und Gehirne von Südsee-Insulanern, Abh. bayer. Akad. Wiss., Vol. 11, Bd. 16, München, 1887.  
Includes report on two deformed skulls from Ancon, Peru.
- SCHREIBER, W. Beitrag zur Kraniologie der alperuanischen Schädel; Zeitschr. Morphol. Anthr., Vol. 12, Stuttgart, 1909, pp. 243-260.  
Observations and some measurements on 102 Bolivian and Peruvian skulls (Ancon 60, Puno 7, Arequipa 6, Arica 4, Cajamarquilla 2, Cochabamba 2, etc.).
- SERGI, G., and L. MOSCHEN. Crani peruviani antichi del Museo antropologico nella Università di Roma. 1887. 8°. Archiv Anthropol. & Ethnol., Firenze, Vol. 17, 1887, pp. 5-26.  
Notes and measurements on 21 skulls, 12 from the vicinity of Lima, 3 from Ancon and 6 from unknown localities on the west.
- STOLYHWO, C. Crânes Péruviens. Bull. Acad. Sciences de Cracovie, Fevrier 1906, pp. 109-138.  
Detailed measurements and notes on 92 skulls, nearly all deformed, localities not given.
- TSCHUDI, J. J. v. See Rivero and Tschudi.
- VIRCHOW, R. Crania Ethnica Americana, fol., Berlin, 1802.  
Measurements and description of 4 skulls, 2 from Paucartambo, 1 from Ancon and 1 from Iquique. Deformation. Exostoses in auditory canal.
- VIRCHOW, R. Schädel (Peruanische). In Reiss (W.) and Stübel's (A.): "Das Todtenfeld von Ancon in Peru," fol., Vol. 3, Berlin, 1887, Taf. 108-116.  
Illustration, notes on and measurements of 3 skulls from Ancon.

- VRAM, UGO G. Contributo all'antropologia antica del Peru. Atti della Societa Romana di Antropologia, Vol. 7, Roma, 1900-1901, pp. 44-93.  
Measurements and observations on 24 crania, 3 from Tacna, 3 from Caudivilla, 1 from Iquique and 17 derivation not stated. Also on some other parts of the skeleton.
- VRAM, U. G. Secondo contributo all'antropologia del Peru antico. (Craniologia: varietà craniche con speciale riguardo all'accrescimento del teschio). Atti Soc. Romana di Antrop., 7, 1901, pp. 67-69. Nineteen skulls, 15 from Ancon, 4 from Lima.
- WILSON, D. Physical Ethnology: The American Cranial Type. Seventeenth Ann. Rep. Smithsonian Inst. for 1862, Washington, 1863, pp. 249 *et seq.*  
Observations and some measurements on 39 Bolivian and Peruvian skulls, 14 from near Arica, 13 from Pachacamac, 4 from Titicaca, 2 from near Lima, 1 from Santa and 5 locality unknown.
- WYMAN, J. Observations on Crania and Other Parts of the Skeleton. Fourth Ann. Rep. Peabody Museum, Boston, 1871, pp. 10-24.  
Gives measurements and some observations on 6 skulls of Aymaras from Bolivia; and on 14 skulls from Casma, 16 from Amacavilca, 7 from Gran Chimu, 4 from Trujillo, 4 from Pachacamac, 5 from Cajamarquilla, Peru; all, or nearly all, deformed.
- WYMAN, J. Crania. Seventh Ann. Rep. Peabody Museum, Cambridge, 1874, pp. 8-15.  
Observations and some measurements on 330 skulls from Ancon.



1



2

1. PIECE OF A BLACK VASE FROM A GRAVE IN THE VALLEY OF CHICAMA, PERU (GREATEST BREADTH, 10.3 CM.). 2. TIGER'S HEAD IN CLAY, PAINTED WHITE AND RED, FROM AN OLD GRAVE IN THE VALLEY OF CHICAMA, PERU (GREATEST BREADTH, 7.4 CM.).







SMITHSONIAN MISCELLANEOUS COLLECTIONS

VOLUME 56, NUMBER 17

NEW SPECIES OF RODENTS AND CARNI-  
VORES FROM EQUATORIAL AFRICA

BY

EDMUND HELLER

Naturalist, Smithsonian African Expedition



(PUBLICATION 2006)

CITY OF WASHINGTON

PUBLISHED BY THE SMITHSONIAN INSTITUTION

February 28, 1911





# NEW SPECIES OF RODENTS AND CARNIVORES FROM EQUATORIAL AFRICA

By EDMUND HELLER

NATURALIST, SMITHSONIAN AFRICAN EXPEDITION

Further study of the mammals collected by the Smithsonian African Expedition has made necessary the description of twenty-one additional new forms which are dealt with in the present paper. The bulk of these new forms are from Rhino Camp, in the Lado Enclave. The specimens in the collection are the first which have been obtained in this unknown region. The Lado Enclave comprises the Nile watershed lying west of the Upper Nile (Bahr-el-Jebel). The precise geographical position of Rhino Camp is latitude  $2^{\circ} 55'$  north, on the west bank of the Nile some fifteen miles north of the station of Wadelai.

This paper is the thirteenth dealing with the results of the expedition. Incidentally a new *Lophuromys* from West Africa is here described.

## HELIOSCIURUS MULTICOLOR MADOGÆ, new subspecies

NIMULE TREE SQUIRREL

Type from Uma (50 miles north of Nimule), Uganda; adult male, number 164828, U. S. Nat. Mus.; collected by Kermit Roosevelt, February 11, 1910; Loring number, 8991.

*Characters*.—Size of *lateris*, but coloration distinctively buffy, the feet and under parts pure buffy yellow.

*Coloration*.—General coloration of upper parts mixed buffy, grayish, and black; individual hairs annulated, basally black, then ochraceous, followed by a broad band of black and then by a narrower subterminal band of grayish buff and terminated by a black tip. Eyes with a broad whitish eye-ring, cheeks and feet buffy. Tail annulated with buffy and black bands of equal width. Under parts and inside of limbs buffy; under side of tail basally, and anal region, tawny rufous in marked contrast to rest of under parts.

*Measurements*.—Head and body, 202 mm.; tail, 204; hind foot, 44. Skull: condylo-incisive length, 41.5; basilar length, 35; zygomatic breadth, 27.5; interorbital width, 13.5; length of nasals, 14; upper toothrow, 9; condylo-incisive length of mandible, 30.5.

This form of the widespread *multicolor* group is decidedly more buffy than its Lado ally, *lateris*, approaching more the color of *elegans* of Mr. Elgon. It is, however, distinctly smaller than this form and somewhat yellower.

The type is the only specimen in the collection. This was secured by Kermit Roosevelt in a clump of bamboo near the village of Uma.

### PARAXERUS KAHARI, new species

#### MERU FOREST SQUIRREL

Type from Meru Boma, northeast of Mt. Kenia, British East Africa; adult female, number 164203, U. S. Nat. Mus.; collected by Edmund Heller, September 24, 1909; original number, 1174.

*Characters*.—Like *ganana*, but tail without rusty median stripe; skull larger and proportionately broader.

*Coloration*.—General dorsal coloration buffy olive, darkest medially, becoming lighter and more buffy on the sides; individual hairs annulated by a narrow subterminal band of buff; overlaid by longer wholly black hairs; dark area of back bordered by an obsolete lighter stripe. Eye with a broad buffy ring. Cheeks and lower sides olive buff. Feet above ochraceous. Ears like dorsum. Tail mixed blackish and buffy, without marked darker cross-bands, the border light buffy; below more yellowish buffy. Under parts cream buff, the hair on median line buffy to the roots.

*Measurements*.—Head and body, 175 mm.; tail, 172; hind foot, 38. Skull: condylo-incisive length, 36.5; basilar length, 31.5; zygomatic breadth, 24.5; interorbital width, 11.5; length of upper toothrow, 7.3; condylo-incisive length of mandible, 27.5.

This race is closely allied to *ganana* of Jubaland. Specimens from the northern Guaso Nyiro River are exactly like the type in body coloration, but are somewhat smaller skulled. In coloration of upper parts this race is similar to *ochraceus* from Mombasa, but the coast species is at once distinguishable by its bright ochraceous under parts.

Among the Wameru tribe this squirrel is known as *kahari*.

### GRAPHIURUS PERSONATUS, new species

#### MASKED DORMOUSE

Type from Rhino Camp, Lado Enclave; adult female, number 164827, U. S. Nat. Mus.; collected by J. Alden Loring, January 11, 1910; original number, 8644.

*Characters*.—Dorsal coloration buffy, as in *lorraineus*, but size much less.

*Coloration*.—General dorsal colors buffy, overlaid by sepia, the buffy purer on sides and head and sharply defined against the gray of the under parts. Eye surrounded by a narrow black ring, which is continuous with a black streak to the tip of the snout. Cheeks creamy buff to level of eyes, where some fulvous separates it from the darker color of the upper parts; this light creamy color ascends behind ears and appears above them as a whitish tuft above each ear. Under parts grayish, washed with pale primrose yellow. Fore feet whitish, hind limbs broccoli brown like the tail; the toes and sides of the feet white. Tail above broccoli brown, the hairs lightening at tip and forming a light border; under surface lighter grayish or brown, but darkening toward tip, where it is the color of the upper surface.

*Measurements*.—Head and body, 82 mm.; tail, 63; hind foot, 14; ear, 10. Skull: condylo-nasal length, 23; zygomatic breadth, 13.5; length of nasals, 8.5; interorbital width, 4.3; length of upper tooth-row, 3.

Skull smaller than *lorraineus*, with shorter snout and smaller teeth. This species resembles *lorraineus* most closely in color and size. From *smithii*, which is about the same size, it differs widely in color, being buffy instead of grayish, with a distinct black eye-ring.

There is but a single specimen in the collection.

#### DENDROMUS SPECTABILIS, new species

##### NILE BLACK-FRONTED TREE MOUSE

Type from Rhino Camp, Lado Enclave; adult female, number 164815, U. S. Nat. Mus.; collected by J. Alden Loring, January 18, 1910; original number, 8783.

*Characters*.—Like *nigrifrons*, but lighter, the under parts pearl gray; feet whitish and the upper parts cinnamon fawn.

*Coloration*.—Color of upper parts cinnamon fawn, changing on lower sides and head to tawny buff, but not sharply defined against the pearl gray of the under parts; a wide black median dorsal line from shoulders to root of tail, widest anteriorly and narrowing gradually posteriorly; a median black spot on forehead midway between eye and ear. Snout lighter than rest of head, pure buffy yellow; base of whiskers and area between eye and tip of snout

blackish. A few white hairs at anterior base of ears and a larger white patch immediately below ear. Ears dark seal brown with a few silvery hairs on inside. Feet whitish. Lower parts pearl gray, the hair basally slate gray except on chin, throat, and under lip, which are white; median line of belly buffy. Tail dusky brown all around, essentially naked.

*Measurements*.—Head and body, 68 mm.; tail, 78; hind foot, 17.5. Skull: greatest length, 21; condylo-incisive length, 18.5; zygomatic breadth, 11.8; nasals, 7.5; diastema, 5; length of upper molar series, 3.1; condylo-incisive length of mandible, 12.

This species is allied to *nigrifrons*, but is readily distinguishable by its lack of buffy under parts and whitish feet. The series of eight topotypes shows very little variation in the color of the under parts.

### DENDROMUS LINEATUS, new species

#### LADO TREE MOUSE

Type from Rhino Camp, Lado Enclave; adult male, number 164816, U. S. Nat. Mus.; collected by J. Alden Loring, February 1, 1910; original number, 8921.

*Characters*.—Size of *jamesoni* and coloration of *ochropus*, with short ears and small skull and feet.

*Coloration*.—Upper parts tawny ochraceous, lighter on the sides, ochraceous where the color is well defined against the white of the under parts; head lighter than body, ears darker umber-brown; a wide black median stripe extending from the shoulders to the base of the tail. Fore feet and under parts pure white, the hair white to the roots. Tail bicolor, dusky brown above, white below.

*Measurements*.—Head and body, 65 mm.; tail, 87; hind foot, 16.5. Skull: greatest length, 20; basilar length, 14.5; condylo-incisive length, 17.2; zygomatic breadth, 10; nasals, 7.2; diastema, 5; length of upper toothrow, 3.5; condylo-incisive length of mandible, 11.5.

Twelve topotypes are in the collection. This series shows great variation in the distinctness of the black median dorsal stripe. In seven of these it is well defined, but in the remaining five there are all degrees of obsolescence down to specimens which show only a very faint trace.

*Dendromus jamesoni* of the Transvaal seems to be a close ally of this species, the chief differences separating the two forms being the lesser zygomatic width of the skull and the smaller ear of the

Nile species. This new form approaches *ochropus* of British East Africa closer than any other equatorial species. From this species it is readily separable by the white under parts and the bicolored tail, and also by slightly smaller skull and feet.

Two other specimens, both with stripe obsolete, are in the collection from Hoima and Gondokoro, Uganda.

**MUS MUSCULOIDES EMESI, new subspecies**

UGANDA PYGMY MOUSE

Type from Kabula Muliro, Uganda; adult male, number 164819, U. S. Nat. Mus.; collected by J. Alden Loring, December 27, 1909; original number, 8497.

*Characters*.—Dorsal coloration similar to *murillus*; hair of under parts white to the roots; body size less, with proportionately smaller skull.

*Coloration*.—Median dorsal area blackish, sparingly flecked with tawny; sides lighter and more tawny, the lower sides well defined against the white of the under parts by a narrow band of fulvous; dorsal pelage composed of black hairs annulated with tawny and of scattered wholly black hairs. Limbs like sides, ears and dorsal surface of tail blackish and clothed by minute hairs. Feet and under parts white, the hair white to the roots. Lower side of tail whitish.

*Measurements*.—Head and body, 71 mm.; tail, 51; foot, 13.5. Skull: greatest length, 20.1; condylo-incisive length, 18.5; nasal, 7.9; zygomatic breadth, 10.5; palatal foramina, 4.4; upper molar series, 3.5.

Skull similar to *murillus* and to the members of the *musculoides* group generally, having the masseter knob and anterior cusp of  $m^1$  little pronounced. This is a small white-bellied Nile race of the widespread *musculoides* group.

The series of nine topotypes shows considerable variation in dorsal coloration, ranging from the dark color of the type to a rufous phase. A specimen taken at Hoima, Uganda, is also referable to this new form.

**MUS WAMÆ, new species**

LONG-SNOUDED PYGMY MOUSE

Type from Kapiti Plains, British East Africa; adult female, number 161777, U. S. Nat. Mus.; collected by J. Alden Loring, May 6, 1909; original number, 6061.

*Characters.*—Long snouted like *sorellus*, but snout longer, the nasal bones measuring 8.5 mm. in length; upper parts much lighter, ochraceous-buff.

*Coloration.*—Median dorsal region from eyes to base of tail ochraceous-buff, heavily lined with black; snout and sides of head and body from level of eyes purer ochraceous-buff, changing to fulvous on lower sides where this color meets the white of the under parts. Ears hair brown, an ill-defined white spot at their base. Tail nearly naked; light brownish above, whitish below. Under parts, feet, and snout from level of nose, white; the hair white to the roots.

*Measurements.*—Head and body, 68 mm.; tail, 40; foot, 15. Skull: occipito-incisive (greatest) length, 20.5; condylo-incisive length, 20; length of nasals, 8.5; width of interorbital constriction, 3.2; length of palatal foramina, 5.4; width of brain case, 9; length of upper molar series, 3.6.

This species is closely allied to *sorellus*, with which it agrees in the peculiar elongate snout and straight projecting incisors, and also in general proportions of body. *Sorellus* is, however, only distantly related to *gratus*, but shows close relationship to *tenellus* in the formation of the short, narrowed mesopterygoid region, straight incisors and short tail. The group to which this species belongs represents the extreme divergence of the African *Leggadas* from the *Mus musculus* group in skull characters. This difference from the type species of *Mus* is most marked in the straight, projecting incisors, the elongate snout, the abbreviated, narrow, mesopterygoid fossa, and the minute coronoid process of the mandible. In the two latter characters these long-snouted African *Mus* approach somewhat the skull condition exhibited by *Acomys*.

This is rather a rare species, being represented by only one skin and one alcoholic specimen in the collection, which contains some hundred specimens of *Leggadas* from British East Africa.

#### MUS TENELLUS ACHOLI, new subspecies

##### LONG-SNOUTED PYGMY MOUSE

Type from Rhino Camp, Lado Enclave; adult male, number 164817, U. S. Nat. Mus.; collected by J. Alden Loring, January 13, 1910; original number, 8671.

*Characters.*—Coloration of *tenellus*, but size much larger, with large skull and proportionately short tail.

*Coloration.*—Median dorsal area mixed blackish and fulvous, the

snout and posterior rump more fulvous; sides pure fulvous, fairly well defined against the dark dorsal area and the white of the under parts; limbs fulvous like the sides. Ears blackish, covered sparingly by minute grayish hairs. A conspicuous white subaural patch. Feet and under parts white, the hair white to the base. Tail hair brown above, whitish below, closely covered by short stiff hairs which hide the annuli.

*Measurements.*—Head and body, 68 mm.; tail, 36; foot, 13. Skull: greatest length, 20.5; condylo-incisive length, 19; zygomatic breadth, 10; palatal length, 11; nasals, 8; length of upper molar series, 3.3; palatine foramina, 5.

This is a larger race of the *tenellus* group of the Lower Sudan, of which it is the extreme in size. From *suaelica* of the Kilimanjaro region this species differs widely in its much larger size and lighter coloration. The *tenellus* group is well defined by its long snout, projecting incisors, and short hairy tail. Three other specimens are in the collection from the type locality.

#### MUS GRATUS SUNGARÆ, new subspecies

##### KENIA PYGMY MOUSE

Type from West Kenia Forest Station, altitude 7,500 feet; old male, number 163487, U. S. Nat. Mus.; collected by J. Alden Loring, September 20, 1909; original number, 7425.

*Characters.*—Like *gratus*, but larger and lighter colored, with the central dark area better defined.

*Coloration.*—Median dorsal area from snout to base of tail mixed blackish and tawny in about equal parts; sides lighter, purer tawny, changing somewhat abruptly from the dark dorsal region; bounded on lower sides where the sides meet the white of the under parts by a fulvous line. Ears hair brown. Tail dark brown above, light brown below. Under parts and feet white, the hair white to the roots.

*Measurements.*—Head and body, 70 mm.; tail, 60; hind foot, 14.5. Skull: occipito-nasal (greatest) length, 19.5; condylo-incisive length, 18.2; basilar length, 15.5; zygomatic breadth, 10; length of nasals, 7.2; length of palatal foramina, 4.9; length of upper tooth-row, 3.5.

The material of this form in the collection is quite extensive. From the type locality there are six specimens, ten from Nyeri, seven from Waubugus, and eight from Naivasha. There is con-

siderable variation due to age, the young usually having the under parts quite buffy with the hair basally plumbeous, the pure white under parts being acquired only in old adults.

**MUS BELLUS GONDOKORÆ, new subspecies**

GONDOKORO PYGMY MOUSE

Type from Gondokoro. Uganda; adult male, number 164820, U. S. Nat. Mus.; collected by J. Alden Loring, February 25, 1910; original number, 9089.

*Characters*.—Smaller and lighter colored than *bellus*, with the subaural white spot well defined.

*Coloration*.—Median dorsal area from eyes to posterior rump hair brown, much lighter than the fulvous sides against which it is not well defined; snout, area about eye, limbs, and sides of body bright fulvous, sharply contrasted with the white of the under parts. Ears hair brown like back. Under parts, tip of snout, and lips and feet, white; the hair white to the roots. Tail brown above, lighter and whiter below.

*Measurements*.—Head and body, 60 mm.; tail, 43; hind foot, 13. Skull: greatest length, 17.6; condylo-incisive length, 16; zygomatic breadth, 9.4; nasal, 63; length of upper toothrow, 3.

The type is the only specimen in the collection.

**MUS BELLUS ENCLAVÆ new subspecies**

ENCLAVE PYGMY MOUSE

Type from Rhino Camp, Lado Enclave; adult male, number 164818, U. S. Nat. Mus.; collected by J. Alden Loring, January 10, 1910; original number, 8613.

*Characters*.—Size of *bellus*, but dorsal coloration much darker, the sides nearly as dark as the median region.

*Coloration*.—Upper parts blackish, the median region very sparingly flecked with tawny; sides more tawny, about equally mixed broccoli brown and tawny; snout dorsally blackish to tip, sides of head and snout tawny ochraceous, enclosing the eye on lower and posterior side only, the buffy eye-ring being broken above by the blackish suffusion of the head. Ears hair brown, with an indistinct white patch at their base. Tail dark brown above, lighter brownish below. Under parts from level of nostrils and feet white, the hair white to the base.



*Measurements*.—Head and body, 64 mm.; tail, 46; hind foot, 13. Skull: occipito-nasal (greatest) length, 18; condylo-incisive length, 16.5; length of nasals, 6.2; zygomatic breadth, 9.2; palatal foramina, 4.3; length of upper toothrow, 3.1.

This is a dark form of the widespread *bellus*. A series of thirteen from Rhino Camp show very little variation in the dark upper parts and are readily distinguishable from the light sided *bellus*, with its sharply defined dark dorsal area.

#### ARVICANTHIS PULCHELLUS MICROPUS, new subspecies

##### LADO STRIPED GRASS RAT

Type from Rhino Camp, Lado Enclave; adult female, number 164825, U. S. Nat. Mus.; collected by J. Alden Loring, January 24, 1910; original number, 8861.

*Characters*.—Closely allied to *massaicus*, but feet smaller and skull narrower.

*Coloration*.—General dorsal coloration bistre brown; the back marked by ten parallel lines of ochraceous spots, the central pair enclosing a median black dorsal line; sides lighter and more grayish, the spots light buffy. Feet and ears ochraceous. Tail blackish above, buffy on sides and below. Under parts cream buff, the hair uniform to the roots.

*Measurements*.—Head and body, 114 mm.; tail, 125; hind foot, 23. Skull: condylo-incisive length, 25; zygomatic breadth, 23.5; nasals, 11 x 3; diastema, 7; length of upper toothrow, 5.2; length of bullæ, 5; condylo-incisive length of mandible, 18.

There are eleven topotypes in the collection. In color these range from the grayish color of *massaicus* to a buffy tint similar to *ardeus*. A series from Uganda, taken along the route from Kampala to Butiaba, agree in the small size of their feet and in color with the types series. One specimen from Gondokoro has the spots so coalesced as to form lines as in *barbarus*, from which it is not distinguished except in the flatter skull and darker olivaceous body color.

#### ARVICANTHIS JEBELÆ, new species

##### WHITE-BELLIED GRASS RAT

Type from Rhino Camp, Lado Enclave; number 164826, U. S. Nat. Mus.; collected by J. Alden Loring, January 16, 1910; original number, 8762.

*Characters.*—Tail long, length equaling head and body or greater; nasal bones slightly concave along lateral edges; upper parts tawny ochraceous, lower parts white.

*Coloration.*—Upper parts tawny ochraceous, sparingly lined by black; purer ochraceous on sides, the color extending low down on sides of belly, but not sharply defined against the white under parts; pelage made up of narrowly seal brown tipped hairs with a broad band of ochraceous followed by slate to the base, the subterminal ochraceous band giving the pelage its color character; interspersed with these annulated hairs are longer black ones, which give the median dorsal area a lined effect. Eyes with an ill-defined buffy ring. Ears chiefly ochraceous, with a few black hairs about the base and on the inner side. Feet ochraceous. Tail with a broad dorsal band of black, the sides buffy and the lower surface whitish. Under parts white, the hair white almost to the roots, the base ashy gray; on chin, lips, throat, and thighs the hair is white to the roots.

*Measurements.*—Head and body, 140 mm.; tail, 150; hind foot, 29. Skull: condylo-incisive length, 31.5; greatest length, 35.5; zygomatic breadth, 17; interorbital constriction, 5; nasals, 12.5 x 4; length of upper row, 6.5; diastema, 8.2; length of palatine foramina, 5.5; length of bulke, 5.6; condylo-incisive length of mandible, 22.

This species occurs at its type locality with *rubescens*, both being forms of the *abyssiunicus* group. Both forms occur about Gondokoro also. The color differences from the dark-bellied, shorter-tailed *rubescens* are marked, but the skull differences consist of only average characters, such as the slight concavity to the edges of the nasal bones and the lack of beading to the anterior part of the interorbital region.

The type locality is represented by a series of twenty-four skins in which are specimens of all ages, but the variation in color is very little. The relationship between length of head and body and the length of the tail in this series shows the following proportion: tail longer than head and body, 8 specimens; tail equal to head and body, 6 specimens; tail slightly shorter than head and body, 10 specimens.

### LOPHUROMYS PYRRHUS, new species

LADO HARSH-FURRED MOUSE

Type from Rhino Camp, Lado Enclave; adult male, number 163823, U. S. Nat. Mus.; collected by J. Alden Loring, January 24, 1910; original number, 8853.

*Characters.*— Size large, skull long snouted; under parts bright orange rufous.

*Coloration.*— Upper parts uniform seal brown, becoming lighter only on lower sides where the coloration merges gradually from burnt umber to the cinnamon rufous of the belly. Feet lighter than back, vandyke brown. Tail quite blackish above and on the sides, the median under surface becoming lighter. Under fur of upper parts chestnut brown. Under parts from chin to base of tail bright cinnamon rufous, the color uniform to the roots of the hair.

*Measurements.*— Head and body, 136 mm; tail, 72; hind foot, 22.5. Skull: condylo incisive length, 31; basilar length, 27; zygomatic breadth, 15.5; interorbital width, 6.7; length of nasals, 14; length of upper toothrow, 5; condylo incisive length of mandible, 22.5.

Compared to *ansorgei* of the Kavirondo country of British East Africa, this form has the under parts much brighter red, the intensity of the red persisting through old age. *Sikapusi*, which has the same bright under parts, is a smaller race with a decidedly broader skull, with shorter, more convex nasal bones.

#### LOPHUROMYS NUDICAUDUS, new species

Type from Efulen, Bula country, Kamerun; adult male, number 125436, U. S. Nat. Mus.; collected by G. L. Bates, August 4, 1903; original number, 26.

*Characters.* Tail essentially naked, the annulations conspicuous; hair very harsh; skull with small flattened bulge and shortened brain case, the parietal bones short.

*Coloration.* Upper parts uniform seal brown, the hair uniform in color to the roots on median line, but lightening on sides. Feet vandyke brown. Under parts chiefly cinnamon rufous, the chest orange rufous. Tail quite naked, with distinct annulations, uniform deep seal brown in color.

*Measurements.* Total length, 166 mm; tail (skin), 60; foot, 18.5. Skull: condylo incisive length, 25; basilar length, 21; zygomatic width, 13.5 (approximate); interorbital width, 6.5; length of nasals, 11.6; length of upper toothrow, 4.4; condylo-incisive length of mandible, 17.3.

This is a small species of *Lophuromys* and differs from the other described species in its very much harsher fur and essentially naked tail.

## URANOMYS UGANDÆ, new species

## UGANDA BIG-TOOTHED MOUSE

Type from Kikonda, Uganda; adult male, number 164822, U. S. Nat. Mus.; collected by J. Alden Loring, January 2, 1910; original number, 8570.

*Specific characters.*—Most closely related to *ruddi* of the Mount Elgon District of British East Africa. Differs decidedly in the shorter and narrower skull and the shorter nasal bones. Size smaller and coloration of under parts without any pinkish wash.

*Coloration.*—Median portion of head and body above sepia flecked minutely with light brown, changing gradually on sides of head and body to a fulvous flecked with sepia. Under parts light grayish with a buffy wash. Fore and hind limbs with the color of the sides, except the feet, which are white. Tail dusky brownish above, becoming somewhat lighter below.

*Measurements.*—Head and body, 101 mm.; tail, 75; hind foot, 18; ear, 12. Skull: greatest length, 27; condylo-basal length, 25; zygomatic breadth, 14.5; nasals, 7.5 x 3.5; upper toothrow, 4.5; palatal foramina, 7.5.

The skull of this genus is very close to *Acomys* in structure, the palatal region especially being similar, but externally this species can be scarcely distinguished from *Lophuromys aquilas*, with which it is found associated. The collection contains but a single specimen. The teeth in this individual are quite worn, so that the tubercular structure cannot be made out. Compared with skulls of equal age of *Lophuromys* and *Acomys*, the  $m_3$  is found to lack the minute posterior median cusp which is found in both these genera. The structure of the floor of the skull closely resembles *Acomys*. The depressions marking the termination of the bony palate are, however, much deeper and have prominent margins, the interpterygoid fossa is wider and has parallel sides and blunt bead-shaped pterygoid processes. The mandible resembles more that of *Lophuromys* in the shape of its coronoid process, which is long and slender and very different from the minute projection which is found in *Acomys*. The condylar process is considerably larger than in either *Lophuromys* or *Acomys*. The most marked difference, however, is the prominence given to the incisor capsules. In this genus the capsule forms a prominent shelf-like projection midway between the coronoid and the condylar processes. The incisor condyle of *Acomys* and

*Lophuromys* is scarcely perceptible on the surface of the posterior portion of the ramus. This genus has the external characters of *Lophuromys* with the palatal skull formation of *Acomys* and distinctive projecting incisors and marked mandibular characters.

**ACOMYS HYSTRELLA, new species**

GRAY-BACKED SPINY MOUSE

Type from Nimule, Uganda; adult female, number 164821, U. S. Nat. Mus.; collected by J. Alden Loring, February 4, 1910; original number, 8929.

*Characters*.—Size large; tail three-fourths head and body; dorsal coloration drab gray with fulvous sides; nasal bones short.

*Coloration*.—Median dorsal region from the snout to the base of the tail drab-gray, this color merging gradually into the fulvous of the sides; fulvous of cheeks, lower sides, and legs sharply defined against the white of the under parts. Spinous hair of sides annulated, the extreme tip seal brown, succeeded by a broad band of fulvous, which is followed by cinereous gray to the base; this annulation is not perceptible in the darker spines of the back, the sub-terminal band of drab-gray being nearly as dark as the tips. Feet white. A small white spot below the ear. Ears smoky-brown clothed with a mixture of minute brownish and silvery hairs. Tail sharply bicolor; above lighter gray than the back, below whitish. Under parts, including upper lips and feet, white, the hair white to the roots.

*Measurements*.—Head and body, 111 mm.; tail, 81; hind foot, 16; ear, 15. Skull: greatest length, 28.3; basilar length, 22; zygomatic breadth, 13.2; nasals, 10.5 x 3.5; interorbital constriction, 5; length of palatine foramina, 6.7; length of upper toothrow, 4.5.

From the Somali species, *mullah*, this species differs in its smaller size, more fulvous sides, and shorter tail and nasal bones. The fulvous sides also distinguish it from the grayish *cahirinus* of Egypt, from which it further differs by larger skull and acutely pointed mesopterygoid fossa and smaller bullæ.

**DASYMYS ORTHOS, new species**

NYANZA SWAMP RAT

Type from Butiaba, Albert Nyanza, Uganda; adult male, number 164824, U. S. Nat. Mus.; collected by J. Alden Loring, January 1, 1910; original number, 8601.

*Characters*.—Antorbital plate with a straight anterior margin, with scarcely any concavity; bullæ small, coloration brownish; size large.

*Coloration*.—General dorsal coloration Prout's brown, becoming grayer on the sides and merging gradually into the olive-yellow wash of the gray under parts. Dorsal pelage made up of long black hairs which overlay the nearest shorter ones, which are terminally seal brown, then broadly tawny and basally slate. Limbs light wood brown. Tail showing very little hair, the annulation conspicuous, color broccoli brown.

*Measurements*.—Head and body 160 mm.; tail, 156; hind foot, 32. Skull: condylo-incisive length, 36.5; zygomatic breadth, 18.5; nasal, 13.5; palatal foramina, 8; length tympanic bullæ, 5.6; length upper toothrow, 7.3; diastema, 11.2; condylo-incisive length of mandible, 26.

This species is a much browner species than *medius*, with larger body size. The skull differs decisively from a large series of *helukus* from British East Africa in its straight-edged antorbital plate, which is scarcely more angulated at its upper edge than in *Epimys alexandrinus*.

There is one other specimen from Butiaba in the collection, and a third from Rhino Camp.

#### DASYMYS SAVANNUS, new species

##### KENIA SWAMP RAT

Type from Fort Hall, British East Africa; adult female, number 164471, U. S. Nat. Mus.; collected by J. Alden Loring, October 28, 1909; original number, 8182.

*Characters*.—Coloration umber-brown, skull with antorbital plate much angulated and produced, giving the antorbital vacuity great depth; size smaller than in *helukus*; tail essentially naked.

*Coloration*.—Upper parts umber, overlaid medially with black, the individual hairs tawny-ochraceous, with dark brown tips and slaty bases mixed with longer black hairs. Sides lighter, purer ochraceous, becoming more grayish where they meet the olive-gray wash of the lower parts. Feet pale brown. Ears hair brown, clothed with minute grayish hairs. Tail like the ears in color, but quite naked, with the annuli showing conspicuously.

*Measurements*.—Head and body, 156 mm.; tail, 146; hind foot, 29.5. Skull: condylo-incisive length, 37.5; zygomatic breadth, 19;

nasal, 14; palatal foramina, 8.5; length of bullæ, 6; upper tooth-row, 7.5; diastema, 12.5; condylo-incisive length of mandible, 28.

This species is very much browner than *helukus*, with a less hairy tail in old age, and smaller body size. The angle of the antorbital plate is much more pronounced than in any other specimen in the collection. Interorbital region narrow, the beads on margin much raised and leaving a deep median groove.

A large series of specimens show the age differences in skulls to be great. The interorbital region changes from a flat, weakly beaded condition to a narrow, deeply concave affair with high beads. Bullæ in youth high and rounded, becoming in age flat and broad, antorbital plate less concave in young.

### MUNGOS SANGUINEUS ORESTES, new subspecies

#### KENIA FOREST MUNGOOSE

Type from west slope of Mt. Kenia, altitude 8,500 feet; adult male, number 164152, U. S. Nat. Mus.; collected by J. Alden Loring, October 12, 1909; original number, 7934.

*Characters*.—Much darker and larger than *sanguineus*, with black predominating on the dorsal surface; skull larger and wider zygomatically.

*Coloration*.—Median dorsal area from snout to tip of tail blackish; top of head and tip of tail wholly black; back and sides mixed tawny and black, the black predominating; feet like back, only the toes black; sides of face black like the crown. Under parts mixed tawny and dark brown, the tawny predominating.

*Measurements*.—Head and body, 300 mm.; tail, 282; hind foot, 59. Skull: condylo-basal length, 65; palatal length, 34; zygomatic breadth, 34.5; width of brain case, 26.5; greatest diameter of pm<sup>4</sup>, 8.

The series of six topotypes shows considerable variation. The darkest one has the head feet and median line of the back wholly black. The lightest one is somewhat darker than normal specimens of *sanguineus*. This new race is nearest to *proteus* of Mt. Ruwenzori, which lives in very similar environment. It has a longer tail and larger skull, and is much less blackish.

**CROSSARCHUS FASCIATUS COLONUS, new subspecies**

## EAST AFRICAN BANDED MUNGOOSE

Type from the Southern Guaso Nyiro River, Sotik District, British East Africa; adult female, number 162132, U. S. Nat. Mus.; collected by Edmund Heller, June 21, 1909; original number, 6396. J. Alden Loring.

*Characters.*—Size and proportions as in *macrurus*, but coloration much grayer, the rufous of the shoulders replaced by buffy gray and the feet seal brown.

*Coloration.*—General dorsal coloration buffy grayish, lined everywhere with blackish; the posterior back and rump marked by eleven dark cross bands which are well defined only on back, being obsolete on the sides. Separating the broad dark cross bands are narrower light bands of buffy, which on median line become ferruginous. Shoulders and limbs uniform in color with the general body color, the feet and the muzzle dorsally from the level of the eyes dark seal brown. Tail like body color, the terminal one-fourth blackish. Under parts with an ochraceous wash, the hairs basally dark brown; throat lighter buffy, the chin and upper lip bright tawny, in marked contrast to rest of under parts.

*Measurements.*—Head and body, 380 mm.; tail, 260; hind foot, 92. Skull: condylo-basal length, 75.5; basal length, 71; zygomatic breadth, 42.5; palatal length, 39; greatest diameter of pm<sup>4</sup>, 7.

This East African veldt race of the banded mongoose is a much grayer and lighter colored animal than *macrurus* of Ruwenzori and Uganda. The rich rufous suffusion of the shoulders and the black feet of the latter are wanting, the body color being quite uniform and the black replaced by brown.

These mongooses are often met with on the grassy plains of the Sotik country, where they live in colonies in burrows on the open veldt. They, however, do not stop long in any locality, but move about in small packs of ten to twenty individuals, which take up a temporary abode in any nest of burrows which they find convenient. From our observations it was apparent that they do not remain more than a day or two in any one set of burrows.







SMITHSONIAN MISCELLANEOUS COLLECTIONS

VOLUME 56, NUMBER 18

BIBLIOGRAPHY OF THE  
SCIENTIFIC WRITINGS OF R. E. C. STEARNS

BY MISS MARY R. STEARNS

WITH ONE PLATE

WITH BIOGRAPHICAL SKETCH BY

WILLIAM H. DALL



(PUBLICATION 2007)

CITY OF WASHINGTON  
PUBLISHED BY THE SMITHSONIAN INSTITUTION

1911

**The Lord Baltimore Press**  
BALTIMORE, MD., U. S. A.





ROBERT EDWARDS CARTER STEARNS  
1827-1909

# BIBLIOGRAPHY OF SCIENTIFIC WRITINGS OF R. E. C. STEARNS

BY MISS MARY R. STEARNS

(WITH ONE PLATE)

## I. BIOGRAPHICAL SKETCH OF ROBERT EDWARDS CARTER STEARNS<sup>1</sup>

BY DR. W. H. DALL

Dr. Robert Edwards Carter Stearns died at Los Angeles, Cal., July 27, 1909, in his eighty-third year. He was a native of Boston, Mass., a son of Charles Stearns, and was born February 1, 1827. He was educated in the public schools, followed by a course of mercantile training, and from his earliest years evinced a deep love of nature, fostered by his father, with whom similar tastes led to a degree of comradeship in rambles and hunting expeditions which he always remembered with appreciation. The boy had an unusual artistic ability, and, though his early avocations were services in a bank and on a farm, when only twenty-two years of age he painted a panorama of the Hudson River from the mouth of the Mohawk to Fort William, which was sold and exhibited. He turned his attention to mining, explored the coal fields of southern Indiana, and in 1854 was appointed resident agent of several copper mines in northern Michigan, on Lake Superior. In 1858 he went to California, where he became a partner in a large printing establishment of a brother-in-law of his wife, in San Francisco. This firm published the *Pacific Methodist*, a weekly religious paper, and in the troubled times preceding the civil war the reverend editor of this journal was obliged to visit the east. Stearns was requested to fill his place during his absence. The fate of California hung in the balance, many of the immigrants from the southern states urged independence for that territory when hostilities broke out. Stearns took the responsibility of making his paper an enthusiastic advocate of the Union cause, and to this call and the eloquence of Thomas Starr King, old Californians believed the decision of the people to

<sup>1</sup> Printed also in *Science*, N. S. Vol. 30, No. 765, Aug. 27, 1909, pp. 279-80.

stand by the Union in that struggle was due in no small degree. Through the influence of Justice Field, Stearns was appointed deputy clerk of the supreme court of California in 1862, a post which he resigned in the following year to accept the secretaryship of the State Board of Harbor Commissioners, which he was obliged to resign some years later on account of ill health. Coming to the east, he made one of a party, comprising besides himself the late Dr. William Stimpson and Col. Ezekiel Jewett, for the exploration of the invertebrate fauna of southwestern Florida, during which large collections were made for the Smithsonian Institution. He returned to California, and in 1874 was elected secretary of the University of California, being the business executive of that institution under the presidency of the late Dr. Daniel C. Gilman. He served in this capacity for eight years with great approval, and, when ill health again obliged him to retire from service, the university as expressive of their sense of his services to the cause of education in California, and in recognition of his scientific attainments, conferred upon him the degree of doctor of philosophy. Returning to the east after the death of Mrs. Stearns, he was engaged in researches for the U. S. Fish Commission in 1882, was appointed paleontologist to the U. S. Geological Survey by Major Powell in 1884, and assistant curator of mollusks in the National Museum by Professor Baird. His collection of mollusca was acquired by the museum. Age and infirmity obliged him to return to the more genial climate of California in 1892, where he settled in Los Angeles, continuing, as his strength permitted, his researches into the malacology of the Pacific coast. He married March 28, 1850, Mary Anne Libby, daughter of Oliver Libby, of Boston, and is survived by a daughter.

Dr. Stearns was an earnest student of mollusks from boyhood; his early experience led him to interest himself in horticulture and landscape gardening, and his ability in this line is attested by the beauty of the university grounds at Berkeley, which were developed under his superintendence. His knowledge of the Pacific coast mollusca was profound, and a long list of papers on this topic and on the shells of Florida was the result. He also contributed many papers on various branches of horticulture and gardening to the California periodicals devoted to this subject. He was an enthusiastic supporter of the California Academy of Sciences in its early days, and, after the earthquake of 1868, when disaster threatened the society, he, with Professor J. D. Whitney and a few other friends, stood between it and dissolution. He was a member of



numerous scientific societies at home and abroad, and of the Sons of the American Revolution.

Dr. Stearns was a man of sanguine temperament, with a lively sense of humor and high moral character. His reading was wide, his learning never obtrusive, his interest in art, literature and all good causes, intense. He was a staunch friend and, for a righteous object, ever ready to sacrifice his own material interests. His services to Californian science will keep his memory green.

## II. LIST OF SCIENTIFIC PUBLICATIONS BY ROBERT EDWARDS CARTER STEARNS, PH. D.

Fellow American Association for the Advancement of Science; in 1869, chosen Corresponding Member of the Chicago Academy of Science; 1870, Corresponding Member Lyceum of Natural History in the City of New York, now the New York Academy of Science; September 17, 1873, elected Corresponding Member of Die Kaiserlich Königliche Zoologisch-Botanische Gesellschaft in Wien, Austria; 1877, Corresponding Member of Academy of Natural Science, Davenport, Iowa; 1887, Correspondent of the Academy of Natural Sciences in Philadelphia.

### CONCHOLOGY

1. List of Shells collected at Baulines Bay, California, June, 1866.—Proc. California Acad. Nat. Sci., Vol. 3, 1866, pp. 275-276. (C. M. I.) Additions to this list, *ibid.*, p. 291, 1867. (C. M. II.)
2. List of Shells collected at Santa Barbara and San Diego by Mr. J. Hepburn, in February-March, 1866, with Remarks upon some of the species.—Proc. California Acad. Nat. Sci., Vol. 3, 1866, pp. 283-286. (C. M. I.)
3. Remarkable Instance of Vitality in a Snail, *Helix veatchii*.—Proc. California Acad. Nat. Sci., Vol. 3, 1867, pp. 328-329.
4. Shells collected at Santa Barbara by W. Newcomb, M. D., in January, 1867.—Proc. California Acad. Nat. Sci., Vol. 3, 1867, pp. 343-345. (C. M. II.)
5. List of Shells collected at Purissima and Lobitas, California, October, 1866.—Proc. California Acad. Nat. Sci., Vol. 3, 1867, pp. 345-346. (C. M. II.)
6. List of Shells collected at Bodega Bay, California, in June, 1867.—Proc. California Acad. Nat. Sci., Vol. 3, 1867, pp. 382-383. (C. M. III.)
7. Shells collected by the U. S. Coast Survey Expedition to Alaska in the Year 1867.—Proc. California Acad. Nat. Sci., Vol. 3, 1867, pp. 384-385. (C. M. III.)

Also in Report of the Superintendent of the U. S. Coast Survey, for 1867, Appendix No. 18, pp. 291-2; Harford's List, which contains numerous typographical errors, which were not in the original.

<sup>1</sup>This and a number of the following papers were also issued under the title "Conchological Memoranda" by Doctor Stearns and will be referred to as "C. M." in the subsequent annotations. Since the dates of the memoranda were often prior to the publication in serials, it is important that they should be noted, and they are as follows: I, July 16, 1866; II, August 20, 1866; III, December 2, 1867; IV, 1869; V, 1870; VI, May 18, 1871; VII, Aug. 28, 1871; VIII, Oct. 14, 1871; IX, Sept. 4, 1871; X, June 5, 1872; XI, Jan. 17, 1873; XII, April 7, 1873; XIII, Oct. 18, 1875.

8. Shell Money.—*Amer. Naturalist*, Vol. 3, No. 1, March, 1869, pp. 1-5.  
Contains notes on West American shells, used as Money by the Aborigines of California.
9. The Haliotis, or Pearly Ear-shell.—*Amer. Naturalist*, Vol. 3, No. 5, July, 1869, pp. 250-256, with figures.  
Includes notes on California species.
10. Rambles in Florida.—*Amer. Naturalist*, Vol. 3, Nos. 6, 7, 8 and 9, 1869, 37 pp.  
Containing many notes on the Natural History, Ethnology, etc., of Florida, made during a visit in January-March, 1869, in company with the late Dr. William Stimpson and Col. Ezekiel Jewett.
11. On a new species of Pedipes, *P. naticoides*, from Tampa Bay, Florida.—*Proc. Boston Soc. Nat. Hist.*, Vol. 13, 1869, with figure. (C. M. IV.)
12. Description of a new species of Monoceros, *M. paucilirata*, from California, with Remarks on the distribution of North American species.—*Am. Jour. Conchology*, Vol. 7, 1871, pp. 167-171, with figures. (C. M. VI.)
13. Description of new California Shells; *Ocenebra gracillima* and *O. circumcirta*.—*Am. Jour. Conchology*, Vol. 7, for 1871, pp. 172-173, with figures, 1872. (C. M. VI.)
14. Description of a new species of Veronicella from Nicaragua, *V. olivacea*.—*Conch. Memoranda*, VIII, p. 1, October 14, 1871.  
This article, intended for the Boston Proceedings, was not printed in them or elsewhere except in this form.
15. On the Habitat and Distribution of the West American species of Cypræidae, Triviidae and Amphiperasidae.—*Proc. California Acad. Sci.*, Vol. 4, 1872, pp. 186-189. (C. M. IX.)  
Being corrections to Mr. Roberts' Catalogues of the "Porcellanidae" and Amphiperasidae.
16. Descriptions of new species of Marine Mollusks from the Coast of Florida.—*Proc. Boston Soc. Nat. Hist.*, Vol. 15, pp. 21-24, January 17, 1872.  
*Marginella (Glabella) opalina*, *Marginella (Glabella) aureocincta*, *Drillia ostrearum*, *Mangelia stellata*, *Architectonica tricarinata*, *Siphonaria naufragum*, and *Cerithidea turrata*.
17. Description of a new species of Mangelia, *Mangelia interlirata*, from California.—*Proc. California Acad. Sci.*, Vol. 4, 1872, p. 226, with figure. (C. M. X.)
18. Remarks on Marine Faunal Provinces on West Coast of America.—*Proc. California Acad. Sci.*, Vol. 4, 1872, p. 246. (C. M. X.)
19. Description of new Species of Shells from California, *Siphonaria Brannani* and *Truncatella Stimpsonii*.—*Proc. California Acad. Sci.*, Vol. 4, 1872, p. 249, with figures. (C. M. X.)
20. Notes on *Purpura canaliculata* of Duclos.—*Proc. California Acad. Sci.*, Vol. 4, 1872, pp. 250-251. (C. M. X.)
21. A partial comparison of the Conchology of portions of the Atlantic and Pacific coasts of North America.—*Proc. California Acad. Sci.*, Vol. 4, 1872, pp. 271-273. (C. M. X.)
22. The Californian Trivia, *T. Californica*, and some points in its Distribution.—*Amer. Naturalist*, Vol. 6, December, 1872, pp. 732-734, with figures.

23. Descriptions of a new Genus, *Laticribranchiaca*, and two new Species of Nudibranchiate Mollusks, *L. festiva* and *Triopa Carpenteri*, from the Coast of California.—Proc. California Acad. Sci., Vol. 5, 1873, pp. 77-78, with figures. (C. M. XII.)

24. Descriptions of new Marine Mollusks from the West Coast of North America.—Proc. California Acad. Sci., Vol. 5, 1873, pp. 78-82, with plate. (C. M. XII.)

*Conus Dalli*, *Ptychactractus occidentalis*, *Fusus* (*Chrysodomus*?) *Harfordii*, *Pleurotoma* (*Drillia*) *Montereyensis*, *Pleurotoma* (*Drillia*) *Hemphilli*, *Muricidea subangulata*, *Astyris variegata*, and *Pholas Pacifica*.

25. On Nymphagous Marine Animals; *Tercdo*, *Limnoria*, etc.—California Horticulturist, etc., May, 1873, with figures.

26. Remarks on the Nudibranchiate or Naked-gilled Mollusks, with several figures.—California Horticulturist, July, 1873.

27. Aboriginal Shell-money.—Proc. California Acad. Sci., Vol. 5, 1873, pp. 113-120, with plate.

Many California species mentioned.

28. Shells collected at San Juanico, Lower California, by William M. Gabb.—Proc. California Acad. Sci., Vol. 5, 1873, pp. 131-132.

29. Shells collected at Lereto, Lower California, by W. M. Gabb in February, 1867.—Proc. California Acad. Sci., Vol. 5, 1873, p. 132.

30. Descriptions of New Marine Shells, *Anachis semiplicata*, *Anachis acuta*, *Nitidella filosa* and *Clathurella Jewetti*, from the West Coast of Florida—Proc. Acad. Nat. Sci., Philadelphia, July 27, 1873, pp. 344-347, with figures.

31. On the vitality of certain Land Mollusks, *Helix Veatchii* and *Bulinus pallidior*.—Proc. California Acad. Sci., Vol. 6, 1875, pp. 185-187, with plate. Amer. Naturalist, Vol. 11, February, 1877, pp. 100-102. (C. M. XIII.)

32. Descriptions of new Fossil Shells, *Opatia varicostata* and *Opatia anomala*, from the Tertiary of California.—Proc. Acad. Nat. Sci., Philadelphia, 1875, pp. 463-464, with plate.

33. Description of a new species of Dolabella, *Dolabella Californica*, from the Gulf of California, with Remarks on other Rare or Little-known species from the Same Region.—Proc. Acad. Nat. Sci., Philadelphia, 1878, pp. 395-401, pl. 7.

34. Remarks on Fossil Shells from the Colorado Desert.—Amer. Naturalist, Vol. 13, 1879, pp. 141-154; several figures.

Personally read before the California Academy of Sciences.

35. Description of a new species or variety of Land Snail from California (*Helix circumcarinata*).—Annals New York Acad. Sci., Vol. 1, 1879, pp. 310-317, 3 figures.

36. Comments upon Mr. Calkins' "Marine Shells of Florida."—Science News, New York, April 15, 1879, 2 pp.

37. In the Matter of certain Badly-treated Mollusks.—Read before the California Acad. Sci., April 21, 1879. Separately printed, pp. 1-10, cover and title, with many figures.

38. Observations on Planorbis; are the Shells of Planorbis dextral or sinistral? On certain aspects of Variation in American Planorbis.—Proc. Acad. Nat. Sci., Philadelphia, 1881, pp. 92-110, with 27 figures.

39. *Mya arenaria* in San Francisco Bay.—Amer. Naturalist, Vol. 15, May, 1881, pp. 362-366.

40. On *Helix aspersa* in California, and the Geographical distribution of certain West American Land-snails, etc.—Annals New York Acad. Sci., Vol. 2, 1881, pp. 129-139.

41. Verification of the Habitat of Conrad's *Mytilus bifurcatus*.—Proc. Acad. Nat. Sci., Philadelphia, 1882, pp. 241-242.

42. On the History and Distribution of the Fresh-Water Mussels and the Identity of certain alleged Species.—Proc. California Acad. Sci., November 20, 1882, 21 pp., and figures.

Specially devoted to the Anodons of the Pacific States. Only the separates of this paper were published.

43. On the Shells of the Colorado Desert and the region farther East; Part 1. The Physas of Indio; Part 2. *Anodonta californiensis* in a new locality.—Amer. Naturalist, Vol. 17, Part 2, October, 1883, pp. 1014-1020, several figures.

Read before the California Acad. of Sci., June 5, 1883.

44. The Edible Clams of the Pacific Coast, and a proposed method of transplanting them to the Atlantic Coast.—Bull. U. S. Fish Com., Vol. 3, 1883, pp. 353-362, with several figures.

Letter to Prof. Spencer F. Baird, U. S. Fish Commissioner, October 14, 1882. *Glycymeris generosa*, *Savidonus nuttallii* and *Schizothoerus nuttallii*, specially mentioned.

45. Description of a New Hydrobioid gasteropod, *Pyrgula Nevadensis*, from the Mountain Lakes of Nevada, with remarks on allied species and the Physiographic features of said region.—Proc. Acad. Nat. Sci., Philadelphia, 1883, pp. 171-176, with figures.

46. Fresh-Water Pearl-mussels.—Mining and Scientific Press, San Francisco, April 7, 1883; Pacific Rural Press, April 14, 1883.

47. The Giant Clams of Puget Sound, *Glycymeris generosa* or *gcoduck*.—Forest and Stream, May 28, 1885.

Read at the Washington, D. C., meeting of the American Fisheries Society, April, 1885, and published in the report of said meeting.

48. The Helicidae of the John Day Fauna. Contained in Dr. Charles A. White's paper, "On Marine Eocene, Fresh-Water Miocene, and other Fossil Mollusca of Western North America."—Bull. U. S. Geol. Surv., No. 18, 1885, pp. 14-18, pl. 3.

49. The Teredo, or Ship-worm.—Amer. Naturalist, February, 1886, pp. 132-136, with figures.

From letter to Prof. Spencer F. Baird, Secretary of the Smithsonian Institution.

50. A Mammoth Land Snail.—Nautilus, Vol. 3, No. 3, p. 29, Philadelphia, July, 1889.

51. Notes on *Physa triticea* of Lea; its relations, and comments on the Variation, etc., of *Physac*.—Nautilus, Vol. 3, No. 5, pp. 49-51, Philadelphia, September, 1889.

52. *Helix* (*Stenotrema*) *hirsuta* Say, on the West Coast.—*Nautilus*, Vol. 3, No. 7, pp. 81-82, Philadelphia, November, 1889.

53. Critiques and Comments.—*Nautilus*, Vol. 3, No. 6, pp. 64-66, Philadelphia, October, 1889.

Reviews Mr. H. F. Carpenter's article on "The Shell-bearing Mollusca of Rhode Island," in the August, 1889, *Nautilus*.

54. Notice of and comments on the distribution of *Planorbis* (*Helisoma*) *bicarinatus* Say.—*West American Scientist*, San Diego, California, September, 1889.

55. Descriptions of new West American Land, Fresh-Water and Marine shells, etc. Scientific Results of Explorations by the U. S. Fish Commission Steamer "Albatross."—*Proc. U. S. Nat. Mus.*, Vol. 13, 1890, pls. 15-17, pp. 205-225.

Describes *Helix* (*Arionta*) *coloradoensis*, *H. (Arionta)* *magdalensis*, *Holospira semisculpta*, *H. arizonensis*, *Melania* (*Goaiobasis*?) *acutifilosa*, *Cyclothyca corrugata*, *Mitris* (*Costellaria*?) *nodocancellata*, *Venericardia barbarensis*, *Lucina acquizonata*, *Venus* (*Chione*) *effeminata*, *Venericardia ventricosa*, *Miodon prolongatus*, and *Periploma discus*. *Cyclothyca*, a new genus, is defined.

56. List of American Land and Fresh-water Shells received from the U. S. Department of Agriculture, etc.—*Proc. U. S. Nat. Mus.*, Vol. 15, 1891, pp. 95-106.

57. List of Shells collected on the West coast of South America, principally between latitudes 7° 30' S. and 8° 49' N., by Dr. W. H. Jones, U. S. Navy.—*Proc. U. S. Nat. Mus.*, Vol. 14, 1891, pp. 307-335.

58. Notes on the Sculpture of American Limnaeas, etc.—*Nautilus*, Vol. 4, No. 11, pp. 121-124, Philadelphia, March, 1891.

59. Edible Mollusks, etc., Here and There.—*Nautilus*, Vol. 5, No. 1, pp. 2-4, Philadelphia, May, 1891.

60. Edible Shell Notes, for the *Nautilus*.—*Nautilus*, Vol. 5, No. 3, pp. 25-26, Philadelphia, July, 1891.

61. *Patula strigosa* Gould, in Arizona.—*Nautilus*, Vol. 6, No. 1, pp. 1-2, Philadelphia, May, 1892.

62. Preliminary Descriptions of New Molluscan Forms from West American Regions.—*Nautilus*, Vol. 6, No. 8, pp. 85-89, Philadelphia, December, 1892.

*Uvanilla regina*, *Chlorostoma gallina* var. *multiflora*, *Bulimulus* (*Pleuropyrgus*) *Habeli*, *Onchidium Lesliei*, *Littorina* (*Tectarius*) *galapagiensis*, *Nitidella incerta*, *Littorina* (*Tectarius*) *atypus*.

63. Report on the Land and Fresh-water Shells of the Death Valley Expedition.—*North Am. Fauna*, No. 7, 1893, pp. 269-283. U. S. Dep. Agric., Division of Ornithology and Mammalogy.

*Amnicola micrococcus* Pilsbry, and *Fluminicola merriami* Pilsbry and Beecher, described and figured.

64. Description of a new species of *Nassa* (*Nassa brunncostoma*) from the Gulf of California.—*Nautilus*, Vol. 7, No. 1, pp. 10-11, Philadelphia, May, 1893.

65. Preliminary Report on the Molluscan species collected by the United States Scientific Expedition to West Africa in 1889-1890.—*Proc. U. S. Nat. Mus.*, Vol. 16, 1893, pp. 317-339.

66. On Rare or Little-known Mollusks from the West Coast of North and South America, with Descriptions of New Species.—Proc. U. S. Nat. Mus., Vol. 16, 1893, pp. 341-352, pl. 50.

*Onchidella Binneyi*, *Cypraea isabella-mexicana*, *Tectarius atyphus*, *Uvanilla regina*, *Chlorostoma gallina* var. *multiflora*, figured.

67. Report on the Mollusk-Fauna of the Galapagos Islands, with descriptions of new species. Scientific Results of Explorations by the U. S. Fish Commission Steamer "Albatross."—Proc. U. S. Nat. Mus., Vol. 16, 1893, pp. 353-450, pls. 51 and 52, map.

*Bulimulus (Pleuropyrgus) Habeli*, *Onchidium Lesliei*, *Onchidella Steindachneri*, *Nitidella incerta*, and *Tectarius galapagensis*, figured. A summary of previous work in the region is given.

68. Notes on Recent collections of North American Land, Fresh-water and Marine Shells, received from the U. S. Department of Agriculture.—Proc. U. S. Nat. Mus., Vol. 16, 1894, pp. 743-755.

69. Mollusk-Fauna of the Galapagos Islands.—West American Scientist, San Diego, California, April, 1894.

70. Triodopsis + Mesodon, distribution, etc.—Nautilus, Vol. 8, No. 1, pp. 6-8, Philadelphia, May, 1894.

71. *Urosalpinx cinereus* in San Francisco Bay.—Nautilus, Vol. 8, No. 2, pp. 13-14, Philadelphia, June, 1894; Vol. 12, No. 10, p. 112, February, 1899.

72. *Helix (Arionta) coloradoensis*—A New Locality.—Nautilus, Vol. 8, No. 3, p. 29, Philadelphia, July, 1894.

73. The Shells of the Tres Marias and other Localities along the Shores of Lower California and the Gulf of California, etc.—Proc. U. S. Nat. Mus., Vol. 17, 1894, pp. 139-204.

74. A New Variety of *Ocenebra circumtexta* Stearns (var. *aurantia*).—Nautilus, Vol. 9, No. 2, p. 16, Philadelphia, June, 1895.

75. *Purpura lapillus*, var. *imbricata*.—Nautilus, Vol. 10, No. 8, p. 85, Philadelphia, December, 1896.

Not Lamarck's "*imbricata*," but a finely imbricated form, detected by me sixty years ago in Boston.

76. *Uvanilla regina*—A new locality.—Nautilus, Vol. 11, No. 1, pp. 1-2, Philadelphia, May, 1897.

San Clemente Island, in the Santa Barbara Channel: previously on Guadaloupe Island.

77. Quarter-Decks and Jingles.—Nautilus, Vol. 11, No. 4, pp. 38-40, Philadelphia, August, 1897.

Local names given to *Crepidula fornicata* and *Anomia simplex*. The oystermen use these shells for the purpose of collecting the spat of *O. virginica* in the Eastern oyster beds.

78. *Modiola plicatula* Lamarck—An extinct locality.—Nautilus, Vol. 11, No. 9, pp. 102-103, Philadelphia, January, 1898.

The "Back-bay district," in Boston, the region referred to.

79. Description of new species of Actaeon, *A. Traski*, from the Quaternary bluffs of Spanish Bight, San Diego, California.—Proc. U. S. Nat. Mus., Vol. 21, 1898, pp. 297-299, with figure.

Also preliminary descriptions in Nautilus, Vol. XI, June, 1897, pp. 14-15.

80. Notes on *Cytherea* (*Tivela*) *crassatelloides* Conrad, with descriptions of many varieties.—Proc. U. S. Nat. Mus., Vol. 21, 1898, pp. 371-378, pls. 23-25.

The varieties named herein rest on the critical examination of over two thousand examples of all ages from specimens under an inch in length to extreme adults.

81. *Crepidula convexa* Say, var. *glauca* Say, San Francisco Bay.—Nautilus, Vol. 13, No. 1, p. 8, Philadelphia, May, 1899.

82. Natural History of the Tres Marias Islands, Mexico.—Nautilus, Vol. 13, No. 2, pp. 19-20, Philadelphia, June, 1899.

Also in Science, N. S., Vol. 10, July 28, 1899, No. 239, p. 121. A criticism of Nelson and Goldman's paper in N. A. Fauna, No. 14.

83. *Donax stultorum* Mawe: Conrad's species, *Cytherea crassatelloides*.—Nautilus, Vol. 13, No. 7, pp. 73-75, Philadelphia, November, 1899.

Contains bibliography of this species, with Dr. Pilsbry's assistance.

84. Abalone Fishery in California: Protective regulation.—Nautilus, Vol. 13, No. 7, pp. 81-82, Philadelphia, November, 1899.

85. *Modiola plicatula* Lamarck, in San Francisco Bay.—Nautilus, Vol. 13, No. 8, p. 86, Philadelphia, December, 1899.

86. List of Shells collected by Vernon Bailey in Heron and Eagle Lakes, Minnesota, with notes.—Proc. U. S. Nat. Mus., Vol. 22, pp. 135-138, April 7, 1900.

The variation in size, form, and sculpture of *Limnaea emarginata* is specially indicated.

87. Description of a new variety of *Haliotis*, *H. fulgens* var. *walballensis*, from California, with Faunal and Geographical Notes.—Proc. U. S. Nat. Mus., Vol. 22, 1899, pp. 139-142.

Also, Nautilus, Vol. 12, No. 9, January, 1899, pp. 106-107.

88. Mollusca associated with Mastodon remains.—Nautilus, Vol. 13, No. 9, pp. 100-101, Philadelphia, January, 1900.

Fresh-water species near Newburgh, N. Y.

89. Field-notes and Reminiscences [of a collecting trip on the coast of California with the late Dr. W. Newcomb].—Nautilus Vol. 13, No. 10, pp. 115-117, Philadelphia, February, 1900.

90. Exotic Mollusca in California.—Science, N. S., Vol. 11, 1900, No. 278, pp. 655-659.

91. Notes on the distribution of and certain characteristics in the *Saxidomus* of the West Coast.—Nautilus, Vol. 14, No. 1, pp. 1-3, Philadelphia, May, 1900.

Conspicuous hinge characters pointed out and compared.

92. The Fossil Shells of the Los Angeles Tunnel Clays.—Science, N. S., Vol. 12, 1900, No. 294, pp. 247-250.

A satisfactory determination of the form described as *Radiolites Hamlini*, awaits further material.

93. *Vallonia pulchella* Müll., in Los Angeles and elsewhere in California.—Nautilus, Vol. 14, No. 6, pp. 65-67, Philadelphia, October, 1900.

94. Fossil Land-shells of the John Day Region, with Notes on related living species.—Proc. Washington Acad. Sci., Vol. 2, 1900, pp. 651-660, pl. 35.

*Epiphragmophora fidelis antecedens*, *Polygyra Dalli*, *Ammonitella Yatesi praecursor*, *Pyramidula perspectiva simillima* described. See also No. 98 of this list.

95. An Abnormal Chiton.—*Nautilus*, Vol. 15, No. 5, pp. 53-54, Philadelphia, September, 1901.

*Ischnochiton (Maugrella) conspicuus* Cpr., with only six valves. A three-valved *Chiton* also mentioned.

96. Japanese Vivipara in California.—*Nautilus*, Vol. 15, No. 8, p. 91, Philadelphia, December, 1901.

*V. stelmaphora* Bgt., in San Jose.

97. The Fossil Fresh-water Shells of the Colorado Desert, their distribution, environment and variation.—*Proc. U. S. Nat. Mus.*, Vol. 24, 1901, pp. 271-299, pls. 19-24, and many figures in the text.

The figures of *Paludestrina protea* represent the more conspicuous aspects of variation, selected from over 40,000 specimens. Of the *Physas* more than 2000 were critically examined and compared.

Some idea of the abundance of these shells on the surface of the desert may be formed from the fact, that about a year after the above paper was published, I had in my hands and weighed a bag which contained fourteen pounds of *Paludestrina*, quite clean and free from sand or any other shells, except a few examples of *Ammicola longinqua*; in other words seven million three hundred and four individuals. See also Nos. 34, 43, ante.

98. Fossil Shells of the John Day Region.—*Science*, N. S., Vol. 15, January 24, 1902, No. 369, pp. 153-154.

*Helix (Epihragmophora?) dubiosa* nom. prov., *Pyramidula Le Contei*, and names provisionally *Limnaea maxima*. *Vide* previous paper, No. 48.

99. Unio Condoni in the John Day Beds.—*Science* (as above), March 7, 1902, p. 393.

Correction of omission in the preceding paper.

100. *Helix* var. *circumcarinata* and *Pyramidula Elrodi*.—*Nautilus*, Vol. 16, No. 6, pp. 61-62, Philadelphia, October, 1902.

101. *Pyramidula elrodi* and *Epihragmophora circumcarinata*.—*Nautilus*, Vol. 16, No. 7, pp. 83-84, Philadelphia, November, 1902.

102. Mollusks occurring in Southern California.—*Nautilus*, Vol. 16, No. 12, pp. 133-134, Philadelphia, April, 1903.

*Limax flavus*, *Limax maximus*, *Punctum conspectum* in Los Angeles mentioned

103. Clam-crows Crows.—*Nautilus*, Vol. 17, No. 10, p. 120, Philadelphia, February, 1904.

*Saxidomus giganteus* carried by the crows and sometimes dropped on the roofs in Victoria, B. C.

104. *Limax maximus* and other Slugs in California.—*Nautilus*, Vol. 18, No. 3, pp. 34-36, Philadelphia, July, 1904. See also Pacific Rural Press, San Francisco, of about the same date.

*Limax hewstoni*, *L. columbianus*, *L. californicus*, and *L. maximus* mentioned, and remedies suggested for a pest of slugs.

105. The Cambridge Natural History: Errata corrected.—*Nautilus*, Vol. 18, No. 5, p. 58, Philadelphia, September, 1904.

106. Abalones and the Earthquake.—*Nautilus*, Vol. 20, No. 12, pp. 135-136, Philadelphia, April, 1907.

107. Fossil Mollusca from the John Day and Mascall Beds of Oregon.—*Bull. Dep. Geology, Univ. California*, Vol. 5, No. 3, pp. 67-70.

*Helix (Epihragmophora?) dubiosa* nom. prov.; *Pyramidella (Oreohelix) Le Contei* n. s.; *Limnaea maxima* n. s.; described and figured.



108. On the Composition and Decomposition of Fresh-water Mussel Shells, with Notes and Queries.—Proc. Biol. Soc. Washington, June 12, 1907, Vol. 20, pp. 67-70.

*Anodonta Nuttalliana* and its varieties, of the West Coast, mentioned.

109. Among the Cephalopods.—Nautilus, Vol. 21, No. 2, p. 23, Philadelphia, June, 1907.

110. In re *Cytherea petechialis* of Carpenter's Mazatlan Catalogue.—Nautilus, Vol. 21, No. 3, p. 29, Philadelphia, July, 1907.

111. The U. S. Coast Survey Expedition to Alaska in the Year 1867.—Nautilus, Vol. 21, No. 3, pp. 29-31, Philadelphia, July, 1907.

#### COELENTERATA

112. Remarks on a New Alcyonoid Polyp, from Burrard's Inlet.—Proc. California Acad. Sci., Vol. 5, February 3, 1873; also separately, 8 pp.

113. Description of a new species of Alcyonoid Polyp, *Pavonaria Blakei*.—Mining and Scientific Press (San Francisco), August 9, 1873; also separately.

114. Description of a New Genus, *Verrillia*, and species, *V. Blakei*, of Alcyonoid Polyp.—Proc. California Acad. Sci., Vol. 5, August 18, 1873; Morning Call, San Francisco, August 12, 1873; Amer. Naturalist, Vol. 7, October, 1873, and Vol. 16, January, 1882.

115. Remarks suggested by Dr. J. E. Gray's paper on the "Stick Fish," in "Nature" [*Verrillia Blakei*], November 6, 1873.—Proc. California Acad. Sci., Vol. 5, March 16, 1874; also separately.

116. *Verrillia Blakei* or *Halipterus Blakei*.—Amer. Naturalist, January, 1882, pp. 55-56; also separately.

117. A new Virgularian Zoöphyte.—Mining and Scientific Press, San Francisco, October 13, 1883.

118. Description of a New Genus (*Radicipes*), and Species (*R. pleurocristatus*), of Alcyonoid Polyp, from Japanese waters, with remarks on the Structure and Habits of related forms, etc.—Proc. U. S. Nat. Mus., Vol. 6, 1883, pp. 96-101, and pl. 7.

119. Contributions to the Natural History of the Coelenterata; 4 pp., cover and title, Washington, D. C., October 26, 1889.

Historical Sketch and Bibliography of *Halipterus Blakei* and *Radicipes pleurocristatus*, with which copies of the previous papers were included under the same cover.

#### AGRICULTURE, ETC.

120. The Value of the Sugar Beet.—The Pacific, San Francisco, 1859.

If not the first, yet very nearly the first article suggesting the cultivation of the sugar beet as a profitable industry in California. No doubt too far ahead of the time. The first company was organized in 1869 and in November, 1870, the first beet sugar was made, the output the first season being 500,000 pounds. At the present date, 1903, the number of factories is eight with a capacity of 10,050 tons in twenty-four hours; "the capital invested in the factories will aggregate approximately \$12,000,000, to which may be added as a working capital and that invested in land, enough to raise the total amount invested by the companies themselves in the industry to about \$20,000,000." The population of the State being 1,485,053; the consumption of sugar estimated at 101,577,800

pounds and the production 160,000,000 pounds." (Geo. W. Shaw in Bulletin No. 149, Coll. of Agriculture, Univ. of California.)

121. A little more Lime.—The Pacific, San Francisco, 1859.

On the uses of Lime for various purposes in connection with farming.

122. Prolific Joint Corn.—California Horticulturist, November, 1873.

Notes of experiments with the above, and its value as compared with other varieties, for grain or fodder.

123. Ginseng the Chinese Panacea.—Cultivator's Guide, Sacramento, California, October, 1883.

Where found, its export value and possibilities in the way of trade and profitable culture.

124. The Sunflower.—Cultivator's Guide, Sacramento, California, December, 1883.

Its economic value in various ways indicated.

125. The Camass or Kamass.—Cultivator's Guide, Sacramento, California, January, 1884.

*Camass esculenta* the wild hyacinth of California and elsewhere; use by the Indians, etc.

126. Whitewashing Trees—uses of Lime, etc.—Cultivator's Guide, Sacramento, California, August, 1883.

Prevention of moss growth, sap-scald, and pestiferous insects.

127. Parasites in Domestic Animals.—Cultivator's Guide, Vol. 1, pp. 13-14, with figures, Sacramento, California, May 1, 1883.

The sheep rot, flukeworm, etc., their occurrence and metamorphoses.

128. On the care of young Fruit-trees, Orchards, etc.—Cultivator's Guide, Sacramento, California, June, 1883.

The selection of a site, planting out and protection against hot winds, extreme cold, and destructive animals.

129. Parasites in Drinking Water.—Cultivator's Guide, Sacramento, California, May, 1883.

130. *Dracaena Australis* for Basketry purposes, etc.—Pacific Rural Press, February 21, 1903.

The use of the long, slender tough leaves for basket-work, mats, and similar fabrics, is suggested.

#### FORESTRY, ETC.

131. On the Economic Value of certain Australian Forest Trees, and their cultivation in California.—Proc. California Acad. Sci., Vol. 4, 1872, pp. 236-241.

Also in Annual Report State Board of Health for 1872; the California Horticulturist and the California Farmer; fifteen hundred copies separately published in pamphlet form.

Review of the above in the *Nation*, New York, August 22, 1872, by Fred Law Olmsted. The foregoing, it was said at the time, gave an immediate impetus to the planting of these Australian species.

132. On the growth of certain California Forest Trees and the Meteorological inferences suggested thereby.

Read at the Cincinnati meeting of the American Forestry Association, April, 1882; printed separately, 8 pp. 8°.

Portions of above were read before the California Academy of Science, December 5, 1881.

133. Forest Tree Culture in California.—Review of the Decade, 1872-1882. Read at the Cincinnati meeting of the American Forestry Association, April, 1882; printed separately, 12 pp., 8°.

This and the preceding published in the Report of the Association for 1882.

134. The Mulberry as a Useful and Ornamental Tree.—Cultivator's Guide, Sacramento, California, August, 1883.

Methods of propagation and care; good varieties mentioned.

135. The Oriental Sycamore as a street tree.—Pacific Rural Press, San Francisco, December 20, 1902.

136. Eucalypts cultivated in the United States.—Science, N. S., Vol. 17, No. 439, 1903, pp. 858-860.

A review and in part, criticism of Prof. A. J. McClatchie's "Eucalypts cultivated in the United States," Bull. No. 35, Bureau of Forestry, U. S. Dep. Agriculture, 1903.

137. Eucalypts in the Philippines.—Science, N. S., Vol. 18, No. 457, 1903, pp. 439-440.

#### ETHNOLOGY, ETC.

138. Remarks on Pre-historic Remains in Florida.—Proc. California Acad. Sci., Vol. 4, March 4, 1872; also separately.

139. The Pectens, or Scallop shells.—Overland Monthly, San Francisco, April, 1873, Vol. 10, pp. 342-345.

As referred to in History and Poetry; also remarks on their Anatomy.

140. Aboriginal Shell-money.—Proc. California Acad. Sci., Vol. 5, July 7, 1873, with plate.

141. Aboriginal Shell-money.—Overland Monthly, San Francisco, September, 1873, with figures.

Also Globus, Braunschweig, Germany, of about same date; without credit.

142. Aboriginal Shell-money.—Amer. Naturalist, Vol. 11, June, 1877, pp. 344-350, with figures and plate.

143. Aboriginal Shell Ornaments, and Mr. E. A. Barber's paper thereon.—Amer. Naturalist, Vol. 11, August, 1877, pp. 473-474.

144. On certain Aboriginal Implements, from Napa County, California.—Amer. Naturalist, March, 1882, pp. 203-209, 9 figures.

Read before the California Academy of Sciences, October 19, 1881.

145. Ethno-Conchology—a Study of Primitive Money.—Rep. U. S. Nat. Mus., 1887, pp. 297-334, pls. 1-9, and numerous text-figures.

The various American and Indo-Pacific species of shells used as money or a medium in trade in past and recent times are mentioned. A lengthy review of the above, 30 pp. by Ed. Jardin, was published in Vol. 17 (2d Series) of the Bulletin of the Société Académique of Brest, in 1892.

146. On the Nishinam Game of "Ha" and the Boston Game of "Props."—Amer. Anthropologist, October, 1890, pp. 353-358, with figures.

Read before the Anthropological Society of Washington, D. C. The Nishinam game was played with acorns, the Boston game with the marine shells, *Cypraea moneta*.

## MISCELLANEOUS

147. Form of Seeds as a factor in Natural Selection in Plants.—Amer. Naturalist, July, 1879, pp. 411-420, several figures; also in Pacific Rural Press and mining and Scientific Press, San Francisco, of about same date.

Read before the California Academy of Sciences, July, 1879.

The changes in the Flora between the years 1858 and 1879 in the neighborhood of Berkeley, California, are pointed out.

The botanical forms mentioned are *Brassica nigra*, *Erodium cicutarium* and *E. moschatum*, *Geranium maculatum*, *Hordeum maritimum*, *Medicago denticulata*, *Centaurea melitensis*, *C. solstitialis*, *Madia sativa*, etc.

148. On the Botanical relations of *Physianthus albens*, the structure of its flowers, and their peculiarities as an Insect trap.—Pacific Rural Press, San Francisco, November, 1881, with several figures, under the title "A Moth-catching Plant."

Previously read before the California Academy of Sciences.

149. The Acorn-storing habit of the California Woodpecker, *Melanerpes formicivorus*.—Amer. Naturalist, May, 1882, pp. 353-357; also separately.

150. Instances of the effect of Musical Sounds on Animals.—Amer. Naturalist, Vol. 24, January, February and March, 1890. Also separately, 23 pp., cover and title.

Read before the Biological Society of Washington, D. C., May 1, 1886.

A lengthy notice of above by Catherine C. Hopley, in the Globe, London, England, April 14, 1890.

151. The Distribution of Species.—Forest and Stream, May 13, 1886.

Read before the American Fisheries Society, April 14, 1886.

152. On certain Parasites, Commensals and Domiciliaries in the Pearl oysters, *Meleagrinae*.—Ann. Rep. Smithsonian Inst. for 1886, Part 1, pp. 339-344, pls. 1, 3, 1889.

153. *Araujia albens* as a Moth-trap.—Amer. Naturalist, Vol. 21, June, 1887, pp. 501-507, with numerous figures.

Read before the Biological Society of Washington, D. C., February 19, 1887.

The names of the species of *Lepidoptera* and other insects entrapped are given.

154. On Xylophagous Marine Animals.—California Horticulturist, etc., May, 1873, with figures.

155. Zoölogical Scraps from a Californian Notebook.—Cultivator's Guide, Sacramento, California, July, 1883.

White beavers; a squealing Toad; Protective coloration of the Horned Toads; Sand-hill Cranes, mentioned.

156. On Accidentally introduced forms of Animals.—West American Scientist, February, 1891, pp. 107-109.

GENERA AND SPECIES NAMED FOR ROBERT EDWARDS  
CARTER STEARNS BY THE AUTHORS

Cetacean: *Grampus Stearnsii* DALL.

Fish: *Roncador Stearnsii* STEINDACHNER.

Recent Mollusks:

*Voluta (Scaphella) Stearnsii* DALL.

*Cylindrella Stearnsii* ARANGO.

*Lamellaria Stearnsii* DALL.

*Unio Stearnsiana* WRIGHT.

*Aesopus Stearnsii* TRYON.

*Helix Stearnsiana* GABB.

*Microphysa Stearnsii* BLAND.

*Bulimus (Anctus?) Stearnsianus* PILSBRY.

*Callocardia Stearnsii* DALL.

*Periploma Stearnsii* DALL.

*Mytilus Stearnsi* PILSBRY and RAYMOND.

*Paludestrina Stearnsiana* PILSBRY.

*Sportella Stearnsii* DALL.

*Ischnochiton Stearnsii* DALL (1902).

*Venericardia (Cyclocardia) Stearnsii* DALL (1902).

Fossil Mollusks:

*Scala Stearnsii* DALL.

*Bulimus Stearnsii* DALL.

*Vorticifex Stearnsii* WHITE, and

*Stearnsia*, WHITE, for a Generic form of Cretaceous Mollusk.

Coral: *Paracyathus Stearnsii* VERRILL.









SMITHSONIAN MISCELLANEOUS COLLECTIONS

VOLUME 56, NUMBER 19

# THE SILVER DISK PYRHELIOMETER

(WITH ONE PLATE)

BY

C. G. ABBOT

Director, Astrophysical Observatory of the Smithsonian Institution



(PUBLICATION 2008)

CITY OF WASHINGTON  
PUBLISHED BY THE SMITHSONIAN INSTITUTION  
March 31, 1911

WASHINGTON, D. C.  
PRESS OF JUDD & DETWEILER, INC.  
1911

## THE SILVER DISK PYRHELIOMETER

By C. G. ABBOT

DIRECTOR, ASTROPHYSICAL OBSERVATORY OF THE SMITHSONIAN INSTITUTION

(WITH ONE PLATE)

In 1902 the writer designed a mercury pyrhelimeter based on the fundamental device of Pouillet, as modified by Tyndall. This instrument was described in the *Annals of the Astrophysical Observatory of the Smithsonian Institution*, volume 2. As the measurements have gone on at Washington, Mount Wilson, and Mount Whitney for the determination of values of the solar constant of radiation, various alterations have seemed desirable, which led in 1909 to the form of instrument here described.

The silver disk, *a*, shown in cross-section, is bored radially with a hole to admit the cylindrical bulb of a thermometer, *b*. The hole in the disk has a thin lining of steel, so that a small quantity of mercury may be introduced without alloying the silver, in order to make a good heat conduction between the silver disk and the thermometer bulb. A soft cord soaked in shellac is forced down at the mouth of the hole to prevent the escape of mercury, and a ring of Chatterton wax is sealed over the outside of the cord to make the closure more perfect.

The thermometer, *b*, is bent at a right angle, as shown, in order to make the instrument more compact and less fragile. A nicked brass tube (shown partly cut away in the figure) supports and protects the thermometer. A slot is cut in the right-hand side of the support tube throughout almost its whole length to permit the reading of the thermometer. At the top of the support tube a short piece is removable, in order that heat may be applied to the overflow bulb of the thermometer, to dislodge mercury which sometimes collects there during transportation. The thermometer is graduated to tenths of degrees centigrade from  $-15^{\circ}$  C. to  $+50^{\circ}$  C. Two points,  $0^{\circ}$  and  $+50^{\circ}$ , are first marked on the stem by the makers, and then the thermometer is graduated by equal linear intervals without regard to the variations of cross-section of bore of the stem. Before insertion in the instrument, a careful calibration of the thermometer stem is made.

The silver disk, *a*, is enclosed by a copper cylindrical box, *c*, halved together for convenience in construction. Three small steel wires, not shown in the figure, support the silver disk. These wires lie in the plane of the center of the disk at  $120^\circ$  intervals apart. Midway between them are three brass screws, not shown, which may be screwed through the walls of the box, *c*, up to their heads. These screws in that position clamp the silver disk tightly. Their purpose is to prevent the breakage of the thermometer if jarred during transportation. These screws must be loosened during observations.

The copper box, *c*, is enclosed by a wooden box, *d*, to protect the instrument from temperature changes. This box is also halved together and fastened by long wood-screws, one of which is seen near the letter, *d*, in the figure.

Sunlight may be admitted through the tube, *e*. This tube is provided with a number of diaphragms,  $f_1 f_2 f_3$ , having circular apertures. The aperture,  $f_3$ , nearest the silver disk is slightly smaller than the others, and slightly smaller than the disk itself. Thus it limits the cross-section of the sunbeam whose intensity is to be measured. The entire interior of the tube, *e*, the box, *c*, and the silver disk, *a*, are painted dead black with lamp-black mixed in alcohol, with a little shellac added to cause the lamp-black to stick. To secure a fine, even coat, the mixture is filtered through cheesecloth before applying, and on the disk it is warmed with an alcohol lamp until the brush marks disappear.

A rotatable shutter, *g*, with three nicked parallel metal plates, *h h h*, is provided for cutting off the sunlight as desired. The top of the tube, *e*, carries a screen, *k*, large enough to shade the wooden box, *d*. This screen also supports the thermometer tube, and the axis of the exposing shutter just mentioned. A small hole in the part which supports the thermometer admits a little guiding beam of sunlight, *i*, whose use is to assure the observer that the instrument points towards the sun.

The pyrheliometer is carried upon an equatorial stand, as shown in the figure. A worm and wheel mechanism is provided for following the sun. No clockwork is needed, as it is sufficient for the observer to move the worm slightly two or three times a minute.

The purpose of the silver disk pyrheliometer is merely to furnish readings proportional to the intensity of radiation of the sun, and comparable one with another at all times and places, but not to furnish independent means of reducing these readings to true heat

units. Pouillet, it is true, determined the dimensions of his pyrheliometer, and from them reduced his results approximately to calories per square centimeter per minute. But owing to several uncertainties not necessary to mention here, it is not practicable to achieve sufficient accuracy in such standardizations of pyrheliometers of this type. They must therefore be regarded as secondary instruments, useful only for relative readings, unless standardized by comparison with true standard pyrheliometers. Such standardizations have been made at the Astrophysical Observatory.<sup>1</sup>

Regarding the silver disk pyrheliometers as secondary instruments, an abridged method of reading is possible, which materially reduces the labor of observation and reduction. In ordinary calorimetry the thermometer is read as frequently as possible, often at 10 or 20 second intervals, in order that a graphical representation of the whole march of temperatures may be made. In this way the most exact determination is possible of the rate of rise of temperature due to the source of heat itself, irrespective of cooling or warming due to the surroundings. In the use of the pyrheliometer as a secondary instrument the true value of the rate of rise of temperature due to solar heating is not material. If a simplified method of observation can furnish results which are under all circumstances greater or smaller by a constant fraction than the true rate of rise, such results are equally as valuable as the true ones would be. For the standardization constant of the instrument corrects such errors. By numerous experiments it has been shown that the short method of reading the instrument to be described below satisfies the condition just explained, well within the error of the observations, hence it has been adopted.

In order to promote pyrheliometric measurements of the solar radiation in other parts of the world, with instruments whose indications are quite comparable, Secretary Walcott loaned, in 1910, three silver disk instruments which were constructed at the cost of the Hodgkins fund and carefully standardized. These instruments were sent to Messrs. M. A. Rykatchew of St. Petersburg, J. Violle of Paris, and C. Chistoni of Italy. Unfortunately the first two mentioned were broken in transportation, but they have since been replaced. In the latest sendings the pyrheliometer proper is wrapped at its heavy end in cotton, and tied into its box in such a way that the projecting thermometer is wholly free, and could not possibly come in contact with any parts of the box. This box is enclosed in

---

<sup>1</sup> See Abbot and Aldrich: *Astrophysical Journal*, March, 1911.

a soldered tin case. This, in turn, is surrounded by a larger wooden box, having ten spiral chair-seat springs fastened within, so as to give elastic support to the inner case. To prevent too much movement of the inner case, wads of excelsior are put between the boxes at the eight corners. To prevent severe jarring of the outside box, wads of excelsior in canvas are also tacked outside the outer box at its eight corners.

Besides the three pyrhelimeters mentioned, two have been sold by the Institution to the United States Weather Bureau and to the Physical Laboratory of the Agricultural Department of the United States. Three others are being prepared by request for use in South America—one at Arequipa, Peru, two in Argentina.

With each instrument is sent out a calibration sheet, and also the following:

#### DIRECTIONS FOR USING THE ABBOT SILVER DISK PYRHELIOMETER

##### *Setting Up*

The pyrhelimeter is in the long box; the mounting in the cubical box.

1. If the mercury column of the thermometer is broken, remove the little screw at the side near the upper end of the nickel-plated tube, and take off the upper portion of the tube. Then heat the exposed stem cavity of the thermometer gently in a smoky flame (a match flame is good) until the mercury is expelled from the cavity. Then, holding the thermometer vertical, shake the instrument repeatedly with a downward jerk until the mercury columns join.

2. Remove the two little ivory plugs (using pliers if necessary) and unscrew the two brass screws under them, and also unscrew the third similar screw seen through the trunnion on the other side of the case. About three complete turns of each screw is proper. Insert the two ivory plugs. *When packing the instrument again for a journey, screw in the three screws as far as they will go.* Their purpose is to clamp the silver disk to protect the thermometer during transportation.

3. Unscrew the two pivots from the sides of the ring of the mounting, insert the pyrhelimeter so that the thermometer is *not* next to the worm wheel, and screw in the pivots.

4. Unclamp the half ring and set the polar axis approximately for the latitude of the place. The thermometer should be next to the *upper* end of the axis.

### *Adjustments*

5. For quick adjustment in right ascension guide the pyrheliometer with one hand and loosen the lower right-hand milled screw (as seen from the upper end of the polar axis). The worm may then be lowered out of engagement with the wheel and the change made.

6. To follow the sun, adjust in right ascension and declination until the sun shining through the little hole in the upper plate forms its image on the scratched spot on the nickered piece below. When exposing to solar radiation rotate the worm screw a little (about once every half minute) to follow the sun.

7. When about to observe, push aside the cover, leaving only the shutter to shade the silver disk. When through with each series of readings, close the cover to keep out dust.

### *Observations*

8. When reading the thermometer the observer should hold his head so that the reflection of each dark line of the scale near the degree to be observed, as seen in the mercury thread, is coincident with the corresponding dark line. This prevents parallax errors of reading.

9. Having adjusted the instrument to point at the sun and opened the cover, read the thermometer exactly at 20 seconds after the beginning of the first minute. Read again after 100 seconds, or at the beginning of the third minute, and immediately after reading open the shutter to expose to the sun. Note that the instrument is then correctly pointed. After 20 seconds read again. After 100 seconds more (during which the pointing is corrected frequently), or at the beginning of the fifth minute read again, and immediately close the shutter. After 20 seconds read again. After 100 seconds read again, or at the beginning of the seventh minute, and immediately open the shutter. Continue the readings in the above order, as long as desired. Readings should be made within  $1/5$  second of the prescribed time. Hold the watch directly opposite the degree to be observed, and close to the thermometer. Read the hundredths of degrees first, the degree itself afterward.

10. For example:

Reading.....	1	2	3	4	5	6
Time.....	11 <sup>h</sup> 55 <sup>m</sup> 20 <sup>s</sup>	57 <sup>m</sup> 00 <sup>s</sup>	57 <sup>m</sup> 20 <sup>s</sup>	59 <sup>m</sup> 00 <sup>s</sup>	59 <sup>m</sup> 20 <sup>s</sup>	01 <sup>h</sup> 01 <sup>m</sup> 00 <sup>s</sup>
Reading.....	15°.12	14°.25	14°.80	17°.58	17°.36	16°.09
Condition.....	Shaded		Exposed		Shaded	
Reading.....			7	8	9	10
Time.....			01 <sup>m</sup> 20 <sup>s</sup>	03 <sup>m</sup> 00 <sup>s</sup>	03 <sup>m</sup> 20 <sup>s</sup>	05 <sup>m</sup> 00 <sup>s</sup>
Reading.....			16°.58	18°.99	18°.75	17°.29
Condition.....			Exposed		Shaded	

Air temperature 15°.

Pyrheliometer "S. I. Q."

### Reductions

11. Subtract readings (2) from (1); (3) from (4); (6) from (5); (7) from (8); (10) from (9).

12. Take the algebraic means

$$\frac{(1)-(2)+(5)-(6)}{2}; \quad \frac{(5)-(6)+(9)-(10)}{2};$$

and to them add [(4)−(3)] and [(8)−(7)] respectively.

13. Call the results above  $R_1$  and  $R_2$ . Find roughly the mean temperatures  $T_1$  and  $T_2$  during the intervals of exposure (3) to (4) and (7) to (8).

14. Add to  $R_1$  and  $R_2$  the percentage corrections for graduation furnished with the instrument, then, after correcting, add to  $R_1$ ,  $K[(T_1 - 30^\circ)R_1]$  and to  $R_2$  add  $K[(T_2 - 30^\circ)R_2]$ .  $K$  is a constant furnished with the instrument. If the prevailing temperature of the air differs much from  $20^\circ$ , add  $0.0014R$  for each  $10^\circ$  the air temperature falls below  $20^\circ$ . The results (which we will call  $R'_1$  and  $R'_2$ ) are the final rates of rise per 100 seconds during the exposures (3) to (4) and (7) to (8) as reduced to the standard bulb temperature of  $30^\circ$ , and standard stem temperature of  $20^\circ$ .



15. (Note.) The approximate method of procedure stated in (12) and (14) is much easier than the exact method, and having been found by experiments to yield closely comparable results under all circumstances of use, within the error of measurement, it has been adopted, and the standardization of the instrument is made by this method.

16. To reduce the results  $R_1^1$  and  $R_2^1$  to standard calories per square centimeter per minute, or to the scale provisionally used up to 1910 by the Smithsonian Institution, multiply by the factors furnished from the Smithsonian Institution with each instrument.

17. Under favorable circumstances an experienced observer can read to a probable error of  $\frac{3}{10}$  per cent for a single reading. The sample readings here given differ more than this, for they were made at sealevel with variable sky.

## 18. Example of reduction:

Number.....	1	2	3	4	5	6	7	8	9	10
Reading.....	15°.12	14°.25	14°.80	17°.58	17°.36	16°.09	16°.58	18°.99	18°.75	17°.29
Differences.....		0°.87	2°.780		1°.27		2°.410		1°.46	
Cooling correction.....			1°.070				1°.365			
$R_1$ and $R_2$ .....			3°.850				3°.775			
$T_1$ and $T_2$ .....			16°.2				17°.8			
Scale correction.....		$-0.0020R_1=$	$-0°.008$		$-0.0022R_2=$	$-0°.008$	$-0°.008$			
$KR(T-30°)$ .....		$-(0.0011)(13.8)R_1=$	$-0°.058$		$-(0.0011)(12.2)R_2=$	$-0°.051$	$-0°.051$			
Air correction.....		$+0.0007R_1=$	$+0°.003$				$+0°.003$			
$R_1$ and $R_2$ .....			3°.787				3°.719			

Several questions have arisen regarding the accuracy of the silver disk pyrheliometer:

1. As to the effect of variations of the light of the sky, it might seem that since the pyrheliometer is exposed to about  $80^\circ$  of solid angle, of which the sun occupies only about  $0.2^\circ$ , the sky light might be quite considerable. To test this question a screen which limited the solid angle to  $5^\circ$  was fixed to one instrument, and another instrument with the usual arrangements was compared with it at Washington. No alteration of the relative readings due to the use of the screen could be found on a very clear day. On another day, less clear, a change of relative readings of about 0.5 per cent was found. On a very poor day the effect may reach 1 or even 2 per cent. On Mount Wilson the sky is so clear that its effect would be negligible.

2. As regards the inclination of the instrument, experiments were made by affixing a mirror to one pyrheliometer, so that the sun at about  $45^\circ$  from the zenith could be observed in two positions, vertical and horizontal, of the instrument, without shifting the mirror with respect to the pyrheliometer. Thus equipped, the pyrheliometer was compared with a second, read in the usual manner. No alteration of the relative readings could be found depending on the inclination.

3. As regards atmospheric pressure, a metal box was fitted to one pyrheliometer and a glass plate fixed over the tube for admitting sun rays, so that the air could be exhausted from the interior of the pyrheliometer. Comparisons were made at atmospheric pressure, and at about  $1/760$  of atmospheric pressure, with another instrument read as usual. No changes of the relative readings depending on air pressure could be discerned.

4. As regards age of the blackened surface of the *silver disk*, we have not very long-continued records. But a *copper disk* instrument has been employed on Mount Wilson since the spring of 1906, and has been many times compared with other copper disk instruments there. It has been several times cleaned and re-blackened. There is no evidence that changes as great as 1 per cent have ever occurred due to defects in the blackening. The instrument appears now to have the same relative readings compared with another instrument at Washington which has been unchanged and seldom used since 1906, that subsisted between them five years ago. Another copper disk instrument was loaned in 1907 to the Weather Bureau. Its blackening has been unchanged, and it now (1911)

gives the same relative readings compared with the one at the Astrophysical Observatory that it did in 1907.

5. As regards accidental error of observation, persons with good eyesight and experience in observing appear to read with a probable error, for a single determination, at high sun, not exceeding  $3/10$  per cent. As a single determination depends on six readings, and the rise of temperature determined is only about  $3^\circ$ , this requires a probable error of single readings of temperature not exceeding  $0.^\circ 005$ , or  $1/20$  division of the scale. It seems almost incredible that this degree of accuracy should usually be attained, but comparisons of instruments by two observers simultaneously, if made under excellent sky conditions, so indicate.

A silver disk pyrheliumeter ready for shipment, including standardization and boxing, costs the Smithsonian Institution about \$100. While it is not desired to manufacture them extensively, the Institution has in several instances consented to prepare and sell them. In cases where this evidently will tend to promote valuable and regular series of solar observations, the Institution is prepared to furnish silver disk pyrheliumeters at the price above stated.

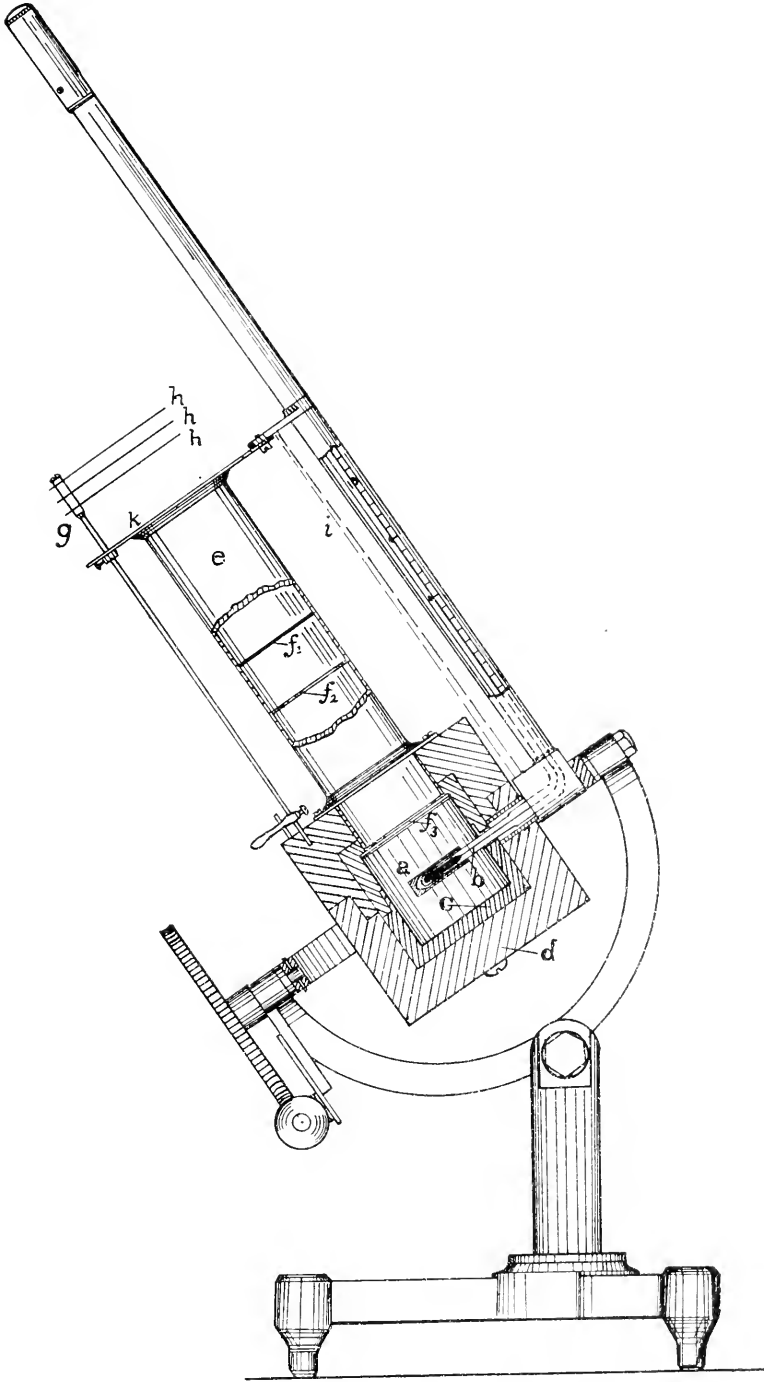

ABBOT SILVER DISK PYRHELIOMETER









SMITHSONIAN MISCELLANEOUS COLLECTIONS

VOLUME 56, NUMBER 20

# DESCRIPTIONS OF FIFTEEN NEW AFRICAN BIRDS

BY

EDGAR A. MEARNS

Associate in Zoölogy. U. S. National Museum



( PUBLICATION 2010 )

CITY OF WASHINGTON  
PUBLISHED BY THE SMITHSONIAN INSTITUTION  
APRIL 17, 1911

The Lord Baltimore Press  
BALTIMORE, MD., U. S. A.

## DESCRIPTIONS OF FIFTEEN NEW AFRICAN BIRDS

By EDGAR A. MEARNS

ASSOCIATE IN ZOOLOGY, UNITED STATES NATIONAL MUSEUM

This paper is the fourteenth dealing with the results of the Smithsonian African Expedition under the direction of Col. Theodore Roosevelt. It embraces descriptions of fifteen new species and subspecies of birds, ten of which were discovered by members of the expedition.

*Pternistes leucoscepus* (G. R. Gray), a plastic species of the East African region, has been divided into several subspecies in the northern portion of its range. Hitherto, the form found over much of British and German East Africa has been known as *Pternistes leucoscepus infuscatus* (Cabanis), but in the series of thirty specimens from this region in the collection of the United States National Museum, there are two undescribed subspecies from Mount Kenia, and Mount Kilimanjaro, respectively. These are the darkest forms of the species, and have a preponderance of chestnut color on the under parts.

Cabanis's description and very satisfactory colored plate (v. d. Decken's Reise, 1869, pl. 14) show that the form *infuscatus*, described by him from Lake Jipe, German East Africa, is the widely ranging plains race, and neither of the mountain forms described below, from both of which it may be readily distinguished by having the tail and wings distinctly cross-banded, and the dark centers of the long feathers of the flanks undivided by a central white shaft-stripe.

### **PTERNISTES LEUCOSCEPUS KENIENSIS**, new subspecies

Mount Kenia Bare-throated Spurfowl

*Type-specimen*.—Adult male. Cat. No. 214721, U. S. N. M. Collected on the west slope of Mount Kenia, on the N'joro or Kasorongai River, 6500 feet, British East Africa, October 18, 1909, by Edgar A. Mearns. Original number, 17164.

*Characters*.—Differs from *Pternistes leucoscepus infuscatus* in its generally darker coloration; in the absence of transverse bars on the wings and tail, which instead of being barred are minutely speckled

and vermiculated; in the much narrower white borders of the feathers of breast and sides, those of the flanks having white shaft-stripes; and in having the thighs and crissum darker and without pure white edges. Adult males have the iris brown; bill olivaceous brown, orange at base below; feet and claws black; naked sides of face and chin light red; throat bright yellow. Females are similar, but with less orange at base of bill below.

*Measurements of type-specimen* (adult male).—Wing, 204 mm.; tail, 105; exposed culmen (chord), 33; tarsus, 67; longest spur, 22.

*Material*.—Twenty specimens are referred to this subspecies.

*Remarks*.—Thirteen specimens taken around the base of Mount Kenia, at an altitude of 6000 to 7000 feet are typical *keniensis*. Seven specimens from Fort Hall and Saba Saba, at altitudes of 3900 and 4000 feet, are intergrades between *infuscatus* and *keniensis*. Specimens from Wambugu, Kapiti Plains, Ulukenia Hills, and the Southern N'Guaso Nyiro River in the Sotik District are all typical *infuscatus*.

#### PTERNISTES LEUCOSCEPUS KILIMENSIS, new subspecies

Mount Kilimanjaro Bare-throated Spurfowl

*Type-specimen*.—Adult female. Cat. No. 117817, U. S. N. M. Collected in the Mount Kilimanjaro Region, East Africa, 1888-'89, by Dr. W. L. Abbott.

*Characters*.—This is the extreme of the dark forms of *Pternistes leucoscepus*, and differs from *Pternistes leucoscepus infuscatus* in much the same way as does *keniensis*. Its closest affinity appears to be with *keniensis*, from which it differs in having a general castaneous tone of coloration; the light specklings of the wings and tail and the shaft-streaks of the mantle and wing-coverts are chestnut or rust color instead of grayish or buffy white; the concealed pale markings of the wing-quills are decidedly rusty instead of nearly white; the white edgings to the feathers of the breast and sides are obsolete except upon the posterior flanks, and these parts have the chestnut color extending to the subtriangular white spots at the tips of the feathers.

*Measurements of type-specimen* (adult female).—Wing, 181 mm.; tail, 82; exposed culmen (chord), 32; tarsus, 55.

*Material*.—Two specimens (one female and one unsexed) collected by Dr. W. L. Abbott.

*Remarks*.—The size is quite uniform in the three forms under consideration.

**FRANCOLINUS GRISESCENS**, new species

Grayish Francolin

*Type-specimen*.—Adult female. Cat. No. 216223, U. S. N. M. Collected at Lokko Zegga, Uganda, Africa, February 13, 1910, by Edgar A. Mearns. Original number, 18407.

*Characters*.—Allied to *Francolinus clappertoni* Children, but apparently much smaller than the subspecies *gedgii* and *heuglini*: females without chestnut markings; crown and ear-coverts prouts brown; feathers of upper side of neck and mantle black or brownish black, bordered with white except at the tips, and with narrow white shaft-stripes posteriorly; general color of remainder of upper parts grayish drab; feathers of back and rump with sagittate black markings and pale shaft-stripes; outer surface of wings spotted and irregularly cross-banded with grayish rusty white; wing-quills dark brown, cross-banded with rusty white and without longitudinal markings; tail brownish black, narrowly cross-banded with grayish white or rusty white; sides of head and neck buffy white, narrowly striped with black; chin and throat plain buffy white; remainder of under parts pale buff with brownish black markings, those of the chest V-shaped, with guttate extremities on the lower breast and sides, becoming oval or elliptical and sparse on the abdomen, and irregularly hastate on the posterior flanks and upper thighs; under tail-coverts buffy white, broadly banded with dark brown.

*Measurements of type-specimen (adult female)*.—Wing, 155 mm.; tail, 73; exposed culmen (chord), 26; tarsus, 47.

*Material*.—Six females from the upper Bahr el Jebel, near Lake Albert.

**FRANCOLINUS GRANTII DELUTESCENS**, new subspecies

Kasorongai Francolin

*Type-specimen*.—Adult male. Cat. No. 214748, U. S. N. M. Collected on a high, wooded hill at the base of Mount Kenia, west of the camp on the N'joro or Kasorongai River, altitude 7000 feet, British East Africa, October 19, 1909, by Edgar A. Mearns. Original number, 17172.

*Characters*.—Most closely related to *Francolinus grantii grantii* Hartlaub and *Francolinus grantii ochrogaster* (Hartlaub). From the latter it may at once be distinguished by its considerably larger size and much less ochraceous coloration. It is more closely related to typical *grantii*; compared with that bird it is seen that the size is

slightly greater; the general color is much more grayish, especially on the back, rump, and chest; the belly and crissum are much less ochraceous; the neck-collar of subtriangular chestnut markings is narrower, with the spots smaller; the upper parts are less rufescent—more olivaceous than reddish brown; the white shaft-streaks of the upper parts are much narrower and more broadly bordered with black; the crown is darker, with the bases of the feathers black instead of brown. Females have the upper parts much more abundantly vermiculated, cross-banded, and dotted with black than in the females of typical *grantii* or *ochrogaster*.

*Comparative measurements.*—Average of two adult males of *Francolinus grantii delutescens*: Wing, 146 mm.; tail, 87; exposed culmen (chord), 20; tarsus, 41.

Average of two adult males of *Francolinus grantii grantii*: Wing, 143 mm.; tail, 90; exposed culmen (chord), 19.5; tarsus, 42.

Average of two adult males of *Francolinus grantii ochrogaster*: Wing, 135; tail, 86; exposed culmen (chord), 19; tarsus, 40.

#### FRANCOLINUS SCHUETTI ZAPPEYI, new subspecies

Zappey's Francolin

*Type-specimen.*—Adult male. Cat. No. 56122, Museum of Comparative Zoölogy, Cambridge, Massachusetts. Collected on the east shore of Lake Victoria, in British East Africa, October 3, 1910, by Walter R. Zappey.

*Characters.*—Most closely related to *Francolinus schuetzi kapitensis* Mearns, the palest and grayest of the four recognized subspecies of *Francolinus schuetzi* Cabanis, from which it may be readily distinguished by the very broad pale edging to the feathers of the under parts and the absence of coarse markings on the upper parts; the crown is grayer and less brownish olive; the back and scapulars are much the same, but with clearer gray margins to the feathers; the general color of the lower back, rump, and upper tail-coverts is more olive brown, with the vermiculations obsolete; the outer webs of the outer primaries are plain dark brown; the rectrices are warm brown, with scarcely a trace of vermiculations; the feathers of the chest are grayish hair brown with apical shaft-stripes of broccoli brown, not flecked with black near the shafts; the feathers of the lower breast, upper abdomen, and flanks are soiled grayish white with shaft-stripes of hair brown; the under tail-coverts are hair brown broadly bordered with buffy white. "Bill and tarsi deep orange." (Zappey.)

*Measurements of type (adult male).*—Wing, 177 mm.; tail, 90; exposed culmen, 25; tarsus, 52; middle toe (without claw), 42; longest spur, 14.

*Remarks.*—The right foot has two developed spurs, the left only one.

**PTILOPACHUS FUSCUS KENIENSIS**, new subspecies

Mount Kenia Stone-Pheasant

*Type-specimen.*—Adult male. Cat. No. 56123, Museum of Comparative Zoölogy, Cambridge, Massachusetts. Collected on hills west of Mount Kenia, British East Africa, July 28, 1909, by Dr. Glover M. Allen.

*Characters.*—Most closely related to *Ptilopachus fuscus florentia*, from Gessena, British East Africa, but differing in having the coloration darker; the breast is pale buff; the feathers of the flanks are very narrowly barred with chestnut; the nape and mantle are without any chestnut whatever. "Eye-ring red; legs pink." (Allen.)

*Measurements of type (adult male).*—Wing, 120 mm.; tail, 78; culmen, 15; tarsus, 31.

*Average measurements of two adult female topotypes.*—Wing, 119 mm.; tail, 87; culmen (chord), 16; tarsus, 30.5.

**TURNIX SYLVATICA ALLENI**, new subspecies

Allen's Hemipode

*Type-specimen.*—Adult male. Cat. No. 56126, Museum of Comparative Zoölogy, Cambridge, Massachusetts. Collected on plains of the N'Guaso Nyiro River, near Mount Kenia, British East Africa, July 20, 1909, by Dr. Glover M. Allen.

*Characters.*—Most closely related to *Turnix sylvatica lepurana* (Smith), from which it differs in its more intense coloration; the brown of the crown, mantle, rump, and tail is much darker, and the dark markings are much larger and blacker; the rust color of the chest is also much stronger; all of the dark markings are increased in area and intensity.

*Measurements of type (adult male).*—Wing, 70 mm.; tail, 34; culmen (chord), 12; tarsus, 21.

*Measurements of adult male of Turnix sylvaticus lepurana* (Cat. No. 117841, U. S. N. M., Kahé, south side of Mount Kilimanjaro).—Wing, 70 mm.; tail, 34; culmen (chord), 13; tarsus, 21.5.

**XANTHOPHILUS BOJERI ALLENI**, new subspecies

Allen's Golden Weaver

*Type-specimen*.—Adult male. Cat. No. 56117, Museum of Comparative Zoölogy, Cambridge Massachusetts. Collected on the Miru River, near Mount Kenia, British East Africa, August 13, 1909, by Dr. Glover M. Allen.

*Characters*.—Adult male similar to that of *Xanthophilus bojeri bojeri* (Finsch and Hartlaub), but larger and slightly darker, with the bill slightly stouter, and having the upper contour more convex; the upper parts are less yellow because more heavily washed with olive-green; the wings and tail are darker above and below; the head and under parts are distinguishable from those of *bojeri* only by a slight intensification of the orange and yellow colors.

Female with upper parts darker, more greenish gray, without warm brown tints.

*Measurements of type (adult male)*.—Wing, 79 mm.; tail, 59; culmen (chord), 16; tarsus, 22.5.

*Average measurements of three adult male topotypes*.—Wing, 78.7 mm.; tail, 59; culmen (chord), 16.1; tarsus, 22.5.

*Measurements of adult female topotype* (Cat. No. 56118, Mus. Comp. Zoöl.).—Wing, 69 mm.; tail, 52; culmen (chord), 15.2; tarsus, 20.2.

*Measurements of Xanthophilus bojeri bojeri*.—Average of nine adult males from Changamwe and Mombasa, on the coast of British East Africa: Wing, 72.3 mm.; tail, 54; culmen (chord), 16; tarsus, 21.1. Average of three adult females (same localities): Wing, 65.9 mm.; tail, 51; culmen (chord), 15.2; tarsus, 20.2.

*Material*.—Five specimens from N'Guaso Nyiro and the Miru Rivers.

**URÆGINTHUS BENGALUS BRUNNEIGULARIS**, new subspecies

Brown-chinned Ruby-checked Cordon-bleu

*Type-specimen*.—Adult female. Cat. No. 215922, U. S. N. M. Collected at Wambugu, 5500 feet, British East Africa, October 23, 1909, by Edgar A. Mearns. Original number, 17309.

*Characters*.—Similar to *Uræginthus bengalus schoensis* Neumann, but averaging slightly smaller; the female has the side of head and chin brown instead of blue, though there may be a trace of blue next to the mandible.



*Measurements of type (adult female).—*Wing, 54 mm.; tail, 58; culmen (chord), 9.5; tarsus, 15.

*Remarks.*—All adult females of the races of *Uracinthus bengalus* found in the N'Guaso Nyiro region, northwest of Mount Kenia, British East Africa, and in the valley of the Upper White Nile, have the sides of the face and chin blue. One female (Cat. No. 213779, U. S. N. M.) from Juja Farm, Athli River, British East Africa, May 19, 1909, is intermediate with respect to the coloration of the chin and sides of head, both of which are brown, mixed with blue; but the bill agrees in size with that of *brunneigularis*, which is about one millimeter shorter than that of *schoenasis*.

*Average measurements of nine adult males.*—Wing, 52.2 mm.; tail, 58; culmen (chord), 9.8; tarsus, 14.3.

*Average measurements of twelve adult females.*—Wing, 51.5 mm.; tail, 53.5; culmen (chord), 9.5; tarsus, 14.3.

#### PYCNONOTUS LAYARDI Gurney

Layard's Yellow-vented Bulbul

*Pycnonotus layardi* GURNEY, Ibis, 1879, p. 390 (Rustenburg, Transvaal).

The typical form, *Pycnonotus layardi layardi*, inhabits the eastern districts of the Cape region of South Africa. In the coast region of German and British East Africa it merges into the subspecies *micrus*, and, farther north, and west to the Nile Valley, into several recognizable subspecies, three of which are here described as new.

#### PYCNONOTUS LAYARDI FAYI, new subspecies

Fay's Bulbul

*Type-specimen.*—Adult male. Cat. No. 214391, U. S. N. M. Collected at Fay's Farm, at N'jabini, British East Africa, altitude 8000 feet, August 11, 1909, by Edgar A. Mearns. Original number, 16537.

*Characters.*—Similar to *Pycnonotus layardi micrus* Oberholser in pattern and coloration, but nearly as large as *Pycnonotus layardi layardi*, from which it differs in being more darkly colored, with dark centers to the feathers of the mantle, and a tendency to striping of the lower breast instead of the softly-blended coloration of *layardi*. *Micrus* is much paler as well as smaller than *fayi*.

Nestlings, ready for flight, have the head blackish brown; the wings and tail dark brown; the remaining upper parts bistre; the

lower breast and abdomen buffy white; the crissum and upper tail-coverts sulphur yellow; and the sides pale brown.

*Measurements of type (adult male).*—Wing, 98 mm.; tail, 88; exposed culmen, 16; tarsus, 21.6.

*Material.*—Twenty-one specimens from western British East Africa.

*Remarks.*—This form extends from the Kapiti Plains west to Lake Victoria, in British East Africa. *Pycnonotus layardi micrus* ranges from the coasts of German and British East Africa west to the Kapiti Plains region; where it intergrades with *fayi* and also with the form described below.

**PYCNONOTUS LAYARDI PEASEI, new subspecies**

Kitunga Bulbul

*Type-specimen.*—Adult male. Cat. No. 213532, U. S. N. M. Collected at Sir Alfred Pease's Farm, Kitunga, British East Africa, altitude 6500 feet, May 2, 1909, by Edgar A. Mearns. Original number, 15656.

*Characters.*—Most closely related to *Pycnonotus layardi dodsoni* Sharpe, from Somaliland, but larger (see subjoined table of comparative measurements under the following subspecies), with the general coloration darker, in fresh plumage with a slight yellowish wash, absent in *dodsoni*, to the edges of the feathers of the mantle, this becoming more pronounced upon the rump and upper tail-coverts; edge of wing yellower than in *dodsoni*; feathers of lower breast more heavily striped centrally with dark brown; head blacker; nape appearing less distinctly striped because of the grayish white edging to the feathers.

*Measurements of type (adult male).*—Wing, 84 mm.; tail, 76; exposed culmen, 14.3; tarsus, 20.

*Material.*—Ten specimens from the Kapiti Plains region of British East Africa.

*Remarks.*—This form intergrades, both in size and coloration, with *Pycnonotus layardi micrus* in the Kapiti Plains region.

**PYCNONOTUS LAYARDI PHÆOCEPHALUS, new subspecies**

Brown-headed Bulbul

*Type-specimen.*—Adult female. Cat. No. 217202, U. S. N. M. Collected at Kikandwa (altitude about 3000 feet), Uganda, Africa, December 24, 1909, by Edgar A. Mearns. Original number, 17755.

*Characters*.—Intermediate between *Pycnonotus layardi fayi* and *P. l. minor* Heuglin. In extreme *minor*, from Gondokoro on the Bahr-el-Jebel, the head is scarcely darker than the mantle; in *fayi* the head is brownish black: in *phaeocephalus* it is dark brown (between sepia and clove brown). The mantle, rump, upper tail-coverts, and flanks are decidedly more olivaceous than in *fayi* or *minor*; the abdomen is more buffy white; the crissum and under tail-coverts are a considerably deeper yellow (lemon yellow instead of canary yellow).

*Measurements of type (adult female)*.—Wing, 92 mm.; tail, 82; exposed culmen, 15; tarsus, 21.5.

*Remarks*.—This peculiar form inhabits Uganda from Lake Victoria to Lake Albert. On the Upper Nile (Bahr-el-Jebel) this form rapidly passes into the subspecies *minor*.

COMPARATIVE MEASUREMENTS (IN MILLIMETERS) OF THE  
SUBSPECIES OF *PYCNONOTUS LAYARDI*.

Name.	Sex.	Number of Specimens.	Wing.	Tail.	Exposed Culmen.	Tarsus.
<i>Pycnonotus layardi layardi</i> .....	Male ...	5	99.0	89.8	17.3	22.0
<i>Pycnonotus layardi micrus</i> .....	Male ...	5	88.7	78.6	14.5	21.1
<i>Pycnonotus layardi micrus</i> .....	Female.	2	84.0	78.0	14.5	20.0
<i>Pycnonotus layardi peasei</i> .....	Male ...	4	84.3	75.8	14.5	20.1
<i>Pycnonotus layardi peasei</i> .....	Female.	4	77.8	72.5	13.7	19.5
<i>Pycnonotus layardi dodsoni</i> .....	Female.	1	81.0	78.0	14.0	19.0
<i>Pycnonotus layardi fayi</i> .....	Male ...	9	94.3	86.3	16.1	22.0
<i>Pycnonotus layardi fayi</i> .....	Female.	9	88.2	82.1	15.7	21.8
<i>Pycnonotus layardi phaeocephalus</i> ..	Female.	1	92.0	82.0	15.0	21.5
<i>Pycnonotus layardi minor</i> .....	Male ...	9	91.7	83.0	15.2	20.9
<i>Pycnonotus layardi minor</i> .....	Female.	3	88.3	81.3	15.2	20.5

**POGONOCICHLA CUCULLATA KENIENSIS, new subspecies**

Mount Kenia Bush-Robin

*Type-specimen*.—Adult male. Cat. No. 215577, U. S. N. M. Collected at the altitude of 10,700 feet, on the west slope of Mount Kenia, British East Africa, September 29, 1909, by Edgar A. Mearns. Original number, 16942.

*Characters*.—Most closely related to the form from the Kilimanjaro region, German East Africa, to which Oberholser, in 1905, restricted Blyth's name *cucullata* (Ibis, 1867, p. 16), and which has also been known by the names *orientalis* (adult birds) and *guttifer* (young). The Mount Kenia bird is similar in size to *cucullata*, but

differs from it in its lighter coloration. The head and wings are a paler blue; the lores are dark blue; the mantle is a more golden olive-green; the rump-patch is a clearer yellow; the tail-feathers have more yellow on the bases of the feathers and correspondingly narrower black tips; the under parts are a clearer, less ochery yellow; the white brow-patch is larger.

A young male topotype, in first plumage (Cat. No. 215580, U. S. N. M.), is much paler than the young of *cucullata* from Mount Kilimanjaro, and has the pale centers of the feathers of the chest enlarged and grayish white, slightly tinged with yellow; the greater wing-coverts are not tipped with yellow; the chin, throat, and abdomen are grayish white, slightly mixed with blackish, and washed with pale buff; the yellow upon the inner webs of the rectrices extends nearly to their tips.

*Measurements of type*.—Wing, 83 mm.; tail, 68; culmen (chord), 13.5; tarsus, 25.

*Remarks*.—*Tarsiger elgonensis* Ogilvie-Grant, recently described from Mount Elgon, British East Africa, differs from *P. c. keniensis* in having the outer tail-feathers black except at the extreme base, which is yellow, and in being a trifle larger.

#### EMINIA LEPIDUS HYPOCHLORUS, new subspecies

Green-sided Bush-Warbler

*Type-specimen*.—Adult male. Cat. No. 215355, U. S. N. M. Collected at Wambugu, 5500 feet, British East Africa, October 24, 1909, by Edgar A. Mearns. Original number, 17301.

*Characters*.—Differs from *Eminia lepidus lepidus* Hartlaub, in being slightly larger and in the following details of coloration: the forehead is gray, almost as dark as the crown, instead of whitish; the olive-green of the upper parts is paler and yellower; the shoulder and bend of the wing have much less chestnut color; the under parts are gray instead of grayish white; the sides olive-green instead of gray faintly washed with green.

*Measurements of type (adult male)*.—Wing, 66 mm.; tail, 69; culmen (chord), 18; tarsus, 26.

*Comparative measurements*.—Measurements of *Eminia lepidus lepidus* adult male: Wing, 67 mm.; tail, 65; culmen (chord), 16; tarsus, 26.

*Average measurements of six adult males of Eminia lepidus hypochlorus*: Wing, 69 mm.; tail, 70.5; culmen (chord), 17.9; tarsus, 26.1.

*Average measurements of three adult females of Eminia lepidus hypochlorus:* Wing, 66.7 mm.; tail, 62.3; culmen (chord), 17.2; tarsus, 24.7.

*Remarks.*—All of the specimens from west of Lake Victoria are typical *lepidus*, while those from British East Africa, east of Victoria Nyanza, are *hypochlorus*, although several specimens from the Southern N'Guaso Nyiro, in the Sotik District, and from Lake Naivasha verge toward the western form.

**SYLVIETTA WHYTII LORINGI, new subspecies**

Loring's Bush-Warbler

*Type-specimen.*—Adult male. Cat. No. 215360, U. S. N. M. Collected at Fort Hall, 3900 feet, British East Africa, October 28, 1909, by J. Alden Loring. Original number, 531.

*Characters.*—Most closely related to *Sylvietta whytii jacksoni*, but slightly smaller and considerably paler in color; the upper parts are more buffy, and paler, gray; the wing-quills are much paler brown; the under parts are pinkish buff instead of ochraceous-buff; the bill and feet lighter, with the mandible pale throughout.

*Measurements of type (adult male).*—Wing, 61 mm.; tail, 25; culmen (chord), 11.7; tarsus, 19.6.

*Measurements of adult female topotype.*—Wing, 56 mm.; tail, 25; culmen (chord), 11.5; tarsus, 18.

*Average measurements of two adult males of Sylvietta whytii jacksoni.*—Wing, 62.5 mm.; tail, 30; culmen (chord), 12; tarsus, 19.

*Measurements of one adult female of Sylvietta whytii jacksoni.*—Wing, 59 mm.; tail, 26; culmen (chord), 12; tarsus, 19.

*Remarks.*—I also refer to this form an adult female specimen (Cat. No. 118154, U. S. N. M.), collected at Taveta, British East Africa, July 6, 1888, by Dr. W. L. Abbott. It measures: Wing, 57 mm.; tail, 26; culmen (chord), 11; tarsus, 17. This specimen has been recorded as *Sylvietta whytii jacksoni* (Sharpe), by Oberholser, in the Proceedings of the United States National Museum, vol. xxviii, 1905, p. 906.









SMITHSONIAN MISCELLANEOUS COLLECTIONS

[VOLUME 56, NUMBER 21

DESCRIPTION OF A NEW GENUS  
AND SPECIES OF HUMMING-  
BIRD FROM PANAMA

BY

E. W. NELSON



(PUBLICATION 2015)

CITY OF WASHINGTON  
PUBLISHED BY THE SMITHSONIAN INSTITUTION  
JULY 8, 1911

The Lord Baltimore Press  
BALTIMORE, MD., U. S. A.

DESCRIPTION OF A NEW GENUS AND SPECIES OF  
HUMMINGBIRD FROM PANAMA

By E. W. NELSON

Since January, 1911, Mr. E. A. Goldman, of the Biological Survey, U. S. Department of Agriculture, has been detailed to the Smithsonian Biological Survey of the Panama Canal Zone to collect mammals and birds in the Canal Zone and adjacent parts of Panama. The most interesting discovery in his work to date has been a hummingbird representing a beautiful new genus and species. The type came from the higher slopes of the Cerro Azul, which rises to an altitude of 3200 feet about 15 miles northwest of Chepo, Panama. This high mountain lies at the extreme headwaters of the Chagres River, and Mr. Goldman writes that it is covered with forest which becomes smaller on the upper parts where these hummingbirds live.

I am indebted to Mr. Robert Ridgway, Curator of Birds, in the U. S. National Museum, for directing my attention to the marked characters of this interesting hummingbird.

**GOLDMANIA, new genus**

Type *Goldmania violiceps*, new species. Genus named in honor of Mr. E. A. Goldman.

*Generic characters.*—In general appearance similar to *Saucerotea*, but under-tail coverts small and very short; the three median ones remarkably specialized, being very narrow at base, broad and strongly decurved distally and very stiff; tenth, or outermost primary, shorter than ninth and abruptly attenuate near tip in adult male; bill longer than head, terete, narrow, slightly expanded basally and nasal operculum overlapping edge of mandible; feathers on tarsus very short, leaving inner side completely exposed.

**GOLDMANIA VIOLICEPS, new species**

Type No. 207754, adult male, U. S. National Museum, Biological Survey collection, from Cerro Azul, northwest of Chepo, Panama (3000 ft. altitude); collected by E. A. Goldman, March 23, 1911. (Original number 14173.)

*Distribution*.—Known only from 2500 to 3000 feet altitude on Cerro Azul, Panama.

*Description of adult male (type)*.—Crown, forehead and lores dull iridescent violet; rest of upper parts from nape to upper tail coverts rich metallic green, becoming clearer or brighter posteriorly (closely similar to color of upper parts of neck and body in *Saucerottea cyaneifrons*): lower parts nearly uniform brilliant metallic green, brighter than back (similar to but brighter than in *cyaneifrons*); under tail coverts very short and shining green, except 3 middle ones, which are satiny white, stiff and recurved; wings uniform purplish black; tail feathers reddish chestnut, broadly margined, especially at tips, with bronze green; upper mandible blackish; lower mandible pale basally and shaded with dusky on terminal half.

*Adult female (same date and locality as type)*.—Entire upper parts of head and body uniform, rather dull metallic green, becoming clearer posteriorly; under parts dull white mixed on sides of neck, breast and flanks with green feathers like those on back; under-tail coverts as in male; middle tail feathers mainly bronze green, with a very narrow dull rufous shaft streak on basal two thirds; other tail feathers dark rusty rufous along middle and margined by bronze green which occupies terminal fourth of the feathers; all but central pair of feathers with small central white spots at the tips; upper mandible dusky, lower one pale at base and becoming more dusky horn color on terminal two-thirds.

*Immature male*.—Upper parts plain green, nearly as in adult females, but rather brighter; under parts green mixed with grayish white on borders of feathers, especially on neck and breast, where the green in form of subterminal semilunar spots on median area give a scaled appearance; sides of neck and body and abdomen washed with duller metallic green; wings, tail and bill as in adult male, except broader bronze green tips to tail feathers and small terminal whitish spots at extreme tips, smaller than those in females.

*Measurements*.—Adult male (type), wing, 52.5 mm.; tail, 32.5 mm.; culmen, 19 mm. Adult female, wing, 47.5 mm.; tail, 25.5 mm.; culmen, 19 mm.

SMITHSONIAN MISCELLANEOUS COLLECTIONS

VOLUME 56, NUMBER 22

TWO NEW SUBSPECIES OF BIRDS  
FROM PANAMA

BY

E. W. NELSON



(PUBLICATION 2053)

CITY OF WASHINGTON  
PUBLISHED BY THE SMITHSONIAN INSTITUTION  
SEPTEMBER 7, 1911

The Lord Baltimore Press  
BALTIMORE, MD., U. S. A.

## TWO NEW SUBSPECIES OF BIRDS FROM PANAMA

By E. W. NELSON

While working on the Smithsonian Biological Survey of the Canal Zone,<sup>1</sup> Mr. E. A. Goldman of the Biological Survey, United States Department of Agriculture, collected specimens of two undescribed subspecies of birds which are characterized below.

### **HYLOMANES MOMOTULA OBSCURUS** subsp. nov.

Panama Pigmy Motmot.

Type No. 229477, adult female, U. S. National Museum, Biological Survey Collection, from Cerro Brujo, Panama; collected by E. A. Goldman, June 7, 1911. (Original number 15049.)

*Subspecific characters*.—Size same as in typical *momotula*, but colors generally darker: the back and rump parrot green of Ridgway; outside of wings and top of tail olive green; breast and sides of neck and body darker, more olive, especially along flanks; bend of wing olive brownish and under wing coverts darker buffy.

### **PACHYSYLVIA OCHRACEICEPS BREVIPENNIS** subsp. nov.

Panama Pachysylvia.

Type No. 229476, adult male, U. S. National Museum, Biological Survey Collection, from Lion Hill, Canal Zone; collected by E. A. Goldman, May 1, 1911. (Original number 14686.)

*Subspecific characters*.—Nearest *pallidipectus*, but with much shorter wings and tail; forehead and crown similarly tawny, but rest of upper parts of body from nape to upper tail coverts much more olive greenish; middle of back, scapulars and wing coverts dull olive brown, with much less russet than in either of the other forms; under parts of body from breast to under tail coverts pale, dingy, greenish yellow, with scarcely a trace of the ochraceous brown suffusion so marked in *ochraceiceps* and *pallidipectus*.

*Measurements of type*.—Wing, 53 mm.; tail, 40 mm.; tarsus, 17 mm.; culmen, 13 mm.

*Remarks*.—The great difference in length of wing and tail between the present form and the other subspecies, combined with the color differences, are almost sufficient to warrant giving this bird specific rank. One pair, shot on May 1, were the only specimens taken.

<sup>1</sup>This paper is the second dealing with the results of the Smithsonian Biological Survey of the Canal Zone.





SMITHSONIAN MISCELLANEOUS COLLECTIONS

VOLUME 56, NUMBER 23

ON PSOMIOCARPA, A NEGLECTED  
GENUS OF FERNS

WITH ONE PLATE

BY

DR. H. CHRIST, BASEL



(PUBLICATION 2054)

CITY OF WASHINGTON  
PUBLISHED BY THE SMITHSONIAN INSTITUTION  
NOVEMBER 21, 1911

The Lord Baltimore Press  
BALTIMORE, MD., U. S. A.

# ON PSOMIOCARPA, A NEGLECTED GENUS OF FERNS

BY DR. H. CHRIST, BASEL.

WITH ONE PLATE

The long discredited genus *Psomiocarpa* was established by C. B. Presl on one of the most extraordinary plants of the Philippine Islands, first discovered by the late Cuming and named by John Smith *Polybotrya apiifolia*. In conformity with our present views of generic relationship within the Polypodiaceæ this genus must now be reinstated, leaving out *Polybotrya acuminata* Link and *Polybotrya incisa* Link, which are true members of the genus *Polybotrya*, and including two American plants which are to be characterized in the present paper.

**PSOMIOCARPA** Presl, *Epim. Bot.* 161. 1849.

Genus a *Polybotrya* rhizomate brevi suberecto caespitoso nec aero-reptante, vernatione fasciculata nec eremobrya, et sporangiis segmenta fertilia undique tegentibus nec paginae inferiori solum affixis diversum. Folia sterilia plura fasciculato-rosulata, folium fertile solitarium, centrale.

## 1. PSOMIOCARPA APIIFOLIA Presl, l. c.

*Polybotrya apiifolia* J. Smith, *Journ. Bot.* 3: 401. 1841.

Foliis sterilibus subdeltoideis bipinnatis, versus basin postice auctis et tripinnatis, nervis lateralibus pinnularum furcatis. Folio fertili longe stipitato ideoque sterilia superante, lamina ad meras costas contracta, paniculiformi, segmentis remotis minutis globosis.

Planta pilis articulatis vestita.

Hab. Ins. Philippinae passim.

## 2. PSOMIOCARPA ASPIDIOIDES (Griseb.) Christ, *Geograph.*

*Farne* 224. 1910.

*Polybotrya aspidioides* Griseb. *Cat. Pl. Cub.* 276. 1868.

*Acrostichum aspidioides* Baker, in Hook. & Baker, *Syn. Fil.* 414. 1868.

Foliis sterilibus late ovatis, basin versus non auctis nec angustatis, bipinnatifidis, pinnis ad alam angustam incisissimis, segmentis

sinu separatis obtusis, subintegris aut minute serrulatis, nervis lateralibus simplicibus. Folio fertili sterilia non superante, lamina contracta racemosa, segmentis elongatis brevissimis verruciformibus sessilibus confluentibus.

Planta squamis lanceolatis subulatisque vestita, sed fronde fertili fere glabra. Cellulis squamarum parietibus tenuissimis separatis.

Hab. Ins. Cuba, *Wright* 1827 (U. S. National Herbarium, no. 50575).

3. **PSOMIOCARPA MAXONI** Christ, sp. nov.

*Psomiocarpa Maxoni* Christ, Geograph. Farne 224. 1910 (*nomen nudum*).

Foliis sterilibus late ovatis basin versus non auctis nec angustatis, bipinnatifidis, pinnis ad alam angustam incisus, segmentis confertis

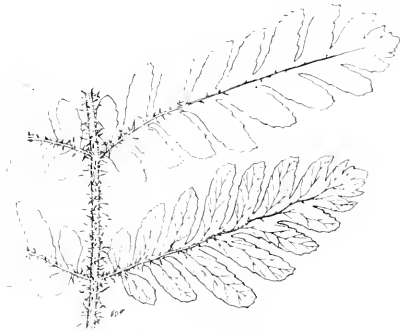

FIG. 1—*Psomiocarpa Maxoni* Christ. Lowermost pinnae at natural size.

sive imbricatis, ovato-acutis, dentato-serratis, nervis lateralibus furcatis. Folio fertili sterilia longe superante, longissime stipitato, speciei praecedenti simili, sed racemo squamis subulatis creberrimis valde hispido.

Planta squamis lanceolatis vestita: cellulis squamarum parietibus incrassatis rufobrunneis tuberculatis separatis.

Hab. Ins. Jamaica, Holly Mount, Mount Diabolo, alt. 750 meters, *Maxon* 2228 (U. S. National Herbarium, no. 520143, type).

*Remarks.*—*Psomiocarpa* is so closely related to *Dryopteris* that one is tempted to consider its several species as aberrant *Acrostichum*-like forms of this genus, with condensed non-indusiate sori. On account of the shape of the sterile frond and of the scales, the two American species are more closely related to the *Lastrea pinnata* group of *Dryopteris*, while the only other species, from the Far East, with its compound frond and its hairs, comes nearer to the species of the *Lastrea decomposita* group, as, for instance, *D. dissecta* (Forst.).

The sporangia, which are smooth, globose, pedicellate, with thick rings of at least 20 articulations, as well as the ovate, brown spores, are perfectly alike in the three species.

As to the shape of the fertile segments, the distinction between "globose" and "elongate" is not absolute. For example, a single specimen of *Psomiocarpa apiifolia*, collected in 1895 at San Ramon, Mindanao, by Copeland (no. 1777), has a fertile frond the pinnules of which are not globose, but elongate and confluent, very much as in the American species.

The presence of such a striking genus in Asia and America, although surprising, is not without parallel. One need cite only the case of *Loxsonia* of New Zealand and *Loxsomopsis* of Costa Rica.

The phylogenetic relations of *Psomiocarpa* tend toward *Dryopteris* and not *Polybotrya*. The latter seems to have rather more affinity to *Polystichum*, an intermediate form being *Polystichum apiifolium* C. Chr. (*Dicksonia* Sw.; syn. *Nephrodium duale* Down.-Smith), which shows the trailing rhizome and the contracted fertile frond of *Polybotrya*, though it has also a reniform indusium.

## EXPLANATION OF PLATE I

*Psomiocarpa Maxoni*, at about two-fifths natural size. Type collection.



*PSOMIOCHARPA MAXONI* Christ





SMITHSONIAN MISCELLANEOUS COLLECTIONS

VOLUME 56, NUMBER 24

# A REMARKABLE NEW FERN FROM PANAMA

WITH THREE PLATES

BY

WILLIAM R. MAXON



(PUBLICATION 2055)

CITY OF WASHINGTON  
PUBLISHED BY THE SMITHSONIAN INSTITUTION  
NOVEMBER 22, 1911

The Lord Baltimore Press  
BALTIMORE, MD., U. S. A.



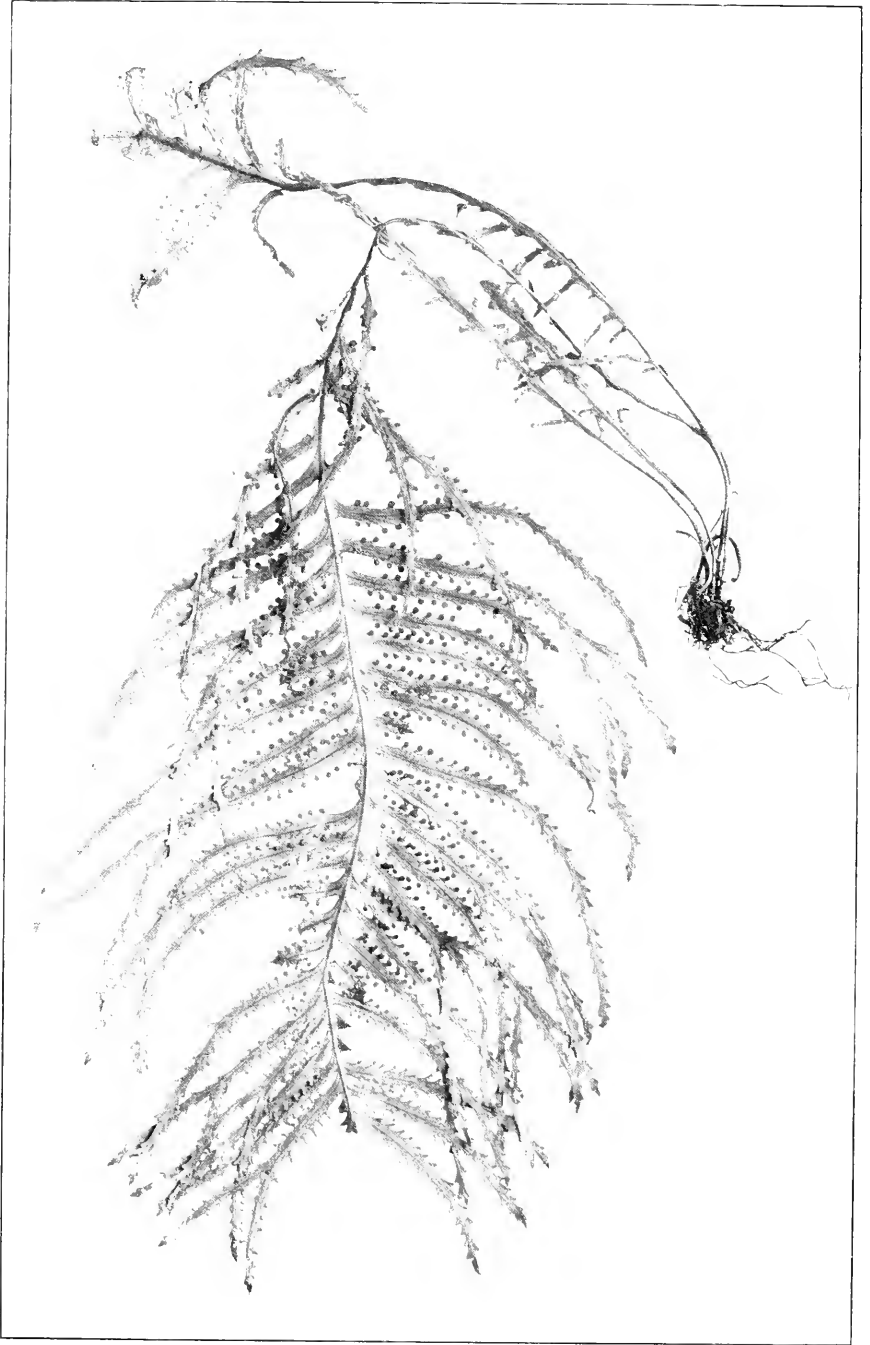

POLYPODIUM PODOCARPUM Maxon

## A REMARKABLE NEW FERN FROM PANAMA

BY WILLIAM R. MAXON

(WITH THREE PLATES)

Toward the last of February, 1911, in the course of fieldwork connected with the Smithsonian Biological Survey of the Panama Canal Zone, I accompanied Mr. Henry Pittier from the Canal Zone, where our work had been carried on up to that time, to Chiriqui, the westernmost province of Panama, and spent nearly all of March in collecting plants—mainly ferns and lower cryptogams—in the mountains north of David, the principal city of the province. As indicating in a general way the character of this region, the following notes may be of value, inasmuch as other new ferns will be described later, in advance of a proposed paper dealing with the fern flora of Panama as a whole.

Our base of operations was the small town of El Boquete, which lies at an altitude of about 1,100 meters upon the immediate southern base of the extensive east-and-west range of mountains here forming the Continental Divide, and is reached from David by means of a rather indifferent ox-road of nearly 35 miles. The contrast between the gentle slopes of the open and nearly treeless wind-swept savannah region, through which the trail extends practically its whole length, and the territory from which the Rio Caldera issues abruptly at the foot of the mountains, is most pronounced. Ferns, which have been almost wholly wanting below, here become a conspicuous part of the vegetation. From El Boquete a few trails lead in various directions to the upper slopes of the heavily forested mountains and under tolerably good weather conditions afford fair opportunity for collecting. In less favorable weather, however, the term "rain forest" here acquires a new and truer significance; conditions of such intense and apparently perpetual humidity I have never seen in other parts of tropical America as here in the Cordillera of Chiriqui.

The most extended trips taken from El Boquete were one of four days to the summit of Chiriqui Volcano, which lies just south of the Cordillera and wholly in the dry zone; another to the twin peaks Cerro de la Horqueta, at the summit of the Cordillera; and a

third expedition (the most interesting of all to a collector of ferns) along a comparatively recent path, known from the name of the surveyor as "Holcomb's trail," which, though never wholly completed, was designed to cross the Divide to the northern (Atlantic) coast. It was upon this last trip that the peculiar species here to be described was collected. The first day's route lay wholly along the Rio Caldera, "Camp I" being some ten or twelve miles from El Boquete and in the midst of wet virgin forest at an altitude of about 1,625 meters. The second day's route proceeded through an even more humid forest above the Rio Caldera over a laboriously constructed trail, which is rapidly becoming obliterated, to the summit of the Divide at a point previously determined as about 1,925 meters above sea-level. "Camp II," which lies a short distance farther on and below, upon the Atlantic side, was not visited from lack of time. My collections for this day, which were very large, consisted entirely of material gathered between "Camp I" and the Divide. Among the many noteworthy pteridophyta collected, several of them new, none approaches in interest the species here to be described.

The first specimen of this peculiar species was secured at perhaps 1,750 meters elevation, on the trail referred to, above "Camp I," and from there all the way to the summit an occasional plant or tuft of plants would be found upon the smooth trunks of palms or other forest trees, usually at a distance of from two to six meters from the ground. The fact that the plant, though nowhere abundant, was sufficiently widespread to be encountered over an area of several miles, may safely be taken to indicate that the peculiar position of the sori, though apparently unique within the genus, is nevertheless normal for the species. The elongation of the pinnæ and their repeated division in a great majority of the fronds is discussed later, following the description. The species may be known as:

**POLYPODIUM PODOCARPUM Maxon, new species**

Plants epiphytic, the fronds pendent, usually numerous, closely fasciculate, 25 to 55 cm. long, subpinnate, the pinnæ sometimes simple, but mostly several to many times divaricately branched, both lamina and pinnæ of slow indeterminate growth. Rhizome prostrate or decumbent, rather slender and short, up to 4 cm. long, 4 to 6 mm. in diameter, the older portion clothed with the imbricated bases of numerous dead fronds, the crown bearing a few nearly concealed lanceolate, plicate, cucullate or subtubulose, entire, bright brown scales 3 to 5 mm. long; stipes stoutish, greenish from a dull

brown base, or discolored throughout, 1 to 6 cm. long or nearly wanting, flattened, very narrowly alate above (gradually passing into the narrowly winged rachis), rather densely pilose with very slender, fragile, spreading, rufous hairs 2 to 3.5 mm. long; lamina 20 to 50 cm. long, of varying form and indeterminate growth, readily abortive at the apex, the pinnæ simple and usually elongate, or greatly extended and freely branched near or beyond their middle, the numerous slender branches commonly forming a subdichotomy; pinnæ spreading or slightly ascending, adnate, joined uniformly by a narrow wing about 1 mm. broad, decurrent, the simple ones linear-caudate, 4 to 14 cm. long, 3 to 5 mm. broad and entire if sterile, if fertile distantly and obliquely serrate-pectinate to dentate, 5 to 9 mm. broad including the teeth or lobes, these 1 to 3 mm. long, rounded and soriferous at the apex; veins free, very oblique, the sterile ones 1- to 3-forked, the fertile ones forked, the sorus borne at the clavate apex of the greatly elongated anterior branch, very close to the margin; sori large, hemispherical, or by their position nearly globose, the sporangia arising from the lower surface but crowding outward in the plane of the lamina, the sorus thus appearing nearly or quite terminal upon the lobe; leaf tissue of young plants firmly membrano-herbaceous, the veins apparent by transmitted light, of mature plants thicker and spongiose, the veins seen with difficulty; both surfaces of the lamina (including the greenish rachis and nearly concealed midveins) covered throughout with short, distant, dark, gland-like hairs.

Type in the U. S. National Herbarium, no. 676092, collected from a tree trunk in the humid forest of the upper Caldera watershed, between "Camp I" and the Divide, Holcomb's trail, above El Boquete, province of Chiriqui, Panama, altitude 1,750 to 1,925 meters, March 23, 1911, by William R. Maxon (no. 5640).

The specimen designated as the type is but one of several mounted plants (numbers 5640 and 5656) showing the extremes of leaf form within the species. It is shown at exactly one-half natural size in Plate 1 and may be taken to indicate the "normal" form of the mature frond. Plate 2 represents at the same scale a plant of no. 5656 in which the tendency toward repeated dichotomy of the pinnæ has found ample expression. Plate 3, at about two-fifths natural size, shows a plant of no. 5640 approaching maturity and possessing an unusually large number of fronds, most of which have escaped injury at the apex while young and have in consequence attained a fair length.

A reasonable explanation of the remarkable leaf form developed by many individual fronds is, I believe, found in the following hypothesis, which has been substantiated by a careful examination of the series of specimens. It is that, notwithstanding the indeterminate growth of the lamina and of the pinnæ at their apices, the fronds would, if fully protected from injury by natural causes (such as injury by wind or by the falling of water-filled parasites from the heavily laden branches above), develop in a nearly symmetrical form. (See Plate 1, in which the frond had apparently attained a fair size before the apical portion was lost. There is no abortive tip: the whole apical portion has been broken off.) Plate 2 would appear to controvert this supposition somewhat; but an examination of the specimen itself shows the apex of this frond to be dead and discolored, and the other five or six fronds to have been broken off short and to have "forced" the activities of the entire plant to seek an outlet through a single channel, namely, the further development of the pinnæ of the one remaining frond, each (if uninjured) with its nearly dormant or slowly unrolling minute terminal bud. The alternative would have been the development or pushing out of new fronds, a feature which is, possibly, seasonal.

Further evidence is offered by a great number of mutilated fronds, and in particular (among the mounted specimens) by one not here figured (U. S. Nat. Herbarium, no. 676090) which has the stipe short and stout, the rachis 7 cm. long, the lamina there broken off sharply by natural injury and wanting, the pinnæ missing on one side of the basal remnant, and those on the other side several times dichotomous and produced to a length of 18 cm. A frond of another plant has several pinnæ similarly developed to a length of from 18 to 24 cm.

Instances of indeterminate growth in *Polyopodium* are, I think, not very common, but the following readily occur: (1) That of *P. jamesonioides* Fée<sup>1</sup>, a species described from Colombia (*Schlim* 399), recently collected by me on Chiriqui Volcano at an altitude of about 3,000 meters (no. 5340), in which the slender simply pinnate fronds are obviously of indefinite evolution, the apex being invariably terminated by a crosier-like nascent bud; (2) that of *P. heteromorphum* Hook. and Grev., which with its dichotomous fronds is well known in several forms; (3) and that of the West Indian *P. curvatum* Sw. (of which *P. inaequale* Fée<sup>2</sup> is an exact

<sup>1</sup> Fée, 7me Mém. Foug. 59. pl. 21. f. 4. 1857.

<sup>2</sup> Fée, 11me Mém. Foug. 47. pl. 12. f. 3. 1866.



synonym), in which a close examination shows the apices of perfect fronds to be not truly determinate, but rather, as in *P. podocarpum*, to remain in a nascent state long after the older parts of the frond have reached maturity.

As to the cause of the development of the dichotomous form of the pinnæ in fronds of *P. podocarpum*, in preference to the simple elongation of its pinnæ by the same method of indefinite evolution, no especial explanation need be sought, inasmuch as instances of repeated subdivision of apical growth in ferns are exceedingly common. But it may be mentioned that in the whole series of this species not one of the fronds is subdivided at its apex, and in only one is the rachis forked, the simple division in this instance having been caused by an injury. The repeated subdivision of the fronds occurs invariably in the pinnæ. This is only partially accounted for by the greater likelihood of injury to the apex of the frond.

With respect to relationship, *Polypodium podocarpum* is clearly allied to *P. curvatum*, its nearest relatives being perhaps the Andine species *P. pilipes* Hook.<sup>1</sup> and *P. pozuzoense* Baker,<sup>2</sup> the former from Peru, the latter from Ecuador. But these are species with deeply pectinate-pinnatifid pinnæ, and the former, at least, has simple veins. Both differ from *P. podocarpum* very conspicuously in the position of their sori, which are not placed apically upon special teeth or lobes. The position of the sori in *P. podocarpum*, indeed, demands especial notice, for it is not only apparently new for the genus *Polypodium* (*Eupolypodium*), but seems to reverse the usual observed fact that fertility is commonly accompanied by a loss of foliar tissue. The contrary is here true; the pinnæ are entire where sterile, and toothed or lobed only where soriferous; there are no sterile lobes on the fertile fronds. Moreover, the apical position of the sori is so pronounced a feature as to suggest strongly the recognition of this species as a distinct generic type. Without a more critical study of its closest allies this hardly appears desirable; but it is difficult to escape the conviction that, as proven similarly by Mr. Christensen in the case of *Dryopteris*, the genus *Polypodium* (restricted to *Eupolypodium*) is susceptible of division into several well-defined sections, which will be more than "groups of closely related species," in that they may be recognized by definite characters afforded by a study of their minute morphology and their method of growth.

<sup>1</sup> Hook. Ic. Pl. *pl.* 221. 1840.

<sup>2</sup> Hook. Ic. Pl. *pl.* 1672. 1886.



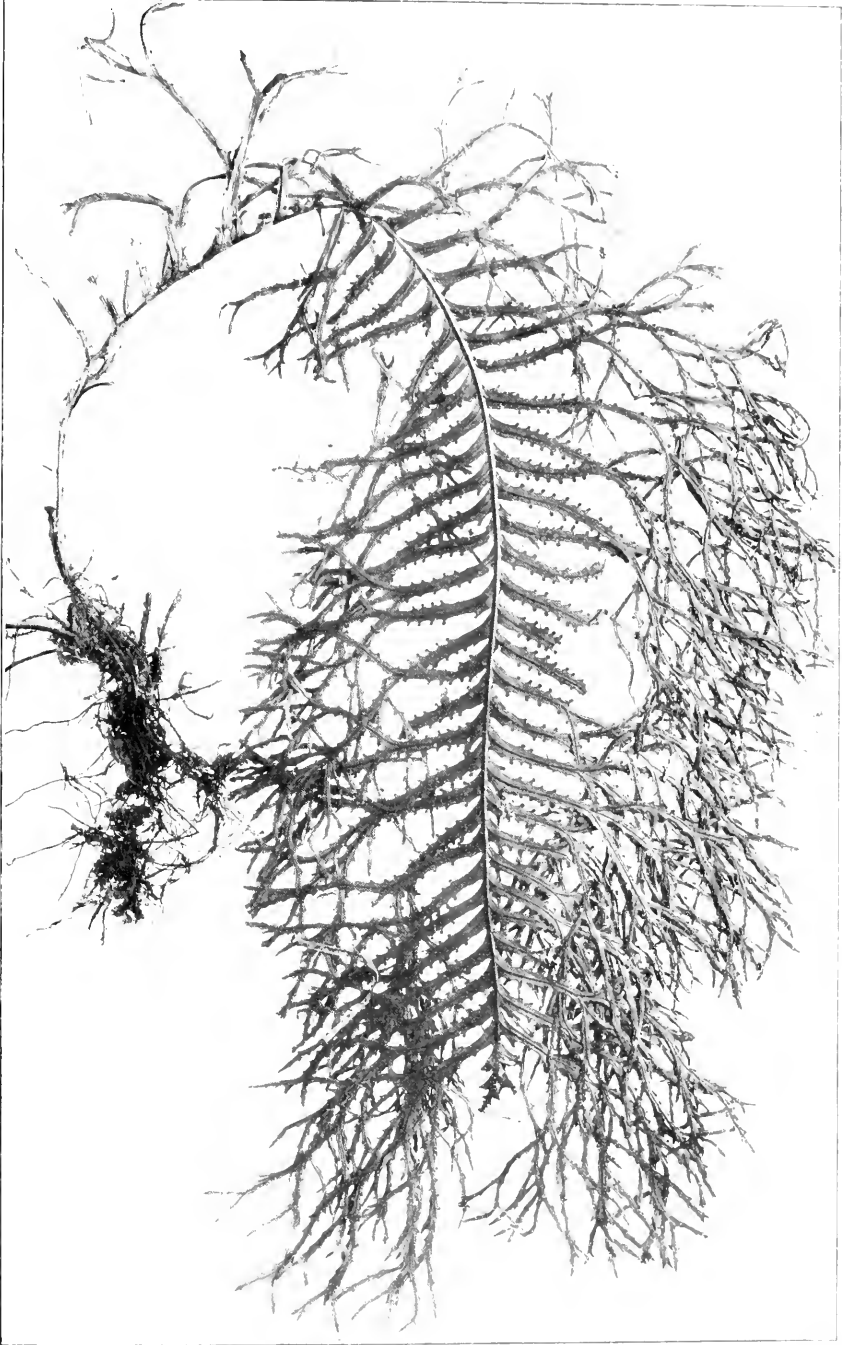

POLYPODIUM PODOCARPUM Maxon





POLYPODIUM PODOCARPUM Maxon



SMITHSONIAN MISCELLANEOUS COLLECTIONS

VOLUME 56, NUMBER 25

DESCRIPTIONS OF SEVEN NEW AFRICAN  
GRASS-WARBLEDERS OF THE  
GENUS CISTICOLA

BY

EDGAR A. MEARNS

Associate in Zoology, U. S. National Museum



(PUBLICATION 2056)

CITY OF WASHINGTON  
PUBLISHED BY THE SMITHSONIAN INSTITUTION  
NOVEMBER 23, 1911

The Lord Baltimore Press  
BALTIMORE, MD., U. S. A.



DESCRIPTIONS OF SEVEN NEW AFRICAN GRASS-  
WARBLERS OF THE GENUS *CISTICOLA*

By EDGAR A. MEARNS

ASSOCIATE IN ZOOLOGY, UNITED STATES NATIONAL MUSEUM

This paper is the fifteenth dealing with the results of the Smithsonian African Expedition, under the direction of Col. Theodore Roosevelt. It embraces descriptions of seven new species and subspecies of birds, four of which were discovered by members of the expedition.

All of the measurements submitted in this paper are in millimeters; and the designation of colors conforms to Mr. Robert Ridgway's "Nomenclature of Colors," 1886.

***CISTICOLA PRINIODES KILIMENSIS*, new subspecies**

Mount Kilimanjaro Grass-Warbler

*Cisticola prinioides* OBERHOLSER, Proc. U. S. Nat. Mus., Vol. 28, 1905, p. 902 ("Six specimens, from Mount Kilimanjaro, at 5,000, 6,000, and 8,000 feet, April 3 to 11, 1888.")--SjÖSTEDT, Wiss. Ergeb. Schwed. Zool. Exped. Kilimandjaro, III, Vögel, 1908, p. 140 (Kilimanjaro).

*Type-specimen*.—Adult male. Cat. No. 118025, U. S. N. M. Collected at Maranu, altitude of 5,000 feet, on Mount Kilimanjaro, German East Africa, April 3, 1888, by Dr. W. L. Abbott.

*Characters*.—Most closely related to *Cisticola prinioides prinioides* Neumann, from Mau, British East Africa, but differs in having the upper parts less uniformly colored, and the under parts darker, without a well-defined whitish area along the middle of the abdomen. The rufous crown is more distinctly spotted with dark centers to the feathers. The mantle is grayish, with blacker centers to the feathers.

*Measurements of type* (adult male).—Length (of skin), 147; wing, 58; tail, 69; culmen, 13; tarsus, 24.

*Material*.—Six specimens, collected by Dr. W. L. Abbott, on Mount Kilimanjaro, at the altitudes of 5,000, 6,000, and 8,000 feet.

*Remarks*.—This form may be distinguished from *Cisticola prinioides neumanni* (Hartert), from Mount Kenia, British East Africa, by its paler, more grayish, and more spotted upper parts; and the

under surfaces are browner, less grayish, in *kilimensis* than in *neumanni*.

**CISTICOLA SUBRUFICAPILLA ÆQUATORIALIS**, new subspecies

Equatorial Grass-Warbler

*Type-specimen*.—Adult male. Cat. No. 214431, U. S. N. M. Collected at Lake Naivasha, altitude 6,350 feet, British East Africa, July 22, 1909, by Edgar A. Mearns. Original number, 16355.

*Characters*.—Much larger than *Cisticola subruficapilla subruficapilla* (A. Smith); coloration darker; median stripes on feathers of upper parts broader and blacker; tail and outer aspect of wings less rufescent.

*Description*.—Pileum and cervix pale sepia, the feathers centrally striped with blackish brown; lores white or (sometimes) rusty white; no light stripe above eye; ear-coverts grayish brown; back, rump, and upper tail-coverts dark hair brown, the feathers of the mantle with conspicuous brownish-black centers; wings externally dark brown, with outer webs edged with dull cinnamon; tail above dark reddish brown, obscurely fasciated, all but the central pair of rectrices subterminally banded with black and tipped with pale drab; chin and upper throat white; middle of chest and abdomen white, washed with cream-buff; sides brownish gray washed with buff; thighs clay color; axillars and bend of wing creamy white; under wing-coverts and inner border of quills pinkish buff; crissum cream-buff; under surface of tail pale drab (sometimes rusty), the feathers subterminally crossed by a complete black band about five millimeters in width. Iris yellowish brown; bill blackish brown above and flesh color below; feet and claws light brown.

*Measurements of type* (adult male).—Length (of skin), 140; wing, 61; tail, 58; exposed culmen (chord), 13.5; tarsus, 24.

*Average measurements of eight adult males*.—Wing, 66.1; tail, 58.3; culmen (chord), 13.4; tarsus, 24.5.

*Average measurements of four adult females*.—Wing, 57; tail, 49.3; culmen (chord), 12.3; tarsus, 23.6.

*Measurements of one adult male topotype of Cisticola subruficapilla subruficapilla*.—Wing, 52; tail, 50; culmen (chord), 11.2; tarsus, 20.

*Material*.—Twelve adults from Juja Farm (Athi River), Heatley's Farm (Kamiti), Southern N'Guaso Nyiro River (Sotik District), Oljoro-o-Nyon River, Lake Naivasha, Gilgil, Laikipia, and Guaso Nyiro River, all in British East Africa.

**CISTICOLA SUBRUFICAPILLA BOREA**, new subspecies

Northern Grass-Warbler

*Type-specimen*.—Adult male. Cat. No. 217127, U. S. N. M. Collected at "Rhino Camp,"<sup>1</sup> on the Bahr el Jebel, Lado Enclave, Africa, January 30, 1910, by Edgar A. Mearns. Original number 18244.

*Characters*.—Similar to *Cisticola subruficapilla equatorialis* Mearns, but smaller and much paler in coloration.

*Description*.—Pileum and cervix pale bistre, the feathers centrally striped with dark brown; lores white; ear-coverts and sides of neck drab; back, rump, and upper tail-coverts light hair brown, the feathers of the mantle with dark brown centers; wings dark brown, with fulvous edging to the outer webs of the primaries, and drab edging to the outer webs of the secondaries and wing-coverts; tail broccoli brown, obscurely fasciated, all but the central pair of feathers crossed by a subterminal black band and narrowly tipped with écreu drab; chin, throat, and middle of abdomen white; sides pale grayish drab washed with cream-buff; thighs pale brownish gray; axillars and lining of wings creamy white; under wing-coverts and inner border of quills pale pinkish buff; under tail-coverts soiled white; under surface of tail écreu drab, the feathers subterminally crossed by a complete black band about four millimeters in width. Bill (in dry skin) dark brown above and flesh color below; feet and claws light brown.

*Measurements of type* (adult male).—Length (of skin), 132; wing, 62; tail, 54; culmen (chord), 13.5; tarsus, 25.5.

*Measurements of adult male* (Cat. No. 217129, Bahr el Jebel at Gondokoro, Uganda, February 25, 1910).—Wing, 64; tail, 58; culmen (chord), 13; tarsus, 25.

**CISTICOLA ALLENI**, new species

Allen's Grass-Warbler

*Type-specimen*.—Adult male. Cat. No. 56127, Museum of Comparative Zoology, Cambridge, Massachusetts. Collected on the Meru River, British East Africa, August 12, 1909, by Dr. Glover M. Allen.

*Characters*.—This species appears to be most closely related to the *Cisticola subruficapilla* group, from which it differs in the relatively stouter, more curved bill, pallid grayish coloration, cinereous outer aspect of the primaries, and white tips to the tail-feathers.

<sup>1</sup> "Rhino Camp" is on the left (west) bank of the Nile ("Bahr el Jebel"), about 15 miles north of Wadelai, latitude 2° 55' north.

*Description.*—Upper parts brownish gray, slightly rufescent on the crown; feathers of mantle and crown centrally striped with dark brown; wing-coverts and quill-feathers dark brown with broad hoary edging; feathers of rump and upper tail-coverts cinereous, with obsolete median dark streaks; rectrices dusky brownish gray, obscurely fasciated, all but the central pair with a broad subterminal band of black and pure white tip; lores and sides of face, below eye, white; ear-coverts pale grayish brown; under parts white with a faint tinge of buff across chest and along sides; edge of wing white; under wing-coverts creamy white; inner border of quill-feathers buffy white; under surface of rectrices gray, all but the middle pair crossed by a subterminal black bar seven millimeters in width and broadly tipped with pure white. Bill, in dry specimens, pale brown above, flesh color on mandible and sides of maxilla; feet and claws light brown.

*Measurements of type* (adult male).—Length (of skin), 115; wing, 63; tail, 57; culmen (chord), 13; tarsus, 23.

*Measurements of adult male topotype.*—Length, 115; wing, 67; tail, 55; culmen (chord), 12; tarsus, 24.

*Material.*—Two adult males, collected by Dr. Glover M. Allen, on the Meru and Guaso Nyiro Rivers, north of Mount Kenia, in British East Africa.

#### CISTICOLA STRANGEI KAPITENSIS, new subspecies

Kapiti Plains Grass-Warbler

*Type-specimen.*—Adult male. Cat. No. 213547, U. S. N. M. Collected at Potha, altitude 4250 feet, Kapiti Plains, British East Africa, April 29, 1909, by Edgar A. Mearns. Original number, 15644.

*Characters.*—Most closely related to *Cisticola strangei pachyrhyncha* (Heuglin),<sup>1</sup> from the "forest-region of Bongo, in Central Africa," from which it differs in being much paler and more grayish. *Cisticola argentea* Reichenow,<sup>2</sup> which is apparently a subspecies of *Cisticola strangei* (Fraser),<sup>3</sup> is larger, grayer, and with more grayish sides than the present form. The salient differences in three closely related forms of *Cisticola strangei* may be stated as follows:

<sup>1</sup> Ibis, 1869, pp. 130 and 131, in text (new name for *valida* Peters).

<sup>2</sup> Ornith. Monatsb., Vol. 13, 1905, p. 25.

<sup>3</sup> *Drynoica strangei* L. Fraser, Proc. Zool. Soc. Lond., Pt. 11, No. 121, July, 1843, p. 716.

<i>Cisticola strangei strangei</i>	<i>Cisticola strangei pachyrhyncha</i>	<i>Cisticola strangei kapitensis</i>
Pileum prout's brown, the feathers inconspicuously edged with wood brown.	Pileum bistre, without conspicuous edging to the feathers.	Pileum pale brown, the feathers broadly edged with pale grayish clay color.
Nape similar to crown.	Nape similar to crown.	Nape pale clay color, with darker centers to the feathers, contrasting with color of crown and mantle.
Mantle dark brown, the feather edging paler, more yellowish brown.	Mantle darker brown, the feather edging not in strong contrast with the dark centers.	Mantle paler, with broad grayish margins strongly contrasting with the dark centers to the feathers.
Outer surface of wing-quills russet.	Outer surface of wing-quills wood brown.	Outer surface of wing-quills wood brown.
Under surfaces deep yellowish olive-buff.	Undersurfaces pale yellowish olive-buff.	Under surfaces buffy white.

Measurements of type (adult male).—Length (of skin), 128; wing, 68; tail, 51; exposed culmen (chord), 13.1; tarsus, 29.

Comparative measurements of adult males:

	Wing	Tail	Exposed culmen	Tarsus
<i>Cisticola strangei strangei</i> .....	69.0	53.6	13.0	29.0
<i>Cisticola strangei pachyrhyncha</i> .....	69.0	50.0	13.0	29.0
<i>Cisticola strangei kapitensis</i> .....	67.6	51.9	13.1	28.5

Material.—Five adult males from British East Africa.

Remarks.—I noted the color of the iris of the type specimen as "pale brownish yellow." On two specimen labels, Mr. G. L. Harrison, Jr., has noted: "Iris light brown; bill dusky; legs and feet flesh color."

**CISTICOLA DIFFICILIS**, new species

Lakiondu Grass-Warbler

Type-specimen.—Adult female. Cat. No. 56129, Museum of Comparative Zoology. Collected at Lakiondu, north of Mount Kenia, British East Africa, September 7, 1909, by Dr. Glover M. Allen.

Characters.—Similar to *Cisticola sylvia* Reichenow, but striped above and slightly smaller. In general coloration it is not very unlike *Cisticola emini* Reichenow, though striped and more yellowish above and more strongly fulvous below.

Description.—Pileum and cervix plain sepia brown; mantle sepia, the feathers mesially striped with blackish brown; rump and upper tail-coverts rather pale yellowish brown; wings bistre, washed with cinnamon on the outer webs of quills; tail above bistre, showing

faint cross-bars, subterminally banded on all of the feathers with obsolete dusky bars which are black on the under surface, and tipped with grayish drab; lores and supraorbital stripe soiled white; sides of head pale grayish brown; under parts pale grayish brown, whitish on throat and middle of abdomen; thighs broccoli brown; edge of wing white; under wing-coverts buff-yellow; inner webs of quills buffy gray; under side of tail grayish drab, subterminally banded with black (these bands about six millimeters in width on outer rectrices), and broadly tipped with yellowish drab. In the dry skin the ridge of the maxilla is brown, the mandible and sides of maxilla flesh color; feet and claws pale yellowish brown.

*Measurements of type* (and only specimen).—Length (of skin), 120; wing, 54; tail, 52; culmen (chord), 12.5; tarsus, 21; width of middle tail-feather, 10.

**CISTICOLA HYPOXANTHA REICHENOWI**, new subspecies

Reichenow's Grass-Warbler

*Cisticola hypoxantha* OBERHOLSER. Proc. U. S. Nat. Mus., Vol. 30, 1906, p. 805.

*Type-specimen*.—Adult male. Cat. No. 215430, U. S. N. M. Collected at Changanwe (sea-level), British East Africa, November 30, 1909, by Edgar A. Mearns. Original number, 17702.

*Characters*.—Similar to *Cisticola hypoxantha hypoxantha* Hartlaub from the upper Nile Valley, but paler, and less distinctly streaked above.<sup>1</sup>

*Measurements of type* (adult male).—Length (of skin), 100; wing, 48; tail, 37; exposed culmen (chord), 10.3; tarsus, 20.

*Material*.—Eight specimens of the present form from Mombasa and Changanwe, on the coast of British East Africa; five specimens of *Cisticola hypoxantha hypoxantha* Hartlaub from near the type locality (Lake Albert).

*Remarks*.—Dr. Reichenow, to whom the specimens collected by William Doherty at Mombasa were submitted, considered this form distinct; but in the absence of specimens from the type locality of *Cisticola hypoxantha*, Mr. Oberholser was unwilling to name the Mombasa bird, which I now take pleasure in naming for Dr. Anton Reichenow.

<sup>1</sup> For a detailed description of this form see Oberholser, Proc. U. S. Nat. Mus., Vol. 30, June 4, 1906, p. 806.

SMITHSONIAN MISCELLANEOUS COLLECTIONS

VOLUME 56, NUMBER 26

FOUR NEW MAMMALS FROM  
THE CANADIAN ROCKIES

BY

N. HOLLISTER



(PUBLICATION 2662)

CITY OF WASHINGTON  
PUBLISHED BY THE SMITHSONIAN INSTITUTION  
DECEMBER 5, 1911

**The Lord Baltimore Press**  
BALTIMORE, MD., U. S. A.



## FOUR NEW MAMMALS FROM THE CANADIAN ROCKIES

By N. HOLLISTER

A small party from the Smithsonian Institution accompanied the Alpine Club of Canada expedition to Jasper Park and the Mount Robson region, during the summer of 1911. Among the mammals collected are specimens of a new chipmunk, a new mantled ground-squirrel and two new bats.<sup>1</sup>

### **EUTAMIAS LUDIBUNDUS, sp. nov.**

*Type* from Yellowhead Lake,<sup>2</sup> British Columbia; 3700 feet. Cat. No. 174225, U. S. National Museum; skin and skull, female adult. Collected August 29, 1911. N. Hollister; original No. 3987.

*General characters*.—A large member of the *amanus* group, nearest related to *Eutamias luteiventris*, but with sides of quite a different tint; darker and more tawny, less bright and yellowish. Underparts without the yellowish color of *luteiventris*; tail darker beneath.

*Color of type* (post-breeding pelage).—Top of head, rump, and upper surface of hind legs to heel, grizzled hair-brown. Five dark stripes on back nearly pure black; the two inner light stripes grayish; outer light stripes creamy-white, mixed with gray. Checks, sides, shoulders, and fore legs, dark cinnamon; feet wood brown. Ears blackish outside, brown inside; a white area at base extends to tip of ear in a broad band. Underparts whitish, without yellowish tint, but with a faint suffusion of cinnamon-tawny on sides of middle of belly. Tail above mixed black and dark buff; below with central area russet, bordered by bands of black and tawny-olive.

*Skull*.—Like skull of *Eutamias luteiventris*, but averaging slightly larger.

*Measurements of type*.—Head and body, 126 mm.; tail vertebrae, 96; hind foot, 34. Skull: Greatest length, 33.7; condylobasal length, 31; zygomatic breadth, 19.6; upper tooth row, 5.5.

<sup>1</sup>Some new species of birds collected by this expedition are described by J. H. Riley in Proc. Biol. Soc. Washington, Vol. 24, pp. 233-236, 1911.

<sup>2</sup>This is the Cowdung Lake of many maps. It lies about six miles west of the Alberta-British Columbia line, in Yellowhead Pass.

*Remarks.*—This chipmunk is not closely related to either *Eutamias affinis* or *E. borealis*, but is apparently a northern form of *luteiventris*. It bears some resemblance to *Eutamias felix*, but is readily distinguished from that species by its much less reddish coloration. The close similarity between the skulls of *felix*, *ludibundus*, and *luteiventris*, and the general type of coloration exhibited by all three, make it seem possible that series of specimens collected between the known ranges will show intergradation between these forms. At present the material does not warrant treating them as subspecies. From *E. borealis*, with which it does not intergrade, in this region at least, *ludibundus* may be easily separated by its large size, large foot, reddish, not gray, tail, and larger skull. Specimens of *E. borealis* were collected by our party at Prairie Creek, and at Brule Lake, Alberta. West of these points, at Henry House, Alberta, and along the British Columbia boundary line, all the chipmunks collected are of this new form. From *E. affinis*, this form differs conspicuously in the general color of the back and rump, showing far less clear white, and with rump, legs, and inner light stripes much darker brownish-gray; cheeks, shoulders, and sides very much darker. I am under obligations to Mr. Arthur H. Howell for pertinent criticism and assistance during my work in this most difficult genus.

A large series of specimens of this new chipmunk was collected, all from the region along the boundary line between British Columbia and Alberta, from Yellowhead Pass northward.

**CALLOSPERMOPHILUS LATERALIS TESCORUM**, subsp. nov.

*Type* from head of Moose Pass branch of the Smoky River, Alberta (near Moose Pass, B. C.), at 7000 feet. Cat. No. 174165, U. S. National Museum; skin and skull, male adult. Collected August 2, 1911. N. Hollister; original No. 3863.

*General characters.*—Nearest to *Callospermophilus lateralis cinerascens*, but larger, darker, and richer colored; mantle darker and extending further back over shoulders; under side of tail clear cinnamon color with black subterminal border to hairs (in *cinerascens* the under side of the tail is mixed pale buff and black); upper side of tail with less black.

*Color of type.*—Nose, top and sides of head, neck and shoulders, glossy Mars brown; ring around eyes, whitish; back grizzled brownish-gray, darkening on rump. Lateral stripes sharp and distinct, the dark ones clear black from shoulders to middle of body, the posterior half colored like back; inner black stripes short, reaching only little

past the middle of body. Shoulders and upper part of fore legs suffused with blackish. Hind legs dark brown outside to heel. Tail above black and buff mixed; below with central area clear cinnamon, border black and cinnamon-buff. Sides and underparts of body buffy-white, strongly suffused with darker buff.

*Skull and teeth*.—Skull averaging larger than that of *C. l. cinerascens*, with slightly larger teeth.

*Measurements*.—Type: Head and body, 198 mm.; tail vertebrae, 105; hind foot, 45. Average of nineteen specimens from type region compared with average of fifteen specimens of *cinerascens* from Montana, the latter in parentheses: Head and body, 194 (178); tail vertebrae, 104 (95); hind foot, 43 (40.9). Skull of type: Greatest length, 47; condylobasal length, 44; zygomatic breadth, 29.4; nasals, 15.5; upper tooth row, 9.0.

*Remarks*.—Twenty-seven specimens of this new form were collected, twelve at the type locality, and fifteen at nearby points across the line in British Columbia.

#### MYOTIS ALTIFRONS, sp. nov.

*Type* from Henry House, Alberta, at 3350 ft. altitude. Cat. No. 174133, U. S. National Museum; skin and skull, adult male (teeth considerably worn). Collected September 5, 1911. J. H. Riley; original No. 2317.

*General characters*.—About the size of *Myotis lucifugus*, but differing widely in color and cranial characters. Upperparts very dark brown; forearm shorter than in *M. lucifugus longicrus*, longer than in *M. yumanensis saturatus*; border of interfemoral membrane without trace of fringe; wing from base of toes; tragus long and narrow. Skull with unusually inflated braincase, giving the effect of a turned up nose much as in *M. capitaneus* from Lower California.

*Color of type*.—Upperparts very dark brown; the underfur dull black, and hair tips brown; a thin border of clear burnt umber hairs between hips, around base of interfemoral membrane. Underparts dark drab-brown. Ears and membranes blackish.

*Skull and teeth*.—Skull about the size of skulls of *M. l. longicrus*; facial concavity greater; braincase higher, the inflation of the anterior portion making it appear very much larger, compared with rostrum, than in *lucifugus* or any of its forms. The teeth in the type specimen are much worn, but appear to be essentially as in *longicrus*.

*Measurements of type*.—Head and body, 49 mm.; tail vertebrae, 39.5; hind foot, 9.5 (measured in flesh by collector); forearm, 36.5;

tibia, 17; ear from notch, 13; tragus from notch, 6.7 (from dry skin). Skull: Condylbasal length, 13.7; breadth of braincase, 8.0; interorbital breadth, 4.4; upper tooth row, including canine, 5.4.

*Remarks.*—This bat is immediately distinguishable from any species known from the United States and Canada by the peculiar high and inflated braincase and apparent shortness of the rostrum. The color is even slightly darker than the darkest skins of *M. l. alascensis* and *M. y. saturatus* that I have seen. It is slightly larger than *M. kecnii*, with smaller ear and tragus. The species is based upon a single specimen.

**MYOTIS PERNOX, sp. nov.**

*Type* from Henry House, Alberta. Cat. No. 174134, U. S. National Museum; skin and skull, adult male. Collected September 6, 1911. J. H. Riley; original No. 2318.

*General characters.*—A dark brown *Myotis*, externally resembling *M. lucifugus lucifugus*, but with larger foot. Interfemoral membrane edged with scattering hairs. Skull differs from that of *lucifugus* in its larger size and more depressed braincase.

*Color of type.*—Upperparts uniform glossy brown, nearest to the bistre of Ridgway; underparts dark Isabella color; ears and membranes blackish.

*Skull and teeth.*—The skull is essentially like that of *M. lucifugus lucifugus*, except that the size is greater, and the braincase is much flattened. The ventral surface, including the teeth, presents much the same appearance, except for size, as does that of *lucifugus*.

*Measurements.*—Type and topotype, the latter in parentheses: Head and body, 53 mm. (54); tail vertebrae, 39 (44); hind foot, 11 (12), measured in flesh by collector. Forearm, 37.7 (38.6); tibia, 16.7 (17); ear from notch, 12.5 (12.2); tragus from notch, 7.6 (8.0), from dry skin. Skull: Condylbasal length, 14.8 (14.9); breadth of braincase, 8.0 (8.0); interorbital breadth, 4.1 (4.2); upper tooth row, including canine, 5.5 (5.7).

*Remarks.*—This bat might, from external examination, be readily mistaken for *M. lucifugus lucifugus*, but the characters of the skull will at once distinguish it. The black ears and membranes also serve to separate it; *M. l. lucifugus* has brown wings and interfemoral membrane. Two specimens of this species, both males, were collected the same evening.





SMITHSONIAN MISCELLANEOUS COLLECTIONS

VOLUME 56, NUMBER 27

# A NEW KINGFISHER FROM PANAMA

BY

E. A. GOLDMAN



(PUBLICATION 2058)

CITY OF WASHINGTON  
PUBLISHED BY THE SMITHSONIAN INSTITUTION  
DECEMBER 1, 1911

*The Lord Baltimore Press*  
BALTIMORE, MD., U. S. A.



## A NEW KINGFISHER FROM PANAMA

By E. A. GOLDMAN

Among the birds obtained in the course of the Smithsonian Biological Survey of Panama<sup>1</sup> are 28 kingfishers of the *Ceryle americana* group. Comparison of this large series, and examination of the birds from numerous localities in northern South America and within the wide distribution area (Panama to southern United States) originally assigned to *Ceryle septentrionalis* Sharpe, show that two well-marked races have been united under this name. One of these ranges northward through Panama, Costa Rica, Nicaragua, and Honduras to Guatemala, passing thence into the form which reaches the southern border of the United States.

When *Ceryle septentrionalis* Sharpe was originally described no type specimen or type locality was mentioned, but Mr. C. Chubb, of the British Museum, has very kindly written me, under date of October 13, 1911, the following: "In reply to yours respecting *Ceryle septentrionalis* Sharpe, I have much pleasure in saying that the types of the original descriptions of the male and female were collected at Teapa, Mexico, in March, no year or day of month given, by D. W. S., who is the wife of H. H. Smith; these form a part of the Salvin-Godman Collection." Teapa, Tabasco, Mexico, must therefore be accepted as the type locality of *C. a. septentrionalis*. Fortunately this locality is within the geographic range of the most northern form of the group, so that the name is well applied.

This disposal of *C. a. septentrionalis* leaves the hitherto unseparated form of the southern part of Middle America without a name. It may be characterized as follows:

### CERYLE AMERICANA ISTHMICA, new subspecies

*Type* from Rio Indio (near Gatun), Canal Zone, Panama. No. 207628, male adult, U. S. National Museum (Biological Survey collection), collected by E. A. Goldman, February 23, 1911. Original number, 13820.

<sup>1</sup>This paper is the fourth dealing with the results of the Smithsonian Biological Survey of the Panama Canal Zone.

*Characters*.—Similar to *C. americana americana*, but larger, with stouter bill; greenish-black submalar stripe narrower; chestnut-rufous pectoral area of male less extended anteriorly (encroached upon by white of throat); greenish-black pectoral bands of female narrower, more interrupted. Similar to *C. americana septentrionalis*, but smaller; wings more narrowly banded with white; pileum much less distinctly flecked with white anteriorly; male with under parts more heavily spotted with greenish-black, the chestnut-rufous pectoral area more extended anteriorly (less encroached upon by white of throat); female with broader pectoral bands.

*Measurements*.—Type: Wing, 79.5 mm.; tail, 55.6; culmen, 45.5; depth of bill at anterior angle of nostril, 9.5; width of bill at anterior angle of nostril, 6.7; tarsus, 8.7.

SMITHSONIAN MISCELLANEOUS COLLECTIONS

VOLUME 56, NUMBER 28

DESCRIPTION OF A NEW SPECIES OF SUN-  
BIRD. *HELIONYMPHA RAINEYI*. FROM  
BRITISH EAST AFRICA

BY

EDGAR A. MEARNS



(PUBLICATION 2059)

CITY OF WASHINGTON  
PUBLISHED BY THE SMITHSONIAN INSTITUTION  
NOVEMBER 28, 1911

**The Lord Baltimore Press**  
BALTIMORE, MD., U. S. A.

DESCRIPTION OF A NEW SPECIES OF SUNBIRD,  
HELIONYMPHA RAINEYI, FROM BRITISH  
EAST AFRICA

By EDGAR A. MEARNS

Upon examining the first lot of birds sent to the United States National Museum by the Rainey African Expedition, I find the following apparently new species.

**HELIONYMPHA RAINEYI, new species<sup>1</sup>**

Rainey's Wedge-tailed Sunbird

*Type-specimen*.—Adult male, molting. Cat. No. 217483, U. S. N. M. Collected at the Telek River, Sotik District, British East Africa, May 16, 1911, by Edmund Heller. Original number, 136.

*Characters*.—In coloration almost exactly like *Cinnyris mariquensis suahelica* Reichenow, but with a much longer bill, shorter wing, and elongated pointed central pair of rectrices.

*Description*.—Pileum, cervix, mantle, and rump metallic golden green; wings brownish blue-black; upper tail-coverts bluish green; tail brownish black, the central feathers narrowly edged with green; chin and throat metallic golden green; upper chest with a transverse band of metallic blue, succeeded, posteriorly, by a broader band of brownish red; abdomen and crissum brownish black; bend of wing metallic green; axillars and under wing-coverts black. In dry skins the bill, feet, and claws are black.

*Measurements of type* (adult male).—Length (of skin), 138 mm.; wing, 66; tail (molting), 57; exposed culmen (chord), 22; tarsus, 17.

*Measurements of adult male topotype* (Cat. No. 217484, U. S. N. M.).—Length (of skin), 130; wing, 66; tail (molting), 49; exposed culmen (chord), 22; tarsus, 18.

*Remarks*.—This bird is most closely related to *Helionympha erythrocerca* (Henglin), but in coloration bears a closer resemblance to *Cinnyris mariquensis suahelica* Reichenow.

---

<sup>1</sup>Named in honor of Mr. Paul J. Rainey, in recognition of his services to biological science in connection with the Rainey African Expedition.

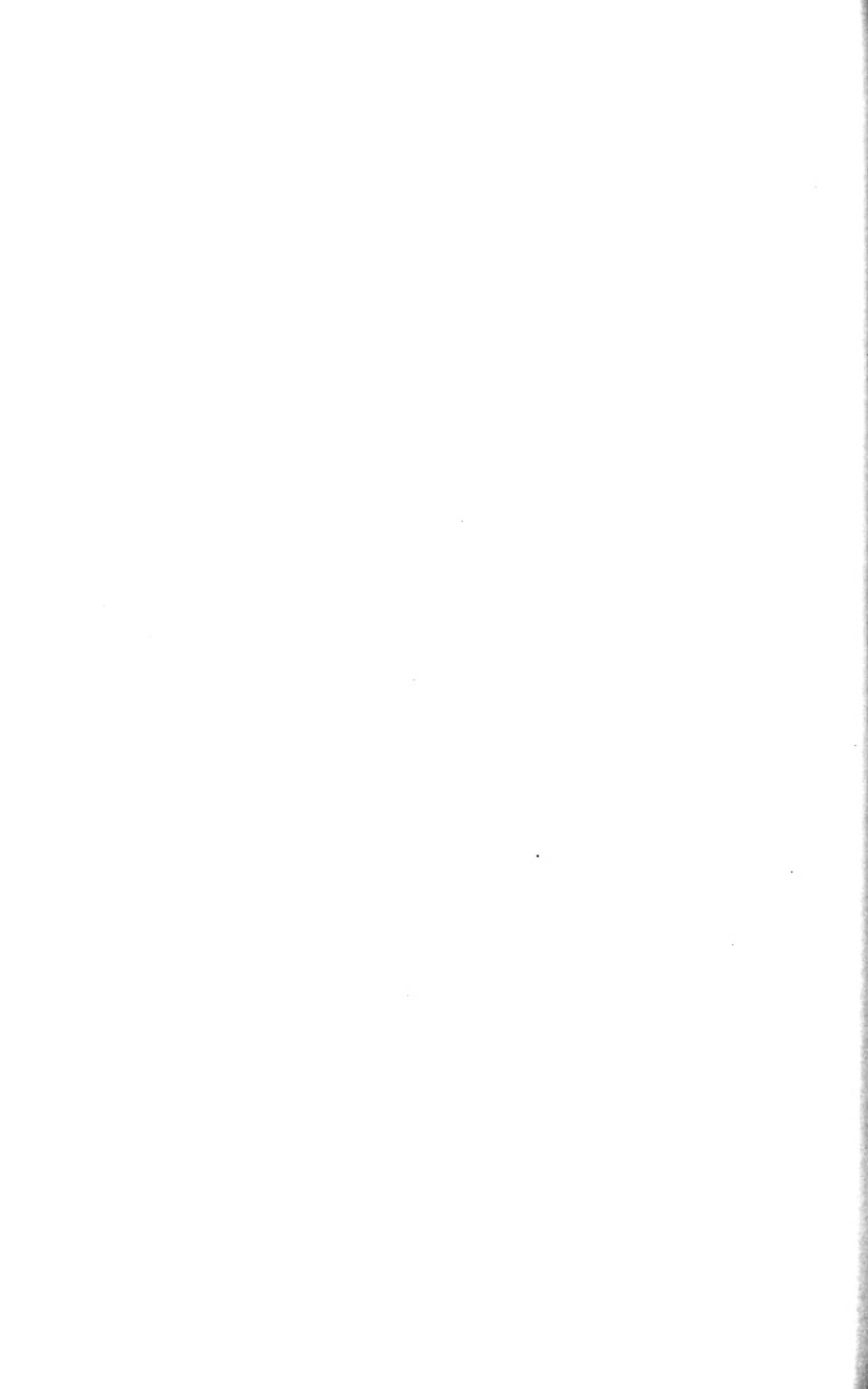

SMITHSONIAN MISCELLANEOUS COLLECTIONS

VOLUME 56, NUMBER 29

# THREE NEW CLUB-MOSSES FROM PANAMA

WITH THREE PLATES

BY

WILLIAM R. MAXON



(PUBLICATION 2064)

CITY OF WASHINGTON  
PUBLISHED BY THE SMITHSONIAN INSTITUTION  
JANUARY 6, 1912

*The Lord Baltimore Press*  
BALTIMORE, MD., U. S. A.



## THREE NEW CLUB-MOSSES FROM PANAMA<sup>1</sup>

BY WILLIAM R. MAXON

WITH THREE PLATES

In a previous paper<sup>2</sup> relating to a singular new fern (*Polypodium podocarpum*) from Panama, I have described very briefly the mountain region above David in the province of Chiriqui, and have referred in particular to a most interesting collecting trip of three days which I took from El Boquete over "Holcomb's trail" along the Rio Caldera to "Camp I" and to the summit of the Continental Divide a few miles farther on. The heavily forested mountain slopes are here intensely wet, and, as is usual under such conditions, a large proportion of the pteridophyta are epiphytes. Species of *Lycopodium* do not appear to be very common, but of the several collected three seem to have been hitherto unknown. These may be described as follows:

### **LYCOPODIUM FOLIACEUM** Maxon, sp. nov.

#### PLATE I

A coarse, stout, diffuse epiphyte, probably of ascending growth, attaining a length of 40 cm., sporangiate without interruption in the upper third or half, the sporophylls similar to the foliar leaves but gradually smaller toward the ends of the branches. Stem very stout, woody, about 4 mm. in diameter at the base, 1 to 4 times dichotomous, the branches divaricate, about 2 mm. in diameter near the tips; leaves very numerous and close, borne in 10 ranks and by torsion somewhat dorsiventrally arranged, those of the 8 under and lateral ranks usually divergent at right angles (except in drying) or slightly ascending, twisted at the base, those of the 2 uppermost rows strongly reflexed, straight, all the leaves otherwise alike, symmetrical, rigidly herbaceous to subcoriaceous, oblong-elliptic to oblanceolate from a narrowly long-cuneate base (the base reddish-punctate below), thus sometimes appearing subspatulate, 10 to 13.5 mm. long, 2.5 to 4.5 mm. broad near

<sup>1</sup> This paper is the fifth dealing with the results of the Smithsonian Biological Survey of the Panama Canal Zone.

<sup>2</sup> Smithsonian Misc. Coll., Vol. 56, No. 24, pp. 1-4, pls. 1-3, November 22, 1911.

the middle, the margins strongly revolute, entire except at the minutely crose-denticulate, acute or short-cuspidate apex; costæ medial, percurrent, the leaf in drying sharply carinate upon the upper surface, the costæ sometimes evident below near the base, but usually indicated along the under surface of the leaf throughout merely by a shallow medial furrow; sporophyls conform, rarely more than 10 mm. long; sporangia reniform, about 2 mm. broad, protruding beyond the narrow bases of the sporophyls a distance of about 0.5 mm. on each side.

Type in the U. S. National Herbarium, no. 676073; collected from a fallen branch in humid forest along the upper Caldera River, near Camp I, Holcomb's trail, above El Boquete, Chiriqui, Panama, altitude about 1650 meters, March 23, 1911, by William R. Maxon (no. 5628).

The specimens here described were found upon a large limb which had been broken off from an enormous forest tree upon the steep slopes above and partially obstructed the trail at a point not far above Camp I. The species is very different from any reported previously from North America, and from any South American species known to me. It is a coarse, "bushy" plant and, when in a fresh condition, very heavy. Though not succulent it was long in drying, and then very rigid. The arrangement of the leaves can scarcely be made out except by soaking the plant in water, when the number of ranks of leaves, the twisting of all but those of the two upper rows, and the reflexed position of the latter are features which become readily apparent. Including the spreading leaves the diameter of the larger stems is from 2.5 to 3 cm. The apparent abundance of leafy covering, which has suggested the specific name, is even more pronounced in the living than in the dried specimens.

**LYCOPODIUM STAMINEUM** Maxon, sp. nov.

PLATE 2

Plant about 20 cm. long, 3 times dichotomous (probably repeatedly so in larger specimens), the stem relatively stout, about 1.5 mm. in diameter at the base, 1 mm. in diameter near the apex, more or less succulent, flattened in drying; leaves rather crowded in attachment, borne apparently in 10 ranks, spreading at right angles to the stem, filiform, acicular in the outer part, 10 to 17 mm. long, 0.2 to 0.3 mm. broad, bright red at the base (at least upon the under side), the margins entire and in drying curved inward over the upper surface, the leaves thus broadly concave above or even subtubulose; plant fertile in the upper third, the sporangia borne in alternating zones,

the sporophylls exactly like the foliar leaves; sporangia reniform, 1.2 to 1.3 mm. broad, thus protruding beyond the base of the sporophyll a distance of about 0.5 mm. on each side.

Type in the U. S. National Herbarium, no. 676085; collected from a tree trunk in humid forest of the upper Caldera watershed between Camp I and the Divide, Holcomb's trail, above El Boquete, Chiriqui, Panama, altitude about 1750 meters, March 23, 1911, by William R. Maxon (no. 5636).

Only three plants of the present species were observed, these growing together; the largest has served for the description. Presumably the plant attains a greater size than shown by the specimens at hand; but even this small amount of material is ample to indicate the marked peculiarity and distinctness of the species. The leaves are truly capillary and mark it as the narrowest-leaved species yet discovered in tropical America. It is a member of the section *Selago*, and is related (though not at all closely) to *L. pithyoides* Schlecht. and Cham., of Mexico, Guatemala, and Cuba, a species which is equally well marked by its stout woody stems and very much longer, bisulcate, reflexed leaves about 1 mm. broad.

**LYCOPODIUM WATSONIANUM** Maxon, sp. nov.

PLATE 3

A slender pendent epiphyte, 35 cm. long, about 8 times dichotomous, interruptedly sporangiate in the upper third. Stem delicate, 0.5 to 0.7 mm. in diameter, yellowish green like the whole plant, the branches slender, unequally developed (perhaps through injury), forked at a slight angle; leaves numerous but not close, borne in 8 ranks, in the dried plant appearing almost whorled, divergent to obliquely ascending, mostly falcate, slender but very rigid, thick, linear-acicular from a slightly broader base, 5 to 8 mm. long, 0.4 to 0.5 mm. broad at the base, 0.3 to 0.4 mm. broad below the middle, or much narrower by the curvature of the margins, entire, all twisted at the base, the upper surface slightly convex, the lower surface broadly or sometimes deeply concave, the leaf in drying not infrequently subtubulose or irregularly plicate, the costae very slender, concealed, or evident only by transmitted light as a whitish line; sporophylls in alternating zones 1 to 1.5 cm. long, averaging shorter than the foliar leaves (4 to 5 mm. long), linear-acicular from an irregularly ovate to broadly deltoid base (this 0.7 to 1 mm. broad), the margins here undulate to irregularly and bluntly crose-dentate, elsewhere entire; sporangia reniform, partially concealed by the expanded bases of the sporophylls.

Type in the U. S. National Herbarium, no. 676223; collected from the trunk of a small forest tree in humid forest along the upper Caldera River, near Camp I, Holcomb's trail, above El Boquete, Chiriqui, Panama, altitude about 1600 meters, March 24, 1911, by William R. Maxon (no. 5712).

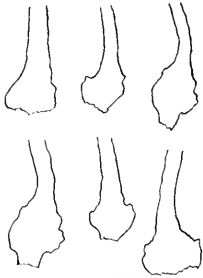
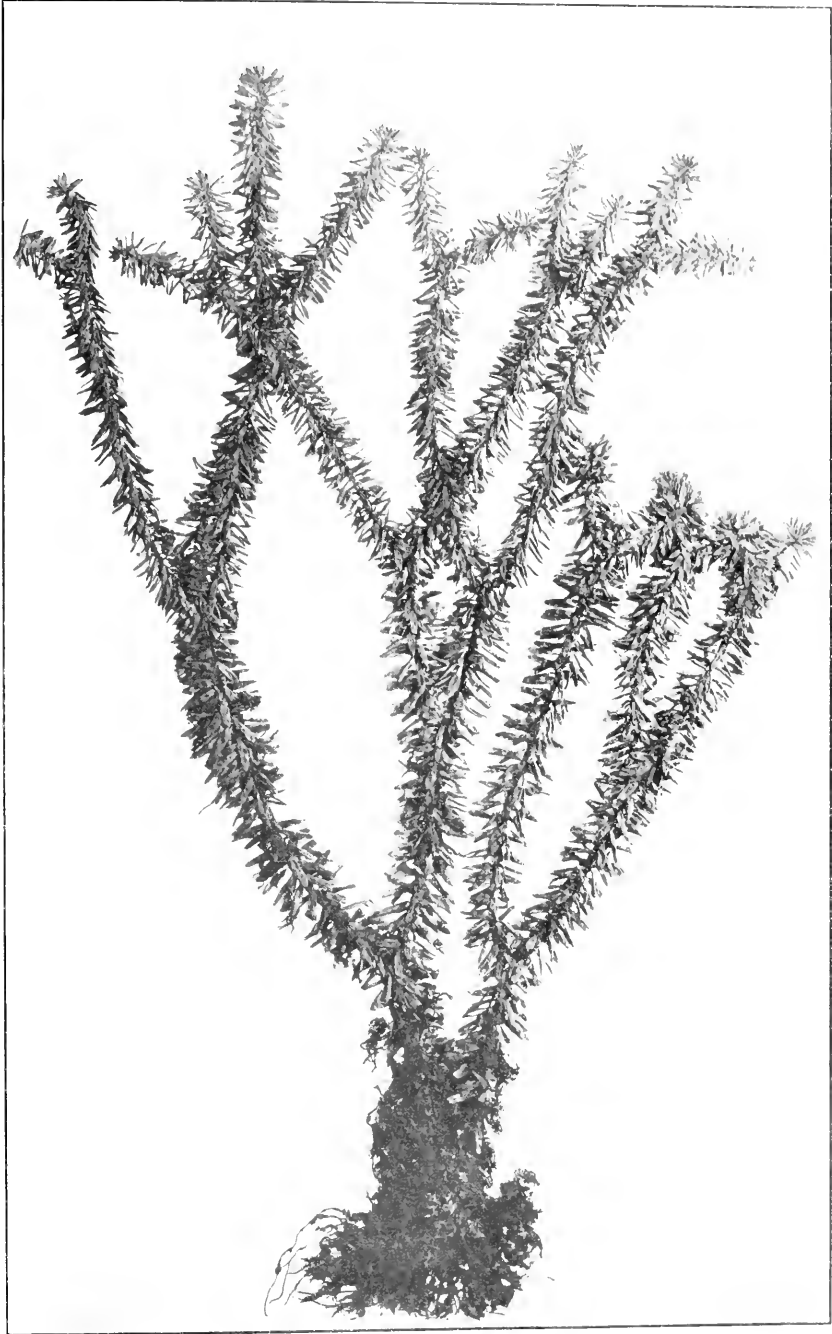

FIG. 1.—Bases of Sporophylls.

*L. Watsonianum* is of the section Selago and the group of *L. limifolium*, but is not closely related to any North American species. The leaves are harsh to the touch, and the branches remarkably rigid for so slender a plant. The irregular expanded bases of the sporophylls, an unusual feature for this group of species, are indicated in the text-figure herewith.

Dedicated to H. J. Watson, Esq., a resident of El Boquete, who during the last twenty years not only has been of very great assistance to naturalists visiting the mountain region of Chiriqui, but has himself made extensive zoölogical collections.



LYCOPIDIUM FOLIACEUM Maxon  
(TWO FIFTHS NATURAL SIZE)



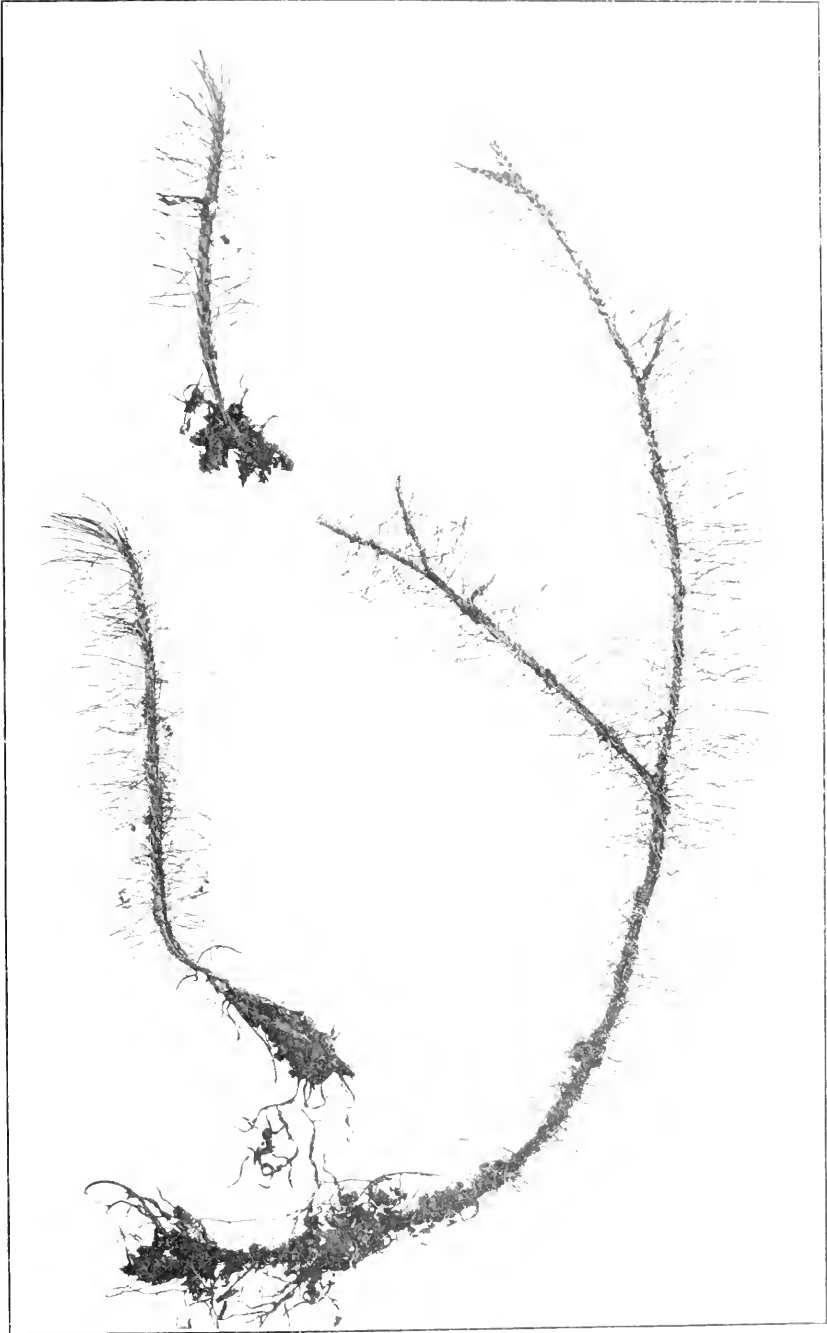

LYCOPODIUM STAMINEUM Maxim  
(NATURAL SIZE)





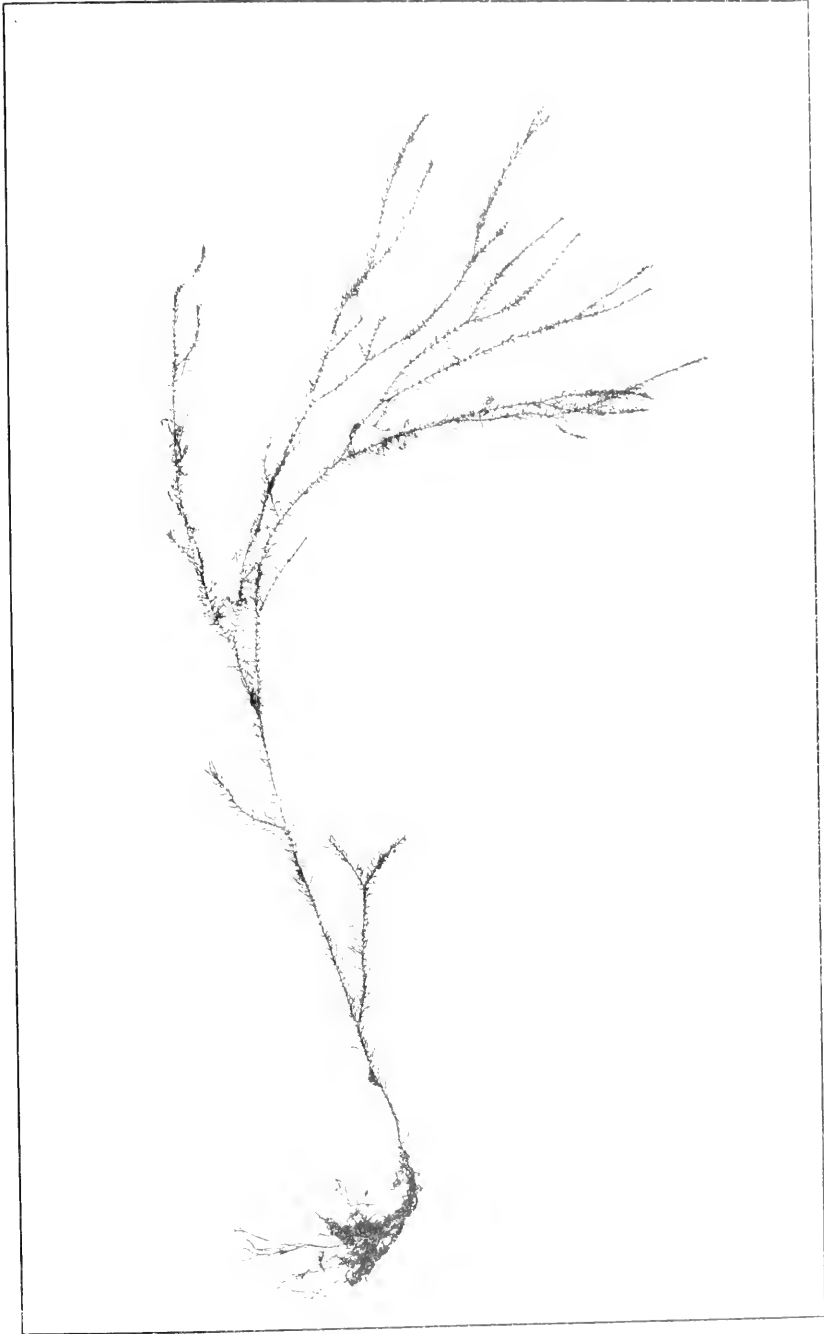

LYCOPodium WATSONIANUM Maxon  
(ONE HALF NATURAL SIZE)







SMITHSONIAN MISCELLANEOUS COLLECTIONS

VOLUME 56, NUMBER 30

A NEW SUBSPECIES OF PTARMIGAN  
FROM THE ALEUTIAN ISLANDS

BY

A. C. BENT



(PUBLICATION 2066)

CITY OF WASHINGTON  
PUBLISHED BY THE SMITHSONIAN INSTITUTION  
JANUARY 6, 1912

The Lord Baltimore Press  
BALTIMORE, MD., U. S. A.

A NEW SUBSPECIES OF PTARMIGAN FROM THE  
ALEUTIAN ISLANDS

By A. C. BENT

The new subspecies of Ptarmigan here described was collected at Tanaga Island, Alaska, during a brief visit to the Aleutian Chain in the summer of 1911 for the purpose of gathering material for the continuation of the work on the Life Histories of North American Birds, published by the Smithsonian Institution several years ago. The subspecies is named in honor of Dr. Leonard C. Sanford, of New Haven, Conn. Good series of this bird and of its nest were collected. Near the beach and on the tundra of Tanaga Island the birds were abundant and tame.

**LAGOPUS RUPESTRIS SANFORDI**, new subspecies

Tanaga Ptarmigan

*Subspecific characters.*—Similar to *Lagopus rupestris chamberlaini*, Clark, and to *L. r. atkensis*, Turner, but much lighter than either, especially on the throat and breast, the darkest specimens of *sanfordi* being somewhat lighter than the lightest specimens of either of the other forms and the average difference being well marked and fairly constant. Less heavily barred with black on head, throat and chest; black loreal space less conspicuous; and with fewer black markings in feathers of back.

*Description of male.*—(Type, adult male, Cat. No. 222527 U. S. Nat. Mus., Tanaga Island, Aleutian Chain, Alaska, June 25, 1911. R. H. Beck.) General tone of the summer plumage light greyish buff, paler on the throat, chest, rump and upper tail-coverts than elsewhere.

Ground colors of upper parts varying from pale clay color or wood brown in the darkest birds to very pale drab grey, almost whitish, in the lightest birds; generally all of these and several intermediate shades of color showing on different feathers scattered indiscriminately over the back, scapulars and rump. The lightest feathers tipped with whitish, having irregular subterminal black bars and finely sprinkled with minute black dots. The darkest feathers ochraceous or clay-colored, with large central black spaces and irregularly barred or vermiculated with black. Feathers of intermediate colors more or less barred or sprinkled with black.

Central tail feathers wood brown, more or less finely sprinkled with black. The lateral rectrices dull seal brown, more or less variegated basally on the outer web with broccoli brown more extensively towards the center of the tail. Chin and upper throat dull white tinged with buff, sometimes heavily spotted with black. Breast and sides varying from very pale buff to ochraceous buff finely vermiculated with black. Abdomen, under tail-coverts, feet and wings white. Shafts of primaries dusky, usually with a median dusky streak, which in some specimens occupies more than half of the width of the web and in others is scarcely visible. The supraorbital comb is highly developed and varies in color from flame scarlet to orange vermilion. Measurements of type: wing 197, tail 108, tarsus 33 and culmen 18 millimeters.

*Description of female.*—Upper parts, including head, back, scapulars, upper tail-coverts and central rectrices, variegated with shades of ochraceous, clay color, buff and pale wood brown, heavily and irregularly barred with black; many feathers on the hind neck, back, scapulars and rump have large central black spaces and very broad black bands. Under parts, from which all white disappears in summer, uniform rich ochraceous buff, barred on the breast and sides with black, sparingly barred on the abdomen and but sparingly spotted on the throat. Wings white, primaries marked as in the male. Tail similar to that of the male. Supraorbital comb smaller and duller than that of the male.



SMITHSONIAN MISCELLANEOUS COLLECTIONS

VOLUME 56, NUMBER 51

REPORT ON AN INVESTIGATION OF  
THE GEOLOGICAL STRUCTURE  
OF THE ALPS

BY

BAILEY WILLIS



(PUBLICATION 2067)

CITY OF WASHINGTON  
PUBLISHED BY THE SMITHSONIAN INSTITUTION  
FEBRUARY 7, 1912

The Lord Baltimore Press  
BALTIMORE, MD., U. S. A.

## REPORT ON AN INVESTIGATION OF THE GEOLOGICAL STRUCTURE OF THE ALPS.<sup>1</sup>

By BAILEY WILLIS

Eight years ago I first had the pleasure of meeting Prof. Maurice Lugeon on the memorable occasion of his striking address and remarkable triumph at the Vienna Congress of Geologists in 1903. The subject of overthrusts which he then discussed so graphically and with so much force was not unfamiliar to me, that type of structure having been recognized first by the American geologist Rogers, whose observations I had had occasion to verify. I was, therefore, fully prepared to accept the view that the Alps had been overthrust. I did not then, and I do not now, doubt that they consist chiefly of overthrust masses. Nor do I question the amount of displacement. Even the greatest horizontal movements which are postulated to account for the various nappes that have been observed, are relatively small as compared with the long arcs of the earth's periphery, in which the movement must have originated; and the accumulated effect which we may observe in any case should not occasion doubt.

It is a pleasure to me to be able to agree with Prof. Lugeon in these fundamental conceptions of the importance and extent of overthrusting in the structure of mountain chains, and particularly of the Alps. I regret the more that there are differences of opinion between us as to the mechanics of overthrusts, and that this divergence of interpretation is such that I have not been able to accept his views on the structure of the Alps as cordially and fully as I should like to do. But, inasmuch as Alpine structure is one of the great types from which our science draws essential conclusions, I hold it to be important to reach a correct interpretation of it, and I have for some years assiduously endeavored to understand the basis of Prof. Lugeon's views and the grounds upon which they have been accepted generally by European geologists. Through the aid of the Smithsonian Insti-

---

<sup>1</sup> This investigation was carried on by means of a grant from the Smithsonian Institution in 1907.

tution, I visited, in 1907, certain critical districts in the Bernese Alps and was most courteously guided to significant localities in the Diablerets and near Château d'Eux by Prof. Lugeon and M. Jaccard. The observations which I was thus enabled to make confirmed my opinion that the visible structures must be essentially those which Prof. Lugeon had described as seen by him, but that his interpretation rests upon mistaken assumptions and is erroneous. The detail of his observations and the painstaking care with which they are made are worthy of the highest recognition, but, in my opinion, the purely hypothetical formula expressed in the conventional figure of a "pli-nappe" is incorrect.

In the interests of our science, I have sincerely hoped that Prof. Lugeon would explain the structure and movement of the "nappes de recouvrement" as he conceives them, and that his explanation would include such modifications of the accepted theory that it would not contradict the principles of mechanics. Particularly since the publication of the observations of Professor Rothpletz, in the section across Préalpes from Gurnigel to the Wildstrübel, it has seemed to me that the theory of the "nappes de recouvrement," involving the concepts of the "racine," the "carapace," and the "tête," must be justified or corrected. But, so far as I know, no adequate answer to Professor Rothpletz, nor any searching study of the mechanics of the "pli-nappe," has been made.

There is good ground, in my opinion, to question the following assumptions or inferences of the currently accepted theory of Alpine structure:

(1) That the overthrust masses of the Alps have all moved in one direction.

(2) That the so-called "racine" of a nappe de recouvrement is, in fact, the zone of origin of the thrust mass.

(3) That the supposed "tête" is that part of the structure which has advanced beyond the "carapace" and the "racine"!

(4) That the succession of overthrusts in the Bernese Alps has been as described, either in relations of space or time.

From the observations which I made in 1907, I infer that:

(1) Overthrusting in the zone of the Préalpes and Bernese Alps has proceeded at different epochs from opposed directions: namely, earlier from the northwest, later from the southeast.

(2) The so-called "racine" of the pli-nappe of the Wildhorn-Wildstrübel is, in fact, the southern and farthest advanced remnant of an overthrust from the northwest.

(3) The isolated masses of pre-Eocene strata, which have been called remnants of the tête or front of the same pli-nappe, and others which I saw near Château d'Eux, have been cut off by intersecting overthrusts. They first moved southward or southeastward and later northward or northwestward, in both movements rising on the inclined thrust planes. Their present position is thus above but not distant from that which they originally occupied. The same is true of the so-called "exotic" masses of the Préalpes which constitute the "têtes" of the hypothetical nappes des Klippes.

(4) The thrust which divides the pli de Morcles from that of the Diablerets is a minor thrust plane rising from a major thrust plane that underlies the Hautes-Alpes, and is one of a system of minor thrusts which, with the major thrust, constitute a single complex structure of the Scottish Highland type.

(5) Since the principal concrete example of a "pli-nappe" or nappe de recouvrement, that of the Wildhorn-Wildstrübel, is, according to my observation, not a pli-nappe but an effect of two intersecting thrusts, I am unable to accept the reconstruction of less complete nappes de recouvrement, which, according to modern theory, were once piled up, one overriding the other, to form the Alps. I regard it as probable that the recognition of intersecting overthrusts and of systems of major and minor thrusts of the Scottish type, combined with unusual but incidental folding, will eventually be found to explain a large part of Alpine structures.

The observations which led me to these views were as follows:

First, as to the existence of thrusts from opposed directions. The evidence of that fact I first observed near Lenk, in the valley and heights, up to and including the base of the Wildstrübel. It is stratigraphic, structural, and physiographic. For identification of strata in the field on paleontologic evidence I am indebted to Professor Rothpletz, whom I chanced to meet at Zweisimmen and with whom I examined the locality. We there discussed and verified our observations of structure. The physiographic relations, which had great weight with me because I had seen similar effects in the Lewis Range of Montana, were unfamiliar to him as a basis of inference, and may be regarded as an independent line of reasoning.

The stratigraphy of the district of Lenk, which lies in the southern Préalpes, is well established. The Triassic, Jurassic, and Eocene are more or less fully represented by very distinctive formations which, in the order named, are essentially gypsiferous shales or gypsum (Triassic), blue marine limestone (Jurassic), and sandy brown shales

(the facies of the Eocene, commonly called "Flysch"). The Cretaceous is scarcely present, there being a marked hiatus between the Jurassic limestones and the earthy red lime-shales that correspond to its highest horizon. The Flysch, which was originally a very thick formation, has been thickened by folding and thrusting, so that it constitutes the dominant rock of the hills. The Jurassic limestone and the Triassic gypsiferous shales occur in the Flysch as fragments which have been separated from their original connections by thrusting.

The internal structure of the Flysch is obscured by sward, but its principal features may be traced by the fragments of pre-Eocene formations. Where Jurassic or Triassic rests upon Flysch, the contact of the older upon the younger formation is obviously a thrust plane. Where two or more such contacts, though somewhat apart, fall into a common plane of dip, they may reasonably be connected as belong-

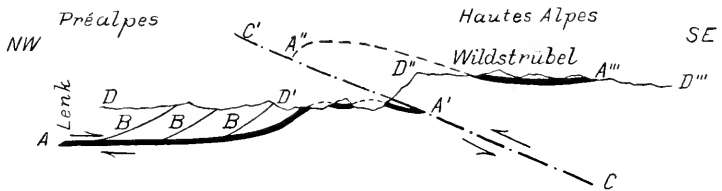

FIG. 1.—Diagram of intersecting thrusts observed near Lenk and in the Wildstrübel.

$AA'A''A'''$  = plane of a major thrust from the northwest.  $B, B, B,$  = minor thrusts branching from the major thrust  $AA'$  and belonging to one system with it.  $CC'$  = thrust from the southeast, intersecting and disturbing the older thrust  $AA'A''A'''$ .  $DD'$  and  $D''D'''$  = surface of erosion developed after the thrust  $AA'A''A'''$  and before the thrust  $CC'$ ; dislocated by the latter and involved in the elevation of the Hautes-Alpes.

ing to one and the same thrust. And where several such planes lie parallel one to another, they form a system of thrusts; such, for instance, as that diagrammatically represented by the minor thrusts  $B, B, B$  in Fig. 1.

Near Lenk, in the hills which rise on each side of the valley that is eroded across the strike, this structure is clearly represented by the fragments of Jurassic limestone that form little scarps in the smooth grass-grown slopes of Flysch. Having traced out the several parallel thrusts on one side of the valley, one may identify each one on the other side by corresponding features of the hills and slopes. This Professor Rothpletz and I did, and we observed that the planes of these parallel thrusts dip northwestward at moderate angles. Our observations

have been fully described by Professor Rothpletz in the article already referred to. (See p. 2.)

Beneath the valley and adjacent hills is a thrust plane which is nearly horizontal. It is exposed near Lenk in the very bottom of the valley, and has long been recognized by Swiss geologists as one of the major structural features of the "zone des Cols" and of the "Niesen." We observed that the Flysch at this contact rests upon the nummulitic Eocene; that is to say, that the terrigenous sandy shales had been thrust upon the marine limestone of the same general period.

The relation of this nearly horizontal thrust plane to those which, at steeper inclinations, traverse the hills on either side is that of a major thrust to minor thrusts of the same system, as shown by *B*, *B* to *AA'*, Fig. 1. The general dip is northwestward. In that direction the minor thrusts join the major thrust and the system is represented farther northwest by other minor thrusts.

In a region like the Alps, where thrust planes have been folded, the direction of thrusting cannot safely be inferred from the dip of a single plane. But granting this, it is quite a different matter when the inference rests on the agreement of several minor thrusts and the major thrust from which they spring. The system of major and minor thrusts to be seen at Lenk demonstrates that the Flysch of that region and the fragments of older strata included in it moved from northwest toward southeast.

This observation is surprising, because it is in such marked contradiction to the fact that European geologists have in recent years given up the idea of movements from the north or northwest. They appear to have abandoned the field too readily to those who assert that the Alps have been pressed northwestward only. At Lenk there is clear evidence of southeastward movement.

It will be necessary to identify this mass which has been thrust southward, in its southern extension. But before doing so, it is desirable to refer here to the great thrust that underlies the Wildstrübel and other portions of the Bernese Hautes-Alpes (*CC'*, Fig. 1). It is, of course, well-known. With the superb recumbent fold which is so magnificently exposed in the face of the Wildstrübel, it constitutes a most striking example of that structure which is now described as a "pli-nappe," and which Rogers first recognized in the Appalachians as an overturned anticline and reversed fault. Heim elucidated the mechanics of the structure. It has been experimentally reproduced. The overturned anticline precedes displacement on the thrust plane when a couple of opposed forces develops in strata in

the zone of moderate load and folding; but when dislocation originates in the deeper zone, where excessive load prevents competent folding, the movement, on being transmitted to strata in the zone of folding, may produce a recumbent anticline as an incidental structure. Displacements of the former class are usually of moderate horizontal throw, rarely more than ten or twenty kilometers, but they may be features of a very extensive general movement. Such I take this pli-nappe of the Wildstrübel to be: an overturned anticline which has been pushed far enough to dislocate the middle limb, although not necessarily to a great distance. It is, however, a striking feature of the pronounced movement of the mass of the Alps from southeast toward northwest. Since there is no question of this movement toward the northwest, we may accept it without discussion.

I must here advert to the difference of facies between the strata of the Préalpes and those of the Hautes-Alpes. The former is an incomplete sequence, comprising but a few of the Mesozoic stages and the Eocene. The latter is a very complete succession from Triassic to Eocene inclusive. The one is composed chiefly of sands and muds, the other of marine limestones. The contrast could scarcely be more marked.

Accepting this well-known distinction, we may say that the two facies are superimposed, each on the other, by the thrusts from opposite directions. The Flysch of the Préalpes, in being thrust toward the southeast on the major thrust plane, came to rest on the surface of the marine nummulitic Eocene of the facies of the Hautes-Alpes. This contact is seen in the valley floor near Lenk, as already described. The marine strata which form the Hautes-Alpes may, in turn, be seen superimposed on the Flysch at the base of the great cliffs which form the face of the Wildstrübel south of Lenk. The contact marks the thrust plane, which dips southeast and on which movement was toward the northwest.

Having become convinced, contrary to my expectations, but by my own observations, that the structures of this district comprise two intersecting systems of overthrusts, I sought to determine which might be the older system. The evidence on this point is unequivocal.

Going from Lenk southward to the base of the Wildstrübel one may observe that the major and minor thrusts of the system on which displacement was southward rise in the hills. Near Lenk the planes dip nearly uniformly. Near the base of the Wildstrübel they are folded into anticlinal and synclinal structures. Although long fa-



miliar with folded thrust planes as they occur in the Appalachians and have been described by Keith, I have never elsewhere seen such clear and convincing examples as are to be found here. The anticline of the Iffigental, which shows a superb arch of Jurassic limestone overlying the Eocene Flysch, is without an equal in my experience for perfection and simplicity; and the folded thrust planes of the foothills north of the Wildstrübel (Oberlaubhorn and Laufbodenhorn), though more intricate, are no less clearly defined. At the immediate base of the Wildstrübel the disturbance of the thrust planes is more intricate and minute. They are affected by shearing as well as by folding; and tracing these minor secondary structures directly to the great overthrust on which movement was from the opposite direction, one cannot doubt that they were produced by that movement. Hence, the thrust from the southeast is younger than that from the northwest.

A method of investigation which has been more widely adopted by American geologists than by those of Europe, is based upon the relation that may exist between structures, such as folds or thrusts, and the features developed by erosion. I know many mountain ranges whose internal structures are older than the erosion of the surface. I know others whose relief is an effect of relatively recent folding or thrusting. On examining the *Préalpes* and *Hautes-Alpes* with this relation in mind, I found a clear distinction between the movement from the northwest, which is older than any recognizable erosion of the region, and the movement from the southeast, which is younger than the earliest erosion cycle that I could recognize. The succession of events was: (1) movement from the northwest; (2) erosion to a mature stage, with moderate relief; (3) movement from the southeast, resulting in dislocation of the older structures and also of the mature erosion surface, together with the elevation of the *Hautes-Alpes*; (4) erosion of the younger features of topography as they now exist.

The observations which I made on these points were as follows:

In the *Préalpes* I detected features pertaining to two different cycles of erosion. The more recent is represented by the deep valleys and slopes of the present stage. The other is an older, mature surface, which may be seen in the long ridges and summits of the *Préalpes*. It is extensively and generally dissected by the later valleys, but there are many flat areas which are not the result of any structure or of any recent condition of erosion. They represent the lower levels of the mature surface in which the present valleys are

so deeply cut, and they are being destroyed by current activities. The hills that rose above these old levels were of moderate altitude, 200 meters, more or less, and were maintained by the relatively hard limestone fragments involved in the overthrust masses of the Flysch. The old topographic surface thus resulted from differential erosion of a region which had already been disturbed by movement from the northwest. The thrusts had brought up the limestone fragments, but any ridges which may initially have been produced by thrusting had been eroded and replaced by hills adjusted to the the relatively harder rocks. This mature topographic surface is well seen in the Hahnenmoos and surrounding hills above Lenk, and may be recognized from that point of view as an obvious landscape of the summits of the Préalpes.

A mature erosion surface of parallel development to that just described is to be seen in the Hautes-Alpes. I would cite the ice-covered flat of the Plaine Morte as an illustration of its development in the Wildstrübel. This basin, though now the gathering-ground of a glacier, is not due to glaciation; nor is it due to structure of the rocks. It is an erosion surface of gentle grade, with more or less surviving relief worked out before it was elevated to its present position. Where it now lies, its destiny is to be cut to pieces by the development of ravines in the mountain mass of the Wildstrübel. It lies a thousand meters above the homologous surface in the Préalpes and is separated from it by the thrust plane on which the Wildstrübel moved northwestward. The thrust plane rises in that direction; the mass of the Wildstrübel must have been raised in advancing up the incline, and the altitude of the Plaine Morte above its homologue in the Préalpes may, with reason, be attributed to that upward movement.

From these relations I draw the conclusion that the thrusting from the southeast occurred after the erosion cycle had advanced to maturity on the overthrust masses that had previously approached from the northwest.

Since structural and physiographic evidences show that the more recent thrusting was from the southeast, we are led to look for displacement of the older structures by the younger. I have already described the folding of the older thrust planes at the base of the Wildstrübel on the northern side of the younger thrust, by which they are there cut off. When we cross to the southern side of that younger thrust any part of the older major thrust which may exist on that side must lie at some higher level in the elevated mass of the Wild-

strübel. It is found in the summit and is traced down the southern slope to the valley of the Rhone.

This statement rests upon Prof. Lugeon's own observations. He has traced this overthrust from the Rhone valley over the Wildstrübel to the Préalpes near Lenk, and has identified the overthrust mass as a *nappe de recouvrement* having its "racine" in the Rhone valley, its "carapace" on the summit of the Wildstrübel, and its "tête" near Lenk. We may accept the identification of the several sections as parts of a whole structure, for it rests upon that detailed stratigraphic and structural study which Prof. Lugeon has pursued with minute care. But, misled by the erroneous assumption that thrusting proceeded from one direction only, Prof. Lugeon has, I believe, mistaken the relations of the parts to the whole. The so-called "racine" is the tête and the "tête" is the racine, if we can apply these terms at all. The great major thrust from the northwest can be recognized from Lenk to the base of the Wildstrübel and from the summit of the Wildstrübel to the Rhone valley. It is dislocated between the base and the summit of the Wildstrübel by one younger thrust from the southeast, and is finally cut off by another south of the Rhone.

Having been obliged by my observations to recognize the preceding statement of the structure of the Préalpes and Hautes-Alpes as correct, and feeling sure that the concept of superimposed "pli-nappes" or "nappes de recouvrement" should be replaced by an explanation based on intersecting major thrusts, minor thrusts, and folds, I ventured to consider the supposed sequence of pli-nappes which Prof. Lugeon has described as forming the Hautes-Alpes from the Rhone valley eastward. He distinguished the "pli de Morcles," the "pli de Diablerets," and the "pli de Wildhorn-Wildstrübel," and others, in the order named from west to east, and showed that the pli de Morcles pitches under that of the Diablerets, the latter pitches under the pli-nappe of the Wildstrübel, and so forth, each folded and overthrust mass disappearing under the one to the east of it. I accept this observed structure, a portion of which I had the pleasure of seeing with Prof. Lugeon in an excursion to the Diablerets. According to the current interpretation, which I cannot accept, each of these pli-nappes developed as a distinct overthrust, one after the other, each older one having a "racine" south of the next younger, and each having been thrust over the preceding. They would thus have been piled up, as shown in various hypothetical sections, in such, for instance, as profiles I to IV of the *Géologie de la Suisse*, by Dr.

Schardt.<sup>1</sup> The total altitude would then have been not far from 12,000 meters.

Were this view correct, there must be a notable difference in age between the successive overthrusts, and particularly between the earliest and latest of the series. Since they have been exposed to erosion, and by hypothesis some have been exposed longer than others, we should expect the older masses to be more eroded than the younger; as, for instance, in the case of older and younger volcanoes of the Canary or Hawaiian Islands. Such is not the case in the Alps. The Hautes-Alpes constitute a physiographic unit, although they are structurally complex. Considering them for the moment also as a structural unit, and recalling the great recent thrust plane up which they have advanced as a whole from the southeast, we may recognize that the altitude of the chain above the Préalpes is due to the rise on the inclined thrust plane, while the superb scarp which they present to the northwest and north is the effect of consequent erosion on the front of the rising mountain mass. This scarp is of uniform physiographic age from one end of the chain to the other, it being everywhere in a stage of extreme youth.

Having studied a similar scarp and structure in the Lewis range of Montana, where Pre-Cambrian rocks were overthrust on Cretaceous, probably during the Miocene, I judge by comparing the effects of erosion in the two mountain ranges that the elevation of the Hautes-Alpes by advance on the thrust plane occurred not earlier than the Pliocene and possibly in the early Quaternary. However this may be, the scarp is very young, and uniformly young from end to end.

At certain points a lesser scarp branches from the great front of the range and turns back into the heights. As the front faces north by west, these lesser ones face westerly. They also are physiographically young. Indeed, they are distinguishable from the great scarp only by their branching off and having less altitude. Each of these minor scarps is the western face of a segment of the range which Prof. Lugeon has described as a distinct pli-nappe. The cliffs of the Diablerets thus overlook the segment which is called the pli de Morcles. Each minor scarp is based on a thrust plane, dipping easterly, just as the major scarp is based on the major thrust dipping southeasterly. Each minor scarp is related to its minor thrust as the major scarp is related to the major thrust. They all form one system and are of one and the same age.

<sup>1</sup> Schardt, H.: Géologie de la Suisse, article extrait de "La Suisse"; Publications de la Dictionnaire Géographique de la Suisse, Neuchâtel, 1908, pls. 22-23.

Thus I regard the Hautes-Alpes of the Bernese chain as consisting structurally of a great overthrust mass whose general movement was north by west or northwest on a major thrust plane. There developed simultaneously a number of minor thrusts on which movement was toward the west, at an angle to the general motion of the mass. It is an example of major and minor thrusting, with two somewhat divergent directions of displacement and with diversities of folding in the several segments.

It was at the suggestion of Prof. Lugeon that Dr. Jaccard courteously conducted me to the vicinity of Château d'Eux, where he showed me a typical example of the "tête plongeante" of a nappe de recouvrement in the Rhetic limestone of the Pte. de Cananéen. The annexed diagram is taken from Dr. Jaccard's paper.<sup>1</sup>

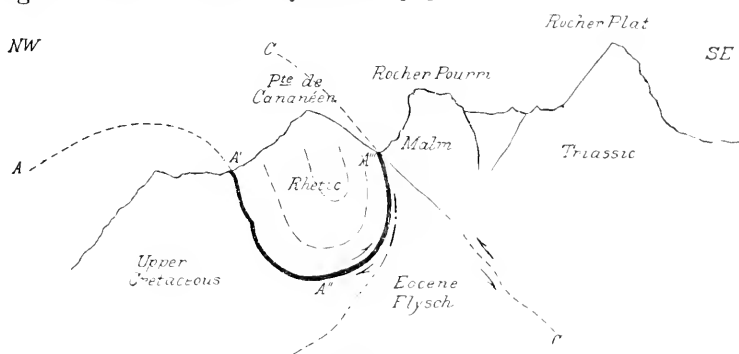

FIG. 2.—Préalpes near Château d'Eux. Characteristic "tête plongeante" of a supposed "pli-nappe" represented by the "Brèche de Chablais-Hornfluh" (Rhetic) infolded in Cretaceous and Eocene. Otherwise interpreted as a mass overthrust from the left (NW) on the plane AA'A'A'', which now appears folded back by the later thrust CC' from the southeast. (Adapted from sketch by Jaccard, pl. 34.<sup>1</sup>)

The limestone ("Brèche de Chablais-Hornfluh") is of Rhetic age, according to Jaccard, and the fragment that forms the Pte. de Cananéen is an isolated synclinal mass, resting upon and enveloped in Upper Cretaceous strata, which in turn overlies the Eocene Flysch. In this inverted order and synclinal structure we may certainly see the plunging head of a great overthrust sheet that has come over all the Alps from the far southeast and buried itself in the Flysch—if such a head and such a sheet have, or possibly could have, any actual existence. I could not, however, accept that concept. I saw, instead,

<sup>1</sup> Jaccard, Frédéric: La Région Rubli-Gumfluh; Bull. de la Société Vaudoise des Sciences Naturelles, Vol. 43, 1907, pl. 34.

a complex thrust, composed apparently of two related planes, which had been folded back upon itself in a later movement from the opposite direction. The later movement had also resulted in a thrust, dislocating the former one and superimposing the Jurassic and Triassic strata of the Rocher Pourri and the Rocher Plat upon the Eocene and the Rhetic mass infolded in it. To the southeast of the Rocher Plat we crossed another fragment of the Brèche de Chablais-Hornfluh, also superimposed upon the Flysch by thrusting from the northwest, and observed that the thrust plane was closely folded and cut off by the Jurassic of the Gummfluh, again overthrust upon it by the later movement from the southeast. (See the sections in Jaccard's paper, pls. 36-38.)

The structure involves one thrust plane from the northwest and two later parallel thrust planes from the southeast. The strata involved in the movements have also been closely folded.

This structure is one of the most complex I have ever seen, and I could not have understood it, as I believe I do, had I not been prepared by the observations on folded and intersecting thrusts which I had made at the northern base of the Wildstrübel, in the Laufbodenhorn, etc. During the two days that I was guided by Dr. Jaccard, between Château d'Eux and Zweisimmen, I saw repeatedly the evidence of older thrusts from the northwest and of younger thrusts from the southeast intersecting and dislocating them.

In the tête plongeante of the Pte. de Cananéen we have an excellent illustration of the structure of those masses which were described by Querreau and later by Prof. Lugeon as being isolated and "without roots." To satisfy myself on this point, I studied the Mythen above Schwyz, and the Brèche de Hornfluh near Zweisimmen. I have no doubt that these masses and others described by Prof. Lugeon, including the Brèche de Chablais, are actually underlain throughout by younger strata and are without any connection with the like formations in place. It is well known that some of these isolated masses, those of the Klippes, are "exotic"; that is to say, no strata of the same facies have ever been found in place. Hence, it is supposed that they must have come from a distant zone south of the Alps. An earlier and, I think, a more correct view was that they came from strata deposited in the zone of the Préalpes, where they are now found. That view was discarded because there was no explanation of the manner in which these isolated masses might have risen through and have become superimposed upon the younger (Eocene) strata which now so widely cover that zone. But let us consider the mechanical effects of intersecting thrust planes.

Let a rock mass start at  $a$  and be thrust to  $a'$ . Then let a later thrust carry it to  $a''$ . It will be isolated by two thrust planes and will be superimposed on younger strata more or less nearly over the place from which it started. One has but to think of a person mounting a stairway which turns back on itself. The "exotic" masses have

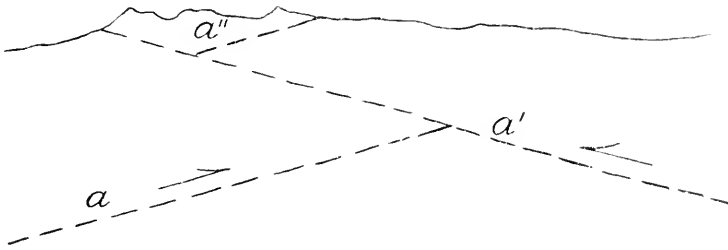
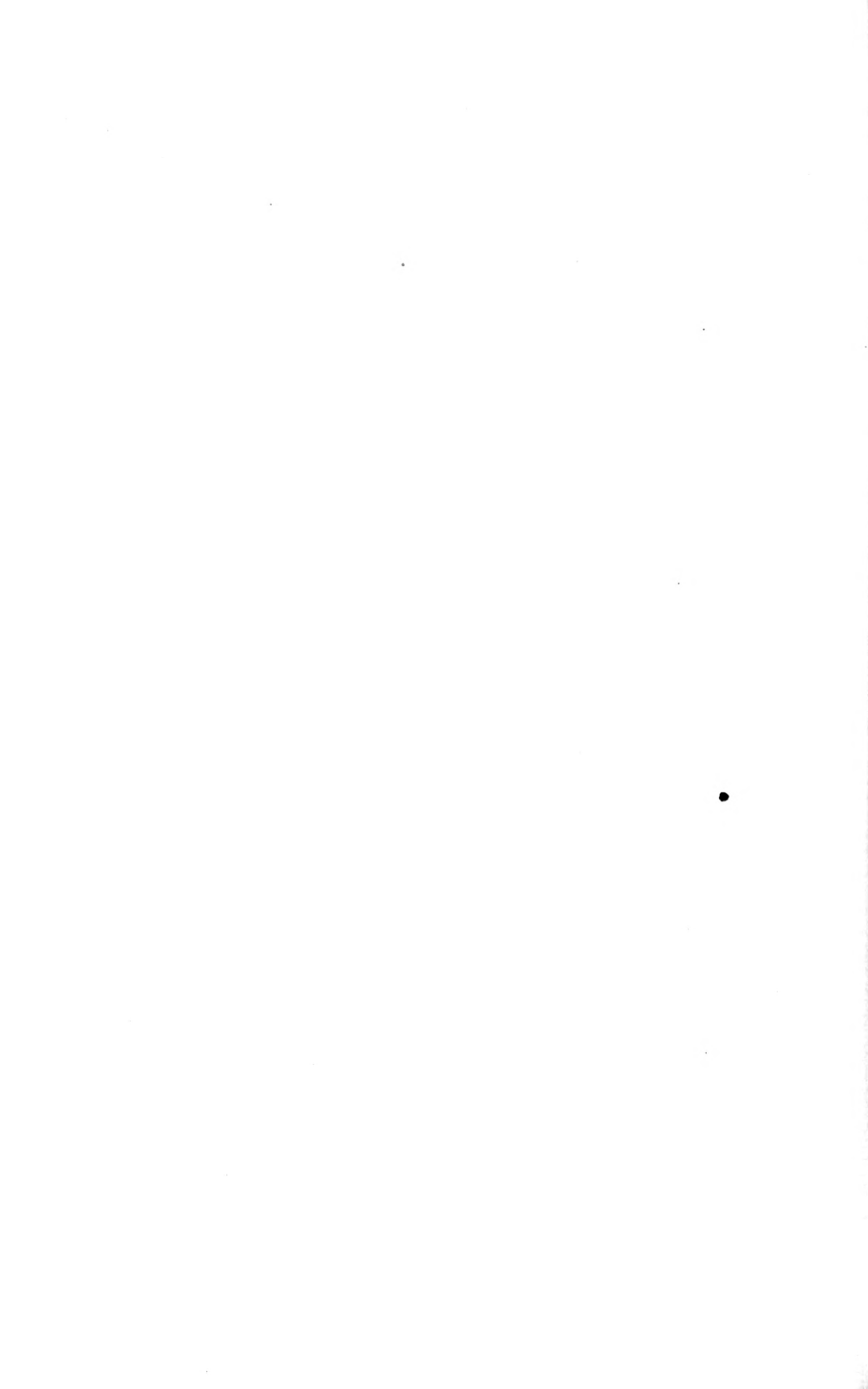

FIG. 3.—Intersecting thrust planes.

gone upstairs, some in one direction only, some in two; and the strata have been folded and squeezed into most complex and irregular forms in the successive movements.

In conclusion I desire to express my appreciation of the able and painstaking investigations of Prof. Lugeon, and to repeat an expression of regret that it is impossible for me to accept the theories of structure which have been developed from his studies.





SMITHSONIAN MISCELLANEOUS COLLECTIONS

VOLUME 56, NUMBER 32

Notes On Birds Observed During A Brief  
Visit to the Aleutian Islands and  
Bering Sea in 1911

BY

A. C. BENT



(PUBLICATION 2068)

CITY OF WASHINGTON  
PUBLISHED BY THE SMITHSONIAN INSTITUTION  
FEBRUARY 12, 1912

The Lord Baltimore Press  
BALTIMORE, MD., U. S. A.

NOTES ON BIRDS OBSERVED DURING A BRIEF VISIT  
TO THE ALEUTIAN ISLANDS AND  
BERING SEA IN 1911

By A. C. BENT

I. INTRODUCTION

At the suggestion of Dr. Leonard C. Sanford, of New Haven, Conn., and with his financial assistance, I undertook to organize and conduct an expedition to the Aleutian Islands during the season of 1911. It was our intention to charter a suitable vessel and spend the entire summer in making a thorough biological survey of the whole Aleutian chain, exploring all of the larger and more important islands as thoroughly as the time and the facilities at our disposal would permit. But since the Biological Survey of the Department of Agriculture desired to cooperate with us and to send a man to collect for them, and as the Smithsonian Institution was interested in helping me secure material for additional volumes of the publication on Life Histories of North American Birds, it seemed best to make it a government expedition and accept the courtesy of the Treasury Department in offering transportation on a revenue cutter. We therefore abandoned our plans for a private expedition and the revenue cutter *Tahoma* was detailed to care for our party, which consisted of Rollo H. Beck, of San Jose, Cal., Alexander Wetmore, of Lawrence, Kan., Fred B. McKechnie, of Boston, Mass., and the writer.

We sailed from Seattle on May 19, and took the inside passage north to Ketchikan, where we remained a few days to take on some spar buoys, and from there we sailed out through Dixon Entrance and nearly west across the Pacific Ocean to Unimak Pass. We entered the Pass on June 4, anchored for one night at Akun Island and reached Unalaska on June 5. After discharging our cargo and coaling, we started on the western trip among the Aleutian Islands on June 10, with orders for the *Tahoma* to return to Unalaska on July 1. This gave us less than three weeks in which to explore over 800 miles of difficult islands, an undertaking for which three months would have been hardly time enough. We cruised the whole length

of the chain, however, and landed on Atka, Kiska, Attu, Tanaga, and Adak islands, besides visiting the western end of Unalaska Island, landing at Chernofski. The whole time at our disposal was so short that we could devote but a very few days to each of these islands and our explorations were limited to such small portions of them as we could reach on foot, which meant a small area within one day's walking distance of the most frequented or best harbor, where we were obliged to anchor. Long trips into the interior, which would involve camping, were not attempted; our time was too limited to waste any of it in making and breaking camp; we were not familiar enough with the region to know where to go and we had no facilities for transporting our camp outfit, supplies, and provisions over the endless succession of barren mountains surrounding every harbor, as there were neither navigable streams nor trails.

Our reconnaissance of the Aleutian chain was necessarily so superficial and hurried that it seems best to make at this time merely a brief report of the results and not to attempt to fully describe the topography, the flora, and the fauna of these interesting and little known islands until a more complete biological survey can be made by some subsequent expedition.

In spite of the short time at our disposal, the four members of our party used the excellent facilities at our command to the best advantage, and by constant hard work accomplished very satisfactory results. Much credit is due to the officers of the *Tahoma*, who gave us most valuable assistance and did everything in their power to further the objects of the expedition. Special thanks are due Chief Engineer John I. Bryan, Lieutenant John T. Carr, Lieutenant Herbert N. Perham, and Doctor Louis Schwartz, for much valuable assistance in securing specimens.

Good series of all the land birds were collected on nearly all of the islands visited; particularly fine series of the various subspecies of ptarmigan were taken, about forty from each of the important islands, among which a new subspecies was discovered inhabiting Tanaga Island, *Lagopus rupcstris sanfordi*;<sup>1</sup> two species, hitherto unrecorded from North America, were collected, namely, *Calliope calliope* and *Hypocentor rustica*.

Some other interesting facts were learned regarding the distribution and habits of the birds of this region, but so much important work in this line still remains to be done that further and more thorough explorations would well be worth while.

<sup>1</sup> Described in Smithsonian Misc. Coll., Vol. 56, No. 30, December, 1911.

## II. BIRDS NOTED IN THE ALEUTIAN ISLANDS IN JUNE, 1911

**GAVIA IMMER**

Loon

Loons were noted at various islands, generally flying high in the air and too far off to identify. One, positively identified as this species, was seen flying across the bay at Adak Island on June 26, and one at Attu Island on June 23.

**GAVIA PACIFICA**

Pacific Loon

**GAVIA STELLATA**

Red-throated Loon

Small loons were seen flying in the distance on several of the islands where both of these species are found, though the Red-throated Loon is probably the more common one. I do not seem to have any positive records of any of these being definitely identified and none were shot. One or both of these species were undoubtedly breeding on nearly all of the larger islands where there were suitable ponds.

**LUNDA CIRRHATA**

Tufted Puffin

Immense numbers of this Puffin and a few of the following species were seen in the water as we were entering Unimak Pass, where they were scattered about over a large area, mostly singly, or in pairs or small groups. There were thousands of them dotting the water in all directions as far as we could see. We saw a few Tufted Puffins about nearly all the islands among which they were generally distributed, but we found only one breeding colony of any size, on a small rocky islet in Nazan Bay, Atka Island. A cloud of these Puffins and a few Horned Puffins were seen flying about the islet, but they all flew off when we landed. We had seen them entering and leaving some inaccessible crevices in the steep rocky cliffs where they were probably nesting. They also had burrows in the soil on the top of the rock, but they had not laid in the holes we dug out. This was on June 15, but evidently most of them had not yet laid.

**FRATERCULA CORNICULATA**

Horned Puffin

This species was not so abundant as the preceding, but was seen quite regularly in small numbers at nearly all of the islands and was breeding throughout its range. At Atka Island, on June 15, we found a small breeding colony on one of the rocky islands in Nazan Bay

where we saw them flying into and out of inaccessible crevices in a precipitous rocky cliff. In habits and general appearance they closely resemble the common Puffins of the Atlantic coast. We had no time to devote to their study and did not make any efforts to secure their eggs, being too busy with other more desirable things.

#### **ÆTHIA CRISTATELLA**

Crested Auklet

We did not find this species so abundant as we expected among the islands, probably because we did not spend enough time at the proper places. We saw a few among the Puffins at the entrance to Unimak Pass and several flocks among the rafts of Least Auklets in the harbor at Kiska Island. The Crested Auklets flew in large compact flocks, often containing forty or fifty birds, and could be easily recognized by their larger size and wholly gray appearance.

Their manner of flight, size, color and crests have suggested the local name of "sea quail" from a fancied resemblance to the California Quail. They were apparently breeding among the masses of large loose rocks and boulders at the base of some high cliffs near the entrance to Kiska Harbor; we saw birds flying out and saw droppings and feathers in the remote crevices under the rocks, but their eggs were too well hidden to see and were entirely inaccessible under the large rocks.

#### **ÆTHIA PUSILLA**

Least Auklet

These interesting little birds, the smallest of the Alcidae, were first seen at the entrance to Unimak Pass among the Puffins and other sea birds, which gave us our first impressions of Aleutian bird life. There were a number of small flocks constantly in sight, rising readily in front of the ship or diving like a flash if we came too near. But it was not until we reached Kiska Harbor that we saw them in real abundance. One smooth foggy afternoon Mr. Beck and I took the skiff and went out towards the entrance of the harbor to collect sea birds. In the outer harbor we found Least Auklets congregating in immense flocks on what was probably their feeding ground. There were thousands and thousands of them swinging about us in great clouds like swarms of bees, or mosquitoes, and great rafts of them sitting in the water. Their diminutive size, short chunky bodies and the rapid motion of their little wings suggested bumble bees rather than birds as they bounced along over the little waves in their haste to get away. They kept up a constant twittering which from such a

vast multitude of birds created quite a volume of sound. They dove like lightning, disappearing so quickly that I could not see how it was done; but I saw them swimming under water using their wings and progressing rapidly. They are sociable little fellows and if one was wounded one or two others would usually return and hover about it, or settle on the water near it. I think they were also nesting under the rocks at the base of the cliffs with the Crested Auklets.

#### SYNTLIBORAMPHUS ANTIQUUS

Ancient Murrelet

These pretty little birds were more or less common in all of the harbors where we anchored, usually well in shore, in small flocks of from four to six birds, swimming rapidly in compact flocks, but usually so lined out that not more than one could be killed at a shot. When hard pressed they dive by plunging quickly forward, sometimes, when greatly alarmed, jumping clear out of the water and diving head first. They do not remain under long and suddenly appear on the surface without causing a ripple. They have a shrill, faint whistling note.

We did not find their breeding places but the natives at Nazan Bay, Atka Island, had eggs which they had taken from holes in the cliffs at no great distance.

#### CEPPHUS COLUMBA

Pigeon Guillemot

This western counterpart of our eastern "sea pigeon" was seen in all suitable localities among the various islands, called by the same name and similar in habits to our eastern bird. The black markings in the white wing patches were quite conspicuous as field marks.

Wherever there were loose rocks piled up on the beaches around the harbors, we saw these Guillemots flying out from the shores and circling about us close to the water or sitting in little groups on the rocks, under which their nests were too well hidden for us to find, or too inaccessible to reach without the help of several men with crowbars. They were particularly numerous about the rocky shores of Kiska Harbor on Kiska Island, where the Least and Crested Auklets and Pacific Eiders were breeding. The breeding birds were in full summer plumage but we saw many in the mottled changing plumage and shot one in practically full winter plumage as late as June 15. On June 18 one female was taken containing an egg ready for laying.

**URIA TROILE CALIFORNICA**

## California Murre

Numerous Murres were seen in Unimak Pass and at various places among the Aleutian Islands, but probably most of them were of the following species, though some of them were undoubtedly of this species. Among the vast hordes of Pallas's Murres breeding on Bogoslof Island we recognized a few scattering pairs of this species, which could be easily identified by the lighter brown color of the heads and necks which were also more slender with longer bills. On the flat top of the high, rounded cliff at the west end of Bogoslof, the sides of which were covered with breeding colonies of Pallas's Murres, we found several small compact colonies of California Murres sitting on their eggs in close bunches of fifteen or twenty pairs.

No breeding colonies were found elsewhere among the Aleutian Islands, although they undoubtedly existed there.

**URIA LOMVIA ARRA**

## Pallas's Murre

As the Brunnich's Murre differs from the common Murre of the Atlantic coast, so may the Pallas's Murre be distinguished from the California.

Pallas's Murre in flight looks shorter, thicker and darker and at close range the white on the cutting edges of the mandibles is conspicuous. It is the commonest Murre in Bering Sea and was seen at various points among the Aleutian Islands where it breeds. It was particularly abundant in the waters north of Unalaska Island, where large or small flocks were almost constantly in sight flying up to the ship and swerving off across the bow or around the stern within easy gunshot. They were flying to or from their great breeding grounds on Bogoslof Island, which can often be located in the prevailing fogs by noting the direction in which the Murres or "crow bills," as they are called, are flying. Our visit to Bogoslof Island was made on July 4, and it proved to be a most glorious celebration of the day, though not a gun was fired.

It was certainly one of the most wonderful bird colonies I had ever seen. Castle rock at the eastern end towered upward from two hundred to three hundred feet with steep, sloping sides and sharp pointed peaks of volcanic rock and loose debris, over which we could readily climb. The peaks, the steep cliffs, and even the gravelly and sandy slopes were literally covered with nesting Murres, countless thousands of them, probably several hundred thousand, perhaps a



million; their numbers were beyond our power to even estimate. As we approached near enough to disturb them, they came sweeping down the slopes in great clouds so thickly that it seemed as if we would be swept off our feet by the rushing tide of birds; in their haste to escape as they scrambled off their nests they sent a shower of eggs rolling down the slopes to be smashed against the first rock they struck; and many of the birds bounded helplessly along over the rocks and stones in their frantic efforts to rise; it was an easy matter to knock them over with sticks or even catch them in our hands. When once well a-wing they would circle about the rocks in bewildering clouds, a steady stream of swiftly flying birds; and off at sea great rafts of them could be seen sitting on the water. Practically all of the birds in this colony were Pallas's Murres. Their eggs were thickly scattered all over the rocks in close rows along the ledges, in every available hollow, nook or crevice big enough to hold an egg and in dense masses, as close as the birds could sit, on the flat spaces and on the sandy slopes. Even at this late date most of the eggs were fresh or nearly so and no young birds were seen.

Toward night, from about 5 p. m. until sunset, the population of the already overcrowded island was still further increased by flocks of Murres constantly coming in from the sea, sometimes in small compact flocks of regular formation but more often in loose straggling parties. Without any apparent cause a cloud of birds would occasionally sweep down from the cliffs, circle about the rocks a few times and then settle down.

#### **STERCORARIUS PARASITICUS**

Parasitic Jaeger

Only a few of these birds were seen about the harbors, particularly at Kiska where they were feeding among the gulls. They were in the dark phase of plumage, plain slate gray. On the inland tundra on Kiska Island I saw one of these Jaegers flying about some small ponds where they are fond of alighting and standing for some time on some prominent little hummock, from which a good outlook is obtainable; at such times they are shy and difficult to approach.

#### **RISSA TRIDACTYLA POLLICARIS**

Pacific Kittiwake

We saw quite a number of Kittiwakes between Unimak Pass and Unalaska, but as they were all in the distance it was impossible to say whether they were of this or the following species. Elsewhere among the Aleutian Islands they seemed to be very rare or entirely absent.

**RISSA BREVIROSTRIS**

Red-legged Kittiwake

As we passed Akutan Island we saw a large number of Kittiwakes hovering about the rocky cliffs, which were probably this species, though we could not stop and did not go near enough to identify them. They are listed as breeding on this island. We did not have time to visit their other known breeding grounds.

**LARUS HYPERBOREUS**

Glaucous Gull

Among the large numbers of Glaucous-winged Gulls seen everywhere, there were undoubtedly a few of this species, perhaps many of them. It was almost impossible to distinguish the slight difference in the wing markings in life and we shot very few gulls for lack of time to prepare them. A few were seen and one was taken at Unalaska.

**LARUS GLAUCESCENS**

Glaucous-winged Gull

This was the common gull seen on or about all of the islands we visited. They were particularly abundant in the harbor at Unalaska and Dutch Harbor, where they were constantly flocking about the ships to feed on garbage thrown overboard. They were common all the way up the coast from Seattle and in the passes, but seldom seen out of sight of land. I saw a large number of them on the high upland tundra above the cliffs on Kiska Island, where they acted as if they were breeding, but I did not find any nests there. The only breeding colony we found was on Bogoslof Island where there were between one and two hundred nests widely scattered over the flat sandy portions of the island. The nests were well made of kelp and seaweed, decorated with feathers and fish bones. At the time of our visit on July 4, most of the young had hatched and were running about, some nests still contained young or pipped eggs and several held sets of two or three blowable eggs. Wherever these gulls were seen we found numerous shells of sea urchins, far from the water, where the gulls had dropped and broken them to feed on them.

**LARUS BRACHYRHYNCHUS**

Short-billed Gull

Young birds of this species were common about Ketchikan where we collected a small series. We saw a few adults in Kiska Harbor but did not find their breeding grounds.

**DIOMEDEA NIGRIPES**

Black-footed Albatross

On the northern Pacific Ocean from Dixon Entrance to Unimak Pass, when two hundred miles or more off shore, a few of these Albatrosses, sometimes as many as six, were almost constantly following the ship, but nearer shore they were seldom seen. We saw a few off the Aleutian Islands both in Bering Sea and the Pacific.

The Short-tailed Albatross, which has been recorded from this region, was not seen.

**FULMARIUS GLACIALIS GLUPISCHA**

Pacific Fulmar

Fulmars were common in the northern Pacific Ocean and Bering Sea, being seen almost constantly about the ship when out of sight of land and frequently closer in. Their graceful movements on the wing were interesting to watch, as they sailed about with their long wings stretched out straight to their fullest extent or flapping rapidly for a few strokes at intervals. Various phases of plumage were noted, light, dark and all grades of intermediates. They breed among the western Aleutian Islands but we did not see their breeding grounds.

**FULMARIUS RODGERSI**

Rodgers's Fulmar

The Fulmars of the northern islands in Bering Sea are supposed to be of this species, but there seems to be some doubt as to the validity of the species and we saw plenty of Fulmars in the Pacific Ocean and about the Aleutian Islands which seemed to be the same as those seen farther north.

**PUFFINUS GRISEUS**

Sooty Shearwater

**PUFFINUS TENUIROSTRIS**

Slender-billed Shearwater

Among the vast flocks of dark colored Shearwaters seen in and about Unimak Pass, it was impossible to separate these two species at any great distance. Certainly both species were present, for we identified both at close range, though none were shot as we could not pick them up. I never saw anything approaching their abundance in Unimak Pass when we went through there on June 4; small black whales were numerous and the Shearwaters were following them about to feed on the remnants of food left on the surface by the

whales; on account of this habit they were called "whale birds." The water was literally black with birds all around us as we sailed through acres and acres of them, wildly scrambling to get out of our way or rising in great clouds to sweep away over the smooth water. For several hours we were almost constantly seeing or passing through these great rafts of Shearwaters and I should not dare to hazard a guess as to how many hundred thousand we saw.

The Slender-billed Shearwater is supposed to breed in some of the western Aleutian Islands, but we did not have a chance to investigate.

#### AESTRELATA FISHERI

Fisher's Petrel

A species of *Aestrclata*, apparently fitting the description of this species, was fairly common in the Pacific Ocean from one hundred to two hundred miles off shore, south of the Alaska Peninsula and the Aleutian Islands, but we were not allowed to lower a boat to secure any. We saw a few also about the Aleutian Islands and secured one specimen at the entrance to Kiska Harbor on June 17. This bird does not exactly fit the description of *fisheri*, and there seems to be some doubt as to whether there is any such species; the three species of *Aestralata* known as *scularis*, *gularis* and *fisheri* seem to intergrade more or less and it may yet be proven that all three of these are based on individual variations in a single species and should not be recognized as three different species.

#### OCEANODROMA FURCATA

Forked-tailed Petrel

This pretty little Petrel was common in the north Pacific Ocean and seen frequently about the Aleutian Islands, breeding on several of them. The only breeding place we found was on Tanaga Island, when they were just beginning to breed on June 25.

Their nests were in burrows in the soft soil at the base of a steep grassy hillside, a mile or so inland. Several burrows were dug out by Mr. Beck, but only one fresh egg was found and only one bird taken.

#### OCEANODROMA LEUCORHOA

Leach's Petrel

We saw a few in the north Pacific Ocean and a few about the harbor at Kiska where one was shot.

**PHALACROCORAX PELAGICUS PELAGICUS**

Pelagic Cormorant

This was the common Cormorant of general distribution among the islands. We saw them at every island we visited, but found them nowhere abundant and saw no breeding colonies. They were commonest in Kiska Harbor where we saw them sitting on the rocks in small groups or flying out around our boat; they were probably prompted by curiosity for they usually circled about the boat several times before flying away and were not much alarmed by our shooting. Only a few of them had the nuptial plumage fully developed with conspicuous white flank patches; some had slight traces of white only and many were in the brown immature plumage, probably one year old birds. A Cormorant collected by Mr. Wetmore, at Unalaska on June 8, seems referable to *robustus*.

**MERGUS SERRATOR**

Red-breasted Merganser

We saw these Mergansers on nearly all of the islands we visited. They were generally distributed throughout the chain, breeding on all suitable islands. We did not find any nests but saw a female with a brood of nine young on Adak Island on June 26.

**ANAS PLATYRHYNCHOS**

Mallard

Mallards were not common anywhere but we saw a few on Kiska and on Tanaga Islands. On the former a female was seen with a brood of young on June 19. Probably this species breeds sparingly throughout the Aleutian Chain.

**NETTION CRECCA**

European Teal

**NETTION CAROLINENSE**

Green-winged Teal

The European bird is supposed to occur only rarely, or as a straggler, in the Aleutian Islands and the American bird is recorded by nearly all of the writers on Aleutian ornithology as the common breeding Teal of the region. Teal of one of these species were common on all of the islands; we saw them frequently and found them breeding in nearly all suitable places along the small water courses and about small ponds. Mr. Wetmore found a nest contain-

ing ten fresh eggs on June 7, near Unalaska and shot the female; unfortunately the male was not secured. We naturally assumed that these were American Green-winged Teal and therefore made no special effort to shoot males on any of the eastern islands, but I now sorely regret that we did not collect at least a few males as the females of the two species are nearly indistinguishable. Among the western and central islands we collected quite a series of both sexes and every male taken proved to be an European Teal; not a single male Green-winged Teal was collected or identified anywhere. On my return to Washington I looked through the National Museum collection for specimens from the Aleutian Islands and found only two males, No. 85615, collected by Lucien M. Turner on Atka Island, June 28, 1879, and No. 192391, collected by Dr. J. Hobart Egbert on Kiska Island, July 14, 1904; both of these proved to be typical European Teal. Therefore, failing to find any positive evidence to prove that the Green-winged Teal breeds on the Aleutian Islands, we must assume for the present, on the strength of what evidence we have, that the European Teal is the common breeding species of this region, where it is fairly abundant, and that the Green-winged Teal, which is so abundant on the main land of Alaska, occurs on the islands rarely, if at all.

#### MARILA MARILA

Scaup Duck

I saw a flock of five of these ducks in a small pond on Atka Island on June 14. They did not seem to be breeding there or at any other point visited by us.

#### HARELDA HYEMALIS

Old-squaw

A few were seen on June 11 in Chernofski Harbor on Unalaska Island and at Kiska Island on June 17, but they were not in summer plumage and did not seem to be breeding.

#### HISTRIONICUS HISTRIONICUS

Harlequin Duck

This is undoubtedly the commonest and one of the most widely distributed of the ducks of the Aleutian Islands. They were seen in large or small flocks at all of the islands where they could find the rocky shores that they love to frequent. They were breeding about the shores of Kiska Harbor on June 17 and probably at other places

we visited, but we did not happen to find any nests. They were frequently seen feeding in pairs about the kelp covered rocks at low tide, among which they were surprisingly inconspicuous and were easily approached.

They were hard to kill however, and would dive readily when shot at or wounded. The unmated pairs were often congregated into large flocks, the adult males generally in flocks by themselves but the flocks of young males or females were usually led by two or three adult males.

#### **SOMATERIA V-NIGRA**

Pacific Eider

Eiders were seen about the inner harbors on all of the islands west of Unalaska and in Kiska Harbor they were fairly abundant in small flocks and mated pairs. They frequented the rocky beaches at the bases of the cliffs where they would sit in the loose rocks, feed in the kelp beds about them and build their nests among the large boulders above high water mark. We found two nests here, one with four and one with five fresh eggs, one in a hollow behind the rocks and partially concealed in the long grass, and one in the long grass at the top of a steep grassy slope.

#### **OIDEMIA AMERICANA**

Scoter

Flocks of Scoters of both this and the following species were seen on the various islands visited, principally in the harbors, and some of this species were shot at Atka Island on June 14. We saw no evidence of their breeding anywhere and none were seen in any of the inland ponds.

#### **OIDEMIA DEGLANDI**

White-Winged Scoter

The same remarks apply to this species, which were easily recognized, but none were shot. They were evidently flocks of non-breeding birds wandering about. I find no record of any Surf Scoters being positively identified among the Aleutian Islands, though we may have seen some.

#### **BRANTA CANADENSIS MINIMA**

Cackling Goose

Although we saw a few geese, either this or Hutchins's on Kiska, Adak, Atka and Attu islands, the only one positively identified was one of this subspecies taken by Mr. Beck as she flew from her nest of

four eggs on Attu Island on June 23. If we had had time to thoroughly explore the inland ponds on some of the western islands, where they are said to be common, we should probably have found plenty of geese breeding. The status of these two geese was one of the points we particularly wanted to settle and we were much disappointed at not being able to do so.

#### **LOBIPES LOBATUS**

Northern Phalarope

We saw a few Phalaropes on Atka Island where several nests were found with fresh or incomplete sets of eggs on June 18. On Kiska Island they were really abundant and breeding about the small grassy ponds and sloughs, where a set of three fresh eggs was taken on June 21. A small flock of apparently unmated birds of both sexes, in which I counted seventeen birds at one time, frequented the beach almost constantly, swimming about the piers of an old dock or feeding in the surf where they floated buoyantly over the little waves and fluttered over the crests of the small breakers. They were swimming about in little circles, picking up some minute objects from the surface. They were very tame everywhere and, about the ponds where they were breeding, very solicitous and noisy. Their nests were made in little tussocks in the wet meadows around the edges of the ponds or near the banks of streams. They were common on all the other islands where there were suitable breeding grounds.

#### **ARQUATELLA MARITIMA COUESI**

Aleutian Sandpiper

The first specimen of this local species was taken on the beach at Akun Island on June 4, and after that we saw them on every one of the islands we visited, but they were not common among the eastern islands. At Tanaga Island they were fairly abundant and breeding on the inland tundra.

Only one nest was found with eggs, on Kiska Island on June 14. While climbing over a high hill a bird fluttered off directly under my feet, on a bare moss covered space where there was only a scanty growth of grass. The four large eggs lay well concealed in a deep little hollow lined with dead leaves and bits of straw. The eggs were only slightly incubated. On Attu Island on June 23, I shot a pair of these birds which were very solicitous and evidently had a nest; after a short search I found it on a little moss covered hummock well up on the hillside; in a hollow similar to the first nest were three beauti-



fully colored downy young, not yet old enough to run. Mr. Wetmore also found a brood of downy young on Adak Island on June 27. We found these sandpipers always very tame and unsuspecting and, except on their breeding grounds, remarkably silent and inactive. They move about very little while feeding and pay no attention to passers-by even at short distances; it was often necessary to back off before shooting one.

On their breeding grounds, on the high dry tundra or mossy hill-sides, they were much more active and noisy, indulging in their hovering flight songs thirty or forty feet up in the air, a series of delightful twittering notes as they fluttered downward, or giving their loud musical flute-like whistling notes, suggestive of the melodious calls of the Upland Plover, while flying about or standing on the top of some prominent hummock.

Among a series of eleven birds collected on Attu Island on June 23 are two birds which closely resemble *ptilocnemis* in color, but in size are typical of *couesi*. At least one of them was a breeding bird, the parent of a brood of downy young, and doubtless both of them were summer resident birds. At this point so far west of their normal range and entirely outside of their known migration route, they could hardly be regarded as straggling or belated migrants, which might be expected in the eastern Aleutian Islands. They can, therefore, be regarded only as aberrant specimens of *couesi* or variants towards *ptilocnemis*. In our series of *couesi* from the Aleutian Islands are a number of other specimens which are somewhat intermediate between the two forms but are undoubtedly referable to *couesi*.

#### LIMOSA LAPPONICA BAUERI

Pacific Godwit

While walking around the shores of a pond on Atka Island on June 13, I flushed two Godwits which I am quite sure were of this species, although I was unable to secure them. They were probably late migrants.

#### HAEMATOPUS BACHMANI

Black Oyster-catcher

Oyster-catchers were fairly common about Kiska Harbor where we saw them sitting on the rocks or flying about and uttering their loud and penetrating cries. They were remarkably inconspicuous on the rocks and not at all shy. At Adak Island we saw a flock of eight or ten birds several times flying about the harbor or standing on a rocky islet. They may have been breeding at one of these

places but we saw no evidence of it and no, apparently, breeding pairs. They were also noted on Tanaga Island and at Chernofski on Unalaska Island.

#### **LAGOPUS RUPESTRIS NELSONI**

Nelson's Ptarmigan

The best known of the Aleutian Ptarmigan inhabits Unalaska Island and Amaknak Island, which are separated only by a narrow channel. About Iliuliuk Village on Unalaska Ptarmigan are scarce and wild, having been persistently hunted by the inhabitants, but across the channel on Amaknak, where most of our birds were taken, we found them common and tame on the steep sloping sides of a mountain locally known as "Ballyhoo." At the time of our visit, June 5 and 9 inclusive, the Ptarmigan were apparently just mating and were scattered all over the sides of the mountain. We found no nests and judging from our experience elsewhere we inferred that they would come down to lower levels to nest in the grassy hollows. A pair of birds could often be located by seeing the song flight of the male, his white wings being quite conspicuous at a great distance as he flies thirty or forty feet upwards and floats or flutters downwards, sometimes scaling on decurrent wings, uttering all the time his loud clucking, rattling call. The male may often be seen sitting on his favorite perch on some prominent hummock where he has a good outlook, but where he is equally conspicuous; he apparently uses the same hummock regularly for it is usually well decorated with dung and feathers. The female is very inconspicuous and moves about very deliberately where she matches her surroundings perfectly.

#### **LAGOPUS RUPESTRIS ATKHENSIS**

Turner's Ptarmigan

On Atka Island we found this form of Ptarmigan very abundant; there seemed to be more Ptarmigan here than on any island we visited. There were comparatively few of them on the hillsides, but in the grassy hollows and among the low rolling hills of the valleys we were constantly flushing them. They were apparently mated and breeding on June 13, the day of our arrival, but we failed to find any nests during the next two or three days. The male usually flushed first with loud clucking notes and the female was sure to follow soon after him. They were very tame and we had plenty of opportunities to observe and study their movements, as they conducted

their courtship in the air or strutted about on the ground. The male is a strong flyer and delights in making long scaling flights, particularly against a strong wind when he rises and falls at will on firmly set wings or poises like a falcon over his admiring mate.

#### **LAGOPUS RUPESTRIS TOWNSENDI**

Townsend's Ptarmigan

At Kiska Island on June 17, the Ptarmigan of this form were still in the uplands, were much wilder than the Atka birds and not nearly so abundant, but during the few days that we were here we succeeded in collecting a good series. No nests were found; probably we were too early for complete sets.

#### **LAGOPUS RUPESTRIS CHAMBERLAINI**

Adak Ptarmigan

The Adak Ptarmigan frequented the high dry tundra and low hillsides where reindeer moss was plentiful as well as the grassy hollows and valleys. They were common but not abundant and we obtained all we needed. Two nests were found, each containing seven nearly fresh eggs. All of these Ptarmigan were feeding entirely on green food, principally the young, green leaves and buds of the dwarf willows, the tops of ground evergreens and mosses and the flower buds and blossoms of herbaceous plants.

#### **LAGOPUS RUPESTRIS SANFORDI**

Tanaga Ptarmigan

On Tanaga Island we collected a good series of this bird which proved to be a new subspecies, as elsewhere described.<sup>1</sup> The birds were abundant and tame on the rolling grassy hillocks or sand dunes back of the beach and on the little grassy hills on the tundra. Three sets of eggs were collected and other nests were seen by members of the ships crew, who went hunting on June 25, only a half day being spent on the island. One nest containing nine fresh eggs was in a hollow among some large tufts of grass in the steep bank of a stream. The other nests were in grassy hollows among the hillocks and contained eight fresh eggs each.

#### **LAGOPUS EVERMANNI**

Evermann's Ptarmigan

This, the darkest of all the forms, inhabits Attu Island, the western extremity of the chain where it is found on the moss covered and bare, rocky sides of the mountains. It enjoys the rank of a distinct

<sup>1</sup> Smithsonian Misc. Coll., Vol. 56, No. 30.

species, but I doubt if it is correctly so ranked for our material seems to show intergrading with *nelsoni*. We learned less about this than any of the others for our collecting time on this important island was cut down to one cold, rainy, stormy day, when effective collecting was difficult. We collected only one female and seven males. No nests were found, though the female was evidently incubating. What few birds we saw were very tame.

There is much yet to be learned about the relationships of the Aleutian Ptarmigan and their connection with the mainland birds of both continents, but before the subject can be satisfactorily studied, more material must become available from the unexplored islands and the Asiatic mainland. I shall, therefore, have to leave this important matter for future investigation.

### HALIÆTUS LEUCOCEPHALUS ALASCANUS

Northern Bald Eagle

Large Bald Eagles were common on all the islands we visited, particularly about Unalaska and Dutch Harbor, where one or more were almost constantly in sight. They were not at all shy, frequently flying within easy gunshot; they were especially bold about their nesting places or near their favorite lookout points on the hilltops, where feathers and droppings indicated that they habitually used the same spot for a perch; at one such spot on the crest of a steep rocky hill, I surprised a large White Headed Eagle which sailed back and forth several times, within a few feet of my head, squealing vigorously all the time as if I were intruding on its home. It undoubtedly breeds on all the islands. Nests with young about half grown or more were found on Atka, Adak, Kiska and Tanaga islands; they were placed on rocky cliffs and some were easily accessible.

Among the numerous dark colored Eagles seen, some were probably Golden Eagles, as the species is recorded as common among these islands. We saw several which we thought might be Gray Sea Eagles, but they did not come near enough to be positively identified.

### FALCO PEREGRINUS PEALEI

Peale's Falcon

This species is said to be commoner among the western islands than elsewhere, but we saw large Falcons, undoubtedly this species, on Atka, Kiska, Tanaga and Adak. At Kiska Harbor on Jun 19, I watched a pair of these birds flying about the high rocky cliffs; they were apparently building a nest, as I saw one of them fly up

with a stick in its claws. I also saw a pair mating at Atka Island on June 13. These facts would seem to indicate that they are late breeders. We did not secure any specimens or find any nests.

#### **ASIO FLAMMEUS**

Short-eared Owl

A single individual of this species was seen on Amaknak Island, near Dutch Harbor, on June 7, where it was flushed from the top of a small spruce tree, in one of the only two clumps of trees in the Aleutian Islands.

#### **CORVUS CORAX PRINCIPALIS**

Northern Raven

Ravens were common throughout the whole Aleutian chain. About Iliulik Village, Unalaska, they were particularly abundant and absurdly tame. They habitually frequented a steep grassy hillside, across a small creek from the town, whence they made frequent visits to the village. Along the beach and about the houses they were as tame as hens, hopping away a few feet from us or sitting on the fences or on the roofs of the houses like tame Crows. They are useful as scavengers and probably make a good living. Their aerial evolutions are strikingly interesting, showing wonderful command of their flight powers. The young were fully grown and on the wing at the time of our arrival, the first week in June.

#### **HYPOCENTOR RUSTICA**

Rustic Bunting

Two specimens of this bird, at that time unknown to us, were picked up dead and partially dried on Kiska Island. On June 10, at the same place, Mr. Wetmore saw and collected a living specimen. I saw two or three birds on Adak Island, which I thought were this species but they were exceedingly shy and I did not collect any. This species occurs regularly in Japan and on the Asiatic mainland from Kamchatka to China, and as a rare straggler only in the Commander Islands.

#### **LEUCOSTICTE GRISEONUCHA**

Aleutian Rosy Finch

This characteristic Aleutian species was uniformly distributed in all suitable localities over all of the islands. Its favorite haunts are the rocky mountain sides and summits, its breeding grounds the rocky ravines and inaccessible cliffs and its feeding grounds about

the edges of snow banks on the hillsides and gulches. They are restless, roving birds, sweeping over the mountain tops in long swinging curves, or gathering in small parties on the edges of a melting snow bank to feed on the small insects to be found there, where they are often too shy to approach. About the rocky cliffs and summits, where their nests are well concealed in inaccessible crevices, they are tamest; if one stands still they will come and perch on some near by rock, chirping loudly in protest, or fly about from point to point with their swinging billowy flight, twittering all the time. Mr. Wetmore found a nest on Kiska Island on June 18, containing two fully fledged young; it was in a crevice in the rocks in an almost inaccessible place on the face of a cliff. This was the only nest found.

Rosy Finches were occasionally seen on the rocky beaches, but apparently were only feeding there.

#### **ACANTHIS LINARIA LINARIA**

Redpoll

A Redpoll alighted on a spruce tree near Dutch Harbor, on June 7, while I was sitting under it eating my supper, but it flew away before I could grab my gun and I never saw it again. No others were seen.

#### **PLECTROPHENAX NIVALIS TOWNSENDI**

Pribilof Snow Bunting

The first Snow Buntings were seen before we had been ashore an hour on Akun Island, and from that time on they were found regularly on all the islands visited, but were nowhere abundant or even common. Though occasionally seen on the beaches or low levels, they were confined almost entirely to the mountain tops and rocky ravines, where they were breeding. They were generally rather shy if we attempted to stalk them in the open but were easily approached among the rocks. The males had a pretty little song and a variety of twittering notes. They were not as active as the Rosy Finches and were generally confined to restricted localities which suited their needs. No nests were found, for we had very little time to devote to small land birds. No young were seen on the wing during June.

#### **CALCARIUS LAPPONICUS ALASCENSIS**

Alaska Longspur

Just as the Chestnut-colored Longspur adds a charm to a drive across the inland prairies, so does this beautiful little bird cheer the wanderer over the cold and fog bound tundra of this inhospitable

region by his delightful song and cheerful manner, as standing on the top of some little hummock he whistles in joyful greeting or, flying up into the air, he charms his mate with his melodious flight song. Fortunately these pretty little Longspurs are exceedingly abundant all over the low grassy hills, plains and tundra of all the islands, where they are almost constantly seen and heard; they undoubtedly outnumber all other land birds. They were mating and breeding all through the month of June; nests with fresh eggs were found as early as June 7, and as late as June 27. The nests were placed on the ground, either in or under the tufts of grass or wild rye, usually in grassy hollows in the lowlands, but sometimes on the hillsides or on the tundra. No young birds were seen on the wing during June, but several nests were found with fledged young.

#### **PASSERCULUS SANDWICHENSIS SANDWICHENSIS**

Aleutian Savannah Sparrow

This Sparrow was very abundant on Unalaska Island, even as far west as Chernofski, and on the other islands to the eastward of it, but it was not found on any of the islands to the westward of Unalaska. Its favorite haunts were the low, flat, grassy meadows near the beaches and about the ponds and streams, but it was also found more sparingly on the high tundra and low hillsides. In habits and song it closely resembles the eastern Savannah Sparrow. Only one nest was found, by Mr. Wetmore on June 9, containing four fresh eggs.

#### **MELOSPIZA MELODIA SANAKA**

Aleutian Song Sparrow

One of the birds peculiar to this region and the most widely variant form of a plastic species is this strikingly large Song Sparrow. Although so widely different from any of the mainland subspecies, it seems to vary very little among the 800 miles of islands forming the Aleutian Chain. Only a few Song Sparrows were seen about the vicinity of Dutch Harbor, but they were very abundant at the western end of Unalaska Island near Chernofski. They were fairly common locally on all of the other islands but nowhere abundant. They were strictly littoral in their habits and were confined almost wholly to the steep grassy banks above the beaches or the rocky and grassy valleys near the shore. In such localities we almost always found at least a few of them breeding. Only one nest was found, at Chernofski on June 10, containing four fresh eggs. It was concealed behind a tuft of grass on a steep grassy bank above the beach. Being a

heavily bodied, small winged bird, this Song Sparrow's flight is slow and direct, not at all like the buoyant flight of the eastern bird. But its song, though it has many variations, is quite similar to that of its well known relative. One that I shot had a bill full of small angle worms.

**HIRUNDO ERYTHROGAстра**

Barn Swallow

One was seen at Dutch Harbor on June 5, but none were seen elsewhere. I believe it does not occur west of Unalaska.

**ANTHUS RUBESCENS**

Pipit

We saw a few Pipits on the mountains about Dutch Harbor and Unalaska where they were mating and breeding early in June, though no nests were found. We did not see them elsewhere among the islands.

**NANNUS MELIGER**

Aleutian Wren

These delightful little songsters were seen on the islands we visited, wherever suitable conditions were found. They frequented the rocky ravines inland, particularly along the beds of cool mountain streams and some grassy valleys where there were a few loose scattered rocks. We also found them on the rocky beaches among the loose boulders under the cliffs. It was surprising to see such a delicate little woodland bird braving the rigors of such a rugged coast, dodging in and out among the surf swept rocks or pouring out his delightful warbling song among the cries of hardy seabirds. He must have a brave and cheerful little heart under his tiny coat of thick feathers.

**CINCLUS MEXICANUS UNICOLOR**

Dipper

I saw a pair of Dippers on an inland mountain stream near a little waterfall at Unalaska, but did not see any elsewhere.

**CALLIOPE CALLIOPE**

Ruby-throated Nightingale

Mr. McKechnie shot one of these rare birds at Kiska Harbor on June 17 and saw two others at the same time. Mr. Wetmore also saw one two days later. They were near the beach about some old buildings.



This species is abundant in Kamchatka, where it is one of the most attractive birds and an exquisite songster.

Dr. Stejneger records the capture of a single straggler on Bering Island, January 29, 1883; it is therefore a rarity even in the Commander Islands. The capture of our specimen, which is now in the National Museum collection, extends its known range several hundred miles eastward.

### III. BIRDS NOTED IN BERING SEA IN JULY, 1911

On our return to Unalaska on July 1, we were informed by the Commander of the Bering Sea fleet that the Revenue Cutter Service could do nothing more for us, as they needed the *Tahoma* on the seal island patrol. We therefore made other arrangements for transportation during the remainder of the season. We left Mr. Wetmore at Unalaska to work in that vicinity for a while and to secure passage homeward along the south side of the Alaska peninsula. The results of his work belong to the Biological Survey. The remainder of our party secured passage to Nome on the gasoline schooner *Polar Bear*, owned and commanded by Mr. Louis L. Lane, of Seattle. We sailed from Unalaska on July 3 and reached Nome July 11, having spent one day on Bogoslof volcano, half a day on St. Paul Island, half a day on Walrus and a day at St. Matthew and Hall islands.

No thorough work could be done on such a hurried trip, but we obtained a fairly good impression of the avifauna of these interesting islands and took a large series of photographs. The following notes on the species observed may be worth recording, though I realize that they contain very little new matter.

#### LUNDA CIRRHATA

##### Tufted Puffin

A few Tufted Puffins were breeding on Bogoslof Island, making their burrows in the sandy bluffs above the beaches or in the sand and gravel slopes about Castle Rock among the Murres. Their burrows were rather shallow and were generally profusely lined with feathers and straws.

The soft soil on the bare top of Walrus Island was so honeycombed with the burrows of this Puffin that it was difficult to walk without breaking into them; very few Puffins were seen, however, until they were dug out of their burrows when they would go scrambling off towards the water in a frantic effort to fly. They were nesting here also under the loose rocks on the stony beach among the Auklets.

**FRATERCULA CORNICULATA**

Horned Puffin

A few pairs were seen breeding on the rocky cliffs at St. Paul Island and they were common at St. Matthew Island on the high cliffs among the Fulmars. No nests of this species were examined.

**PHALERIS PSITTACULA**

Paroquet Auklet

We first saw this large White Breasted Auklet when we approached the shores of St. Paul Island in a dense fog, the direction in which this and other birds were flying helping to locate it. They were nesting in inaccessible crevices in the low rocky cliffs about this island where we saw them sitting in little groups on the rocks or flying out to circle around us. On Walrus Island we found them breeding abundantly, on June 7, where their nests were well hidden under the piles of loose rocks on the beach-like center of the island, in company with the Tufted Puffins, Crested and Least Auklets. The rocks were mostly small so that we did not have much difficulty in moving enough of them to discover the bright white eyes and curious upturned red bills of these Auklets as they sat quietly on their single eggs. The eggs were laid on the bare rocks or soil or on a bed of loose pebbles. They were silent and very gentle as they sat quietly on their nests, quite different in this respect from the other Auklets. On St. Matthew Island we saw a few Paroquet Auklets, apparently breeding, about the tops of the high rocky cliffs, two hundred feet above the sea.

**ÆTHIA CRISTATELLA**

Crested Auklet

This species was not so abundant as the foregoing, but was breeding commonly on Walrus Island. While hunting for nests among the loose rocks we frequently heard the loud weird cries of this strange bird coming from the innermost recesses of the rocks below us. By moving the rocks we could sometimes see them sitting on their nests. The eggs are similar to those of the Paroquet Auklet, but usually a little smaller and more pointed.

**ÆTHIA PUSILLA**

Least Auklet

Great clouds of these little birds greeted us on our arrival at St. Paul Island, where they rose from the stony beaches in swarms, and were probably breeding among the loose rocks. Their faint

twittering notes sounded like an immense flock of Peep in full cry or like the distant peeping of countless Hylas.

### CEPPHUS COLUMBA

Pigeon Guillemot

A few were seen at St. Paul and Walrus islands, and a few about the high cliffs of St. Matthew Island. They were probably breeding at all of these places, but we spent no time in hunting for their nests.

### URIA TROILLE CALIFORNICA

California Murre

Although the Murre colonies at Bogoslof Island were the most extensive I had ever seen and probably included the greatest number of birds, they were totally eclipsed in density by the wonderful colonies on Walrus Island. This is a most remarkable little island, an ornithological wonderland, where ten species of seabirds breed in countless multitudes, far surpassing anything I have ever seen. The California Murres rank first in numbers, literally covering the low cliffs and rocky shores all around the island, as well as large spaces on top of it, with dense masses of birds sitting remarkably closely. They were exceedingly tame or stupid and would allow a near approach, but if hard pressed they would rise on their toes and waddle off, flapping their wings rapidly; the clatter of many hundred pairs of wings increasing to a deafening roar, they would pour off in streams, stumbling over each other as they scrambled down to the water, pattering over its surface to join the distant rafts of Murres on the water or diving straight downward and flying away rapidly below the surface. Plenty of Murres, mostly of this species, were breeding on the perpendicular cliffs of St. Matthew Island.

### URIA LOMVIA ARRA

Pallas's Murre

Among the vast hosts of California Murres on Walrus Island were a few of this species. On the cliffs of St. Paul Island this species was breeding among the Puffins and Kittiwakes. At St. Matthew Island a few Pallas's Murres were seen, although they were far outnumbered by the foregoing species. All through Bering Sea Pallas's Murres were frequently seen flying about, even out of sight of land, in small flocks or singly.

**RISSA TRIDACTYLA POLLICARIS**

Pacific Kittiwake

This seems to be the commonest gull in Bering Sea. We saw a few breeding on the cliffs at St. Paul Island; they were quite common on Walrus Island and a few were nesting on the high cliffs on St. Matthew Island. At Walrus Island, where there are no high cliffs, we had an unusually good opportunity to examine their nests, which were placed on little shelves on the faces of perpendicular rocks in little groups of from four to six pairs each, often close to the Murres or Red-faced Cormorants. The nests were neatly made of soft green grasses, securely plastered onto the rocks, and contained one or two eggs.

**RISSA BREVIROSTRIS**

Red-legged Kittiwake

Only one specimen of this beautiful species was taken, between Bogoslof and the Pribilof islands. Several were seen about the latter and could be distinguished by their darker mantles, short bills, less black on their wing tips and by their bright red feet. We did not see their breeding grounds.

**LARUS HYPERBOREUS**

Glaucous Gull

In the large breeding colony of Gulls on Walrus Island there were certainly a number of Glaucous Gulls, but just what the proportions were of this and the following species we were unable to determine as we were not allowed to do any shooting here. Only a few nests still contained eggs, as most of the young Gulls were running about and hiding under the tufts of grass which covered the highest part of the island.

**LARUS GLAUDESCENS**

Glaucous-winged Gull

I assumed that the majority of the Gulls breeding on Walrus Island were of this species, but I have no reason for the assumption except that this seems to be the commoner species. It is to be regretted that we were unable to shoot any, although photography gave us plenty to do during the half day spent on this fascinating little island.

**STERNA PARADISÆA**

Arctic Tern

A few Terns were seen in the northeastern part of Bering Sea, undoubtedly of this species, which was the bird found at Nome.

**FULMARS RODGERSI**

Rodgers's Fulmar

The Fulmars of the northern islands of Bering Sea are supposed to be of this species while those about the Aleutian Islands are supposed to be the Pacific Fulmar. There is so much individual variation in Fulmars that the careful study of a very large series is necessary to determine satisfactorily the validity of this species and I doubt whether the characters of *rodgersi* would prove sufficiently constant to warrant its recognition as a distinct species. I saw Fulmars on the Pacific Ocean which certainly looked like *rodgersi* and about the high cliffs of St. Matthew Island, where Rodgers's Fulmars were breeding in large numbers, I could see from an advantageous point on the top of the cliff, where I could look down upon their backs, a great variety of color patterns on the birds circling below me. It would be well worth while to collect a large series of them here and thus determine the constancy of the specific characters. This was the only breeding colony of Fulmars that we saw; they were breeding in large numbers all over the faces of several high, precipitous, rocky cliffs where the eggs were laid on narrow ledges entirely inaccessible so far as we could see; but an hour or two on shore with a camera was hardly time enough for thorough exploration. \*The Fulmars were not shy and were constantly flying in and out or conducting their courtships on the narrow ledges below me.

**PHALACROCORAX URILE**

Red-faced Cormorant

Among all the birds breeding in the large colonies of Walrus Island, these beautiful and rare Cormorants interested me most, for I had never seen the species alive before and there are very few places where it can be seen, as it is restricted to Bering Sea, where it is constantly resident. There was not a large number of them, perhaps fifty or one hundred pairs, scattered over the island in small groups, nesting on the broader level ledges on the outer and higher rocks. The nests were rather prettily made of various kinds of seaweeds, kelp, sea mosses and green grass, not very large and rather clean for Cormorants' nests. Most of the nests contained three or four young of various ages, naked and blind at first, but afterwards covered with soft gray down mixed with white on the belly. The birds were exceedingly tame as they stood beside the nests brooding over their young, allowing us to walk up and photograph them within a few feet. The beautiful metallic colors of their plumage, purple, blue, green and

bronze, their bright scarlet faces and gular pouches of rich smalt blue, made a strikingly handsome combination, as they stood craning their necks at us in ignorant stupidity as if they had never seen a man before. They were generally silent, but occasionally uttered a loud, rolling guttural croak, when alarmed. A few of the nests still contained, on July 7, three or four eggs. One nest contained two eggs of the Cormorant and a Murre's egg, which may have rolled into it from the rocks above.

#### HARELDA HYEMALIS

Old-squaw

Two pairs of Old-squaws in summer plumage were seen in a small pond near the village on St. Paul Island, where they were probably breeding.

#### PHALAROPUS FULICARIUS

Red Phalarope

A few flocks of large light-colored Phalaropes were seen flying over the northern parts of Bering Sea and one, a beautiful adult bird, came near enough to be identified.

#### ARQUATELLA MARITIMA PTILOCNEMIS

Pribilof Sandpiper

These Sandpipers were common on the low tundra at the south end of St. Matthew Island, in the interior at the north end and on Hall Island. Several specimens were taken by Mr. Kleinschmidt.

#### HETERACTITIS INCANUS

Wandering Tattler

A single bird of this species was heard on the rocky beach of St. Paul Island, near the fur-seal rookeries, on July 6.

#### LEUCOSTICTE GRISEONUCHA

Aleutian Rosy Finch

A few were seen on St. Paul Island about the rocky places near the killing grounds.

#### PLECTROPHENAX HYPERBOREUS

McKay's Snow Bunting

The name *hyperboreus* well fits this snow white bit of Arctic bird life which we saw sweeping down in long, curving flights from the rocky hills of St. Matthew Island to feed around the edges of the

snow glaciers in the valley. The male is almost wholly white and is a strikingly conspicuous bird as it flits about the rocks of its summer home. A pair were taken on this island and several on Hall Island. One nest was found containing young nearly fledged in an almost inaccessible crevice in the face of a rocky cliff, on July 9.

**CALCARIUS LAPPONICUS ALASCENSIS**

Alaska Longspur

They were fairly common on St. Paul Island on the grassy plains about the killing grounds.





SMITHSONIAN MISCELLANEOUS COLLECTIONS

VOLUME 56, NUMBER 33

# THREE NEW PLANTS FROM ALBERTA

BY

PAUL C. STANDLEY



(PUBLICATION 2069)

CITY OF WASHINGTON  
PUBLISHED BY THE SMITHSONIAN INSTITUTION  
FEBRUARY 7, 1912

The Lord Baltimore Press  
BALTIMORE, MD., U. S. A.

## THREE NEW PLANTS FROM ALBERTA<sup>1</sup>

By PAUL C. STANDLEY

During the summer of 1911 Mr. N. Hollister and Mr. J. H. Riley made an extended reconnaissance of the animal life of the mountains of eastern British Columbia and western Alberta.<sup>1</sup> At the same time they secured representatives of many of the plants of this little explored region, their collections consisting of over two hundred numbers. Coming from a territory where little or no botanical collecting had been done previously, these have proved to be of more than passing interest. In the course of identifying the plants secured by the two collectors three were found which seem to be undescribed. It is expected later to publish an annotated list of the species represented in the series of specimens, but it seems advisable to publish here the descriptions of the new ones in advance of the complete report.

### **VAGNERA PUMILA** Standley, *sp. nov.*

Low perennial 10 cm. high or less; leaves few, usually only 2, with one or 2 very small bract-like leaves just below the inflorescence, elliptic or elliptic-oval, 20 to 50 mm. long and 8 to 14 mm. wide, abruptly acute, sessile by a clasping base, finely parallel-veined, glabrous; inflorescence a stout raceme about 5 cm. long, well exserted beyond the leaves, the flowers rather widely spaced; pedicels stout, ascending, 6 to 8 mm. long, glabrous, subtended by minute, scarious, obtuse, purple-dotted bracts; perianth segments 3 mm. long, oblong, obtuse, white conspicuously blotched with purple; filaments stout, slightly thickened towards the base; anthers purple; stigma very short and thick, not longer than wide, the styles often nearly sessile; mature fruit not seen.

Type in the U. S. National Herbarium, no 622636, collected on Prairie Creek, western Alberta, July 3, 1911, by J. H. Riley (no. 100).

<sup>1</sup> Some new species of birds collected by this expedition are described by J. H. Riley in Proc. Biol. Soc. Washington, Vol. 24, pp. 233-236, 1911; and four new mammals are described by N. Hollister in Smithsonian Misc. Coll., Vol. 56, No. 26, December 5, 1911.

This is a distinct species related to *V. trifolia* which occurs farther east in Canada and has been reported from the western mountains. The writer has seen no other western specimens so cannot determine whether the other material referred to *V. trifolia* is of that species or rather belongs here. *Vagnera pumila* is distinguished from the eastern plant by the short leaves, small size of the plant, less spreading pedicels, and especially by the very short style. The raceme, too, is all exserted beyond the leaves while in *V. trifolia* it seldom more than equals them.

**ARTEMISIA LAEVIGATA Standley, sp. nov.**

Perennial; stems stout, 25 to 30 cm. high, erect from an ascending base, finely striate, reddish, glabrous; basal leaves on slender petioles, twice pinnatifid into oblong-linear acute segments, glabrous, bright green, thick; cauline leaves mostly once, sometimes twice pinnatifid into narrow acute segments, the upper ones sessile, the lower petiolate, those of the inflorescence mostly oblong-linear and entire; heads few, about 5 to 8, large, 8 to 10 mm. in diameter, broadly campanulate, cernuous on slender erect peduncles 7 to 16 mm. long; bracts glabrous, 3 to 4 mm. long, in 2 or 3 series, ovate, obtuse, with scarious erose margins, green with a broad dark brown border; receptacle naked, glabrous; flowers apparently all fertile; corolla trumpet-shaped, slightly constricted at the throat, 2 mm. long, with short-triangular erect or reflexed lobes, glabrous or with a few short white hairs at the base, yellowish or the lobes tinged with reddish purple; mature achenes not seen, the undeveloped ones short, glabrous.

Type in the U. S. National Herbarium, no. 622563, collected at the head of Smoky River in western Alberta, August 5, 1911, by J. H. Riley (no. 30).

This appears to be most closely related to *Artemisia arctica* Less. It differs from that species and its allies in being quite glabrous. Its leaves, too, are less dissected than in other members of the group.

**GAILLARDIA BRACTEOSA Standley, sp. nov.**

Stems rather slender, tall, about 70 cm. high, ascending or erect, branched from the base and throughout, sparingly and minutely glandular, beset with abundant cobwebby hairs, purplish, striate; basal leaves not seen; cauline ones lanceolate or oblong lanceolate, 35 to 80 mm. long and 10 to 18 mm. wide, entire, acute or nearly obtuse, sessile by a usually clasping base, bright green, minutely

glandular-puberulent and with rather few soft, weak, many-celled hairs on both surfaces; peduncles long and tortuous, 14 to 22 cm., glandular-puberulent and abundantly villous; heads, exclusive of the rays, 2 cm. in diameter, hemispheric or nearly globose; involueral bracts in several series, 1 to 2 cm. long, elliptic or elliptic-lanceolate, the outer much longer and broader than the linear inner ones, purplish at the base and on the margins, elsewhere bright green, most of them abruptly acute, freely arachnoid especially when young; rays bright deep yellow, 25 to 30 mm. long, 3-lobed at the apex, the lobes oblong, obtuse, glabrous on the upper surface but bearing a few short, several-celled hairs beneath; corollas purplish, the tube nearly or quite glabrous, the lobes triangular, acute, glandular-villous; achenes obpyramidal, densely covered with coarse, appressed, bristle-like hairs; pappus of lanceolate, white, hyaline scales with long-attenuate tips; fimbriæ of the receptacle coarse, setiform, not much longer than the achenes.

Type in the U. S. National Herbarium, no. 622536, collected near Henry House, Alberta, September 11, 1911, by J. H. Riley (no. 4).

Our plant, the northernmost representative of the genus apparently, is similar to *G. aristata* Pursh but is at once distinguished by the elongated, broad outer bracts of the involucre as well as by the tall stems, short fimbriæ of the receptacle, entire leaves, and rather different pubescence.

#### SVIDA PUBESCENS (Nutt.)

*Cornus pubescens* Nutt. *Sylva* 3: 54. 1849.

*Cornus sericea* ? *occidentalis* Torr. & Gr. *Fl. N. Amer.* 1: 652. 1840.

*Cornus occidentalis* Coville, *Contr. Nat. Herb.* 4: 117. 1893.

Among the shrubs collected is one which appears not to have been segregated from the genus with which it has been associated. As has been shown by Dr. J. K. Small and others, the genus *Svida* is a well marked one, and should not be combined with typical *Cornus*.









SMITHSONIAN MISCELLANEOUS COLLECTIONS

VOLUME 56, NUMBER 34

# A NEW LEATHER FLOWER FROM ILLINOIS

WITH ONE PLATE

By

PAUL C. STANDLEY



(PUBLICATION 2070)

CITY OF WASHINGTON  
PUBLISHED BY THE SMITHSONIAN INSTITUTION  
FEBRUARY 7, 1912

*The Lord Baltimore Press*  
BALTIMORE, MD., U. S. A.

## A NEW LEATHER FLOWER FROM ILLINOIS.

By PAUL C. STANDLEY

(WITH ONE PLATE)

During the last three or four years Mr. Robert Ridgway, Curator of the Division of Birds of the U. S. National Museum, has presented to the National Herbarium several interesting lots of plants collected at his summer home, Bird Haven, near Olney, Richland County, in southern Illinois. Coming from a region of whose flora we know comparatively little, either through published reports or through herbarium material, these collections have proved to be especially interesting and might well be reported upon fully.

Bird Haven consists of some eighteen acres situated two and one-half miles north of Olney. The land was once entirely cleared and many of the original components of its flora have doubtless disappeared. In later years the ground has remained untilled and unpastured and is now covered with a growth of trees and shrubs, while many of the herbaceous plants have reestablished themselves. Although some of the arborescent species are represented only by still immature individuals no less than 56 have been detected within this small area. As examples of the interesting variety of trees and shrubs growing spontaneously here may be enumerated the following: *Juniperus virginiana*, *Salix nigra*, *Populus deltoides*, *Quercus imbricaria*, *Q. schneckii*, *Q. palustris*, *Q. macrocarpa*, *Q. platanoides*, *Q. rubra*, *Q. velutina*, *Q. marilandica*, *Q. minor* and *Q. acuminata*; *Juglans nigra* and *J. cinerea*; *Hicoria minima*, *H. alba*, *H. glabra*, *H. villosa*, *H. laciniosa*, and *H. ovata*; *Ulmus fulva* and *U. americana*; *Morus rubra*, *Celtis crassifolia*, *Toxylon pomiferum*, *Asimina triloba*, *Liriodendron tulipiferum*, *Platanus accidentalis*; *Malus angustifolia* and *M. coronaria*; *Prunus americana* ?, *P. hortulana*, *P. angustifolia* ?, and *P. serotina*; two species of *Cratægus*, *Gleditsia triacanthos*, *Cercis canadensis*; *Acer saccharum*, *A. rubrum* and *A. nigrum* ?; *Sassafras*, two species—perhaps three—of *Fraxinus*; *Nyssa sylvatica*, *Cornus florida*, *Diospyros virginiana*, *Catalpa catalpa*, and *Viburnum prunifolium*. Liquidambar grows near by, as well as *Quercus michauxii*. Along the Big Fox not far distant are found *Ulmus*

*alata* and *Quercus lyrata*. These trees were formerly abundant in the surrounding region but the utilization of the land for agricultural purposes has greatly lessened their numbers.

Most interesting, perhaps, of the woody plants from this locality is a member of the genus *Viorna*, a group best developed in the southern United States, of which Dr. J. K. Small has named a number of well marked species within the past few years. This plant whose description appears here seems to be undescribed. It is a near ally of the most common species, *Viorna viorna*, a plant not rare in rich woods as far north as Pennsylvania. Probably our species will be found to occur elsewhere in southern Illinois and Indiana and adjacent Kentucky. So far it has been collected only at Bird Haven and the number of specimens here is limited. The plants from which the type was taken grow along or near the south bank of the "East Fork" of the Fox River in a flat bottom land that is overflowed for short periods many times annually. Associated with it are such species as *Cephalanthus occidentalis*, *Symphoricarpos symphoricarpos*, *Sambucus*, *Ptelea trifoliata*, *Erythronium atropurpureum*, *Amorpha fruticosa*, *Rubus (nigrobaccus?)*, *Menispermum canadense*, *Psedera quinquefolia*, *Tecoma radicans*, and *Rhus toxicodendron radicans*. This plant may be known as

**VIORNA RIDGWAYI Standley, sp. nov.**

PLATE I

A slender vine; stems striate, somewhat swollen at the nodes, brown, rather densely silky pubescent when young, in age glabrous or sparingly pubescent; leaves pinnate, with 3 or 4 pairs of leaflets, commonly ending in a tendril; petioles 4 to 5 cm. long, striate, sparingly pubescent or glabrous; leaflets 3-parted or 3-cleft, on petiolules 30 to 35 mm. long; segments of the leaflets thin, finely reticulate-veined, bright green, glabrous on the upper surface, with a few scattered appressed hairs beneath, entire, the lateral ones inaequilateral, rhombic-ovate or rhombic-oval or oblong, 25 to 45 mm. long, 10 to 20 mm. wide, abruptly acute or attenuate, the terminal segment broadly elliptic or oval, 30 to 50 mm. long and 15 to 25 mm. wide, abruptly long-acuminate, the nearly linear tip 4 or 5 or even 6 mm. long; secondary petiolules 5 mm. long or less; leaflets when entire deltoid-ovate, abruptly short-acuminate, subcordate; peduncles slender, appressed pubescent, 5 to 10 cm. long; sepals thick and leathery, 20 mm. long and 10 mm. wide or smaller, ovate or ovate-lanceolate, abruptly acuminate and with long subulate tips, silky

pubescent, densely so about the apex; mature achenes not seen, the immature ones with long persistent plumose styles.

Type in the U. S. National Herbarium, no. 619852, collected by Mr. Robert Ridgway at Bird Haven, two and one-half miles north of Olney, Richland County, Illinois, June 6, 1910. Additional material is mounted on sheet 619853.

The proposed species is a near relative of *Viora viorna* the common leather-flower. It differs chiefly in the outline and especially the tips of the leaf-segments. In *V. viorna* the leaflets are merely abruptly acute and the tips, if there are any, are not more than a millimeter or perhaps two, in length. The pubescence is much more abundant in *V. ridgwayi*, as well. I have seen no other collections of the species, but this is not surprising since so few collections have been made in southern Illinois.

Plate I represents a leaf of the type, two-thirds natural size.



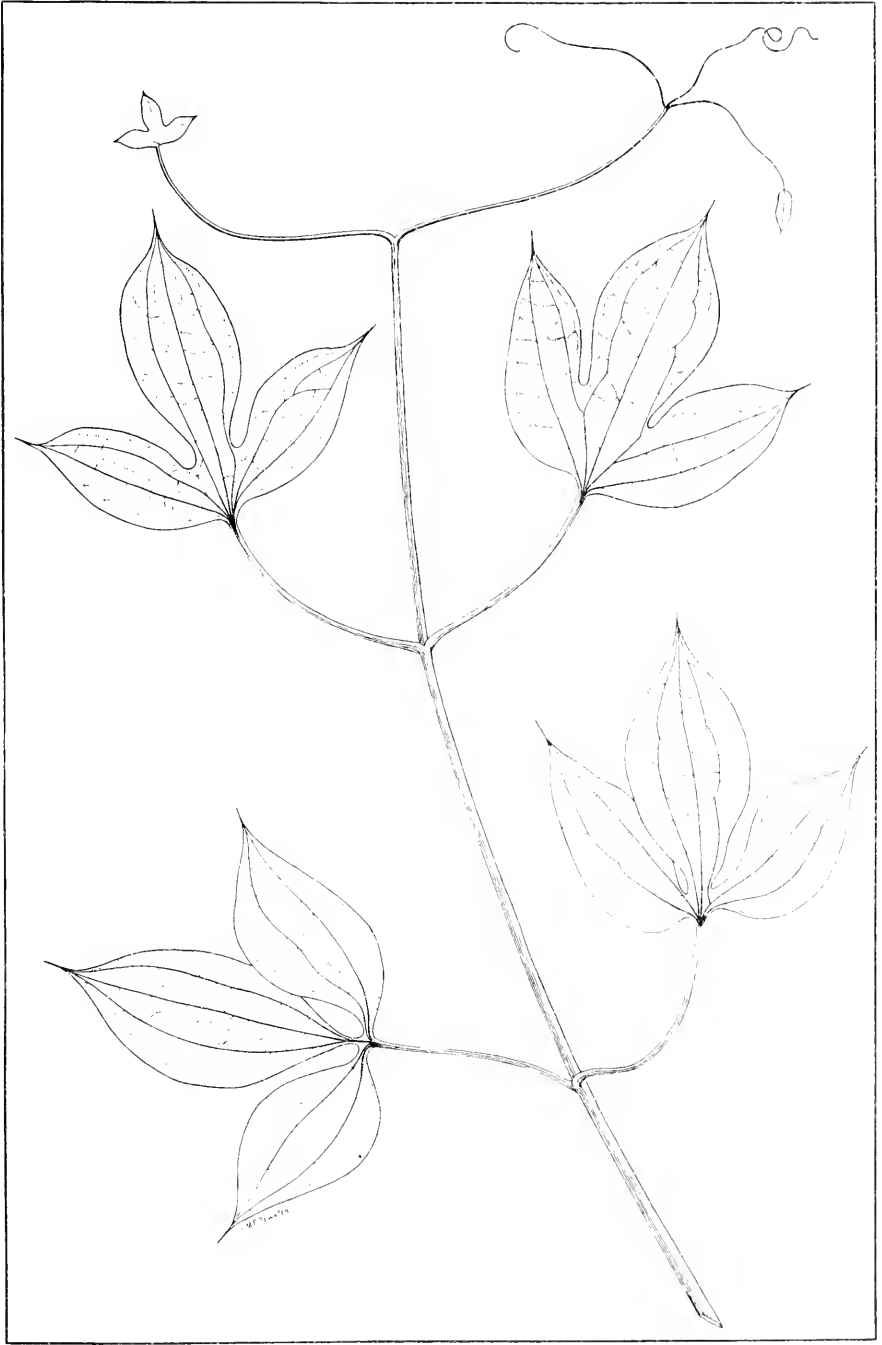

VIGNA RIDGWAYI Standley  
(TWO-THIRDS NATURAL SIZE)





SMITHSONIAN MISCELLANEOUS COLLECTIONS

VOLUME 56, NUMBER 35

NEW MAMMALS FROM CANADA, ALASKA,  
AND KAMCHATKA

WITH THREE PLATES

BY

N. HOLLISTER



(PUBLICATION 2072)

CITY OF WASHINGTON  
PUBLISHED BY THE SMITHSONIAN INSTITUTION  
FEBRUARY 7, 1912

**The Lord Baltimore Press**  
BALTIMORE, MD., U. S. A.

NEW MAMMALS FROM CANADA, ALASKA, AND  
KAMCHATKA

By N. HOLLISTER

(WITH THREE PLATES)

A study of the larger mammals collected by the Smithsonian party on the Alpine Club of Canada expedition to Jasper Park and the Mount Robson region, during the summer of 1911, has resulted in the discovery of several unrecognized forms. The hoary marmot and the caribou from the vicinity of Moose Pass prove to be new; and a thorough study of the caribou in the National Museum collections shows the necessity of recognizing three additional forms. For the subspecies of the eastern woodland caribou found in Kewatin and Manitoba, Richardson's name *sylvestris* is revived; and new species from the Arctic coast of Alaska and from Kamchatka are named.

**MARMOTA SIBILA, sp. nov.**

*Type* from head of Moose Pass branch of the Smoky River, Alberta; 7,200 feet. Cat. no. 174503, U. S. National Museum. Adult female, skin and skull. Collected August 3, 1911, by N. Hollister and C. D. Walcott, Jr. Original no. 3871.

*Characters*.—A large member of the *caligata* group; much larger (as known only by the female) than *M. caligata*; coloration dark; cheeks ochraceous. Skulls of females equal in size to largest male skulls of *caligata*.

*Color of type* (new coat replacing the worn pelage).—Hair around nose and lips white; top of nose and malar stripe black; a whitish strip across forehead between eyes; top of head and nape mixed brown and black; sides of neck and lower throat ochraceous. Shoulders and forward part of body, above, grizzled, the hairs dull blackish underneath, white above, with brownish-black tips. Posterior part of back (still largely in the old coat) mixed brown, black, and buff. Feet black, the hands with scattering white hairs. Underparts brownish-gray, bright hazel at base of tail. Tail above with black center; bordered and tipped with dull mummy brown; beneath Vandyrke brown. Immature specimens differ from young of *M. caligata*,

from western Alaska, in the great amount of black in the coat. Two young males have the whole crown, nape, lower back, and feet, black; and the tail black above and below, narrowly edged with ochraceous.

*Skull and teeth.*—The skulls of females are slightly larger than male skulls of *M. caligata*, and are about the size of male skulls of *M. olympus*. Compared with skulls of adult females of *caligata*, the female skulls of *M. sibilata* are very much larger, relatively narrower, and with elongated rostra. The orbital ring is relatively much smaller; the tip of postorbital process, as viewed from above, almost in center between maxillary and squamosal arms of zygomatic arch [in *caligata* much further back, or forward only about one-third the distance from squamosal arm]; coronoid process of mandible reduced, the superior notch one and one-half times as long as high at point of coronoid process [in *caligata* same length as height to point of coronoid]; teeth slightly smaller.

*Measurements of type* (adult female).—Head and body, 510 millimeters; tail vertebrae, 210; hind foot, 95. Skull of type and female topotype, the latter in parentheses: Condylbasal length, 101.5 (104.2); palatal length, 56.5 (62.1); postpalatal length, 40.9 (38.5); zygomatic breadth, 67 (66.3); length of nasals, 44 (40.5); alveolar length of upper tooth row, 22.5 (23.5); alveolar length of mandibular tooth row, 21 (22.3).

*Remarks.*—A large series of hoary marmot skulls from the Alaska Peninsula around the coast to Mount Rainier, Washington, including topotypes of *M. vigilis*, shows remarkably little variation in size; and the relative size of male and female skulls is constant. The males are considerably larger. As the female skulls of *M. sibilata* about equal the male skulls of *M. olympus*, the new species must be the largest American marmot. Specimens of the hoary marmot from Stuart Lake, Barkerville, Glacier, and other points in British Columbia, west of the main Rockies, and from northern Idaho, are much like true *caligata* from western Alaska, and show no approach toward *M. sibilata* in cranial characters. The name *Arctomys okanaganus*, proposed by King in 1836<sup>1</sup> for a hoary marmot from the southern interior of British Columbia thus remains in synonymy, unless the *caligata*-like marmots of these interior ranges prove subspecifically separable from true *caligata* from Bristol Bay. A female specimen

<sup>1</sup> Narrative of a Journey to the Arctic Ocean, Vol. 2, p. 236, 1836.

from St. Mary's Lake, Montana, is clearly referable to *M. sibila*, which thus ranges along the eastern Rockies to the United States boundary.

**RANGIFER FORTIDENS, sp. nov.**

*Type* from head of Moose Pass branch of the Smoky River, Alberta (north-east of Mount Robson). Cat. no. 174505, U. S. National Museum. Adult male, skin and skull. Collected July 29, 1911, by N. Hollister and C. D. Walcott, Jr. Original no. 3826.

*Characters*.—Largest of the caribou, exceeding in measurements the largest specimens of *Rangifer osborni* and *R. montanus*. Coloration very dark, no whitish on underparts of body. Teeth conspicuously larger than in other species. Antlers stout and heavily palmated; not so long and slender as in *osborni*; main beam nearly straight. Females normally without antlers.

*Color of type*.—Head blackish-brown; neck grayish-brown, with a small white throat-mane. Shoulders and body deep brownish-black; a stripe of the old pelage on belly shows the long faded brown hair of the winter coat; the new coat coming in here is almost as dark as the back. Legs blackish-brown; feet broadly white around hoofs. Rump patch small, white; tail like back above, bordered with white, a continuation of the rump patch. Five topotypes, four younger bulls and one cow, show the new coat, which is replacing the faded winter pelage, to vary from clove brown to clear black.

*Skull and teeth*.—Skull largest in size, general proportions much as in *osborni*, but larger, more massive, and with rostrum and palate actually and relatively much broader, and nasals proportionally longer. Exceeds the largest skulls of *montanus* from the Selkirk and Gold Ranges in every measurement. Teeth conspicuously larger than in any other species; each tooth longer and much heavier. Upper premolars and the mandibular teeth especially large. Posterior external cusp of  $pm_3$  and  $pm_4$  separated from remainder of crown-pattern of respective teeth by a deep and broad valley, widening at the exterior edge; the cusp ridge standing almost at right angles with longitudinal axis of tooth, the crown-pattern connecting with tooth immediately behind rather than pattern of crown of tooth of which it is a part. Compared with corresponding teeth of other caribou this character is very conspicuous. In the last premolars of other species, the posterior external cusp lies close to and parallel with the diagonal ridge connecting the posterior internal cusp with the main outer cusp, from which it is separated by a narrow and shallow sulcus. Incisors of the "woodland" type

(more uniformly grading in size from middle to outer pair than in the "barren-ground" type, which decrease by conspicuous steps, with the outer pairs very small).

*Antlers* large and stout; main ascending beam rather straight, without the low, sweeping, backward curve of *osborni*; less slender and more palmated.

*Measurements of type*.—Head and body, 2,220 millimeters; tail vertebrae, 150; hind foot, 690. Skull: Condylbasal length, 427; palatal length, 268; postpalatal length, 136.5; greatest orbital breadth, 182; greatest length of nasals, 151; maxillary tooth row, crowns, 112; mandibular tooth row, crowns, 120; length of upper molars, 62.1; upper premolars, 52; greatest breadth of  $m^2$ , 18; lower molars, length, crowns, 70.5; lower premolar row, 50.

*Remarks*.—From its large size and dark coloration, this species scarcely needs comparison with *Rangifer caribou sylvestris* Richardson, represented in the National Museum collection by specimens from Nelson River, Keewatin, and east of Lake Winnipeg, Manitoba. Six specimens of *Rangifer fortidens*, all from the type locality, have been examined. Apparently the females of this species are normally without antlers. A number seen and one killed lacked them, and the resident hunters all told me this was the usual condition. The cow collected, a sub-adult specimen, has small knobs on the skull, which did not pierce the skin. The type specimen, a magnificent bull, was shot by Chas. D. Walcott, Jr., in the snow fields above timberline.

#### RANGIFER CARIBOU SYLVESTRIS (Richardson)

1829. *Cervus tarandus*, var.  $\beta$  *sylvestris* RICHARDSON, Fauna Boreali Americana, Vol. 1, p. 250.

*Type locality*.—Southwestern shores of Hudson Bay.

*Characters*.—Like *Rangifer caribou caribou* of eastern Canada, but skull longer and more slender; rostrum narrower; teeth larger, the tooth rows, especially mandibular row, longer; nasal bones longer. Neck and head darker in color; ears, back and sides of neck, much darker, the hairs brown to roots.

*Measurements of skulls*.—Adult male (east of Lake Winnipeg, Manitoba): Total length 417 millimeters; condylbasal length, 398; greatest orbital breadth, 163; breadth of rostrum in front of first premolars, 73; upper tooth row, 107; lower tooth row, 112.5. Adult female (Nelson River, Keewatin): Total length, 396; condylbasal length, 377; greatest orbital breadth, 165.5; breadth of rostrum in front of first premolars, 68; upper tooth row, 102.5; lower tooth row, 113.5.

*Remarks.*—A careful comparison of four skulls of adult caribou from Manitoba and Keewatin with ten skulls from eastern Canada and Maine, has convinced me that Richardson's *sykestrís* is a good subspecies of the eastern *Rangifer caribou*. I am indebted to Dr. Glover M. Allen, of the Museum of Comparative Zoölogy, Cambridge, Massachusetts, for the loan of several skulls of eastern caribou, to supplement the National Museum series for this study.

**RANGIFER EXCELSIFRONS, sp. nov.**

*Type* from Meade River, near Point Barrow, Alaska. Cat. no. 16755, U. S. National Museum. Adult male, skull only. Collected March, 1883, by Lieutenant P. H. Ray. Original no. 1496.

*Characters.*—Skull short and broad. Compared with a large series of skulls of *Rangifer arcticus* from Fort Anderson and Fort Rae, Mackenzie, it is about the same average breadth across orbits, but with rostrum considerably shorter. Braincase very high; the frontal bone abruptly rising, back of frontal depression, to a height of 35 millimeters above general plane of rostrum; angle of profile of forehead from line of nasal bones and anterior portion of frontals is about 45 degrees. The two branches of the parieto-frontal suture meet to form the median frontal suture at the apex of this high crown. Hollow between orbits deep and rounded. Teeth much as in *arcticus*. Compared with all American mainland caribou the character of this high braincase is very distinctive. The skull of *Rangifer graelandicus*, however, exhibits much the same forehead inflation, but the braincase in this species is very narrow, as opposed to the broad braincase of *R. excelsifrons*. The general shape of the skull of *excelsifrons* is much like that of the Kamchatkan reindeer but the size is very much less.

*Measurements of type skull.*—Condylbasal length, 366 millimeters; basal length, 344; palatal length, 230; postpalatal length, 114; greatest breadth, 175; greatest length of nasals, 119; maxillary tooth row, crowns, 92.5; mandibular tooth row, 96; upper molars, 52; upper premolars, 43; lower molars, 57.1; lower premolars, 42.

*Remarks.*—With a series of over eighty skulls of American mainland caribou before me, I find no specimens of other forms approaching *R. excelsifrons* in the peculiar shape of the braincase. Compared with a good series of skulls of *R. stonci*, the skull of *R. excelsifrons* is very short and relatively broad. Skulls of old male *stonci* frequently develop a longitudinal ridge on the forehead, which is very different from the general broad elevation of the crown of *excelsi-*

*frons*. The two skulls of *R. granti* available for comparison are peculiar in the hypsodont character of the molariform teeth. Two skulls, collected by Lieutenant Ray on the Meade River, are referred to this new species. Unfortunately no skins of caribou from the Arctic coast of Alaska are available, and the external characters of this form can not now be described.

**RANGIFER PHYLARCHUS, sp. nov.**

*Type* from southeastern Kamchatka. Cat. no. 21343. U. S. National Museum. Adult male, skull. Collected in 1883, by Dr. Leonhard Stejneger. Orig. no. 2709.

*Characters*.—Largest of the Palearctic reindeer; exceeds *Rangifer tarandus fennicus* of Finland in every important cranial measurement. Skull very much larger than that of *R. t. sibiricus*, with higher braincase and smaller teeth.

*Skull and teeth*.—Skull large, massive, and elongated. Compared with measurements of skull of *R. t. sibiricus*, as published by Doctor Lönnberg,<sup>2</sup> it is very much larger than that form, with a relatively narrower rostrum. Braincase high and rounded; frontal bones concave in center and rising abruptly, back of frontal depression, to a height of about 35 millimeters above plane of rostrum. Lachrymal vacuities large. Mandible relatively slender. Tooth rows measuring less than in *sibiricus*, but probably averaging about same actual size, and thus relatively much smaller. The incisor teeth are, unfortunately, missing.

*Measurements*.—For measurements of the type skull see table below.

*Remarks*.—As known from the skull alone, the Kamchatkan reindeer is a very different animal from the species of northeastern Siberia, referred by Doctor Lönnberg to *R. t. sibiricus* Murray. The name *sibiricus* dates, however, from Schreber, "Die Saugthiere," plate 248c, 1784, instead of from Murray's "Geographical Distribution of Mammals," as stated by Doctor Lönnberg. This fact puts the question of the name of the reindeer from the Chukchi country, as represented by the Nordqvist specimen described by Doctor Lönnberg, in a different light. A careful review of the text for the reindeer plates of Schreber's work, published in 1804, gives little help in determining a type locality for *sibiricus*. It is evident that the plate is chiefly based upon a description of the color of the 'Siberian' reindeer, furnished Schreber in a letter from Pallas—"Die sibiris-

<sup>2</sup> Arkiv för Zool., Vol. 6, hft. 1, No. 4, pp. 17-18, 1909.



chen sind nach Pallas im Sommer dunkel mausefarbig, im Winter weisslichgrau," (Schreber, l. c., p. 1034). On page 1039, Schreber says that Pallas found wild reindeer on the Kama and Ufa; and on the Obi, in the neighborhood of the Berezov Mountains. The last place, as a Pallas Siberian locality known at the time to Schreber, might be regarded as the type locality.

From our present imperfect knowledge of the Asiatic wild reindeer, it has been necessary for me to compare the Kamchatkan animal with Doctor Lönnberg's '*sibiricus*' of the Chukchi country, though it is scarcely to be doubted that there is more than the one form of this animal between the extremes of northeastern and northwestern Asia. The size and relative proportions of the Kamchatkan species are best expressed in a table of comparative measurements. In the following I have copied Doctor Lönnberg's measurements of adult male skulls of *R. t. fennicus* and of *R. t. 'sibiricus*,' and added the measurements of the type skull of the new species from Kamchatka.

Measurements of Skulls of Adult Male Reindeer.

	<i>R. t. fennicus</i>	<i>R. t. 'sibiricus'</i>	<i>R. t. phyllotrichus</i>
Basal length .....	357	329	387
Distance from <i>crista occipitalis</i> to tip of premaxillaries...	397	362	430
Distance from <i>crista occipitalis</i> to tip of nasals.....	302	276	325
Length of nasals .....	125	129	135
Width of single nasal at <i>os supramaxillare accessorium</i> ..	21	16	23.4
Width of single nasal at middle .....	23.5	18	25
Width of single nasal just in front of lachrymal vacuity..	36	37	43.0
Combined width of both nasals at <i>os supramaxillare accessorium</i> .....	36	32	40.2
Combined width of both nasals at narrowest place.....	33	29	39.5
Combined width of both nasals just in front of lachrymal vacuities .....	54	62	68
Distance from <i>crista occipitalis</i> to posterior end of nasals	176	147	195
Distance between tip of nasals and tips of premaxillaries..	104	92	119.5
Distance in line from <i>m</i> <sup>2</sup> to nasal suture.....	115	103	120
Vertical height of skull on level with anterior end of nasals .....	69	57	74
Width of skull just behind the canines.....	69	72	75
Width of skull on a line with anterior end of nasals....	72	69	72
Interorbital width at the middle of the orbits.....	149	126	148
Width of skull on a level with <i>meatus auditorius</i> .....	142.5	117	153.2
Zygomatic width just behind the orbits.....	149	139	152
Length of upper molar series .....	85	93	91.5
Length of lower molar series .....	90	102	98.5
Distance from orbit to tip of premaxillary.....	243	223	268

## EXPLANATION OF PLATES.

## PLATE I

Molar-premolar Rows of *Rangifer* (Natural Size)

- FIG. 1. *R. fortidens*, upper left tooth row. Type. ♂ ad. Smoky River, Alberta. (Cat. No. 174505 U. S. N. M.)
- FIG. 1a. *R. fortidens*, lower left tooth row. Type. ♂ ad. Smoky River, Alberta. (Cat. No. 174505 U. S. N. M.)
- FIG. 2. *R. osborni*, upper left tooth row. ♂ ad. Klappan River, British Columbia. (Cat. No. 171093 U. S. N. M., Biological Survey Collection.)
- FIG. 2a. *R. osborni*, lower left tooth row. ♂ ad. Iskut River, British Columbia. (Cat. No. 171092 U. S. N. M., Biological Survey Collection.)
- FIG. 3. *R. montanus*, upper left tooth row. ♂ ad. Okanagan County, Washington. (Cat. No. 105947 U. S. N. M.)

## PLATE 2

Skulls of *Rangifer* (ventral views, reduced)

- FIG. 1. *R. caribou caribou*. ♀ ad. Houlton, Maine. (Cat. No. 57823, U. S. N. M.)
- FIG. 2. *R. caribou sylvestris*. ♀ ad. Nelson River, Keewatin. (Cat. No. 3289, U. S. N. M.)
- FIG. 3. *R. phylarchus*. ♂ ad. Type. Eastern Kamchatka. (Cat. No. 21343, U. S. N. M.)

## PLATE 3

Skulls of *Rangifer* (lateral views, reduced)

- FIG. 1. *R. excelsifrons*. ♂ ad. Type. Meade River, Alaska. (Cat. No. 16755, U. S. N. M.)
- FIG. 2. *R. arcticus*. ♂ ad. Fort Rae, Mackenzie. (Cat. No. 6277, U. S. N. M.)
- FIG. 3. *R. phylarchus*. ♂ ad. Type. Eastern Kamchatka. (Cat. No. 21343, U. S. N. M.)

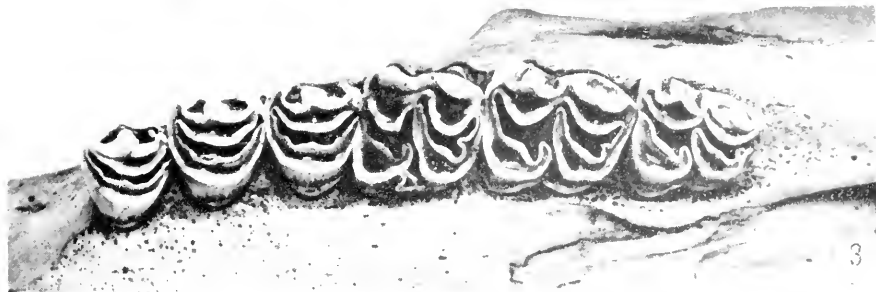
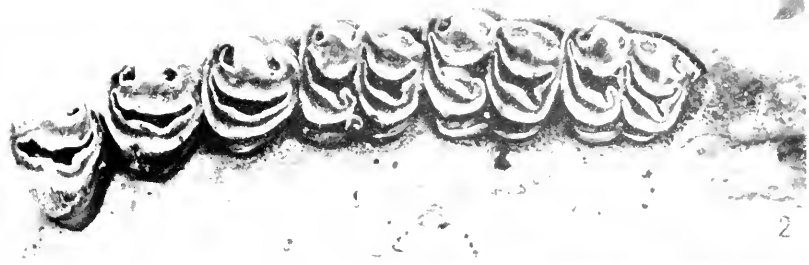

TOOTH ROWS OF RANGIFER (Natural Size).

FIGS. 1 AND 1A, R. FORTIDENS; 2 AND 2A, R. O-BORNEI; 3, R. MONTANUS.





1

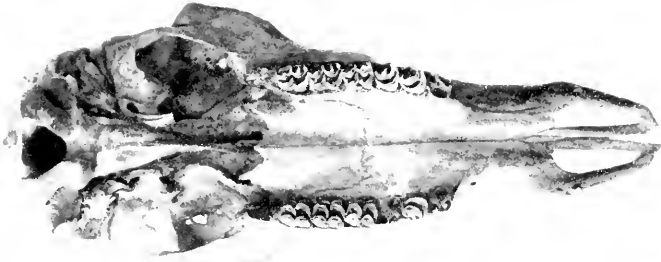

2

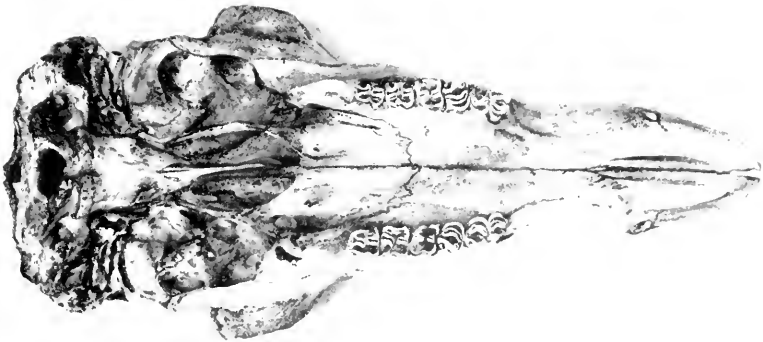

3

SKULLS OF RANGIFER (Reduced)

FIG. 1. *R. CARIBOU CARIBOU*; 2. *R. CARIBOU SYLVESTRIS*; 3. *R. PHYLARCHUS*.



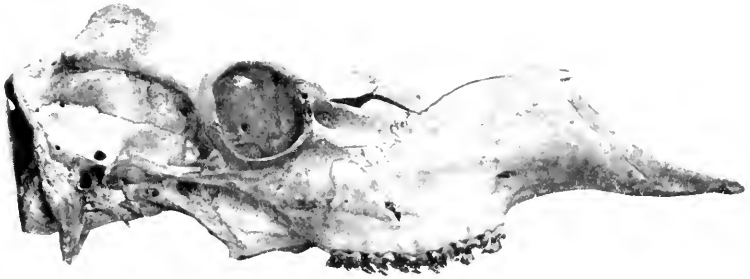

1

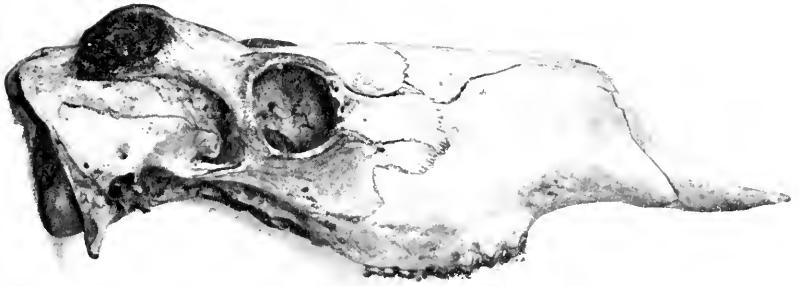

2

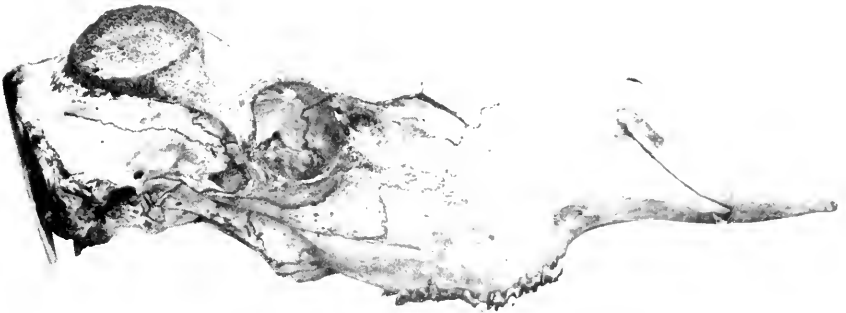

3

SKULLS OF RANGIFER - Reduced

FIG. 1. R. EXCELSIFRONS; 2. R. ARCTICUS; 3. R. PHYLARCHUS.





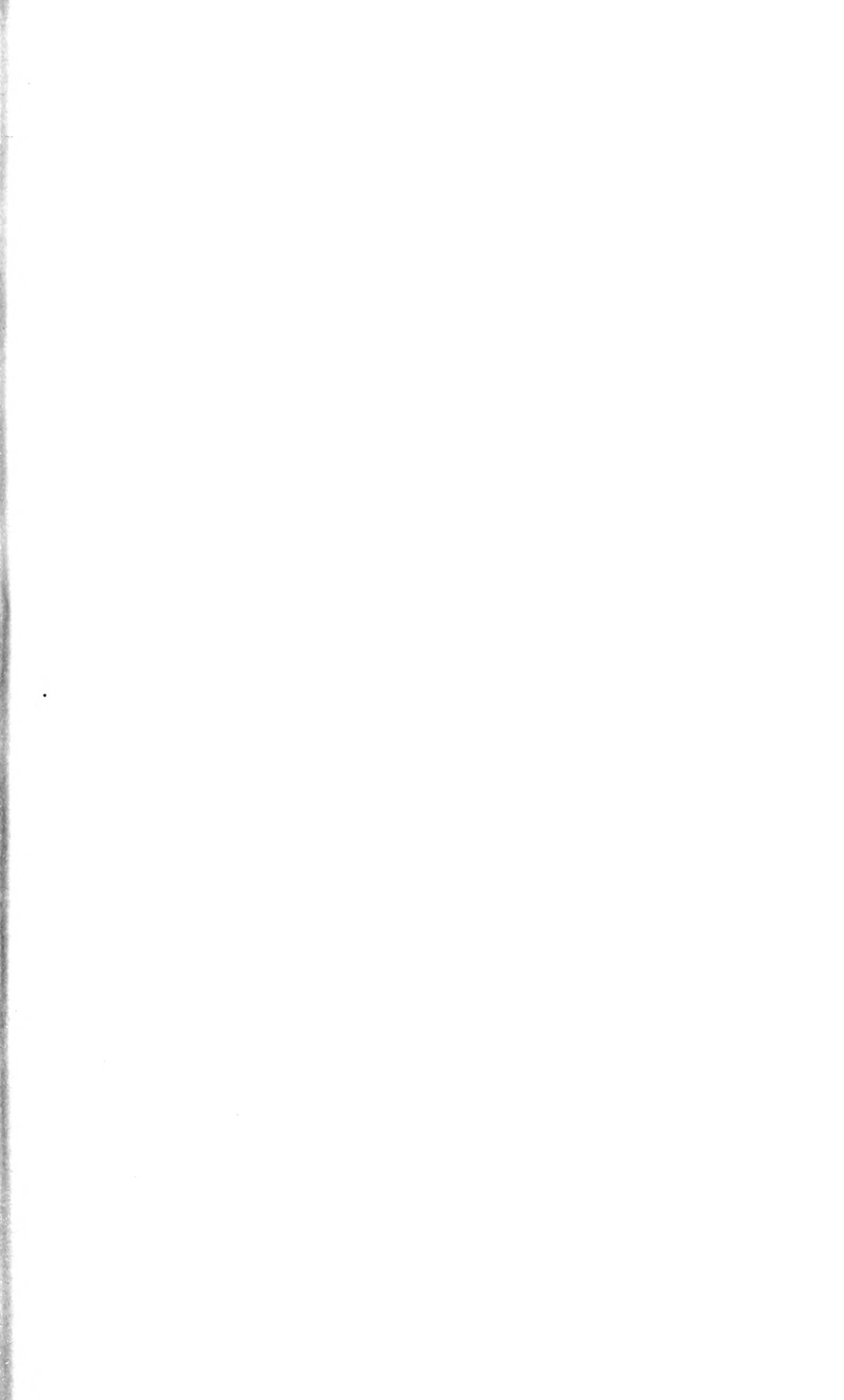



SMITHSONIAN MISCELLANEOUS COLLECTIONS

VOLUME 56, NUMBER 36

DESCRIPTIONS OF TWELVE NEW SPECIES  
AND SUBSPECIES OF MAMMALS  
FROM PANAMA

BY

E. A. GOLDMAN



(PUBLICATION 2073)

CITY OF WASHINGTON  
PUBLISHED BY THE SMITHSONIAN INSTITUTION  
FEBRUARY 19, 1912

**The Lord Baltimore Press**  
BALTIMORE, MD., U. S. A.

## DESCRIPTIONS OF TWELVE NEW SPECIES AND SUBSPECIES OF MAMMALS FROM PANAMA<sup>1</sup>

By E. A. GOLDMAN

In the early part of 1911 a collection of 368 mammals was made by me while engaged in the biological survey of the Canal Zone, and adjacent parts of Panama, undertaken by the Smithsonian Institution in coöperation with several government departments, including the War Department and the Department of Agriculture. This collection, representing between 40 and 50 genera, includes 12 new species and subspecies which are here published in advance of a general report on the mammals of the region. Nine of the new forms are from the Canal Zone, and the others were taken while on a visit, in March, to the mountains near the headwaters of the Chagres River.

Acknowledgments are due, especially, to Col. George W. Goethals, U. S. Army, and others connected with the administration of the Canal Zone, who aided materially in the prosecution of the work of the survey. I am also indebted to Dr. J. A. Allen for the privilege of making comparisons with types and other material in the American Museum of Natural History, and to Mr. Samuel Henshaw for the loan of specimens from the Bangs Collection in the Museum of Comparative Zoölogy.

### MARMOSA ISTHMICA, sp. nov.

*Type* from Rio Indio, near Gatun, Canal Zone, Panama. No. 170969, male adult, U. S. National Museum (Biological Survey Collection), collected by E. A. Goldman, February 16, 1911. Original number 20880.

*General characters*.—Size large, about as in *chapmani* and *ruatanica*, larger than *mexicana*, *zeledoni* or *mitis*; color about as in *chapmani*, but skull with narrower rostrum, slightly smaller teeth, and decidedly smaller auditory processes of alisphenoids.

*Color*.—General color of upper parts brownish cinnamon, lighter on middle of face, and becoming dull ochraceous buff on sides of

<sup>1</sup>This paper is the sixth dealing with the results of the Smithsonian Biological Survey of the Panama Canal Zone.

neck and flanks: under parts between cream buff and pinkish buff, this color extending to roots of hairs; ears brown; orbital area black; fore feet brownish to base of toes; hind feet and toes of fore feet dull whitish; longer hairs at base of tail on under side tawny ochraceous; tail light brownish.

*Skull*.—Similar in general to that of *chapmani*, but rostrum narrower; nasals less prolonged posteriorly; auditory processes of alisphenoids decidedly smaller; teeth slightly smaller. Differing from that of *matanica* in narrower rostrum and more strongly developed supraorbital ridges.

*Measurements*.—Total length, 385 mm.; tail vertebrae, 215; hind foot, 28. *Skull* (type): Greatest length, 43.5; condylobasal length, 42.7; zygomatic breadth, 23.7; nasals, 20 x 5.1; interorbital breadth, 6.2; palatal length, 21.5; upper molariform toothrow, 13.8; three anterior molariform teeth, 6.2.

*Remarks*.—A single specimen of this large pale colored species was trapped in an old banana plantation only a few feet above sea level.

**METACHIRUS NUDICAUDATUS DENTANEUS, subsp. nov.**

*Type* from Gatun, Canal Zone, Panama. No. 172732, male adult, U. S. National Museum (Biological Survey Collection), collected by E. A. Goldman, January 12, 1911. Original number 20837.

*General characters*.—Most closely allied to *M. n. colombianus*; color paler, less tawny; skull differing in detail.

*Color*.—General color of upper parts, including outer sides of hind legs, near wood brown, darkened along back by blackish, the black predominating in a narrow line down middle of rump to tail; median area on top of head glossy black, this color fading gradually by admixture with lighter hairs along a narrowing line reaching anteriorly to nose and posteriorly to back of neck; orbital rings and sides of muzzle blackish; cheeks, supraorbital spots, and area about ears ochraceous buffy, the color richest about ears; shoulders suffused with plumbeous, the basal color being darker and showing through; under parts, including inner sides of limbs, yellowish white; outer sides of fore limbs grayish, tinged with buffy; fore feet mainly dusky, becoming abruptly whitish along outer side of tarsus and on toes; hind feet dull white; tail dusky above, lighter below, becoming whitish all round near tip.

*Skull*.—Similar in general to that of *colombianus*, but dentition heavier; first, second, and third upper molars more deeply emarginate externally; zygomata lighter.

*Measurements.*—Type: Total length, 597 mm.; tail vertebrae, 33.2; hind foot, 48. *Skull* (type): Greatest length, 63; condylobasal length, 61.7; zygomatic breadth, 31.7; nasals 30 x 9.5; interorbital breadth, 9.3; palatal length, 34.5; upper molariform toothrow, 22.2.

*Remarks.*—In Panama this form seems to be a much rarer animal than *M. fuscogriseus*, which occurs at the same localities and seems to have similar habits. A specimen taken at 2500 feet elevation on Cerro Azul, near the headwaters of the Chagres River is like those from near sea level at Gatun.

*Specimens examined.*—Total number, 4, from localities as follows:

Canal Zone: Gatun (type locality), 2.

Panama: Cerro Azul, 1.

Costa Rica: Angostura, 1.

#### SCIURUS VARIEGATOIDES HELVEOLUS, subsp. nov.

*Type* from Corozal, Canal Zone, Panama. No. 171540, male adult, U. S. National Museum (Biological Survey Collection), collected by E. A. Goldman, June 15, 1911. Original number 21166.

*General characters.*—Similar in general to *dorsalis* and *variegatoides*, but limbs and under parts paler in the grizzled-back phase; premolars  $\frac{1}{2}$  (premolars  $\frac{2}{3}$  in *dorsalis*).

*Color.*—Phase with grizzled back: Top of head and back mixed black and pale buff, the mixture producing a grizzled effect; muzzle and sides of head buffy grayish, much paler than top of head; under parts and limbs pale buff, the color richest on outer sides of forearms, along flanks and on lower base of tail, becoming somewhat paler on feet; ears broadly edged with black anteriorly, more narrowly posteriorly, the ear patches pale buff or white, tail above at base like back, rest of upper side black and white, the hairs broadly tipped with the latter color, below varying along median line from pale ochraceous buff to pale cinnamon-rufous, bordered with black and edged with white. *Variation:* One specimen in worn pelage, perhaps representing the black-backed phase seen in *dorsalis*, has the under parts and limbs uniform pale buffy gray, and the top of head and back blackish in patches. The top of head and back are more uniform in color, and the dark dorsal area broader than in typical examples of *dorsalis* in this phase.

*Measurements.*—Type: Total length, 508 mm.; tail vertebrae, 25.5; hind foot, 63. An adult topotype: 540; 274; 67. *Skull* (type): Greatest length, 57.7; condylobasal length, 53; zygomatic breadth, 34.2; nasals, 19.3; interorbital breadth, 21; palatal length, 26.7; maxillary toothrow (small anterior premolar absent), 10.7.

*Remarks.*—The squirrels of the *S. variegatoides* group are very imperfectly known. The group includes several rather localized forms which in color present a remarkably wide range of individual variation. Large series of typical examples are much needed to make clear many doubtful points. The Panama form is doubtless most closely allied to *dorsalis* of northern Costa Rica, but it seems to differ from typical *variegatoides* mainly in the paler color of the under parts in the phase with grizzled back. The three specimens obtained, two adults and one about half-grown, all lack the small upper premolar usually present in the squirrels of this group.

*Specimens examined.*—Three, all from the type locality.

**MICROSCIURUS ALFARI VENUSTULUS, subsp. nov.**

*Type* from Gatun, Canal Zone, Panama. No. 171030, female adult, U. S. National Museum (Biological Survey Collection), collected by E. A. Goldman, March 1, 1911. Original number 20955.

*General characters.*—Closely allied to *alfari*, but general color less rufescent. Similar to *brownii*, but darker above and below; tail edged with orange rufous instead of grayish white; throat more rusty brown.

*Color.*—Upper parts, including outer sides of limbs, brownish black, finely grizzled with cinnamon-rufous, or rusty reddish, the general effect resulting from overlapping of black-tipped hairs with rusty reddish subterminal bands; head, and especially cheeks, clearer cinnamon-rufous than back; under parts, including inner sides of limbs, grayish brown, somewhat irregularly suffused with cinnamon-rufous; ears brownish at tips, clothed on inner base with a partly concealed patch of moderately long cream-buffy hairs; feet dark rusty brownish; tail coarsely grizzled black and cinnamon-rufous, rather broadly edged with the latter color.

*Skull.*—Similar to that of *alfari*, but nasals narrower posteriorly and jugal weaker than in the type of that species.

*Measurements.*—Type: Total length, 250 mm.; tail vertebrae, 102; hind foot, 40. *Skull* (type): Greatest length, 37; condylobasal length, 32.8; zygomatic breadth, 23.2; nasals, 10.5; interorbital breadth, 14; palatal length, 15; maxillary toothrow (small anterior premolar absent), 5.5.

*Remarks.*—The pigmy squirrels typified by *alfari* and usually assigned to the subgenus *Microsciurus* constitute a group that seems to merit full generic recognition under this name. Aside from the subgeneric characters currently recognized the group is charac-



terized by simpler dentition than *Sciurus*; the small cusps intermediate in position between the larger tubercles on the outer side in the large upper molariform teeth in *Sciurus* are absent in *Microsciurus*. The skull of the type of *venustus* lacks the small anterior premolar usually present in *Microsciurus*.

*Specimens examined*.—Total number, 3, from the following localities:

Canal Zone: Gatun, 2.

Panama: Porto Bello, 1.

#### ORYZOMYS IDONEUS, sp. nov.

*Type* from Cerro Azul (altitude 2500 feet), near the headwaters of the Chagres River, Panama. No 171106, female adult U. S. National Museum (Biological Survey Collection), collected by E. A. Goldman, March 26, 1911. Original number 21010.

*General characters*.—A large species of the subgenus *Melanomys*, allied to *columbianus*, but larger, with shorter tail; color more rufescent. Differing from *phaopus* and *chrysomelas* in larger size and decidedly paler color.

*Color*.—Upper parts cinnamon-rufous evenly mixed with black, becoming somewhat paler along flanks; outer sides of limbs dark brownish cinnamon; under parts dark tawny ochraceous, the under color showing through; feet and tail thinly haired, the hairs and epidermis blackish.

*Skull*.—Closely resembling that of *columbianus*, but decidedly larger; sides of frontals more projecting as supraorbital shelves. Differing from those of *phaopus* and *chrysomelas* mainly in decidedly larger size.

*Measurements*.—Type: Total length, 218 mm.; tail vertebræ, 88; hind foot, 30. *Skull* (type): Greatest length, 31.5; condylobasal length, 29.5; zygomatic breadth, 17.5; nasals, 12.5; interorbital breadth, 6.5; interparietal, 8.7 x 2.5; incisive foramina, 4.8; length of palatal bridge, 6.5; maxillary toothrow, 4.8.

*Remarks*.—A single specimen of this rice rat was taken in the humid forest on Cerro Azul. The group to which it belongs bears a marked external resemblance to some species of *Akodon*, and this fact probably led to the publication of *Akodon columbianus* Allen (= *Oryzomys columbianus*). *O. columbianus* is closely allied to *O. phaopus* and *O. chrysomelas*, and these forms, perhaps along with the one described above, may prove to be intergrading geographic races all assignable to a single widely ranging species.

**ORYZOMYS FRONTALIS, sp. nov.**

*Type* from Corozal, Canal Zone, Panama. No. 171531, female adult, U. S. National Museum (Biological Survey Collection), collected by E. A. Goldman, June 20, 1911. Original number 21172.

*General characters*.—Similar to *O. flavicans*, but decidedly larger; color darker; supraorbital ridges projecting farther over orbits.

*Color*.—Upper parts between cinnamon-rufous and orange-rufous, darkened on head by more abundant admixed dusky hairs, becoming paler and duller along sides; under parts, including lips and inner sides of limbs white; ears and fore feet brownish; hind feet dull white; tail dusky all round.

*Skull*.—In general form closely resembling that of *flavicans*, but much larger; supraorbital ridges more developed, the edges less upturned and shelving farther over orbits.

*Measurements*.—Type: Total length, 309 mm.; tail vertebræ, 161; hind foot, 30. *Skull* (type): Greatest length, 35.5; condylobasal length, 33; zygomatic breadth, 18; nasals, 12; interorbital breadth, 6.7; interparietal, 10.2 x 5; incisive foramina, 6; length of palatal bridge, 6.7; maxillary toothrow, 5.

*Remarks*.—The type and only specimen obtained of this large species shows that the animal is clearly a member of the *flavicans* group. It may be not very unlike *O. tectus* Thomas, of Bogava, Chiriqui, which is said to have remarkably expanded supraorbital ridges, but the latter is described as having fulvous upper lips and buffy under parts and feet. The species requires no close comparison with *O. flavicans illectus* which is more orange buffy in color, and has a different skull—the zygomata much less squarely spreading anteriorly, and supraorbital ridges less developed. *O. panamensis* was described from very near the same locality, but was placed in the *laticeps* group.

**ORYZOMYS BOMBYCINUS, sp. nov.**

*Type* from Cerro Azul (altitude 2500 feet), near the headwaters of the Chagres River, Panama. No. 171105, male adult, U. S. National Museum (Biological Survey Collection), collected by E. A. Goldman, March 26, 1911. Original number 21009.

*General characters*.—Similar in color to *carrikeri*, but pelage much longer, and skull more slender. Somewhat like *talamancæ*, but color much darker, and pelage longer and softer; skull with more slender rostrum, and differing in other details.

*Color*.—Upper parts varying from vandyke brown to mars brown of Ridgway, shaded with black along median line of dorsum, and becoming somewhat paler along sides; face blackish; outer sides of limbs dark brown; under parts dull white, the plumbeous basal color of fur showing through; feet thinly haired, rather dark flesh-colored; tail brownish above, grayish below.

*Skull*.—Similar in general to that of *talamanca*, but rostrum more slender; parietals bounded laterally by temporal ridges, instead of extending across them and encroaching on squamosals as in *talamanca*; frontal region more depressed near posterior ends of nasals.

*Measurements*.—Type: Total length, 252 mm.; tail vertebrae, 127; hind foot, 32. *Skull* (type): Greatest length, 31.3; condylobasal length, 28.8; zygomatic breadth, 15.4; nasals, 12.2; interorbital breadth, 5.5; interparietal, 8.8 x 4; incisive foramina, 5; length of palatal bridge, 6.2; maxillary toothrow, 4.7.

*Remarks*.—This rice rat is a dark-colored, long-haired mountain member of the widely ranging *laticeps* group, which includes a number of forms in northern South America, and reaches northward as a group, through Middle America to Mexico. *Oryzomys bambicinus* is remarkable for the length and softness of its pelage.

*Specimens examined*.—Total number, 4, from localities in Panama, as follows: Cerro Azul (type locality), 3; Cerro Brujo, 1.

#### ORYZOMYS GATUNENSIS, sp. nov.

*Type* from Gatun, Canal Zone, Panama. No. 171034, male young, U. S. National Museum (Biological Survey Collection), collected by E. A. Goldman, March 7, 1911. Original number 20967.

*General characters*.—Allied to *richmondi*; color paler; skull decidedly broader between orbits, the sides of frontals more projecting, interparietal smaller.

*Color*.—Upper parts between raw umber and tawny olive of Ridgway, mixed with black, the general color becoming brownish on the face and somewhat buffy along flanks; under parts dark pinkish buff, the plumbeous basal color of fur showing through; feet thinly haired, flesh colored; tail grayish brown above, lighter below.

*Skull*.—Similar in general to that of *richmondi*, but frontal region broader, the lateral margins more developed as supraorbital shelves; interparietal much less extended antero-posteriorly; nasals more

prolonged posteriorly beyond premaxillæ: dentition about as in *richmondi*.

*Measurements*.—Type: Total length, 224 mm.; tail vertebræ, 115; hind foot, 31.5; *Skull* (type): Greatest length, 27.7; condylobasal length, 24.8; zygomatic breadth, 14.5; nasals, 10.2; interorbital breadth, 5.3; interparietal,  $7.3 \times 1.5$ ; incisive foramina, 5.6; length of palatal bridge, 5.2; maxillary toothrow, 5.

*Remarks*.—This species seems to require comparison only with *richmondi*. It is represented by a single specimen taken in an abandoned sugar plantation on the bank of the Chagres River.

**ZYGODONTOMYS CHERRIEI VENTRIOSUS, subsp. nov.**

*Type* from Tabernilla, Canal Zone, Panama. No. 171098, male adult, U. S. National Museum (Biological Survey Collection), collected by E. A. Goldman, March 12, 1911. Original number 20975.

*General characters*.—Similar to *cherriei*, but larger; general color paler and grayer, the back more uniform, less distinctly darkened along median line.

*Color*.—Upper parts grayish brown, darkest and more or less suffused with yellowish, or light rusty brown, on median dorsal area, becoming paler and grayer along flanks and outer sides of limbs; under parts dull creamy white, or gray, the fur short, and the plumbeous basal color showing through; ears brownish, overlapped at anterior base by rather long rusty hairs; feet white; tail nearly naked, grayish above, whitish below.

*Skull*.—About like that of *cherriei*, but larger.

*Measurements*.—Type: Total length, 240 mm.; tail vertebræ, 104; hind foot, 28. Average of ten adult topotypes: 236 (220-255); 102 (94-109); 27.3 (26.5-28). *Skull* (average of four adults): Greatest length, 31.7 (30.5-32.5); condylobasal length, 29.6 (28.5-31); zygomatic breadth, 16.4 (16-17.2); nasals, 12.2 (11.2-13.5); interorbital breadth, 5 (5-5.2); interparietal,  $7.7 \times 3$  ( $6.3 \times 3.9 \times 3.5$ ); incisive foramina, 6.7 (6.2-7); length of palatal bridge, 5.5 (5.5-5.5); maxillary toothrow, 4.6 (4.5-4.8).

*Remarks*.—This form, representing the genus *Zygodontomys* in the Canal Zone, seems to be the most abundant murine rodent in the grassy clearings and second growth jungle of the region. It was not obtained in the heavy forest.

*Specimens examined*.—Total number, 23, from the following localities in the Canal Zone: Tabernilla (type locality), 15; Gatun, 8.

**HETEROMYS PANAMENSIS, sp. nov.**

*Type* from Cerro Azul (altitude 2800 feet), near the headwaters of the Chagres River, Panama. No. 171107, male adult, U. S. National Museum (Biological Survey Collection), collected by E. A. Goldman, March 23, 1911. Original number 20999.

*General characters*.—Allied to *repens*, but color still darker: fore feet blackish, instead of white, to near base of toes; ankles dusky all round; an ochraceous buffy lateral line sometimes present; sole of hind foot naked, six-tuberculate.

*Color*.—Ground color of upper parts blackish, nearly clear black on lower part of rump and outer sides of hind legs, becoming slaty grayish along flanks and outer sides of fore legs, the slender ochraceous buffy hairs abundant and producing a grizzled effect; ochraceous buff lateral line present in some specimens, absent in others; under parts white, sometimes suffused with pale buff; fore feet slaty grayish to near base of toes; ankles and proximal third of metatarsus dusky all round; distal two-thirds of metatarsus, and toes of fore and hind feet, whitish; tail varying from blackish above and whitish below to dark nearly unicolor all round.

*Skull*.—Similar to that of *repens*, but rostrum broadening more abruptly to zygomata; interparietal broader; lateral wings of supra-occipital narrower, less developed over mastoids.

*Measurements*.—Type: Total length, 283 mm.; tail vertebræ, 148; hind foot, 35. *Skull* (type): Greatest length, 35.5; zygomatic breadth, 17.1; interorbital breadth, 9.4; nasals, 14.4; width of braincase, 15.2; interparietal, 10 x 5.5; maxillary toothrow, 5.2.

*Remarks*.—On the mountains near the headwaters of the Chagres River this very dark spiny pocket mouse was found inhabiting the forests from 2000 feet upward to the summit at about 3000 feet altitude. The same species was also obtained at about 2000 feet altitude on Cerro Brujo, near the north coast. It is more nearly related to *repens* of Chiriqui, than to *zonalis*, a near geographic neighbor of the lowlands in the Canal Zone.

*Specimens Examined*.—Six, all from Panama, as follows: Cerro Azul (type locality), 5; Cerro Brujo, 1.

**HETEROMYS ZONALIS, sp. nov.**

*Type* from Rio Indio (near Gatun), Canal Zone, Panama. No. 170976, female adult, U. S. National Museum (Biological Survey Collection), collected by E. A. Goldman, February 15, 1911. Original number 20885.

*General characters.*—Size about as in *desmarestianus*, but color darker, the slender hairs paler and less conspicuous among the bristles over dorsum; lateral line absent; white of under parts continuous along inner side of hind leg to foot; skull massive; maxillary root of zygomatic broad and heavy; interparietal rather narrow, with a well-developed anterior angle, and a small posterior median notch.

*Color.*—Upper parts blackish, becoming dark mouse gray along flanks and outer sides of limbs, the slender hairs inconspicuous among the black-tipped bristles; under parts, feet, and a line down inner side of hind leg to metatarsus, white; tail blackish or brownish above, whitish below, except at base where it is dark all round as usual in the group.

*Skull.*—Similar to that of *desmarestianus*, but interparietal with a more prominent anterior angle, and a posterior median notch (the latter absent in *desmarestianus*); parietals less extended laterally across temporal ridges; dentition about the same.

*Measurements.*—Type: Total length, 263 mm.; tail vertebrae, 134; hind foot, 35. *Skull* (type): Greatest length, 37; zygomatic breadth, 17; interorbital breadth, 10; nasals, 15.2; width of braincase, 15.2; interparietal, 8.2 x 5; maxillary toothrow, 5.5.

*Remarks.*—Although so widely separated geographically this species seems more like typical *desmarestianus* of Guatemala than like its near neighbors in Panama. It lives at low elevations on rocky heavily forested hills in the northern end of the Canal Zone.

*Specimens examined.*—Four, all from the vicinity of the type locality.

#### HOPLOMYS GOETHALSI,<sup>1</sup> sp. nov.

*Type* from Rio Indio, near Gatun, Canal Zone, Panama. No. 170972, young female, U. S. National Museum (Biological Survey Collection), collected by E. A. Goldman, February 16, 1911. Original number 20888.

*General characters.*—In size and color similar to *truei* and *gymnurus*; skull with heavier zygomatica than either, the jugal decidedly broader, with inferior border projecting posteriorly in a well defined hook (absent in *truei* and *gymnurus*).

<sup>1</sup> Named in honor of Col. George W. Goethals, U. S. Army, Chairman and Chief Engineer of the Isthmian Canal Commission, whose courtesy and assistance have contributed so much to the success of the Smithsonian Biological Survey of the Panama Canal Zone.

*Color*.—Ground color of upper parts cinnamon-rufous, darkened on top of head and along median line of neck by slender bristles which are replaced from near shoulders to rump by stout, anteriorly-grooved, black-tipped spines projecting beyond and overlying the finer hairs; cheeks and outer sides of fore limbs grayish brown, the cheeks in a fully adult example suffused with cinnamon-rufous; outer sides of hind limbs blackish; under parts white, interrupted in some specimens by a more or less complete pectoral band; nose and sides of muzzle blackish; ankles dark all round; inner side of metatarsus and three inner digits whitish, outer side and two outer digits brownish; tail blackish above, whitish below.

*Skull*.—General form resembling that of *truci*, but jugal more extended vertically, the inferior border more produced anteriorly, reaching nearer to antorbital foramen, and more prolonged posteriorly to form a distinct hook. Similar to *gymnurus*, but parietals more developed below temporal ridges; squamosal reaching farther along lateral ridges near frontoparietal suture; audital bullæ larger; zygomata differing in about the same characters as from *truci*; dentition the same as in the type species of the genus.

*Measurements*.—Type: Total length, 391 mm.; tail vertebrae, 153; hind foot, 54. An old male topotype: 529; 244; 62.5. *Skull* (type): Condylbasal length, 51.6; zygomatic breadth, 29.2; inter-orbital breadth, 13; palatal length, 20; length of palatal bridge, 11.8; width of jugal near middle, 3.8; maxillary toothrow, 9.3.

*Remarks*.—The Isthmian representative of this genus agrees closely with *truci* and *gymnurus* in color and remarkably stout spiny armature, but is readily distinguished by the cranial characters pointed out. The posterior prolongation of the lower border of the jugal to form a process or hook is a character present also in some species of *Præchimys*, and absent in others.

*Specimens examined*.—Three, from the type locality.









SMITHSONIAN MISCELLANEOUS COLLECTIONS

VOLUME 56. NUMBER 37

DESCRIPTIONS OF TWO NEW SPECIES OF  
NUN BIRDS FROM PANAMA

BY

E. W. NELSON



(PUBLICATION 2074)

CITY OF WASHINGTON  
PUBLISHED BY THE SMITHSONIAN INSTITUTION  
FEBRUARY 16, 1912

The Lord Baltimore Press  
BALTIMORE, MD., U. S. A.

DESCRIPTIONS OF TWO NEW SPECIES OF NUN  
BIRDS FROM PANAMA<sup>1</sup>

By E. W. NELSON

Two new species of *Monasa* are among the interesting birds collected by E. A. Goldman while working on the Smithsonian Biological Survey of Panama during the winter of 1911. They were collected at the same locality on the base of Cerro Azul, north-west from Chepo, and only a single specimen of each was obtained. No others were seen during the entire season in the Canal Zone and adjacent territory. I wish to express my obligation to Mr. Robert Ridgway, Curator of Birds, U. S. National Museum for his aid in the determination of the status of the species described here.

**MONASA FIDELIS**, new species

Goldman's Nun Bird

Type No. 207666, adult male, U. S. National Museum, Biological Survey Collection; collected on Cerro Azul, Panama (altitude 800 feet), March 21, 1911, by E. A. Goldman (original number 14127).

*Distribution*.—Known from type locality only.

*Specific characters*.—Much like *grandior* of Costa Rica, but anterior point of feathered malar area white as in *morphaus* from eastern Brazil, and black of head and neck extending farther back, and more abruptly defined posteriorly, reaching front of back above and middle of breast below; wing coverts paler gray than in *grandior* but much darker than in *pallescens*.

*Measurements*.—Wing, 134; tail, 115; tarsus, 21; culmen, 41.

**MONASA SIMILIS**, new species

Cerro Azul Nun Bird

Type No. 207665, adult female, U. S. National Museum, Biological Survey Collection; collected on Cerro Azul, Panama (altitude 800 feet) March 24, 1911, by E. A. Goldman (original number 14180).

*Distribution*.—Known from type locality only.

<sup>1</sup>This paper is the seventh dealing with the results of the Smithsonian Biological Survey of the Panama Canal Zone.

*Specific characters.*—In general coloration very similar to *M. fidelis* from the same locality but immediately distinguishable by absence of white on chin, this color being confined to a band about base of upper mandible extending to lores as in *pallescens*; black of head and neck extends over entire neck and on fore part of back and over most of breast; posterior border of black not sharply defined as in *fidelis* but shading into the slaty color of body; color of wings, tail and rest of body the same in both these species.

*Measurements.*—Wing, 138 mm.; tail, 120; tarsus, 22; culmen, 42.5.









SMITHSONIAN INSTITUTION LIBRARIES



3 9088 01421 4472