

PLANNING FOR PROFIT
SOILS
AND SOIL
MANAGEMENT



FRANK D. GARDNER



Class S591

Book .G23

Copyright N^o _____

COPYRIGHT DEPOSIT

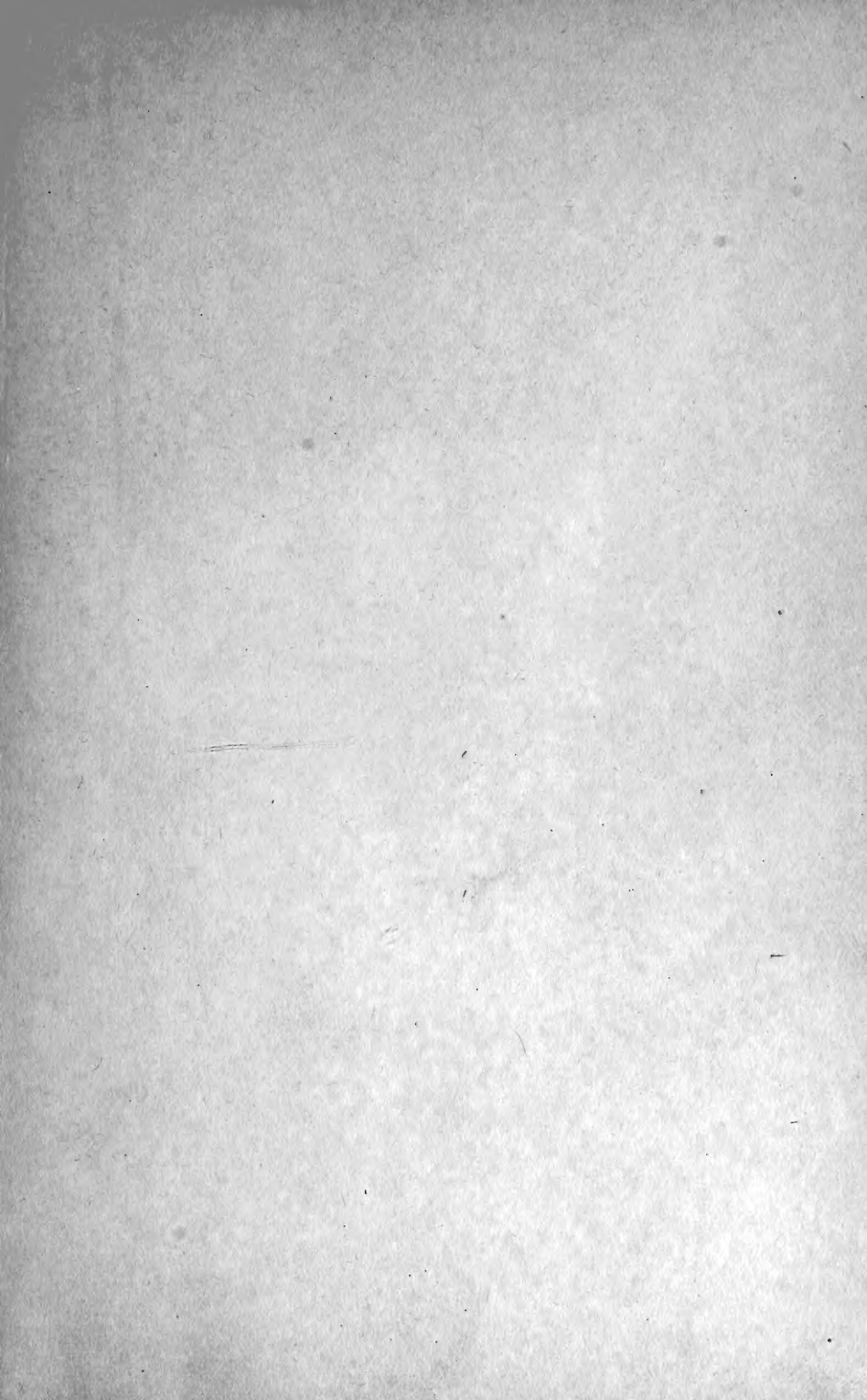

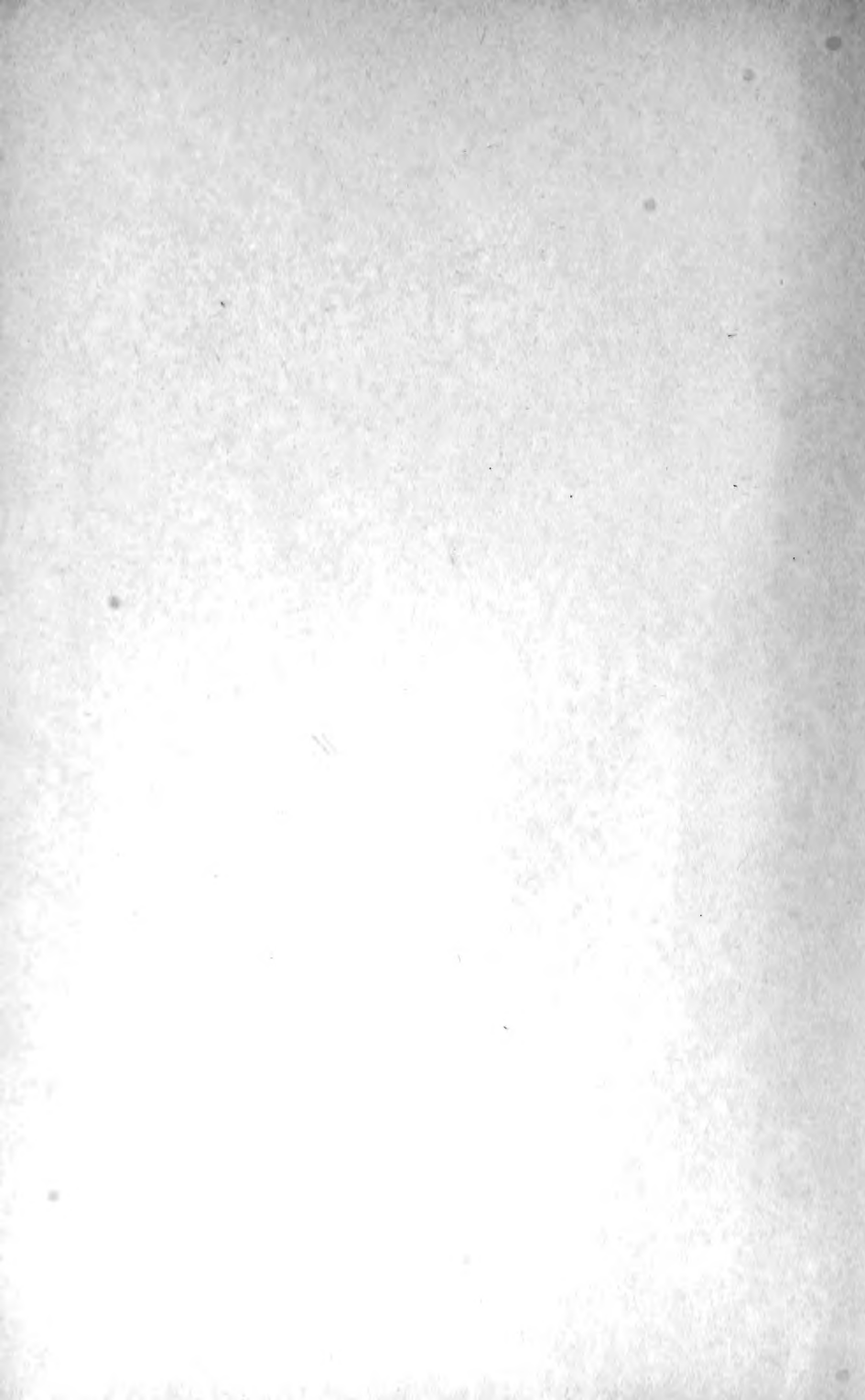

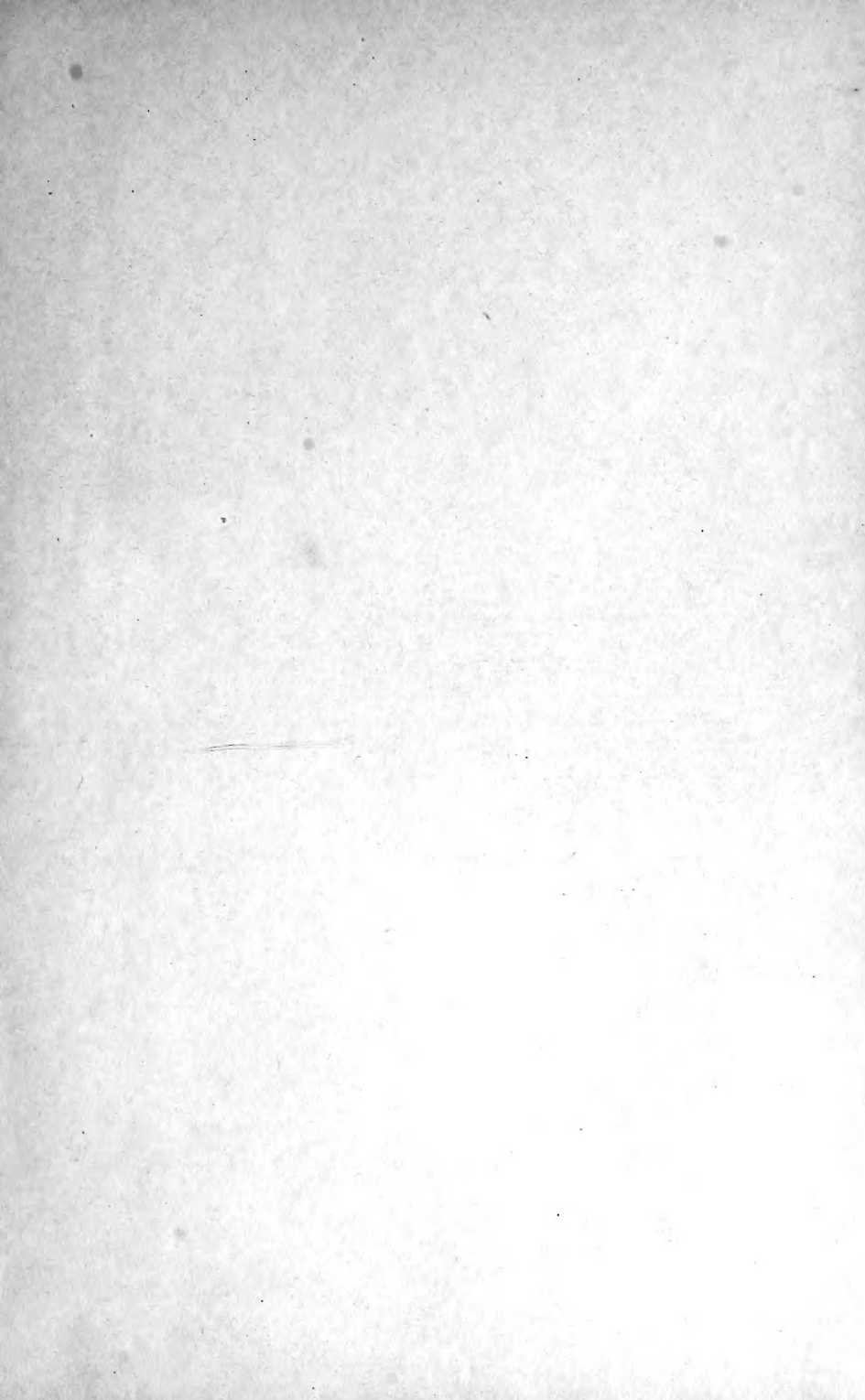







PLAN FOR A FARMSTEAD.

1—Residence, 2—Poultry-house, 3—Milk-house, 4—Silo, 5—Dairy-barn,
 6—Horse-barn, 7—Storage for crops, 8—Farm machinery, 9—Shop and garage,
 10—Corn crib, Orchard on left, garden to right.

FARMING FOR PROFIT

SOILS AND SOIL CULTIVATION

A NON-TECHNICAL MANUAL ON THE
MANAGEMENT OF SOIL FOR THE PRODUCTION
AND MAINTENANCE OF FERTILITY

BY

FRANK D. GARDNER

PROFESSOR OF AGRONOMY, PENNSYLVANIA STATE COLLEGE
AND EXPERIMENT STATION

ASSISTED BY

R. U. BLASINGAME

*Professor of Agricultural Engineering
Alabama Polytechnic Institute*



ILLUSTRATED

THE JOHN C. WINSTON COMPANY
PHILADELPHIA

CHICAGO

S 591
. G 23

Copyright, 1918, by
THE JOHN C. WINSTON COMPANY ✓

Copyright, 1916, by
L. T. MYERS



APR 19 1919

©CLA 515288 R

No. 1.

PREFACE

This book is written for amateur as well as professional farmers and will also be of interest to students of agriculture and prospective farmers. It makes a popular appeal to all men engaged in farming and is designed to be a handy reference work on soils, their classification and treatment and the proper adaptation of crops with a view to preserving and increasing the fertility of the soil and producing the largest and best yield in point of quality.

Ages of farm experience and a few generations of agricultural research have given us a vast store of practical knowledge on tilling the soil and raising crops. This knowledge is scattered through many different volumes on different phases of the subject, in experiment station bulletins, agricultural journals and encyclopedias. The important facts on which the most successful farming is based are here brought together in orderly and readable form. Not only are directions given for the management of the soil but the best types of farm buildings and equipment are fully described and illustrated, including farm machinery of the latest type, farm sanitation, drainage and irrigation.

The subject-matter is arranged in two parts of a number of chapters each, and by referring to the Table of Contents any subject may be quickly found. References are freely given at the close of each chapter. Each chapter has been prepared by a specialist in the subject presented. The name of the author appears at the beginning of each chapter. Those unacknowledged have been prepared by myself.

The illustrations have been secured from many sources. Due credit has been given these.

Special acknowledgment is due the publishers of this volume and the other volumes in the series for their conception, and for many helpful suggestions in the presentation of its subject-matter.

Acknowledgment is also due Professor E. L. Worthen and Professor R. S. Smith, both of The Pennsylvania State College, for helpful suggestions and criticisms on soils and crop rotations. I wish also to especially acknowledge the valuable editorial assistance of my wife in the preparation of the manuscript.

FRANK D. GARDNER.



CONTENTS

PART I. SOILS AND SOIL MANAGEMENT

- Chapter 1. SOIL CLASSIFICATION AND CROP ADAPTATION..... 15**
Soils are permanent—What farmers should know—The science of the soil—How soils are formed—Weathering and disintegration—Decomposition—What is the soil—The soil solids—The soil fluid—Gases of the soil—Soil classification—Soil surveys—Soils of the United States—Classification by texture—Crop adaptation—Summary of soil adaptedness—Eastern soils not worn out—Soil adaptation of sixteen crops common to Northeastern States—Soil adaptation of the leading crops of the North Central Region, South Central and South Atlantic Coast Region, Plains and Mountain Region, Pacific Coast Region—Aids to the solution of soil problems.
- Chapter 2. PHYSICAL, CHEMICAL AND BIOLOGICAL PROPERTIES..... 33**
Texture of soil—Water-holding capacity of soils—Water movement in soil—Absorption of fertilizers—Plasticity and ease of cultivation—Texture affects crop adaptation—Texture affects tillage—Structure of the soil—Granular structure—Granulation improved by organic matter—Good tilth important—Solubility of soil minerals—Rate of solubility depends on texture and kind of minerals—Soil bacteria increase solubility—Rapid solubility results in loss of fertility—Chemical composition of soils—Availability important—Elements essential to plants—Soil bacteria—Bacteria make plant food available—Nitrogen increased by bacteria—Bacteria abundant near surface.
- Chapter 3. FERTILITY AND HOW TO MAINTAIN..... 44**
Fertility defined—Vegetation an index to fertility—Drainage reflected in character of vegetation—Lime content and acidity related to plants—Vegetation and alkali—Color of soil related to fertility—Maintenance of fertility—Fertility lost by plant removal—Loss by erosion—Preventing soil erosion—Farming systems that maintain fertility—Deep plowing advisable—Tillage is manure—Rotations are helpful—Rotations reduce diseases—Cover crops prevent loss of fertility—Legumes increase soil nitrogen—Drainage increases fertility—Manure is the best fertilizer—Commercial fertilizers add plant food only—The limiting factor—Fertility an economic problem.
- Chapter 4. COMMERCIAL FERTILIZERS..... 54**
Object and use of commercial fertilizers—What are commercial fertilizers—Where are fertilizers secured—Carriers of nitrogen—Phosphorus—Potassium—Forms of fertilizer materials—Relative value of fertilizer ingredients—The composition of fertilizers—What analyses of fertilizers show—Commercial *vs.* agricultural value of manures—Mechanical condition—High-grade *vs.* low-grade fertilizers—Use of fertilizers—Value of crop determines rate of fertilization—Valuable products justify heavy fertilization—Character of fertilizer related to soil—What the farmer should know—How to determine needs of soil—Effect modified by soil and crop—Which is the best fertilizer to use—Needs of different soils—Crop requirements—Fertilizers for cereals and grasses—Legumes require no nitrogen—Available forms best for roots—Slow-acting fertilizers suited to orchards and small fruits—Nitrogen needed for vegetables—Fertilizers for cotton—Miscellaneous fertilizer facts—Effect of fertilizers on proportion of straw to grain—Principles governing profitable use of fertilizers—When to apply fertilizers—Methods of application—Purchase of fertilizers—Home mixing of fertilizers.

- Chapter 5. BARNYARD, STABLE AND GREEN MANURES.**..... 76
 Manure an important farm asset—As a source of plant food—Physical effect of manures—Biological effect of manure—The value of manure—Horse manure—Cattle manure—Hog manure—Sheep manure—Poultry manure—Miscellaneous farm manures—Value of manure influenced by quality of feed—Amount and character of bedding affects value of manure—Methods of storing and handling—Losses of manure—Experimental results—How to prevent loss—Absorbents *vs.* cisterns—Sterilization—Reinforcing of manures—Economical use of manure—To what crops should manure be applied—To what soils should manure be applied—Climate affects decomposition—Eroded soils most in need of manure—Rate of application—Methods of applying manure—Top dressing *vs.* plowing under—The parking system—Distribution of benefits.

Green Manures.

When is green manuring advisable—Objections to green manuring—Principal green-manuring crops.

- Chapter 6. LIME AND OTHER SOIL AMENDMENTS.**..... 97
 Soils need lime—Lime content of soils—How soils lose lime—Lime requirements of soils—Crops require lime—Tolerance to acidity—Lime as affecting growth of plants—Sources of lime—Forms of lime.

Functions of Lime.

Lime as plant food—Chemical action of lime—Physical effect of lime—Lime affects soil bacteria—Lime corrects soil acidity—Sanitary effect of lime—Injurious effect of lime—Rate of application—Time of applying—Frequency of application—Methods of applying—Relative values of different forms of lime—Mixing with manure and fertilizers—Experimental results—Spreading lime—Slaking lime—Crushing *vs.* burning lime.

- Chapter 7. SOIL WATER, ITS FUNCTIONS AND CONTROL.**..... 112
 Amount and distribution of rain—Amount of water necessary to produce crops—Transpiration by plants—Forms of soil water—Capillary water—Gravitational water—Hygroscopic water—Water affects temperature of soil—Water storage capacity of soils—Moisture conservation—Removing excess of water.

Land Drainage.

Drainage increases warmth and fertility of soil—Improves health conditions—Open *vs.* underground drains—Quality of tile—Cost of tile and excavating—Depth and frequency of drains—Grades, silt basins and junctions—The outlet—Size of tile.

- Chapter 8. GENERAL METHODS OF SOIL MANAGEMENT.**..... 124
 Objects of tillage—Plowing—Time of plowing—Depth of plowing—Subsoiling—Disking—Harrowing—Planking or dragging—Rolling—Character of seed-bed—Cultivation and hoeing—Control of weeds—Soil mulches—Soil erosion—Soil injury—Time and intensity of tillage are economic factors.

PART II. FARM BUILDINGS AND EQUIPMENT

- Chapter 9. FARM BUILDINGS, FENCES AND GATES.**..... 139
 The Farm Residence.

Barns.

Bank barns—Dairy barns—Storage capacity—Floor space and arrangement—Stable floors—Lighting—Ventilation—Conveniences—Silos.

Out Buildings.

The implement house—Corn cribs—Hog houses—Poultry houses—Milk houses—Ice houses—Roofing—Use of concrete—Lightning rods—Fences and gates.

- Chapter 10. FARM MACHINERY AND IMPLEMENTS.**..... 161
 Advantages of farm machinery—Tillage machinery—Cultivators—Seeding machines—Corn planters.

Harvesting Machinery.

Mowing machines—Self-rake reaper—Self-binder—Corn harvesters—Threshing machines—Corn shellers—Silage cutters—Manure spreader—Milking machines—Spraying machines—Tractors—Farm vehicles—Hand implements—Tools—Handy conveniences—Machinery for the house—Buying farm machinery—Care of machinery—Condition of machinery—Utilizing machinery—Cost of farm machinery—Duty of farm machinery.

Chapter 11. ENGINES, MOTORS AND TRACTORS FOR THE FARM..... 189

The Real Power for the Farm.

Gas engine principles—Vertical and horizontal engines—Ignition—Cooling system—Lubrication—Gas engine parts—Governors—Gas engine troubles.

Transmission of Power.

Shafting—Speed of shafting—The size of pulleys—Kind of pulleys—Straight and crown faces—Covering steel pulleys—Pulley fasteners.

Belts and Belting.

Advantages of belts—Disadvantages—Essentials of a belt—Leather belts—Rubber belts—Belt slipping.

Water Motors.

Overshot wheels—Undershot wheels—Breast wheels—Impulse water motors—Turbine wheels—The hydraulic ram.

The Farm Tractor.

The size of tractors—Tractor efficiency—Type of tractor.

Chapter 12. FARM SANITATION..... 204

Lighting.

Kerosene lamps—Gasoline lamps—Acetylene gas—Electrical lighting. Heating—Ventilation—Water supply—Sewage disposal.

Chapter 13. FARM DRAINAGE AND IRRIGATION..... 211

Land Drainage.

Co-operation—Tile drains—Running the levels—Establishing the grades—Small ditching machines—Size of tile.

Irrigation.

Water rights—Co-operation—Sources of water—Dams and reservoirs—Methods of transmission—Losses in transmission—Head gates—Preparing land for irrigation—Farm ditches—Distributaries—Distributing the water—The check system—Duty of water—When to irrigate—Irrigation waters—Alkali troubles.

LIST OF ILLUSTRATIONS

	PAGE
PLAN FOR A FARMSTEAD (<i>Color Plate</i>).....	<i>Frontispiece</i>
ROCK WEATHERING AND THE PROCESS OF SOIL FORMATION.....	16
THE SOIL PROVINCES AND SOIL REGIONS OF THE UNITED STATES (<i>Color Map</i>)..	20
THE SOIL SEPARATES AS MADE BY MECHANICAL ANALYSIS.....	21
INSPECTING AND SAMPLING THE SOIL.....	22
A SOIL AUGER.....	32
RATE AND HEIGHT OF CAPILLARY RISE OF WATER IN SOILS OF DIFFERENT TEXTURE	34
THE EASE OF SEED-BED PREPARATION DEPENDS ON CONDITION OF SOIL.....	37
SOIL FERTILITY BARREL.....	50
SOIL FERTILITY PLATS.....	52
EFFECT OF TOP DRESSING MEADOWS WITH COMMERCIAL FERTILIZER.....	64
EFFECT OF FERTILIZERS ON THE GROWTH OF SWEET CLOVER.....	65
EFFECT OF COMMERCIAL FERTILIZER ON WHEAT ON A POOR SOIL.....	67
SOIL FERTILITY PLATS.....	70
MODERN CONVENIENCE FOR CONVEYING MANURE.....	83
PILES OF MANURE STORED UNDER EAVES OF BARN.....	85
SPREADING MANURE FROM WAGON, OLD WAY.....	88
THE MODERN MANURE SPREADER.....	92
RYE TURNED UNDER FOR SOIL IMPROVEMENT.....	95
THE GROWTH OF RED CLOVER ON AN ACID SOIL AS AFFECTED BY LIME.....	99
BEETS GROWN WITH AND WITHOUT LIME.....	101
THE OLD WAY OF SPREADING LIME.....	107
A MODERN LIME SPREADER IN OPERATION.....	108
A LIME CRUSHING OUTFIT SUITABLE FOR THE FARMER.....	109
DETAILS OF CONSTRUCTION OF A FARM LIMEKILN.....	110
MAP SHOWING MEAN ANNUAL RAINFALL FOR ALL PARTS OF THE UNITED STATES	112
EFFECT OF LITTLE, MEDIUM, AND MUCH WATER ON WHEAT.....	115
ORCHARD WELL CULTIVATED TO PREVENT EVAPORATION.....	118
WATER ISSUING FROM AN UNDERGROUND DRAIN.....	122
A DEEP TILLING DOUBLE-DISK PLOW.....	125
A BADLY ERODED FIELD.....	127
DETAILS OF A GOOD SEED BED.....	130
TERRACING AS A MEANS OF PREVENTING EROSION.....	132
ANOTHER WAY TO STOP EROSION.....	133
AN ATTRACTIVE FARM HOUSE.....	140
PLANS OF A FARM HOUSE.....	141
A GOOD TYPE OF BARN.....	142
INTERIOR OF A COW STABLE.....	143
ECONOMICAL AND PRACTICAL MANURE SHED.....	144
PLANS FOR A CIRCULAR BARN.....	145
CROSS-SECTION SHOWING VENTILATION AND STABLE FLOOR OF CONCRETE.....	146
ENSILAGE CUTTER AND FILLER.....	147
A GOOD IMPLEMENT SHED.....	149
PLAN OF CONCRETE FOUNDATION OF CORN CRIB.....	150
INTERIOR OF DOUBLE CORN CRIB.....	151
TWO VIEWS OF IOWA GABLE ROOF HOG HOUSE.....	153
A CONCRETE BLOCK ICE HOUSE.....	154
HOW TO CONSTRUCT A CONCRETE WATER TANK.....	155
A "T" CONNECTION FOR HEAVY WIRE LIGHTNING RODS.....	156
A GOOD TYPE OF FARM FENCE.....	159
A GOOD TYPE OF WALKING PLOW.....	161

	PAGE
ONE TYPE OF SULKY PLOW.....	162
AN ADJUSTABLE SMOOTHING HARROW.....	163
SPRING TOOTHED HARROW.....	163
DOUBLE DISK HARROW.....	164
A CORRUGATED ROLLER.....	165
A HOME-MADE PLANKER.....	166
A MUCH USED FORM OF CORN CULTIVATOR.....	167
A WHEELBARROW SEEDER IN OPERATION.....	168
THE USUAL TYPE OF GRAIN DRILL WITH SINGLE DISK FURROW OPENERS.....	169
A GOOD CORN PLANTER.....	170
CORN HARVESTER WITH BUNDLE ELEVATOR.....	172
A MOWING MACHINE WITH PEA VINE ATTACHMENT.....	173
AN UP-TO-DATE THRESHING MACHINE.....	175
FOUR-HOLE MOUNTED BELT CORN SHELLER WITH RIGHT ANGLE BELT ATTACHMENT.....	176
MILKING MACHINE IN OPERATION.....	178
A POWER SPRAYER ROUTING ORCHARD PESTS.....	179
A COLLECTION OF USEFUL HAND IMPLEMENTS.....	180
INTERIOR OF A WORKSHOP WITH A \$25 OUTFIT OF TOOLS.....	181
HOME-MADE BARREL CART FOR HAULING LIQUID FEED.....	182
HOME-MADE DUMP CART TO MAKE STABLE WORK EASIER.....	183
A WASHING MACHINE SAVES MUCH HARD WORK FOR THE HOUSEWIFE.....	184
WHERE DO YOU PREFER TO KEEP YOUR IMPLEMENTS? UNDER THE SKY? ..	185
SECTIONAL VIEW OF A FOUR-CYCLE VERTICAL GAS ENGINE	188
SECTIONAL VIEW OF A TWO-CYCLE ENGINE.....	190
SECTIONAL VIEW OF A FOUR-CYCLE HORIZONTAL GAS ENGINE.....	191
THREE H. P. GAS ENGINE OPERATING BINDER.....	193
ENGINE OPERATING PUMP JACK.....	195
PELTON WATER WHEEL.....	199
TURBINE WATER WHEEL.....	199
THREE-PLOW TRACTOR IN OPERATION	200
HACKNEY AUTO-PLOW.....	201
PLOWING ON A LARGE SCALE (<i>Color Plate</i>).....	202
CREEPING GRIP TRACTOR.....	202
MOR-LITE ELECTRIC PLANT.....	204
ELECTRIC LIGHTING PLANT FOR FARM HOUSE.....	205
MODIFIED KING SYSTEM OF VENTILATION.....	206
A PNEUMATIC WATER TANK.....	207
FAIRBANKS-MORSE WATER SYSTEM FOR FARMS AND SUBURBAN HOMES.....	208
THE KAUSTINE CLOSET.....	209
GRADING THE DITCH AND LAYING TILE.....	212
A LOW PRICED TILE DITCHER	213
THE DITCHER IN OPERATION.....	214
DELIVERY GATE TO FARM LATERAL.....	218
THE V-CROWDER IS EXCELLENT FOR MAKING THE FARM DITCHES.....	218
CANVAS DAM TO CHECK WATER.....	219
ORCHARD IRRIGATION BY FURROW METHOD.....	220
CELERY UNDER IRRIGATION, SKINNER SYSTEM.....	221

PART I
SOILS AND SOIL MANAGEMENT



CHAPTER 1

SOIL CLASSIFICATION AND CROP ADAPTATION

The thin layer of the earth's surface known as the "soil and subsoil" supports all vegetation and makes it possible for the earth to sustain a highly developed life. The prosperity and degree of civilization of a people depend in a large measure on the productivity and utilization of this thin surface layer of the earth's crust. From it come the food supply and the materials for clothing and to a considerable extent the materials for housing of mankind.

Soils are Permanent.—The soil is indestructible, and according to the great laws of nature, it should be capable of supporting generation after generation of men each living on a slightly higher plane than the preceding. This necessitates a system of agriculture that is permanent, and one that will foster and maintain the productivity of the soil. Each man who owns and cultivates land owes it to his fellow-men to so cultivate and fertilize the soil that it will be left to his successor in as good or even better condition than it was during his occupation. In return, his fellow-men should make it possible for him to secure a living without resorting to soil robbery. A faulty system of soil management that permits a decline in soil productivity will ultimately be just as injurious to the men indirectly dependent upon the soil as it is to those actually living on the land.

The soils of the United States and Canada are a great asset, and one over which man has relatively large control. Intimately associated with this great asset are two other resources, namely, the atmosphere that envelops the earth and the sunshine that reaches it. Little can be done, however, to control these assets, but with the surface of the earth man can do much as he pleases.

What Farmers Should Know.—Every farmer should have a thorough knowledge of the soil on his own farm. In this and following chapters, the soil and its properties as related to the business of farming will be discussed chiefly from the standpoint of the farmer. The practical farmer expects cash compensation for the intelligent care he gives to his land. He should be able to distinguish between the essentials and non-essentials in the science of the soil. He should know that all soils may be made productive, but this cannot always be done at a profit. Soils on which men, by the exercise of intelligence and reasonable industry, cannot make more than a meager living, should not be cultivated. They should revert to nature or be devoted to forestry. There is some land that has been cleared of its virgin growth and come under the plow that should

never have been farmed. There are farms, once productive, that have been robbed of fertility and neglected until they are no longer fit for occupation. There are also some types of farming in some localities, once profitable, that are not paying under the changed economic conditions. These are some of the more acute problems that call for a fuller knowledge of the soil than we have previously possessed. The following chapters in Part I will deal with the essentials in a non-technical manner.



ROCK WEATHERING AND THE PROCESS OF SOIL FORMATION.¹

It is hoped it may all be profitable reading for any one engaged in the business of farming.

The Science of the Soil.—In recent years science has been directed towards the soil in search of new truths. The reasons for methods of tillage, crop rotations, use of manures, need for lime and many other things have been explained. Soils are being classified and mapped. Crop adaptation is being studied. Field experiments with fertilizers and cultural methods are being conducted extensively in every state in the Union. As a result of all this activity, much progress has been made and we now have a voluminous literature relating to the soil. The subject is recognized as vital to successful farming everywhere, because the soil is the foundation of all agriculture.

¹Courtesy of E. P. Dutton & Co., New York City. From "The Soil," by Hall.

How Soils are Formed.—Many agents are active in the formation of soils. Among these may be mentioned changes in temperature, the mechanical action of wind and water, the solvent action of water, and the action of bacteria, fungi and the higher forms of plants.

The manner of formation gives rise to two general classes of soil known as (1) residual soils and (2) transported soils. Residual soils are those formed from rocks like those on which they rest, while transported soils are those carried some distance either by the movement of glaciers, or by moving water in the form of streams and tides, or by the action of the wind.

Weathering and Disintegration.—Rocks absorb more or less water. Low temperatures cause a freezing of the water, which exerts a pressure approximating one ton per square inch. This ruptures the rocks, and the process repeated many times every year gradually reduces the portion subjected to these changes in temperature to fragments. Little by little rocks are thus reduced to soil. On the immediate surface the change in temperature between night and day causes expansion and contraction which also tends to sliver off particles of rock. The movement of soil particles as the result of wind and rain also tends to wear down the surface and break off minute particles that contribute to the process of weathering and disintegration.

In addition to this the vegetation which gradually secures a foothold develops into larger plants, the roots of which penetrate the crevices, exerting a pressure which still further moves and often ruptures the already weakened rocks or fragments thereof. In this way, through generations, the soils are gradually formed and become incorporated with the decomposed vegetation that gradually accumulates on and near the surface. As a further aid to the process of weathering and disintegration we find numerous worms and insects that burrow into the soil, living on the organic matter and living plants. These not only move particles of soil from place to place but carry the organic matter down into the soil.

The rain which falls upon the soil is also a factor in soil formation. When thoroughly wet the soils expand and when quite dry they contract and little fissures open in the surface. A succeeding rain washes the fine surface particles and organic matter into the fissures and causes a gradual mixture of these two essential parts of the soil solids.

Decomposition.—The processes of weathering and disintegration result in a change in the physical properties of the soil without necessarily changing the character of the compounds. Decomposition, on the other hand, generally results in the formation of new compounds. The processes of decomposition are technical and we will not undertake to discuss them.

What is the Soil?—The soil consists of three principal parts, namely, solids, a liquid and gases. The solids consist of the minerals and the organic matter mingled with them. The liquid is the soil water in which

is dissolved small quantities of various soil solids. The gases consist chiefly of the air intermingled with various quantities of other compounds, such as carbon dioxide, marsh gas, etc.

The soil and subsoil include all material to the depth to which plant roots distribute themselves. It, therefore, constitutes a wide range of material, both in depth and character. It may be deep or shallow, loose or compact, wet or dry, coarse or fine in texture, having all degrees of variation in its physical, chemical and biological properties.

The Soil Solids.—The solid part of the soil consists of the minerals and organic matter. In practically all soils the minerals form ninety-five per cent or more of the solids. The exception to this would be the peat and muck soils, which may contain as much as eighty per cent or more of organic matter. The mineral matter of the soil consists chiefly of the minute particles or fragments of the mother rock from which the soil has been derived. In case of residual soils this will correspond in a large degree to the rock formation generally found beneath the soil and subsoil at varying depths. In transported soils the mineral particles, having been transported either by water, glaciers, or wind, may have come from different sources, and will generally show a greater diversity in character. It is significant, however, that the minerals of all soils contain all the essential mineral elements for plant growth, although these may vary widely in their relative proportions.

The minerals of the soil are sparingly soluble in the soil water and the solubility is influenced by a number of factors that will be discussed in a subsequent chapter. It is fortunate that this solubility takes place very slowly, otherwise soils would be dissolved and disappear in the drainage waters too rapidly, and the waters of the earth would become too saline to be used by plant and animal life. Loss of the mineral constituents takes place by leaching. The drainage waters from land always contain a very small quantity of many of the elements of which the soil is composed. Nitrogen, the most valuable decomposition product of the organic matter of the soil, is most rapidly leached away in the form of nitrates. Likewise, lime slowly disappears from the body of the soil. Limestone soils, formed from the disintegration and decomposition of limestone rocks, sometimes ninety per cent or more carbonate of lime, generally contain not more than one-half of one per cent of carbonate of lime. The rate of leaching corresponds in a large measure to the rainfall of the region. In regions of sparse rainfall very little leaching takes place, and the soil solution frequently becomes so concentrated that the soils are known as alkali soils. Such soils are either bare of vegetation or produce only crops that are tolerant of alkali. The soils of arid regions are as a rule very productive when placed under irrigation.

The Soil Fluid.—This consists of water in which is dissolved minute quantities of the different minerals of the soil together with organic products and gases. The soil solution moves through the soil by virtue of

gravity and capillarity. The water from rain passes downward by gravity. The rate of downward movement depends on the size of the little passages through the soil. In fine-textured, compact soils it is often very slow. The depth to which it penetrates depends upon the character of the subsoil or underlying strata. It is frequently intercepted by impervious layers, and consequently in times of excessive rainfall the soil becomes saturated and water accumulates on the surface. It then seeks an escape by passage over the surface and often carries with it portions of the soil, thus becoming a destructive agent in soil formation. In dry periods the surface of the soil loses its water through direct evaporation and through the consumption of water by the plants growing in the soil. This should be replaced by the water in the subsoil which returns to the surface by capillarity. The distance through which capillary water will rise is measured by a few feet. The height of rise is greatest in case of fine-textured soils, but in this type of soil the rate of movement is slowest. The rate of movement in sandy soils is much more rapid, but the height of rise is much less.

Gases of the Soil.—The soil atmosphere consists of air and the gases resulting from decomposition of the organic solids in the soil. The dominant gas is carbon dioxide, which, dissolved in water, increases the solvent action of the water and helps to increase the available plant food. The movement of the gases in the soil is affected by changes in temperature which cause an expansion and contraction of their volume. It is also affected by the movements of soil water. As the water table in the soil is lowered air enters and fills up all spaces not occupied by water. The movement is also facilitated by changes in barometric pressure and by the movement of the air over the surface of the soil. Just as a strong wind blowing over the top of a chimney causes a strong draft in the chimney, so does such a wind cause a ventilation of the soil and increases the circulation of the air within the soil.

The roots of most economic plants require oxygen and this is secured in properly drained and well aerated soils from the soil atmosphere. When soils are filled with water the plant roots have difficulty in getting the required supply of oxygen and the growth of the plant is retarded. A proper aeration of the soil is necessary to the development of microscopic organisms that live in great numbers in the soil and play an important part in making available the mineral constituents necessary for the higher forms of plants. It is essential that farmers understand the movement of water and air in the soil in order that they may do their part in bringing about that degree of movement that is essential to the highest productivity of the soil. Drainage, cultivation and the judicious selection of the crops grown are some of the means of influencing the movement of water and air in the soil.

Soil Classification.—Science is classified knowledge. In order that there may be a science of the soil it becomes necessary to classify soils.

Such a classification should meet the needs of an enlightened agriculture. The first classification of the soils of the United States and Canada to be put into extensive use was that devised by the Bureau of Soils of the United States Department of Agriculture, and used extensively in the soil survey of the United States during the past sixteen years. This classification is based upon factors that can be recognized in the field, and has for its ultimate aim the crop adaptation and management of the soil.

Soil Surveys.—"A soil survey exists for the purpose of defining, mapping, classifying, correlating and describing soils. The results obtained are valuable in many ways and to men of many kinds of occupation and interests. To the farmer it gives an interpretation of the appearance and behavior of his soils, and enables him to compare his farm with other farms of the same and of different soils. The soil survey report shows him the meaning of the comparison and furnishes a basis for working out a system of management that will be profitable and at the same time conserve the fertility of his soil. To the investor, banker, real estate dealer or railway official it furnishes a basis for the determination of land values. To the scientific investigator it furnishes a foundation knowledge of the soil on which can be based plans for its improvement and further investigation by experiment. To the colonist it furnishes a reliable description of the soil."

Soils of the United States.—"For the purposes of soil classification the United States has been divided into thirteen subdivisions, seven of which, lying east of the Great Plains, are called soil provinces, and six, including the Great Plains and the country west of them, are known as regions.

"A soil province is an area having the same general physiographic expression, in which the soils have been produced by the same forces or groups of forces and throughout which each rock or soil material yields to equal forces equal results.

"A soil region differs from a soil province in being more inclusive. It embraces an area, the several parts of which may on further study resolve themselves into soil provinces.

"Soil provinces and soil regions are essentially geographic features."* The soils in a province are separated into groups. Each group constitutes a series. A soil series is divided finally into types. The type is determined by texture. The texture may range from loose sands down to the heaviest of clays. All types in a soil region or province that are closely related in reference to color, drainage, character of subsoil and topography and are of a common origin, constitute a group or series of soils. A soil type is, therefore, the unit in soil classification. "It is limited to a single class, a single series and a single province."*

C'assification by Texture.—The soil type of a particular series is

* That which is enclosed in quotation marks is quoted from U. S. Bureau of Soils Bulletin No. 96. "Soils of the United States."







based on soil texture and is determined in the laboratory by separating a sample into seven portions, or grades. Each portion contains soil particles ranging in diameter between fixed limits. This process constitutes a mechanical analysis. In such an analysis the groups and their diameters are as follows:

Groups.	Diameter in mm.	Number of Particles in 1 Gram.
1. Fine gravel.....	2.000-1.000	252
2. Coarse sand.....	1.000-0.500	1,723
3. Medium sand.....	0.500-0.250	13,500
4. Fine sand.....	0.250-0.100	132,600
5. Very fine sand.....	0.100-0.050	1,687,000
6. Silt.....	0.050-0.005	65,100,000
7. Clay.....	0.005-0.000	45,500,000,000

Fifteen types of soil are possible within any soil series. The relative proportions of the several soil separates, given in the table above, determine the type. The twelve most important of these are known as

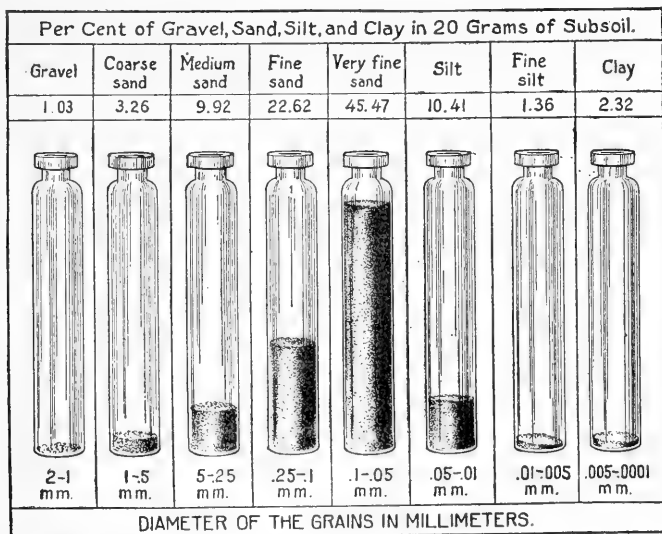

THE SOIL SEPARATES AS MADE BY MECHANICAL ANALYSIS, SHOWING THE MAKEUP OF A TYPICAL SOIL.¹

coarse sand, medium sand, fine sand, coarse sandy loam, medium sandy loam, fine sandy loam, loam, silt loam, clay loam, sandy clay, silt clay and clay. They range from light to heavy in the order named, and, except

¹Courtesy of Orange Judd Company. From "Soils and Crops," by Hunt and Burkett.

as influenced by presence of organic matter, their water-holding capacity varies directly with the increase in fineness of texture, the sand having the smallest water-holding capacity and the silty clays and clays the largest.

In classifying soils in the field the soil expert determines the type by the appearance and feel of the soil. He takes numerous samples which are sent to the laboratory where they are subjected to a mechanical analysis in order to verify his judgment and field classification.

The accompanying map shows the extent and location of the several soil provinces and regions in the United States.

Crop Adaptation.—That certain soils under definite climatic conditions are best adapted to certain plants is obvious to anyone who has studied



INSPECTING AND SAMPLING THE SOIL.

different soils under field conditions. The marked variation in the character of vegetation is often made use of in defining the boundaries of soil types and soil series. Adaptation is also manifest in the behavior of cultivated crops. Among our well-known crops tobacco is the most susceptible to changes in character of soil, and we find that a specific type of tobacco can be grown to perfection only on a certain type of soil, while a very different type of tobacco demands an entirely different type of soil for its satisfactory growth. The red soils of the Orangeburg series in Texas will produce an excellent quality of tobacco, whereas the Norfolk series with gray surface soil and yellow subsoil, occurring in the same general locality, gives very unsatisfactory results with the same variety of tobacco. This difference in the tobacco is not due to the texture of the soil, since soil of the same texture can readily be selected in both of these series. The most casual observer cannot fail to distinguish the difference between the Norfolk and Orangeburg soils, as manifested chiefly in their color.

The question of crop adaptation, therefore, becomes exceedingly important, and success with a crop in which quality plays an important part will be determined to a large extent by whether or not it is produced on the soil to which it is by nature best adapted.

Variety tests of wheat afford further illustration of crop adaptation. In Illinois the wheat giving the highest yield on the black prairie soil of the central and northern part of the state is Turkey Red, but this variety when grown on the light-colored soil in the southern part of the state yielded five bushels per acre less than the variety Harvest King. It is evident, therefore, that if Turkey Red, which was demonstrated to be the best variety at the experiment station, had been planted over the wheat-growing region of the southern part of the state, farmers of that region would have suffered a considerable loss. In Pennsylvania and North Carolina Turkey Red has been grown in variety tests, and found to be one of the lowest yielding varieties. For example, the yield in North Carolina, as an average of four years, was only 8.4 bushels per acre as compared with 13.5 bushels for Dawson's Golden Chaff. At the Pennsylvania Station the yield for two years was 26.5 bushels per acre for Turkey Red and 37.5 bushels for Dawson's Golden Chaff.

Similar observations have been made relative to varieties of cotton and varieties of apples. There is no doubt but that the question of varietal adaptation, with reference to all of the principal crops, is important, and it should be the business of farmers in their community to ascertain the varieties of the crops grown which are best adapted to local conditions.

Dr. J. A. Bonsteel, born and reared on a New York farm, and for fifteen years a soil expert in the U. S. Bureau of Soils, prepared for the *Tribune Farmer* in the early part of 1913 a series of articles on "Fitting Crops to Soils." The following is a portion of his summary and is a concise statement of the soil adaptation of the fifteen leading crops in the northeastern part of the United States.

"Summary of Soil Adaptedness.—Summarizing, briefly, the facts stated in the articles and derived from a large number of field observations made in all parts of the northeastern portion of the United States, we see:

"First.—Clay soils are best suited to the production of grass. They are suited to the growing of wheat when well drained and of cabbages under favorable local conditions of drainage and market. Oats may be grown, but thrive better upon more friable soils.

"Second.—Clay loam soils are especially well suited to the growing of grass, wheat, beans and cabbages, the latter two only when well drained.

"Third.—Silt loam soils produce wheat, oats, buckwheat, late potatoes, corn, onions and celery. The last two crops require special attention to drainage and moisture supply to be well suited to silt loam soils.

"Fourth.—Loam soils, which are the most extensively developed of any group in the Northeastern states, are also suited to the widest range of

crops. These are wheat, oats, corn, buckwheat, late potatoes, barley, rye, grass, alfalfa and beans.

"Fifth.—The sandy loam soils are best suited for the growing of barley, rye, beans, early potatoes, and, under special conditions of location near to water level, of onions and celery.

"Sixth.—Sandy soils are best adapted to the early potatoes grown as market garden or truck crops, and to rye.

"This summary takes into consideration only the texture of the soil and its adaptations under fair conditions of drainage, organic matter content and average skill in treatment.

"Yet the articles have called special attention to certain other features than those of soil texture. Otherwise, the specific naming of the different loam soils would not have been given.

"The noteworthy lime content of the soils of the Dunkirk, Ontario, Cazenovia, Dover and Hagerstown loams has been made evident as a basis for the profitable growing of alfalfa, since the plant is known to be particularly sensitive to the amount of lime contained in the soil.

"Similarly the production of the late or staple potato crop has been noted upon soils which are particularly well supplied with organic matter as in the case of the Caribou loam and the Volusia loam. Other loams and silt loams produce good crops of potatoes upon individual farms where there is an unusually good supply of organic matter in the soil, but not on portions of the other types not so well supplied. Good organic matter content is rather a general characteristic of a good potato soil and is found on the types named.

"Beans may be grown upon a large number of different soils if the farmer is satisfied with average crops. But the best bean crops are secured from soils which are well supplied both with organic matter and with lime. Hence, the Clyde loam and clay loam and the soils of the Dunkirk series are among the best bean soils.

"It is still impossible to state precisely what varieties of the different crops are best suited to a particular soil, yet I hope to see the time when there will be special breeding of staple crops to meet the different conditions which prevail upon different soils. Some time there will be strains of wheat, of corn, of oats, of alfalfa and of other field crops which have been developed for generations upon a specific type of soil and which excel all other strains of the crop for that soil. This is inevitable in time, since the characteristics of plants may be fixed by growing them under the same conditions of soil and climate for many plant generations.

"There are certain broad generalizations in crop adaptation which are very generally known, but may profitably be stated again.

"The friable loam is the great soil texture of the temperate, humid regions, possessing the broadest crop adaptations, and usually the most permanent natural fertility of all soils.

"As any departure is made from the loam texture there is a restriction

in the number of the different crops which may be grown upon this type, and frequently in the yields of the common crops, which may be expected. The crop range in number of kinds best grown usually decreases in both directions, becoming decidedly limited at a rapid rate in the case of more sandy soils, and at a less rapid rate in the case of the clay loams and clays. This expresses moisture control. It has been more difficult to control moisture in the sandy soils than in the clay loams and clays. Irrigation is the answer to the difficulty with the sands, and drainage with the clays.

“Leguminous crops of all descriptions are particularly favored by a high lime content in both soil and subsoil.

“Soils well supplied with organic matter atone for some other soil deficiencies in texture and structure.

“Compacted layers of any kinds beneath the surface soil are unfavorable to crop production. This applies to compacted subsoil, due to shallow plowing, as well as to actual ‘hard-pan.’

“Good soil management always increases the range of crops which may be grown as well as the amounts harvested. Man’s ingenuity may be used profitably to overcome nature’s deficiencies.

“**Eastern Soils Not Worn Out.**—Finally, I wish to state as a result of years of observation under widely varying circumstances of soil study and of farming:

“I. That the soils of the Northeastern states are in nowise ‘worn out’ or seriously depleted of anything essential to good crop production with the local exception of organic matter in the surface soil.

“II. That the majority of soils of the Northeastern states are capable of producing average crops or greater if given fair treatment, especially when the proper crops for the climate and the soil are selected for planting and others are discarded.

“III. That soils which have been called ‘worn out’ have frequently revived within a period of five years or less of good farming methods, until their yields equaled or exceeded any production before known upon that soil.

“IV. That the best methods of crop growing and of soil management now practiced by the best farmers of the Northeastern states would, if made general in their application, more than double the total cropping ability of the improved lands now in use.

“V. That the market facilities of the Northeastern states are now and will continue to become more and more favorable to the intensive use of land and to the man who uses each acre for the crop or group of crops best suited to his soil and climate.

* * * * *

“To the young farmers who are to carry on the great work of redeeming land and of feeding people I have just one more thing to say. Study the fundamental principles, which are true in Asia or the United States;

true today and for the centuries to come; true for all crops and for all seasons. The details of modifying these principles of agriculture, experience alone can teach you."

SOIL ADAPTATION OF FIFTEEN CROPS COMMON TO NORTHEASTERN STATES.

CROPS.	SOILS BEST SUITED TO.	WAYS OF MODIFYING SOILS TO FIT CROPS.	FERTILIZERS TO APPLY.
Wheat.	Clay and silt loams containing considerable lime. Surface soil friable. Subsoils of same nature, but heavier and more compacted.	Use manure liberally. Practice rotation with leguminous crops. Apply moderate amounts of lime.	Principally phosphatic fertilizers containing small amounts of nitrogen and potash.
Oats.	Wide adaptation. Loams or heavy loams rather fine in texture best. Avoid dry sands. Plenty of humus desirable.	Apply manure to crop preceding. Turn under green manure. Plow only moderately deep. Seed early in spring. Prepare land thoroughly.	Always use some form of phosphate, preferably acid phosphate or basic slag. Use small amounts of potash, usually muriate.
Rye.	Well-drained, sandy loams give the longest, brightest straw and largest crops of grain. Will do fairly well on lighter and poorer upland soils.	Smaller amounts of humus necessary. Will grow on more acid soils than wheat or oats. Fine general utility crop.	About same as wheat. Little lime needed.
Barley.	Well-drained fertile loam. Intermediate between rye and oat soils. Heavy loams give best yields. Sandy loams give brighter grain. Avoid clay on account of lodging and too light sand because of drought.	Requires moderate amount of humus. Avoid too rich soils on account of lodging. Good drainage essential.	About same as oats.
Buckwheat.	Moderately friable loam, underlain by compacted but well-drained loamy subsoils.	Will do well on rather poor, thin hill lands, because of power to loosen pulverized soil. Prepare land thoroughly, providing organic matter. Good drainage necessary.	Complete fertilizer.
Potatoes.	Sandy or sandy loam preferably for early crop. Silt loam or loam best for late. Avoid clay and clay loams.	Thorough drainage essential. Abundant organic matter needed. Grow in rotation and turn under green manures.	Apply large amounts of fertilizer high in potash. Small amounts of nitrogen for late crops. More on sandy soils. Avoid liming immediately ahead of potatoes.
Corn.	Loam or silt loam, with heavier subsoil at least ten inches below surface. Where seasons are short, sandy or gravelly loams give larger yields, because of earlier maturity.	Well-drained, moisture-holding lands. Turn under good grass sod or preferably clover sod. Apply barnyard manure to previous crop if possible.	Use 200 to 500 lbs. of fertilizer containing 3 to 4 per cent of nitrogen, 8 to 12 per cent phosphoric acid, 3 to 4 per cent potash.
Clover and Timothy Hay.	Loam or clay loam best. Heavy soils retain moisture best. Avoid too compacted clays or hardpans. Timothy: Loam or well-drained clay loam or clay.	Use stable manure on preceding crop. Apply lime in most cases. See that both surface and subsoil are well drained. Prepare land very thoroughly for seeding.	Stable manure best fertilizer; 100 to 300 lbs. an acre of complete fertilizer. High in nitrogen (8 to 10 per cent). Gives good results.
Alfalfa.	Very fertile, well-drained, alkaline soils. Strong loams containing limestone best. Avoid shallow soils and hardpans near surface.	Drain soil thoroughly. Standing water fatal to alfalfa. Apply lime liberally. Inoculate soil.	Top dress with stable manure or with 300 to 400 lbs. of acid phosphate or 400 to 600 lbs. basic slag, or 200 lbs. or more of steamed bone meal an acre.
Beans.	Wide range of soils. Best results on types not more coarse grained than sandy loam or more compacted than clay loam. Lime-bearing soils best.	Must be well drained and well supplied with organic matter. If soils do not contain limestone give moderate application of lime.	Fertilize with 200 to 300 lbs. an acre of mixture containing 2 per cent nitrogen, 8 to 12 per cent phosphoric acid, 4 to 6 per cent potash. Use stable manure.
Apples.	Fairly deep, well-drained loams and clay and silt loams with fair proportion of sand in surface soil. A heavy subsoil retentive of moisture, but not impervious to water.	See that soils are thoroughly drained. Apply moderate amounts of manure. Plow under leguminous cover crop. In general give thorough cultivation in early part of the season.	Depends on soils and variety. On heavier soils none may be needed except stable manure, which is always best. Experiment with commercial fertilizers.

SOIL ADAPTATION OF FIFTEEN CROPS COMMON TO NORTHEASTERN STATES (Continued).

CROPS.	SOILS BEST SUITED TO.	WAYS OF MODIFYING SOILS TO FIT CROPS.	FERTILIZERS TO APPLY
Cabbage.	Heavy loam or silt loam, with retentive subsoils. Muck soils generally well suited if not too loose.	See that soil is well supplied with organic matter. Apply lime liberally to surface of soil. Grow crop in rotation.	Apply complete fertilizer, high in potash and moderately high in nitrogen, in liberal amounts.
Celery.	Muck soils best adapted. Silty river flood plains and silty or fine silty uplands, high in organic matter, will do.	Soil must be moist, but well drained and well supplied with organic matter. Lime and salt both affect celery favorably.	Fertilize heavily with stable manure where possible. Large amounts of commercial fertilizer, rich in nitrogen, can be applied profitably.
Onions.	Sandy loam just above water level, protected from overflow and well supplied with moisture. Strong, well-drained muck land tilled two or three years.	Must be well drained. Large amounts of organic matter necessary. Lime gives good results. Crop rotation or alternation desirable.	Stable manure and high grade commercial fertilizers must be abundantly supplied for continued large yields.
Tobacco.	Many grades of soil from light silt to heavy loams suitable, depending on grade of leaf desired.	Must be well drained. High in organic matter. Very thoroughly prepared soil and constant cultivation necessary.	Depends on kind of soil and type of leaf being grown. Usually requires large amounts of potash derived from sulphate. Liming usually thickens leaf and makes it harsh.

Following the plan of Dr. Bonsteel, the author has gone carefully through the soil literature of the United States and summarized the crop adaptations, the means of modifying soils and the fertilizers to apply to them. This is given for the leading crops by regions as follows: (1) The North Central region, covered mostly by the Glacial and Glacial lake soils lying between Pennsylvania and the Dakotas, and north of the Ohio and Missouri Rivers; (2) the South Central and South Atlantic Coast region, comprising Delaware, Maryland, Virginia, West Virginia, Kentucky and the Cotton Belt; (3) the Plains and Mountain region west of the 97th meridian of longitude; and (4) the Pacific Coast region, including the three coast states and most of Nevada.

The following is a summary of the leading crops adapted to soils of the North Central region:

Sand.—Good for very early truck and small fruits; fair for sugar beets and poor for small grains. May be kept in grass to prevent drifting.

Sandy Loam.—Good for tobacco, truck, apples, beans, root crops, fruit, and fair for hay, small grains and corn.

Loam.—Good for general crops, truck and fruit.

Silt Loam.—Finest corn soil; good for small grains, hay, fruit, tobacco and heavy truck, such as cabbage.

Clay Loam.—Best wheat soil; good for corn, oats, rye, barley, grass, clover, alfalfa and fruit.

Clay.—Good for hay, small grains, export tobacco, some fruit and small fruit. (For continuation see next page.)

The following is a summary of the leading crops adapted to soils of the South Central and South Atlantic Coast region:

Sand.—Adapted to earliest vegetables, some fruits and some varieties of grapes. Small grains may be grown, but do better on heavier soils.

SOIL ADAPTATION OF THE LEADING CROPS OF THE NORTH CENTRAL REGION.

CROPS.	SOILS BEST SUITED TO.	WAYS OF MODIFYING SOILS TO FIT CROPS.	FERTILIZERS TO APPLY.
Corn.	Loam or silt loam. Deep soil with heavy subsoil. For short season, sandy loam.	Well-drained moisture-holding lands. Turn under good grass or clover sod. Apply barnyard manure.	Phosphoric acid and legumes. Use lime on sour soils.
Wheat.	Clay or silt loam. Deep soil well supplied with humus. Subsoil, heavier clay.	Rotate with legumes and hoed crops. Add organic matter as manure or green manure when available.	Small to moderate amounts of fertilizers high in phosphoric acid, and with small amounts of nitrogen and potash. For western portion, phosphoric acid only.
Oats.	Any soil but light sand. Loam or silt loam best. Good supply of humus desirable.	Should follow hoed crops, usually corn. Prepare seed bed by disking, seed early, drilling preferable.	Manure or fertilizer should be applied to preceding crop. On poor soils, small amounts of phosphorus and nitrogen may be used.
Rye.	Sandy loam or loam; must be well drained.	Good crop for poor land; will stand considerable acid.	About same as wheat. Does not need much lime.
Barley.	Loam to clay loam. Clay causes lodging. Heavy soils give larger yields; light soils brighter straw.	Moderate amounts of humus. Must be well drained. Too rich soils will cause lodging.	About same as oats.
Buckwheat.	Loam with well-drained loamy subsoil.	Good pulverizer, hence will do well on rather poor soil. Good drainage essential. Add organic matter.	A minor crop, seldom fertilized. Small amounts of complete fertilizer advised for poor soils.
Potatoes.	Sandy loam or loam; avoid heavy soils.	Fall plow; use winter cover crop and turn under. Grow in rotation. Thorough drainage needed.	Do not lime immediately before potatoes. Apply fertilizer high in potassium.
Hay, Clover, Timothy.	Wide variety of soils. Loam to clay loam best.	Drain land, top dress with manure; small applications spread uniformly.	Top dress beginning of second year with small amounts of complete fertilizer high in nitrogen.
Alfalfa.	Rather heavy soil but must be deep and well drained.	Plow deep and inoculate soil.	Use good supply mineral fertilizer and lime.
Beans.	Sandy loam and clay loam best.	Apply manure and drain.	Moderate amounts complete fertilizer high in phosphoric acid and potash. Apply lime.
Apples.	Loamy soil best; must be quite deep and well drained. Avoid poor air drainage.	Sow to cover crop, preferably to legume in fall; plow under in spring and cultivate clean during early summer.	Depends on soil. On good soils, none needed for several years. Experiment.
Heavy Truck—Cabbage, Celery, etc.	Heavy loams or muck soils, high in organic matter.	Use plenty of stable manure.	Complete fertilizer high in nitrogen. Also lime.
Other Truck—Lettuce, Radishes, etc.	Light soils, sandy for very early markets; sandy loam and loam for later crops.	Must be prepared to irrigate sand. Apply lots of manure. Rotation desirable.	High grade complete fertilizer. High nitrogen content for leaf crops, as lettuce.
Tobacco.	For "bright" cigarette tobacco, sand; for wrapper, sandy loam; for filler and export grade, heavier soils.	Prepare soil thoroughly and cultivate frequently. Must have high organic content and be well drained for best results.	Avoid lime, as it thickens leaf. Kind of fertilizer depends on the soil. Usually large amounts of potassium sulphate.
Plums, Cherries, Small Fruits.	Sand and sandy loam. Provide for good air drainage in order to avoid danger from frost.	Use leguminous cover crops for winter. Clean cultivation in summer.	Varies with soil and location. Experiment.

Sandy Loam.—"Bright" tobacco, mid-season truck, peanuts, forage crops and cotton and small grains to some extent.

Loam.—Cotton, tobacco, main crop truck, corn, small grains, sugar

care, fruit and small fruit, legumes for hay or cover crops, rice and nursery stock.

Silt Loam.—Cotton, tobacco, truck for canning, corn, small grains, hay and pasturage, tree and small fruits.

Clay Loam.—Cotton, export tobacco, corn, small grains, very good for grazing, fruit, rice, flax, hemp, etc.

Clay.—Rice, sugar cane, export tobacco, forage crops, hay and fruit.

SOIL ADAPTATION OF THE LEADING CROPS OF THE SOUTH CENTRAL AND SOUTH ATLANTIC COAST REGION.

CROPS.	SOILS BEST SUITED TO.	WAYS OF MODIFYING SOILS TO FIT CROPS.	FERTILIZERS TO APPLY.
Cotton.	Loam or silt loam.	Fall plow, cultivate frequently, rotate with legumes.	Add manure and other forms of organic matter. Complete fertilizer.
Corn.	Any soil but very light sand and heavy clay. Best on loam.	Plow deep and rotate.	Complete fertilizer high in phosphoric acid. Also plenty of organic matter. Add lime.
Tobacco.	Varies with kind of tobacco grown. (See North Central Region.)	Frequent, careful cultivation and cover crop in winter to prevent erosion. Rotate with legume.	Do not lime light tobacco. Avoid muriate of potash in fertilizer.
Sugar Cane.	Loam to clay; best on clay loam. Soil must be rich.	Drain when needed; add organic matter.	Heavy complete fertilizer.
Truck.	Sand for extra early, loam for main crop.	Must be well drained and have abundant supply of humus.	High grade complete fertilizer.
Rice.	Clay or clay loam; heavy sub-soil essential.	Must be able to flood at proper time and drain at proper time.	Plow deep and add lime.
Peaches, Plums, Cherries, Small Fruits.	Sand or sandy loam.	Use cover crops to prevent washing, legumes best.	Varies with location, climate and crop. Experiment.
Forage Crops—Millet, Sorghum, etc.	Clay loam or clay.	Plow deep, use winter cover crop.	Complete fertilizer and manure, or green manure.
Grapes.	Varies with variety from sand to clay.	Add organic matter.	Varies with soil. Experiment.
Peanuts.	Sandy loam.	Organic matter and fall plowing.	Mineral fertilizers.
Annual Legumes, Cowpeas, Soy Beans, etc.	Sandy loam to clays.	Plow deep, give good cultivation. Good for interplanting with cotton or corn.	Mineral fertilizers and lime.

Plains and Mountain Region.—Most of this region is semi-arid to arid and used largely as pasture, but where transportation and water are available, very good crops may be grown by the aid of irrigation. The following is a summary of the leading crops adapted to soils of the Plains and Mountain region:

Sand.—Is the predominating soil and care must be taken to prevent its drifting. It gives fair crops of truck, fruit, cotton, Kaffir, sorghum, wheat, oats and hay.

Sandy Loam.—Does not drift quite so badly. On it may be grown truck, fruit, cotton, Kaffir, sorghum, milo, sugar beets, wheat and alfalfa. It also gives good pasturage.

Loam.—Is about the most productive soil. It is good for broom-corn, sorghum, milo, truck, sugar beets and, in the South, cotton. In the Central States small grains and forage crops; and in the North, wheat, oats, flax and millet.

Silt Loam.—Is not quite so good as loam, but is used for about the same crops.

Clay Loam.—Is very hard to handle and not very productive. It is used for general crops and special local crops.

Clay.—Very hard to manage to prevent puddling. It is used to some extent for general crops, but chiefly for grazing.

SOIL ADAPTATION OF THE LEADING CROPS OF THE PLAINS AND MOUNTAIN REGION.

CROPS.	SOILS BEST SUITED TO.	WAYS OF MODIFYING SOILS TO FIT CROPS.	FERTILIZERS TO APPLY.
Cotton.	Loam.	Irrigate.	Manure and complete fertilizer.
Corn.	Loam to clay loam.	Plant with lister. Manure, cultivate frequently.	Fertilizer seldom used.
Small Grains.	Silt loam.	Add organic matter.	Fertilizer seldom used.
Hay and Pasturage	Most any soil with enough water.	Do not pasture too closely or when wet.	
Sugar Beets.	Sandy loam and loam.	Irrigate, plow deeply and give clean cultivation.	Complete fertilizer.
Forage Crops—Kaffir, Sorghum, Millet.	Loam best, but will grow in wide range of soils.	Plow deeply, give thorough cultivation. Do not plant too early.	
Alfalfa.	Sandy loam to clay.	Plow deeply; irrigate. Seed and light crops of hay produced without irrigation.	

Pacific Coast Region.—This region is in most places almost arid. With the aid of irrigation it becomes one of the garden spots of the country. The following is a summary of the leading crops adapted to soils of the Pacific Coast region:

Sand.—Used for early truck, figs, stone fruits, citrus fruits and some of the small fruits. It requires large amounts of water and frequent cultivation to conserve moisture.

Sandy Loam.—Used for most of the fruits grown in this region, also grapes, small fruits, alfalfa and, to some extent, general crops. This soil is quite light and requires much the same care as sand.

Loam.—Used for fruit, late truck, small fruit, grapes, hops, hay and general crops.

Silt Loam.—Used for fruit (including citrus fruit), small fruit, heavy truck, English walnuts.

Clay Loam.—Used for fruit, small fruit, truck for canning, and general crops. This soil is much used in southern California for citrus groves and lima beans.

Clay.—Grains and hay, some heavy truck and tree fruit.

SOIL ADAPTATION OF THE LEADING CROPS OF THE PACIFIC COAST REGION.

CROPS.	SOILS BEST SUITED TO.	WAYS OF MODIFYING SOILS TO FIT CROPS.	FERTILIZERS TO APPLY.
Truck.	Sandy loam for early; silt or clay loam for late.	Add lots of organic matter.	Depends on crop and soil.
Fruit.	Any soil; loam or silt loam best for most fruits.	Practice clean cultivation to prevent evaporation. Add organic matter.	Varies with kind of fruit.
Grapes.	Sandy loam or loam.	Same as for fruit.	Complete fertilizer.
Small Fruit.	Sandy loam to silt loam.	Same as for fruit.	Experiment.
English Walnut.	Silt loam.	Cultivate clean in dry season, but grow cover crop in rainy season, and plow under.	
General Crops—Grains, Hay.	Any of the heavier soils.	Give soil thorough preparation before planting and cultivate wherever possible.	Complete fertilizer.

Aids to Solution of Soil Problems.—The soil survey conducted by the Bureau of Soils of the United States Department of Agriculture, in co-operation with the various state departments of agriculture or agricultural experiment stations, is now extended into many counties in every state. Two kinds of surveys have been made: (1) that known as the reconnaissance soil survey, in which detailed mapping is not undertaken (it consists chiefly in mapping the soil series); and (2) a detailed county survey showing the location and extent of each soil type. The results of this work are issued as government reports, accompanied by colored maps outlining the soils. In these reports the soils are fully described and their crop adaptations stated. Much other valuable data pertaining to agricultural conditions, climate and soil requirements are also given. These reports are available to all farmers living in the districts in which the surveys are made. They may be secured either through the local senator or representative, or directly from the National Department of Agriculture. In some cases the state experiment station or state department of agriculture will be able to supply them.

The detailed county surveys will enable any one in such an area to ascertain the types of soil on his farm. If there is any doubt in this particular on the part of the farmer, he can submit samples of his soil to his state experiment station, and by giving the exact location of his farm, the authorities at the station will be able to advise him not only as to the

type of his soil, but in a general way can give him facts concerning crop adaptation and the treatment most likely to bring good results.

Samples of soil should accurately represent the field from which taken. Samples should be taken to the depth of plowing in not less than ten places in the field. These may be put together and thoroughly mixed.

A pound of this mixture sent to the experiment station by parcel post will meet the requirements. It is frequently desirable also to send a sample of the subsoil. If there is no great hurry it will be better to write to the experiment station first and ask for instruction on collecting and sending samples.

The soil auger is most convenient for taking soil samples. It consists of an ordinary 1½-inch wood auger having the shank lengthened and the threaded screw and sharp lips removed. Any blacksmith can do the work in a few minutes. The accompanying figure shows a three-foot auger with gas pipe handle. For a farmer's use the wooden handle will serve just as well. If an auger is not available, a square-pointed spade will serve very well for taking samples. Dig a hole to the depth of plowing, having one perpendicular side, then cut from the perpendicular side a slice of uniform thickness from top to bottom. This repeated in ten or more places in the field will give a sample representing the soil accurately.

A SOIL AUGER.¹

Because of the difficulty on the part of the experiment station authorities in giving definite advice at long range, some of these institutions now employ experts who travel about the state, inspect farms and consult with farmers relative to their soil problems as well as other problems of the farm. By such inspection these men are able to advise more definitely than can be done by letter.

In the last few years another innovation for the benefit of the farmers has been introduced, namely, the providing of the county farm adviser, who is located within a county permanently and who soon becomes familiar with the agricultural problems of his restricted territory. Through these sources the farmer can always secure able assistance in the solution not only of his soil problems, but of all problems that concern his business.

REFERENCES

"Soils: How to Handle and Improve Them." Fletcher.

"Soils." Lyon and Fippin.

"Soils." Burkett.

Pennsylvania Agricultural Expt. Station Bulletin 132. "Soils of Pennsylvania."

Canadian Dept. of Agriculture Bulletin 228. "Farm Crops."

Farmers' Bulletin No. 494, U. S. Dept. of Agriculture. "Lawn Soils and Lawns."

¹ Courtesy of The Macmillan Co., N. Y. From "How to Choose a Farm," by Hunt.

CHAPTER 2

PHYSICAL, CHEMICAL AND BIOLOGICAL PROPERTIES

Texture of Soil.—Texture pertains to the size of the mineral particles that make up the body of the soil. In the laboratory, texture is determined by a mechanical analysis. This is described in Chapter 1. The clay portion of a soil will range anywhere from a fraction of one per cent to as high as fifty per cent of the body of the soil. The particles of clay are so small that they can be seen only by the use of a high-power microscope. When clay is thoroughly mixed with water the particles will remain in suspension for several days. It is this clay that is chiefly responsible for the turbid condition of the streams of water flowing from the land after heavy rains. Clay, when thoroughly wet and rubbed between the thumb and finger, has a smooth, greasy feel.

The silt may also range from a very small percentage to sixty per cent or more of the body of the soil. It forms the group of particles next larger than clay. It produces practically no perceptibly gritty feel when wet and rubbed between the thumb and finger. Silt particles will remain in suspension in water for only a short time, seldom more than one-half hour.

The various grades of sand consist of particles very much larger than those of either clay or silt, and can be seen with the naked eye. The percentage of sand in soils like that of clay and silt varies between wide ranges. Sandy soils may contain seventy-five per cent to ninety per cent of the different grades of sand. All of the sandy soils give a distinctly gritty feel when the wet soil is rubbed between the thumb and finger.

Water-Holding Capacity of Soils.—The texture of the soil is very important and determines in a large degree the water-holding capacity of the soil, the rapidity of movement of water and air in the soil, the penetration of plant roots, ease of cultivation and, above all, the crop adaptation of the soil. Texture is determined by the relative amounts of the particles that fall into the several groups mentioned. The textural effect is modified by the structure of the soil (discussed later) and its content of organic matter.

The larger the proportion of fine particles, such as clay and silt, the greater is the surface area of these particles in a unit volume of soil. In a well-drained soil all gravitational water passes away and only capillary water is retained. This capillary water consists of very thin films of water adhering to the surface of the soil particles and surrounding them in such a way as to make a continuous film of water in the soil. Through this continuity of the film, water moves by capillarity from a point where the

films are thickest to a point where they are thinner, tending always to equality in the thickness of the film, but gradually becoming thinner as the distance from the source of water increases.

It is evident, therefore, that the fine-textured soil will hold much more water than the one consisting largely of sand. Such a soil can supply crops with more water than a sandy soil, and such a soil is adapted to grass, wheat and other plants having fibrous roots that do not penetrate to great depths.

If a glass tumbler is filled with water and emptied, a thin film of the liquid adheres to the surface. This will equal only a fraction of one per cent of the weight of the tumbler. If the tumbler can be pulverized into a very fine powder and the particles saturated with water and allowed to drain, they may hold water to the extent of ten to fifteen per cent of the weight of the glass. This change in the water-holding power is the result of pulverization and especially of the increase of the exposed surface which is brought in contact with the liquid. The finer the degree of pulverization the larger the percentage of water the glass particles will retain. So we find that soils of very fine texture will sometimes hold as much as forty per cent of their weight of water, while some of the coarse, sandy soils will not hold more than four or

five per cent of their weight of water. This water-holding capacity of the soil is also modified by its content of organic matter. Organic matter

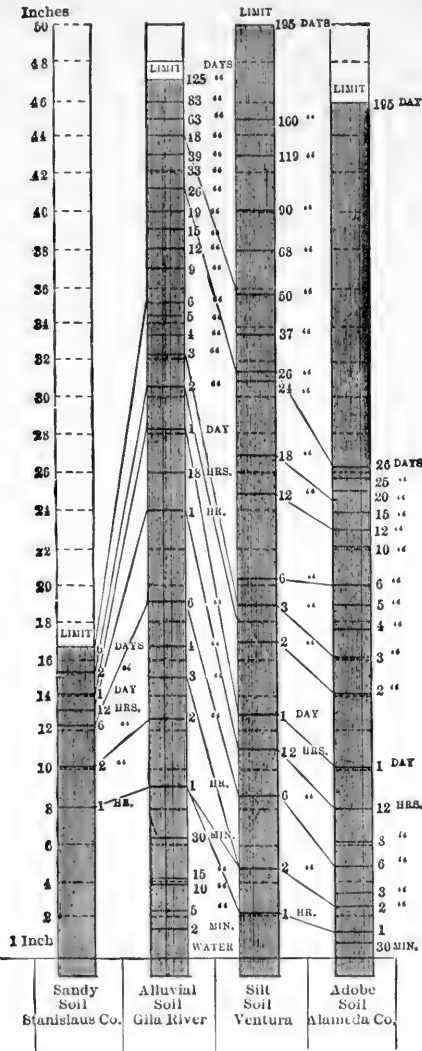

RATE AND HEIGHT OF CAPILLARY RISE OF WATER IN SOILS OF DIFFERENT TEXTURE.¹

¹Courtesy of The Macmillan Company, N. Y. From "Soils," by Hilyard.

will absorb from two to four times its own weight of water. The sponge best illustrates the capacity of organic matter to absorb and hold water.

Water Movement in Soil.—The movement of water in the soil is influenced chiefly by soil texture. In soils of coarse texture the water moves very freely. Drainage is rapid and the soils dry soon after rains so that tillage operations may soon be resumed. On such soils there is generally little loss of time during the period when they need tillage. On very heavy soils, that is, on those consisting chiefly of clay and silt particles, the movement of water within the body of the soil is exceedingly slow. Drainage is difficult, and where the land is level and the substratum is dense, underdrainage is often required in order to make the soils productive. In sandy soils the rainfall penetrates and descends rapidly through the soil body. In this kind of soil leaching is rather rapid. Rain penetrates heavy soils very slowly, and if the rainfall is rapid, its passing from the surface of the soil causes severe erosion. Furthermore, a large proportion of the rainfall is thus lost and in no way benefits the growing plants. On the part of the farmer it therefore becomes essential so to plow and cultivate the fine-textured, heavy soil as to increase its penetrability and facilitate the movement of air and water and the penetration of roots as much as possible. In case of the very sandy soil it is often advisable to do just the reverse. Applications of lime, which tend to cement the particles together, and of organic matter to fill up the interspaces, and compacting the soil by rolling to reduce the spaces, are often resorted to. Where land has a high value it may even pay to add clay to a sandy soil in order to improve its physical properties. On the other hand, it may sometimes pay to add sand to a very heavy, clay soil. Such practice, however, is justifiable only in case of land of high value when used for intensive cropping.

Absorption of Fertilizers.—The absorptive power of the soil is also proportional to the surface area of the particles within a unit volume. Soils of fine texture are, therefore, capable of absorbing and holding much larger amounts of fertilizers than those that are sandy. This is very important in connection with the application of fertilizers. It is also true that the soil absorption is much stronger for some substances than it is for others, and this will often determine the time of application of fertilizers. The absorptive power of the soil is less marked for nitrogen, either as ammonia or nitrates, than it is for either potash or phosphorus. Consequently, nitrogenous fertilizers should be used in quantities just sufficient to meet the needs of the crop, and applied just preceding the time at which the crop most needs it. In view of this fact, surface applications of nitrogen are often effective, since the downward movement of the material in the soil soon brings it into the region of root activity.

Potash and phosphorus are, however, absorbed and held much more tenaciously by the soil particles, and are not subject to severe loss by leaching. Liberal applications of potash applied to the surface of the

soil to which large amounts of water were applied by irrigation were found to have penetrated to a depth of only about three inches in the course of as many months. This suggests that such fertilizers should be distributed in that zone of the soil where root activity is most marked, in order that the plants may utilize the fertilizer as fully as possible. All of this has a bearing upon the fertilizer practices which will be discussed in a subsequent chapter.

Plasticity and Ease of Cultivation.—Soils of fine texture are very plastic when wet, and clay soils in this condition tend to adhere to cultural implements, wheels of vehicles and the feet of animals. Such soils should not be tilled when they are wet. The movement of the soil particles upon one another when in this condition causes them to be cloddy and hard when they dry out. It furthermore gives rise to what is known as puddling, and prevents the free movement of water and air through the soil. This is well illustrated by a clay road in the spring when wagons pass over it and form ruts while it is in a wet condition. These ruts will often become filled with water, which escapes only by evaporation, none of it finding its way through the soil below. The fine-textured soils, when not well supplied with organic matter, tend to run together and become very compact and difficult to cultivate. This condition can be alleviated to a certain extent by avoiding tillage operations when too wet, and also by the application of organic matter in the form of manure or green manuring crops. Likewise, this condition is improved by the application of lime, which causes a flocculation of the soil particles; that is, causes them to gather into little groups with larger spaces between these groups.

The sandy soils and those containing a liberal amount of sand are less affected by rains, are more easy of cultivation and do not call for as great precautions in their tillage. Such soils when wet do not adhere to cultural implements and the feet of animals as do the heavy soils, and the roads made of such soil are often as good or better immediately after rains than they are when in a dry condition.

Texture Affects Crop Adaptation.—Heavy clay soils and those containing large amounts of silt are generally best adapted to the grasses such as timothy, blue grass, orchard grass and redtop, and to wheat, rye and what is commonly known as the heavy truck crops, such as cabbage, tomatoes and asparagus. The soils known as loam, which are of medium texture, are better adapted to such crops as corn, oats, barley, buckwheat, peas, beans, clover and potatoes. The soils of light texture, known as fine sand and sandy loams, are also well adapted to potatoes, beets and all tuber and root crops, and are also extensively used for the early truck crops, such as spinach, lettuce, early potatoes, early peas, etc. Some of the very lightest sands, such as are found in certain parts of Florida, are especially adapted to the growing of pineapples. In general, the pomaceous fruits, such as apples and pears, will do well on fairly heavy soils,

while the stone fruits, such as peaches, cherries and plums, succeed better on soils that are lighter in texture and better drained. In fact, peaches will often succeed admirably on shaly ridges and mountains in the Piedmont Plateau.

Texture Affects Tillage.—Soil texture so influences the cost of tillage that it often determines the crop to be grown. Crops that require a great deal of tillage and hand work, such as sugar beets, are more economically



THE EASE OF SEED-BED PREPARATION DEPENDS ON CONDITION OF SOIL.¹

grown on soils of light texture, because of the greater ease of weeding and tillage. Even though these light soils under intensive cultivation may require considerable expenditure for fertilizers, the additional cost thus entailed is generally more than offset by the saving in labor.

Structure of the Soil.—The structure of the soil pertains to the arrangement of the soil particles within the body of the soil in much the same way that the arrangement of the bricks in a building determines the style of architecture. In all soils of fine texture it is good soil management to strive to obtain a granular structure. This consists of a grouping of the soil particles into small groups or granules. A good illustration of

¹ Courtesy of Doubleday, Page & Co., Garden City, N. Y. From "Soils," by Fletcher.

a granular structure is found in what is known as buckshot land. Such a soil when plowed breaks up into small cubical fragments an eighth of an inch to a quarter of an inch in size. The granular structure facilitates the circulation of the air and soil moisture, permits easier penetration by plant roots and lessens the difficulty of cultivation.

Granular Structure.—The granular structure may be improved by tillage. Every time the soil is plowed, cultivated, disked or harrowed, it is pulverized and broken up into particles, each formed of a larger or smaller number of grains. Granular structure is also improved by good drainage. When the body of the soil is saturated or completely filled with water the soil particles move with little resistance and tend to arrange themselves into a compact mass. This fact is taken advantage of in filling excavations, and when the soil is returned to the excavation water is turned into it in order that it may settle compactly, so that when once filled no depression will occur at the surface. Soils that are thoroughly underdrained seldom, if ever, become saturated, so that there is no opportunity for the soil particles to arrange themselves in this compact mass. Consequently, a soil of this character when once drained gradually assumes the granular structure through plowing and cultivation, together with the penetration of the roots of the plants and the work of insects and worms. This is further facilitated by the thorough drying of the soil in periods of prolonged drought.

The process of alternate freezing and thawing also has an influence on structure. As the water in the soil solidifies it expands and causes an elevation of the soil, making it more porous. As it thaws and the water again becomes liquid the soil does not fully return to its original position, and consequently its tilth is improved.

Granulation Improved by Organic Matter.—Granular structure is also improved by the addition of organic matter to the soil either as barnyard manure or the residues of crops turned under. The organic matter incorporated with the soil occupies spaces that would otherwise be occupied by soil particles, and upon its gradual decay it leaves small cavities which separate small groups of soil particles. Plant roots are also influential in improving the structure of the soil, first, by an actual moving of the soil particles due to the enlargement of the roots as they grow; and, second, by the gradual decay of these roots, which leaves minute channels in the soil through which air and water find free passage. Earthworms open channels of considerable depth, and also incorporate in the soil the organic matter upon which they live.

Good Tilth Important.—It is common to speak of the soil as having a good or poor tilth. A soil in good tilth means that it is in good physical condition, or that it has a granular structure that makes it the best possible home for the plants to which it is adapted. The degree of granulation desired will be determined to considerable extent by the character of crop that is planted. Corn and potatoes, demanding a rather open

soil, call for a loose seed-bed in which granular structure is accentuated. Wheat, rye, clover and the grasses, on the other hand, demand a rather compact, fine-grained seed-bed, and, therefore, do not demand an equal degree of granulation.

Solubility of Soil Minerals.—Plants take their mineral food only when it is in solution. This necessitates a degree of solubility of the essential plant food minerals that will meet the maximum needs of the plants. The solubility of the soil particles depends upon a number of factors, and is a rather complex process. In pure water the solubility is very slight, but as the water of the soil becomes impregnated with carbonic acid gas, organic compounds and mineral compounds, these all exert an influence on the degree of solubility of other mineral constituents. Solubility is also markedly influenced by temperature. This fact is well recognized by the housewife, who by heating dissolves sugar in water until it becomes a syrup; so the solubility of the soil minerals is increased by a rise in soil temperature.

Rate of Solubility Depends on Texture and Kind of Minerals.—The rate of solubility is approximately in proportion to the surface of the particles on which the solvent acts. Consequently, we find as a rule larger amounts of plant food in solution in soils of fine texture than we do in soils that are coarse in texture. This doubtless accounts for the practice of the more extensive use of fertilizers on sandy soils. It is also true that the different minerals have varying degrees of solubility, some being far more soluble than others. The limestone particles in a soil mass are much more readily soluble than the quartz, and, consequently, lime disappears from the soil. Plant roots also have an influence upon solubility by means of certain excreta given off by the roots. Since, therefore, carbon dioxide, organic compounds and plant roots increase the solubility of the soil particles, it is plain to be seen that the incorporation of organic manures with the soil and the production of good crops tend always towards a more productive soil, except in so far as the minerals of the soil are exhausted through plant removal.

Soil Bacteria Increase Solubility.—The bacteria of the soil are also instrumental in increasing the solubility of the soil minerals. Since, for their greatest activity, bacteria require proper sanitary conditions, such as aeration, a neutral soil medium and organic matter as their food, it will be seen that fertile soils encourage increased numbers of bacteria, which in turn make for increased fertility. It is, therefore, essential for the tiller of the soil to understand the various factors which enter into soil productivity, and to perform his part in encouraging the development of those which are beneficial and discouraging those which may be destructive.

Rapid Solubility Results in Loss of Fertility.—The rate of the solution of soil minerals should not far exceed the needs of the crops grown, lest there be an unnecessary loss of plant food through leaching and the con-

sequent hastening of the impoverishment of the soil. Except in very sandy soils, in the practice of bare fallowing of soils, and in the Southern states where land is left without cover-crops, there is very little danger, however, in this regard.

Chemical Composition of Soils.—The soil has long been an intricate problem for the chemist. Many years of research have been spent in an endeavor to determine through chemical analysis not only the composition of the soil but its power to produce crops and its need for fertilizers. The chemist has little difficulty in determining the absolute amounts of the essential plant food constituents in the soil, although the process is rather long, tedious and costly. Unfortunately, such analyses seldom indicate the relative fertility of different soils, and tell us comparatively little as to the present fertilizer needs of them. The chemist has also endeavored to devise methods of analysis that will determine the amounts of available plant food present in the soil. For this he has used different solvents of varying concentrations in an endeavor to imitate the plant in its extraction of the elements from the soil. So far, however, such methods have met with comparatively little success, and we are, therefore, obliged to conclude that, as a rule, a chemical analysis of the soil is of very little help to the farmer. This statement admits of certain exceptions. If the analyst finds that the total potash or phosphorus content of a soil is very small, it at once indicates that this soil is either immediately in need of the deficient element or soon will become so. It is also true that, when the physical conditions of the soil are good, the drainage satisfactory and unusually large amounts of the essential elements are present, the soils are, or may easily be made, productive without the addition of plant food.

The above statements should not be construed to mean that the chemist should cease to put forth his best efforts in the solution of unsolved soil problems; but in its present status, it is not worth while for the farmer to ask for a complete chemical analysis of his soil, or to go to the expense of having a commercial chemist make such an analysis for him. Chemical analyses are useful and helpful to the scientist and soil expert, and are to be encouraged as a help in the advancement of our knowledge of soils.

Availability Important.—In the majority of cases it is important that the farmer know how to increase the availability of plant food in the soil. This question has been partly analyzed in the preceding topic on solubility of soil minerals. In general, however, the farmer may increase availability by deep plowing, thorough tillage, the incorporation of organic matter and soil drainage. The best measure of soil fertility or available plant food is the growth that plants make upon any particular soil. Not only is the degree of growth an indication of fertility, but likewise the color of the plants, the manner of growth and the proportion of vegetative parts to seeds or fruits are often indicative of the presence or

absence of particular elements. The first essential to profitable crops is the production of a healthy and vigorous plant. Added to this is a high degree of fruitfulness. A deficiency in phosphorus may not prevent a satisfactory development of the plant, but may seriously curtail the production of seed. This is often illustrated in the case of wheat which makes a rank growth of straw and a comparatively small yield of wheat. The absence of available nitrogen is often indicated by the yellow color of the foliage.

The form in which the elements are combined may influence the quality of the product. This is illustrated in tobacco when the application of muriate of potash causes a poor burning quality of the leaf that is to be used for cigars. Better results with a cigar tobacco are secured when the potash is applied in the form of sulphate or carbonate. Furthermore, the essential plant food constituents dominate in the development of certain parts of the plant or in the performance of certain vegetative functions. For example, potash is believed to be largely instrumental in the development of starch, and fertilizers for starch-producing plants, such as potatoes, generally contain a high percentage of potash. It is believed also that the color of fruits is controlled to a certain extent by the presence or absence of certain essential elements, such as potash or iron.

Elements Essential to Plants.—The essential elements of plant food may be grouped as follows: First, those obtained from air and water, consisting of oxygen, hydrogen and carbon; second, those constituents that are frequently deficient in soils and are supplied through the use of commercial fertilizers, namely, nitrogen, phosphorus and potassium; the third group is not likely to be deficient as elements of plant food. These consist of calcium, magnesium, sulphur and iron. In this group calcium and magnesium in the carbonate form may become so deficient that soils become sour, in which case the practice of applying lime is advisable. The five other elements commonly present and fitting into a fourth group are silicon, aluminum, sodium, chlorine and manganese.

Soil Bacteria.—Bacteria are microscopic plants. They are composed chiefly of protoplasm, and differ from higher plants in that they contain no chlorophyll. Bacteria are generally single-celled, and they are so small that it would require about one and one-half millions brought together in a mass in order to be visible to the naked eye. These small plants are omnipresent. Soils are teeming with millions upon millions of them. They are present in the air and in the water of the lakes and rivers, and occur on all vegetation and are present in the foods we eat. These minute organisms were unknown until the high power microscope was invented a comparatively short time ago. They play a very important part in all life processes. More than a thousand species of bacteria have already been identified and described, and new species are being discovered every day.

Bacteria Make Plant Food Available.—The bacteria of the soil are

of great importance in preparing plant food for our ordinary farm, garden and orchard crops. They are instrumental in making nitrogen available for higher plants. They also bring about availability of the mineral constituents of the soil. It is essential for the farmer to understand that the bacterial flora of the soil is important, and that the multiplication of these bacteria is generally to be encouraged. It is also well to know that there are two great classes of bacteria: first, those that thrive best in the presence of plenty of air, from which they obtain oxygen; and second, those that thrive best with little air and even in the total absence of oxygen. These classes are spoken of as aerobic and anaerobic bacteria, respectively. The first class, or those thriving best with plenty of air, are made up generally of the beneficial forms, and these dominate in the more productive soils. They require for their life and rapid multiplication food in the form of organic matter, although many forms live directly on the mineral elements of the soil. They need moisture and are dormant or may die when the soil remains long in a very dry condition. They must have air and this is facilitated by the tillage of the soil.

Nitrogen Increased by Bacteria.—Soil bacteria have no greater function in soils than the conversion of organic nitrogen into ammonia, nitrites, and finally nitrates, thus making the nitrogen available for higher plants. Nitrogen is the most expensive element that farmers have to purchase in a commercial form. It costs about twenty cents per pound, or three times as much as granulated sugar. Nitrogen is present in the air in great quantities, and it is chiefly through various forms of bacteria that the higher plants are able to secure the necessary supply. Among the bacteria instrumental in this process are the numerous species that are found in the nodules on the roots of the various leguminous crops. For ages legumes, such as clovers, have been recognized as beneficial to the soil, as shown by the increased growth of the non-leguminous crops that follow. Not until the discovery of these bacteria in the nodules on the roots of legumes (about one-fourth century ago) was it understood why legumes were beneficial.

The species of bacteria that occur in the nodules on the roots of one leguminous crop is generally different from that occurring on a different leguminous crop, although there are a few exceptions to this rule. The same species of bacteria occur on the roots of both alfalfa and sweet clover, but a different species is characteristic of red clover, and one species cannot be successfully substituted for another. It is, therefore, essential to use the right species when attempting to inoculate soil artificially for a particular leguminous crop. The different species of bacteria for the leguminous crops will be discussed under each of those crops in chapters which follow.

There are also species of bacteria living in the soil, not dependent directly upon legumes, which have the power of abstracting free nitrogen from the air and converting it into forms available for general farm crops.

Bacteria Abundant Near Surface.—The soil bacteria are most abundant in the plowed portion of the soil. Their numbers greatly diminish as the depth increases, and disappear entirely at a depth of a few feet. It is generally believed that direct sunshine is destructive to practically all forms of bacteria. Consequently, we find few living bacteria immediately at the surface of a dry soil. In the practice of inoculating soils, therefore, it is recommended that the bacteria be distributed on a cloudy day or in the morning or evening when there is little sunshine, and that the inoculation be at once thoroughly mixed with the soil, by disking or harrowing.

Barnyard manures are always teeming with myriads of bacteria, and the practice of applying such manure adds many bacteria to the soil. Bacteria are most active during the warmer portions of the year, and most of them are dormant when the temperature of the soil falls below the freezing point. Those instrumental in nitrification are very inactive when the soil is cold and wet and become exceedingly active in mid-summer when the temperature of the soil is comparatively high, when plant growth in general is most active and when nitrogen is most needed by growing crops. This is a fortunate coincidence, since it enables the higher plants to utilize the nitrates made available at that particular season by bacteria. If nitrification through the bacteria were equally rapid during periods when farm crops made little growth, a great loss of nitrogen would occur through leaching of the soil. The freezing of the soil does not destroy bacteria, as a rule, but simply causes them to be temporarily dormant.

REFERENCE

“The Soil.” Hall.

CHAPTER 3

FERTILITY AND HOW TO MAINTAIN

Fertility Defined.—The fertility of a soil is measured by its capacity to produce an abundant growth of the crops to which the soil and climate of the region are adapted. Fertility is not dependent upon a single factor, but requires the presence and co-ordination of a number of factors acting in unison. The fertility of the soil is, therefore, dependent, first, upon the presence of a sufficient supply of the necessary plant-food elements in an available form; second, upon an adequate water supply to convey these elements in solution to the roots of the plants; third, upon sufficient warmth to promote plant growth; fourth, upon the presence of sufficient air to meet the needs of the roots for oxygen. A fertile soil will, therefore, generally consist of the ordinary soil minerals reduced to a fine state of subdivision, incorporated with more or less organic matter, and containing a sufficient supply of air, water and soil bacteria.

Vegetation an Index to Fertility.—The best index to soil fertility is the growth and condition of plants produced by the soil. On a virgin soil, either in timbered regions or on the prairies, the species of plants and their conditions of growth have long been recognized as indications of the character and value of the soil. In general, such trees as apple, ash, basswood, black walnut, burr oak, crab-apple, hard maple, hickory and wild plum, are indicative of good soil. On the other hand, where beech, chestnut, hemlock, pine or spruce dominates the forest growth, the soils are likely to be comparatively poor. White oak and beech are frequently found growing together in considerable abundance. If the white oak predominates the soil may be considered fairly good, but if beech predominates it may be looked upon with suspicion, and will probably prove to be a poor soil.

Herbaceous plants in the same manner are a good indication of the fertility of the soil. For example, in regions where alfalfa, Canada thistle, bindweed, clover, corn, cockle-burr, Kentucky blue grass, quack grass, ragweed and wheat grow well, the soils are generally found to be fertile. On the other hand, the predominance of buckwheat, Canada blue grass, the daisy, five-finger, oats, paint-brush, potatoes, redtop, rye, sorrel and wild carrot, indicate soils relatively poor.

In general, legumes indicate a good soil, although in case of the wild legumes there are some exceptions to this. Soils on which the grasses predominate are generally better than those given over largely to the growth of sedges. The sedges in general indicate wet soils. Golden-rod is a common weed having a wide habitat. It grows on both poor and

good soils. The character of growth of this plant will suggest whether or not the soil is good or poor. On good soil it will have a rank and vigorous growth. The same may be true with other plants, but where nature is allowed to run her course and the law of "the survival of the fittest" has free sway, those plants naturally best adapted to the region are the ones which will ultimately predominate.

It should not be understood that any one species of plant should be relied upon to indicate whether or not a soil is good or poor, but when one takes into consideration all the vegetation present, one can then judge quite accurately as to the relative strength or fertility of the soil.

Drainage Reflected in Character of Vegetation.—The condition of the soil with reference to drainage is, of course, a modifying factor. Swamp soils, for example, are adapted only to those plants that can grow in the presence of an excess of moisture. So long as soils are in a swampy condition they are unsuited to agricultural crops, and in that condition may be considered unproductive. A good system of artificial drainage may change the whole aspect and cause them to be transformed into highly productive farm soils. Indeed, the establishment of a drainage system under such conditions would ultimately cause the disappearance of the native vegetation and encourage the encroachment of an entirely different set of plants. Then, again, climate is a modifying factor, and certain plants are found in regions of continuous warm climate that are not found where cold winters prevail.

Lime Content and Acidity Related to Plants.—The predominance of chestnut trees as above indicated suggests a poor soil and one low in lime content. Chestnut trees are not found on limestone soils, and the limestone soils in general are considered among the most fertile. Such plants as the huckleberry, blueberry, cranberry and wintergreen are seldom found on soils well supplied with lime. Redtop, while often indicative of a poor soil, will grow luxuriantly on a fertile soil. It is also very tolerant of soil acidity and an excess of moisture. It has a wide adaptation and is often grown as a hay crop on poor soils.

The presence of an abundance of sorrel, plantain and moss in cultivated fields is indicative of the condition of the soil, although it may have no relation to the soluble plant food present. Such plants generally indicate an acid soil, and call for the application of lime to encourage the growth of clover. Sorrel, like clover, is generally benefited by lime, but it is more tolerant of soil acidity than clover, and on an acid soil the clover disappears and the sorrel takes its place. Red clover is less tolerant of soil acidity than alsike clover. Many farmers make it a practice to mix these two species of clover. On neutral soils the red clover will always dominate and the alsike will scarcely be noticeable. But if the acidity of the soil approaches the limit for red clover, then the alsike will predominate, and this predomination is very noticeable when the crop comes into blossom.

Vegetation and Alkali.—In the irrigation districts of the semi-arid regions of the United States the character of vegetation often enables one to determine at a glance whether or not the soils are too alkaline for the production of staple crops. This fact is taken advantage of and serves as a great aid to the soil expert in the mapping of alkali soils. The predominance of sage bushes and rabbit's foot indicates freedom from alkali, while such plants as greasewood, mutton sass and salt grasses show at once that the soils are highly impregnated with alkali salts.

Color of Soils Related to Fertility.—Another index to soil fertility is the color of the soil. It cannot always be explained just why a certain color is indicative of fertility or otherwise, but there seems to be a comparatively consistent relationship between color and degree of fertility. Nearly all black soils are fertile, while those that are of an ashy hue or have a yellowish cast are generally poor. The chocolate-colored soils, the red soils and those of a brown color are, as a rule, fairly fertile. The farmer, as well as the soil expert, soon learns that color is a good index relative to soil fertility.

It is wise, however, to look further than merely on the surface of the soil or the character of the vegetation. Subsoil is also very important in connection with fertility. There are regions where the surface soil is black and where the subsoil immediately beneath is of a light-colored, tenacious clay, so nearly hardpan that the soils are not productive for any considerable range of general farm crops, although they may be well adapted to grass.

Maintenance of Fertility.—Soils are permanent. They constitute the most important asset of the nation. Their maintenance through rational systems of farming is essential. Nature has made for increased soil fertility, but unfortunately the occupation of the soil by man has often resulted in soil robbery and a decline in productivity. This serious fault should be remedied.

Fertility Lost by Plant Removal.—Loss of soil fertility by plant removal is legitimate. Such loss must ultimately be replaced, either by the return of the residues of crops thus removed in the form of unused portions or by-products and the excreta of the animals that consume the crops, or by the purchase of the different elements in commercial fertilizers. In rational systems of farming the removal of plant food through the removal of crops is not to be considered undesirable, and such removal should result in sufficient profits to enable the soil loss to be replaced at a cost less than the profits received through the crops grown. In the preceding chapter we found that of the mineral elements potassium and phosphorus are the only ones likely to become exhausted to such a degree as to necessitate replacement. As a matter of fact, potash occurs in large quantities in most soils, and the problem of the future seems to be largely the adoption of methods that will bring about its availability. Many soils, however, contain phosphorus in such small amounts that in a short

time the supply will be so nearly exhausted as to necessitate the return of this element to the soil in some commercial form. In some soils it is already necessary for most profitable crop production.

Loss by Erosion.—The loss of soil fertility by erosion is more serious than the loss by plant removal. In this way there is not only a loss of plant food but a loss of a portion of the soil body itself. The millions of tons of finest soil particles and organic matter carried annually to the ocean by the rivers of the United States are a monument to careless soil management. This waste may be witnessed everywhere. The removal of the most fertile part of the soil is not only a loss to the soil, but is often a menace to navigable streams which are filled up with this material. An enormous expenditure on the part of our national government is necessary in dredging them out and making them again navigable. This erosion also becomes a menace to our great city water supplies, necessitating expensive filter plants to remove the suspended matter and purify the water. It also frequently does damage to other land subject to overflow, and on which the deposits may be left.

The great problem, therefore, seems to be the control of the rain that falls upon the land. A portion of this may pass over the surface, carrying with it small amounts of the surface, which in the course of time has been largely exhausted of plant-food elements. This loss should be accompanied by a renewal of the soil from below. The addition of new soil below should keep pace with the removal from the surface if permanent soil fertility is to be maintained. The remainder of the rainfall should find its way into the soil. A portion of this may pass off into the drainage waters, removing certain soluble material that without such drainage might accumulate in the course of centuries to the detriment of plant growth. Another portion should return to the surface, bringing with it the soluble constituents of the soil and leaving them near the surface for the use of growing plants.

Preventing Soil Erosion.—Water escaping from the soil by means of underdrainage never carries with it any of the soil material other than the slight portions that are soluble. It is, therefore, essential to establish systems of farming that will enable a large proportion of the rainfall to penetrate the soil; and to remove the excess of water by underdrainage when nature fails to provide such a system. Erosion may be largely prevented on most farms by deep plowing and by keeping the soil covered as much as possible with growing crops or their remains. Deep plowing encourages an increased penetration of the rainfall and, therefore, reduces the amount passing over the surface of the soil. The presence of growing plants retards the movement of surface water and holds back the soil particles. An abundance of roots in the soil helps to hold it together and prevent erosion. The application of barnyard and green manures also retards erosion. In some places terracing the soil to prevent erosion becomes necessary, but it is a costly and cumbersome method

and not to be recommended where other and cheaper methods can be used.

Lands that are steep and subject to erosion should be kept covered with vegetation as fully as possible. Such lands should not be plowed in the fall and allowed to lie bare through the winter.

Farming Systems that Maintain Fertility.—Systems of farming which provide for a return of the largest possible proportion of the plant-food constituents removed in crops are those that most easily maintain the fertility of the soil. It is, therefore, evident that livestock farming in general is least exhaustive of soil fertility, provided the excreta of the animals are carefully saved and returned to the soil. In the rearing of animals for meat, about ninety per cent of the plant food consumed by the animals is voided in the liquid and solid excreta. If this is carefully saved and returned to the soil, depletion of soil fertility will be exceedingly slow.

In dairy farming, where the milk is sold, a somewhat larger proportion of the plant food elements is sold from the farm. Even here the total amount is relatively small, and may be offset by the plant food in concentrates purchased for the dairy. If the milk is fed to pigs and calves and only the butter is sold, the exhaustion in the long run will be no greater than in meat production. It is, therefore, evident that the type of farming is closely related to the maintenance of soil fertility, and those types which permit a maximum sale of cash crops cause the largest direct removal of plant food from the farm. All types of livestock farming, therefore, come closest to maintaining permanent fertility.

In new countries it is not an uncommon practice for farmers to dump the manure from stables into a nearby stream in order to get rid of it. It is also a common practice to burn stacks of straw and the stubble of the field in order that the soil may be freed of rubbish and easily plowed and cultivated. Such practices are to be condemned, for in the long run they encourage soil depletion. Where land is cheap and fertile and labor expensive, the immediate returns from applying manure may not justify the cost of its application, but in a long term of years it will prove profitable. A farmer should be far-sighted enough to calculate what the result will be in the course of a lifetime. There should be more profit in the removal of fifty crops in as many years where fertility has been maintained or increased, and where the crop yields have increased, than there is in the removal of fifty crops with a constantly decreasing yield. In the first case the land is left in good condition for the succeeding generation; in the second case, in bad condition.

Deep Plowing Advisable.—Fertility of the soil is generally improved by increasing the depth of plowing. It is a common observation that in regions of good farming where farmers are prosperous, the soil is generally plowed to a depth of seven to ten inches. In many portions of the South we find the one-mule plow that barely skims the surface of the soil, and

accompanying this we have the unsuccessful farmer. Plowing is an expensive operation. It is estimated that the power required annually to plow the farm land of the United States exceeds that used in the operation of all the mills and factories in the country.

There is a limit to the profitable depth of plowing, and numerous experiments indicate that it is seldom profitable to plow deeper than eight to ten inches. There doubtless are some exceptions to this found in case of the production of intensive crops or the occasional deep plowing for the preparation of a deep-rooted crop like trees or alfalfa. Deep plowing increases fertility by increasing the area of pulverized soil in which the roots of the plants find pasturage. Such plowing increases the aeration of the soil, encourages the multiplication of bacteria to a greater depth in the soil, and results in increased availability of plant food. Deep plowing also incorporates the organic matter applied as manure or as the stubble of the preceding crop in a deeper stratum of soil, thus increasing its water-holding capacity. Deep plowing also increases the penetration of rainfall and provides for greater storage of it. This provides a larger water supply for the growing crops in periods of drought.

Tillage is Manure.—Cultivation of the soil, and especially the intertillage of crops, such as corn, potatoes and truck crops, aids in maintaining fertility: first, by conserving soil moisture; second, by more thorough aeration of the soil; third, by a fuller incorporation and distribution of the organic matter with the mineral matter; and fourth, by the destruction of weeds which consume plant food and water to the detriment of the crop grown.

Rotations are Helpful.—Crop rotations also help to maintain fertility. By means of rotating crops the soil may be occupied for longer periods of time than when one crop is planted year after year on the same soil. The roots of different crops, having very different habits, occupy somewhat different zones in the soil. A shallow-rooted crop may be advantageously followed by a deep-rooted one. One takes the major portion of its plant food from near the surface and the other from a somewhat lower stratum. All crops do not use mineral constituents in the same proportion. One which demands large amounts of nitrogen may appropriately follow one which has the power of gathering nitrogen from the air. For example, corn appropriately follows clover, the corn benefiting by the nitrogen left in the soil by the roots and stubble of the clover crop.

Rotations Reduce Diseases.—Rotations also make for fertility by checking the epidemics of plant diseases and the depredations of insects. As a rule, a plant disease is common only to one crop and where that one crop is grown year after year on the same soil the disease increases until finally the crop must be abandoned. Many of the insect pests of crops either live permanently in the soil or have but little power of migration. These likewise prey upon certain crops and do not bother others, and the rotation of crops prevents serious injury by them. While these do not

add plant food to the soil, their absence increases the growth of crops, which means the same thing.

Cover-Crops Prevent Loss of Fertility.—Cover- or catch-crops may be grown greatly to the benefit of the soil. Cover-crops consist of any suitable plants occupying the soil when the money crop is not in possession. They make growth during the cool season of the year, take up plant food as it is made available, and hold it in plant form, where it may be returned to the soil when such a crop is plowed under. In this way

it prevents the loss of soil fertility by direct soil leaching and converts mineral plant food into an organic form which upon decay is more readily available than it previously was. Such a crop also adds organic matter to the soil, increasing its power for holding water and being generally beneficial. Good examples of cover-crops are crimson clover or a mixture of rye and winter vetch seeded in corn late in the summer and occupying the

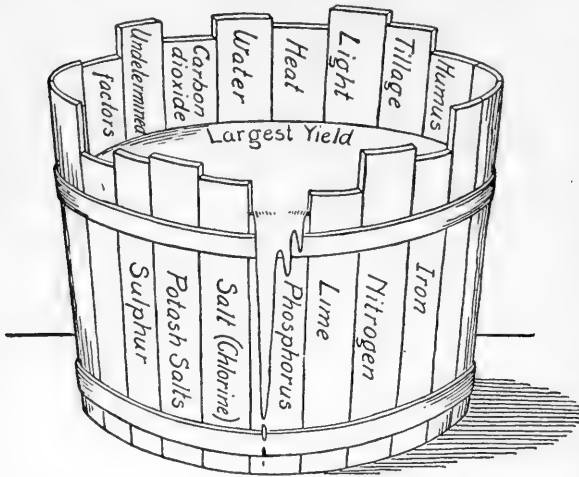

SOIL FERTILITY BARREL.¹

Illustrating the limiting factor in crop production.

soil during the winter. Such crops do not at all interfere with the growth and maturity of the corn. They make most of their growth in the late fall and early spring and may be plowed under in ample time for planting a crop the following year. Such crops are adapted especially to the South, where the winters are mild and freezing of the soil is slight, while erosion and leaching are marked. This practice is quite common with truck farmers, as cover-crops may be seeded after the removal of a truck crop.

Legumes Increase Soil Nitrogen.—Of all the crops instrumental in increasing soil fertility, none equal the legumes, for these alone have the power, through the instrumentality of bacteria residing in the nodules on their roots, to extract free nitrogen from the air. While such crops are richer in protein than the non-legumes, yet at the same time they leave in the roots and stubble a large amount of nitrogen which is available for non-legumes. A crop rotation which does not have at least one leguminous crop every four or five years is decidedly faulty.

¹Courtesy of the Wisconsin Agricultural Experiment Station.

Drainage Increases Fertility.—Fertility is increased by drainage, especially underdrainage, which lowers the water table, increases aeration, and causes plant roots to go deeper in the soil. The amount of plant food that plants can secure is approximately proportionate to the volume of the soil to which they have access. Drainage virtually deepens the soil.

Manure is the Best Fertilizer.—Manures increase fertility by the direct addition of plant food and by increasing the organic matter of the soil. Manures increase the water-holding capacity of the soil, improve its physical condition, introduce various forms of bacteria and encourage the multiplication of desirable bacteria.

Commercial Fertilizers Add Plant Food Only.—Commercial fertilizers increase fertility by the direct addition of the plant food elements they contain, but, as a rule, have very little if any other effect. Commercial fertilizers are expensive and call for an intimate knowledge of the requirements of the soil and the form and availability of the constituents in the fertilizer. The factors above mentioned in relation to soil fertility will be more fully discussed under the several chapters pertaining to them, which follow.

The Limiting Factor.—There is always a limiting factor in crop production, and it is the business of the farmer to ascertain his limiting factor or factors. In many cases the limiting factor in the growth of a crop will be the supply of water. This may be a deficient supply or it may be an excess. If water is the limiting factor it may be due to a low rainfall during the crop season and the low storage capacity of the soil. The farmer has no control over the rainfall, but he should endeavor to increase the water storage capacity of his soil by such means as are economical. Deeper plowing, the addition of organic matter, thorough tillage to conserve soil moisture or the application of water in the form of irrigation are all of them means to such an end. If the limiting factor is due to an excess of water, thus preventing plant growth, the problem becomes one of land drainage and the removal of the water.

The limiting factor may be a deficiency in phosphorus. This being the case, it is important that the farmer know the truth in order that he may supply the deficiency by the application of a phosphatic fertilizer. When the limiting factor or deficiency has been supplied, something else may then become a limiting factor. For example, the limestone soils of Pennsylvania are generally deficient in phosphorus. Such soils, when cropped with a four-year rotation of corn, oats, wheat and mixed clover and timothy, will show a steady decline in crop yields if no manures or fertilizers are applied. Experiments with fertilizers on limestone soil and for the crops mentioned show that when nitrogen alone is applied it has no effect. Potash applied alone is likewise ineffective. When phosphorus is applied there is a marked increase in the yield of crops. Phosphorus, however, will not fully maintain the fertility of the soil. Its yield will

decline, but not so rapidly as when nothing is applied. When the need for phosphorus is met, then potash becomes the limiting factor, and large applications of potash may be used in connection with phosphorus with profitable returns. In this way there will always be a limiting factor in crop production. The farmer should ascertain the limiting factors in his crop production, and then supply them most economically. He may find that there are several limiting factors, and that these will vary from



SOIL FERTILITY PLATS, PENNSYLVANIA AGRICULTURAL EXPERIMENT STATION.

On left, 200 pounds per acre muriate of potash every other year.

In center, dried blood containing 24 pounds nitrogen and dissolved bone-black containing 48 pounds phosphoric acid.

On right, dried blood containing 24 pounds nitrogen, muriate of potash 200 pounds.

time to time; so the problem of soil fertility is a never-ending problem with which the farmer will always have to contend.

Fertility an Economic Problem.—Soil fertility is a problem of far-reaching economic importance. The principal items of expense in general crop production are labor of men and horses, equipment, seeds and land rental. These cost no more for a productive acre than for one of low productivity. In fact, the productive soils are generally plowed and cultivated at less cost of time and energy than those of low productivity. Every hundredweight of product over that required to meet the cost of production is profit.

REFERENCES

- “Conservation of Natural Resources.” Van Hise.
 “Soil Fertility and Permanent Agriculture.” Hopkins.
 “Soil Management.” King.
 “First Principles of Soil Fertility.” Vivian.

- "Soils and Soil Fertility." Whitson and Walston.
 "The Fertility of the Land." Roberts.
 Kentucky Agricultural Expt. Station Bulletin 191. "Teachings of Kentucky Agricultural
 Expt. Station Relative to Soil Fertility."
 Farmers' Bulletins, U. S. Dept. of Agriculture:
 342. "Conservation of Soil Resources."
 406. "Soil Conservation."
 421. "The Control of Blowing Soils."
 446. "The Choice of Crops for Alkali Land."

CHAPTER 4

COMMERCIAL FERTILIZERS

A careful study of the condition of farming in the United States shows that the supply of barnyard and stable manure is not adequate to maintain the fertility of the soil. The need for commercial fertilizers is, therefore, apparent and real, although the amount required in conjunction with natural manures may be comparatively small.

It is desirable to use commercial fertilizers on many farms and the practice is becoming more general each decade. This is but natural, since there is a constant flow of soil fertility towards the cities. The rapid increase in the city population and the consequent increase in food consumption at those points cause a constantly increasing drain upon the soil fertility of the farms.

Object and Use of Commercial Fertilizers.—The object of manuring the soil, whether with stable manure, green manure or commercial fertilizers, is to increase its crop-yielding capacity. In order to justify the practice the resulting increase in products must be more than sufficient to offset the cost of manures or fertilizers applied. This increase need not necessarily be secured the first year after the application, but should be secured in the current and succeeding crops, and should give a net profit on the capital and labor so expended.

The first noteworthy use of commercial fertilizers in the United States was in 1848. In that year there was imported 1000 tons of guano. This was followed the succeeding year by twenty times that quantity. From that date the importation steadily increased until 1880, when it reached its maximum and began to decline because of a failing supply of guano. Other materials, such as sodium nitrate from Chile and the potash salts from Germany, have taken the place of the guano. These, together with the development of our phosphate mines, the use of cottonseed meal and the utilization of slaughter-house by-products, have met the continually increasing demand for commercial fertilizers by our farmers. According to census reports, the expenditures for fertilizers in the United States during the past four census-taking years have been as follows:

Year.	Value.
1879.....	\$28,500,000.00
1889.....	38,500,000.00
1899.....	54,750,000.00
1909.....	112,000,000.00

There seems to be little doubt but that this rate of increase in the use of fertilizers will continue for some time to come. The subject is one

of much economic importance to farmers, and one which has received much time and attention on the part of investigators in the agricultural experiment stations of all the older agricultural states. Agricultural literature now contains a vast amount of data setting forth the results of experiments with fertilizers on different types of soil and for different crops, but there is still much to be learned relative to the subject. We will always have an acute fertilizer problem. This is due to the constantly changing conditions of the soil, resulting primarily from changed agricultural practices and especially from the treatment of the soil, which will gradually change its relationship to crops.

What are Commercial Fertilizers?—In discussing the subject of fertilizers the terms manures, complete and incomplete manures, fertilizers, chemical fertilizers, commercial fertilizers, natural fertilizers, artificial fertilizers, indirect fertilizers, superphosphates, etc., are used, and there is often misunderstanding of the meaning of some of these terms. Fertilizers are first divided into natural and artificial. The former include all the solid and liquid excrement of animals and green manuring crops when plowed under for the benefit of the soil. Artificial fertilizers include all commercial forms of fertilizers. These are sometimes called prepared fertilizers and chemical fertilizers, but are becoming more generally known as commercial fertilizers. A complete fertilizer contains the three essential plant-food constituents, nitrogen, phosphorus and potassium. An incomplete fertilizer contains only one or two of these. All animal manures are complete fertilizers. Green manures are likewise complete.

A fertilizer is said to be indirect when it contains none of the essential plant-food elements, but in some way acts on the soil so as to increase the availability of plant food in the soil or increase crop growth. Lime, gypsum, salt and numerous other substances have been found to have this action and would be classed as indirect fertilizers.

The terms high-grade and low-grade are also applied to fertilizers. These terms, however, are not well defined. High-grade fertilizers generally contain large amounts of plant food per ton, while low-grade fertilizers contain relatively small amounts. Another distinction that is sometimes made is that fertilizers manufactured out of high-grade constituents, such as nitrate of soda, acid phosphate and muriate or sulphate of potash, are considered high-grade fertilizers regardless of the percentage of the elements. A high-grade fertilizer always costs more per ton than a low-grade one, but it is generally true that the elements in such a fertilizer come cheaper to the farmer than they do in a low-grade material. Whether it is more economical to purchase high-grade or low-grade material is an important question, but the answer is not difficult. All fertilizers should be bought on the basis of their content of available plant food, and it is merely a problem in arithmetic to calculate the relative cost of the elements in different grades of fertilizer.

Where are Fertilizers Secured?—Fertilizer materials are to a large

extent gathered from different parts of the world, and are either treated to increase availability or combined into mixed fertilizers before being offered to the farmer. Fortunately the fertilizing element most needed in the soils of the United States and Canada, namely, phosphorus, is secured chiefly from extensive deposits of phosphate rock in Florida, South Carolina and Tennessee and a few other states. This supply is supplemented to some extent by bone phosphate, which comes chiefly from the slaughter-houses of the country; also by basic slag, a by-product of steel manufacture.

The potash salts are secured almost exclusively from the extensive potash mines in Germany. Potash salts come to us in different forms. Most of them have been manipulated and more or less purified. The one most extensively used is known as muriate of potash and is a chloride of potassium (KCl). Sulphate of potash and carbonate of potash are used to a somewhat less extent. In addition to these we have some of the crude potash salts, such as kainite and manure salt. A comparatively new source of potash suitable for commercial fertilizers has been found in the extensive kelp groves in the Pacific Ocean off the coast of the United States and Canada. As yet these have not been extensively used as a commercial source of potash.

Nitrogen is available chiefly in the form of nitrate of soda, which comes from Chile. We also have sulphate of ammonia, an extensive by-product from coke ovens and from the manufacture of artificial gas. As yet the nitrogen escaping from coke ovens is not all transformed into sulphate of ammonia. There are also organic forms of nitrogen, chief of which are cottonseed meal, dried blood, tankage, fish scrap, guano, castor pomace, together with small amounts of horn, hair, feathers and wool waste.

Carriers of Nitrogen.—Nitrate of soda (NaNO_3) contains 15 per cent of nitrogen. It is readily soluble in water, and nitrogen in this form is immediately available for plants. It should be applied in small quantities and not long prior to the time plants most need their nitrogen supply.

Sulphate of ammonia (NH_4)₂SO₄ contains 20 per cent of nitrogen. Like nitrate of soda, it is quick acting, but for most crops the ammonia must first be converted into the nitrate form before it can be utilized. Some crops, however, can utilize ammonia as such. Sulphate of ammonia is not leached from the soil quite as rapidly as nitrate of soda, but nevertheless it should not be applied in larger amounts than are necessary, nor far in advance of the needs of the crop.

Cottonseed meal is another source of nitrogen which is extensively resorted to in the cotton belt. It contains from 3 to 8 per cent of nitrogen, with an average of about 6.8 per cent. It is not wholly a nitrogenous fertilizer, since it also contains an average of 2.9 per cent phosphoric acid and 1.8 per cent potash. The nitrogen in cottonseed meal being in an organic form, is rather slowly available. Availability is gradually

brought about through decomposition. The nitrogen thus resulting is, therefore, distributed through a considerable period of time. It is often used as a part of the nitrogen supply for crops with a long growing season.

Dried blood is also an organic source of nitrogen, containing on an average 10 per cent of this element. It is easily decomposed and somewhat more available than nitrogen in cottonseed meal.

Tankage contains nitrogen in variable quantities, ranging from 5 to 12 per cent. It may also contain from 7 to 20 per cent of phosphoric acid. The nitrogen in tankage is slowly available.

Forms of nitrogen that have more recently found their way into the market are cyanamide and lime nitrate. These are manufactured products in which the nitrogen is secured directly from the air through certain chemical and electrical processes. The nitrogen in these forms is not so available as that in nitrate of soda or sulphate of ammonia, although it is considered more readily available than most of the organic forms.

Phosphorus.—This constituent is available in the form of acid phosphate, which contains 14 to 16 per cent of phosphoric acid or 6 to 7 per cent of phosphorus. Most of the phosphorus is in an available form. Acid phosphate is made by treating a given bulk of finely pulverized phosphate rock with an equal weight of crude commercial sulphuric acid. The reaction that takes place makes the phosphorus available. It is this material that is chiefly used in the manufacture of complete commercial fertilizers. Phosphoric acid costs from four to five cents per pound in acid phosphate, depending on location and size of purchases. (As this goes to press, prices have advanced 25 to 30 per cent. This advance is probably temporary.)

There is now an increased tendency to make direct use of the raw rock phosphate in a finely pulverized form. Such rock contains the equivalent of 28 to 35 per cent of phosphoric acid, but it is in an insoluble form and can be economically used only on soils that are well supplied with organic matter or in conjunction with barnyard or stable manure and green manure crops. The general use of raw rock phosphate has not been advisable on the soils of the eastern and southern part of the United States. On the other hand, the raw rock phosphate has given good results on the prairie soils of Indiana, Illinois, Iowa and some other states. The cost of phosphoric acid in this form is equivalent to two cents per pound or a little less.

Basic slag, sometimes known as Thomas Phosphate, is a by-product of steel mills which is finely ground and used as a source of phosphorus. It is similar to raw rock phosphate, slightly more available and contains the equivalent of 15 to 18 per cent of phosphoric acid.

There are two types of bone meal on the market, raw bone and steamed bone. The raw bone is fresh bone which has been finely ground. Raw bone contains about 20 per cent of phosphoric acid and 4 per cent of nitrogen. Bone which has the fat and gelatin removed by extracting

with steam contains only about 1 per cent of nitrogen and 22 to 23 per cent of phosphoric acid. The steamed bone is more finely ground than the raw bone, and since the fat and gelatin are removed it decomposes more rapidly and is, therefore, more readily available as plant food. While the phosphorus in both forms of bone is largely insoluble, it is nevertheless more readily available than that in rock phosphate.

Potassium.—Muriate of potash (KCl), the chief source of potash, contains the equivalent of about 50 per cent of potash (K_2O). It is the most common purified potash salt, consisting chiefly of potassium chloride. It is a very satisfactory source of potash for all crops excepting tobacco and potatoes. This form, on account of its contents of chlorine, causes a poor burn in tobacco used for smoking purposes. The chlorine is supposed to be slightly detrimental to starch formation, and for this reason the sulphate and carbonate of potash are considered superior for potatoes.

Potassium sulphate also contains the equivalent of 50 per cent of potash (K_2O). Kainite a low-grade material contains about 12 per cent of potash.

Wood ashes are also a source of potash. They contain about 6 per cent of this constituent, together with about 2 per cent of phosphoric acid and a large amount of lime. The availability of the potash in ashes is rated as medium.

Forms of Fertilizer Materials.—It is the common experience of farmers and investigators that the different carriers of nitrogen, phosphorus and potassium behave differently on different soils, in different seasons and with different crops. Most fruit and tobacco growers recognize the difference in the different forms of potash although it is not clearly understood why these differences occur.

Under present fertilizer regulations dealers are required to state only the percentage of the plant-food constituents in the fertilizers they offer for sale. It would be a wise provision if in addition to this they were required to state the source of the constituents as well as the percentage. This is especially important as relates to nitrogen, which varies widely in its availability, depending on its source. Many materials containing essential elements are nearly worthless as sources of plant food because the form is not right. Plants are unable to make use of these materials because they are unavailable. Materials that do not show wide variation in composition and in which the constituents are practically uniform in their action, may be regarded as standard in the sense that they can be depended upon to furnish practically the same amount and form of a constituent wherever secured. Among such standard materials may be considered nitrate of soda, sulphate of ammonia, acid phosphate, muriate of potash, sulphate of potash and carbonate of potash.

Relative Value of Fertilizer Ingredients.—A practical point, and one of importance to the farmer, is a reliable estimate of the relative value and usefulness of the various products that enter into commercial fertil-

izers. The relative rate of availability of a constituent in one carrier as compared with its availability in another is the point at issue. This determines the advantage or disadvantage of purchasing one or the other at ruling market prices. As yet definite relative values for all fertilizing materials have not been worked out. Furthermore, it is recognized that they never can be worked out for conditions in general, because of the wide latitude in the conditions which affect availability. This problem is attacked by what is known as vegetative tests; that is, tests which show the actual amounts of the constituents taken up from various substances by plants when grown under identical conditions. With nitrogenous fertilizers, for example, the results so far obtained indicate that when nitrogen in nitrate of soda is rated at 100 per cent, that in blood and cottonseed meal are equal to about 70 per cent, that in dried and ground fish and hoof meal at 65 per cent, that in bone and tankage at 60 per cent, and for leather and wool waste may range from as low as 2 per cent to as high as 30 per cent.

The Composition of Fertilizers.—In the purchase of mixed fertilizers consumers should demand that they be accompanied by a guarantee. This is essential because the purchaser is unable to determine the kind and proportion of the different materials entering into the mixture, either by its appearance, weight or smell.

At present most of the states have on their statutes, laws regulating the manufacture and sale of commercial fertilizers. These require that the composition be plainly stated on the original packages of fertilizer. The law also provides for the analysis of samples collected at any point and the publication of these analyses either by the state departments or by the state experiment stations. Such publications set forth the name of the brand of fertilizer and the name of the dealer or manufacturer, together with a statement of the analysis as given by the manufacturer as compared with that found by the official analysis. Infringements of the law relative to its provisions call for punishment generally by fines. Under such a system of regulation there is now little danger of the farmer being cheated in the purchase of fertilizers so far as their composition is concerned.

What Analyses of Fertilizers Show.—The difference between a good and inferior fertilizer is shown by a chemical analysis, providing it is carried far enough to show both the amount and form of the constituents present. An analysis of a fertilizer which shows that the nitrogen is present chiefly as nitrates, the phosphorus as acid phosphate and the potash as muriate of potash at once stamps such a fertilizer as being made up of high-grade materials. On the other hand, if the nitrogen is found largely in an organic form and the phosphorus in an insoluble form, it is evident that the materials used are low-grade forms, and result in a slow-acting and sometimes unsatisfactory fertilizer.

Commercial vs. Agricultural Value of Manures.—Agricultural value

and commercial value as applied to fertilizers are not synonymous and should not be confused. The agricultural value is measured by the value of the increase in crops secured through the use of the fertilizer. The commercial value is determined by the trade conditions. It is based upon the composition of the fertilizer and the price per pound of the different forms of the several constituents that enter into it. Commercial value is merely a matter of arithmetic. Agricultural value varies greatly and depends upon a number of factors, among which the knowledge of the farmer plays no small part.

Mechanical Condition.—The mechanical condition of a commercial fertilizer deserves consideration by the farmer. The degree of pulverization controls the rate of solubility to no small extent. The finer the pulverization the more thorough can be the distribution made in the soil. The greater the number of points at which there are particles of fertilizer in the soil, the more rapid will be the solution and the diffusion of the plant-food material. Mechanical condition is also important from the standpoint of distribution through fertilizer drills. The material should be in what is known as a drillable condition. It should not only be thoroughly pulverized, but also should be sufficiently dry to feed through the mechanism of the drill at a uniform rate. Wet, sticky material clogs up the drill and causes faulty distribution.

High-Grade vs. Low-Grade Fertilizers.—Thousands of tons of low-grade fertilizer are bought by farmers because the price is low, when, as a matter of fact, the same money invested in a lesser amount of high-grade fertilizer would have given them better results. Low-grade fertilizers, as a rule, contain varying amounts of filler or inert matter. This sometimes constitutes as much as one-half the weight of the fertilizer. It costs just as much to provide bags and handle this material as it does the more active portion. Furthermore, the farmer pays for the bags and freight on this worthless material. At the same time, he hauls it from the railway station to his farm, unloads it and afterwards applies it to his fields with much more expenditure of time and effort than would be required for a smaller amount of high-grade material containing equally as much plant food.

Use of Fertilizers.—The most economical use of commercial fertilizers is secured only when a systematic crop rotation is practiced and the soil is maintained in good physical condition and well supplied with organic matter and moisture. The soil should contain sufficient lime to prevent the accumulation of acids, so that legumes such as clover will thrive. Every crop rotation should have a suitable legume occurring once every third to fifth year. The presence of legumes will lessen the necessity for nitrogen in the fertilizer. It is estimated that nitrogen can be secured through the growing of legumes at a cost of approximately four cents per pound, whereas it costs fifteen to twenty cents when purchased in a commercial form.

Value of Crop Determines Rate of Fertilization.—Crops are divided into two classes with reference to the use of commercial fertilizers. The first class includes those crops having a comparatively low money value, such as hay and the general grain crops. Because of the low money value it is possible to apply only small amounts of fertilizer profitably. It is also necessary that the crops use as large a proportion of the applied material as possible. The cropping system should be arranged so as to utilize the residues of previous applications. As a rule it is wise to purchase very little nitrogen for such crops, since their needs can generally be met by growing suitable legumes in the rotation. In the temperate climate of the United States and Canada, east of the 100th meridian, red clover is the crop best adapted for this purpose, although there are other clovers and annual legumes that may meet local conditions better. In the southern part of the United States cowpeas, soy beans, Lespedeza clover, crimson clover and some other legumes are best suited for this purpose. West of the Mississippi River alfalfa will pretty fully meet the needs of the soil for nitrogen. Ordinarily it will be grown several years in succession.

Valuable Products Justify Heavy Fertilization.—The second class of crops includes those having a high money value per acre and for which large applications of high-grade fertilizers may be economically used. Among such crops may be mentioned tobacco, cabbage, early peas, spinach, asparagus and even early potatoes. Because of the high money value of these crops a larger investment in fertilizers may be more than paid for, even though the percentage increase in yield is no greater than when fertilizers are applied to crops of low money value. In growing early truck crops, especially when grown along the lower portion of the Atlantic seaboard or in the southern states, the truck farmer who can get his product into the northern markets earliest is the one who receives the fancy prices. Such markets call for products of high quality, and quality in many cases is determined by the rate of growth. In such crops as lettuce, radishes, spinach, etc., succulence and tenderness of the product are essential. These qualities, together with earliness, are often determined not only by the time of planting and the character of soil on which the crops are grown, but also by the character of the fertilizer used. We, therefore, find such farmers using fertilizers that are readily soluble and well supplied with available nitrogen. Nitrogen tends to accelerate vegetative growth and to give quality to early vegetables. It is not unusual to find truck farmers applying as much as a ton per acre of a high-grade fertilizer. The crop grown may use a comparatively small portion of the constituents applied. This calls for a rotation of crops on the part of such a farmer so that other and less valuable crops may follow and be benefited by the residual effect of the fertilizer.

A strict classification of crops into the two classes mentioned is impossible. Conditions which would place a crop in one group in one

locality may place it in the other group in a distant locality. The high price of a crop is in some cases determined by location. For example, the early strawberries and early potatoes of the South that reach northern markets very early are often worth five to ten times as much per unit as are the late strawberries and late potatoes grown in the North and at some distance from markets.

Character of Fertilizer Related to Soil.—In general, fertilizers that stimulate the production of seeds and fruit should be used on rich lands. On poor land the elements that force vegetative growth combined with those that mature fruit may be used. High-grade phosphates in a readily available form hasten maturity and increase the proportion of fruit. This is well illustrated in the fertilizer plats at the Ohio and Pennsylvania Experiment Stations. As the oats and wheat approach maturity on these plats the visitor is at once impressed with the earlier period of ripening of those grown on plats treated with acid phosphate. Nitrogen tends to a prolonged growth of the crop and retards maturity. The grain on the plats treated with liberal applications of nitrogen matures a week or ten days later than on the phosphate-treated plats.

In the use of fertilizers one should distinguish between a large increase of crop and a profitable increase, and this will be determined chiefly by the value of the crop grown. In general there will be an increase in yield accompanying an increase in the amount of fertilizer used, but it is a fact that the first unit of application, that is, the first two hundred or four hundred pounds per acre, will give a relatively larger return than the second or third unit, and there will always be a place where an added unit will give a return, the value of which will be no greater than the cost of the unit of fertilizer. It is most profitable to stop before one reaches this point in the application of fertilizers.

Finally, the purchaser of fertilizers should bear in mind that the composition of the fertilizer and availability of its constituents, its mechanical condition, the economy of its purchase and application are all factors that bear directly upon the economy of its use. This calls for a knowledge of the requirements of the soil and the crops grown.

What the Farmer Should Know.—Commercial fertilizers are valuable mainly because they furnish nitrogen, phosphoric acid and potash. In some cases they may act as stimulants, but their chief function is to supply available plant food. The returns will be approximately in proportion to their content of such constituents, when the selection is so made that it meets the needs of the soil and crops to which applied. The agricultural value of these constituents depends largely upon their chemical form, and these forms must be contained in products of well-defined character and composition. They may be purchased as such from both dealers and manufacturers. The farmer may put them together in proportions to meet his own needs, if he is competent to do so.

The farmer should know the deficiency of the soil on his farm. He

should also know the requirements of the plants with which he deals. He may secure these facts in a general way from the state experiment station, but the details can best be ascertained by actual field tests by the farmer himself on his own farm. Such tests do not necessitate carefully laid out plats of a definite size. Farmers, as a rule, do not have the time and patience to do much experimenting, neither do they have the training, experience and facilities for such work; but any farmer may make a fair comparison of two or more kinds of fertilizers, or he may test the efficiency of any fertilizer ingredient, such as nitrogen, potash or phosphorus, on his soil. This can be done by applying a different character of fertilizer through his fertilizer drill, whether it be attached to the corn planter, the potato planter or to the grain drill, to a definite number of rows running clear through the field. This, if marked at one end of the field by stakes, is easily and readily compared at harvest time with the rows on either side treated with the usual fertilizers or in the usual way. Much can often be determined by observation, but more definite results are obtained by measuring the product of a certain number of rows specially treated, as compared with an equal number adjacent treated in the usual way.

A rapid growth and a dark-green color of foliage indicate the presence of an ample supply of nitrogen in the soil. If the rank growth is accompanied by a watery appearance it suggests a deficiency of phosphoric acid. If plants make a stunted growth under normal conditions of sunshine, temperature and water supply, and mature unduly early, it indicates sufficient phosphoric acid in the soil, and suggests that nitrogen or perhaps potash may materially improve the crop. Potash fertilizers are of special benefit in case of tobacco, beets and the legumes.

The user of commercial fertilizers should place his main dependence upon those that have given him best results. New brands or modified mixtures should be tried on a small scale and in an experimental way until it has been demonstrated that they are better and more economical to use than his old standby. Emphasis should also be placed upon the importance of a systematic use of fertilizers. This can be accomplished through a definite cropping system and a definite scheme of manuring and fertilizing worked out in such a way as best to meet the needs of the soil and crops. It should take into account the fullest possible utilization of the home and local supplies of manure. For example, it is found that the general farm crops in Pennsylvania are most frequently grown in a rotation consisting of corn, oats, wheat and two years of mixed clover and timothy hay. On limestone soils such crops call for a scheme of treatment about as follows: For the corn, 6 to 10 loads of manure per acre should be applied and supplemented with 200 pounds acid phosphate; to the oats following the corn, no fertilizer except when the soil is poor, in which case 150 to 200 pounds per acre of acid phosphate may be used; to the wheat, 350 pounds per acre of acid phosphate, 100 pounds

muriate of potash and 50 pounds of nitrate of soda should be applied; the clover following the wheat calls for no fertilizer, but the timothy during the second year the land is in grass may be profitably treated with a complete fertilizer consisting of 150 pounds of acid phosphate, 150 pounds nitrate of soda and 50 pounds muriate of potash, applied broadcast early in the spring just as the grass starts to grow. Such a scheme of treatment makes a place for all the manure on the average farm and provides for the application of the fertilizer where it will be most fully used and give the largest returns.

A similar scheme of treatment will be found to fit various localities



EFFECT OF TOP DRESSING MEADOWS WITH COMMERCIAL FERTILIZER.

On left, average yield, 2060 pounds cured hay per acre.

On right, average yield, 3637 pounds cured hay per acre.

Grass on right, top dressed early each spring with 350 pounds per acre of 7-7-7 fertilizer. Average of four consecutive years.

in all states. The details will be determined by local conditions, and frequently they have already been worked out for various localities either by the experiment station of the state or by farmers. It is, therefore, important that every farmer become informed on the best practice for his locality.

How to Determine Needs of Soil.—The fertilizer needs of a soil are best determined by applying to the soil and for the crops grown different kinds and combinations of fertilizers. This puts the question directly to the soil, and the crops give the answer by their growth and condition. Such soil tests with fertilizers have proven more practicable and satisfactory than any others thus far devised. A chemical analysis of the soil

is thought by many to enable the farmer or the soil expert to judge as to the character of the fertilizer needed. This, however, is not the case, and such chemical analyses are as a rule of very little help in this respect. The chief difficulty with this method lies in the fact that such analyses do not determine the availability of the plant food present. Another method which is fairly satisfactory is to make pot tests with the soil in question and for the crops to be grown. Such tests may frequently be completed in a shorter period of time than can field tests. They are not, however, so satisfactory as field tests because the crops are not grown under field conditions.

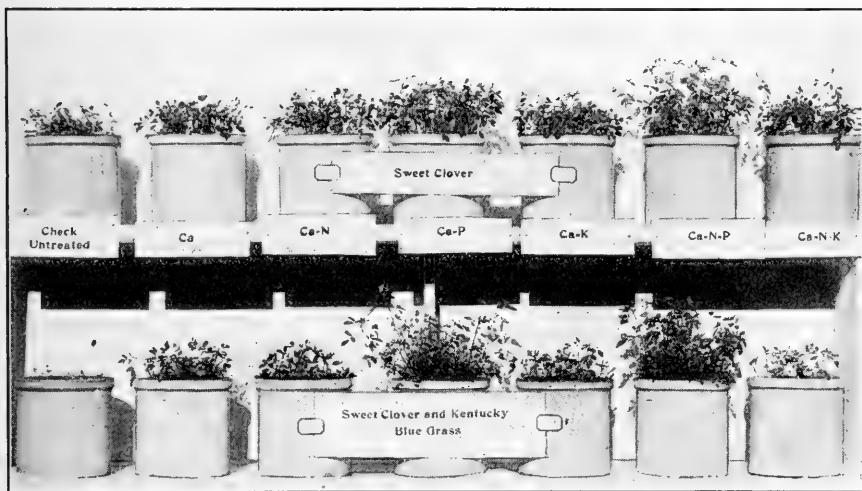

EFFECT OF FERTILIZERS ON THE GROWTH OF SWEET CLOVER.

Soil from virgin cut-over land in Pennsylvania.

Ca—Lime. N—Nitrogen. P—Phosphorus. K—Potash.

Effect Modified by Soil and Crop.—The fertilizer to be used is determined both by the needs of the soil and the crop grown. A commercial fertilizer is beneficial chiefly because of the plant-food elements it supplies. Its best action is accomplished when the soil is in good physical condition and when there is a good supply of moisture and organic matter. The effect of a fertilizer under one set of soil conditions may be reversed when the conditions are materially changed. Under favorable conditions, for example, nitrification in the soil might proceed with sufficient activity to supply a certain crop with all the nitrogen needed for normal growth. The following season being cold and accompanied by an excess of moisture might result in slow nitrification, and this might materially diminish the growth of the crop. In one case nitrogen in a readily available form

would be much more beneficial than in the other. In the same way the results obtained on one farm might not be duplicated on the adjacent farm, although the soil is of the same formation and type, difference in the previous cropping or management of the soil being responsible for the difference in results.

Which is the Best Fertilizer to Use?—This question is a pertinent one, and is often asked by practical farmers. A definite answer can seldom be given. The consumer of fertilizers can best answer it by tests such as above suggested. In a general way, however, the consumer should select those fertilizers which contain the largest amount of plant food in suitable and available forms for the least money. Until a rational scheme of fertilizer treatment has been established it is safest to depend upon high-grade fertilizers used in rather limited amounts. Low-grade materials and elements in slowly available form may prove cheaper for certain soils and crops, but their use involves a larger risk, especially for the farmer who is not well informed on the subject. For soils poor in humus, nitrogenous fertilizers will generally be advisable. For those well supplied with humus, phosphates and potash generally give best results.

Needs of Different Soils.—Since the fertilizer is determined by both soil and crop, the needs of the soil can be determined only in a rather general way. There is no definite statement that will hold under all conditions. A particular soil type in one locality may be greatly benefited by a certain fertilizer, while the same type in another neighborhood may have quite a different requirement.

Heavy soils generally respond to phosphates. Sandy soils are more likely to need potash and nitrogen, while clay soils are generally well supplied with potash. There are some exceptions to this rule.

Experiments at various experiment stations show that soils vary widely in their fertilizer requirements. The results in one locality may be inapplicable in another. Acid soils respond to application of lime and generally to available phosphates. Marshy soils, especially those consisting chiefly of muck or peat, are generally in need of potash and sometimes phosphoric acid and lime. The prairie soils are as a rule deficient in phosphorus, and on such soils the insoluble phosphates are economically used. The need for lime is frequently determined by the failure of clover and the encroachment of sorrel and plantain. Potassium is likely to be needed in soils that have long been exhaustively cropped, especially if hay and straw have been sold from the land as well as the grain.

Crop Requirements.—Crops differ in their fertilizer requirements. This difference is due to the purpose for which the crop is grown, to the length of the growing season required by the crop, and to the period of the season when it makes its chief growth; also to the composition of the crop. It is also influenced by the character of the root systems. Plants which grow quickly generally need their food supply in a readily available

form. Those which grow slowly and take a long time to mature can utilize the more difficultly available forms of plant food. These facts explain why plants differ in their requirements.

Fertilizers for Cereals and Grasses.—The cereals and grasses (Indian corn excepted) are similar in habits of growth and are distinguished by having extensive, fibrous root systems. They require comparatively long periods of growth, and this enables them to extract mineral food from comparatively insoluble sources. As a rule, however, these crops make the major portion of their vegetative growth during the cool part of the growing season. During this period nitrification is comparatively slow; consequently, such crops need readily available nitrogen and respond to fertilizers containing some nitrogen. This demands the application

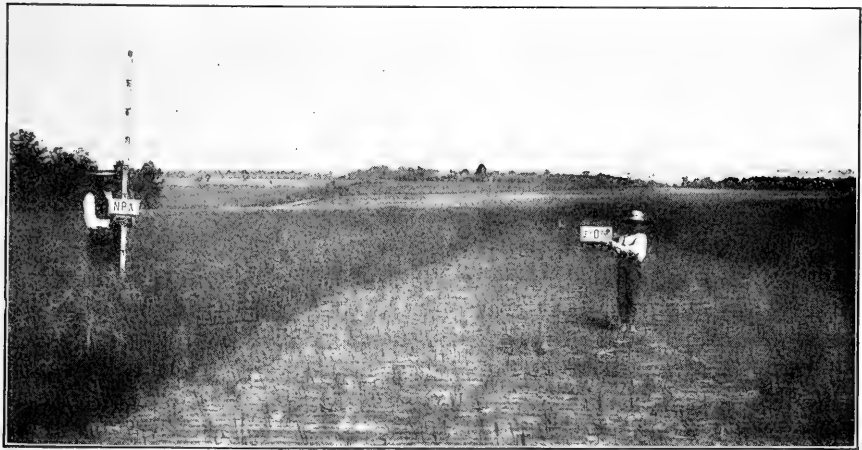

EFFECT OF COMMERCIAL FERTILIZER ON WHEAT ON A POOR SOIL.

A complete fertilizer on the left, no fertilizer in center.

of nitrogen in a readily available form, preferably just at the beginning of vegetative growth in the spring.

Legumes Require No Nitrogen.—The clovers, peas, beans, vetches and in fact nearly all the crops that belong to the family of legumes have the power under proper soil conditions to utilize free nitrogen from the air; consequently, such crops require no nitrogen in the fertilizer. They use relatively more potash than most other forage crops; consequently, the mineral fertilizers with a rather high proportion of potash are generally most beneficial. Corn is a rather gross feeder, and since it makes the major portion of its vegetative growth in the warmer portion of the growing season when nitrification is especially active, it seldom pays to apply much nitrogen to it. Furthermore, corn is able to make use of relatively insoluble phosphorus and potash.

Available Forms Best for Roots.—Root and tuber crops are generally regarded as a class that, because of their habits of growth, are unable to make extensive use of the insoluble minerals; hence, their profitable growth requires plenty of the readily available forms of fertilizing constituents. Nitrogen and potash are especially valuable for mangels and beets, while phosphates and potash together with small amounts of nitrogen are generally used for both white and sweet potatoes.

Slow-Acting Fertilizers Suited to Orchards and Small Fruits.—Orchard trees are as a rule slow growing and do not demand quick-acting fertilizers. In old orchards that are large and are top dressed it may, however, be good practice to use the readily soluble forms of plant food in order that it may be carried into the soil by rainfall and brought in contact with the zones of root activity. Where orchards are manured from the beginning, and especially where they are inter-tilled, barnyard manure and the more difficultly soluble forms of fertilizers may be economically used.

The fertilizer requirements of small fruits are similar to those of orchard fruits. As a rule smaller fruits make a more rapid growth; consequently, heavier applications of soluble fertilizing constituents may be used.

Nitrogen Needed for Vegetables.—The market garden crops, and especially those grown for their vegetative parts, demand rather liberal applications of available nitrogen. The higher the value of the crop per unit of weight, the larger are the applications of nitrogen that may be used economically. In such crops as early cabbage, beets, peas, etc., earliness and quality are of prime importance. To be highly remunerative such crops must be harvested early; in other words, they must be forced. At this period of the year decomposition processes in the soil are not especially active. For this reason an abundance of available nitrogen is demanded.

Fertilizers for Cotton.—Perhaps no crop has been subjected to more experiments with fertilizers than cotton. Cotton is a plant that responds promptly and profitably to judicious fertilization. Such fertilization should hasten the maturity of the crop. This tends to increase the climatic area in which cotton may be grown. In recent years it has become of great importance in connection with the cotton boll weevil. This insect multiplies rapidly throughout the season, its numbers becoming very great in the latter part of the season. It feeds on the cotton bolls. When the bolls are matured early, the insects being less numerous at that season, a larger proportion of the bolls escapes infestation than when they mature late. The most judicious proportions of nitrogen, soluble phosphoric acid and potash in a complete fertilizer for cotton has not been determined with entire accuracy. Those for Georgia are nitrogen 1, potash 1, phosphoric acid $3\frac{1}{2}$; for South Carolina, nitrogen 1, potash $\frac{3}{4}$, phosphoric acid $2\frac{1}{4}$; and for general use nitrogen 1, potash 1, phosphoric acid $2\frac{3}{4}$ or 3 will perhaps approximate reasonable accuracy.

The amount of fertilizer which may be profitably used varies widely with the season, nature of soil and other circumstances. On an average the maximum amounts indicated for Georgia are nitrogen 20 pounds, potash 20 pounds, phosphoric acid 70 pounds; those for South Carolina, nitrogen 20 pounds, potash 15 pounds, phosphoric acid 50 pounds.

Miscellaneous Fertilizer Facts.—Wheat, to which a moderate amount of manure has been applied, will not need additional nitrogen. In most cases the manure can be profitably supplemented with phosphoric acid, and on some soils a small amount of potash may be included. When the wheat field is seeded to clover and grass which is to be left down for hay, the phosphoric acid and potash in the fertilizer should be increased somewhat.

Oats as a rule receive no commercial fertilizer. On soils low in fertility small applications of readily soluble nitrogen and phosphoric acid applied at seeding time are advisable. Winter oats, grown mostly in the South, are generally fertilized with light applications of phosphorus and potash when seeded in the fall, and are top dressed with nitrate of soda in the spring.

For tobacco, barnyard manure occupies a leading position as a fertilizer, both because of its cheapness and effectiveness. When manure is not available in sufficient quantities commercial fertilizers are frequently resorted to. In fact, the manure is often supplemented with commercial fertilizers. This crop generally requires a complete fertilizer. Cottonseed meal is frequently used as a source of nitrogen for tobacco. However, manure is not used for bright tobacco and only very small amounts of cottonseed meal are used.

When nitrogen is required by a crop having a long growing season it is generally advisable to combine it in two forms, one readily available as nitrate of soda or sulphate of ammonia, the other in an organic form, as dried blood or cottonseed meal. Where nitrate of soda is depended upon entirely, two or more applications may be given during the growing season. This is applicable to open, leachy soils, but is not essential on heavy soils.

Effect of Fertilizers on Proportion of Straw to Grain.—The proportion of straw to grain is influenced by season, soil and character of fertilizer. At the Pennsylvania Experiment Station, in a test extending through many years, it was found that for twenty-four different fertilizers applied there were produced 52 pounds of stover for each 70 pounds of ear corn. The average proportion for seven complete fertilizers was 55.4 pounds stover to 70 pounds corn. Barnyard manure gave 47.6 pounds stover to 70 pounds corn, while a complete fertilizer containing dried blood gave 58 pounds stover to 70 pounds corn. In case of oats, the largest relative yield of straw was from barnyard manure. The average for twenty-four different fertilizers was 45 pounds straw per bushel of oats. The average for seven complete fertilizers was 42 pounds straw

per bushel of oats. In general, the proportion of straw will be increased by an abundance of nitrogen, while the proportion of grain will be increased by liberal supplies of phosphoric acid.

This is a matter of considerable practical importance in the growing of both oats and wheat. There is often such a marked tendency for these crops to produce vegetative growth that the straw lodges before maturity. This makes harvesting of the crops with machinery difficult. It smothers out the clover and grasses that are sometimes seeded with them. Lodging also prevents satisfactory filling of the heads of grain and maturing of



SOIL FERTILITY PLATS, PENNSYLVANIA AGRICULTURAL EXPERIMENT STATION.

On left, 320 pounds land plaster.

Center, no fertilizer.

On right, dissolved bone-black, containing 48 pounds phosphoric acid and muriate of potash 200 pounds.

the kernels. A properly balanced fertilizer or the proper proportion of available constituents in the soil for these crops, therefore, is essential.

Principles Governing Profitable Use of Fertilizers.—Definite rules relative to amount and character of fertilizer for soils or crops cannot be laid down, but there are certain principles that should always be taken into consideration in connection with the use of fertilizers. In general, the higher the acre value of the crop grown the larger the amount of fertilizer that can be profitably used. This is a principle that will hold even though the same percentage increase from a definite investment in fertilizer is secured.

Another principle which always holds is that each additional unit of fertilizer gives a smaller increase in crop growth than the preceding one; consequently, the lower the money value of the crop the smaller the

amount of fertilizer that can be profitably used. This principle is well illustrated in an experiment with fertilizers used in different amounts on cotton at the Georgia Experiment Station. In this experiment a fertilizer valued at about \$20 per ton was applied in amounts valued at \$4, \$8 and \$12 per acre respectively. As an average of three years with these applications the increase in lint and seed, respectively, resulting from the applications were valued at \$10.11, \$15.69 and \$21.17, the percentage of profit on the investment in fertilizers being 153, 96 and 76 for the three amounts respectively. These results coincide with the principle above stated. In the above experiment the increase in yield of seed cotton for 400 pounds of fertilizer was 281 pounds. The increase for 800 pounds was not twice 281, which would be 562, but was only 436 pounds. The increase for 1200 pounds was not three times 281, which would equal 843, but was only 588 pounds. The smallest amount of fertilizer produced the largest return on the capital invested in fertilizer, although the largest amount made the largest aggregate profit. In this case each \$4 invested brought a return greater than the actual investment, and it is evident that it might have been possible to add another \$4 worth of fertilizer and still further increase the total profit per acre, although the percentage return on the investment would have been reduced still further. The fertilizer, however, is only part of the investment, since the rent of land and cost of labor and seed are comparatively large items.

If a planter has \$1400 to invest in the growing of cotton and the rent of land, seed, labor and every expense connected with the cost of cultivation and picking aggregated \$28 per acre, he can plant fifty acres. If his profit without fertilizer is \$3 per acre, it will aggregate \$150, or 10 $\frac{2}{3}$ per cent on the investment. On the basis of the above experiment and with the same capital, how much will he be justified in reducing his acreage in order to purchase fertilizers?

By inspection we find:

Acres.	Cost of Growing One Acre.	Total Cost.	Profit per Acre.	Total Profit.	Per Cent on Investment.
50.....	\$28.00	\$1,400.00	\$3.00	\$150.00	10.7
43.75.....	32.00	1,400.00	9.11	398.56	28.4
38.9.....	36.00	1,400.00	10.69	415.84	29.7
35.....	40.00	1,400.00	12.17	425.00	30.3

The increased cost per acre represents the addition of fertilizers to the amount of \$4, \$8 and \$12 and is justified up to the \$12 limit where the maximum profit of \$425 is secured. By growing 35 acres well fertilized, his percentage profit on capital invested is 30 $\frac{1}{3}$ instead of 10 $\frac{2}{3}$ where no fertilizer was to be used.

When to Apply Fertilizers.—The time at which to apply commercial fertilizer will be determined by the needs of the crop, kind of fertilizer,

rate of application, character of soil and subsoil, convenience of the farmer and the economy in applying. Plenty of plant food should be within reach of the plants when growth is rapid. Fertilizers that are readily lost by leaching should not be applied long before needed. Heavy applications may be divided into two or three portions and applied as needed. On heavy soils with retentive subsoils leaching is slight. On sandy soils it may be pronounced. As a rule it will be economy to apply small and moderate applications of fertilizer just prior to or at seeding time. Most planting and drilling machinery is now supplied with fertilizer attachments. These provide for the proper distribution of the fertilizer at the time of seeding or planting without much additional labor. So long as the amount which is distributed in the immediate vicinity of the seed is not sufficient to interfere with germination and early growth, the method is satisfactory. If the concentration of the soil solution in contact with seeds equals the concentration within the cells of the seeds, they will be unable to absorb water from the soil. This may prevent germination and cause the seed to rot. For this reason it is never wise to apply large applications in this way. Such applications should be applied some time in advance of seeding or planting in order that the fertilizers may have become uniformly disseminated through the soil. Another method in common use is to broadcast a portion of the fertilizer and mix it with the soil by harrowing. The remainder is then applied through the fertilizer attachment of the seeding machinery. As previously noted, soluble nitrates may be advantageously applied just at the time when the growing crop is most in need of available nitrogen. This is especially applicable on sandy, leachy soils. So far as danger of loss is concerned, the potash and phosphorus may be applied at almost any time.

Readily soluble fertilizers are preferable for the top dressing of grass land, and should be applied very early in the spring, just as the grass is starting to grow. Early application is necessary because the growth demands it early in the season, and also because the fertilizer must be carried into the soil by rains in order to be brought into contact with the roots.

Organic fertilizers, and especially manure, are best applied some time in advance of seeding. The early stages of decomposition frequently give rise to deleterious compounds. These should have time to disappear before the crop is started.

Methods of Application.—The manner of applying fertilizer depends on a number of conditions, especially the kind of fertilizer, the amount to be used, the character of the crop and the method of its tillage. It is a good practice to distribute the potash and phosphoric acid in that portion of the soil where the root activity of the crop grown is most abundant. In case of inter-tilled crops this will generally be in the lower two-thirds of the plowed portion of the soil. The surface two inches are so frequently cultivated during the early period that roots are destroyed. At other

seasons it is likely to be so dry that roots cannot grow in it. Plant food does little good so long as it remains at the surface. It is not so essential to put the soluble nitrates in this lower zone because there is a great tendency for them to pass downward in the soil.

Where very small applications are used it is often thought advisable to deposit the fertilizer with the seed or plant in order that it may have an abundance of plant food at the very outset. This method stimulates the plant in its early stages of growth. It is probably more applicable to crops that are seeded or planted very early when the ground is cold and bacterial activity is slow.

In the cotton belt there are two methods of applying fertilizers. Experiments at the Georgia Experiment Station have shown that the method known as "bedding on the fertilizer" has given better results than applying the fertilizer through the fertilizer drill at time of seeding cotton. In the first method the fertilizer is distributed over the bottom of a furrow in which the cotton is planted one week or ten days later. The second method deposits the fertilizer in close proximity to the seed at planting time. As an average of four years the per cent profit on the investment in fertilizer was 48 when applied with the seed and 90 when "bedded on the fertilizer."

Purchase of Fertilizers.—The concentrated high-grade fertilizer materials necessarily command a higher price than low-grade materials and those containing small amounts of plant food. As a rule the high-grade materials are the cheapest. The inexperienced farmer is too much inclined to purchase fertilizers chiefly on the ton basis, without regard to the amount or form of plant-food constituents they contain. He should bear in mind that he is not buying mere weight, but that he is paying for one or more of the plant-food constituents, and those fertilizers that are richest in plant food will generally supply these ingredients at the lowest cost per unit. This is obvious from what has been previously said relative to the costs of manufacturing, handling and shipping fertilizers. It is well also to consider the relative economy of retail versus wholesale rates on fertilizers. The more hands a fertilizer passes through the greater will be its cost when it reaches the consumer. Each dealer must of necessity make some profit on his transaction. Small shipments and small consignments call for higher freight rates and additional labor in making out bills and collecting accounts. These all entail increased expense.

There is now an increased tendency on the part of farmers to cooperate in the purchase of fertilizers. As a rule the character of fertilizer that best meets the needs of a farmer in a particular locality will in general be a good fertilizer for his neighbors. It is possible for neighbors to combine and purchase their fertilizers in carload lots directly from the manufacturer, saving the profit of the middleman and getting carload freight rates which will very materially reduce the cost of the fertilizers laid

down at their railway stations. Such co-operation in buying will generally lead to a discussion of the merits of the different brands of fertilizers, and in this way the purchase is generally based upon the combined judgment of the co-operating farmers instead of on an individual farmer. If by chance a diversity of crops and soils of the neighborhood is such that different brands are required, there will be no difficulty in having several brands shipped in the same car.

It is also wise to purchase early and avoid the rush which often causes a delay in shipments in the rush season. Then, too, early orders enable the farmer to plan more definitely relative to his fertilizer needs and give more careful consideration to the brand most likely to meet his needs. In this way he is enabled to receive and haul his fertilizer to his farm at a time when the field work does not demand the time of himself and teams.

It is also well to consider the relative advantages of buying mixed fertilizers as compared with the unmixed goods. In the nature of things the manufacturer with his well-equipped plant should be able to mix fertilizers more thoroughly and economically than the farmer. This, however, is not always done, since the farmer can frequently utilize labor for mixing fertilizers when it would otherwise be unemployed. The advantages of buying unmixed goods are that the farmer can make the mixture that in his judgment will best meet his needs. He may not be able to secure on the market just such a mixture. Furthermore, it will enable him to make different mixtures and try them on his soil and for his crops with the view of gaining information relative to the character of fertilizer that will best meet his future needs.

Home Mixing of Fertilizers.—The home mixing of fertilizers demands on the part of the farmer a fair knowledge of fertilizers and the needs of soils and crops. Without this, he had probably best depend upon ready mixed goods such as are recommended for his conditions. Furthermore, much will depend upon whether or not he can purchase a fertilizer the composition of which, in his judgment, is what he should have, and also whether or not there would be much saving in buying unmixed goods when the additional labor of mixing is taken into account. Such a practice is likely to be economical only when the fertilizers are used rather extensively. Where only a few hundred pounds are used by the farmer it will generally not be advisable for him to attempt to mix his own fertilizer.

So far as the mechanical process is concerned, fertilizers can be mixed by the farmer on the farm very satisfactorily. It does not require a mechanical mixer, although this may be economical when it is done on a large scale. When the unmixed goods are in good mechanical condition, as they should be, definite weights or measures of the different constituents may be placed on a tight barn floor and shoveled over a number of times until the mixture takes on a uniform color. It is advisable to empty not more than 400 to 600 pounds at one time. It can be more thoroughly

mixed in small quantities. A hoe and square-pointed shovel are best suited for the mixing. A broom and an ordinary 2 by 6 foot sand screen with three meshes to the inch are all that are necessary. This assumes that the fertilizer comes in bags of definite weight, and that by putting in one bag of one ingredient and two or three of another, etc., a proper proportion can be secured. Greater exactness can, of course, be obtained by using platform scales and weighing roughly the amounts of the different kinds that are brought together. It is suggested that the most bulky ingredient be placed at the bottom of the pile and the least bulky on top. After it is mixed with a shovel and hoe it should be thrown through the screen. This removes all lumps and perfects the mixing. The lumps, should there be any, should be crushed before they are allowed to go into the next mixing batch. After thorough mixing the material will be ready to return to the bags. It can be hauled to the field when needed.

It is well to remember that most fertilizers absorb moisture, increase in weight and later on dry out and become hard. It is, therefore, wise to keep them in a building which is fairly dry.

The following list of fertilizer materials, together with the percentage of the several ingredients which they contain, is given as an aid to those making home mixtures of fertilizers:

LIST OF MATERIALS USED IN HOME-MIXING OF FERTILIZERS.*

Name of Material.	Nitrogen, per cent.	Phosphoric Acid, per cent.	Potash, per cent.	Availability.
Nitrate of soda.....	15	0	0	Very quick
Sulphate of ammonia.....	20	0	0	Quick
Dried blood.....	10	0	0	Medium
Tankage (meat).....	7.4	10	0	Slow
Tankage (bone).....	5	15	0	Slow
Ground bone.....	2.5	23	0	Slow
Acid phosphate, 14 per cent.....	0	14	0	Quick
Acid phosphate, 12 per cent.....	0	12	0	Quick
Dissolved bone-black.....	0	15	0	Medium
Basic slag.....	0	15	0	Slow
Rock phosphate.....	0	18-30	0	Very slow
Muriate of potash.....	0	0	50	Quick
High-grade sulphate of potash.....	0	0	50	Quick
Kainite.....	0	0	12	Quick
Wood-ashes.....	0	2	6	Medium

REFERENCES

- "Manures and Fertilizers." Wheeler.
 "Fertilizers." Voorhees.
 "Fertilizers and Crops." Van Slyke.
 New York Expt. Station Bulletin 392. "Fertilizer Facts for the Farmer."
 South Carolina Expt. Station Bulletin 182. "Potash."
 Texas Expt. Station Bulletin 167. "Commercial Fertilizers and Their Use."
 Farmers' Bulletins, U. S. Dept. of Agriculture:
 388 "Incompatibles in Fertilizer Mixtures."
 398. "Commercial Fertilizers in the South."

* From the Farmers' Cyclo-pædia.

CHAPTER 5

BARNYARD, STABLE AND GREEN MANURES

Barnyard and stable manure consists of the solid and liquid voidings of the farm animals mixed with various kinds and amounts of bedding. The term stable manure designates manure just as it comes from the stable in its fresh state. Yard manure applies to that which has accumulated or been kept for some time in piles in the barnyard. Fresh manure means that which is only a few hours or, at most, a few days old. The term rotted manure is used to designate that which has gone through considerable fermentation and is more or less disintegrated. The term mixed manure applies to that of the different species of farm animals when brought together in the same manure heap.

Manure an Important Farm Asset.—The manure of farm animals is the most valuable by-product of American farms. Numerous tests and analyses have been made to determine the amount and composition of both the liquid and solid excrements for different classes of farm animals. The average yield of fresh manure and its content of essential plant-food constituents, together with the yearly value of these, is given in the following table for different classes of animals. The calculations in this table are based on the composition of the solid and liquid excrements given in a subsequent table in this chapter. The plant-food constituents are valued as follows: nitrogen eighteen cents a pound, phosphoric acid four cents a pound, potash five cents a pound.

AVERAGE YIELD AND YEARLY VALUE OF FRESH MANURE OF FARM ANIMALS,
EXCLUSIVE OF BEDDING.

Kind of Livestock.	Amount of Manure Yearly, pounds.	Pounds of Ingredients Yearly.			Yearly Value.
		Nitrogen.	Phosphoric Acid.	Potash.	
Cow	28,000	124.	50.	132.	\$30.92
Horse	15,000	96.	42.	81.	23.01
Pig	3,000	14.4	9.54	11.4	3.54
Sheep	1,140	11.02	4.75	9.88	2.67
Poultry	30	.414	.15	.123	.087

The following table gives the numbers of the different classes of farm animals in the United States according to the census of 1910, together with the calculated value of manure for each class, the calculations being based upon the valuation of manure given in the preceding table. In case of cattle, the valuation has been reduced, the reduction being based on the

relative numbers and values of milch cows as compared with all other cattle.

ANIMALS IN THE UNITED STATES IN 1910 AND ESTIMATED VALUE OF THEIR MANURE.

Class.	Number of Animals.	Value of Manure.	
		Per Head.	Total.
Horses.....	27,618,242	\$23.00	\$635,219,566.00
Cattle (all kinds).....	63,682,648	23.00*	1,464,700,904.00
Swine.....	59,473,636	3.54	210,536,671.00
Sheep and goats.....	55,868,543	2.67	149,169,010.00
Poultry.....	295,880,000	.087	25,741,560.00
Total value.....			\$2,485,367,711.00

Manure is valuable because: (1) it contains the three essential elements of plant food, namely, nitrogen, phosphorus and potassium; (2) it furnishes organic matter which is converted into humus in the soil and materially improves the physical condition, water-holding capacity and chemical and bacterial activities in the soil; (3) it introduces beneficial forms of bacteria in the soil and these multiply and become increasingly beneficial as their numbers increase.

As a Source of Plant Food.—The composition of manure varies with the kind of animals producing it, the age of animals and the amount and quality of the feed they consume. The manure consists of the solid excrements and the liquids or urine. These differ in their composition. The urine is the most valuable part of the excreta of animals. The average mixed stable and barnyard manure contains approximately ten pounds nitrogen, six pounds phosphoric acid and eight pounds potash in each ton of manure. The solid portions consist chiefly of the undigested portions of the food consumed, together with the straw or bedding that has been used in the stables. The solid portions contain approximately one-third of the total nitrogen, one-fifth of the total potash and nearly all of the phosphoric acid voided by animals. The urine contains about two-thirds of the total nitrogen, four-fifths of the potash and very little of the phosphoric acid. The elements found in the urine are insoluble. They are not immediately available as food for plants, but become so more quickly than the constituents in the solid portions.

Of the nitrogen in barnyard manure, that in the urine will be most readily available; that in the finely divided matter of the feces will be more slowly available; and that in the bedding will be most slowly available. For this reason the availability of the nitrogen in manure when applied to the soil is distributed throughout a comparatively long period. Availability will vary greatly with the nature and treatment of the manure.

* Estimated value based on relative numbers and values of milch cows and all other kinds of cattle.

Experiments at several experiment stations show that the nitrogen in manure is much less readily available than that in either nitrate of soda or sulphate of ammonia. Because of this fact, barnyard manure when used for certain truck crops is sometimes supplemented with available forms of nitrogen. In such cases it is not advisable to mix the chemical forms of nitrogen with the manure. Such mixture is likely to result in a loss of available nitrogen through denitrification in the manure pile. It is best, therefore, to apply the chemical form of nitrogen by itself, preferably some time after the manure has been applied.

Physical Effect of Manures.—Barnyard and stable manure improves the physical condition of heavy soils by increasing their tilth and making them easier to cultivate. It improves loose, sandy soils by holding the particles together and increasing the water-holding capacity. It, therefore, has the reverse effect on these two extremes of soil.

Manure tends to equalize the supply and distribution of water in the soil and renders the soil less subject to erosion and injury by winds. Experiments conducted by Professor King at the Wisconsin Experiment Station show that manured land contained eighteen tons more water per acre in the upper foot of soil than similar land unmanured, and thirty-four tons more in the soil to a depth of three feet.

Biological Effect of Manure.—Farm manures introduce into the soil a variety of bacteria and ferments. These help increase the supply of available plant food. Barnyard manure sometimes causes denitrification in the soil. By this process, nitrogen is set free in a gaseous form and may escape. This is likely to be most serious as a result of changing nitrates in the soil into other forms and therefore reducing the available nitrogen supply. Experiments show that this occurs only in exceptional cases and generally when unusually large applications of manure have been made. On the other hand, experiments in considerable number indicate that applications of manure may actually favor nitrification and aid in the formation of nitrates. At the Delaware Experiment Station it was found that soil liberally manured and producing hay at the rate of six tons per acre contained several times as many bacteria as were found in the same soil which had but little manure and was producing hay at the rate of about one ton per acre.

The Value of Manure.—The value of manure depends: (1) upon the class of animals by which it is produced; (2) upon the age of the animals producing it; and (3) upon the character of feed from which produced. Animals that are used for breeding purposes or for the production of milk or wool retain a larger proportion of the plant-food constituents of the food they consume. This will be found in their products, whether it be the young animals to which they give birth or the milk or wool produced by the cow and sheep respectively. Young animals that are making rapid growth use a portion of the plant-food constituents, and this is built into the tissues and bones of such animals. Old animals

that have ceased to grow and animals that are being fattened void practically all of the plant-food constituents in their excrements. For this reason the manure from different classes of animals varies considerably in its plant-food constituents.

Mature animals, neither gaining nor losing in weight, excrete practically all of the fertilizer constituents in the food consumed. Growing animals may excrete as little as 50 per cent of such constituents. Milch cows excrete 65 to 85 per cent; fattening and working animals 85 to 95 per cent. As regards the value of equal weights of manure under average farm conditions, farm animals stand in the following order: poultry, sheep, pigs, horses, cows. At the Mississippi Experiment Station young fattening steers excreted on an average 84 per cent of the nitrogen, 86 per cent of the phosphoric acid and 92 per cent of the potash in the food consumed. At the Pennsylvania Experiment Station, cows in milk excreted 83 per cent of nitrogen, 75 per cent of phosphoric acid and 92 per cent of the potash of their food. The amount of manure produced per thousand pounds of live weight of animals also varies with the class of animals, as well as with the method of feeding and the character of the feed consumed. Sheep and hogs produce the smallest amount of manure, but yield manure of the greatest value per ton. Cows stand first in the amount of manure produced, but rank lowest in the quality of manure.

Horse Manure.—Horse manure is more variable in its composition than that of any other class of farm animals. This is due to the fluctuation in the amount and character of the feed given to the horse, depending on whether he is doing heavy or light work, or whether he is idle. Horse manure is drier than that from cattle, and generally contains more fibrous material. It ferments easily, and is, therefore, considered a hot, quick manure. When placed in piles by itself it ferments rapidly and soon loses a large part of its nitrogen in the form of ammonia. Because of its dry condition and rapid fermentation the temperature of the manure pile becomes very high, causing it to dry out quickly. This results in what is commonly called fire-fanging. To prevent this, horse manure should be mixed with cold, heavy cow or pig manure, or the piles of horse manure should be compacted and kept constantly wet in order to reduce the presence of air and consequent rapid fermentation. The quality of horse manure makes it especially valuable for use in hotbeds, for the growing of mushrooms and for application to cold, wet soils. Horse manure is more bulky than that of any other class of farm animals and weighs less per cubic foot.

Cattle Manure.—Cow and steer manure contains more water than that from other domestic animals. It is ranked as a cold manure, and has the lowest value, both from the standpoint of its plant-food constituents and its fertilizing value. The average cow produces 40 to 50 pounds of dung or solid manure, and 20 to 30 pounds of urine per day.

Hog Manure.—The manure from hogs is fairly uniform in its com-

position, and is considered a cold, wet manure. It ferments slowly. Hogs of average size produce 10 to 15 pounds of manure daily, and the manure is somewhat richer than that from the preceding classes of animals, chiefly because swine are fed more largely on rich, concentrated foods.

Sheep Manure.—Sheep manure is drier and richer than that from any of the domestic animals except poultry. It ferments easily and acts quickly in the soil. It keeps well, however, when allowed to accumulate in pens where it is thoroughly tramped by the animals. It is especially valuable for use in flower beds or for vegetables where quick action is desired. An average sheep produces about four to five pounds of manure daily.

Poultry Manure.—Poultry manure is the richest of farm manures. It is especially rich in nitrogen, which is due to the fact that the urinal secretions are semi-solid and are voided with the solid excrements. It ferments easily, giving rise to the loss of nitrogen, and is very quick acting when placed in the soil. It keeps best when maintained in a fairly dry condition, and should be mixed with some absorbent or preservative. Ground rock phosphate, gypsum or dry earth are good materials for this purpose. Mixing with slaked lime, ashes or any alkaline material should be avoided. These cause a liberation of ammonia, resulting in a loss of nitrogen.

The following table gives the average total production of solid and liquid excrements per year of the different classes of animals, together with their percentage of water, nitrogen, phosphoric acid and potash.

AVERAGE YIELD AND COMPOSITION OF FRESH EXCREMENTS OF FARM ANIMALS.*

Dung—Solid Excrements.	Excreted per Year, pounds.	Water, per cent.	Composition.		Potash, per cent.
			Nitrogen, per cent.	Phosphoric Acid, per cent.	
Cows.....	20,000	84.0	0.30	0.25	0.10
Horse.....	12,000	76.0	0.50	0.35	0.30
Pigs.....	1,800	80.0	0.60	0.45	0.50
Sheep.....	760	58.0	0.75	0.60	0.30
Hen.....	30	48.6	1.38	0.50	0.41

Urine—Liquid Excrements.	Excreted per Year, pounds.	Water, per cent.	Composition.		Potash, per cent.
			Nitrogen, per cent.	Phosphoric Acid, per cent.	
Cows.....	8,000	92.0	0.80	Trace	1.4
Horse.....	3,000	89.0	1.20	Trace	1.5
Pigs.....	1,200	97.5	0.30	0.12	0.2
Sheep.....	380	86.5	1.40	0.05	2.0

* This table taken from Volume Five, Farmers' Cyclopedia.

Miscellaneous Farm Manures.—In addition to the manure from farm animals there is a variety of materials that may be available as manure on many farms. It is well to utilize these as far as possible. Among those most commonly met with are night-soil, leaf-mould and muck or peat. Night-soil is best used when mixed with some good absorbent, such as loam, muck or peat, and composted. Muck and peat are terms used to designate accumulations of vegetable matter that are frequently found in marshes, swamps and small ponds. Such material varies greatly in its composition, and is especially valuable for its content of nitrogen, and for its physical effect upon the soil. Leaf-mould pertains to decayed accumulations of leaves frequently found in considerable quantities in forested areas. It is especially valuable for some classes of garden truck and flowers, but is ordinarily too costly because of the difficulty of gathering it in any considerable quantities.

Value of Manure Influenced by Quality of Feed.—The plant-food content of manure is almost directly in proportion to the plant-food constituents contained in the feeds from which it comes. Thus, concentrated feeds high in protein, such as cottonseed meal, wheat bran and oil cake, produce manure of the highest value. Ranking next to these are such feeds as alfalfa and clover hay and other legumes. The cereals, including corn and oats together with hay made from grasses, rank third, while manure from roots is the lowest in plant-food constituents and fertilizing value. Not only will the plant-food constituents be most abundant in the manure from the concentrates, but it is likely also to be more readily available than that produced from roughage.

These facts are important in connection with the selling of cash crops and purchasing such concentrates as cottonseed meal and bran. One who buys cottonseed meal as a fertilizer gets only its fertilizing value. If it is purchased for feeding purposes, one may secure both its feeding value and practically all of its manurial value. The relative price, therefore, of cash crops and purchased concentrates as feed is only one phase of the exchange problem. Such concentrates produce manure having a much higher value than that from the cash crops. This should be considered in connection with the exchange.

The table on next page shows the pounds of fertilizer constituents in one ton of different agricultural products. It indicates the exchanges which might, therefore, be effected with advantage.

The feeding value of a ton of wheat bran does not differ materially from that of a ton of shelled corn. The difference in its feeding value affects the nutritive ratio rather than the energy value. By exchanging one ton of corn for an equal weight of wheat bran, there would be a gain to the farm of 21 pounds of nitrogen, 46 pounds phosphoric acid and 24 pounds of potash, as shown by the above table. At usual prices for the fertilizer constituents, this gain would amount to not less than \$6 worth

of plant food. With an exchange of milk or potatoes for similar concentrates, the gain would be still more striking.

Amount and Character of Bedding Affects Value of Manure.—Straw is a by-product on most farms, and is best utilized as bedding for animals. In this way the plant-food constituents are not only all returned to the soil from whence they originally came, but the straw becomes an absorbent and prevents the loss of the liquids in the manure. Straw utilized in this way is probably more valuable than it would be if applied directly

MANURIAL CONSTITUENTS CONTAINED IN ONE TON OF VARIOUS FARM PRODUCTS.

Farm Product.	Manurial Constituents.		
	Nitrogen, pounds.	Phosphoric Acid, pounds.	Potash, pounds.
Timothy hay.....	19.2	7.2	25.2
Clover hay.....	39.4	8.0	35.0
Alfalfa hay.....	53.2	10.8	49.2
Cowpea hay.....	49.6	13.2	47.2
Corn fodder, field cured.....	17.2	7.2	21.4
Corn silage.....	8.4	2.4	6.6
Wheat straw.....	8.6	2.6	14.8
Rye straw.....	10.0	5.8	15.8
Oat straw.....	13.0	4.4	24.4
Wheat.....	34.6	19.2	7.0
Rye.....	32.4	16.2	10.4
Oats.....	36.2	15.4	11.4
Corn.....	29.6	12.2	7.2
Barley.....	39.6	15.4	9.0
Wheat bran.....	51.2	58.4	31.4
Linseed meal.....	108.6	37.6	26.2
Cottonseed meal.....	142.8	61.8	36.4
Potatoes.....	7.0	3.2	11.4
Milk.....	10.2	3.4	3.0
Cheese.....	90.6	23.0	5.0
Live cattle.....	53.2	37.2	3.4

as such to the soil. In the manure it is intermingled with the solid and liquid excrement, and inoculated with the bacteria in the voidings of animals, which facilitates its decomposition in the soil. Straw contains less plant food than an equal weight of dry matter in manure. An abundance of straw, therefore, used as bedding tends to dilute the manure and slightly reduce its value per ton. This, however, is not a logical objection to its use on the farm, although it might become so on the part of the farmer who is purchasing barnyard manure from outside sources, providing, of course, that no distinction in price is made in accordance with the concentration or dilution of the manure.

Some farmers use a great abundance of straw for bedding their animals. It is not, however, deemed good practice to use more than is sufficient to keep the animals clean and absorb and retain all of the liquids.

A superabundance of bedding gives rise to a bulky, strawy manure that must be used in large quantities in order to be effective, and frequently results at the outset in denitrification and unsatisfactory results.

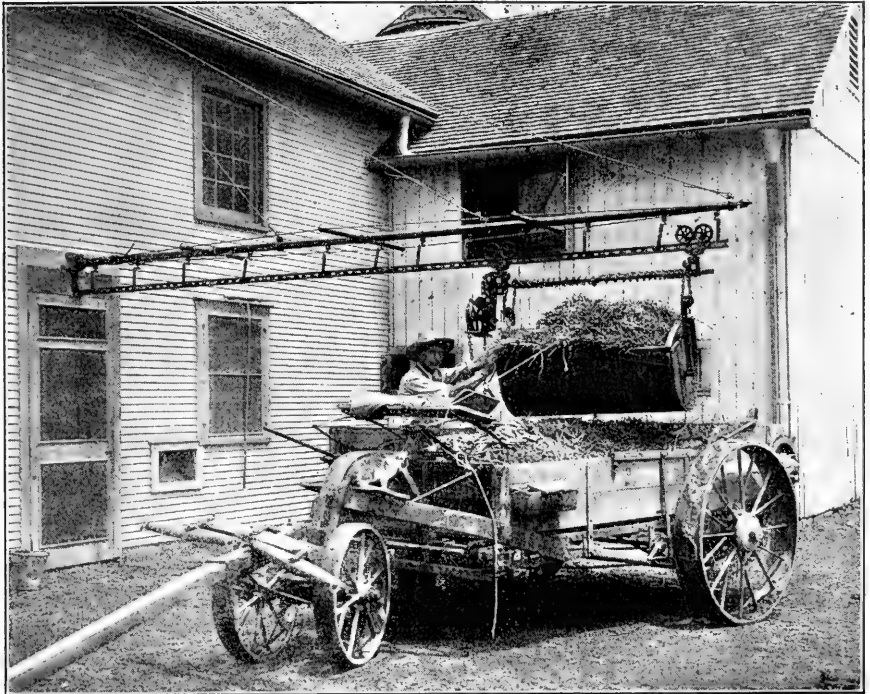

MODERN CONVENIENCE FOR CONVEYING MANURE FROM STALLS TO MANURE SPREADER.¹

In a general way, it is estimated that the amount of bedding used for animals should equal approximately one-third of the dry matter con-

ABSORBENT CAPACITY OF 100 POUNDS OF DIFFERENT MATERIALS WHEN AIR DRY

Nature of Absorbent.	Liquid Absorbed, pounds.
Wheat straw.....	220
Oat straw.....	285
Rye straw.....	300
Sawdust.....	350
Partly decomposed oak leaves.....	160
Leaf rakings.....	400
Peat.....	500
Peat moss.....	1,300

¹ Courtesy of The Pennsylvania Farmer.

sumed. This, however, will vary greatly, depending on the absorbent power of the bedding used and the character of the feed the animals receive. It will also depend on whether or not the absorbent material is thoroughly dry when used. When bedded with ordinary oat and wheat straw, it is estimated generally that cows should each have about 9 pounds of bedding, horses $6\frac{1}{2}$ pounds and sheep $\frac{3}{4}$ pound. The table on preceding page shows the approximate absorbent capacity of various materials used as bedding.

The figures in the table are only approximate, and will vary considerably under different conditions. They are supposed to represent the amount of liquid that will be held by 100 pounds of the substances mentioned, after twenty-four hours of contact.

Aside from the absorbent power of bedding, its composition is also of some importance, and the following table gives the average fertilizer constituents in 2000 pounds of different kinds of straw.

FERTILIZER CONSTITUENTS IN 2000 POUNDS OF VARIOUS KINDS OF DRY STRAW.

	Nitrogen, per cent.	Phosphoric Acid, per cent.	Potash, per cent.
Wheat.....	11.8	2.4	10.2
Wheat chaff.....	15.8	14.0	8.4
Oats.....	12.4	4.0	24.8
Rye.....	9.2	5.6	15.8
Barley.....	26.2	6.0	41.8
Barley chaff.....	20.2	5.4	19.8
Buckwheat hulls.....	9.8	1.4	10.4

Methods of Storing and Handling.—The value of manure is also determined by the manner in which it is stored, the length of time it remains in storage and its manipulation in the storage heap. Manure is a very bulky material of a comparatively low money value per ton. Its economical use, therefore, demands that the consequent labor be reduced to the minimum, especially in those regions where labor is high-priced. Where manure is to be protected from the elements, it calls for comparatively inexpensive structures for the purpose.

When different kinds of animals are kept, it is advisable to place all the manure together so that the moist, cold cow and pig manure may become thoroughly mixed with the dry, hot horse and sheep dung. In this way each class of manure benefits the other. Where the manure is deposited in a barnyard in which the animals run, the swine are frequently allowed to have free access to the manure pile, from which they often get considerable feed which would otherwise be wasted. Such feed consists of the undigested concentrates fed to the horses and cattle. Swine thoroughly mix the different kinds of manure, and when it is thoroughly compacted by the tramping of the animals, fermentation is reduced

to the minimum. If it is protected from rains and sufficient absorbent material has been used in the bedding, loss is comparatively small.

When horse manure is placed by itself, it ferments very rapidly and soon loses its nitrogen. Such fermentation can be materially reduced by compacting the manure pile thoroughly and applying sufficient water to keep it constantly wet. This same rapid decomposition and loss of nitrogen will take place in case of mixed manures if they are neither compacted nor wet, although loss will not be so rapid.

The use of covered barnyards for protecting manure has in recent years met with much favor in some portions of the country.

Losses of Manure.—A practice too common in many sections is to



PILES OF MANURE STORED UNDER EAVES OF BARN, SHOWING HOW LOSS TAKES PLACE.¹

throw the manure out of stable doors and windows, and allow it to remain for a considerable length of time beneath the eaves of the barns. This not only exposes it to direct rainfall, but also subjects it to additional rain collected by the roof of the building. Under these conditions the leaching of the manure and the consequent loss is very great. Where manure piles remain long under these conditions, it is sometimes doubtful whether the depleted manure is worth hauling to the field. Certainly this is a practice to be condemned. Both the mineral constituents and organic matter are carried off in the leachings.

Experimental Results.—Experiments at the Cornell Experiment Station where manure remained exposed during six summer months showed a percentage loss for horse manure as follows: gross weight 57

¹ Courtesy of Doubleday, Page & Co., Garden City, N. Y. From "Soils," by Fletcher.

per cent, nitrogen 60 per cent, phosphoric acid 47 per cent, potash 76 per cent; for cow manure the loss was: gross weight 49 per cent, nitrogen 41 per cent, phosphoric acid 19 per cent, potash 8 per cent. The rainfall during this period was 28 inches. This shows an average loss for the two classes of manure of more than one-half in both weight and actual plant-food constituents.

By similar observations at the Kansas Station, it was found that the waste in six months amounted to fully one-half of the gross weight of the manure and nearly 40 per cent of its nitrogen.

The New Jersey Experiment Station found that cow dung exposed to the weather for 109 days lost 37.6 per cent of its nitrogen, 52 per cent of its phosphoric acid and 47 per cent of its potash. Mixed dung and urine lost during the same period of time 51 per cent of its nitrogen, 51 per cent of phosphoric acid and 61 per cent of potash. Numerous other experiments along the same line could be cited, giving essentially the same results. These experiments leave no doubt as to the large loss incurred in negligent methods in the management of manure, and emphasize the importance of better methods of storing manure.

The estimated annual value of the manure from all animals in the United States as given in the table in the first part of this chapter is \$2,485,367,711. There is no means of ascertaining what proportion of all manure is deposited where it can be collected. For present purposes we will assume that one-half of it is available for return to the land. Assuming that one-third of this is lost because of faulty methods of storage and handling, the loss from this source would be valued at \$414,227,952. The enormous loss sustained by American farmers through negligence in the care, management and use of manure emphasizes the importance of the subject and the great need of adopting economic methods in its utilization.

How to Prevent Loss.—Some of the methods of preventing loss have already been suggested. Under most conditions this is best accomplished by hauling the manure soon after its production directly to the field. This has become a common practice in many localities. It is economical from a number of viewpoints. It saves labor, obviating the extra handling incurred when the manure is first dumped in the yard and afterwards loaded on wagons to be taken to the field. It keeps the premises about the barns and yards clean at all times; reduces offensive odors due to decomposition of manure; and reduces in the summer time breeding places for flies. The most important saving, however, is in the actual value of the manure, which in this way has sustained no loss due to decomposition and leaching.

Absorbents vs. Cisterns.—Losses frequently occur both in the yard and stable, due to a direct and immediate loss of the liquid portions of the manure. This is overcome either by the use of an ample supply of absorbent in the way of bedding or by collecting the liquid manure in a

cistern. The cistern method of saving liquid manure is of doubtful economy in this country. The expense of cisterns and the trouble of hauling and distributing, together with the care which must be exercised to prevent loss of nitrogen by fermentation of the liquid when it stands long, are all valid objections to such provisions. It is possible under intensive farming and with cheap labor that liquid manure might be thus saved and utilized for crops that respond to nitrogenous fertilizers. Best results with manure demand that the liquid and solid portions be applied together. It is the consensus of opinion that the best general practice is to save the liquid by the use of absorbents.

Since nitrogen frequently escapes as ammonia, certain absorbents for gases, such as gypsum, kainite, acid phosphate and ordinary dust, have been recommended. As direct absorbents, however, these are of doubtful value, although some of them are effective, first, in reducing the fermentation, and second, in actually reinforcing the manure by the addition of plant-food constituents.

Sterilization.—Preservatives have also been suggested in the nature of substances that will prevent fermentation and thus reduce losses. Bisulphide of carbon, caustic lime, sulphuric acid and a number of other substances have been tested for this purpose. However, anything that will prohibit fermentation destroys the bacteria of the manure, and such destruction may more than offset the saving in plant-food constituents. Furthermore, most of these materials are rather costly, and the benefits derived are not equal to the expense incurred.

Reinforcing Manures.—A number of substances have been used to reinforce manure. The one most beneficial and economical is either acid phosphate or rock phosphate. This is undoubtedly due to the fact that phosphorus is the element most frequently needed in the soils, and that manure is inadequately supplied with it. The following table, showing results obtained at the Ohio Experiment Station by reinforcing manure with different substances, gives direct evidence as to the relative merits of such substances:

VALUE OF MANURE, AVERAGE 15 YEARS.—Rotation: Corn, Wheat, Clover (3 Years).

Treatment.	Nothing.	Gypsum.	Kainite.	Floats.	Acid Phosphate.
Return per ton:					
Yard manure.....	\$2.55	\$3.04	\$2.93	\$3.54	\$4.10
Stall manure.....	3.31	3.56	3.97	4.49	4.82

It is evident from the above table that all the materials used have more or less increased the value of the manure, as determined by the value of increase in crops obtained from each ton when applied once in a three years' rotation of corn, wheat and clover. The value per ton of

manure is based on the average farm price of the crops produced. It is also evident from the table that stall manure gave in every instance a larger return per ton than did yard manure, and that floats and acid phosphate proved by all odds the best reinforcing materials. While acid phosphate reinforcement gave the largest return per ton of manure, the floats proved about equally profitable from the investment standpoint.

In localities where phosphorus is the dominant soil requirement, the reinforcement of manure with acid phosphate at the rate of about forty pounds to each ton of manure is a most excellent practice. The manner of applying the phosphate may be determined by conditions. It will frequently be found convenient to apply this material to the manure in



SPREADING MANURE FROM WAGON, OLD WAY.¹

the stalls or stables each day at the rate of about one pound for each fully grown cow, horse or steer, and in lesser amounts for the smaller animals. There is probably no place in which the raw rock phosphate is likely to give better results than when used in this way as a reinforcement to manure.

Economical Use of Manure.—The most economical use of manure involves a number of factors. It is the opinion of both chemists and farmers that manure and urine should be applied to the soil in its freshest possible condition. If this is true, manure should be hauled from the stable or barnyard to the field as soon as it is made. As previously indicated, this method reduces to the minimum the cost of handling and has several additional advantages. Well-rotted manure may be more quickly available to plants, less bulky and easier to distribute, and weight for

¹ Courtesy of Doubleday, Page & Co., Garden City, N. Y. From "Soils," by Fletcher.

weight may give as much or larger returns than fresh manure. There are, however, only a few conditions under which its use can be superior to that of using fresh material. The rotted manure may be used for intensive crops when availability is important, and especially on land where weeds, entailing hand work, become a serious problem. In fresh manure the weed-seeds that may have been in the feeds are likely to be largely viable, and give rise to trouble in the field. Thorough fermentation generally destroys the viability of weed-seeds in manure.

To Which Crops Should Manure be Applied?—Next to time of hauling may be considered the crops to which manure can be most advantageously applied. Direct applications of fresh manure are thought to be injurious to the quality of tobacco, to sugar beets and to potatoes. It should, therefore, not be applied to these crops directly. It may be applied to the crop preceding, or decomposed manure may be used. As a rule, manure should be applied directly to the crop in the rotation having the longest growing season, or the greatest money value. For example, in a rotation of corn, oats, wheat and mixed grasses, corn not only has the longest growing season, but also the greatest food and cash value. It is, therefore, considered good practice to apply the manure directly to the corn. Since the benefits of manure are distributed over a number of years, the crops which follow will benefit by its residual effect.

To What Soils Should Manure be Applied?—Character of soil may also determine where the manure should be applied. If mechanical condition is a prime consideration, fresh manure may be applied to heavy, clay soils and well-rotted manure to light, sandy soils. On the other hand, the sandy soils in a favorable season are more likely to utilize coarse manure to advantage than heavy soils. In such soils decomposition will proceed more rapidly, thus rendering available the plant-food constituents of the manure. On sandy soils manure should be applied only a short time before it is likely to be needed, in order to prevent the danger of loss by leaching. On heavy, clay soils the benefits from applying fresh manure are likely to be rather slight the first year, because of slow decomposition of the manure. This, however, is not serious, because in such soils the plant food as it becomes available is held by the soil with little or no loss.

Climate Affects Decomposition.—Climate may also be a factor influencing the use of fresh manure. In a warm, damp climate it matters little whether the manure is fresh or well rotted when applied. Under such conditions decomposition in the soil is sufficiently rapid to make fresh manure readily available. The character of season may also be a factor determining the relative merits of fresh and rotted manure. In a very dry season excessive applications of fresh manure show a tendency to burn out the soil, and this is more marked in light, sandy soils than in the heavy soils. Furthermore, heavy applications of strawy manure

plowed under when the soil is dry will destroy the capillary connection between the upper and lower soils, thus preventing a rise of the subsoil water for the benefit of the newly planted crop. This occasionally results in a crop failure and the condemnation of the use of fresh manure.

Eroded Soil Most in Need of Manure.—In a general way, any kind of manure should be applied to those portions of the farm the soil of which is most in need of manure. Marked differences in the organic content of the soil in different parts of fields are often manifest. This most frequently is the result of slight erosion on the sloping portions. It is a good practice to apply manure to these portions in an effort to restore them to their original fertility. Such areas without special attention tend to deteriorate rapidly. The addition of manure improves the physical condition of the soil, increases its absorptive power for rain and lessens erosion. In this way, not only is the soil benefited, but deterioration through erosion is checked.

Rate of Application.—The rate of applying manure is also important and will determine the returns per ton of manure. Farmers in general do not have sufficient manure to apply in large quantities to all of their land. This gives rise to the question as to whether or not heavy applications shall be used on restricted areas and for certain crops, or whether the manure shall be spread thinly and made to reach as far as possible. Some German writers speak of 18 tons per acre as abundant, 14 tons as

VALUE OF MANURE. AVERAGE 30 YEARS.

Rotation: Corn,* Oats, Wheat,* Clover, Timothy (Four Years).

Treatment, One Rotation.	Value of Four Crops.	Return per Ton of Manure.	Return per Ton over 12 per Acre.
Nothing.....	\$60.02
Manure 12 tons.....	88.91	\$2.41
Manure 16 tons.....	89.62	1.85	\$0.18
Manure 20 tons.....	92.68	1.63	.33
Manure 12 tons and lime 2 tons.....	92.22	2.68

moderate and 8 tons as light applications. They recommend 10 tons per acre for roots, 20 tons per acre for potatoes. In England, at the Rothamsted Experiment Station, 14 tons yearly for grain was considered heavy. In New Jersey 20 tons per acre for truck is not infrequently used. Such applications are, however, unnecessarily large for general farm crops and for the average farm.

At the Pennsylvania Experiment Station the average results for a period of thirty years in a four-crop rotation when manure was used at the rate of 12, 16 and 20 tons per acre during the rotation, show that the largest return per ton of manure was secured with the lightest application.

* Manure applied to these crops only.

The manure in this case was applied twice in the rotation; 6, 8 and 10 tons per acre to the corn, the same amounts to the wheat and none to either the oats or grass.

The returns per ton of manure are based on a valuation of crops as follows: Corn 50 cents a bushel, oats 32 cents a bushel, wheat 80 cents a bushel, hay \$10 a ton, and oat straw, wheat straw and corn stover \$2.50 per ton.

A similar experiment at the Ohio Experiment Station covering a period of eighteen years has also shown the largest return per ton of manure in case of the smaller applications. The results are given in the following table:

VALUE OF MANURE. AVERAGE 18 YEARS.

Rotation: Corn,* Oats, Wheat,* Clover, Timothy (Five-year Rotation).

Treatment, One Rotation.	Return per Ton of Manure.	Return per Ton over 8 per Acre.
Manure 8 tons.....	\$3.17
Manure 16 tons.....	2.41	\$1.75

Rotation: Potatoes, Wheat,† Clover (Three Years).

Treatment, One Rotation.	Return per Ton of Manure.	Return per Ton over 8 per Acre.
Manure 4 tons.....	\$3.47
Manure 8 tons.....	2.58	\$1.69
Manure 16 tons.....	2.15	1.72
Manure 8 tons.....	3.30

Methods of Applying Manure.—A uniform rate and even distribution of manure are essential. This can be most economically effected by the use of a manure spreader. It does the work better than it can be done with a fork, and at a great saving of labor. While a manure spreader is rather an expensive implement, it will be a paying investment on any farm where 60 tons or more of manure are to be applied annually. It is a common practice in most parts of the country to apply manure to a grass sod and plow it under. In many cases manure is also applied to corn land and land that has been in small grain, to be followed by other or similar crops. While it is the consensus of opinion that the manure applied in this way will give best results, there is some question as to whether or not more of it should not be applied in the form of a top dressing.

Top Dressing vs. Plowing Under.—At the Maryland Experiment

* Manure applied to these crops only.

† Manure applied to wheat, except in second 8 tons application, which went on potatoes.

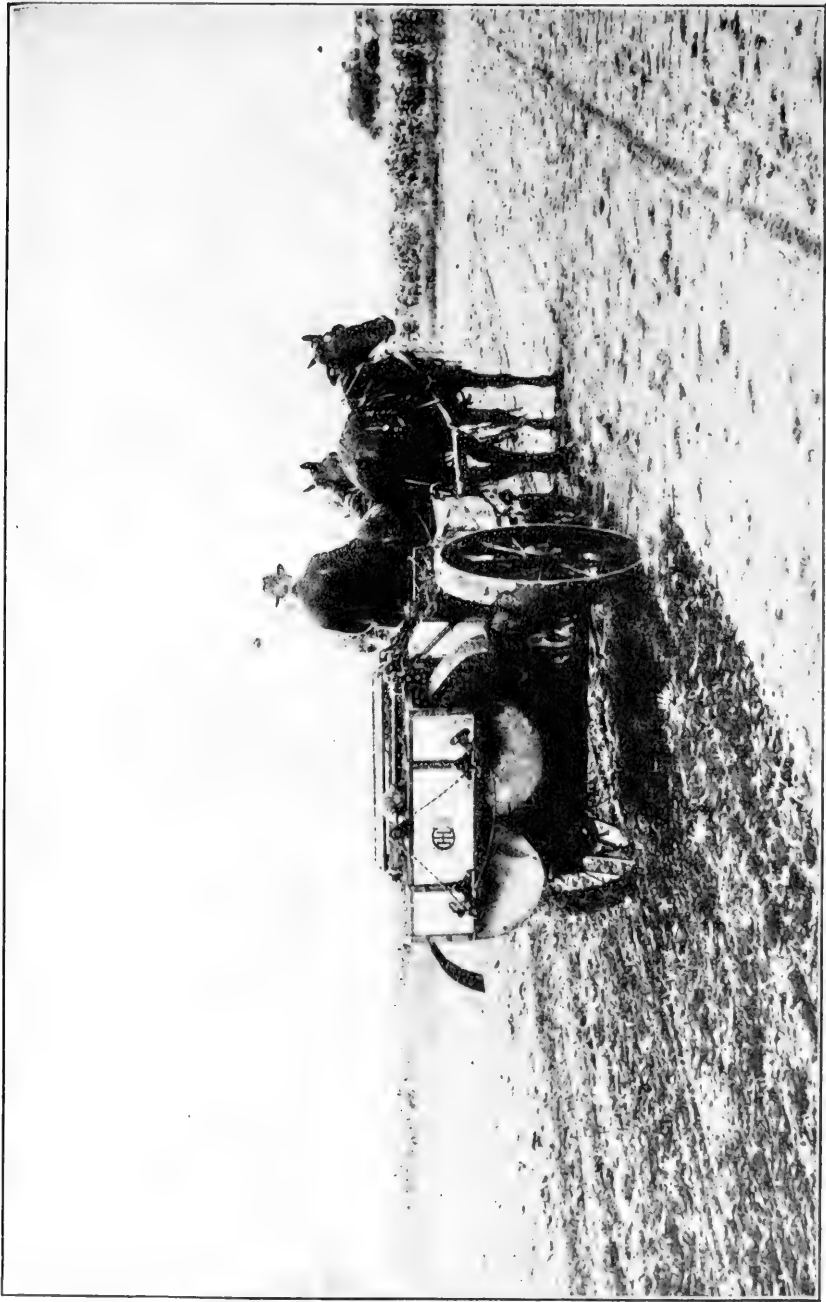

THE MODERN MANURE SPREADER.¹
This machine spreads the manure evenly; and requires but one man to drive and operate it.

¹ Courtesy of The International Harvester Company, Chicago.

Station both fresh and rotted manure were applied before and after plowing. For fresh manure the average of two crops of corn showed a gain of 10.9 bushels per acre in favor of applying after plowing. For the wheat which followed the corn the gain was two bushels per acre. Where rotted manure was compared in the same way there was practically no difference in the yield of corn, and about one bushel gain for wheat in favor of applying after plowing. In this experiment the fresh manure under both conditions and for both crops gave yields considerably above that produced by the rotted manure.

Another experiment in which the manure was plowed under in the spring as compared with plowing under in the fall gave results with corn and wheat favorable to plowing under in the spring. This is in harmony with the preceding experiment, and suggests that manure applied to the surface, and allowed to remain for some time in that position, benefits the soil and results in a better growth of crops than when it is plowed under immediately. The subject is one worthy of further consideration and experimentation. It is not an uncommon opinion, however, among practical farmers that top dressing with manure is more beneficial than plowing it under, and it is quite a common practice to top dress grass lands and wheat with manure.

In the South, where manure is very scarce, it is frequently applied in the hill or furrow at planting time. This entails a good deal of hand labor, but it is probably justifiable where labor is as cheap as it is there. The manner of applying small applications concentrates the manure in the vicinity of the plants and stimulates growth during the early portions of the season.

The Parking System.—The cheapest possible way of getting manure on the land is by pasturing the animals, or allowing them to gather their own feed. This, of course, is an old and universal practice in case of pastures, and is becoming more popular as indicated by the practice of hogging off corn, and other annual crops. This is spoken of as the parking system. It has a disadvantage that in certain classes of animals the manure is not uniformly distributed. It is more applicable for sheep and swine than it is for the larger animals.

Distribution of Benefits.—The benefits of manure are distributed over a number of years. This often gives rise to difficulty in case of the tenant farmer who rents a farm for only one year and without assurance that he will remain for more than that length of time. He hesitates to haul and apply the manure, knowing that his successor will receive a considerable part of its benefits. Under average conditions it is estimated that the first crop after manure is applied will receive about 40 per cent of its benefits; the second crop 30 per cent; the third crop 20 per cent; and the fourth one the remaining 10 per cent. This distribution of the benefits of manure is used in cost accounting in farm crops. The accuracy of the distribution is doubtless crude, and would vary greatly

for different crops and different soils, and would also be influenced by the character of the manure and its rate of application.

GREEN MANURES

Green manuring consists of plowing under green crops for the benefit of the soil. The practice results in increasing the organic matter in the soil. If legumes are used for this purpose the nitrogen content of the soil may also be increased. Preference should be given to legumes for this reason. The choice of a crop for green manuring purposes will depend on a number of factors. Other things equal, deep-rooted crops are preferable to those having shallow root systems. Plants with deep roots gather some mineral constituents from the subsoil and upon the decay of the plants leave them in the surface soil in an organic form. Deep-rooted plants are also beneficial because they improve the physical condition of the subsoil. In general, crops that will furnish the largest amount of humus and nitrogen-bearing material for the soil should be selected.

When is Green Manuring Advisable?—The practice of plowing under crops for the benefit of the soil is not justified in systems of livestock farming where the crops can be profitably fed and the manure returned to the soil. There are many localities, however, where the farming systems are such that but little manure is available to supply the needs of the soil. Under such conditions green manuring crops are often resorted to with profit. They are especially to be recommended in case of sandy soils low in organic matter, and for heavy soils in poor physical condition. In addition to serving the purposes above mentioned, green manuring crops, if properly selected, occupy the soil at seasons when it would otherwise be bare of vegetation and subject to erosion. They also prevent the loss of nitrogen by leaching. This is later made available for other crops as the green manures decompose in the soil.

Green manuring is most applicable on fruit and truck farms. It is quite extensively practiced in orchards during the early life of the trees. It is also economical in the trucking regions where the winters are mild.

Objections to Green Manuring.—The objections to green manuring lie chiefly in the fact that green manure crops are grown and plowed under for the benefit of the soil and no direct immediate return is secured. The green manuring crops generally take the place of money crops. When it is possible to grow legumes and feed them to livestock with profit, the stubble and roots of such crops, together with the manure which they will afford, make possible nearly as rapid improvement of the soil as is the case when the whole crop is plowed under. Whether or not a green manuring crop should be fed or plowed under must be determined by the cost of harvesting and feeding, together with the cost of returning the manure, as compared with the returns secured in animals or animal products in feeding it.

Principal Green Manuring Crops.—The principal crops grown in the United States for green manuring purposes are red clover, alfalfa, alsike clover, crimson clover, cowpeas, Canada peas, soy beans, vetch, velvet bean, Japan clover, sweet clover and bur clover. In addition to these, beggar weed, peanuts and velvet bean are also used in the South. These are all legumes, and are decidedly preferable to non-legumes under most conditions where green manures can be used. In the North, where the winters are severe, rye and occasionally wheat are used for this purpose. Buckwheat, which is a summer annual, is also sometimes used.



RYE TURNED UNDER FOR SOIL IMPROVEMENT.

When heavy green manuring crops are turned under allow two weeks or more to elapse before planting succeeding crop.

The characteristics and the requirements for these crops will be discussed in Part II of this work.

On poor soils lime and the mineral fertilizers may be used with profit in the production of a green manure crop. This will stimulate the crop to a greater growth, and when it decays in the soil the elements applied will again become available for the crop that is to follow.

The composition of the legumes used for green manuring varies considerably, depending upon local conditions, character of soil and the stage of maturity when plowed under. The table on next page shows the composition as determined by the average of a number of analyses, and gives the fertilizing constituents in pounds per ton of dry matter for both tops and roots in the crops indicated.

In connection with the analyses as shown in this table, it should be borne in mind that all of the mineral constituents come from the soil, and that it is not possible to increase these by the growing of green manur-

ing crops. The only possible benefit in this respect is the more available form that may result as the green manuring crops decompose. The only real additions to the soil will be in the form of organic matter and nitrogen. It is, therefore, essential to select those crops that will give the largest increase in those two constituents.

FERTILIZING MATERIALS IN 2000 POUNDS OF DRY SUBSTANCE.

Plant and Part.	Nitrogen, per cent.	Phosphoric Acid, per cent.	Potash, per cent.
Alfalfa, tops.....	46.	10.8	30.4
Alfalfa, roots.....	41.	8.6	9.6
Cowpeas, tops.....	39.2	10.2	38.6
Cowpeas, roots.....	23.6	11.	23.2
Crimson clover, tops.....	42.6	12.4	27.
Crimson clover, roots.....	30.	9.4	20.4
Common vetch, tops.....	59.9	14.2	53.7
Common vetch, roots.....	43.8	15.8	23.6
Red clover, tops.....	47.	11.6	42.8
Red clover, roots.....	54.8	16.8	16.4
Soy bean, tops.....	43.6	12.5	33.6
Soy bean, roots.....	21.	6.8	13.4
Velvet bean.....	50.2	10.6	76.8

The cultivated crops, such as corn, potatoes, tobacco, cotton and some of the heavier truck crops, generally follow a green manuring crop to better advantage than crops that are broadcasted or drilled and do not require cultivation. It is good practice to plow under green manuring crops two weeks or more in advance of the time of seeding the crop which is to follow. Lime applied to the surface before the crop is turned under will tend to hasten decomposition and neutralize acids which are generally formed. The more succulent the crop when turned under, the greater the tendency to acid formation.

REFERENCES

- "Fertilizers and Manures." Hall.
 "Farm Manures." Thorne.
 "Barnyard Manure, Value and Use." Edward Minus, Dept. of Agriculture, Cornell University, Ithaca, N. Y.
 Michigan Expt. Station Circular 25. "Composition and Value of Farm Manure."
 Michigan Expt. Station Circular 26. "Losses and Preservation of Barnyard Manure."
 Ohio Expt. Station Bulletin 246. "Barnyard Manure."
 Purdue Expt. Station Bulletin 49. "Farm Manures."

CHAPTER 6

LIME AND OTHER SOIL AMENDMENTS

Soils Need Lime.—Lime is an essential element of plant food. Many plants are injured by an acid condition of the soil. Soil acidity is most cheaply corrected by one of the several forms of lime. The beneficial effects of liming have been demonstrated by the agricultural experiment stations in a dozen or more of the states. Observations by farmers in all of the Eastern and Southern States, and in the Central States as far west as the Missouri River, show that on many of the farms soils are sour. This sourness of the soil is due to a deficiency of lime, and often occurs in soils originally rich in lime.

Lime Content of Soils.—Soils vary greatly in their original lime content. Some have very little lime to begin with. Others, such as the limestone soils, are formed from limestone rocks, some of which were originally more than 90 per cent carbonate of lime. The lime content of soils is determined by treating them with strong mineral acids. This removes all of the lime from the soil, and the content is then determined chemically. The following table shows the lime content of a number of typical soils in different parts of the United States:

LIME CONTENT (CaCO_3) PER ACRE 7 INCHES OF SOIL IN SOME TYPICAL SOILS
OF THE UNITED STATES.

Soil Type.	State.	Production.	Lime Content, pounds.
Leonardtown loam.....	Maryland.....	Very low.....	2,500
Orangeburg sandy loam.....	Alabama.....	Low.....	3,500
Orangeburg fine sandy loam.....	Texas.....	“.....	4,650
Cecil clay.....	North Carolina.....	“.....	5,000
Norfolk loam.....	Maryland.....	“.....	8,575
Oswego silt loam.....	Kansas.....	“.....	14,275
Hagerstown loam.....	Tennessee.....	Medium.....	14,275
Miami sand.....	Ohio.....	“.....	34,650
Miami silt loam.....	Wisconsin.....	High.....	32,500
Porters black clay.....	Virginia.....	“.....	59,250
Marshal loam.....	Minnesota.....	“.....	66,750
Podunk fine sandy loam.....	Connecticut.....	“.....	83,575
Fresno fine sandy loam.....	California.....	“.....	125,250
Huston clay.....	Alabama.....	“.....	1,000,750

How Soils Lose Lime.—The greatest loss of lime from the soil is due to leaching. Lime is slowly soluble in the soil solution, and is carried downward by the gravitational movement of the soil water. The rate of loss of lime in this way depends both upon the rate of solubility and

the rate of underground drainage. The fact that drainage waters and well waters in all regions where lime is abundant in the soil are highly charged with it is an indication of the readiness with which lime is lost from the soil in this way.

In limestone soil regions the water generally finds its way into underground drainage channels, and few surface streams occur. Very little of it passes over the surface. This explains why limestone soils become deficient in lime. The presence of an abundance of humus in the soil may retain lime in the form of humates, and reduce its loss.

Lime is also removed in farm crops. The amount of removal in this way depends on the yield and character of crops removed, together with the amount that is returned in manures and other by-products. Legumes contain much more lime than non-legumes, and, therefore, cause a more rapid reduction in the lime of the soil.

Lime Requirements of Soils.—The character of vegetation is a good index to the lime requirement of soils. When red clover fails or when alsike clover does better than red clover, it indicates a sour soil. The presence of redtop, plantain and sorrel also indicates a sour soil. In traveling over the country from the Missouri River to the Atlantic sea-coast, the acidity of the soil is indicated by the presence of these weeds.

Farmers who are troubled with failure of clover and by the encroachment of the above-mentioned weeds, may feel reasonably sure that their soils need lime. If these signs leave doubt in the mind of the farmer, he can further test his soil by the use of neutral litmus paper. Five cents worth of neutral litmus paper purchased at the drug store will enable him to make tests of many samples of soil. This is conveniently done by collecting small samples of soil to the usual depth of plowing at a number of points in the field in question. The soils should be made thoroughly wet, preferably with rain water or water that is not charged with lime. A strip of the litmus paper brought in contact with the soil and allowed to remain for fifteen or thirty minutes will turn red if the soil is sour. The intensity of the change of color will in a measure indicate the degree of sourness.

Upon request, most of the state experiment stations will test representative samples of soil and advise concerning their lime requirements. The laboratory method determines approximately the amount of lime required to neutralize the soil to the usual depth of plowing.

Crops Require Lime.—Some crops are more tolerant of soil acidity than others. Of our staple farm crops, common red clover is about the least tolerant of such a condition. The staple crops that draw most heavily on the soil for a supply of lime are those first affected by soil acidity. They are also the least tolerant of soil acidity, and are usually most responsive to applications of lime. The clovers contain much more lime and magnesia than the cereals and grasses. The following table gives the average lime and magnesia content as carbonates in a ton of

the more general farm crops. Notice the large amounts in clover and alfalfa. Common red clover contains more than alsike clover. It is less tolerant of soil acidity than the latter.

AVERAGE LIME AND MAGNESIA (EQUIVALENT TO CaCO_3 AND MgCO_3) IN 2000 LBS. OF THE FOLLOWING CROPS.

(Calculated from von Wolff's Tables on the Basis of 15 per cent Moisture.)

Produce.	Pounds of Carbonates as		
	Calcium CaCO_3 .	Magnesium MgCO_3 .	Total.
Timothy hay.....	6.00	2.77	8.77
Wheat (grain and straw).....	6.50	6.23	12.73
Corn (grain, cobs and stover).....	8.68	8.66	17.34
Oats (grain and straw).....	10.40	9.00	19.40
Clover hay (alsike).....	49.00	21.47	70.47
Clover hay (red).....	73.00	27.01	100.01
Alfalfa hay.....	91.00	13.16	104.16

Tolerance to Acidity.—Numerous tests at the Pennsylvania Experiment Station show that when the lime requirement of the soil is 1500 to 1700 pounds of burnt or caustic lime per acre seven inches of soil, red



THE GROWTH OF RED CLOVER ON AN ACID SOIL AS AFFECTED BY LIME.¹

A sour soil is unfriendly to clover. Lime will overcome the difficulty.

clover fails. This is equivalent to from 2700 to 3000 pounds of carbonate of lime or crushed limestone. A lime requirement of 500 to 1000 pounds per acre does not seriously interfere with the growth of red clover. In ordinary farm practice the acidity seldom becomes sufficiently marked to affect noticeably the cereals and grasses, although these may be indirectly

¹Courtesy of The Pennsylvania Agricultural Experiment Station.

affected by the failure of clover. On experimental plats where ammonium sulphate has been used, the acidity has become so marked that all of the crops in the rotation are directly affected. The degree of tolerance of these crops is in the following order: oats, wheat, corn and red clover; the last being the least tolerant of soil acidity.

At the Rhode Island Experiment Station, Wheeler has made extensive tests of the tolerance of plants to soil acidity, and the relative benefits of applying lime. The following table shows the plants falling into three classes: first, those benefited by lime; second, those but little benefited by lime; third, plants usually or frequently injured by lime.

LIME AS AFFECTING GROWTH OF PLANTS

Plants Benefited by Liming.

Alfalfa	Eggplant	Peanut
Asparagus	Elm, American	Pepper
Balsam	Emmer	Plum (Burbank-Japan)
Barley	Gooseberry	Pumpkin
Beets/(all kinds)	Hemp	Quince
Beans	Kentucky Bluegrass	Raspberry (Cuthbert)
Bush	Kohl-rabi	Rhubarb
Golden Wax	Lentil	Salsify
Horticultural Pole	Lettuce (all kinds)	Salt-bush
Red Valentine	Linden, American	Sorghum
Cabbage	Martynia	Spinach
Cantaloupe	Mignonette	Squash
Cauliflower	Nasturtium	Summer
Celery	Oats	Hubbard
Cherry	Okra (Gumbo)	Sweet Alyssum
Clover	Onion	Timothy
Red	Orange	Tobacco
White	Pea	Turnip
Alsike	Canada	Flat
Crimson	Common	Swedish
Cucumber	Sweet	Upland Cress
Currant	Pansy	Wheat
Dandelion	Parsnip	

Plants but Little Benefited by Liming.

Bent, Rhode Island	Corn, Indian	Rye
Carrot	Redtop	Spurry
Chicory		

Plants Usually or Frequently Injured by Liming.

Apple*	Cowpea*	Raspberry
Azalea†	Cranberry	(Black-cap)
Bean	Flax	Rhododendron†
Velvet	Grape, Concord*	Sorrel
Castor	Lupine	Common
Birch, American White	Phlox (Drummondii)*	Sheep
Blackberry	Peach*	Spruce, Norway
Chestnut†	Pear*	Tomato*
Cotton	Radish	Zinnia*

* These under certain conditions are benefited by liming.

† These have not been tested at the Rhode Island Station.

Crops benefited by lime were not only increased in size, but were ready for market earlier than where lime was omitted. Tobacco was improved in the character of its ash by the use of lime.

Lime is most beneficial in promoting the growth of legumes. This results in building up the nitrogen supply and general fertility of the soil.

Sources of Lime.—The principal source of lime is in the limestone rocks and deposits that occur in great abundance in many sections of the country. There are probably no states in which limestone formations do not occur, although there are sometimes considerable sections including a number of counties in which limestone deposits are not accessible.

Deposits of marl occur in certain localities. They vary greatly in composition and lime content. Marl is generally in good physical condition for application to the soil, and some of it contains phosphorus and potash.

Oyster shells that accumulate in large quantities in sea-coast localities where oyster farming is carried on forms another valuable source of lime. Wood-ashes are about one-third actual lime. Three tons of wood-ashes are, therefore, equal to one ton of pure burnt lime. Unleached ashes contain 5 to 7 per cent of potash, and 1 to 2 per cent of phosphoric acid, which materially increases their value for use on land. When ashes are leached, most of the potash is lost, but the lime content is somewhat increased.

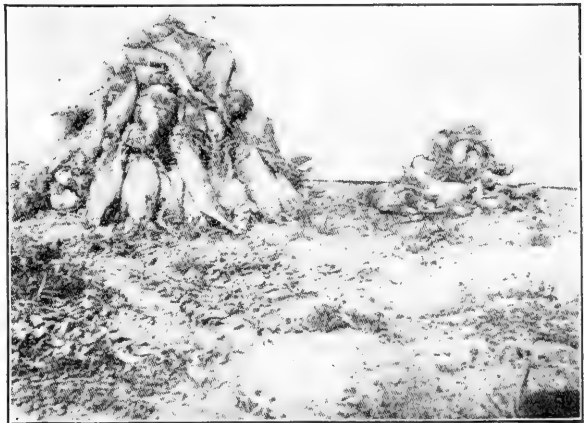

BEETS GROWN WITH AND WITHOUT LIME.¹

There are a number of forms of spent lime, which is a by-product of different manufacturing establishments that use lime. Among these may be mentioned dye-house lime, gas-house lime, lime from tanneries, waste lime from soda-ash works, and waste lime from beet-sugar factories. The value of these varies widely, and it is impossible to make a definite statement concerning their value. They can frequently be secured at no cost other than the hauling. Whether or not they are worth hauling depends upon circumstances. Frequently, they contain much water, are in poor physical condition and will be more expensive in the long run than to purchase first-class lime in good mechanical condition. Their

¹Courtesy of International Agricultural Association, Caledonia, N. Y.

value can be determined only by examination by the chemist or by actual field test.

Gypsum or land plaster is frequently used on land, and while it will supply calcium as a plant food, it has little or no effect in correcting soil acidity.

The rock phosphates and Thomas slag, used as sources of phosphorus, contain considerable lime, and their liberal use may obviate the necessity for applying lime to the soil.

Forms of Lime.—Lime (CaO) does not occur in nature. It is prepared by heating limestone (CaCO_3) in kilns; 100 pounds of pure limestone thus heated loses 44 pounds of gas known as carbon dioxide (CO_2), and results in 56 pounds of lime. This 56 pounds of lime may be slaked with water and will combine with enough water to make 74 pounds of hydrated lime. Therefore, 1120 pounds of pure lime equals 1480 pounds of pure hydrated lime, which equals 2000 pounds carbonate of lime or pure pulverized limestone. When lime and hydrated lime are exposed to the air they slowly combine with the carbon dioxide of the air until finally reverted to the original form of carbonate of lime. The only difference between the original lime rock and completely air-slaked lime is that of fineness of subdivision, the one being in the form of large rock masses and the other a very fine powder. It is this fine state of subdivision that makes air-slaked lime valuable to apply to the soil. If the raw limestone could be made equally fine it would be just as good as air-slaked lime for the same purpose. If used in generous amounts it need not be so fine as air-slaked lime, but in order to be prompt and effective, pulverized limestone should be so fine that 90 per cent will pass through a 100-mesh screen. Where abundant and cheap, larger amounts of coarser material may be used because of the considerable amounts of finely divided active material it carries. The coarse portion may become available in later years. Lime is generally sold in one of five forms: ground limestone, freshly burnt or lump lime, ground burnt lime, hydrated lime and air-slaked lime. Some deposits of lime are nearly pure carbonates of lime, while others contain much magnesia and are known as dolomite. The presence of magnesia slightly increases the neutralizing power of a given weight of lime.

FUNCTIONS OF LIME

Lime as Plant Food.—The absence of lime prevents a normal development of plants. Lime is, therefore, essential as a plant food. Most soils contain sufficient lime to meet the food requirements of plants. Some soils, however, may contain so little, or it may be so unavailable, that plants that are hungry for lime may suffer from a lack of it.

Chemical Action of Lime.—The chemical effect of lime on most soils is of minor importance. It varies somewhat with the form in which it is applied to the soil. Freshly burnt or caustic lime is the most active

form. It may combine with certain soil elements liberating other elements such as potash, and making them available for plants. Lime in the presence of soluble phosphates will readily combine with them, forming tricalcium phosphate. This will prevent the phosphates from uniting with iron and aluminum, which gives rise to compounds less available to plants than the lime phosphates.

Physical Effect of Lime.—Clay soils are frequently improved in physical condition by the liberal application of lime. Freshly burnt lime is the most active form for this purpose. Lime causes a flocculation of the clay particles and increases the porosity of the soil. Lime, therefore, facilitates drainage, makes cultivation easier, causes an aeration of the soil and makes possible a deeper penetration by plant roots. On sandy soils burnt lime may tend to bind the particles together. This may or may not be desirable. When applied for its physical effect it is usually best to apply air-slaked lime or finely pulverized limestone to sandy soils, and to use freshly burnt lime on heavy, refractory soils well supplied with organic matter.

Lime Affects Soil Bacteria.—Certain species of bacteria are instrumental in the change of ammonia and inorganic forms of nitrogen to nitrates. This process is known as nitrification, and is promoted by the presence of lime in the soil. The process not only makes the nitrogen available, but gives rise to the development of carbon dioxide, which in turn acts upon inert plant food and makes it more readily available to plants.

Lime is also beneficial to the several forms of micro-organisms that reside in the tubercles on the roots of all legumes. This may explain why legumes are generally more benefited by lime than non-legumes.

Lime Corrects Soil Acidity.—In the vast majority of instances the chief function of lime is to correct soil acidity. Lime corrects acidity by combining with the acids formed and giving rise to neutral salts. It will seldom pay to apply lime to the soil for purposes other than this. The amount of lime to apply is, therefore, determined chiefly by the degree of acidity of the soil. In practice it is found advisable to apply more than actual lime requirements indicated by chemical methods. This is advisable because in practice it is impossible to distribute lime thoroughly and uniformly and secure its thorough mixture with the soil. Because of this lack of uniformity in distribution some of the lime applied will be ineffective and portions of the soil will not be brought in contact with lime. It is not always necessary to make the soil neutral, since most crops, even the most sensitive crops, will grow fairly well in the presence of small amounts of acids.

Sanitary Effect of Lime.—The decomposition of organic matter in the soil often gives rise to products that are injurious to plant growth. While these generally disappear in time, the presence of lime often corrects the difficulty at once. It is also believed that plant roots excrete injurious substances. Lime neutralizes these objectionable substances.

Lime also affects plant diseases. It lessens the injury of club root, which is often serious in case of turnips, cabbages and other cruciferous plants. It is found to be effective in reducing soil rot of sweet potatoes and checking the root diseases of alfalfa. On the other hand, lime tends to favor the development of potato scab, providing the germ of this disease is already in the soil. In this case it encourages the disease and becomes a menace rather than an aid. For this reason, lime is seldom recommended for potatoes. If applied in a crop rotation which contains potatoes, it is advisable to apply it just after the potato crop rather than before.

Injudicious Use of Lime.—The injudicious use of lime may prove a detriment. Lime is not a fertilizer. To depend on it alone will result in failure. In the failure to recognize these principles lies the truth of the old saying, "Lime and lime without manure makes both farm and farmer poorer."

The excessive use of burnt lime may bring about the availability of more plant food than can be utilized by crops, and cause a rapid loss of it, in which case soil depletion is hastened. It is, therefore, good farm practice to use medium to small quantities at intervals of five or six years. Little is to be gained by applying more than is sufficient to meet the present needs of the soil from the standpoint of neutralizing its acidity.

Rate of Application.—The amount of lime to apply varies with the kind of lime, the requirements of the soil and the frequency of its application. If a soil is a tenacious clay and physical improvement is desired, an application of two or three tons of burnt lime per acre may be profitable. Ordinarily, lime is applied to correct acidity and make the soil friendly to clover and other plants. The equivalent of one to one and one-half tons of burnt lime per acre applied once in each crop rotation is usually a maximum amount. In some instances 1000 pounds per acre will accomplish the desired result. The equivalent of 1000 pounds of burnt lime is between 1300 and 1350 pounds of slaked lime, or a little less than one ton of finely pulverized raw limestone. Unusually large applications have emphasized the wastefulness of such applications so far as the needs of the soil and crops are concerned, through periods of five to six years. Large applications may last much longer, but they are more wasteful of lime, and result in capital being invested without returns.

Small applications are advised for sandy soils. On such soils the carbonate form is to be preferred. Wood-ashes, because of the form of lime and the content of potash, is advised for sandy soils.

Time of Applying.—Lime in any form may be applied at any time of the year. In general farm practice it is advisable to apply lime when men and teams are available for its hauling and distribution with the minimum interference with other farm work. There are some minor precautions, however, in this connection. It is never advisable to apply caustic lime in large amounts just prior to the planting of the crop. At least ten days

or two weeks should intervene between time of application and planting of the seed. The caustic effect may injure the young plants. In the soil lime is converted to the carbonate form and the caustic properties soon disappear.

Lime should usually pave the way for clover. It is well to apply lime a year or more before the seeding of clover. If this has not been done, it may be put on the land when the seed-bed is being made for the wheat, oats or other crop with which clover is to be seeded. The advantages of applying a year or two in advance of clover lie in the very thorough mixture of lime and soil resulting from the plowing and tilling of the soil.

Frequency of Application.—The frequency with which lime should be applied depends upon the character of the soil, the rate of application, the length of the crop rotation and the character of the crops grown. It may also be affected by climatic conditions and soil drainage. With good drainage and heavy rainfall the losses of lime will be large, while under reverse conditions they will be comparatively small. In crop rotations five years or more in length, one application at an appropriate place in each rotation should be sufficient. For shorter rotations one application for each two rotations may meet the needs. On soils that are extremely acid and where lime is scarce and high-priced, it may be desirable to make small applications at frequent intervals until the lime requirement of the soil is fully met. Sandy soils call for light applications at rather short intervals. On clay soils larger amounts can be used and the intervals lengthened.

Method of Applying.—Lime should be applied after the ground is plowed and thoroughly mixed with the soil by harrowing or disking. The more thoroughly it is mixed with the soil the better and quicker the results will be. It should never be plowed under, because its tendency is to work downward rather than upward in the soil. Apply lime with a spreader after the ground has been plowed. Do not drill lime in with seeds, nor mix it with commercial fertilizer, nor use it in place of fertilizer. Apply lime to meet the lime requirements of a soil, and when this has been done use manure and commercial fertilizers in the ways that have been found profitable for the crops which are to be grown, regardless of the fact that lime has been applied.

Relative Values of Different Forms of Lime.—The neutralizing effect of the different forms of lime is given under the carriers of lime on a preceding page. The question of relative money values, however, is a matter of arithmetic, and involves not only the first cost of unit weights of the different forms of lime, but includes freight rates, cost of hauling and the work of applying it to the land. In this connection the purity of the product must always be taken into account. Impurities entail the expense of freight and hauling of worthless materials, and increase the cost of the active portion of the lime. The cost of lime in any locality will depend largely on the presence or absence of limestone or some other

form of lime, together with the actual cost of quarrying, crushing or burning, as the case may be.

The following figures, as given by Mr. J. H. Barron in the *Tribune Farmer*, show the relative cost of equivalent amounts of three forms of lime applied to the land in southern New York. This will serve as a method for any region.

1 ton burnt lime at railroad station.....	\$4.00
Hauling.....	1.00
Cost of applying.....	1.50
Total cost per acre.....	\$6.50

The high cost of applying is on account of having to slake the burnt lime before it is applied, together with the difficulty in applying it in that form.

2640 pounds hydrated lime (equivalent to 1 ton burnt lime), at \$7.00 per ton.....	\$9.24
Hauling, at \$1.00 per ton.....	1.32
Applying, at 75 cents per ton.....	.99
Total cost per acre.....	\$11.55

The increased cost per acre in using this form is due to the relatively high first cost of hydrated lime and to the additional expense of hauling 650 pounds of water content in the hydrated lime.

In case of ground limestone we have the following:

3570 pounds ground limestone (equivalent to 1 ton burnt lime), at \$4.00 per ton.....	\$7.14
Hauling, at \$1.00 per ton.....	1.78
Applying, at 75 cents per ton.....	1.33
Total cost per acre.....	\$10.25

The above costs are probably considerably above the average for most localities where lime is not too inaccessible. The relative cost of ground limestone as compared with the burnt lime is also rather high.

It is good business to purchase that form which supplies the greatest amount of active lime for the amount of money involved, providing the mechanical condition is satisfactory. In this connection it should be borne in mind that no matter in what form lime is applied to the soil, it soon reverts to its original form of carbonate of lime. The advantages in using slaked burnt lime lie chiefly in the extreme fineness of subdivision and the possibilities of more thorough distribution in the soil.

Mixing with Manure and Fertilizers.—Caustic forms of lime should not be mixed with either manure or fertilizers. Such forms in the presence of nitrogenous materials cause a loss of nitrogen in the form of ammonia. In the presence of soluble phosphates they cause a reversion to insoluble forms. It is best, therefore, to apply lime in advance of applying fertil-

izers, and mix it with the soil by disking or harrowing. In case of manure which is plowed under, the application of lime may follow that of manure, being applied preferably after plowing.

The pulverized raw limestone may be applied with manure, or at the time of applying fertilizers, without injurious results.

Experimental Results.—Experiments with lime at many experiment stations and on all kinds of soils show that it makes little difference what form is used, so long as it is applied in sufficient quantities to meet the lime requirements of the soil, and is thoroughly and uniformly mixed with

the soil. At the Pennsylvania Experiment Station finely crushed limestone in each of three field tests extending over a number of years has proven slightly better than equivalent amounts of burnt lime. Extensive pot experiments at the same experiment station have shown that finely pulverized limestone is equally as prompt and effective in correcting soil

acidity and promoting the growth of clover as equivalent amounts of caustic lime. While these tests are favorable to pulverized limestone, they are not all sufficiently decisive to justify its use at a disproportionate price. If two tons of ground limestone cost much more than one ton of burnt lime, one would ordinarily not be justified in using the former.

Where lime must be shipped some distance, the more concentrated forms are usually the cheaper.

Spreading Lime.—The practice most common in the Eastern States is to place small piles of burnt lump lime at uniform intervals over the field, the amount in each pile and the distance between piles determining the rate of application. If the lime is to be spread promptly, about one-half pail of water should be applied to each pile, and then covered lightly with earth. This facilitates slaking, and the lime will be ready for distribution in a comparatively short time. In other instances the piles are allowed to remain without either wetting or covering with earth until weather conditions bring about complete slaking. Long periods of



THE OLD WAY OF SPREADING LIME.¹

After slaking, the piles are uniformly spread over the surface.

¹Courtesy of W. N. Lowry, Student.

rainy weather frequently prove disastrous by puddling the lime and causing it to get into bad physical condition.

Another method is to place the burnt lump lime in large stacks at the end of the field, and allow them to remain for several months until air slaked. From these stacks the lime is hauled either by wagon, manure spreader or lime spreader, and applied to the field. When the lime contains lumps the manure spreader gives best results in distribution. By screening, a lime spreader or fertilizer spreader with large capacity may be used with good results. Whatever method is used, an effort should be made to obtain uniform distribution at the desired rate at the minimum cost of time and labor. When slaked lime is spread with the lime spreader,



A MODERN LIME SPREADER IN OPERATION.¹

a canvas may be attached to the spreader which will reach to the ground, and by tacking a strip at the lower edge to cause it to drag on the ground, the disagreeable effect of the dust is largely overcome. Goggles for the eyes and a wet sponge for the mouth may prevent some of the disagreeable effects to the operator.

In the central states where pulverized raw limestone is extensively used, both manure spreaders and lime spreaders are found satisfactory in its distribution. One successful farmer finds that the work is most cheaply and effectively done by using a short-tongue distributor hitched close behind a wagon loaded with limestone. The limestone is shoveled into the distributor as the load is drawn across the field. On loose, plowed earth four horses are required to pull the load. In this way there is no extra handling of the lime, and the distribution is completed as soon as the wagon is unloaded. Many others have had good results with the manure spreader. Several methods have been practiced with this machine.

¹ Courtesy of The Webb Publishing Company, St. Paul, Minn. From "Field Management and Crop Rotations," by Parker.

Some apply the lime and manure together. When the limestone is to be applied at the rate of three tons per acre, 600 pounds on each load of manure in case of ten loads of manure to the acre, gives the desired amount.

Another method is to put a layer of straw in the bottom of the manure spreader, set the spreader for its minimum rate of distribution, and load in the amount of lime that will give the desired rate of application. For distribution at the rate of three tons per acre, this will generally require not more than one ton.

Slaking Lime.—Lime in large quantities may be satisfactorily slaked by applying about two and one-half pails of water to each barrel of lime

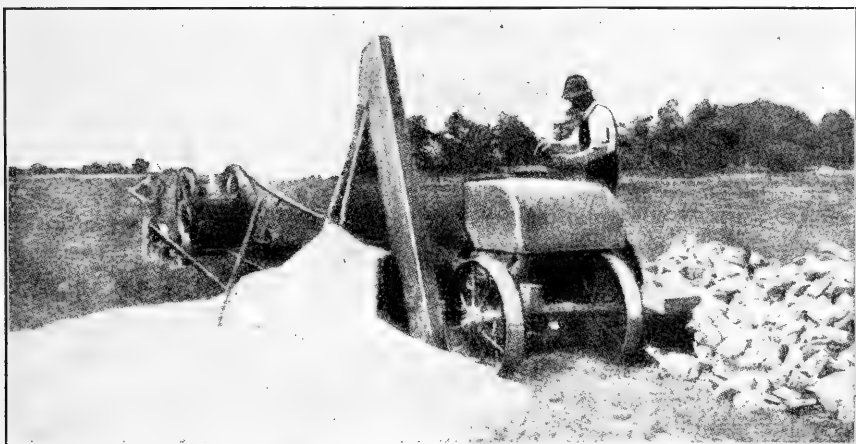

A LIME CRUSHING OUTFIT SUITABLE FOR THE FARMER.¹

as it is unloaded in the field. Eventually the whole stack should be covered with soil. In a few days all of the lime will be thoroughly slaked, and in a fine, dry condition suitable for spreading.

Crushing vs. Burning Lime.—The use of finely pulverized raw limestone has created a demand for machinery for crushing lime rock. There are now on the market quite a number of portable machines suitable for farm use. In some localities where limestone is easily accessible it can be quarried and finely pulverized with these machines at a cost of \$1 to \$1.50 per ton. This puts it within the reach of farmers at a moderate price.

Lime is burnt in several ways. The simplest way on the farm is to make a stack of lime rock with alternating layers of wood or coal. This is built in a conical form with an intake for air at the bottom and an opening at the top for ventilation. The stack is covered with earth and the fire lighted.

¹ Courtesy of New York Agricultural Experiment Station, Geneva, N. Y. Bulletin 400.

More effective burning is secured by burning limestone in a kiln constructed of stone or masonry. In either case the cost per ton of burning varies with the cost of fuel, the price of labor and the accessibility of

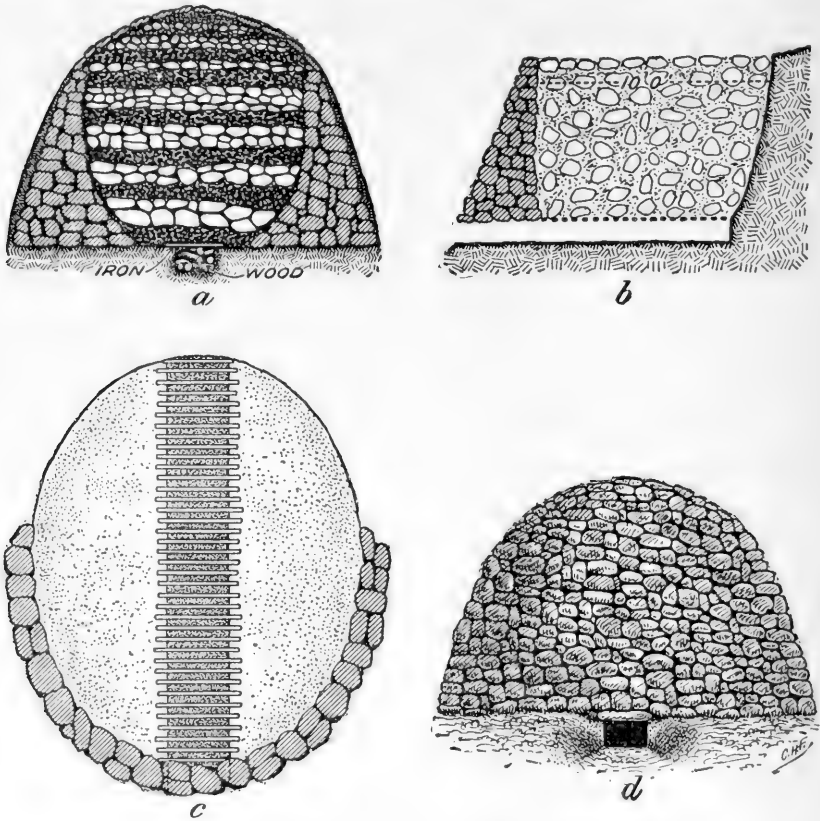

DETAILS OF CONSTRUCTION OF A FARM LIMEKILN.¹

A—Cross section, showing layers of rock and coal. B—Longitudinal section, showing side hill used as back wall. C—Ground plan, showing trench and grate. D—Completed kiln, walled in and plastered with mud.

limestone. The minimum cost for burning, including quarrying, labor and fuel, will be about \$1.75 per ton of burnt lime. In many cases it will cost much more.

REFERENCES

Alabama Expt. Station Bulletin 95. "Lime as a Fertilizer for Oats."
 Iowa Expt. Station Bulletin 151. "Lime as a Fertilizer on Iowa Soils."

¹From Farmers' Bulletin 435, U. S. Dept. of Agriculture.

- Iowa Expt. Station Bulletin 2. "Bacteriological Effects of Lime."
New Jersey Expt. Station Bulletin 210. "Lime as a Fertilizer for Clover and Oats."
Ohio Expt. Station Bulletin 279. "Lime as a Fertilizer."
Pennsylvania Expt. Station Bulletin 131. "Use of Lime on Land."
Rhode Island Expt. Station Bulletin 49. "Methods of Applying Lime."
Rhode Island Expt. Station Bulletin 58. "Lime with Phosphates on Grass."
Rhode Island Expt. Station Bulletin 160. "Lime with Nitrogenous Fertilizers on Acid Soils."
Tennessee Expt. Station Bulletin 96. "Effect of Lime on Crop Production."
Tennessee Expt. Station Bulletin 109. "Lime as a Fertilizer on Tennessee Soils."
Virginia Expt. Station Bulletin 187. "Lime as a Fertilizer on Virginia Soils."
Wisconsin Expt. Station Bulletin 230. "Lime as a Fertilizer on Wisconsin Soils."
Pennsylvania State Dept. of Agriculture Bulletin 261. "Sour Soils and Liming."
U. S. Dept. of Agriculture, Bureau of Chemistry, Bulletin 101. "Lime Sulphur Wash."
Farmers' Bulletin, U. S. Dept. of Agriculture, 435. "Burning Lime on the Farm."

CHAPTER 7

SOIL WATER, ITS FUNCTIONS AND CONTROL

Water is the most abundant substance in nature. It is necessary to all forms of life. An abundant supply of moisture in the soil at all seasons of the plant's growth is essential to a bountiful harvest. Sixty to ninety per cent of all green plants consist of water. About forty per cent of the dry matter is made from water which unites with carbon to form the structure of the plant. Water is the necessary vehicle which

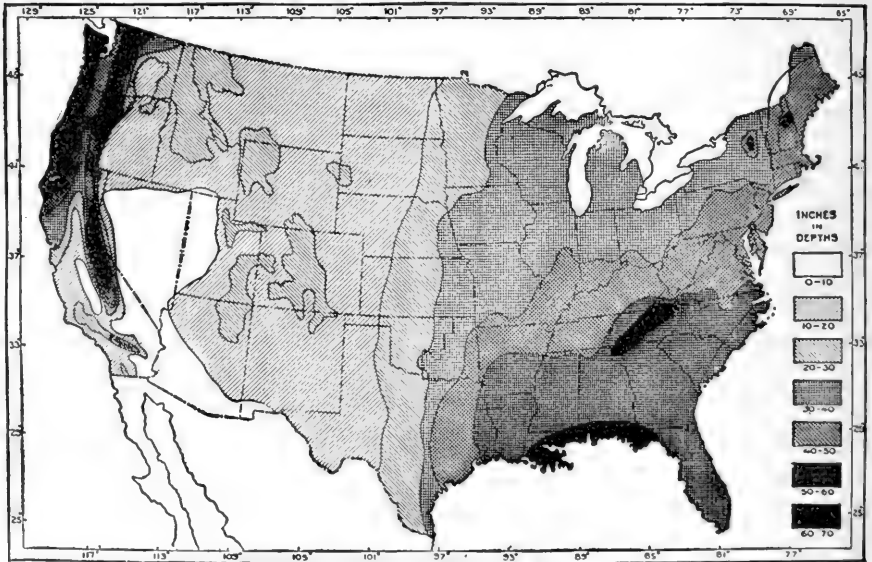

MAP SHOWING MEAN ANNUAL RAINFALL FOR ALL PARTS OF THE UNITED STATES.¹

carries plant food to the plant, and causes it to circulate from one portion of the plant to another. When there is a deficiency of water in the soil, plant growth is checked. If the deficiency becomes sufficiently marked, plant growth ceases entirely.

Amount and Distribution of Rain.—All water comes from rains and melting snows. An acre inch of rain makes 113 tons of water. To supply the equivalent of one inch of rainfall by artificial means at 10 cents per ton of water would cost \$11.30 per acre. Ten inches of rain-

¹ Courtesy of Doubleday, Page & Co., Garden City, N. Y. From "Soils," by Fletcher.

fall at the same rate would cost \$113 per acre. From this it can be readily understood that artificial means of supplying plants with water must be done at a very low cost, otherwise it will not prove profitable.

The amount of rain in any region is important in connection with crop production. In all regions where the annual rainfall averages less than twenty inches, failures from insufficient moisture in the soil are frequent. The distribution of the rain is quite as important as the total annual rainfall. That which falls during the crop-growing season is more important than that which comes in the non-growing season. Consequently, there are regions of comparatively low rainfall where the distribution is so favorable that crop failures are infrequent. In other localities a large part of a good annual rainfall may come in the non-crop-growing season, and as a result, crops frequently suffer from drought. In moving from one region to another it is well to study the average rainfall and its distribution.

Amount of Water Necessary to Produce Crops.—In the processes of plant growth the amount of water transpired or given off by plants is many times greater than that used in the plant tissues. Investigations in different parts of the world and at several of the American experiment stations show that in plant growth the amount of water required to produce a pound of dry matter ranges from 200 to 700 pounds. This amount must actually pass through plants. Each ton of dry matter in alfalfa takes 700 tons of water. Each ton of dry matter in wheat required about 400 tons of water; in oats, about 500 tons; and in corn, about 300 tons. To produce three tons of alfalfa in one season requires from 16 to 17 inches of rainfall, all of which must pass through the plants. A 20-bushel crop of wheat would require about 6 inches, and 40 bushels of oats $6\frac{1}{2}$; while 50 bushels of corn would require about $8\frac{1}{2}$ inches of rainfall. For crops of the yields mentioned there should be more rainfall during the growing season than above indicated, because of the loss of water by direct evaporation from the soil, plus additional amounts that may flow from the surface if the rain falls rapidly, together with some that may pass through the soil into the underdrainage.

Transpiration by Plants.—Transpiration, or the amount of water that passes through the plant and is evaporated from the surface of the leaves, varies greatly in different localities, and is influenced by a number of factors. Transpiration takes place most rapidly during the day-time and in the presence of plenty of sunshine and warmth. During the night-time it is reduced to a very small amount. Transpiration is increased with a reduction of the humidity of the air, with rise in temperature and with intensity of sunshine. It is also increased with an increase in the movement of the air. An increase in plant food tends to decrease it, as does also a rapid growth of the plant. Transpiration is more rapid in the presence of an abundance of soil moisture than it is when the soil is dry.

Experiments at the University of Illinois by Dr. Hunt showed an

increase per acre in the dry matter in corn amounting to 1300 pounds in one week in July. On the basis of requiring 300 pounds of water for each pound of dry matter, the consumption of water by the growing corn in one week would equal 1.72 inches of rain. This, of course, is for a single week in the height of the growing season, but it shows the large amount of rainfall required to meet fully the needs of a large and rapidly growing crop. It should emphasize the importance of storing in the soil the largest possible amount of available water to tide over periods of deficiency in rainfall.

Forms of Soil Water.—Water exists in the soil in three forms: (1) gravitational water, or that which is free to move through the soil under the influence of gravity; (2) capillary water, or that which is held against the force of gravity by capillary power or, as it is sometimes called, surface tension; (3) hygroscopic water, or that which adheres to the soil particles so firmly that it will not be given off, even when the soil becomes dry. Not all of the water in the soil is available for plants. Very few of our economic plants use any of the gravitational water of the soil, except as it may rise by capillarity and be used from the capillary store which it replenishes. It is also certain that plants cannot benefit from the hygroscopic water of the soil, because they are unable to get it from the soil particles by which it is so tenaciously held in this form. The capillary water is, therefore, the one form that is of importance in plant growth. The relative amounts of the three forms of water in the soil depend on a number of factors.

The amount of pore space in soils ranges from 35 to 60 per cent of the volume of the soil. When there is no underdrainage and a superabundance of rain this space may become fully occupied with water to the exclusion of air. The soil is then said to be saturated. If rains cease and underdrainage is established, the gravitational water will escape by means of the drainage channels. The amount which will escape in this way is determined chiefly by the texture of the soil and the percentage of pore space in it. The larger the pore space, the greater the amount of water that will escape in this way; the finer the texture of the soil, the larger the amount held by capillarity and the less the amount that will escape by drainage.

Capillary Water.—This is the important portion of the soil water supply. It is the form on which plants wholly depend for their water supply. Plants cannot exhaust from the soil all of the capillary water, because a portion of it will be too tenaciously held by the soil particles to be removed by the plant root hairs. The optimum, or most favorable percentage of water in the soil for plants, differs for different crops. Such crops as corn and potatoes do best with a moderate percentage of water in the soil, which gives opportunity for plenty of air. Such plants as timothy, redtop and other grasses do best when the percentage of water in the soil is somewhat higher. Field experiments have shown that when

the water content of the soil is increased 25 per cent above the optimum percentage, plants begin to suffer as a result of too much moisture, and when the moisture falls 25 per cent below the optimum, they suffer from drought.

The amount of capillary water in the soil is determined chiefly by its texture. The following table shows the percentage of water held by soils ranging in texture from coarse sand to clay, when subjected to a



EFFECT OF LITTLE, MEDIUM, AND MUCH WATER ON WHEAT.¹

centrifugal force 2940 times that of gravity. A coarse sand held only 4.6 per cent of moisture, while clay held 46.5 per cent or ten times as much. The water held under natural conditions by the several classes of soil given in the table would be much larger, but the relative amounts would be the same.

CAPILLARY MOISTURE IN SOIL.

Class.	Percentage of Clay in Soil.	Percentage of Moisture Retained against Force 2940 Times that of Gravity.
Coarse sand.....	4.8	4.6
Medium sandy loam.....	7.3	7.0
Fine sandy loam.....	12.6	11.8
Silt.....	10.6	12.9
Silt loam.....	17.7	26.9
Clay loam.....	26.6	32.4
Clay.....	59.8	46.5

Capillary water is also influenced to some extent by the structure of the soil, and to somewhat greater extent by its content of humus or

¹ Courtesy of The Macmillan Company, N. Y. From "Principles of Irrigation Practice," by Widsöe,

organic matter. Soils of fine texture and those having plenty of organic matter hold the largest amount of capillary water, and are able to withstand periods of drought better than those with a lesser capacity.

Plant roots move toward the water supply in the soil, and as they withdraw water from the soil particles, water moves to those points by capillary action to replace that removed. The rate of capillary movement is slowest in soils of fine texture, and is most rapid in sandy soils. The distance through which capillary power acts on the other hand is least in sandy soils, and greatest in soils of fine texture. We find, therefore, that plant roots are most extensive in sandy soils and extend to greater depths in search of a water supply.

Gravitational Water.—Since gravitational water is but little used by plants, it becomes a menace in soils more often than a benefit. Over large areas of comparatively level land where there is an abundant rainfall, it often becomes necessary to remove the gravitational water by means of various forms of drainage. The movement of gravitational water within the soil depends chiefly on the texture and structure of the soil. The amount that needs to be removed under agricultural conditions depends chiefly on the rainfall of the region and the amount that escapes over the surface of the land. The depth to which this gravitational water should be removed will be determined chiefly by the character of crops to be grown. Seldom is it advisable to place underdrains for this purpose at a depth of less than three feet. For deep-rooted crops, such as alfalfa and orchard fruits, four feet and sometimes more is advisable.

While this form of water may be injurious to upland plants, when it exists at a depth of from four to six feet below the surface it does no harm and serves as a reservoir from which water may be drawn by capillarity to meet the losses above by evaporation and plant removal.

Hygroscopic Water.—The water which is held by the soil when a thin layer is spread out and allowed to become air dry is called hygroscopic moisture. When this soil is placed in an oven and heated to the temperature of boiling water for several hours, it loses its hygroscopic water and becomes water free. The amount of this form of water held by soils varies directly with the texture of the soil and may amount to as much as 16.5 per cent in case of clay, while in a muck soil it may be as high as 50 per cent. The percentage of hygroscopic water will also be influenced by the temperature and humidity of the air with which it comes in contact.

Water Affects Temperature of the Soil.—A requisite degree of warmth in the soil is essential to physical, chemical and biological processes that make for soil fertility. Warmth is essential to the germination of seeds and growth of plants. The chief source of warmth in the soil is from the sun. The rapidity with which a soil warms under the influence of the sun depends more largely on its water content than on any other factor. One pound of water requires four times as much heat to increase its tem-

perature one degree as would be required by an equal weight of soil. An excess of water in the soil, therefore, greatly lessens its rate of warming. In wet soils much evaporation of water takes place at the surface. It requires more than five times as much heat to transform one pound of water from liquid to vapor as it does to raise the temperature of an equal weight of water from the freezing to the boiling point. In other words, the heat consumed in the process of evaporation is sufficient to cause a change of 900 degrees in temperature in an equal volume of water. This fact emphasizes the importance of removing surplus water by means of drainage, instead of allowing it to evaporate from the surface of the soil. An amount of evaporation sufficient to maintain a proper soil temperature in prolonged heat periods may be desirable, but excessive evaporation is undesirable in temperate latitudes, especially during the early growing season. Reduced temperature as the result of such evaporation often causes disaster during the seeding or planting season and retards the early growth of crops.

Water Storage Capacity of Soils.—Since the rains of summer are rarely fully adequate to meet the needs of growing plants, it is essential to increase the storage capacity of the soil as far as possible. For this purpose, the chief agencies are plowing, methods of tillage and the use of organic manures. Deep plowing and the incorporation of organic matter to the full depth of plowing will increase very materially the capacity of the soil for water. In conjunction with this, the soil should be so cultivated that it will receive the rainfall and thus have an opportunity for holding it. This means the maintenance of a porous surface so that rainfall will not escape over the surface until the soil has become filled with water.

Those crops endowed with the power of deep-root penetration, such as alfalfa, can draw their moisture from greater depths in the soil than shallow-rooted crops. In regions of low rainfall this amounts to the same thing as increasing the storage capacity of the surface portion of the soil.

Moisture Conservation.—The practical conservation of soil moisture is effected chiefly by preventing direct evaporation from the surface of the soil, and also by exterminating all foreign plants in the nature of weeds that tend to rob the crops of their moisture supply. Evaporation is most economically reduced to the minimum by surface tillage and the establishment of an earth mulch. The earth mulch to the depth of two or three inches is formed by periodic cultivation or a stirring of the surface of the soil so as to break the capillary action with the soil immediately beneath. The efficiency of such mulches depends largely on the perfection with which they are made. A surface mulch to be effective should consist of rather finely pulverized loose soil. This becomes dry to such an extent that the soil moisture film is discontinuous and water ceases to rise to the immediate surface. In this condition, any loss that takes place

must result from the escape of water within the soil pores. A little loss will take place in this way. Such mulches must be renewed at intervals more or less frequent, depending on the rainfall and the rapidity with which the surface soil may become compacted. In the absence of rains, a well-established mulch will last for a long time. On the other hand, a comparatively light rain will spoil the mulch and establish capillary connection with the soil below.

Mulches of straw, manure and other organic materials are some-



ORCHARD WELL CULTIVATED TO PREVENT EVAPORATION.¹

times used. These are very effective, but are often expensive. Such mulches are most common in orchards in case of small fruits, strawberries, and sometimes for potatoes and tomatoes.

Where green manuring crops which are to be followed promptly with money crops are used, it is well to take the precaution to plow these under before they have thoroughly exhausted the moisture supply of the soil. Precaution should also be taken in plowing under green manure crops and barnyard manure to avoid possibility of cutting off the capillary connection between the plowed and unplowed portion of the soil.

¹ Courtesy of The Macmillan Company, N. Y. From "Principles of Irrigation Practice," by Widtsoe.

Removing Excess of Water.—Excess of soil water pertains only to that above described as gravitational water. This may be removed by deep; open drains and by underdrains. Methods of drainage will be discussed in another topic.

On comparatively level lands where surface water often accumulates, its escape may be encouraged by so plowing the land that it will lie in slight ridges and continuous depressions. If the depressions have a continuous fall, all of the surface water will slowly escape from the land into natural drainage channels and without causing erosion.

Excess of water is sometimes removed by the use of crops, although this does not pertain to gravitational water. In most localities it is desirable to have the growth of orchard trees cease as the season draws to a close, in order that the wood may harden and withstand winter freezing. For this purpose orchards are frequently planted with crops that draw heavily on the soil moisture for the purpose of so exhausting it that the growth of the trees will be checked. This serves not only a good purpose with reference to the condition of the orchard, but produces organic matter that may be plowed under for the benefit of the soil and the trees.

LAND DRAINAGE

A wet soil is cold and late. It can seldom be plowed and tilled at the proper time. Most farm crops do not make satisfactory growth in a wet soil, and, therefore, it seldom pays to farm such land.

Wet lands, when drained, are generally above the average in fertility. Money invested in drainage seldom fails to bring good returns. In many cases the increase in crops, following drainage, has paid for its cost in one year.

Drainage Increases Warmth and Fertility of Soil.—When an excess of soil water is removed through underground drains it permits the soil to warm up rapidly under the influence of the sun; lengthens the growing season; increases the number of days during which the soil is in good condition to plow; increases aeration of the soil; encourages the deep penetration of the roots of plants, and as a result makes the plants resistant to drought. Drainage is, therefore, the first essential to soil fertility.

Improves Health Conditions.—Drainage also improves health conditions. The drainage of large areas of swampy land in the vicinity of populous districts has often been undertaken for this purpose alone and without any regard to the increased agricultural value of the land. Large portions of the prairie region when first settled were sufficiently wet to furnish abundant breeding places for mosquitoes. The great numbers of mosquitoes were not only a great annoyance, but were responsible for thousands of cases of malaria, which greatly reduced the health and efficiency of people living in that region. Tile drainage that has been so extensively established in most of that region has practically abolished

breeding places for mosquitoes, and caused their disappearance to such a degree that malaria is now practically unknown in that region.

Open vs. Underground Drains.—The gravitational water in the soil may be lowered to the depth of two or three feet below the surface by open drains, but the same can be more economically effected by the installation of underground drains. Open drains waste much land, the ditches are subject to erosion and their presence interferes with cultural operations. They are also expensive to maintain, because of the necessity of annually cleaning them.

Underground or tile drains are more effective than open ones. They waste no land, require practically no outlay for annual maintenance, do not interfere with cultural operations and are permanent. The cost of excavating for underground drains is less than that for an equal length of open drains, because in the former very narrow trenches are excavated which are filled as soon as the tile is in place.

Quality of Tile.—Burned clay pipes are almost universally used for soil drains. They are made in sections, from 12 to 24 inches long, having an internal diameter ranging from 3 to 16 inches. Since the installation of underground drainage is to be permanent, care should be exercised in the selection and purchase of the tile. Only the straight, well-burned tile should be used. A well-burned tile is generally dark in color, and gives a decided ring when struck with a light metal. Formerly it was thought that such tiles should be quite pervious to water, but it is now understood that the openings at the joints are ample to admit the water from the soil as fast as it can reach the lines of tile.

Cost of Tile and Excavating.—The cost of installing underground drainage depends on the cost of the tile laid down on the land, the frequency of the underground lines of drainage as determined by the permeability of the soil to water, together with the cost of digging the trenches as determined by the ease or difficulty in excavating the soil. The cost of the tile will vary with the locality, the freight charges and the distance they must be hauled. In general, the price of the tile per 1000 feet F. O. B. cars, at the factories, will be as follows:

Size.	Price.
3 inch	\$10.00-\$12.00
4 "	15.00- 20.00
5 "	20.00- 27.00
6 "	27.00- 35.00
7 "	36.00- 50.00
8 "	45.00- 60.00
10 "	60.00-110.00
12 "	90.00-150.00

The cost of digging the trenches will vary greatly with the character and condition of the soil to be excavated, the skill of the digger and the prevailing cost of labor in the locality. Deep trenches cost relatively more to excavate than shallow ones, because the trenches must be wider

at the top to accommodate the workman, and the earth in the bottom of the trenches is more difficult to remove. Where the soil is free from stones and hardpan, trenches are frequently excavated to the depth of three feet, and the tiles placed ready for filling the trenches, at a cost of thirty cents per linear rod. Below the depth of three feet and up to five feet, excavating under similar conditions will cost about one cent per inch per rod.

Depth and Frequency of Drains.—The depth at which to place the tile drains will be determined by the class of crops to be grown and the character of the subsoil. Three feet in depth is considered ample for most farm crops, but for orchards, alfalfa and especially deep-rooted crops, a depth of four feet is preferred. There are many localities, however, where the impervious character of the subsoil is such that tiles can be placed only twenty-four or thirty inches deep, and permit the water to enter. Even under these conditions, tile drainage is generally advisable.

The distance between lines of drain will depend chiefly on the character of the soil, with special reference to its permeability to water. A soil and subsoil that is sandy or loamy in character will frequently be satisfactorily drained with lines of tile 200 to 300 feet apart. On the other hand, a dense clay will sometimes necessitate the lines of drains being placed at intervals of not more than 30 to 40 feet. This, of course, makes underdrainage much more expensive than in the former case. The deeper the tile is placed the farther the lines may be apart.

Where land to be drained is uniformly wet, the gridiron or regular system is to be preferred. The irregular system will answer the purpose for the drainage of wet spots or sloughs. The main lines should follow approximately the natural depressions or water courses, while the laterals may run up and down the slopes. Rather long parallel lines are more economical than short ones with numerous branches.

Grades, Silt Basins and Junctions.—All lines of underdrainage should be laid with uniform grades. If the topography of the land necessitates a change in the grade, in which the grade in the lower portion of the line is less than in the upper portion, a silt basin should be placed at the point where the change of grade takes place. When the reverse is true, a silt basin is not necessary. Where laterals enter a main or sub-main which has a lesser fall than the laterals, silt basins should also be installed. Laterals should enter the main above the center of the pipe, rather than below it. All junctions should be made at an angle of about forty-five degrees up-stream. A fall of one foot in one hundred feet is considered a heavy grade. A fall of one inch in one hundred feet will give good results, although more fall than this is better. In the level prairie sections of the country hundreds of miles of tile are laid with a grade of only one-half inch in one hundred feet, and where great care is exercised in laying the tile, difficulty has seldom been encountered.

On level land a fair grade may be obtained by gradually lessening

the depth of the tile from the lower to the upper end of any branch. In a drainage line 1200 feet in length a fall of one inch in each hundred feet may be obtained by having the lower end of the line $3\frac{1}{2}$ feet below the surface of the ground, and the upper end $2\frac{1}{2}$ feet below the surface, even though the land along this line is absolutely level.

The Outlet.—The first essential for a satisfactory system of underground drainage is a good outlet. The outlet must be the lowest point in the whole drainage system, and water should seldom, if ever, stand above the opening of the tile.

The outlet of the main should be protected by a screen in such a way that rabbits and other animals cannot enter. At the outlet the tiles are subject to freezing more than elsewhere in the system, as a result of which they may be broken. It is well to provide for this by using a wooden box, or an iron pipe as a substitute for the earthen tile. This should extend back from the opening six or eight feet to a position where it will not become frozen.



WATER ISSUING FROM AN
UNDERGROUND DRAIN.¹

Size of Tile.—The size of the main outlet or line is determined by the area to be drained, together with the water-shed contributory to it. Not only must we figure on removing all of the rainfall that descends directly on the land to be drained, but we must also calculate on the amount

of water that reaches such land from adjacent higher land, whether as surface wash or underground seepage. The maximum amount of water necessary to remove from the land in order to effect satisfactory drainage will depend chiefly on the rainfall likely to occur in short periods of time during the growing season. It will seldom be necessary to provide for the removal of more than one-half inch of water in twenty-four hours. On this basis a system of tiles flowing at full capacity will remove rainfall at the rate of fifteen inches per month. This is much in excess of the usual rainfall in any part of the country. The removal of one-quarter inch of rainfall in twenty-four hours will generally provide adequate drainage. The size of tile required to accomplish removal of water at the above mentioned rate will be determined largely by the grades that it is possible to secure. The size of tile required is given in the chapter on "Drainage and Irrigation."

¹Courtesy of Orange Judd Company. From "Soils and Crops," by Hunt and Burkett.

REFERENCES

- "Dry Farming." MacDonald.
"Dry Farming." Widtsoe.
"Dry Farming." Shaw.
Kansas Expt. Station Bulletin 206. "Relation of Moisture to Yield of Wheat in Kansas."
Nebraska Expt. Station Bulletin 114. "Storing Moisture in the Soil."
Utah Expt. Station Bulletin 104. "Storage of Winter Precipitation in Soils."

CHAPTER 8

GENERAL METHODS OF SOIL MANAGEMENT

The art of soil management consists in so manipulating the two million pounds of soil constituting the average plowed portion of each acre, that it will give the largest returns without impairing the soil. The best chance of attaining success in the art of soil management is in the hands of the man who best understands the principles underlying it. The art of soil management is the result of more than 4000 years of accumulated experience, while the science is very much a matter of yesterday. It is not to be expected that science will revolutionize the art, but it will explain why many operations are performed and will also suggest improvements in the manner of performing them. There are no definite rules relative to methods of soil tillage. The best way of performing a certain operation of soil tillage at any particular time and place is generally a matter of judgment on the part of the farmer. Accuracy in judgment on his part is greatly strengthened through knowledge of the underlying principles.

Objects of Tillage.—The chief objects of tillage are: (1) to improve the physical condition of the soil; (2) to turn under plant residues that have accumulated at the surface and incorporate them with the soil; (3) to destroy weeds; and (4) to provide a suitable seed-bed.

In recent years great changes have taken place in the methods of tillage, due chiefly to the invention and use of labor-saving implements. In this connection it is well to know the approximate duty of the cultural implements that are available. In a general way the duty of a cultural implement is obtained by multiplying the width in feet which it covers in passing over the field by 1.4. For example, a 12-inch plow will plow, on an average 1.4 acres of land per day. A harrow 6 feet in width would harrow 8.4 acres. The duty will vary somewhat with conditions, such as speed in process of operation, the length of day and percentage of time when not in actual operation. With good fast-walking teams and implements of light draft, the acreage covered per day may be somewhat increased. On the other hand, if much time is lost, if the teams are slow or if implements are of heavy draft, the acreage will be reduced. These facts are important in connection with determining the extent of equipment required to perform satisfactorily the operations on a farm of given size.

Plowing.—Plowing is the most expensive tillage operation in connection with crop production. For this reason it is important to know when it is necessary to plow the land and how deep it should be plowed,

since both depth and frequency of plowing bear directly on the cost of the operation. Mold-board and disk plows are used for this purpose. Either of these implements turn the soil, pulverize it and cover rubbish. The implement to be preferred is determined largely by the character of the soil and its condition. Disk plows work best in rather dry soil. Mold-board plows are much more extensively used and will work under a wider range of soil conditions. The form of the mold-board plow varies considerably, and different forms are applicable to different purposes and different soils. The sod plow has the minimum curvature and inverts



A DEEP TILLING DOUBLE-DISK PLOW.¹

the furrow slice with the least pulverization of the soil. The stubble or breaking plow has much more curvature of the mold board, and gives more thorough pulverization of the soil. The greater the curvature of the mold board and the more thorough the pulverization of the soil as a result of it, the heavier will be the draft. Sharpness of the share and smoothness of the plow surface tend toward lightness of draft. The presence of roots and stones may somewhat increase the draft of plows. The texture, structure and physical condition of the soil, especially with reference to its water content, greatly influence draft. The soil plows

¹ Courtesy of The Spalding Tilling Machine Company, Cleveland, Ohio.

most easily when it is in a fairly moist condition and most easily pulverized. The draft of the plow will be increased both when the soil is too wet and when it is too dry.

Coulters and jointers are both attached to plows to influence draft and improve the character of plowing. Coulters are for two purposes: (1) those which cut the roots separating the furrow slice from the unplowed land, and (2) those which cut vines and rubbish, preventing their dragging across the plow standard and clogging the plow. Rolling coulters are best for the latter purpose, while standard cutters may be equally as good for cutting the roots in the soil. The chief object of the jointer is to push the surface rubbish into the furrow so that it will be more completely covered. Sulky plows are often used instead of walking plows. The chief advantage in the sulky plow is in reducing the labor of the plowman and in more effective plowing. It is claimed that sulky plows reduce the draft of the plow by relieving the friction on the bottom and land side of the furrow. Under most favorable conditions there may be a slight reduction in draft, but under average conditions the weight of the sulky and the plowman more than offset the reduced friction.

Plowing at the same depth many years in succession often gives rise to a compacted layer just below the depth of plowing, known as plow sole or hardpan. This is a fault which may be avoided by changing slightly the depth of plowing from year to year. The plowman often looks with pride on what may be poor plowing. The furrow slice should not be completely inverted like a plank turned the other side up, but one furrow slice should lean against the previous one in such a way that the rubbish will be distributed from a portion of the bottom of the furrow nearly to the surface of the plowed ground. At the same time a portion of the furrow slice should be in direct contact with the soil below. This permits good capillary connection for a portion of each furrow slice. When there is an abundance of rubbish to be turned under, it is often wise to disk the land before plowing. This loosens the surface of the soil and causes some mixture of it with the rubbish. When plowed under in this condition it does not form so continuous a layer to cut off capillary water from below. Disking in advance of plowing in case of rather compact soil also facilitates the pulverization of the furrow slice and results in a better pulverized seed-bed.

Time of Plowing.—The best time to plow depends on many conditions. There is no particular season that will be better than other seasons under all conditions. The old maxim, "Plow when you can," is a good one to follow. Plowing done in the fall or early winter lessens the rush of work in the following spring, and under most conditions fall plowing gives better results than spring plowing. Fall plowing in temperate latitudes subjects the exposed soil to the elements and results in destruction of insects and a thorough pulverization of the soil, due to freezing and thawing. Fall plowing should neither be harrowed nor disked, but left in a

rough condition in order to collect the rains and snows during the winter. This will result in storage of the winter rainfall and prevent erosion, unless by chance the land is steep and rains are very heavy. Under the latter conditions it may not be wise to practice fall plowing. In warmer latitudes plowing may be done during the winter, and when land is plowed in the autumn it should be seeded with a cover crop to prevent erosion. In the Northern states and Canada fall plowing is generally recommended, but in the South spring plowing is considered preferable. Spring plowing, unless it be very early, should be harrowed soon afterward in order to



A BADLY ERODED FIELD.¹

Damage of this character reflects no credit on American agriculture.

conserve soil moistures. Generally it will be found good practice to harrow towards the close of each day the land that has been plowed during the day. If the soil is rather dry and weather conditions very dry, it may be better to harrow it each half day. In case of sod and compact soil, disking in advance of plowing is advised.

Depth of Plowing.—The depth of plowing is determined by the character of the soil and the kind of crop to be grown. In general, fall plowing should be deeper than spring plowing. Deep-rooted crops call

¹Courtesy of United States Department of Agriculture, Bureau of Soils. From "Soil Survey of Fairfield County, South Carolina."

for deeper plowing than shallow-rooted ones. For corn, potatoes and heavy truck crops, deep plowing is generally advised. For oats, barley, flax, millet and other spring annuals, shallow plowing generally gives as good results as deep plowing, and at a less cost. In the long run, deep plowing for most soils is to be recommended. Deep plowing increases the depth of soil from which the mass of plant roots draw moisture and plant food; it increases the water-holding capacity of the soil; it incorporates the organic matter to a greater depth in the soil; it enables the soil to receive and hold the rainfall, thus reducing erosion.

Where shallow plowing has been the practice, the depth of plowing should be increased gradually, one-half inch to one inch each year, until the desired depth has been obtained. This gives better results than increasing to the full depth at once. On virgin land with deep soil shallow plowing during the early years of cultivation may give as good results as deep plowing. Much depends on the nature of the soil, and wherever the soil at the depth of six to ten inches is compact, deep plowing and the incorporation of organic matter will improve it.

Subsoiling.—Subsoiling pertains to loosening the subsoil below the usual depth of plowing. Subsoil plows are constructed to run to a depth of sixteen to eighteen inches, with a view of loosening and slightly lifting the subsoil. It is neither turned nor brought to the surface. Such a practice is even more expensive than plowing and, consequently, more than doubles the cost of the preparation of the land for crops. While it may prove beneficial, many tests indicate that the practice does not generally pay for the expense involved. Doubtless much will depend upon the value of the land, the character of subsoil and the nature of the crops to be grown. On valuable land having impervious subsoil, and for high-priced crops, it may frequently pay. How long the benefits from subsoiling will last is determined by the rapidity with which the soil returns to its former compact condition. Heavy rains and thorough saturation with water often soon overcomes the benefits of subsoiling. As a general practice, subsoiling is not to be recommended. It might prove beneficial in semi-arid regions as a means of increasing the water storage capacity of the soil to tide over long periods of drought. In such regions the beneficial results are likely to be more lasting than where the rainfall is heavy. Both in practice and theory deep plowing is preferable to subsoiling.

Disking.—There are two forms of disk harrows: (1) having a solid disk, and (2) having a serrated disk and known as the cutaway disk. The latter is generally lighter than the former, is adapted to stony and gravelly soil and for light work. The full disk is more generally used, although in double disks both the full disk and the cutaway disk are sometimes combined in the same implement. The disk harrow stirs the soil to a greater depth than do most other forms of harrows. It is especially useful on land that has been plowed for some time and has become somewhat compacted. Fall plowing and early spring plowing,

when being prepared for medium to late planted crops, should generally be gone over once or twice with the disk.

A large portion of the spring oats in the Central States are seeded on land prepared by the use of the disk and harrow, and without plowing. The disk is the most effective implement in the preparation of the seed-bed for oats. This method of preparing the land enables farmers to accomplish early seeding on a large scale. Early seeding of oats is important in connection with good yields.

Harrowing.—There are many forms of harrows varying in style of teeth, number of teeth, weight and adjustment. The steel frame harrow with levers to adjust the teeth, built in sections that are joined together, is generally preferred. The size or width of the harrow is usually determined by the number of sections it has. It is an implement of light draft, and to be effective should be used in the nick of time. Repeated harrowing is often advised (1) for the purpose of maintaining a surface mulch to conserve moisture, and (2) to destroy weeds just as they start growth. The spring-toothed harrow is effective in stony and gravelly soil, and tends to loosen the soil more than the spike-toothed harrow. The former is best for destroying weeds and loosening the soil, while the latter is preferable for soil pulverization and for covering small seeds that are broadcasted, such as clovers, grass seeds and the millets. While the harrow is generally used just prior to seeding and planting, it is found to be a good practice to harrow such crops as corn and potatoes after planting, and sometimes even after they are up. Such harrowing is often fully as effective in destroying weeds and pulverizing the soil as a good cultivation would be. It is much more rapidly and cheaply done than cultivating.

Planking or Dragging.—The plank drag is a cheap implement consisting of three or four two-inch planks fastened securely together with the edges overlapping. These may be eight to twelve feet in length. It is used for pulverizing clods and smoothing the surface of the ground. It is an effective implement to use where fine pulverization of the surface is desired, and works satisfactorily when the soil is rather dry.

Rolling.—The roller serves two chief purposes: (1) to compact the soil, and (2) to pulverize clods. The weight and size of the roller are important in this connection. Soil compacting calls for considerable weight, while pulverization demands a roller of comparatively small diameter. In recent years the corrugated roller with a discontinuous surface has come into use and is thought to be superior to the old style. It compacts the soil and yet leaves some loose soil at the surface, thus lessening direct evaporation. The roller should be used only when the soil is in dry condition and when it is desirable to encourage capillary rise of water and establish conditions favorable for the germination of seeds that lie near the surface of the soil. Rolling is most frequently resorted to in preparing the seed-bed for winter wheat. This crop calls

for a compact and well-pulverized seed-bed. In the winter wheat regions the soils are frequently dry at the time winter wheat should be seeded.

A roller known as the subsurface packer has come into use in the semi-arid regions. This implement, consisting of a series of heavy disks, is so constructed as to compact the soil to a considerable depth, leaving two or three inches of loose soil at the surface. It encourages capillary rise of water without encouraging surface evaporation.



DETAILS OF A GOOD SEED BED.¹

Character of Seed-Bed.—The ideal seed-bed is determined by the character of crop to be grown. Wheat, rye, alfalfa, the clovers and most small seeds call for a finely pulverized, compact seed-bed. If these conditions are combined with a good supply of moisture these crops will make a prompt and satisfactory growth. Such crops as corn and potatoes call for a deep, loose seed-bed, and do not demand the same degree of pulverization of the soil as the crops above mentioned. Oats and barley do best with a fairly loose and open seed-bed, but demand fairly good

¹ Courtesy of The Campbell Soil Culture Publishing Co. From "Wheat," by Ten Eyck.

pulverization of the soil. As a rule, all small seeds need a seed-bed that has been thoroughly well prepared, while larger seeds, and especially those of crops that are to be inter-tilled, may be planted with less thoroughness in seed-bed preparation. The after-tillage will often overcome a lack of previous preparation.

An even distribution of seed, especially when it is sown broadcast, is essential. This, together with uniformity in germination, makes for perfection in stand of plants. The character of seed-bed is important in this connection. A well-prepared seed-bed facilitates a good stand, while a poorly prepared one often does just the reverse.

Cultivation and Hoeing.—Cultivation and hoeing pertain wholly to inter-tilled crops, such as corn, potatoes, beets, tomatoes, cabbage and a great many other garden crops. As a rule, cultivation should be sufficiently frequent during the early stages of growth to maintain a satisfactory soil mulch and destroy all weeds. This is best accomplished by cultivating or hoeing at just the right time. Weeds are easily destroyed when quite small. One cultivation at the right time is more effective than two or three cultivations when weeds have become large. As a rule, little is to be gained by inter-tillage when there are no weeds and when there is a satisfactory soil mulch. The frequency of cultivation is, therefore, largely determined by these factors. Ordinarily, nothing is to be gained by cultivating deeper than necessary to destroy weeds and maintain a good soil mulch. Two to three inches in depth is generally sufficient. Deep cultivation frequently destroys roots of the crop cultivated, much to its detriment.

Throughout most of the corn belt shallow and level cultivation is practiced. This seems to give better results than deeper cultivation or the ridging of the soil by throwing the earth toward the corn plants. Ridging the soil causes rain to flow quickly to the depressions midway between the rows, and encourages soil erosion. Level cultivation with numerous small furrows close together encourages more thorough penetration of the rain. Level cultivation makes the seeding of oats easy, as it generally follows the corn with no other preparation than the disking of the land.

Control of Weeds.—The time of plowing and the frequency and character of cultivation are related to the growth and eradication of weeds. Weed-seeds turned under to the full depth of plowing frequently lie dormant until the ground is again plowed and they are brought near to the surface. On spring-plowed land it is generally advisable to allow time for the weed-seeds to germinate, after which the small weeds may be destroyed by harrowing. Then crops may be planted with comparative safety so far as weed competition is concerned. In case of late plowing, it is advisable to plant or seed very promptly after the land is plowed in order that the crops may get ahead of the weeds.

Weeds are a great menace to crops, and especially to those that do

not fully occupy the ground in their early periods of growth. Weeds compete with the farm crop plants for plant food and moisture. Where they have an equal start, they will frequently exterminate the crop unless removed promptly by cultivation. Weed destruction is most economically accomplished by hoeing and cultivating as soon as weeds have begun to grow. When such measures have been neglected and the weeds get a good start, it requires much more labor for their extermination.

Soil Mulches.—Aside from the soil mulch mentioned under the topic of cultivation and hoeing, mulches of straw, manure and other organic substances are resorted to in exceptional cases. These serve



TERRACING AS A MEANS OF PREVENTING EROSION.¹

both to conserve soil moisture and to keep down weeds. They therefore obviate the necessity for hoeing and cultivating. Such mulches encourage capillary rise of soil moisture to the immediate surface of the ground. Furthermore, upon the decay of the mulch, organic matter and plant food are added to the soil. Such mulches are applicable only under intensive systems of farming and where the materials may be secured without too great cost.

Soil Erosion.—Soils are eroded by the rapid movement of both wind and water. Wind erosion occurs most extensively in the sandy regions

¹ From Year-Book, U. S. Dept. of Agriculture, 1913.

of the semi-arid belt, especially in western Kansas and Oklahoma. Such soil destruction calls for surface protection, either by a continuous covering of plants, or by such methods of cultivation as will prevent the movement of the surface soil. In those regions it is recommended that the plow furrows be at right angles to the prevailing direction of the wind, and that the drill rows of grain be likewise at right angles to the wind. Mulches of straw, especially in the wheat regions where straw is abundant, are also recommended. Such straw may be rolled with a subsurface packer to prevent its blowing from the soil. Under such conditions the surface soil should not be made too fine.

In the South and in southern Illinois, Iowa and Missouri, soils erode badly as result of the movement of rain water. Such erosion often results



ANOTHER WAY TO STOP EROSION.¹

in deep and destructive gullies. These cause a direct loss of soil, and are barriers to continuous cultivation in the fields in which they occur. Such erosion should be prevented by every possible means before it proceeds far. Gullies may be stopped by the use of brush, weeds, straw and stone. These materials should be anchored in the gullies in such a way as to encourage them to fill with soil again. Deep plowing and the use of green manures, which encourage penetration of rains, help to overcome this erosion. Terracing the soil may be resorted to as a last means of preventing erosion.

Soil Injury.—Soils are frequently injured by plowing and cultivating when they are too wet. Heavy soils are more susceptible to such injury than those of a sandy nature. Such injury is often difficult to overcome. It gives rise to a puddled condition of the soil. When plowed, it turns

¹Courtesy of The International Harvester Company.

up in hard clods which are difficult to pulverize. In this condition it requires more labor to prepare a seed-bed than if it had not been so injured.

Soils are often seriously injured by the tramping of livestock. It is unwise to allow stock to run in the fields when the soil is in a very wet condition. Hauling manure or loads of any kind across the field when the soil is too wet often results in injury to such an extent that the tracks of the wagon may be seen even after the land has been plowed and cultivated.

Time and Intensity of Tillage are Economic Factors.—The time to plow, disk harrow and cultivate is important in connection with the cost of the operations. It is essential to perform these tillage operations when the soil is in the best possible moisture condition. This enables the farmer to accomplish the desired result with the minimum amount of labor; consequently, his force of men and teams is able to properly care for the maximum acreage. It is easier and much less expensive to stir the soil at the right time and thus prevent bad physical condition than it is to change the bad physical condition to a good condition. A great deal of labor is required to reduce a hard, cloddy soil to a finely pulverized condition. As above indicated, time of cultivation in connection with weed destruction is important. The farmer who is foresighted and plans his work in such a way as to avoid undue rush at busy seasons will be the one to accomplish the various cultural operations with the minimum amount of labor.

The intensity of tillage will be determined by a number of factors, such as the price of land, the cost of labor and the value of the product grown. With cheap labor, high-priced land and a valuable product, intensive methods of tillage are applicable. On the other hand, when labor is expensive, land is cheap and products are of low value, extensive methods of tillage must be applied. It is wise to keep the soil occupied as fully as possible. This is accomplished by crop rotations and a succession of crops, one following another, throughout the growing season, so that at all times plants will be occupying the soil and gathering plant food as it becomes available.

The saving and utilization of all the manures produced on the farm is essential in this connection. It is more profitable to grow a full crop on five acres than it is to produce one-half a crop on ten acres.

In general, soil utilization and management call for a thorough understanding of the underlying principles and the adoption of methods of handling that accomplish good results without undue expense. Those practices which are injurious and those which do not make for maintenance of fertility should be avoided.

REFERENCES

- "Principles of Soil Management." Lyon and Fippin.
"Crops and Methods of Soil Improvement." Agee.
"Soils." Fletcher.
"The Soil." Hall.
"Soils." Burkett.
Michigan Expt. Station Bulletin 273. "Utilization of Muck Lands."
Missouri Expt. Station Circular 78. "Control of Soil Washing."
U. S. Dept. of Agriculture Bulletin 180. "Soil Erosion in the South."

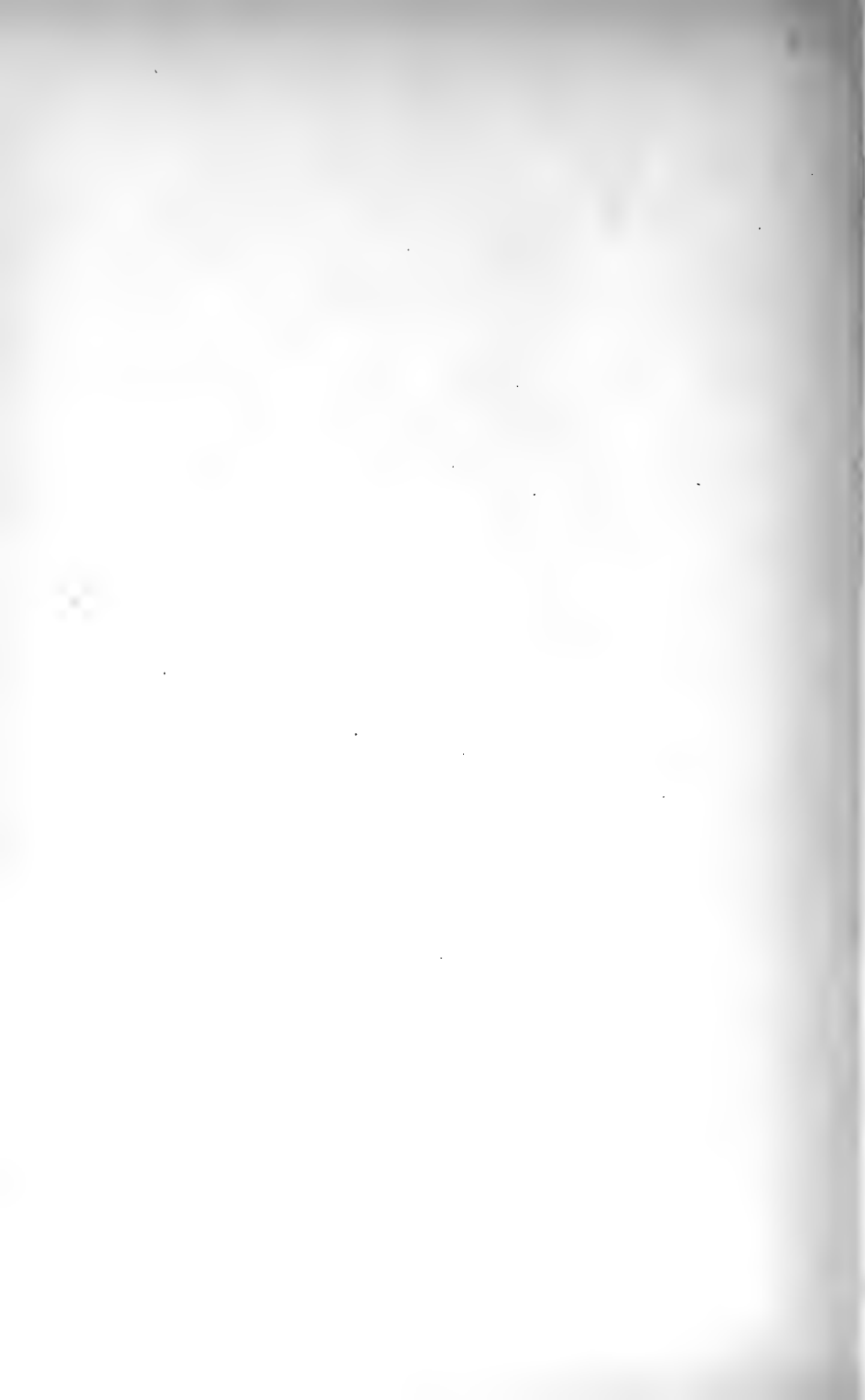

PART II
FARM BUILDINGS AND EQUIPMENT



CHAPTER 9

FARM BUILDINGS, FENCES AND GATES

Farm buildings should be located and constructed with a view of meeting the needs of the farm and farmer's family. They should harmonize with the natural surroundings and have sufficient room for the housing of the farm animals, equipment and the storage of forage, grain and such other crops as may be grown. The number, character and size will be determined by the size of the farm and the type of farming. They should be as fully adapted to the type of farming as possible. Upon the plan of the farm, the arrangement of the farmstead and its position on the farm depends to a large extent the farmer's success.

The Farm Residence.—With some farmers the housing of the livestock is considered of more importance than the housing of the farmer and his family. Where capital is very limited and the farmer is accustomed to an exceedingly simple life, this may prove advantageous for a short time, in order to get a start. At the present time and in most localities, the housing of the farmer and his family properly receives first consideration. The farm residence should be the most important building of the farm. It should occupy a conspicuous place in the farmstead and bear a convenient relationship to the other buildings of the farm. There is more latitude relative to the direction the farm house should face than there is in case of the city house. This feature should be carefully considered in the construction of the house, the position of verandas and the location of the living rooms. Size of windows and the entrance of sunlight should also be considered in this connection.

The foundation and the roof of the house are two important features. These should be constructed with reference to durability and strength as well as appearance. The height of the house or the height of the rooms may be increased with little additional cost, since this will increase the cost of neither foundation nor roof. There is little excuse, however, for tall houses in the country. Land is cheap and comparatively low structures harmonize better with country surroundings.

It pays to paint a farm residence thoroughly immediately after its construction, and to re-paint whenever paint is needed. Paint lengthens the life of a house and makes it warmer. Light colors are generally preferred for country dwellings. The smoke and dirt which make bright colors impracticable and expensive in cities are not present in the country. Such colors harmonize with the green foliage that should surround a country residence. On new lumber, the first or priming coat should be mixed very thin and applied promptly after the house is constructed. At the time



AN ATTRACTIVE FARM HOUSE.¹

A house of moderate size and cost in which comfort and convenience have been carefully considered. Architects, Mrs. Myron Hunt and Elmer Grey.

¹ From "Distinctive Homes of Moderate Cost," by H. H. Saylor.

of priming, the boards should be reasonably dry in order that the paint may enter the wood and fill any cracks that are present. It should be worked well into the wood with the brush and allowed to become thoroughly dry

PLANS OF FARM HOUSE.

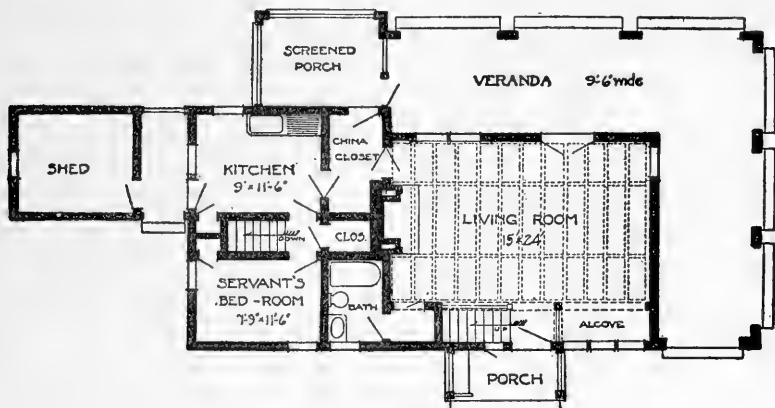

FIRST FLOOR PLAN

In warm weather the dining table is set in the screened porch, convenient to the kitchen. During the winter one end of the living-room takes the place of a dining-room.

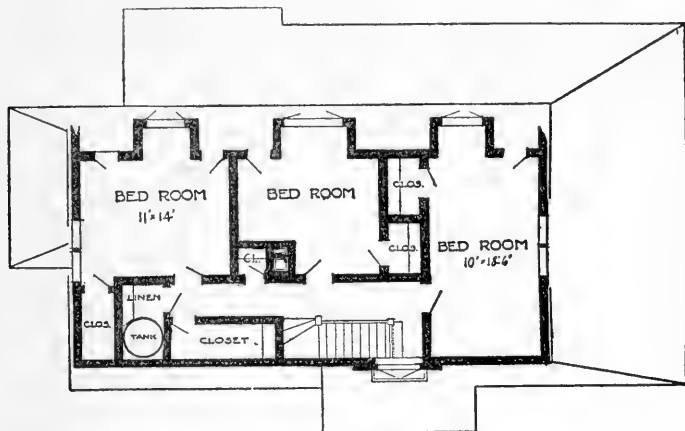

SECOND FLOOR PLAN

There are three good bedrooms on the second floor, and the end ones have cross ventilation through the gable windows.

before the second coat is applied. The second coat should be somewhat thicker, smoother and of the proper color. A third coat will generally be required, but the application should be deferred from three to six months.

This allows time for the second coat to become hard and any small cracks that may open in the meantime by shrinking of the boards will be filled with paint.

Whether the farmer does his own painting or hires it done, it is generally advantageous for him to purchase his own paint, and to be careful to select durable materials. A high grade paint is usually the most economical in the long run, and may be bought ready-mixed from any reliable dealer.

BARN

The principal barn of the farm is second in importance only to the house. In case of noted livestock breeders or some large stock farms, the

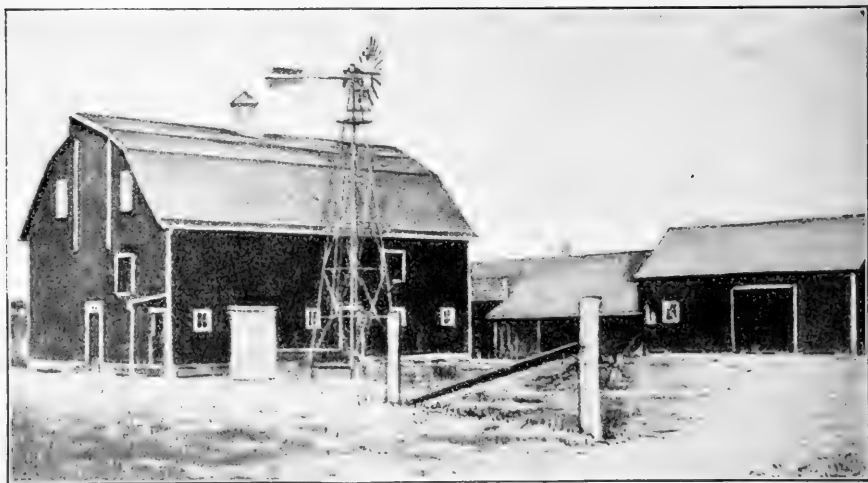

A GOOD TYPE OF BARN.¹

barn becomes the most important structure on the farm. The prime requisites for a good barn are convenience, especially in arrangement, comfort for the animals, ample storage room for feed, proper light and ventilation, and durable but not expensive construction.

Whether all livestock on the farm should be housed in one structure or in several structures must be determined by the kind and number of stock reared. It is generally advisable to house the cows in a separate structure. The noise and odor of swine is detrimental to both the yield and quality of milk. Swine should not be kept in the main barn. If horses and cows are stabled in the same structure, they should have separate compartments. It will frequently be convenient to house the cows in the basement and the horses on the floor above them. This is the usual

¹Courtesy of Wallace's Farmer, Des Moines, Iowa.

arrangement in case of bank barns. Where all stock is on the same floor, cows should be in an extension to the main structure. This should be only one story in height with no storage above.

Bank Barns.—The chief advantage in the bank barn is in the ease with which materials are stored by driving the loaded wagons onto the upper floor. This obviates the necessity of hoisting materials to the height necessary in the other forms of barns. The ideal location for the bank barn is on a southern slope, thus facing the barn toward the south with exercise yards also to the south. When so situated the more elevated land to the

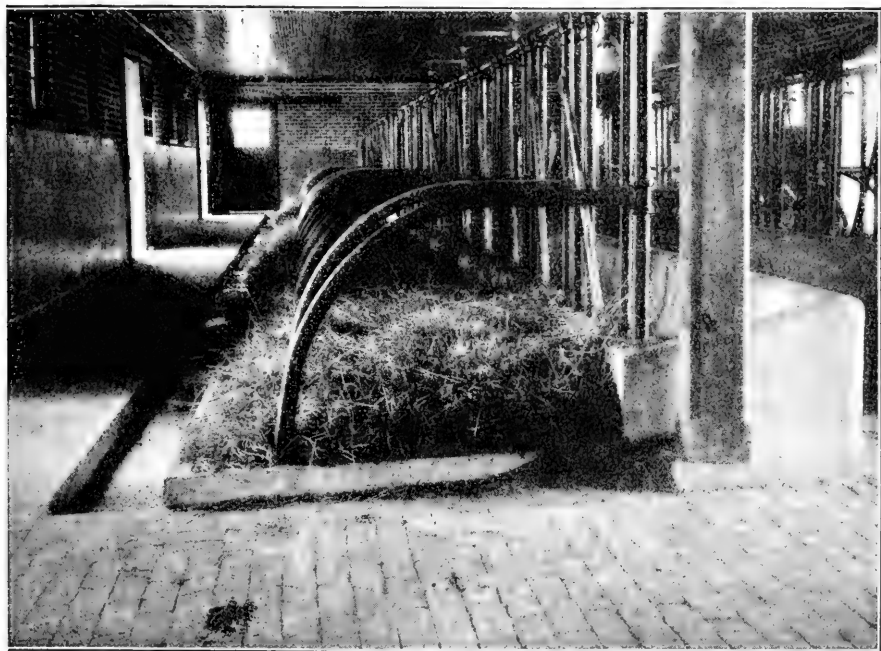

INTERIOR OF COW STABLE.¹

north brings the north wall of the stable below the surface, thus protecting the stable from cold north winds. The chief objection to the basement barn lies in its lack of light and thorough ventilation. This, however, may be largely overcome by not setting the basement too low in the earth and by providing plenty of windows, especially in the east and west walls.

Dairy Barns.—Great improvement has been made in the housing of cows, and much attention is now given to the health of the animals and the production of clean milk, low in its content of bacteria. Best dairymen demand that the cow quarters shall be separated entirely from those of all

¹ Courtesy of The Macmillan Company, N. Y. From "Crops and Soil Management," by Agee.

other stock. The structure should be narrow, housing not more than two rows of cows. The walls, floor and ceiling should be smooth and easily cleaned. For this reason concrete floors that can be frequently washed are preferred. Such floors do not absorb liquids, and if properly cleaned, avoid the objectionable odors so common in stables with wooden or earth floors. Milk is the most widely used uncooked food, and those producing market milk need conditions approaching the ideal for cleanliness in order to secure a high-grade product. Furthermore, the modern dairy cow is bred and fed for efficiency in milk production. This often taxes her health and shortens her life. It calls for the best sanitary surroundings to overcome this drawback.

Storage Capacity.—The storage portion of the barn should connect with one end of the cow barn and should have posts of ample height to store

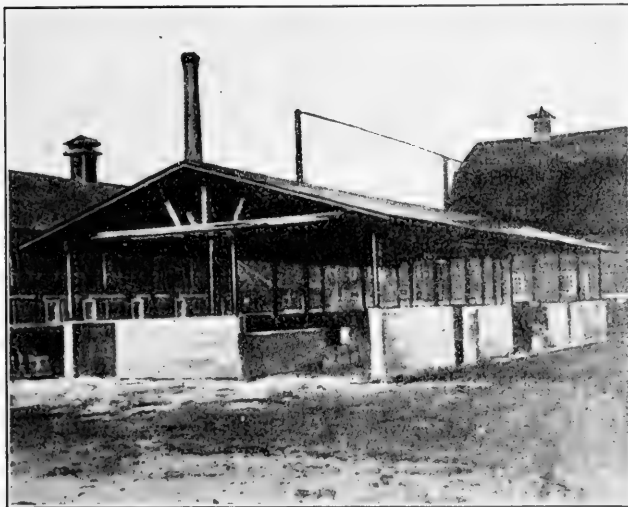

ECONOMICAL AND PRACTICAL MANURE SHED.

a year's supply of roughage and concentrates for the dairy herd. It should be moderately narrow and have sufficient length to meet the storage requirements. The hay chutes and feed bins should be conveniently placed and connected with the cow stable by suitable carriers, conveyed on overhead tracks.

Silos.—Silos will generally be needed and may be connected with the cow stable through a portion of the storage barn. This prevents the silage odor from permeating the stable and contaminating the milk. It is usually considered best to have the storage structure extend east and west. This permits the cow stable to extend north and south, thus admitting sunshine from both the east and west, enabling it to sweep across all the floor surface during the day. When there is one extension it should connect near the center of the storage barn. When there are two they should connect one at each end of the storage structure, thus leaving an open and protected court between the two cow stables.

Floor Space and Arrangement.—The width of the cow stable should be 36 feet and of sufficient length to accommodate the desired number of

cows. The two rows of cows face each other with a spacious feed alley between. Manure alleys of requisite width are located between the gutters and the outside walls. The width and depth of manure gutters, the form of feed troughs and the kind of stanchions, together with many other details, may be obtained from bulletins on this subject.

Stable Floors.— Floors that absorb urine and are difficult to clean should be avoided in cow stables. Of all floor materials

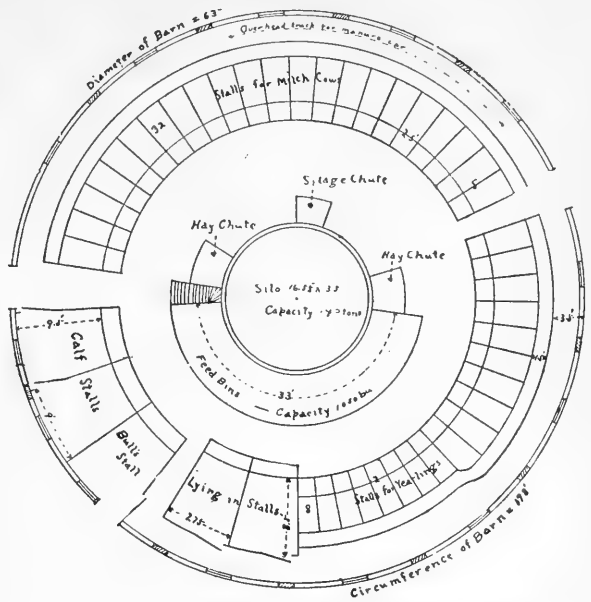

PLAN FOR A CIRCULAR BARN. FLOOR PLAN.¹

within reach of the average dairymen, concrete holds first place. It is durable, non-absorbent and can be disinfected without injury. Its chief

objection is hardness and smoothness; the former may be partially overcome by the liberal use of bedding. Precautions should be taken when making the floor to leave its surface slightly roughened without interfering with the ease of cleaning. Concrete conducts cold more freely than other floor materials. For this reason it should be underlaid with eight inches or more of rather coarsely broken fragments of rock. The conductivity may be

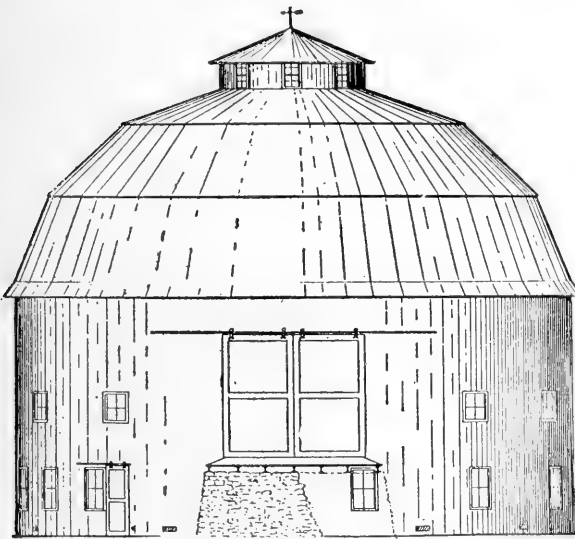

ELEVATION PLAN.¹

¹ Courtesy of The Pennsylvania Farmer, Philadelphia, Pa.

still further reduced by introducing a thin layer of asphalt or other non-conducting material an inch beneath the surface of that portion of the floor on which the cows lie.

A four-inch thickness of concrete is sufficient. The usual proportion of materials are 1 part of cement, $2\frac{1}{2}$ parts of sand and 5 parts of crushed stone by measure. Screened gravel may be substituted for the stone, or good bank gravel may be used unscreened. Screening is to be preferred, unless the proportion of fine material and gravel is about 1 to 2. A bag of cement is equal to 1 cubic foot. The concrete should be laid in sections, similar to the manner of constructing walks. This provides for seams at reasonable intervals and allows for shrinkage without cracking the cement.

Lighting.—Plenty of light is essential in all portions of a stable where animals are kept or work is performed. Its absence is not only inconvenient, but allows the unobserved accumulation of dust and bacteria.

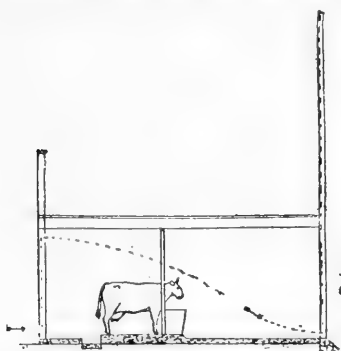

CROSS-SECTION, SHOWING VENTILATION AND STABLE FLOOR OF CONCRETE.

Not only should there be good light, but direct sunshine should also be admitted as much as possible on account of its sanitary effect. The size and location of the windows should permit an abundance of both light and sunshine and provide as great a distribution of the latter as possible. North and south windows are not as effective in this respect as those on the east and west. Windows in cow stables should be screened against flies.

Ventilation.—Fresh air is as essential to the health of cows as it is to man. It is necessary to have much better ventilation in cow stables than in dwellings, because [of the number of animals within a given space and the rapidity with which the air becomes charged with carbon dioxide and moisture from the lungs of the cows. Not only is ventilation necessary for this reason, but it also sets up currents of air that convey dust and bacteria from the barn.

The King system of ventilation is the one generally used in barns. It is described in the chapter on "Farm Sanitation."

Professor King, in his book on Ventilation says, "A cow requires six full pails of pure air each minute of the day and consumes twice the weight of air that she does of food and water combined." This gives a basis for calculating the volume of air required daily by each cow, and is used in determining the number and size of ventilating flues necessary.

Conveniences.—The tendency of the times is toward the saving of labor. This should be seriously considered in connection with the arrangement of the stable and the conveniences that should be therein. Canvas extensions to both hay chutes and ventilators are convenient. The former

prevents the distribution of dust from hay while feeding. These extensions for both hay chutes and ventilators may be folded and hung against the wall or ceiling so as not to interfere with the stable work.

Closets for harness should be provided. They will prove economical in keeping the harness clean and preserving it. In some instances, a small room in which to hang, clean and repair harness is advantageous.

It will pay to have water delivered by pipes directly to the barn. If it has considerable pressure, a hose can be used in washing the walls and

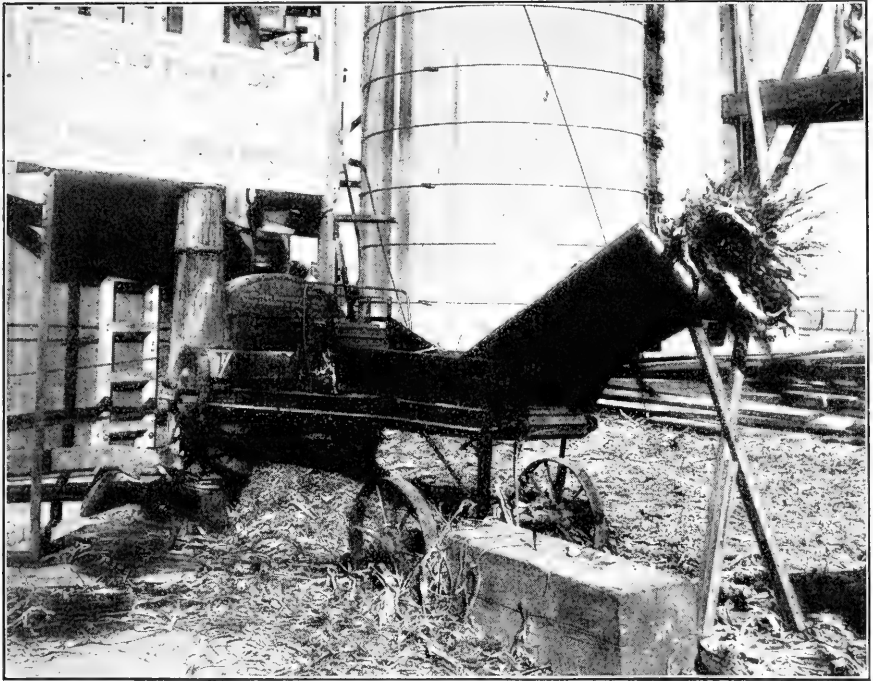

ENSILAGE CUTTER AND FILLER.¹

floor of the cow stable. This will necessitate a drainage pipe leading from the stable floor to a suitable outlet.

Silos.—Silos have come into quite general use as a means of storing roughage for cows, steers and sheep. The product of an acre of land can be stored in less space when made into silage than when cured in any other way. Hay stored in the mow will take up about three times the space and cornfodder about five times the space of the same quantity of food material placed in the silo

¹ Courtesy of The International Harvester Company, Chicago.

Corn can be made into silage at less cost than when cured as fodder. There is not only a saving of time, but there is less waste of the crop and it goes to the feed trough in a succulent and more digestible condition than when dry. Crops may be put into the silo under weather conditions that will not make possible the harvesting for putting in the shock or mow. The silo enables the farmer to keep more stock on a given area of land, and is a step in the direction of greater intensity.

There are many forms of silos, but the essential of a good silo is a strong, durable, tight wall that will permit of thorough settling of the stored material. Silos of the circular form are preferred. The greater the depth, the more compactly the material settles, the better it keeps and the larger the quantity that may be stored in a unit of capacity. The monolithic concrete silo is coming into extensive use. It is fireproof, and when properly constructed should last many years. Its first cost is a little greater than a good wooden silo, but it should prove cheaper in the long run. Concrete blocks and tiles are also used for silos and have proven both satisfactory and durable.

The size of the silo will depend on the number of stock to be fed out of it and the length of the feeding period. In northern latitudes this period is seldom less than 200 days. It is usual to feed cows 30 to 40 pounds of silage daily. On the above-mentioned basis, 3 to 4 tons per animal will be required. These figures give a rough basis for calculating the amount of silage required and the capacity of the silo to construct. It is estimated that there should be fed from the surface of the silage about two inches daily in order to prevent the material spoiling. A feeding period of 200 days would, therefore, call for a silo 400 inches in depth, or about 35 feet deep. Silos are often constructed to a greater depth. The following table gives the height and inside diameter of silos in feet, together with the capacity of silage in tons. This will be helpful in connection with determining the size to build.

Height of Silo, feet.	Inside Diameter of Silo.						
	10 Feet.	12 Feet.	14 Feet.	15 Feet.	16 Feet.	18 Feet.	20 Feet.
	Tons.	Tons.	Tons.	Tons.	Tons.	Tons.	Tons.
20.....	26	38	51	59	67	85	105
21.....	28	40	55	63	72	91	112
22.....	30	43	59	67	77	97	120
23.....	32	46	62	72	82	103	128
24.....	34	49	66	76	87	110	135
25.....	36	52	70	81	90	116	143
26.....	38	55	74	85	97	123	152
27.....	40	58	78	90	103	130	160
28.....	42	61	83	95	108	137	169
29.....	45	64	88	100	114	144	178
30.....	47	68	93	105	119	151	187
31.....	49	70	96	110	125	158	195
32.....	51	73	101	115	131	166	205

It should be borne in mind that the deeper the silo the more compact the silage becomes and the greater the weight per cubic foot. In silos of ordinary depth the weight ranges from 30 to 50 pounds per cubic foot, depending on the position in the silo. On an average, a cow requires one cubic foot of silage daily.

Details concerning the construction of different forms of silos may be secured from bulletins issued by a number of state experiment stations and also by the manufacturers of cement.

OUT-BUILDINGS

The out-buildings of the farmstead, consisting of sheds, cribs, milk house, pig houses, poultry houses and other minor buildings, should be

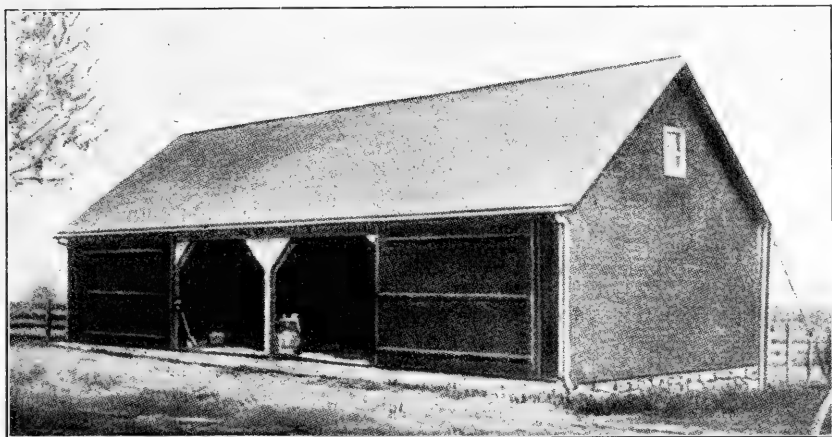

A GOOD IMPLEMENT SHED.¹

grouped with reference to accessibility and appearance. It is worth while in this connection to consider the possibility of fire and fire protection.

The Implement House.—The first essentials of a good implement house are a good, dry floor and a roof and walls that will keep out rain and snow. It should have sufficient strength to withstand winds, ample size for the storage of all machinery without taking much of it apart and freedom from interior posts or obstructions. Such a building need not be expensive. In fact, it should not be expensive if it is to prove a profitable investment. If a comfortable workshop is provided in one end of it where odd jobs of repairing can be done and where a stove can be installed so much the better. Such a provision encourages the proper repair and care of the tools and makes this work possible in weather unsuited to outside work.

¹ Courtesy of Wallace's Farmer, Des Moines, Iowa.

The building should have several wide, rolling doors, and in most instances should be provided with eave-troughs to conduct the water away from its foundation.

Corn Cribs.—The essentials of a good corn crib are a good foundation and a good roof, together with ample capacity and convenience for filling and emptying it. To this might be added protection of grain from the ravages of vermin, especially rats and mice. Where much corn is grown, the double crib is preferred. The usual width of each crib is eight feet and the length is made to conform to the amount of corn raised. The advantage of the double crib is that one or more loads may be driven under shelter and unloaded in stormy weather or at leisure. The driveway, after husking time, may be utilized for storing farm wagons or farm implements.

Since corn dumps and elevators have come into quite general use, corn cribs are constructed much taller than formerly. This is economical, since the capacity is materially increased without enlarging either the foundation or the roof, which are the most costly parts of the structure.

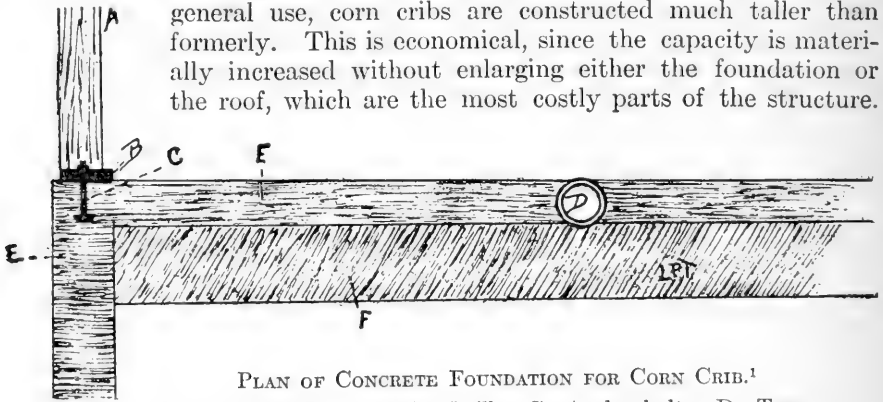

PLAN OF CONCRETE FOUNDATION FOR CORN CRIB.¹

A—2" x 6" joist. B—2" x 6" sill. C—Anchor bolt. D—Terra cotta ventilator. E—Concrete. F—Broken stone.

Extending the posts and walls from four to eight feet adds very little to the cost in proportion to the increased capacity.

Concrete floors are coming into general use for corn cribs. These are so constructed as to afford no harbors for rats and mice. It is necessary to provide against dampness in such floors by thorough drainage about the walls or by building them up on a considerable thickness of coarsely broken stone. It is also advisable to provide floor ventilation by the use of hollow terra cotta tiles laid in the concrete. The accompanying sketch shows the construction of such a floor. It will be noted that bolts $\frac{3}{4}$ inch in diameter are set in the concrete to a depth of 4 inches, a 3-inch washer being on the inserted end. The thread end should project above the concrete sufficient to pass through a 2-inch sill and allow a good washer and tap to be attached. The sill fastened in this way holds the crib secure to its foundation.

¹ Courtesy of Wallace's Farmer, Des Moines, Iowa.

Hog Houses.—The profitable production of swine demands dry, sanitary, comfortable housing. Warmth is also essential, especially at the time of farrowing. Early pig production is impossible without warm shelter. The hog house should be conveniently located, but should take an inconspicuous position in the group of farm buildings. Whether the house is stationary or movable, it should be well ventilated and admit plenty of sunlight. The movable type of hog house is coming into quite general use, and has several advantages over the stationary one. In case of disease the houses may be disinfected and moved to new lots, thus escaping the infected ones. They are also very convenient where pasture is depended upon and is changed from year to year. To be serviceable, such houses should be suited to all seasons of the year. During the summer they should be open and afford shade. During the winter or the farrowing season they should be closed and still admit direct sunlight. The accompanying illustrations show two views of the Iowa gable roof hog house. This house meets the requirements named.

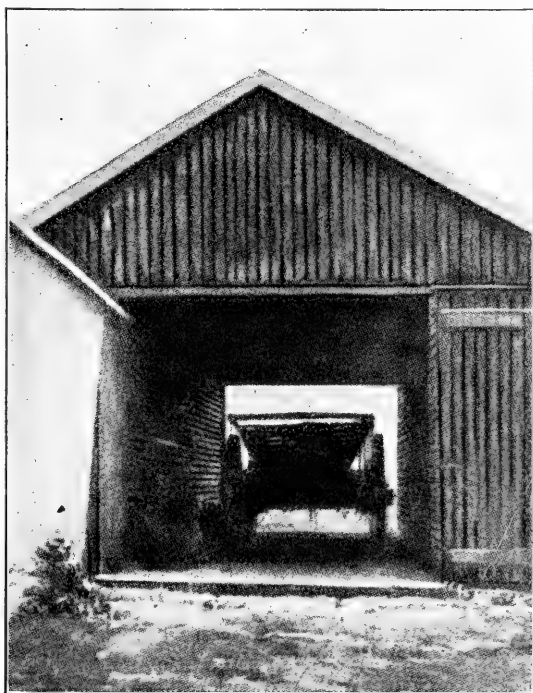

INTERIOR OF DOUBLE CORN CRIB.¹

A bill of material and estimate of cost of this type of individual house is as follows:

BILL OF MATERIAL AND ESTIMATE OF COST.²

THE IOWA GABLE ROOF HOUSE.

1 piece 4" x 4" x 16' for runner, fir, 21½ board feet, at \$55 per M.....	\$1.17
4 pieces 2" x 12" x 12' for floor, No. 1 white or yellow pine, 96 board feet, at \$30 per M.....	2.88
1 piece 2" x 4" x 8' for floor stiffeners, No. 1 white or yellow pine, 5½ board feet, at \$28 per M.....	.15
3 pieces 2" x 4" x 8' for rafters, No. 1 white or yellow pine.....	
1 piece 2" x 4" x 8' for girt, No. 1 white or yellow pine.....	
1 piece 2" x 4" x 10' for ridge, No. 1 white or yellow pine.....	
2 pieces 2" x 4" x 10' for plates, No. 1 white or yellow pine.....	

¹ Courtesy of The Pennsylvania Farmer, Philadelphia, Pa.

² Courtesy of Iowa Agricultural Experiment Station.

2 pieces 2" x 4" x 8' for studs, * No. 1 white or yellow pine.....	
2 pieces 2" x 4" x 10' for studs, * No. 1 white or yellow pine.....	
2 pieces 2" x 4" x 8' for fender, No. 1 white or yellow pine.....	
1 piece 2" x 4" x 10' for fender, No. 1 white or yellow pine, 82 $\frac{3}{4}$ board feet, at \$28 per M.....	\$2.32
1 piece 1" x 4" x 12' for brace, No. 1 white or yellow pine, 4 board feet, at \$30 per M.....	.12
5 pieces 1" x 10" x 16' shiplap for ends and sides, No. 1 white or yellow pine*..	
1 piece 1" x 8" x 8' No. 1 white or yellow pine.....	
3 pieces 1" x 10" x 10' No. 1 white or yellow pine, 97 board feet, at \$30 per M.....	2.91
11 pieces 1" x 10" x 8' shiplap for roof, white or yellow pine, 72 $\frac{3}{4}$ board feet, at \$30 per M.....	2.21
3 pieces 1" x 4" x 16' for bottoms, 16 board feet, at \$30 per M.....	.48
12 eye-bolts at 5 cents.....	.60
8 U-bolts at 8 cents.....	.64
5 pairs 12-inch strap hinges at 22 cents.....	1.10
1 pair 8-inch strap hinges at 18 cents.....	.18
1 door pull.....	.10
1 wire for holding door open.....	.10
12.5 pounds nails at 4 cents.....	.50
0.6 gallon to paint double coat 150 square feet, at \$2 gallon.....	1.20
Cost of material.....	\$16.66
Labor, 15 hours at 25 cents.....	3.75
Total cost.....	\$20.41

Further details of this and other forms of movable hog houses may be found in Bulletin 152, Agricultural Experiment Station, Ames, Iowa.

Poultry Houses.—The poultry house should be well lighted and ventilated. The walls should have only one thickness of boards. Double walls afford a harboring place for lice. In cold climates, the boards may be covered on the outside with prepared roofing. This will make a fairly warm house. Chickens can stand much cold if protected from drafts. The interior walls should be smooth and occasionally whitewashed. Good perches should be supported from the rafters and in such a way as to prevent harboring places for lice. A concrete floor is durable, sanitary and easily cleaned. Ventilation may be provided by substituting a muslin-covered frame for one or more of the windows. These may be hinged at the top so as to be swung up out of the way in warm weather. Perches should be at least twelve inches apart and on the same level, otherwise, there will be crowding on the higher perches. A good dropping board should be beneath the perches, and the droppings should be frequently removed with a hoe or scraper. The perches should be in the warmest and lightest part of the house. The nests should be removable and should rest on supports in the darkest portion of the house. If the dropping board is not too low, some of the nests may be beneath it.

Milk Houses.—No matter what type of dairying the farmer follows, if he has many cows, a milk or dairy house becomes a necessity. Milk is easily contaminated by dust and by absorbing odors. It should, therefore, be kept in a pure, clean place. The milk house should not open

* If the sides of the house are built higher than specified to allow of large doorway for tall swine, make due additions in lumber.

directly into the cow stable. The size and equipment of the house will depend on the amount of milk and the manner of disposing of it. When the milk is made into butter or cheese, the size of the house should be sufficient for the proper installation of the separator, churn, butter worker and for the storage of utensils and butter. If steam or gasoline power is used, it should be located outside and a shaft or steam pipe extend into the dairy house. Steam has the advantage of affording heat for warming water and for sterilizing utensils.

The walls of the building should be constructed with reference to keeping as uniform a temperature as possible. These may be of concrete. The floors should always be of concrete.

Ice Houses.— Ice is essential to the proper handling of milk during the summer months. Every dairy farm should have an ice house. In good-sized dairies a thousand pounds of ice per cow yearly is required to cool the milk. In smaller dairies the waste would be greater and proportionately more per cow would be required.

So far as possible the ice house should be located in the shade. It should have double walls and be sufficiently large to store the required

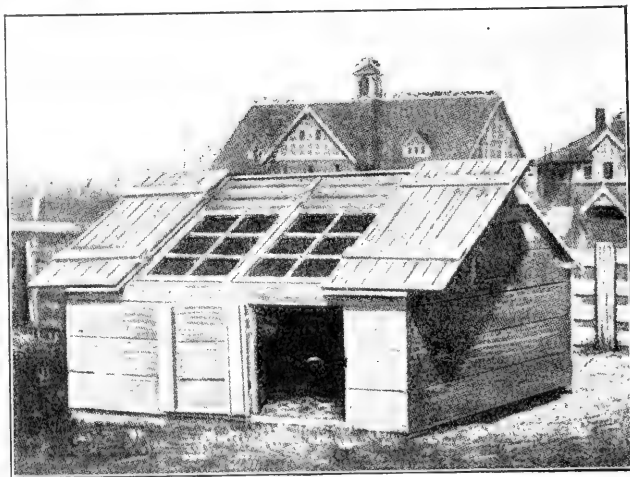
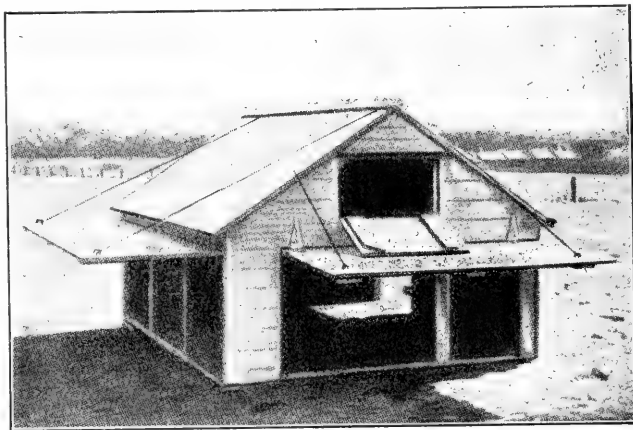

TWO VIEWS OF IOWA GABLE ROOF HOG HOUSE.¹

¹ Courtesy of Agricultural Experiment Station.

amount of ice and allow a space of twelve inches between the walls and ice, which should be filled with sawdust or other non-conducting material. Fifty cubic feet should be allowed for each ton of stored ice. The doors should close tightly to exclude air. Windows are unnecessary. A ventilator should be provided at the roof to allow the escape of vapors.

Wooden structures, because of the continual dampness of the wood, are short lived. For this reason ice houses of concrete blocks or hollow tile are preferable. They keep the ice well and are much more durable than wood.

Roofing.—Wooden shingles have long been the chief roofing material. They embody lightness, ease of construction, good appearance and, when made of the right kind of wood and properly treated or painted, are reasonably durable. It is

folly to put thirty-year shingles on with five-year nails. The new process nails rust out more quickly than the type made in former years. It is, therefore, recommended that good galvanized wire nails be always used for shingles of any material that is reasonably durable.

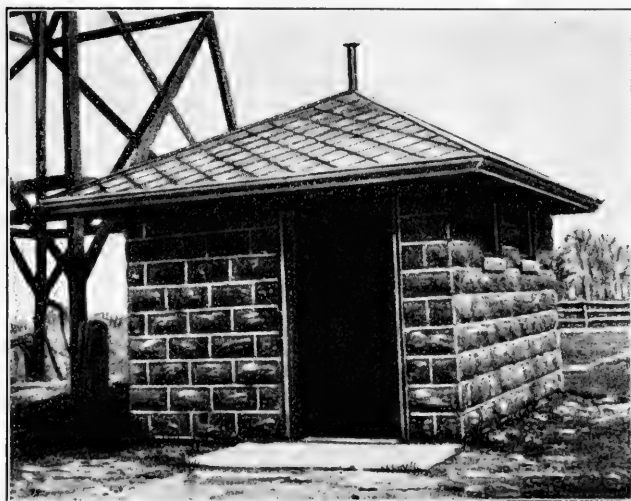

A CONCRETE BLOCK ICE HOUSE.¹

slate and tile roofing are much heavier than wood shingles, but when of good quality are more durable and generally of better appearance. They have the advantage of affording fire protection from sparks and cinders falling on the roof. Any kind of shingles demands a roof of ample pitch to make them durable. If the roof is too flat, more water is absorbed, snow is held, and consequently decay occurs more rapidly.

There is now on the market prepared roofing of many types, much of which is cheaper and more easily placed in position than slate, tile or shingles. The type of building and its permanence should in large measure determine the kind of shingle. Heavy, expensive roofing is out of place on a cheap, temporary building.

¹ Courtesy of The Pennsylvania Farmer, Philadelphia.

Use of Concrete.—Concrete is durable, easily cleaned, simple of construction and finds many good uses on the farm. It makes excellent foundation for all kinds of buildings, is well suited for silos, outside cellars, water troughs, walks, feeding floors and stable floors. The essential in concrete constructions consists in the use of clean sand and gravel, mixed in the proper proportions with a good quality of cement. The greater the strength required and the more impervious the structure is to be, the larger should be the proportion of cement. For building foundations and walks, the 1 : 2½ : 5 mixture is used. Where more strength is required the 1 : 2 : 4 mixture is preferred. Strength is further increased by iron or steel reinforcement. All overhead work—water tanks, silos, bridges, etc.—calls for reinforcement, the extent of which will be determined by the strain to which the structure is to be subjected. The reinforcing material should be placed where it will be most effective. Concrete is most durable if allowed to dry slowly. It should never freeze until thoroughly dry.

Watering troughs should have

thick walls and the sides and ends should be sloped on the inside to lessen the danger of bursting by freezing water. It is safest to provide a means of draining the water off during cold periods. The accompanying sketch shows the foundation, drainage pipe, forms and reinforcement necessary in the construction of a concrete water tank.

Both wooden and metal forms are used. The latter are preferable in the construction of silos and round water tanks. Metal forms, when used repeatedly, are cheaper than wooden ones. They leave a smoother concrete surface than wooden forms. The latter should be soaped or greased on the surface next to the concrete to prevent the material sticking to the forms. Wooden forms should also be sprinkled with water before being filled with concrete, lest they absorb water from the mixture too rapidly.

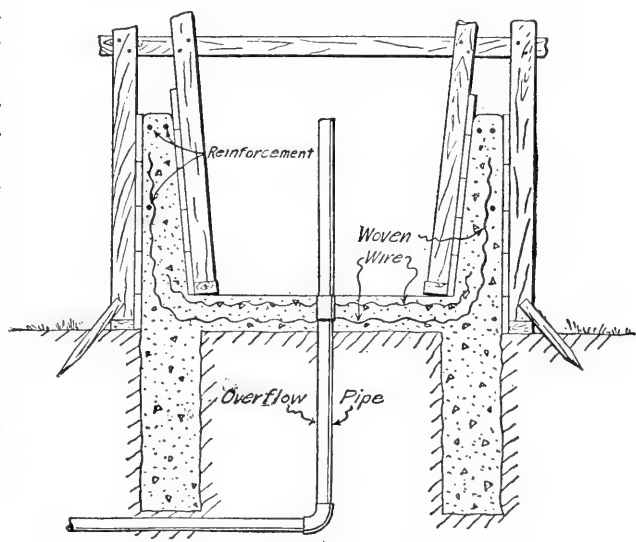

HOW TO CONSTRUCT A CONCRETE WATER TANK.¹

¹ Courtesy of The Pennsylvania Farmer, Philadelphia.

The concrete materials should be thoroughly mixed and enough water used so that the mixture will flow slowly. The smaller the forms into which it is placed, the more liquid it should be. Where much work is to be done, mechanical mixers facilitate the work and do it more thoroughly than can be done by hand. In the absence of a mechanical mixer, a strong, tight board platform, about 8 by 10 feet in dimension, is convenient on which to do the mixing. A square-pointed shovel, a rake and two or more hoes may be advantageously used in mixing the material. If running water is not available, water in barrels or a tank should be convenient to the mixing board. The cement usually comes in bags of 100 pounds each, equal to one cubic foot. Bottomless boxes for measuring sand and gravel are most convenient. They should be constructed of a size suitable for a bag or two-bag mixture of the proportions desired.

One desiring to build should first estimate the cubic space to be occupied by concrete. This known, the amounts of sand, gravel and

cement can be easily estimated. For a 1:2:4 formula, the cement required will equal .058 times the cubic feet in the structure. For the 1:2½:5 formula, it will be .048 times the cubic feet in the structure. The amounts of sand and gravel will be relatively as much more than the cement as the formula specifies.

Plans and specifications for structures of different kinds may be obtained from

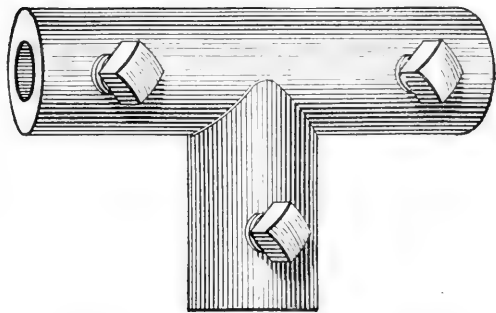

A "T" CONNECTION FOR HEAVY WIRE LIGHTNING RODS.¹

any cement manufacturing company, as well as from bulletins of many of the state experiment stations and from the United States Department of Agriculture.

Lightning Rods.—The larger buildings of the farm group should be protected with lightning rods. The building most likely to be struck by lightning is the barn. Observations show that many barns with entire contents have been burned as the result of lightning. The greatest danger occurs for one or two months immediately after filling the mows with hay. This is due to the accumulation of moisture from the newly-made hay. This moisture fills the peak of the loft, often escaping through the cupola, and increases the conductivity of the air, and in case of a passing thunderstorm attracts the lightning.

Investigations during recent years by insurance companies show that properly installed lightning rods are quite effective as protection against

¹From Farmers' Bulletin 367, U. S. Dept. of Agriculture.

lightning. Eight years' investigations in Iowa show \$4000 worth of damage done to rodded buildings as compared with \$340,000 damage to buildings having no rods. In Canada and Michigan investigations show similar results. Professor Day, of the Ontario Agricultural College, states that out of \$1000 worth of damage by lightning to unrodded buildings, \$999 would be saved if the buildings were properly rodded.

Effective lightning rods for a barn may be installed without much cost. The expensive copper rodding and elaborate system of points and insulators formerly used by lightning rod companies are not necessary. The essentials of a rodding system are metal rods of any good conducting material, sufficiently large to carry a heavy charge of lightning. These should have good contact with moist earth at all times. It is, therefore, well to have the lower ends buried to a depth of three feet or more. On the ends should be a coil at least a foot in diameter. The rods should extend one up each side of the building and over the roof, connecting with a horizontal rod extending along the entire length of the ridge. There should be perpendicular extensions to the horizontal ridge wire at intervals of 15 to 20 feet. These need not be more than 18 inches in length and should be sharpened at the upper end. A terminal point should extend above each cupola, ventilator and chimney on the structure.

No. 3 and No. 4 double galvanized iron telegraph wires make good lightning conductors. The wire may be fastened directly to the building by staples or by means of small wooden blocks and screw eyes. Blocks $1\frac{1}{2}$ inches thick, $2\frac{1}{2}$ inches wide and 4 inches long may be nailed to the side of the buildings and roof at intervals of ten feet or less. The wire can be passed through the eyes screwed into these blocks. The vertical wires and terminals may be connected with the horizontal ridge wire by means of galvanized T's.

The quality and type of rodding system should conform to the nature and character of the building. An attractive system of rodding adds much to the appearance of the building.

Fences and Gates.—The need for farm fences is probably less than formerly. The chief purposes are for the confinement of stock and poultry and for ornamentation. The extensive use of farm machinery and the adoption of systematic crop rotation have reduced the number of fields on the average farm. The increase in the price of land has reduced the acreage used as pasture. As a rule, highway fences, except where pastures border the road, may be omitted. Nothing mars the appearance of a farm more than an untidy fence grown up with weeds. The farmer is benefited and the appearance of the farm improved if unsightly fences are removed and the fields cropped to the border of the road.

The type of fence selected depends much on the service to be rendered. A hog-tight fence is cheapest and most effective when constructed of well-galvanized woven wire. The posts should not be too far apart and the bottom wire should be fastened close to the ground at intervals suffi-

ciently frequent to prevent hogs from springing it and crawling beneath. Woven wire 36 inches high is sufficient to turn the hogs. If the fenced field is to be used for cattle or horses, two barbed wires may be placed above the woven wire. With a little additional expense, a fence 48 or 52 inches high may be secured which will turn all kinds of stock. A single strand of barbed wire, three inches above the top of the woven wire will prevent horses reaching over and stretching the fence.

The top wire of a 48 or 52-inch fence should be of No. 9 wire. Wires below this may be of No. 10 or No. 11 material. Perpendicular wires are sometimes even smaller. The lighter wires are less durable and more easily stretched and broken; consequently, it is economy to pay more for the fence and secure a heavier wire. This is especially true if the fence is to be permanent. For temporary fences to be moved from time to time, the lighter wire is more easily handled and stretched.

Stone fences, plank fences and hedge fences, once thought desirable, are now seldom advisable and will not be discussed.

Wooden posts will probably continue to be extensively used, but are being replaced to some extent by metal posts and reinforced concrete posts. Metal posts should be set in concrete. Both metal and concrete are somewhat more expensive than wooden posts and have not been used sufficiently long to determine extent of their durability. Much greater durability is claimed for them than for wooden posts. The chief advantage of the wooden posts is in the ease with which the wire may be fastened to them.

Red cedar posts are to be preferred, chiefly because of their straightness and long durability. Next to red cedar comes the black or yellow locust, catalpa and white oak. Many other kinds of wood may be used. The kind to select depends chiefly on the cost, together with the feasibility and cost of treating the posts to increase their durability. For permanent fences, the best posts are usually the cheapest. Posts of short duration must be replaced frequently, and this adds much to the upkeep cost of the fence.

It generally pays to treat the bottom ends of posts with creosote. The material for this purpose will cost from four to eight cents a post, depending on size. The outfit for treating consists of a metal tank sufficiently large to hold a number of posts, under which a fire may be built and the creosote heated to about 220° F. The well-seasoned posts should remain in the solution two or three hours, after which they are put into cold creosote for an hour or two. Only the lower three feet of the posts need be treated. Posts decay most rapidly at or just beneath the surface of the soil. Such treatment is claimed to add ten to fifteen years to the usefulness of ordinary soft wood posts.

Every farmer should have a wood lot that will supply posts for the farm. Trees cut for posts should be cut the last of July or during August. Trees felled at this time need not be cut into posts at once. In fact, it

is an advantage to let them lie until the leaves draw the water from the sap, thus leaving the starch to preserve the wood. At a convenient season the trees may be cut into posts and the posts set on end to further cure. Posts cut in this way last much longer than when the trees are cut in the winter or spring.

The interval between posts in fence construction depends on the size of the posts, the depth to which they can be conveniently set, the weight or strength of the wire and the strain to which it will be subjected.

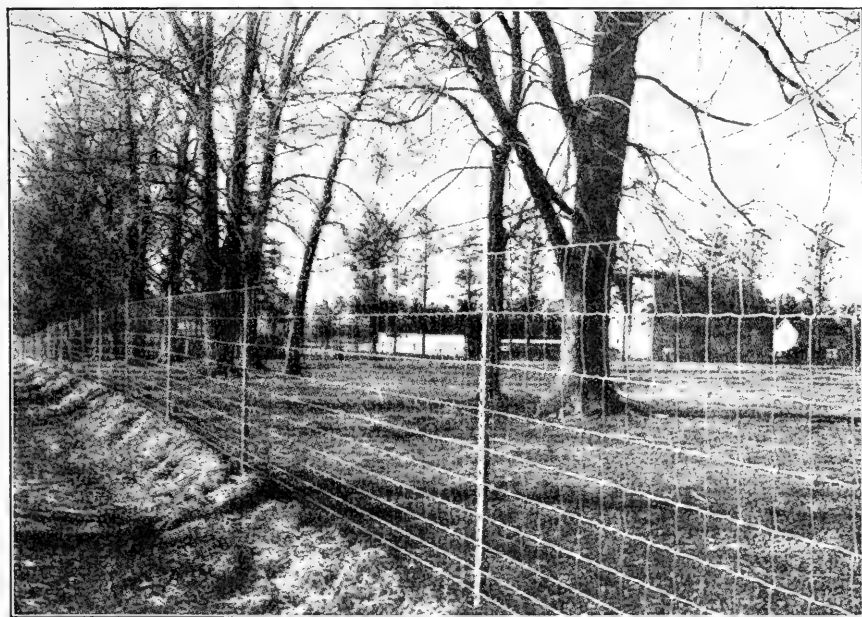

A GOOD TYPE OF FARM FENCE.¹

It will often prove economical to alternate small posts with large ones. With exceptionally good strong posts, the intervals may be as much as from 25 to 30 feet. The usual distance, however, will be from 15 to 20 feet.

Woven wire should be stapled to the posts so that the wire will move freely beneath the staple. With barbed wire the staples may be driven tightly so as to prevent the wire from slipping. The length of the staples used and the number per post depend on the hardness of the post and the number of wires. With woven wire it will usually be sufficient to staple alternate wires at each post, although the top and bottom wire should be stapled at every post. When so stapled, the staples should

¹ Courtesy of The American Steel and Wire Co.

alternate on the intermediate wires. For example, the second wire from the top should be stapled to the first, third and fifth post, while the third wire should be stapled to the second, fourth and sixth post, etc.

Woven wire calls for the strongest and best braced end and corner posts. This permits stretching the wire tightly, thus increasing its efficiency. These posts should be set to a depth of four feet in the ground, have cross pieces on the bottom to prevent them pulling up and be securely braced and anchored as shown on preceding page.

It pays to provide substantial, durable gates of light material that may be easily opened and closed. The style of gate should conform to the fence. There are on the market comparatively cheap, tubular, framed woven-wire gates that are light, neat and durable. They may be easily attached to wooden posts. If wooden gates are preferred, 1 x 4-inch material, well braced, is generally better than heavier material. The weight and strength of material, however, will depend on the strain to which the gate is likely to be subjected.

REFERENCES

- "Successful Houses and How to Build Them." White.
 "Farm Structures." Ekblaw.
 "The Care of a House." Clark.
 South Dakota Expt. Station Bulletin 154. "Pit Silo."
 Canadian Dept. of Agriculture Bulletins:
 207. "Ice Cold Storage on the Farm: How to Provide."
 220. "Lightning Rods: How to Install on Farm Buildings."
 Farmers' Bulletins, U. S. Dept. of Agriculture:
 367. "Lightning and Lightning Conductors."
 387. "Preservative Treatment of Farm Timber."
 403. "Construction of Concrete Fence Posts."
 405. "Cement Silos."
 438. "Hog Houses."
 457. "Reinforced Brick Silos."
 461. "The Use of Concrete on the Farm."
 469. "The Plaster Silo."
 474. "Use of Paint on the Farm."
 475. "Ice Houses."
 574. "Poultry House Construction."
 589. "Home-Made Silos."
 623. "Ice Houses and Their Use on the Dairy Farm."

CHAPTER 10

FARM MACHINERY AND IMPLEMENTS

During the past century the invention and introduction of farm machinery and implements has almost revolutionized methods of farming. The great change from the simplest of tools to the almost perfect farm machines has had a marked effect upon the life of the farmer. It has shortened his hours of labor, increased his efficiency and brought to him better wages. It has reduced the necessity of brute strength and increased the demand



A GOOD TYPE OF WALKING PLOW.¹

for a better developed intellect. Mechanical ability is now an essential in farming.

Advantages of Farm Machinery.—Farm machinery has decreased the percentage of people living upon farms in North America. In 1800, 97 per cent of the people lived on farms. In 1850 this proportion had decreased to 90 per cent. In 1900 it was 36 per cent and is now about 33 per cent. At the present time one-third of our population produces the bulk of food supplies and the raw materials for clothing. Consequently the remaining two-thirds are free to engage in constructive work for the advancement of the race.

This decrease in the proportion of people on farms has been accompanied by a great increase in production per capita. In 1800 in the United

¹ Courtesy of Doubleday, Page & Co., Garden City, N. Y. From "Soils," by Fletcher.

States 5.5 bushels of wheat were produced per capita. In 1850 it had fallen to 4.4. About this time improved harvesting and threshing machinery was developed and the production per capita increased rapidly. In 1880 it was 9.16 bushels per capita, and in 1915 it was 10 bushels per capita.

Although the wage of farm labor has doubled or trebled, the cost of production has decreased. The amount of labor required to produce a bushel of wheat by hand implements was a little over three hours. Improved machinery has reduced it to less than ten minutes.

Machinery has also improved the quality of farm products. Shortening the time of operations enables the farmer to plant his crops at the

proper time, thus insuring full maturity. Shortening the harvesting period enables him to gather the crop when fully matured and with the minimum loss.

Tillage Machinery.—The plow takes first rank in tillage implements. It is estimated that more power is required to plow the fields of North America than is used in all the factories. While the plow is a very old

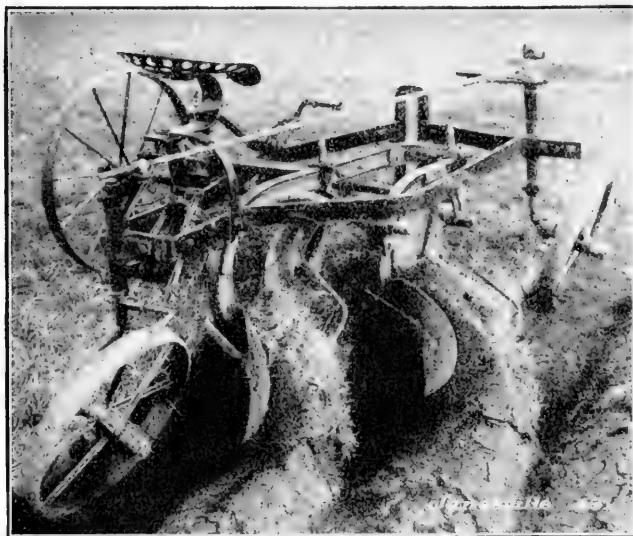

ONE TYPE OF SULKY PLOW.¹

implement, the steel plow, the sulky plow and the disk plow are implements of recent development. These are modified in form and construction to adapt them to different kinds of soil and the power available for doing the work. The mold-board plow is most universally used. It should be highly polished and kept reasonably sharp in order to perform its work with the minimum power. Rolling coulters, standing coulters and jointers are attached to more completely cover trash, prevent clogging or reduce the draft.

Disk plows are adapted to a dry soil and to land heavily covered with vegetation. They have been recently modified so that one disk follows the other in such a way that it increases the depth of plowing to 12 or 14 inches and mixes the subsoil with the surface soil.

¹Courtesy of The Janesville Machine Company, Janesville, Wis.

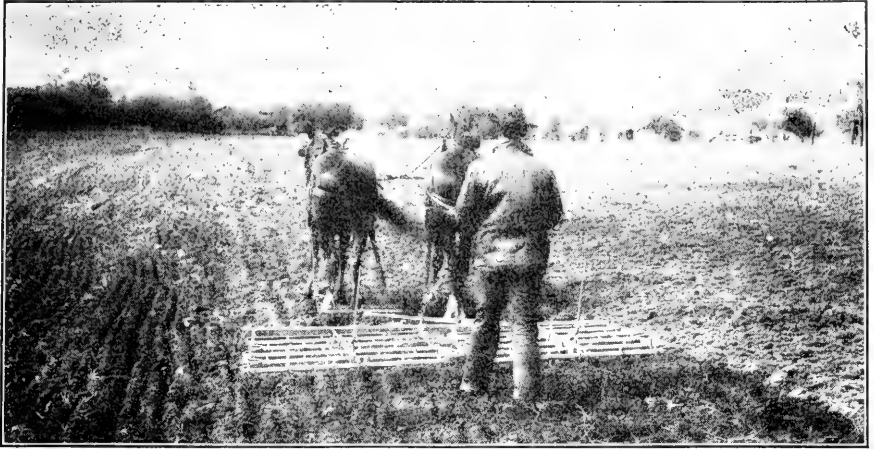

AN ADJUSTABLE SMOOTHING HARROW.¹

Mold-board plows are made in sizes ranging from 6 inches to 18 inches. The 12 and 14-inch sizes usually prevail. Where larger plows are needed gang plows are substituted. A gang plow of two 12-inch bottoms will turn 25 to 26 inches of soil at one passage of the plow and generally requires four good horses. It is essential to have the center of draft fall directly back of the center of the team, otherwise there will be a side draft that will increase

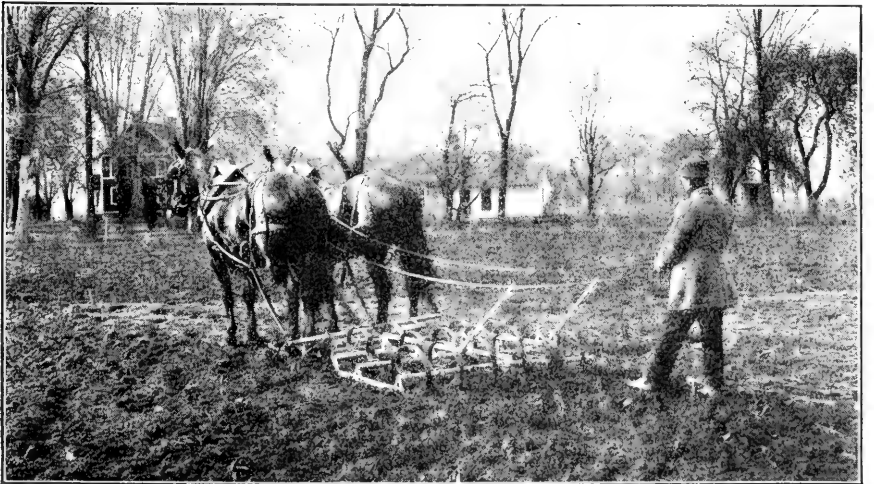

SPRING-TOOTHED HARROW.¹

¹Courtesy of The International Harvester Company, Chicago, Ill.

the draft of the plow. This necessitates adjusting the team, and if five horses are used better results will be secured by placing two in the lead and three in the rear, rather than five abreast.

Next in importance to the plow comes the harrow. The leading forms of harrows are the smoothing harrow, the spring-toothed harrow and the disk harrow. There are a number of forms and many makes of each. The steel-frame smoothing harrow, made in moderate sized sections, with levers to adjust the angle of the teeth, is most efficient. The teeth should be sharp



DOUBLE DISK HARROW.¹

in order to do effective work. They should be held in place by clamps that do not easily loosen. When one side of the teeth is badly worn, they may be turned half way around and a new surface brought into use.

The spring-toothed harrow is made with both wooden and steel frames. The better forms also have either adjustable runners or wheels to regulate the depth of harrowing and to hold the teeth out of the ground in passing from one field to another. Without these adjustments, the harrow may be turned upside-down when taken from shed to fields or from one field to

¹ Courtesy of The International Harvester Company, Chicago, Ill.

another. This form of harrow is adapted to stony land, for the destruction of weeds, for a thorough loosening of the soil and for covering broadcasted seeds rather deeply.

Disk harrows are made in two forms: the full disk and the cutaway disk. The former is most extensively used, while the latter is best adapted to stony land and for light work. Double disks frequently combine both forms. They provide for the use of large teams and increased rapidity of work without increasing man labor. Disks of the several forms are used, especially for pulverizing the soil. They should generally be followed with a smoothing harrow. Disks are generally best adapted for preparing the



A CORRUGATED ROLLER.¹

seed-bed on fall plowing or early spring plowing. They are also extensively used in preparing corn land for the seeding of spring oats without plowing. The disks of these harrows should be kept sharp to do effective work. This is especially true when there is trash on the surface of the soil. The depth of diking is adjusted by the angle at which the disks are set. Levers are provided for setting at different angles. A disk truck reduces the weight on the horses' necks, and is generally advised.

On most farms a combination of the three forms of harrows above mentioned is advantageous.

Under this heading should also be mentioned the roller and the drag. The chief purpose of the former is to compact the soil and crush clods.

¹ Courtesy of The Dunham Company, Berea, Ohio. From pamphlet "Soil Sense."

Seldom should the soil be rolled, except when very dry. Under these conditions it brings the moisture nearer the surface and helps to germinate newly planted seed. The roller is most frequently used in preparing the soil for seeding winter wheat. Rollers of large diameter compact the surface soil without much pulverizing effect. Those of smaller diameter have more pulverizing effect.

The drag or plunker is a cheap implement, usually home-made. It is generally constructed of four 8 or 10-inch planks. These are fastened together with two or three cross pieces, to which the planks are securely nailed or bolted in such a way that one plank overlaps the next about one inch. The width may vary from eight to twelve feet. Such a drag requires two or three horses, depending on length. For light work it may be loaded with stones or bags of earth. For heavier work the operator may ride upon it. The drag pulverizes the surface soil, fills up depressions and levels the surface. It is most effective when the surface soil is rather dry.

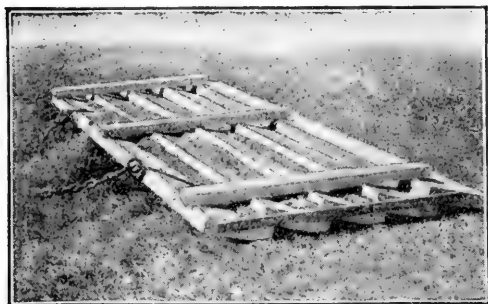

A HOME-MADE PLUNKER.¹

Cultivators.—There are numerous forms of cultivators requiring from one to four horses, depending on size. These are used for many of the truck crops, for orchards and for general farm intertilled crops such as corn, cotton, cane, potatoes, etc. Cultivators are made both for riding

and walking. The number and form of the shovels are determined by the crop to be cultivated and the character of the soil. The size and prevalence of weeds and grass are also determining factors. The large single and double shovels formerly used have largely given place to smaller shovels, disks and sweeps. The small shovels and sweeps are designed for shallow tillage, and are extensively used for both corn and cotton. Such cultivators do little damage to the roots of the crop, make an effective soil mulch, and, if used in the nick of time, destroy all small weeds.

The disk cultivator is better suited for larger weeds and for throwing the earth either to or from the plants.

Numerous forms of hand cultivators are available for garden work. There are also several forms of one-horse cultivators extensively used on truck farms.

The weeder consists of numerous flexible teeth and is designed to break the soil crust and destroy very small weeds when the plants to be

¹ Courtesy of Orange-Judd Company, N. Y. From "Soils and Crops," by Hunt and Burkett.

tilled are small. A variety of tillage implements is advantageous, and the selection should meet the needs of the owner.

Seeding Machines.—Until within the last century much of the sowing and planting of seeds was done by hand. Recently the broadcast seeder has taken the place of broadcasting by hand, and the drill and planter have supplanted hand planting of seeds either in hills or rows. The end-gate seeder, used extensively for seeding oats, and the knapsack seeders, used for grasses and clovers, are an improvement over hand seeding, but are subject to much the same defects as hand seeding. The speed of the distributor, the weight of the seed and the condition of the



A MUCH USED FORM OF CORN CULTIVATOR.¹

wind all affect the distance seed will be thrown. Great care is, therefore, necessary in the spacing of the passages back and forth across the field in order to avoid uneven seeding.

Broadcast seeders with long hoppers carried on two wheels give much better results than the sorts above mentioned. They are provided either with the agitator feed or the force feed. The latter is the more satisfactory. The former has a revolving agitator that passes over each opening from which seed issues and prevents stoppage. The rate of seeding is controlled by adjusting the size of the openings in the bottoms of the hoppers. The seed either falls on a vibrating board or passes through

¹Courtesy of The International Harvester Company, Chicago, Ill.

fan-shaped spouts that distribute it evenly over the ground. The wheelbarrow seeder used for grasses and clovers has the same arrangement, but is usually without the vibrating board or spouts.

Seeders of the same form, provided with a force feed, are most satisfactory. The force feed can be set to seed at any desired rate and makes uniformity reasonably certain.

Broadcast seeders are sometimes attached to disk harrows. The seed may be sown either in front of or behind the disks. In one case it will be rather deeply covered; in the other it will lie on top of the ground and the disk must be followed with a harrow to cover the seed.

Grain drills came into use to some extent in England soon after 1731, at which time Jethro Tull advocated a system of seeding and tillage

called "Horse Hoing Husbandry." In the United States drills worthy of mention were not perfected until after 1840. Drills are more expensive than seeders, are heavier of draft and seed more slowly. As they have become perfected they have displaced broadcast seeders to a large extent. The chief advantage lies in a uniform depth of planting that may be controlled to suit the kind of seed

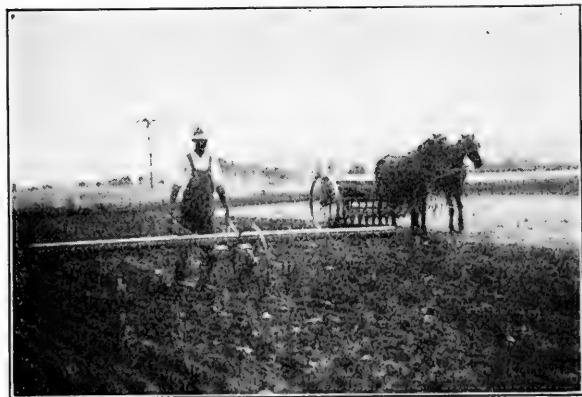

A WHEELBARROW SEEDER IN OPERATION.¹

An even distribution of grass seed is secured by its use.

and the condition of the soil. This insures more perfect germination and requires less seed than when broadcasted. Nearly all wheat is now drilled, and the best farmers also drill oats, rye and barley. Even alfalfa and the clovers are now being drilled with good results.

There are now several forms of furrow openers for drills. The hoe drill was the first to be developed. It has good penetration and works well on *clean* land, but clogs badly in trash. The shoe drill was next to be developed, but has not been so extensively used as the hoe. Disk furrow openers are of more recent use and both single and double disks are used. They are especially good in trashy ground. Press wheels are sometimes provided to follow the disks and compact the soil over the seed. Covering chains are also used, their sole purpose being to insure covering all of the seed. The several forms of furrow openers are provided

¹ Courtesy of Lowery's Summer School Report.

with a tube through which the grain passes, and these are connected with the seed box by flexible tubes either of rubber or of steel ribbon. Spaces between furrow openers vary from 6 to 9 inches, 7 inches being the most common distance.

Drills are provided with both fertilizer and grass-seed attachments if desired.

The drill compels the farmer to put his land in good condition before seeding and this is another of its advantages. For cats, the drill has very little advantage over broadcasting in wet seasons. On an average, however, drilling oats has increased the yield about three bushels per acre. It will save from one-half to one bushel of seed to each acre.

Grass and clover generally do better with drilled grain than with that broadcasted. The drill should be run north and south so the sun



THE USUAL TYPE OF GRAIN DRILL WITH SINGLE DISK FURROW OPENERS.¹

can get into the grass. With winter wheat, north and south drill rows generally hold snow better and heave less than rows running east and west. All seed used in drills should be thoroughly cleaned to avoid clogging and insure even distribution. Care should be exercised to adjust the furrow openers so that the seed will be deposited at the most desirable depth. The smaller the seed, the shallower it should be covered. Seed may be covered more deeply in a dry, loose soil than in a wet, compact one.

Corn Planters.—These are strictly an American invention and have been developed within the last sixty years. They have reached the highest stage of development of any of the seeding machinery. The corn crop is so important and is grown on land of such high value that the importance of accuracy in planting is greater than with the small grains. The

¹ Courtesy of The International Harvester Company, Chicago, Ill.

tillage demanded by this crop makes it essential that the rows be straight, and in case it is check-rowed, that the hills be reasonably compact.

The dropping device should be carefully adjusted and the plates selected to drop the desired number of kernels. It pays to grade the seed for uniformity in size. No device can do perfect work with seed corn, the kernels of which vary greatly in size. There are two forms of plates: the round-holed plate and the edge-selection plate. Whichever form is used, the adjustments should be such that the kernels of corn will not be broken.



A GOOD CORN PLANTER.¹

There are four forms of furrow openers for corn planters, viz., the curved runner, the stub runner, the single disk and the double disk. Each has its advantages, depending on character and condition of soil and presence or freedom from trash. Whatever form is used, the seed should be deposited at a uniform depth and properly covered.

There are several forms of planter wheels. Their purpose is three-fold: (1) to support the frame of the machine, (2) to cover the corn, and (3) to compress the earth about it. A solid wheel is made both flat and concave on its surface. The concave surface is superior, because it more completely closes the furrow and leaves the track slightly higher in the center than at the sides. The open wheel is also used. This leaves a

¹Courtesy of Emerson-Brantingham Implement Company, Rockford, Ill. From pamphlet "A Book About Emerson Planters."

narrow ridge of loose earth directly over the corn. This prevents crusting of the soil directly over the seed in case rains follow planting.

Check-rowers are attached to corn planters for the purpose of having the corn plants in rows in both directions. This provides for cross cultivation and is desirable on weedy soil. There are two forms of check-rowers, one in which the wire enters the device on one side of the planter and is left on the ground on the opposite side, where it is gathered up by the planter upon its return. In the other form the wire remains on the side of the planter next to the planted portion of the field. In the first form, the knots on the wire are twice as far apart as the hills of corn, each knot dropping two hills as it passes through the mechanism. In the second form the distance between knots on the wire is the same as the distance between hills.

The best planters are so constructed that the distance between furrow openers and wheels can be adjusted. The adjustment generally ranges from 3 to 4 feet in width. On good soil, corn is generally planted with rows $3\frac{1}{2}$ feet apart.

The seed boxes should have tight covers with good latches. The boxes should be hinged so that they can be inverted to change the plates without removing the corn. This also provides for the quick removal of corn when one wishes to change from one variety of seed to another.

HARVESTING MACHINERY

In no phase of farm activity has there been a greater saving of labor than through the introduction of improved harvesting machinery. In less than three-quarters of a century this phase of farm work has passed from the use of the cradle by which two men by long hours of back-breaking work could cut and bind an acre and a quarter of grain in a day, to the eight-foot self-binders, by which one man and three horses can cut and bind fifteen acres in a day. Not only is much more accomplished, but the work is better done.

Mowing Machines.—The side-cut mowing machine, in spite of its side draft, has not been displaced by the direct cutting machine. The two-horse mowing machine with a six-foot cutting bar is generally preferred. While there are a number of makes of mowing machines, selection should be made to fit the character of work to be done. The machine should be no heavier than is required for the work it is to do. The important parts of the mowing machine are the cutting device, consisting of the cutting bar, guards and sickle, and the transmission gearing which transmits the power of the team from the wheels to the cutting device. Ample adjustment should be provided for regulating the height of cutting and also for quickly elevating the bar to avoid obstructions in the field.

It is important to keep all bearings tight and thoroughly oiled. This increases the length of life of the machine and promotes efficiency. The sickle knives should be kept sharp and should be held firmly against

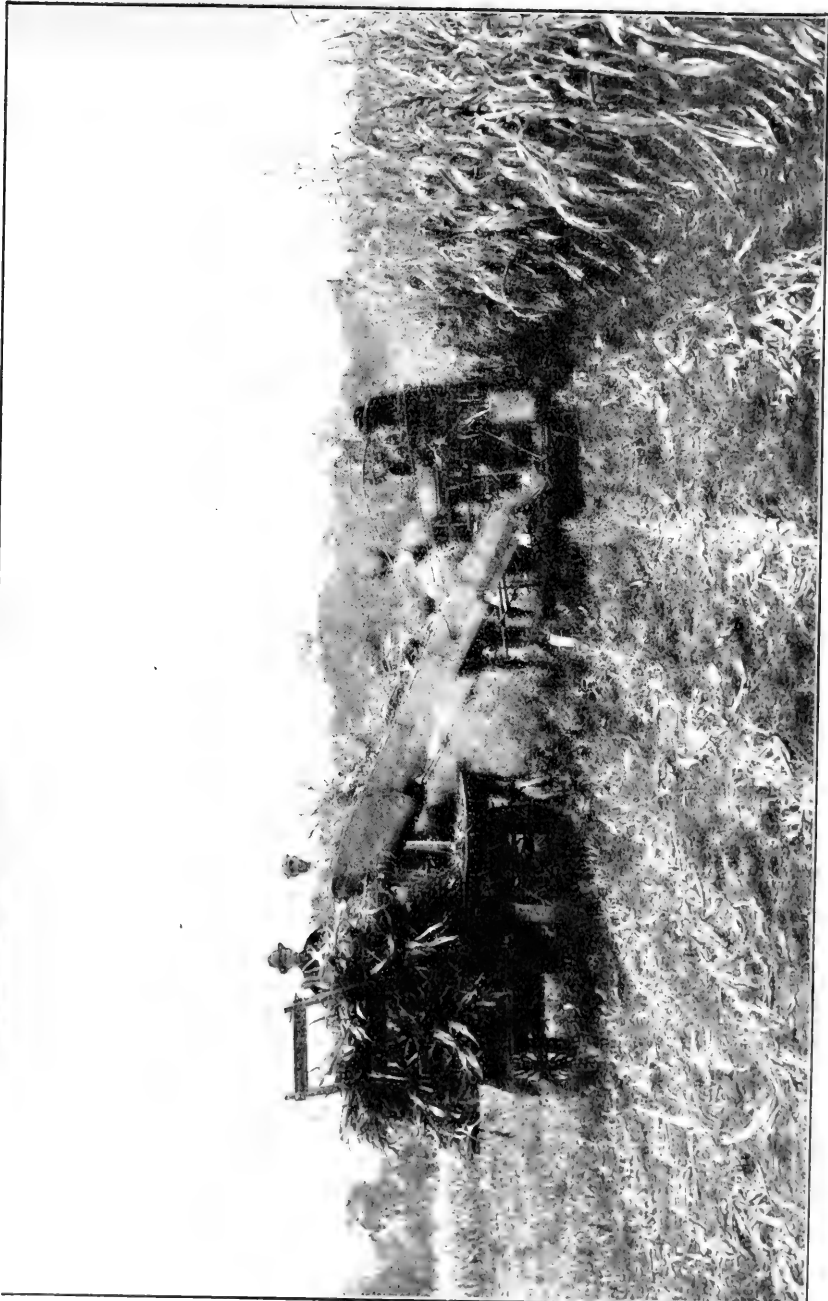

CORN HARVESTER WITH BUNDLE ELEVATOR.¹

¹ Courtesy of The International Harvester Company, Chicago, Ill.

the ledger plates. Damaged plates or badly worn and broken knives should be promptly replaced by new ones.

The Pittman bearings are the ones most likely to become loose. This will give rise to pounding, which will wear the bearings rapidly. The bearings of the Pittman at both the sickle head end and the Pittman crank end should, therefore, be of easy adjustment.

Self-Rake Reaper.—This machine soon followed the improvement and development of the modern mower. It was extensively used for a short period, but was soon displaced by the self-binder. The self-rake reaper is still a desirable machine for harvesting such crops as flax, buckwheat and clover for seed. These crops, when harvested, cling together



A MOWING MACHINE WITH PEA VINE ATTACHMENT.¹

and there is little advantage in having them bound into bundles. This machine, therefore, does the work of harvesting these crops at less initial cost of machine and a further saving in twine. Since the mowing machine and the modern self-binder are both required on most farms, the self-rake reaper is now generally dispensed with, unless the acreage of the above-mentioned crops is large.

Self-Binder.—This machine has been developed since 1875, and is now almost universally used in harvesting small grains. There are a number of different makes, but the most satisfactory ones are built principally of steel, combining strength with lightness of weight and durability. The essential parts consist of the cutting device, the elevators and the

¹ Courtesy of F. Blocki Manufacturing Company, Sheboygan, Wis.

binding apparatus. To these may be added the reel with its several adjustments and the bundle carrier. There are numerous details which will not be described here. The precautions advised relative to the working parts of the mowing machine apply with equal force to the self-binder. Various parts of the binding apparatus must work in harmony and be so timed that each part will do its work at exactly the right moment. In order to operate the self-binder satisfactorily, one should understand the working of the various parts and be capable of adjusting them.

The canvas elevators should be neither too tight nor too loose to insure good work. They should be loosened when the machine stands in the field over night. If rain threatens, it is wise to remove them or cover the machine to keep them dry. Their usefulness will be greatly lengthened by removing them from the machine, rolling them so mice cannot enter the folds and storing in a dry place at the close of the harvesting season.

The best way to keep the self-binder in first-class condition is to oil all wearing parts as soon as the harvest is over and store the machine under shelter at once. If work is not rushing at this time, repairs should be made while the farmer knows how the machine has been running and what parts need repairs. If these precautions are not taken, three or four times as much labor will be required to remove the rust and get the machine to operating smoothly the following season.

One should always have on hand a small supply of knife blades and rivets, extra links for the chains that are likely to break and a few extra small bolts and taps. It is essential to have with the machine suitable wrenches, pliers, a cold chisel, screwdriver and hammer. The frequent oiling of all bearings is necessary.

Corn Harvesters.—The modern corn harvester is the outgrowth of the self-binder. It combines the same principles in both cutting and binding apparatus. The apparatus for conveying the stalks to the binder is very different from that of the self-binder. The various parts of the machine are much stronger than those of the self-binder, in order to handle heavy green corn without straining or breaking the machine. It is designed to cut one row of corn at a time and is now extensively used in cutting corn for the silo as well as cutting more mature corn for shocking in the field.

This machine costs equally as much as the self-binder, and is an economical investment where there are twenty acres or more of corn to be harvested.

Threshing Machines.—The modern threshing machine has reached a high stage of development and does all the work of separating the grain from the straw, cleans the grain of chaff and foreign material, delivers the grain to bag or wagon and the straw to stack or mow without its being touched by the hands of man after it is forked from the wagon to the self-feeder and band cutter.

Since the average farmer does not own a threshing outfit, it is not

necessary for him to understand the details of it. Threshermen would not be satisfied with the brief description that space will permit in this chapter. They can secure ample information from the threshermen's books published by threshing machine manufacturing companies.

The clover huller is a modified threshing machine and is generally owned and operated for a community by the owners of a general thresher or corn-sheller outfit.

Small threshing machines are manufactured for individual farmers, and may prove economical for farmers in the eastern section of the

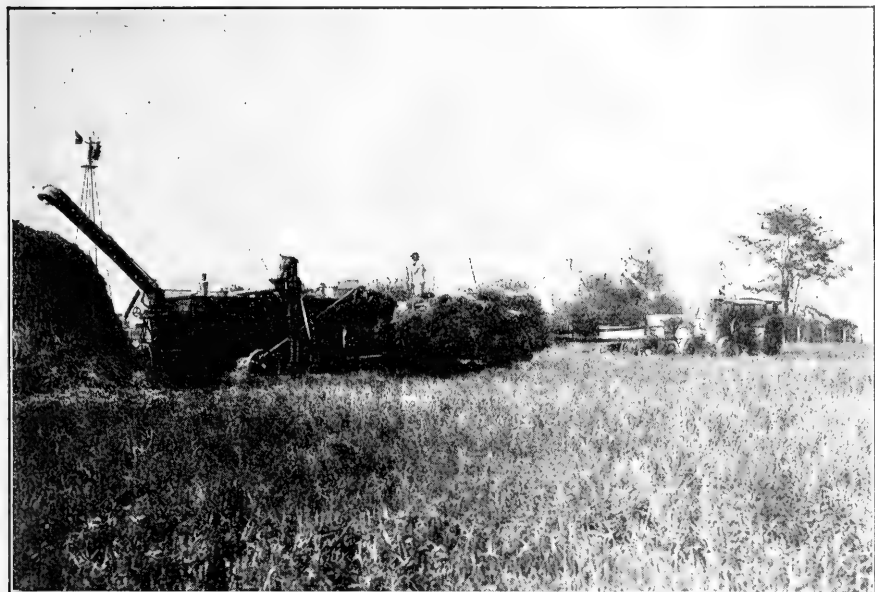

AN UP-TO-DATE THRESHING MACHINE.¹

United States, where it is the custom to store the sheaf grain in large barns and thresh it in the winter time. The essential points in operating the thresher are the speed of the cylinder, which should be uniform, the setting of the concaves, and the number of teeth in it so as to remove all grain from the heads, the speed of the fan, and the selection and adjustment of the sieves, so as to clean the grain without blowing any into the straw. Rapid and satisfactory work necessitates ample power. The power may consist of steam, gasoline or electric motors, and should be adapted to as many other uses as possible.

¹Courtesy of The International Harvester Company, Chicago, Ill.

Corn Shellers.—In the corn belt, large corn shellers are used for shelling nearly all corn that goes to market. They are owned and operated for community work the same as threshers.

Many small hand and power corn shellers are used on farms for shelling corn for feeding purposes. There are two general forms, viz., the spring sheller and the cylinder sheller. All hand shellers are of the first-named type, but some of the power shellers are of the second type. The latter are cheaper and of simpler construction, and seldom get out of order. They break the cobs badly and small pieces of cobs are more numerous in the corn than when spring shellers are used. For this reason,

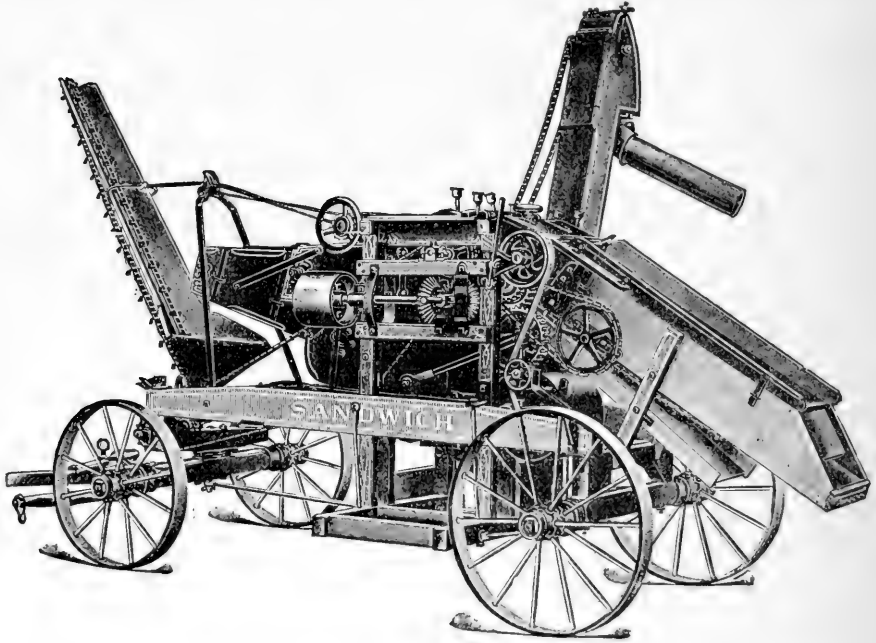

FOUR-HOLE MOUNTED BELT CORN SHELLER WITH RIGHT ANGLE BELT ATTACHMENT.¹

the spring sheller is considered superior. The unbroken cobs are much better fuel.

The larger shellers of both types are provided with a cleaning device which separates chaff, husks and cobs from the shelled corn, and elevators which elevate both shelled corn and cobs.

In order to do good work, corn should be reasonably dry when shelled. It is impossible for the sheller to do satisfactory work when corn is so damp that the kernels are removed with difficulty. Furthermore, such shelled corn will heat or spoil when placed in storage. Corn

¹ Courtesy of Sandwich Manufacturing Company, Sandwich, Ill.

shells most easily when the temperature is below freezing, especially if inclined to be damp.

Silage Cutters.—A silo may now be found on nearly every dairy farm; consequently, silage cutters are in much demand and have been greatly improved in recent years. The essential parts of the silage cutter are the feeding table, provided with an endless apron which feeds the corn into the cutting apparatus, the cutter head and the elevator. There are two types of cutter heads: one with radial knives fastened directly to the flywheel; the other with spiral knives fastened to a shaft. The modern elevator consists of a tight metal tube, through which a blast of air is driven by a fan. This blows the cut corn to the top of the silo, frequently having an elevation of 40 or more feet. It is a good plan to have a movable cylinder, either of metal or canvas to descend in the silo nearly to the surface of the filled portion. A man in the silo can move this to any point, thus keeping the surface level and avoiding a separation of the lighter and heavier portions. This not only saves labor, but provides for uniform settling of the silage.

The cutter knives should be kept sharp and be carefully adjusted so as to have a close shearing effect. If they are too loose, the material will be broken instead of cut, thus requiring more power. If the knives press against the ledger plate with too much force, there is undue friction and wearing of the knives.

The cut corn leaves the silage cutter coated with juice, and acids frequently are developed, thus causing rapid erosion and rusting of all metal parts. It is, therefore, advised to run a few forkfuls of hay or straw through the cutter to remove this material, thus leaving it in a dry condition.

Manure Spreader.—A manure spreader should find a place on every farm where there are 100 loads of manure to spread annually. It not only reduces the work of spreading the manure, but spreads it more evenly and with more rapidity than can be done by hand. Careful experiments show that light applications of manure for general farm crops bring better returns per unit of manure than heavier applications. Manure spreaders make the manure cover more land, thus increasing the returns.

The essentials of a good manure spreader are strength, ample capacity and an apron that will not clog or stick, together with a beater that will spread the manure evenly. The machine should be capable of adjustment so that any desired amount may be applied. The gearing should be covered so as to protect it from the manure. Spreaders are of heavy draft, and may be provided with shafts so that three horses may be used.

It saves time to have the spreader so placed that the manure carrier may be dumped directly into it. When filled, it may be hauled to the field, the manure spread and the spreader returned for refilling. Good farmers find it economy to provide a cement floor, slightly hollowed in the center, on which the spreader stands. This saves the liquid which

may drain from the spreader, and the overflow of manure that sometimes occurs. If this is covered with a roof the spreader is protected and leaching is prevented. If such a shed is sufficiently large, it may serve as a storage place when there are no fields on which manure may be spread.

Milking Machines.—These have been rapidly improved within the last few years, but have not come into very general use. For economical use, they require power and tubing for suction in addition to the apparatus proper. They should, therefore, be most economical in large dairies where



MILKING MACHINE IN OPERATION.¹

the power can be utilized for other purposes as well. The chief advantages of the milking machine are the saving of time in milking and cleaner milk. Cleanliness of milk demands that the apparatus be kept sterilized and clean. The machine should be washed with soda and hot water and all metal parts boiled for half an hour. The rubber parts will not permit of boiling. It is recommended that they be hung in a tank of water containing about 7 per cent of salt and 0.75 per cent of chloride of lime.

The labor saved in milking by the use of the machine may be offset by the extra work in operating and caring for the apparatus. In large dairies, where stablemen are required to do no other work, this is not a

¹ Courtesy of The College of Agriculture and Kentucky Agricultural Experiment Station, Department of Animal Husbandry, Lexington, Ky.

serious objection, since the average man can feed and care for more cows than he can milk by hand during the milking period.

Spraying Machines.—On all truck and fruit farms spraying machines are a necessity. The size and kind of outfit will depend on the size of business and character of plants to be sprayed. Wherever there are more than eight or ten acres of orchard, a power sprayer mounted on wheels is recommended. Those which develop power from the wheels are cheapest, but are not so satisfactory for spraying large trees. A high-grade gasoline engine and a good tank for compressed air provide a uniform pressure under all conditions. Good work demands a pressure of from



A POWER SPRAYER ROUTING ORCHARD PESTS.

90 to 125 pounds. Good nozzles that will give a fine spray without clogging are essential. There should be an agitator in the receptacle that holds the spraying material. The hose attachments should be ample in length to reach all parts of the trees.

Horses attached to the sprayer should be protected by suitable covering.

For small orchards or for small fruit, the barrel sprayer with hand pump, mounted on a sled, will serve the purpose. Knapsack sprayers may meet the needs for garden purposes, and are also useful in connection with larger outfits. They are suited to spraying the base of trees for mice, rabbits and borers. They are also good to spray young plants and for shrubs and bushes around the home.

Tractors.—The rapid development of small tractors adapted to a wide range of uses on the moderate sized to small farm is certain to displace considerable of the horse power within the next decade. The advantages of tractors lie in the saving of time and in the fact that they are of little or no expense when not in use. With present prices of horse feed and fuel for tractors, whether it be coal, crude oil or gasoline, the tractor furnishes power at less cost than the horse.

The motor truck is recommended for farmers having much marketing to do, especially if the distance from market is great and roads are suitable for such a vehicle.

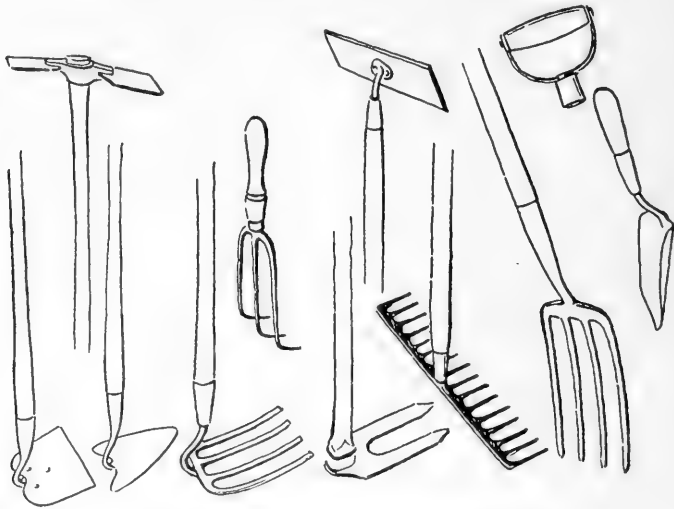

A COLLECTION OF USEFUL HAND IMPLEMENTS.¹

For a fuller discussion of farm motors and tractors, see the following chapter.

Farm Vehicles.—Farm wagons should be selected to suit the character of work to be done, and be adapted to the character of roads in the vicinity. Wide tires are recommended for farm use and for dirt roads. Under most conditions they are lighter of draft and injure roads and fields less than do the regulation narrow-tired wagons. It pays to buy the best makes of wagons, to provide shelter for them and to keep both running gear and boxes well painted.

A low-wheeled running gear on which may be placed the regulation wagon box or hay rack finds favor on most farms. It saves much lifting.

¹Courtesy of The Macmillan Company, N. Y.. From "Soils," by Lyon and Fippen.

A light runabout, suitable for one horse, is useful on nearly every farm. A carriage or surrey should be provided for the pleasure of the family.

The automobile is now displacing the carriage or surrey to a considerable extent. It serves for both business and pleasure and is a great saver of the farmer's time where considerable distance and frequent trips are involved. The automobile costs little or no more than a good driving team and carriage, and should be less expensive to maintain.

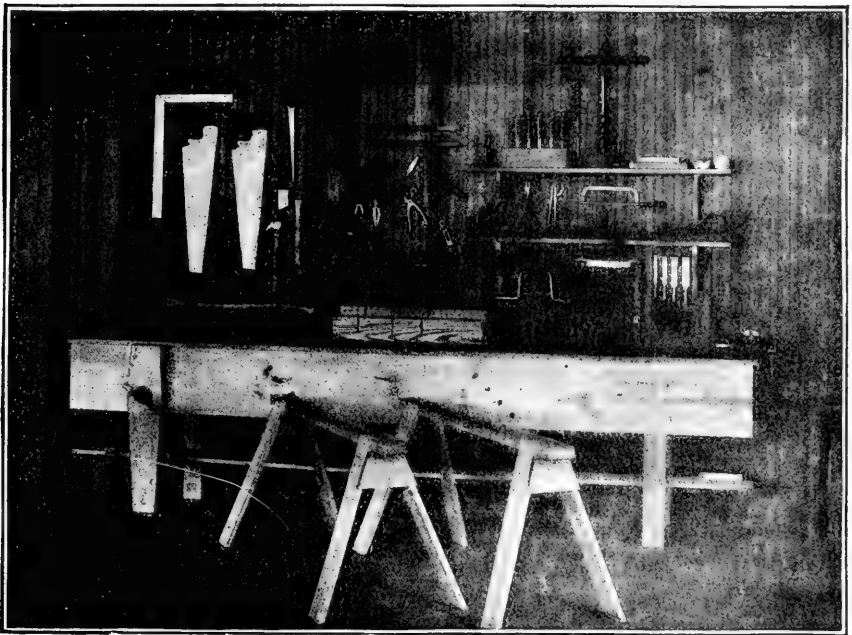

INTERIOR OF A WORKSHOP WITH A \$25.00 OUTFIT OF TOOLS.¹

Hand Implements.—The number and variety of hand implements found on a farm will be determined by the type of farming. They will be most extensively needed on truck and fruit farms. Several forms of hoes, suited to the different kinds of work, are necessary. The hand rake, spades and shovels should be of a type best suited to the work to be done. It pays to keep hand implements sharp and well polished. One can not only do more work with a sharp, well-polished hoe than one can with a dull, rusty one, but pleasure is added to the work.

There should be an ample outfit of barn implements suited to the kind of feed to be handled and the cleaning of the barn. These should

¹ From Farmers' Bulletin 347, U. S. Dept. of Agriculture.

include suitable brooms and brushes for sweeping dry floors, shovels of the size and form suited to the kind of floor and also the gutters. Good currycombs and brushes, always in their place when not in use, insure better care of the stock.

Tools.—The most used forms of carpenter's tools should be found on every farm. There should be a small shop in which to keep them and where they may frequently be used. The ax, hatchet and two or more kinds of hammers, the cross-cut and the rip saw, a brace and suitable outlay of bits, and one or more good planes will frequently be needed. There should also be a suitable collection of files, punches, pliers and wrenches. Both flat and three-cornered files will be found useful. The

bastard and second-cut are the grades of files most needed for general work. Cold chisels and a few wood chisels will also be useful. There are many other small tools that can be added to the outfit as needed. The extent of the outfit will be determined by the extent and character of the farm machinery, the mechanical ability of the farmer and the accessibility to local repair shops.



HOME-MADE BARREL CART FOR HAULING LIQUID FEED.¹

innumerable conveniences, many of which are home-made, that find much use on the farm. Among these may be mentioned the various forms of eveners and double-trees, suitable to three horses or more, and made to suit the character of machinery on which used.

A pump with hose attachment, fastened to a board, may be placed across the wagon bed and is very handy in filling barrels from a stream or shallow well. A derrick of suitable height is useful in the home butchering of hogs, sheep, calves or beef animals. A hoisting apparatus suitable for putting hay into the mow or stack should find a place on nearly every farm.

The wagon jack will make the work of greasing wagons and other vehicles easy.

A hand cart and a wheelbarrow are frequently needed. Suitable

Handy Conveniences.

—There are

¹ Courtesy of The Pennsylvania Farmer.

carriers operated on tracks in the barns are superior to the wheelbarrow for conveying feed to mangers and manure to the spreader or manure pit, but are more expensive.

Standard measures for carrying and measuring grain are always useful. These may be in the form of good splint baskets or as metal measures with handles.

Machinery for the House.—The weekly wash for the average farm family, when done in the old-fashioned way, is a laborious task. It can be greatly lightened by the use of the washing machine, wringer and mangle that are operated by mechanical power. A laundry, with modern equipment, is of more urgent need in the country than in the city. Power for such a laundry may be used for other purposes, such as pumping water for a pressure system, operating the cream separator, churn and possibly a suction cleaner. There are too many farmers who are able to supply such an equipment who are content to permit their wives to do this work in the old-fashioned way. It is safe to predict that if these



HOME-MADE DUMP CART TO MAKE STABLE WORK EASIER.¹

duties were to fall to the lot of the farmer himself, he would find a way to do the work more easily and quickly.

There are on the market many labor-saving household implements, including power churns, cream separators, sewing machines, meat cutters, vacuum cleaners, etc. Wherever electricity is available, electric irons and other electrical devices help to lighten the work.

If water must be pumped or drawn from the well by the housewife, no reason exists why a pipe could not be extended and a pump placed in the kitchen or a pump house connected with the kitchen.

¹ Courtesy of The Pennsylvania Farmer.

Buying Farm Machinery.—The farmers of the United States spend more than \$100,000,000 annually for the purchase of farm machinery. The average life of such machinery is about ten years. Its durability could doubtless be much lengthened if it had better care.

It generally pays to buy the best makes of machines, even though the initial cost is greater than that for cheaper ones. Whether or not it pays to buy a machine depends on the amount of work for which it can be used. If the amount of work is small, it is frequently cheaper to hire a machine than to own one. In some localities the more expensive machines are owned jointly by two or more farmers.

It requires good judgment to know when to replace an old machine with a new one. Frequently machines apparently worn out may be made to work as good as new by replacing badly worn parts. On the other hand, some machines go rapidly out of date because of important improvements. A new machine may, therefore, be purchased to advantage and the old one discarded even though not worn out. There is a tendency on the part of too many farmers to get along with the old machine at a sacrifice of much time spent in continual repairing.

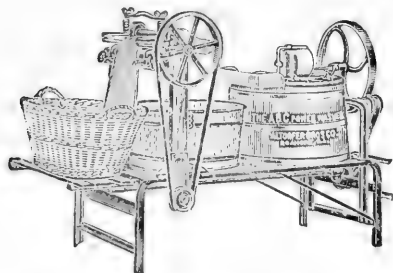

A WASHING MACHINE SAVES MUCH
HARD WORK FOR THE HOUSEWIFE.¹

Care of Machinery.—Every farmer should have a shed large enough to house all his farm implements. This may be a cheap structure, the two essentials being a dry floor and a good roof. There should be sufficient room to store the implements without taking them all apart. It is well to arrange them in the shed when time is not pressing, so that those first needed in the spring are most accessible.

The woodwork of all machinery should be painted whenever it shows need of it. This should be done in leisure time. All machinery should be examined and nuts and bolts tightened. The metal parts, such as the surface of plow bottoms, cultivator shovels, the disks of disk harrows, drills and cultivators should be greased, either with kerosene and tallow or cheap axle grease, as soon as their work is done. This prevents rusting and is easily removed when the machine is again needed for use. Although paint is sometimes used for this purpose, it is not advised, as it is too difficult to remove.

Condition of Machinery.—Every farmer realizes the importance of having all machinery and implements in good working order. This pertains to the adjustment of all complex machinery and applies also to the adjustment of clevises on plows, so that they will run at the proper depth. A machine out of adjustment not only does its work poorly, but

¹Courtesy of Altorfer Bros., Roanoke, Ill.

generally requires more power to operate it. Some one has well said, "Constant vigilance and oil is the price of smooth-running, efficient farm tools, and to spare either is dangerous as well as expensive." Saws that will saw, knives that will cut, hammers that will stay on their handles, are much to be preferred.

Utilizing Machinery.—A full equipment of farm machinery costs so much that interest and depreciation are a burden for the small farmer. This may be overcome by joint ownership of the more costly machines. Large farms can own a complete outfit and utilize it quite fully. The smaller the farm the greater the machinery cost per acre. On small



WHERE DO YOU PREFER TO KEEP YOUR IMPLEMENTS? UNDER THE SKY?

farms the use for certain machinery may be so small as to make ownership unprofitable.

The greater the skill and higher the wage of workmen, the greater the necessity of using the best and most efficient machinery.

For the general farmer tools that are adjustable and can be used for several purposes are advantageous. A combined spike and spring-toothed harrow that may be changed from one to the other by the use of two levers often saves an extra trip to the house or prevents one being used where the other would have served better. The same principle applies to cultivators where gangs or shovels can be changed for disks or sweeps.

Cost of Farm Machinery.—The principal items in the cost of farm machinery are depreciation, interest on the capital invested, cost of repairs,

¹ Courtesy of Wallace's Farmer,

oil and labor in caring for machinery, together with the proper housing of it. When these costs are figured on the acre basis the rate varies inversely in proportion to the acres covered. Low cost, therefore, is associated with the fullest possible utilization of the machines. It is significant that the high-priced machines are usually those used for the shortest period.

The method of computing the cost of farm machinery is well illustrated in the accompanying table taken from the *Tribune Farmer*:

TABLE SHOWING METHOD OF FINDING THE COST OF USING FARM MACHINERY.

IMPLEMENT.	Date of Purchase.	Purchase Price.	Estimated Life.	Actual Life.	Approximate Average Value for Life.	ANNUAL COSTS.				1910, Hours Used.	Cost per Hour.
						Five Per Cent Interest.	Depreciation.	1910, Repairs.	Total Cost.		
Two two-horse walking plows.....	1902-04	\$24.00	16.4	..	\$13.00	.65	\$1.46	\$0.95	\$3.06	344	\$0.0089
Spring-tooth harrow.....	1902	14.40	11.4	12	7.50	.38	1.26	.33	1.97	242	0.0073
Spike-tooth harrow.....	1903	12.00	20.0	..	6.50	.33	.60	.25	1.18	78	0.0151
Roller.....	1903	12.00	15.0	..	6.50	.33	.80	3.25	4.38	82	0.0534
Weeder.....	1906	9.00	17.5	..	5.00	.25	.52	.32	1.09	25	0.0436
One-horse plow.....	1905	7.50	16.4	..	4.00	.20	.46	.18	.84	10	0.0840
Two riding cultivators	1903	31.00	13.7	..	38.00	1.90	5.33	4.30	11.53	154	0.0749
	1906	42.00
Grain binder.....	1902	125.00	12.5	..	64.00	3.20	10.00	2.98	16.18	28	0.5773
Grain drill.....	1904	70.00	14.8	..	37.00	1.85	4.73	3.50	10.08	59	0.1710
Fanning mill.....	1904	25.00	21.8	..	13.00	.65	1.15	.65	2.45	35	0.0700
Mower.....	1903	38.00	12.8	..	20.00	1.00	3.00	1.37	5.37	16	0.3356
Hay rake.....	1903	18.00	12.8	..	9.50	.48	1.40	.50	2.38	16	0.1488
Orchard sprayer.....	1908	80.00	10.0	..	42.00	2.10	8.00	5.25	15.35	44	0.3490
Gasoline engine.....	1908	200.00	13.5	..	105.00	5.25	14.83	5.10	25.18	128	0.0200
Harnesses.....	1902-03	83.50	16.2	..	43.00	2.15	5.15	5.60	12.90	3192	0.0037
Wagons, boxes, racks.....	1903	110.25	20.5	..	58.00	2.90	5.38	4.75	13.03	250	0.0521
Hay slings, fork track.....	1909	50.00	20.0	..	26.00	1.30	2.50	.50	4.30	40	0.1075
Miscellaneous minor equipment.....	1902	386.00	10.0	10	197.00	9.85	38.60	1.38	49.83	78*	0.6400*
Total cost.....	\$1,337.65	12.7	..	\$695.00	34.77	\$105.17	\$1.16	\$181.10

Numerous records of the cost of farm machinery show that the annual cost per farm is about one-quarter of the actual value of the machinery for the year involved.

Farm surveys in Wisconsin indicate that too many farmers economize on their farm equipment to such an extent that efficiency is sacrificed and profits are below what they would be with a more modern and efficient equipment.

Duty of Farm Machinery pertains to the amount of work each machine will do daily or for the season. Manufacturing concerns standardize different operations in their shops as much as possible. This enables them to estimate very closely the amount of work that can be turned out in a given time, and makes it possible for them to state to customers when a stated task can be completed. It is just as essential for the farmer to

* Miscellaneous minor equipment charges are distributed on the basis of the total productive area of the farm, 78 acres. In this group all machinery and small tools not specifically mentioned are included.

standardize his various machines in order to know what machinery will be required for his various operations.

There are many factors influencing the duty of a given machine, such as the speed of the team, the weather conditions and the condition of the ground. On an average, the daily duty of a machine in acres is equal to the width in feet times 1.4. In other words, a 12-inch plow will average 1.4 acres per day. A 6-foot mower will cut 8.4 acres per day. The size of fields will also influence the duty, since small fields require more turning and loss of time.

Careful investigations in Minnesota and Ohio show that in the former state the acre cost of corn machinery is \$1.07, while in the latter it is only 49 cents. The lower cost in Ohio is due chiefly to the relatively larger acreage of corn per farm and the fuller utilization of machinery.

REFERENCES

- "Farm Machinery and Farm Motors." Davidson and Chase.
Kentucky Expt. Station Bulletin 186. "Mechanical Milker."
New York Expt. Station Bulletin 353.
Ohio Expt. Station Bulletin 227. Circular 98.
U. S. Dept. of Agriculture, Bureau of Plant Industry, Bulletins: 44, 212.
Farmers' Bulletin 347, U. S. Dept. of Agriculture. "Repair of Farm Equipment."

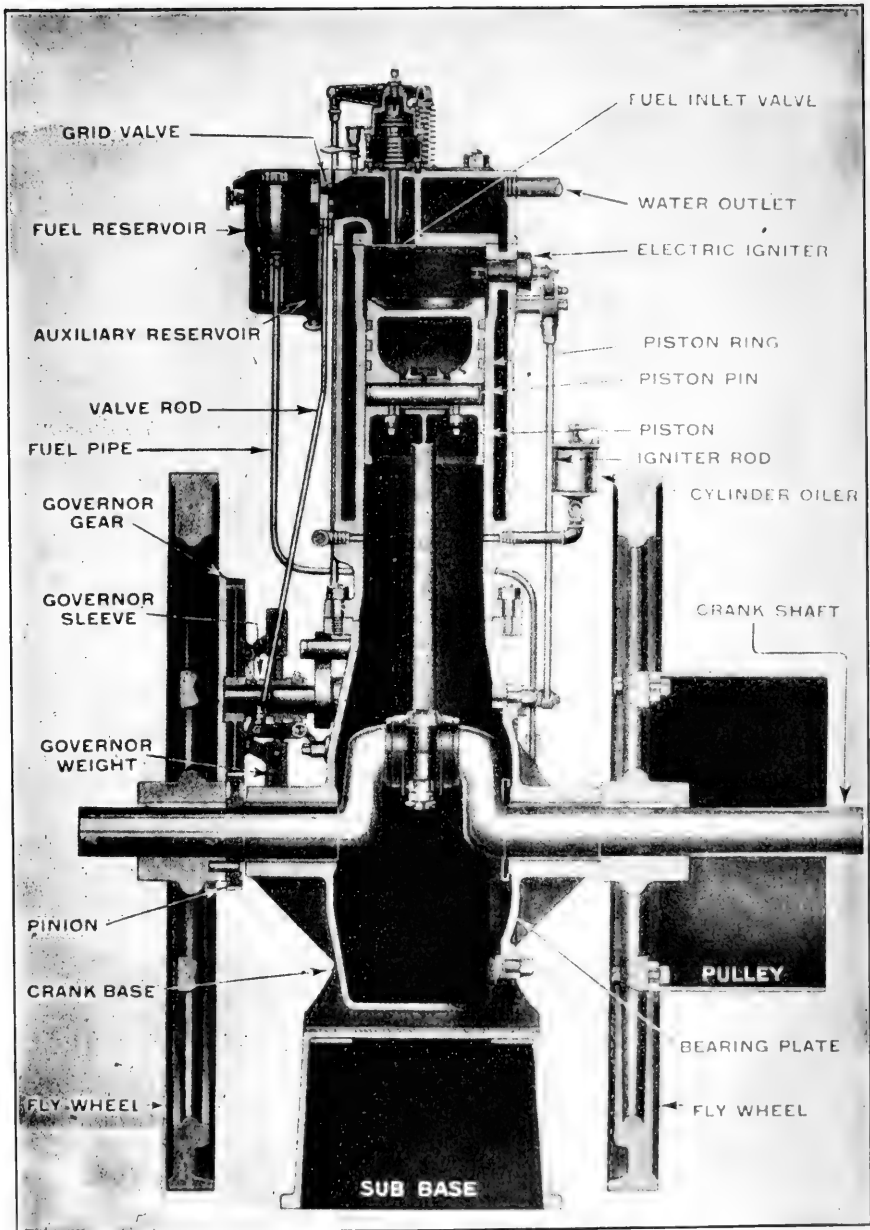

SECTIONAL VIEW OF A FOUR-CYCLE VERTICAL GAS ENGINE.¹

¹Courtesy of Fairbanks, Morse & Co., Chicago, Ill.

CHAPTER 11

ENGINES, MOTORS AND TRACTORS FOR THE FARM

BY R. U. BLASINGAME

Professor of Agricultural Engineering, Alabama Polytechnic Institute

THE REAL POWER FOR THE FARM

The real call of the farm is for power, some means by which the skill of a single man can direct a force that will do as much work as a score or more men could do unaided. From plowing to the feed trough, it takes $4\frac{1}{2}$ hours work to raise one bushel of corn by hand. The use of improved machinery and the multiplicity of power has reduced this figure to 41 minutes.

Various forms of power, such as the treadmill, the sweepmill and the windmill, have all failed in many respects. Windmills are objectionable because they are not portable, they are not steady in power and are often wrecked by the wind. The sweep power is hard to move, cumbersome and requires the operators to be exposed to many storms.

The steam engine, but for the close attention it requires, might be the real power needed for farm purposes. Electricity, when correctly installed, is safe, efficient and convenient, but for farm purposes where all jobs are not under one roof as in factories, the lack of portability makes it inconvenient.

The gasoline engine is the only power at the present time that embodies all the requirements for farm purposes. The operator of such power needs no greater mechanical training than should be necessary to properly operate a grain binder. If power is needed in the laundry room, a small engine might easily be transported to run a washing machine. If it is needed in the furthest corner of the wood lot, it can be conveyed to that place without a second or third trip for water and coal, as would be required for a steam engine. In the coldest, driest and calmest weather the gas engine produces power without delay. It can be obtained in units of from one-half horse power to any size that might be required for any farm job.

In parts of the West where the gas engine is best known, it is plowing, harrowing and seeding in one operation by the square mile instead of by the acre, and is doing the work better quicker and cheaper than it could be done by horse or steam power.

Gas Engine Principles.—There are two distinct types of gas engines on the market at the present time which are used for agricultural purposes; the four-stroke cycle and the two-stroke cycle engine.

The four-stroke cycle or four-cycle engine requires four strokes in order to get one working stroke. These strokes are as follows: The intake

stroke, in which the charge of air and gas is mixed in the right proportions to give an explosive mixture. The second stroke compresses the charge of air and gas which was previously drawn into the cylinder. The third stroke is the working one in which the compressed charge of air and gas is exploded and the energy hurled against the piston head. The fourth stroke is the exhaust, or elimination of all the old gases which were burned. Therefore, the four-cycle engine requires two revolutions of the fly wheel to complete the four strokes necessary for obtaining power from this type of

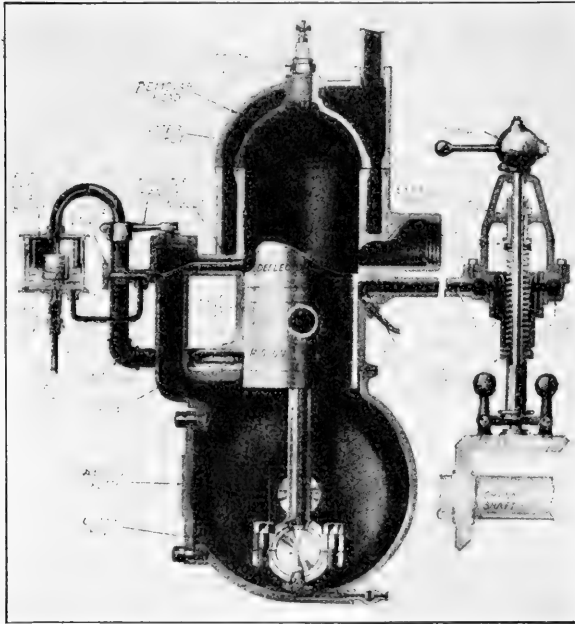

SECTIONAL VIEW OF A TWO-CYCLE ENGINE.¹

engine. The four-cycle engine requires two openings which are provided with valves held tightly in place by springs. These valves are operated by mechanical means, although in some engines the intake valve is operated by suction. The two-stroke cycle or two-cycle engine requires two strokes of the piston in securing one working stroke. Therefore, this engine theoretically receives twice the power per square inch hurled against the piston that the four-cycle engine does. The crank case of such an engine must necessarily be airtight, because the charge of air, or sometimes a mixture of air and gas, is brought into this part on the up-stroke of the piston and on the downward stroke the burned gas passes out of the exhaust port while the new gas from the crank case enters the combustion chamber. It is, therefore, entirely necessary that the crank shaft which runs through the crank case fit airtight in its bearings. This is a condition which is difficult to maintain, especially in an old engine. This type of engine does not operate with valves at the intake and exhaust, but operates with ports or openings which are opened and closed by the piston passing over them.

About 90 per cent of all the gas engines used for agricultural purposes

¹ Courtesy of Ellis Engine Company, Detroit, Mich.

at present are of the four-cycle type; also all but a few of the automobile engines are of this type. By experience, users and manufacturers have found the four-cycle engine the most successful.

Vertical and Horizontal Engines.—Either four-cycle or two-cycle engines may be vertical or horizontal in appearance. The horizontal engine, especially of the four-cycle type, is much easier to repair than the vertical one. However, the vertical engine requires less space for its installation, but may not lubricate as well as the horizontal engine with the oil flowing from the top of the cylinder.

Ignition.—There are three types of ignition used in gas engine operation: high tension, low tension and compression ignition.

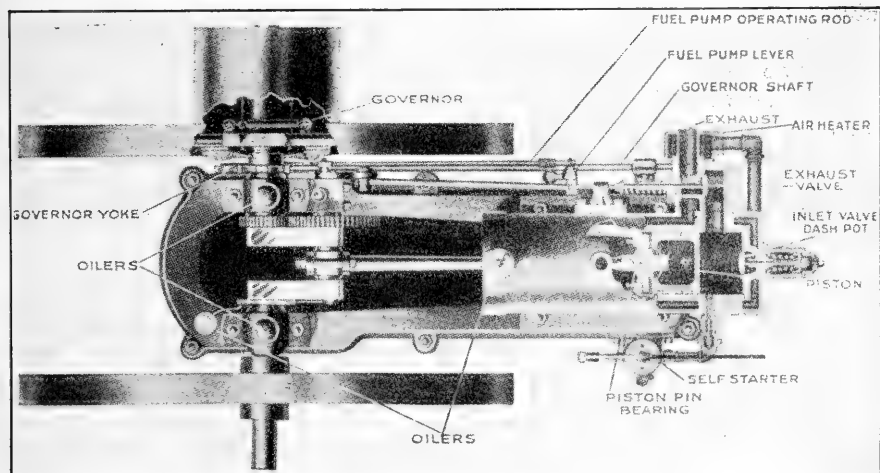

SECTIONAL VIEW OF A FOUR-CYCLE HORIZONTAL GAS ENGINE.¹

The high tension system requires a current of electricity with a voltage sufficiently high to cause a spark to jump from one point to another of a spark plug. This system is used, as a general rule, on high-speed motors.

The low tension system requires a low voltage for ignition of compressed air and gas mixed together in the compression chamber. The spark is produced by the separation of two points in the cylinder which have been brought together and caused to separate.

The source of current for these two types of electric ignition may be from dry or wet batteries or from magnetos. A very successful means of ignition is the battery to start the engine and the magneto to furnish the source of current after it is in operation. In no case should any one purchase a modern engine without a magneto. It is not heir to the many

¹ Courtesy of Fairbanks, Morse & Co., Chicago, Ill.

diseases which render battery ignition worthless. The most modern engines do not require batteries even for starting the engines.

Compression ignition is not so common at present in gas engine operation. It may be found upon several recent crude-oil engines, some of which are being used very successfully and cheaply for agricultural purposes. The principle of this ignition depends upon the separation of the heavy and light gases as the fuel is vaporized and drawn into the cylinders with the charge of air. In the compression stroke the lighter gases are ignited by the heat generated by the compression caused by the advancing piston. The light gases in turn ignite the heavier ones. This type of engine not only burns a very cheap grade of fuel, but may be operated with gasoline, kerosene or most any mixture of the fuels used in internal combustion engines.

Cooling Systems.—When a mixture of gas and air is exploded in a gas engine the temperature rises to about 3000° F., which would melt the cylinder of such an engine if a part of the heat was not conducted away in some manner. Some manufacturers use water, some oil and others air for cooling gas engines. Also a mixture of several liquids is sometimes used in extremely cold weather to prevent freezing and the consequent bursting of the water jacket. Oil, when used for this purpose, takes the place of an anti-freezing mixture.

Some engines are cooled by water poured around the cylinder in a hopper and the heat conducted from the engine by means of evaporation. Other engines require a circulating pump which causes some liquid to be circulated through the water jacket and thence over a screen where it is partially cooled and used again. There are other types of liquid-cooled engines which depend entirely upon the liquid circulating after the engine is warm enough to cause convection currents.

The air-cooled engines for agricultural purposes have not proven altogether satisfactory on account of the small radiating surface; also the poor material which enters into the make-up in order that it may sell at a cheap price.

Lubrication.—Graphite is the true lubricant. It is not affected by heat or cold. The reason it is not used more than it is, is because of the inconvenience it offers in passing through small openings which are ordinarily used for oils. A mixture of powdered graphite and oil might be occasionally placed in gas engine cylinders to aid in lubrication, but this could not be depended upon entirely because the operator may forget when it is time to replace the lubricant.

All bearings may be lubricated with a cheap grade of animal or vegetable oil, but the cylinders of a gas engine must not be lubricated with any except the best grade of gas engine cylinder oil. The temperature in the cylinder of a gas engine is extremely high; therefore, a vegetable or animal oil would burn and be worthless for lubricating. More gas engines are sacrificed to the god of friction each year than from any

other legitimate cause. It should be remembered by all who operate gas engines that oil is cheaper than iron.

The gravity system is the most common means of lubrication. It consists of a glass cup placed above the highest point to be lubricated. The splash system is very often used and consists of a crank case filled with oil to the point that the crank touches the oil at each revolution. The force feed type of lubrication is very successful; however, it adds a few more working parts to an engine, which complicates and may cause an added trouble. There are other systems of lubrication which will not be mentioned because of the infrequency of their use.

Gas Engine Parts.—The base of a gas engine supports the cylinder and all other parts of the engine structure. It should be in proportion

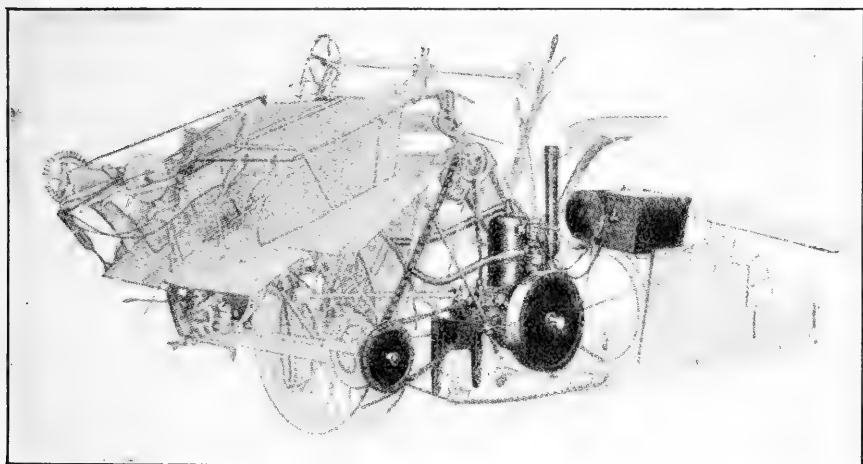

THREE H.P. GAS ENGINE OPERATING BINDER.¹

to the rest of the engine. The cylinder serves the purpose of a container and a receiver. It should be smooth and free from irregularities or dark spots. The cylinder contains the piston and receives the charge and its walls receive the force of every explosion. The piston transmits the power to the connecting rod which is similar to the pitman of a mowing machine. The crank shaft receives the sliding motion from the connecting rod and changes it into rotary motion.

Governors.—There are two distinct types of governors used in gas engine operation at the present time. The hit-miss governor causes the exhaust valve to be held open mechanically when the engine begins to run above speed. So long as the exhaust valve is held open fresh air is drawn in and blown out; therefore, no power is obtained. As soon as

¹ Courtesy of Fairbanks, Morse & Co., Chicago, Ill.

the engine begins to operate below the rated speed, the exhaust valve closes and a charge of air and gas is drawn into the cylinder through the carburetor. This type of governor, of course, gives an uneven speed, but it is all right for ordinary agricultural purposes. It would not do for furnishing electric lights direct from the dynamo, because the lights would flicker with every variation in speed. This type of engine would do for charging batteries from which lights may be taken.

The throttle governor regulates the amount of air and gas mixture which enters the combustion chamber. This is done automatically in the stationary engines. This type of governor may be relied upon to give a more even speed than the preceding one, and especially is this true if extra heavy flywheels are used.

Gas Engine Troubles.—Gas engine troubles are almost unlimited. They are generally from two causes: the things we forget and the things we don't know. Troubles most frequently occur in the ignition system or from lack of proper lubrication. The first is easily remedied, but the latter usually means a new part. If dry batteries are used they may become wet and deteriorate, or a connection may be loose in the wiring. A drop of oil or water may be over the point of the spark plug. Points of the spark plug may be too far apart or too close together. There may be a loss of compression due to leaking valves or piston rings which do not fit tightly against the walls of the cylinder. Leaking may take place also around the spark plug or igniter. The mixture of air and gas may not be proper, in which case, either the gasoline supply is not regular or the air is not properly supplied. In cold weather the fuel often refuses to vaporize. Such a condition may be remedied by pouring hot water in the water jacket in order to warm the cylinder enough for good vaporization.

TRANSMISSION OF POWER

The best farm motor on the market is of no value on the farm unless the power which it develops is transmitted to some other machine doing useful work. Power is transmitted by shafting, belts and gear wheels. While there are other methods of transmitting power, they are only modifications of these three.

Shafting.—The shafting should transmit to the pulleys which it carries whatever energy it receives minus the amount consumed by friction at its own bearings. Shafting should be of the very best material in order to reduce the friction in the bearings by reducing the size. It should be absolutely straight, because much power is required to spring even a two-inch line shaft into line during each of two hundred or four hundred revolutions per minute. A shaft should be driven from the center if possible and between two bearings, and transmit its power to a series of pulleys on either side of the main drive. If possible, heavy shafts should have their bearings or hangers rest upon posts which are directly connected with the ground, because there is always more or less "give"

in the average floor, especially if heavy storage should be above. Line shafting hangers should not be over 8 feet apart and if the shaft is light, not more than 6 feet apart. The horse power of a good shaft may be figured in the following manner:

Multiply the cube of its diameter by the number of revolutions per minute and divide the result by 82 for steel and 110 for iron. In other words, "The amount of power that can be transmitted by two shafts of similar quality varies directly with the speed and with the cubes of their diameters."

The twisting strain on a shaft is greatest near the main drive; there-

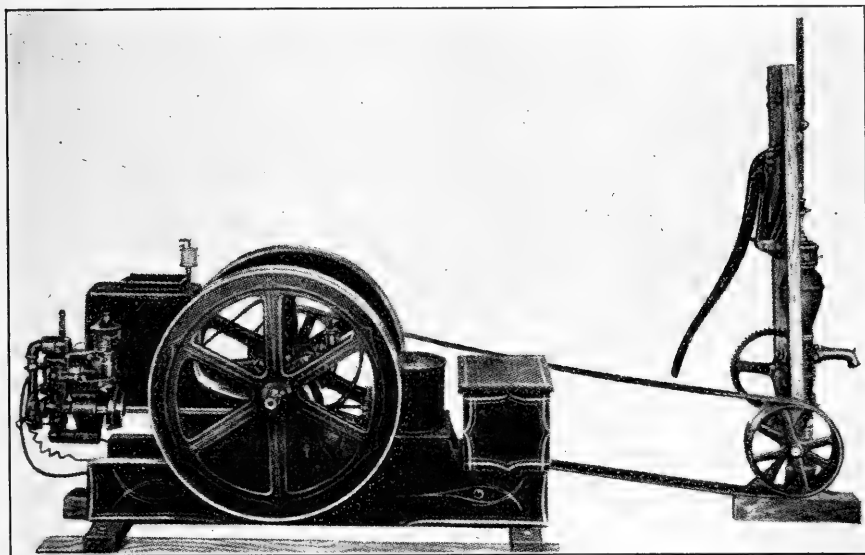

ENGINE OPERATING PUMP JACK.¹

fore, the nearer the main drive is to the hanger, the more nearly will its strain be counteracted. A disregard of any of the above principles is calculated not only to waste power, but gives an unsteady energy to the machine driven and affects both the efficiency and life of the machine being driven by it.

Speed of Shafting.—If only one machine is to be driven by a shaft the problem of shaft speed is very simple. With the operation of a cream separator at a speed of 60 revolutions per minute and a wood saw at a speed of 400 to 600 revolutions per minute as well as other varied speeds, the problem is more difficult. It is at this point that many very large, expensive pulleys and a number of very small pulleys upon which belts

¹Courtesy of The Christensen Engineering Company, Milwaukee, Wis.

do not work very successfully are used. It is best to average all the speeds of machines and operate a line shaft at a medium speed.

The Size of Pulleys.—From the following formulas and conditions one may figure the speed or diameter of any given pulley.

With the speed of the driver, the speed of the driven and the diameter of the driver given, the diameter of the driven may be found.

EXAMPLE No. 1.

$$\frac{\text{Diameter of the driver} \times \text{speed of the driver}}{\text{Speed of the driven}} = \text{Diameter of driven.}$$

EXAMPLE No. 2.

$$\frac{\text{Given the Speed of the driven} \times \text{diameter of the driven}}{\text{Speed of the driver}} = \text{Diameter of driver.}$$

EXAMPLE No. 3.

$$\frac{\text{Given the Diameter of the driven} \times \text{speed of the driven}}{\text{Diameter of the driver}} = \text{Speed of the driver.}$$

EXAMPLE No. 4.

$$\frac{\text{Given the Diameter of the driver} \times \text{speed of the driver}}{\text{Diameter of the driven}} = \text{Speed of the driven.}$$

Kind of Pulleys.—Pulleys on the market at the present time are manufactured from cast iron, steel, wood and paper. Of these, iron is the most commonly used. It is more compact than wood and is cheaper than steel, although wood can stand much higher speed than the average iron pulley of similar size and design. Wooden pulleys have the advantage of holding to a belt better than steel or iron, especially if a belt begins to slip upon the iron pulley, thus wearing its face very smooth. For light work the split pulley, or the pulley which can be divided into two parts, is the most convenient upon the market, especially if machines are changed from time to time for different purposes.

Straight and Crown Faces.—Iron pulleys are usually made crowning or slightly oval across the face. Where belts do not require shifting, this form holds belts to place in good shape. If the load is not heavy the crown pulley does not weaken the belt to a great extent, but with heavy loads the main strain comes upon the center of the belt and this causes a stretching and often develops splits.

Covering Steel Pulleys.—If steel pulleys are used and their surface becomes slick to the point where belts slip badly, they may be covered with a leather face. This can be accomplished in the following manner:

Clean the surface of the pulley with gasoline and apply a coat of varnish upon which a layer of soft paper is placed. Upon this paper a second coat of varnish is applied. A piece of leather belting is cut to fit the diameter of the wheel and while the varnish is still moist the section

of belting is laced as tightly as possible upon the surface. The size of the pulley has now been materially changed; therefore, the effect upon other machines must be corrected.

Pulley Fasteners.—Pulleys may be fastened to line shafting either by a key fitting into a key seat both in the pulley and the shafting or by means of a set screw. The set screw arrangement is convenient and is often used where light work is to be done. The set screw may be a source of danger, especially in machines run at a high speed and where they are exposed and likely to catch the clothes of an operator. Also if the set screw once slips and grooves the shafting, it becomes necessary to shift the pulley to a new place.

BELTS AND BELTING

About 90 per cent of all the power transmission in the United States is accomplished by means of belts.

Advantages of Belts.—In the first place, belts are noiseless. Energy may be transmitted by them at a much greater distance than by direct gears. There is less risk of accident than by any other means of transmission. They are simple and convenient and are applicable to a great many conditions. In case of breakage they can easily be repaired, and in case machines are moved this means of transmission is the most convenient. For these reasons belting is especially adapted to farm uses.

Disadvantages.—Belts are expensive because they wear very easily. They are not always economical of power and unless carefully adjusted and of ample size they are likely to slip.

Essentials of a Belt.—If a belt has strength, durability, the absence of stretch and pulley grip, it has four very valuable qualities. Other qualities, such as flexibility and resistance to moisture, should also be considered.

Leather Belting.—The oak-tanned leather is the best material for belting. It has strength and durability, but has a disadvantage in that it comes to the manufacturer in short lengths and if especial care is not taken in cementing the ends together, it goes to pieces very early. It has been found by experience that as high as 25 per cent more power and greater wear may be obtained from a leather belt by running it with the grain or hair side next to the pulley. That is to say, there is a rough and smooth side to leather belts. The smooth side should be run next to the pulley because this side would crack more readily if placed outward, especially in passing over smooth, small pulleys.

Rubber Belts.—Rubber belting is manufactured by placing several layers of cotton duck and rubber alternately together and vulcanizing the mass into one. The strength of this kind of belt depends entirely upon the quality of the fabric which goes into its make-up. This belting has the advantage of being waterproof and may be made endless and in any length. Endless belts are not always best in a power house where

every machine and pulley is stationary, because the length may change slightly with use. For outdoor work where machines may be moved, it gives excellent service.

Oil of any kind is detrimental to almost every kind of belt, and care should be exercised to keep rubber belts free from it. Rubber belting is resistant to steam and is, therefore, used to a great extent in creameries.

Belt Slipping.—All manner of belt dressings should be avoided because they often contain some material which shortens the life and hardens the surface of a belt. The hardening of a belt finally causes it to crack. Any sticky material put upon a belt will cause a loss in power due to an excess adherence to the pulley. If a large pulley drives a small one, it is best to pull with the lower side which is kept horizontal and allows the upper side to sag. This brings a greater surface of the belt in contact with the pulley.

To twist a belt, as in pulleys to run in opposite directions, often prevents slipping by a greater exposure of the belt to the pulley.

WATER MOTORS

Overshot Wheels.—The overshot wheel receives its power from the weight of water carried by buckets which are fastened to the circumference of the wheel. The water enters the buckets at the top of the wheel and is discharged near the bottom. A wheel of this character is made by placing between two wooden disks a number of buckets or V-shaped troughs. The wheel may be supported upon a wood or steel shaft supported on concrete piers. Motors of this type can be built to operate under falls as low as four feet and may be expected to supply anywhere from 3 to 40 horse power, depending on the head of the fall and the water available.

Undershot Wheels.—The undershot wheel is propelled by water passing beneath it in a horizontal direction, which strikes veins carried by the wheel. Such wheels are often used for irrigation purposes where the fall is too slight for other types of wheels. Most of the undershot wheels have straight, flat projections for veins, but the most efficient wheels are built with curved projections. This form of water motor operates satisfactorily where the water current is rather swift and in places where the volume of water is kept constant. They will not operate in streams that are ever flooded.

Breast Wheels.—Under conditions where little fall may be procured, a breast wheel may be employed to develop power from running water. This type of wheel receives the water near the level of its axis, but in most features it is similar in its action to the overshot wheel. The veins may be straight or slightly curved backward near the circumference.

The wheels mentioned above are very awkward and cumbersome for the amount of power that they are capable of developing. In other words, they are not what is known as efficient; however, they are cheap

in construction and often may utilize water where other types of more efficient wheels cannot be employed.

Impulse Water Motors.—Impulse water motors are provided with buckets around the circumference of the wheel against which a small stream of water under high pressure operates. The Pelton wheel is one of the most efficient of the water motors, but requires for successful operation a head of water considerably higher than is required by most of the other water wheels. This type of wheel may be secured in sizes under one horse power and up to several hundred horse power.

Turbine Wheels.
—The turbine is a water motor which is built up of a number of stationary and moveable curved pipes. It consists of the following parts:

A guiding element which consists of stationary blades the function of which is to deliver the

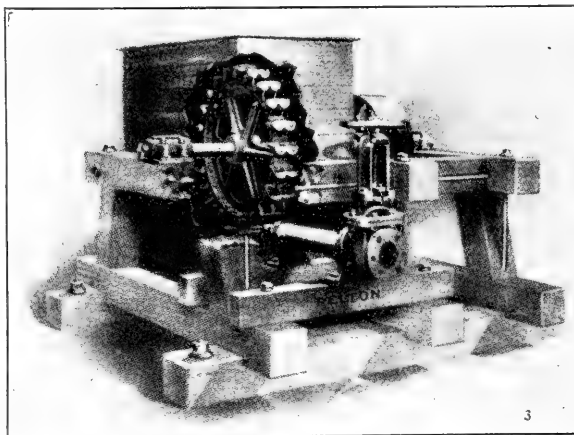

PELTON WATER WHEEL.¹

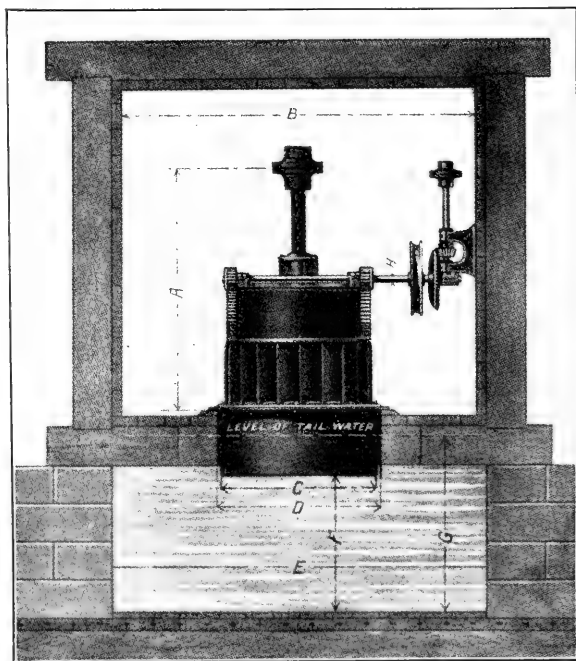

TURBINE WATER WHEEL.²

¹ Courtesy of Pelton Water Wheel Company, New York.

² Courtesy of J. and W. Jolly Company, Holyoke, Mass.



THREE-FURROW TRACTOR IN OPERATION.¹

¹ Courtesy of Advance-Rumely Company, Inc., La Porte, Ind.

water to the rotary part under the proper direction and with the proper speed.

A revolving portion which consists of veins or buckets which are placed in a certain position around the axis of the motor.

The last two mentioned are the most efficient and up-to-date water motors on the market. Power obtained in this method is dependable, inexpensive, safe and sanitary.

The Hydraulic Ram.—This device, although very wasteful of water, is one of the most economical motors for pumping water. It serves both as a motor and a pump. It is not only used for furnishing water for the farm house, barn and dairy, but it is used in many cases for irrigation purposes. Only about one-tenth of the water passing through a ram

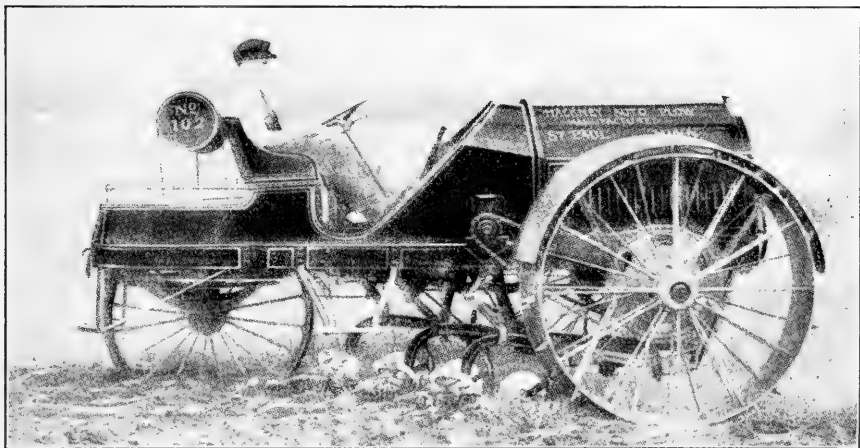

HACKNEY AUTO-PLOW.¹

is finally delivered to the water tank. There is a ram on the market at present which will operate on impure water which may be secured in large quantities and made to pump a pure supply of water. This is commonly known as the double-acting ram.

THE FARM TRACTOR

Farm tractors have been placed upon the market in the past in such large units that they were practical only on extremely large level farms in the Middle West. This type of tractor is being driven from the field by smaller and more compact tractors which are finding a place also on the small farm of 160 acres or less.

The Size of Tractors.—A tractor of less than five tractive and ten-

¹ Courtesy of Hackney Manufacturing Company, St. Paul, Minn.

belt horse power has no place under average farm conditions on the small farm. This size should operate one fourteen-inch or two ten-inch plows. It should operate a small threshing machine and also the small silage cutter for silos not taller than thirty feet. This size tractor may operate a line shaft from which power can be secured for pumping, grinding feed, separating cream, churning, for electric lights and for many other farm operations at one time.

In hilly land where irregular fields are sure to be prevalent and rocky ledges are very likely to occur, the tractor has little place. As plowing is the biggest job in farm operation, the tractor should in this case have

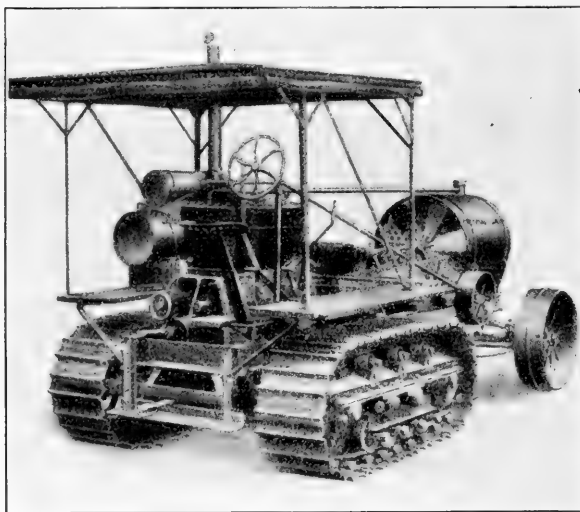

CREEPING GRIP TRACTOR.¹

its greatest usefulness and should replace about one-third of the horses ordinarily employed upon the farm. It generally takes about one-third less horse power to cultivate, harvest and haul to market the crop of any farm than it takes to plow and prepare the seed-bed in a thorough fashion. Under ordinary small farm operations, the writer believes that an 8-16-horse power tractor is the most economical size.

Tractor Efficiency.

—The tractor has been used for agricultural purposes long enough for this fact to become well established; where a tractor of repute is employed, more depends upon the intelligence of the tractioner than upon the ability of the machine to do good work. This does not mean that one has to have a college training in engineering or to be a master mechanic, but one should know the principles upon which a gas engine operates and the intelligent remedy of all diseases to which this mechanism is heir.

Type of Tractor.—It has long been proven that a multi-cylinder engine is the most successful on the road for speed and power and it is becoming recognized by the best tractor manufacturers that more than one cylinder is more dependable and gives more constant power than the one-cylinder type of motor. More cylinders mean more working parts,

¹ Courtesy of The Bullock Tractor Company, Chicago, Ill.

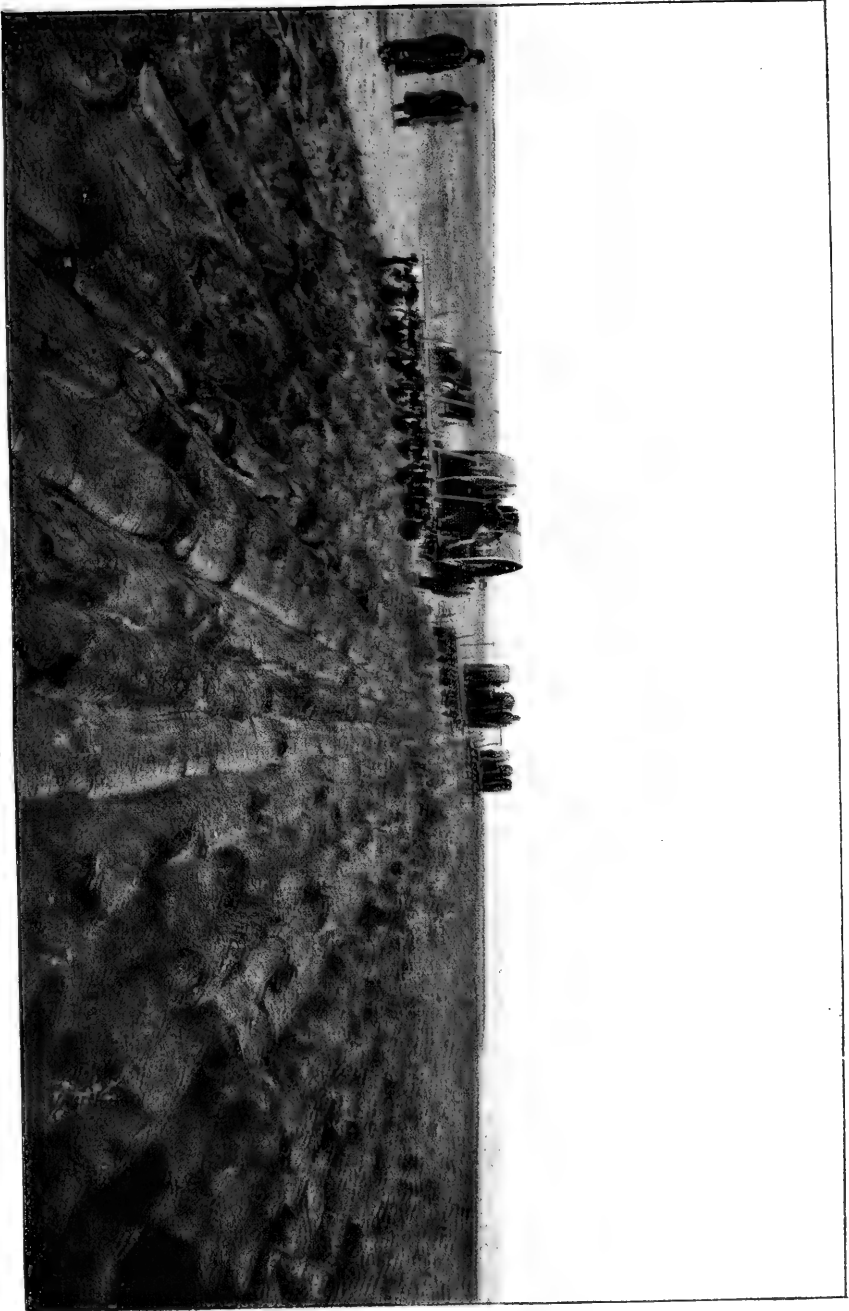

PLOWING ON A LARGE SCALE.

Tower tractors each pulling ten gang plows as used on the great farms of the West. Three such machines under favorable conditions are capable of plowing two hundred acres per day.

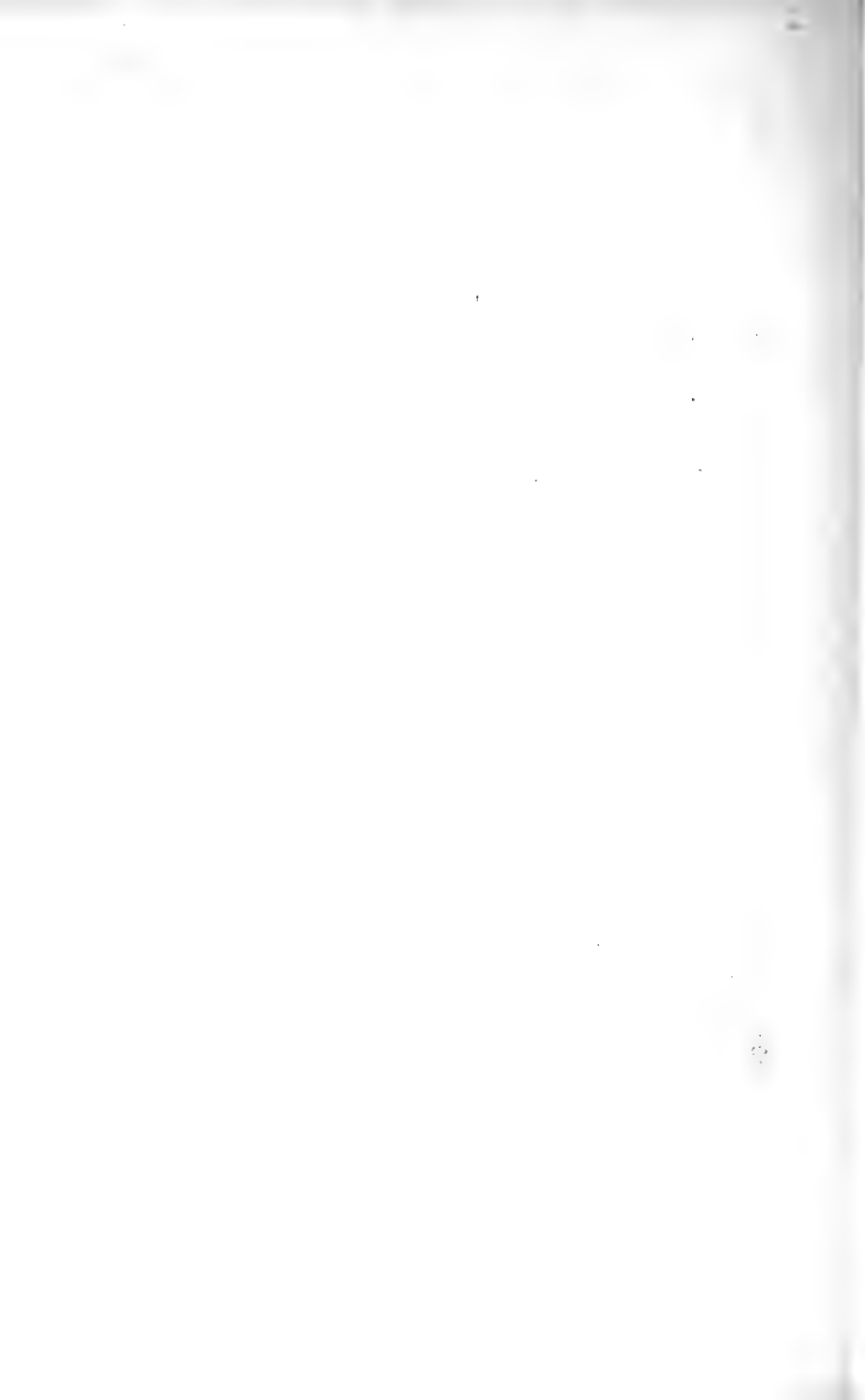

but it also means that a steady pull may be secured, where with one cylinder the power is secured in large quantities at fewer intervals, which is not calculated to give the best efficiency.

The multi-cylinder engine costs more at first, but the efficient service which it will render will more than compensate for its greater initial cost.

REFERENCES

- "Power and the Plow." Ellis and Rumely.
- "Agricultural Engineering." Davidson.
- "Heat Engines." Allen and Bursley.
- "Farm Gas Engines." Hirshfield and Ulbricht.
- "Power." Lucke.
- "Farm Motors." Potter.

CHAPTER 12

FARM SANITATION

BY R. U. BLASINGAME

Professor of Agricultural Engineering, Alabama Polytechnic Institute

Farm sanitation ordinarily includes five distinct branches, namely: lighting, heating, ventilation, water supply and sewage disposal. Following is a brief consideration of each of the above mentioned:

LIGHTING

There are several sources of light for isolated farm homes at the present time. They are as follows:

1. **Kerosene Lamps.**—These are cheap in initial cost. The fuel may be obtained at any cross-roads store. They are quite safe. There are a few disadvantages to such a source of light, namely, the odor they emit, the soot which they produce and the fact that they burn more oxygen than other forms of lighting. Lastly, the light is not a white light.

2. **Gasoline Lamps.**—These may be divided into two groups, the cold process and the hot process. The former system requires a lighter grade of gasoline for the production of light and is more expensive to operate. The cold process

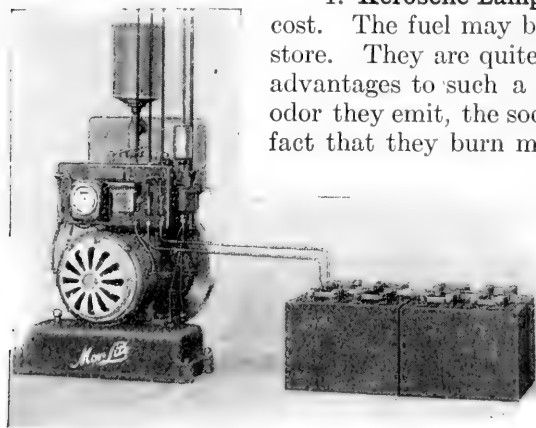

MOR-LITE ELECTRIC PLANT.¹

lamps are much safer than the hot process lamps which may be operated with heavier, cheaper gasoline. While cheaper, the latter are more dangerous than the former.

3. **Acetylene Gas.**—This gas is produced by water and calcium carbide being brought together. The safest system of acetylene lighting may be had by feeding calcium carbide in small quantities to a large quantity of water. The heat produced is conducted away too fast for any danger of explosion. While this system is reasonably safe, there have been many explosions which have cost both life and property. This gas may cause

¹Courtesy of Fairbanks, Morso & Co., Chicago, Ill.

death if inhaled. It has a characteristic odor which any one can easily detect if it is escaping from the system. The light produced from this system is white and considered excellent.

4. **Electrical Lighting.**—The lighting of isolated homes by a private electrical system is generally thought to be an expensive luxury. However, during the past twenty years the cost of living has increased about 20 per cent and the cost of farm labor has increased about 35 per cent, but for the

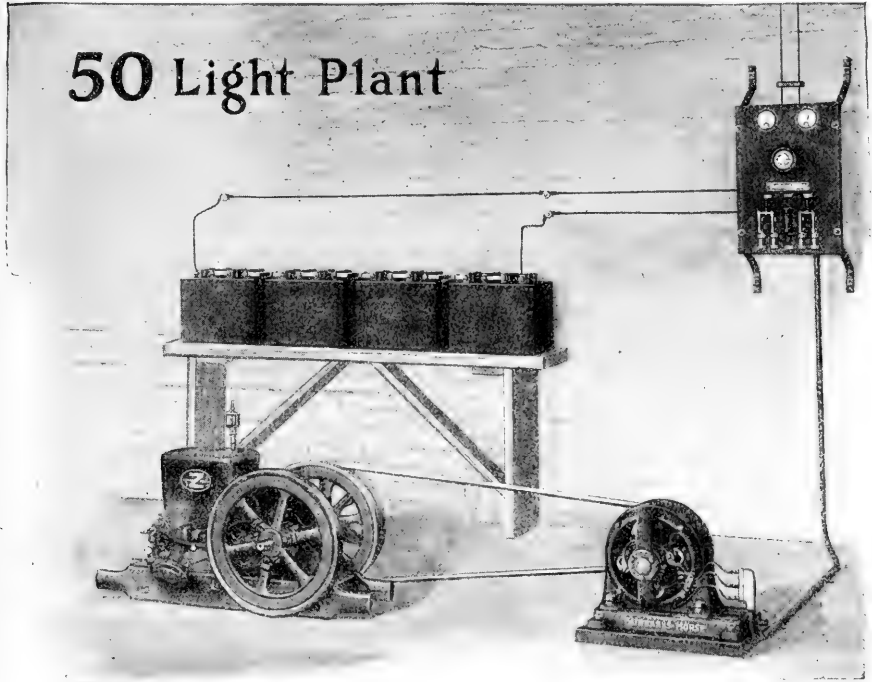

ELECTRIC LIGHTING PLANT FOR FARM HOUSE.¹

same period the cost of lighting by electricity has decreased about 85 per cent. This method of lighting, if correctly installed, is the safest, most sanitary, most convenient and most efficient of all modern lighting systems. There are manufacturing companies who are building very successful private electrical lighting systems for farm homes. These operate on different voltages, namely: 30 volts, 60 volts and 110 volts. If the system is to furnish power for home conveniences such as operating churns, sewing machines, etc., the writer would recommend the 110-volt system. A storage battery will supply about two volts of electrical energy; therefore the 110-volt system would require about 56 cells, whereas, the 30 and 60-

¹ Courtesy of Fairbanks, Morse & Co., Chicago, Ill.

volt systems would operate at a less cost for such equipment. In most cases these systems receive their power from small gasoline engines; however, it is becoming popular in mountainous regions to use small streams to furnish motive power. Where water is used, the storage battery is not necessary, because water forces through the wheel at a steady rate which will in turn produce a steady light. This is not true of a small gasoline engine, although some companies are making very sensitive engine governors and heavy flywheels which are calculated to run very smoothly.

Heating.—There are three distinct heating systems from one central plant, namely: hot air, hot water and steam. These systems are used mostly in extremely cold countries.

1. The hot-air system, if properly installed, gives the best ventilation, and in most cases is the cheapest of the three. In cold, windy weather this system is rather hard to control on account of the leeward side of the house receiving the greater part of the heat.

2. The hot-water heating system is the most expensive to install on account of two systems of piping, one for feed, the other for return. It has been

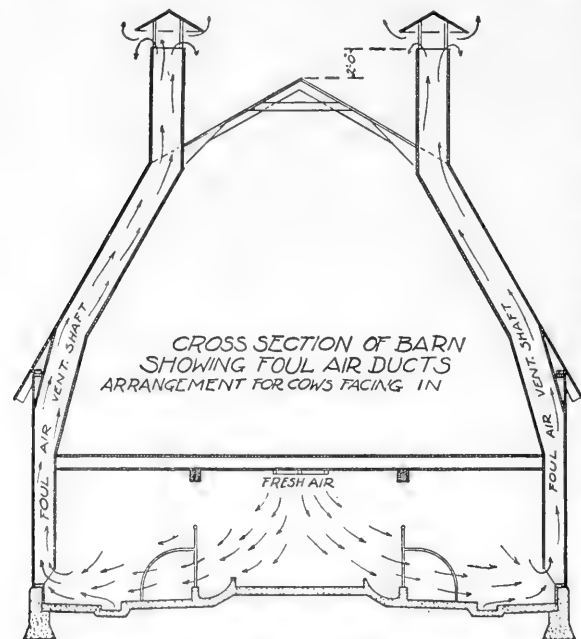

MODIFIED KING SYSTEM OF VENTILATION.¹

found that the Honeywell generator or the Mercury-Seal system causes the hot water to flow more rapidly than without, thus increasing the efficiency of the system.

3. Steam heat is entirely satisfactory. It gives quicker heat, but does not retain its heat as long as the hot-water system.

Ventilation.—There are two influences which cause ventilation, namely: (1) the force of the wind, which causes more or less suction from any opening in a building; (2) the difference in outside and inside temperatures, the warm air inside rising and escaping through any opening, thus causing ventilation. The "King system" is generally used in farm buildings at the present time. It consists in admitting fresh air near the

¹ Courtesy of Loudon Machinery Company, Fairfield, Ia.

ceiling and conducting the foul air from the interior through an opening sometimes located at the highest point of the building.

Dampers should be placed at the intake and the outlet in order that this system may be thoroughly controlled. For horses and cows the area of cross section of outlet flues should not be less than 30 square inches for each animal when the flue is 30 feet high, and 36 square inches for each when only 20 feet high. The cross section of the intakes should aggregate

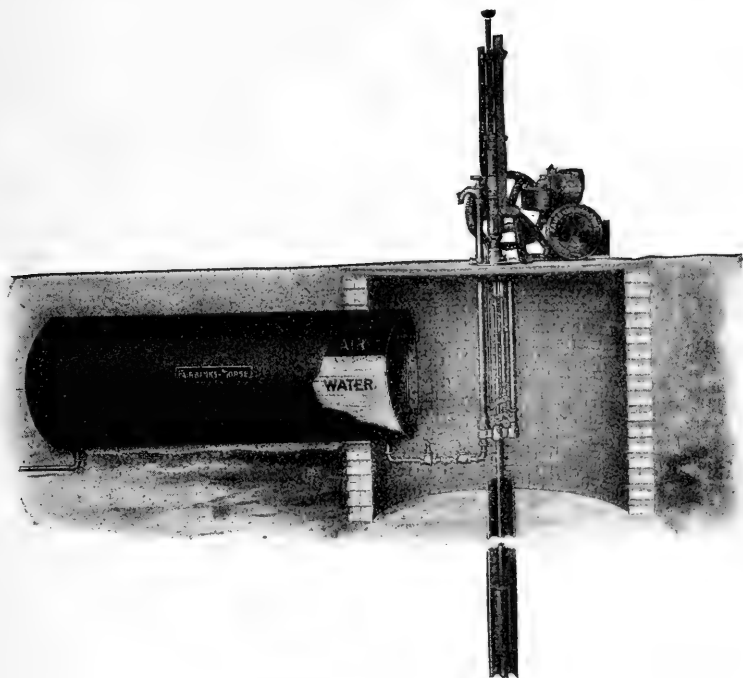

A PNEUMATIC WATER TANK.¹

approximately the same as the outlets. Ventilating flues should be airtight and with as few bends as possible.

There is a system of using double sash windows for dairy barns, in which the top sash is hinged at the bottom so as to permit the entrance of air when the top of the sash is drawn into the barn a few inches. The air entering is deflected upward, thus avoiding a draft of cold air upon the cattle in the barn. This is one of the absolute essentials of a good ventilating system. Deflectors should be placed at the sides of the windows, which will also prevent air from blowing directly upon the stock.

Water Supply.—Water can be supplied to a home under pressure from an elevated tank, also from a pneumatic tank into which water is pumped

¹ Courtesy of Fairbanks, Morse & Company, Chicago.

against a cushion of air. An elevation may be procured by placing the water tank upon a silo, upon a tower or upon a hill. In extremely cold climates water in an elevated tank is likely to freeze, and in hot climates it becomes warm and is not palatable. Where it is not too expensive, a reservoir placed on the side of a hill and well protected supplies water under pressure at an even temperature the year around. Such an elevation is permanent and the pipes are placed beneath the ground so they do not freeze. It is considered, after first cost, the most satisfactory

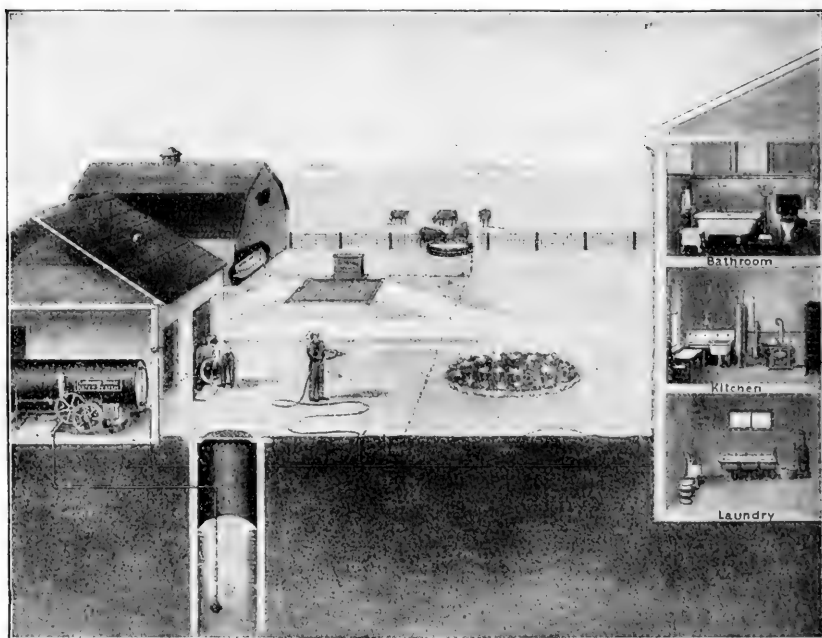

FAIRBANKS-MORSE WATER SYSTEM FOR FARMS AND SUBURBAN HOMES.¹

system of water supply. In recent years the pneumatic tank which may be buried in the ground or placed in the cellar is considered an excellent method for supplying water under pressure to the farmstead.

In installing a system of this kind, one should be sure he is dealing with a responsible company. It is very necessary that the pump supplying the water to this tank should be provided with a small air pump as well. This will supply air as well as water, thus insuring the air cushion at all times. Such a system should be operated under about 50 pounds pressure.

Sewage Disposal.—In some states there are laws which prohibit the discharge of sewage from even a single house into a stream of any size,

¹Courtesy of Fairbanks, Morse & Company, Chicago.

even though the person discharging the sewage may own the land through which the stream flows. Such a law should not require legal machinery for its enforcement, but should appeal to the sense of justice and intelligence of all good citizens.

Vital statistics show that the death rate from typhoid fever in New York State since 1900 has decreased in the cities, while it has remained about constant in rural districts. This reduction in the death rate in the cities may be accredited in large measure to the improved methods of sewage disposal and close attention to pure water supply intended for human consumption.

It is, therefore, desirable to purify sewage before its discharge into any place where it may contaminate food or water intended for human consumption.

The art of sewage treatment when purification is carried on in septic tanks consists in two distinct forms of decomposition.

The first form of decomposition takes place in the absence of oxygen or air, and is called anaerobic, or without air. Under ordinary circumstances it is accompanied with disagreeable odors. The second decomposition process takes place in the presence of air and is called aerobic, or with air. It is accomplished without disagreeable odors.

The first treatment consists in allowing the fresh sewage to enter a water-tight septic tank, and remain for twenty-four or forty-eight hours. During this period, in the absence of air, the organic matter of the sewage is broken down into small particles. The purpose of this treatment is to get the sewage in such a condition that it can be purified. No purification is accomplished during this process. The secondary treatment consists in exposing the effluent from the septic tank to the atmosphere, where

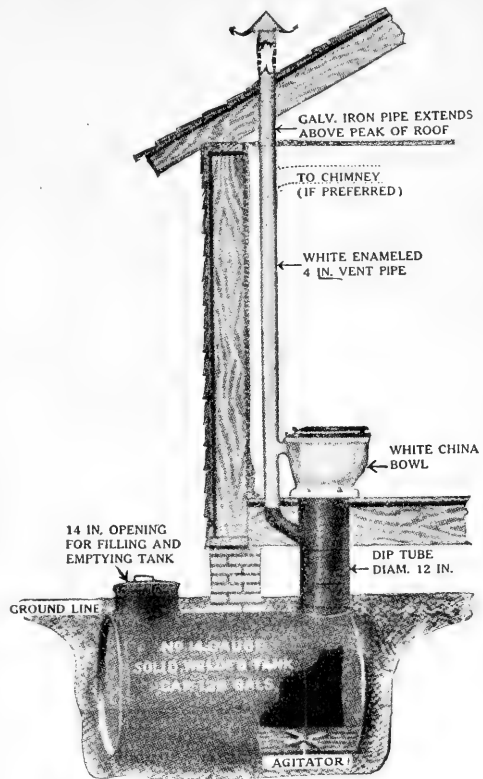

THE KAUSTINE CLOSET.¹

A germless water closet.

¹Courtesy of The Kaustine Company, Inc., Buffalo.

the mass of small particles may be oxidized after the water has been strained from it. This process is accomplished generally in two ways. First, the effluent from the septic tank is flushed upon filter beds which are made by excavating in the ground about two feet deep and filling with sand after placing four-inch drain tile on the bottom. The drain tile should have an outlet from whence the filtered liquid may escape. The air and sunshine decompose the organic matter which is left upon the filter bed. The second method of final disposition of sewage consists in flushing the sewage from the septic tank into a series of drain tile which are placed under ground and have a slope of about 1 inch in 100 feet. In sandy soil about 150 feet of pipe should be allowed for each person living in the home. In clay soil about 400 feet of pipe should be provided for each person. It is necessary to ventilate these lines of pipe at intervals in order that the material left in the pipes after the liquid has escaped into the soil may be oxidized by the air. The size of the tank should be determined by the size of the family, allowing twenty-five gallons of water per day for each person.

By writing the Department of Agriculture at Washington, D. C., one may receive farmers' bulletins which describe and illustrate different systems of sewage disposal. It is often thought and sometimes stated in literature that after sewage has remained in a septic tank for twenty-four hours it may be dumped into a stream without fear of pollution. This is absolutely wrong, for the sewage may contain disease germs which are not affected in the least by the decomposition in the septic tank.

There is a patented sanitary closet which is manufactured by the Kaustine Company, Buffalo, N. Y., which is giving good satisfaction. The principle upon which this method of sewage purification operates is as follows:

The excrement enters a steel tank containing a very strong chemical which is mixed with water. This chemical destroys all bacteria and odor and also disintegrates all solid matter to the point that it may be drained or pumped from the tank and disposed of without fear of contamination. This tank will hold the sewage produced by a family of five during a period of six to eight months. The contents of the tank rates high in fertilizing value.

REFERENCES

- "Electricity for the Farm." Anderson.
"Rural Hygiene." Ogden.
Canadian Dept. of Agriculture Bulletin 78. "Ventilation of Farm Buildings."
U. S. Dept. of Agriculture Bulletin 57. "Water Supply and Sewage Disposal for Country Homes."
U. S. Dept. of Agriculture, Year-Book 1914. "Clean Water on the Farm and How to Get It."
Farmers' Bulletin 463, U. S. Dept. of Agriculture. "Sanitary Privy."

CHAPTER 13

FARM DRAINAGE AND IRRIGATION

Water is the first essential to plant growth, and yet either too much or too little prevents a normal growth of most farm crops. The removal of water from the soil is known as drainage, while the adding of water is called irrigation.

LAND DRAINAGE

The need for drainage and the advantages of it are discussed in Chapter 7. Only the engineering features of it will be discussed here.

Co-operation.—Wherever large tracts of farm land are to be drained, co-operation among the land owners is necessary for the establishment of an economic drainage system. The laws of most states provide for an equitable appraisal of benefits derived by the land owners in a drainage district and make possible the establishment of the district when the majority of land owners ask for it.

The first step in the formation of a district is an accurate survey of the natural water course and an estimate of the size and length of the system of open ditches necessary for the proper drainage of the land. The ditching is generally done by a contractor making a specialty of this kind of work. His services are secured through the ditch commissioners, three or more in number, who are elected by the land owners of the district. Bids are usually let in order to secure competition and get the work done at an equitable price.

The dredged ditches, when completed, usually provide each land owner with an outlet. All subsequent drainage is done by the individual owners, each for his own farm. The individual farm drainage consists chiefly or wholly of tile drains that empty into the open ditches.

The old plow-and-scraper method of making ditches is applicable only when the soil is fairly dry. It will not be described here. Except for very small jobs, it is more expensive than excavating with one of the several forms of large ditching machines.

Of the several types of ditching machines, the floating dredge is the most common and the most successful in level land and for large jobs. It begins at the upper end of the drainage course and works down stream so that the excavation is always well filled with water and easily floats the dredge. This style of dredge is adapted to a large channel, varying from 12 to 60 feet in width. The earth is excavated by large scoops on immense steel arms, operated by steam power. The earth is deposited on either side of the channel and at a distance of 6 to 12 feet from the edge of it. In the

absence of stones, roots or other obstructions, ditches may be excavated at a cost of from 7 to 13 cents per cubic yard. The contract is frequently made on the basis of material removed.

It is essential that such water courses be made as straight and as deep as conditions will permit. The straight course makes the shortest possible ditch and provides for the maximum fall. Good fall and straightness both accelerate the flow of water and make possible adequate drainage with a smaller ditch than would be possible with a longer and more circuitous route.

The ditch embankments, after weathering for a year, may be gradually leveled down and worked back into the adjacent fields by the use of plows and scrapers.

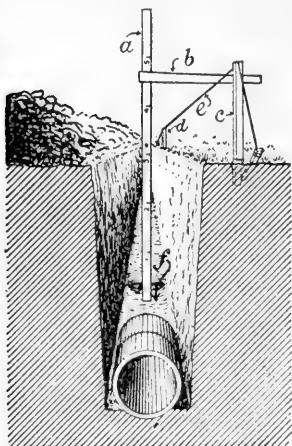

GRADING THE DITCH AND
LAYING TILE.¹

a—Depth gauge. *b*—
Cross piece. *c* and *d*—Stakes
driven in ground to give
proper slope to grading line
e. *f*—Hollow tile drain.

The banks of the ditch need not be as sloping, as formerly thought, although the slope will depend on the character of soil. In heavy, tenacious soils, a slope of $\frac{1}{2}$ to 1 is sufficient, that is 6 inches horizontal to 1 foot vertical. The fall of the ditch may range from 6 inches to 3 feet or more per mile. With 3 feet of fall per mile, the velocity of the water will keep the ditch fairly free from sediment, provided it is not allowed to become filled with growing grass, weeds or willows. If these grow in the ditch during the dry portion of the year, they should be cut and removed annually. Where the fall is too great, the banks of the ditch are apt to erode and cave in. The caved earth will be carried and deposited in lower portions of the stream course and cause trouble. The banks of the ditch should be kept covered with grass to prevent erosion.

Tile Drains.—The first step in tile drainage is an accurate survey of the land to be drained. This will determine the fall and the best position for the main drains. It should also include an estimate of the water shed, that is, the amount of water to be carried away, whether falling on the land to be drained or flowing on to it from adjacent higher lands. The lines of drainage should be as straight as conditions will permit. The mains should be in the lowest portions of the field. Laterals may extend from them into more elevated portions. In case of very level land, this makes provision for the greatest possible fall in the drainage lines.

Running the Levels.—This work may be done by the farmer. In large systems or on very level land, the employment of an engineer is advised. A farm drainage level that is sufficiently accurate may be pur-

¹ Courtesy of U. S. Dept. of Agriculture, Farmers' Bulletin 187.

chased for about \$15. For very small jobs a home-made water level will serve the purpose. This consists of a section of gas pipe about three feet long, with a glass tube attached to each end by means of corks or rubber tubing. The glass tubes should be at right angles to the pipe. When filled with a colored solution and held approximately level, the operator sights across the top of the colored solution as it appears in the two glass tubes.

Establishing the Grades.—The drainage lines are laid out by driving stakes at intervals of 50 to 100 feet, about 18 inches to one side of the center of the ditch. These stakes are driven into the ground until the tops



A LOW-PRICED TILE DITCHER.

are only two or three inches above the ground level. By use of the level, the elevation of each is ascertained. The next step is to calculate the total fall of the line and determine whether the grade is to be uniform or whether it must be changed for a portion of the course. This will depend on the variation in the slope of the surface of the ground. If the slope varies much, two or more grades may be necessary in order that the drainage pipe may be placed at the desired depth beneath the surface of the ground. A single grade may result in the tile being too deep over a portion of the course, thus necessitating expensive excavating, or it may be too shallow to provide effective drainage. These difficulties are avoided by suitable changes in the grade.

Grade stakes projecting about 18 inches above the surface of the ground are set one beside each of the stakes designating the level. These

are driven so that the tops are a uniform distance above the bottom of the ditch as it is to be excavated. This may be $4\frac{1}{2}$ feet or any convenient height. A cord or wire is next stretched tightly over the top of the grade stakes. By means of a gauge, the ditcher can control the depth of the ditch. Care should be exercised not to get it too deep, or to make the bottom wider than necessary.

The sketch on a preceding page shows the method of gauging the depth, the character of excavation and the position of the tile.

Small Ditching Machines.—These may be used to facilitate the work



THE DITCHER IN OPERATION.

Can be operated by one man and six horses. It will excavate 100 rods of dirt to a depth of 3 feet daily.

of excavation. They do it more rapidly than can be done by hand and at less cost. They are adapted only to fairly long courses. It will generally be necessary to grade the bottom of the ditch by hand.

Size of Tile.—In any system the major portion of the tiles will be three inches in diameter. All lines not exceeding 500 feet in length and having no branches entering may be of this size. When such lines exceed 500 feet the lower portion should be 4-inch tile. The capacity of pipes is in proportion to the square of their respective diameters, plus something for the relatively lesser amount of friction in the large diameters. In practice, one 4-inch line will accommodate two 3-inch lines. One 8-inch line will accommodate five 4-inch lines, etc.

The removal of one-quarter inch of rainfall in 24 hours will generally provide adequate drainage. On this basis the area in acres drained by given sizes of tile and grades are as follows:

Diameter of Drain.	Grade 1 Inch to 100 Feet.	Grade 3 Inches to 100 Feet.
5.....	19.1	25.1
6.....	29.9	39.6
7.....	44.1	58.9
8.....	61.4	80.9
9.....	82.2	108.4
10.....	106.2	140.6
12.....	167.7	221.1
16.....	341.4	449.9

To double the fall for steeper grades than those given in the above table will increase the carrying capacity of the tile one-quarter to one-third.

IRRIGATION

Water, wisely used, has converted many desert acres into fruitful fields and orchards. This has made possible thriving settlements in many parts of the arid West, and encouraged the development of industries other than agriculture, especially the mining of useful metals.

Water Rights.—In regions of limited water supply, laws for the control of water become essential. These laws should be understood and obeyed by all users of water. It is a principle that rather definite shares in the water supply of a region shall be apportioned to specific areas of land. When the water supply is insufficient for all available land, priority of appropriation receives first consideration. A new settler is prohibited by law from sharing in the water supply at the expense of early settlers. In many irrigation districts, the extravagant use of water has prevailed. A more economical use on the part of the older settlers would produce equally as good crops. In fact, the extravagant use of water is more often injurious than otherwise.

Co-operation.—This is a necessary feature in most irrigation districts, because the water supply must serve the entire community, and in order to do so most advantageously, co-operative action is called for in its use and conservation. Co-operation means that the farmers on an irrigation ditch must take turns in using the water. The larger the volume of water the shorter the time each may use it and the greater number of farmers can be supplied. The apportionment of the water should correspond to the acreage of crops to be irrigated by each farmer. This rotation of the allotment of water to the farmers on a ditch is advantageous from two standpoints. First, it gives each farmer sufficient water to cover his land in a very short time, thus economizing on the time spent

in irrigating. Second, it overcomes the loss of water by seepage and evaporation which takes place when he has a constant small stream.

Sources of Water.—The chief sources of irrigation water are perennial streams, springs and wells. The first named is by far the most important. The first consideration in the development of an irrigation supply from a stream is the volume of water carried at all times during the year; and second, whether or not the water can be brought to the land to be irrigated at a reasonable expense. This will depend principally upon the length of ditch to be constructed and the character of land that must be traversed by it. In some cases, pipe lines may take the place of ditches without great additional expense and with much less waste of water.

The larger the ditch and the more porous the soil through which it passes, the smaller should be the fall. If, however, the grade is too small, the ditch must be larger in order to carry the supply of water. In ordinary soils, a grade of one foot in 600 feet may be given. In clay soils, it may be increased to two feet in 600 feet. A slow movement of water in the ditch prevents scouring and encourages the settlement of fine sediment. This ultimately forms an impervious lining and prevents seepage.

Springs offer an excellent irrigation water supply, and although the volume is much less than that from perennial streams, it is subject to less fluctuation in volume and is consequently more dependable.

Wells form a considerable source of irrigation water supply in many of the irrigation districts. They are virtually artificial springs secured by boring deep wells provided with iron casings. In some instances, as in case of wells that do not flow, and in elevating water from lakes and streams to land lying above the water level, pumping is resorted to.

Dams and Reservoirs.—Perennial streams are subject to great fluctuation, due to periodic rains and melting snow. Their direct diversion for irrigation purposes, therefore, fails to utilize much of the water during high stages. This has led to methods of storing the water to be used as needed, thus increasing the area irrigated. While dams are necessary for diverting water from streams into canals, much larger and more expensive ones are required in the building of reservoirs. It is important to select the dam site with a view of securing the largest possible water storage capacity with the minimum expenditure for construction. Such sites are most usually found in the upper courses of a stream where it passes through a narrows or canyon. Rocky, impervious abutments to which to connect the dam are essential. On large projects the reinforced masonry or concrete dam that will be permanent is advised. The deeper the water in a storage reservoir the less will be the relative loss by evaporation.

Methods of Transmission.—The census of 1910 gave an aggregate of over 125,000 miles of irrigated ditches in the United States. At that

time, less than four per cent of this mileage was *lined* or otherwise made impervious to water. A limited amount of irrigation water is conveyed through pipe lines of different types, of which wood, terra-cotta and cement predominate. It is important to construct the irrigation ditch of the proper size to convey the maximum amount of water that will be available or the maximum that can be used by those who irrigate. In this connection it is advised to secure the services of an engineer. It should be understood that the amount of water conveyed depends on the cross section of the canal and the rate of movement of the water. In a small ditch capable of carrying 50 miner's inches, a fall of 2 inches to the rod will give a velocity of 2 feet per second. In a ditch carrying 20 times as much water, a fall of $\frac{1}{4}$ inch to a rod will give an equal velocity. Except in hard clay or a mixture of gravel and clay, a velocity greater than 3 feet per second is likely to cause serious erosion. A velocity of 2 to $2\frac{1}{2}$ feet is the maximum that should be permitted for ordinary sandy loams or loams. Where the fall of the land is such as to cause a greater velocity of the water, checks in the canals should be provided. These may be wooden dams or obstructions of cobblestones, causing a drop in the water.

In lined canals erosion is overcome and the velocity of the water may be much greater. Where there is ample fall, such a canal may be much smaller than an ordinary earth canal. The transmission of water through pipes has a still greater advantage in this respect and may be conducted down very steep grades.

Losses in Transmission.—Much water diverted from streams for irrigation is lost from the ditches by seepage and evaporation, and is still further wasted by over-irrigation and by allowing the water to penetrate the soil beyond the reach of crops. Water lost in these ways often causes serious damage to the lower lying land in the irrigation district. Numerous water measurements and experiments have led to a conservative estimate that not more than 35 per cent of the water diverted from streams is effective in plant production.

The efficiency of irrigation water can be greatly increased by the substitution of pipe lines for open ditches and by greater care in the distribution of water in the fields.

Head Gates.—Head gates are necessary at the point of diversion from a stream into the main irrigation canal, and also at points along the main canal at the juncture of laterals. Such gates are usually constructed of plank with a gate that slides up and down to control the volume of water. A simple form is shown in the accompanying illustration.

Preparing Land for Irrigation.—The preparation of the land consists in clearing it of the native vegetation, which in the arid region is usually sage-brush, rabbit-bush, cacti and native grasses. Plowing frequently precedes the clearing operation. This makes easy the gathering and burning of the vegetation. The plowing and clearing should be followed by a thorough harrowing, grading and smoothing of the surface. The

supply ditch should be above the highest portion of the land to be irrigated. After the field is cleaned and leveled, farm ditches should be

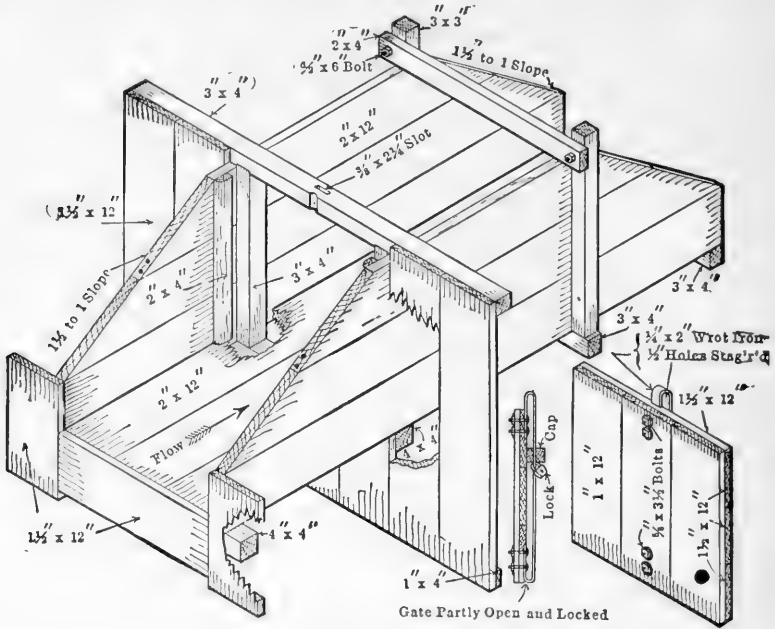

DELIVERY GATE TO FARM LATERAL.¹

conducted over the higher portions of it. From these ditches the water may be conducted to all portions of the land. As far as possible these ditches should extend along the borders of the fields in order to avoid

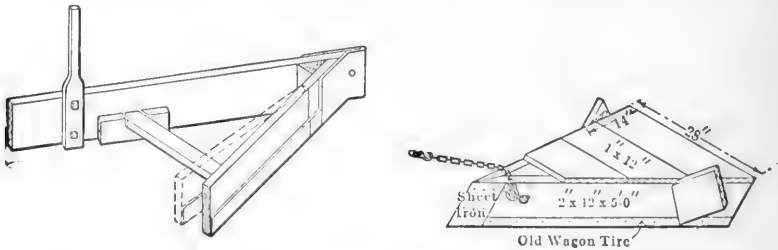

THE V-CROWDER IS EXCELLENT FOR MAKING THE FARM DITCHES.¹

obstructions to cultivation. When necessary to cross fields with open ditches, they should be so placed as to avoid as far as possible irregularity in shape of fields.

¹ Courtesy of The McGraw-Hill Book Company, N. Y. From "Use of Water in Irrigation," by Fortier.

Farm Ditches.—The size of the farm ditches will be determined by the acreage of land irrigated by each, the fall in the ditches and the amount of water that must be cared for in a unit of time. On uneven land it is necessary to bridge over the depressions with levees or flumes. The levee is usually the cheaper, but should be allowed to settle. It will be subject to wash-outs during the first few years.

Wooden flumes are more satisfactory, but wood soon decays when used for this purpose. Metal or concrete pipes cost most, but are durable and generally cheapest in the end. The method of constructing the farm ditches depends on their size. Most of the work on them may be done with the plow and the V-crowder. The crowder makes a ditch with a triangular bottom. This bottom becomes rounded by usage. It is important that the ditch be made in the proper place at the outset. The older the ditch, the more impervious its banks and bottom become and the more satisfaction it gives. Leaky ditches may be greatly improved by puddling the earth of the sides and bottom. This may be done by drawing off the water and driving a flock of sheep the length of the ditch while it is muddy. Dragging the bottom with a brush harrow may be resorted to for the same purpose.



CANVAS DAM TO CHECK WATER.¹

On well-established ditches the chief items of maintenance are the removal of silt, weeds and aquatic plants that may grow in them.

Distributaries.—These consist of small wooden, metal or rubber tubes, imbedded in the bank of the ditch so that the water will pass through the embankment and be uniformly distributed on the adjacent land. These need not be permanent, but may be imbedded temporarily, and moved from field to field as needed. Square boxes, made of lath cut in half, are cheap, light and serve the purpose as well as more expensive metal tubes. Being square and rough, they stay in the embankment better than the smoother metal or rubber tubes.

Small syphons of rubber hose are also used. These obviate the necessity of disturbing the ditch bank. The chief objection to these is the starting of the flow of water.

Distributing the Water.—The method of distribution will depend on the slope of the land, the character of the soil and the kind of crop. Level land is easily irrigated by flooding the whole surface. This method

¹ Courtesy of The Macmillan Company, N. Y. From "Principles of Irrigation Practice," by Widtsoe.

is applicable to the irrigation of alfalfa, grass and small grains. The surface, however, should be divided into areas that may be covered in a comparatively short time with the water available. When one area has received sufficient water, the flow is then directed to the next one, and so on until the irrigation is completed. If the field to be irrigated is large, it necessitates a network of ditches or parallel ditches at intervals of 300 to 400 feet, extending across the field. The distance to which the water may travel over the surface of the ground depends on the character of soil and the ease of penetration. The more porous the soil, the shorter the intervals should be. If the intervals are too long, the soil

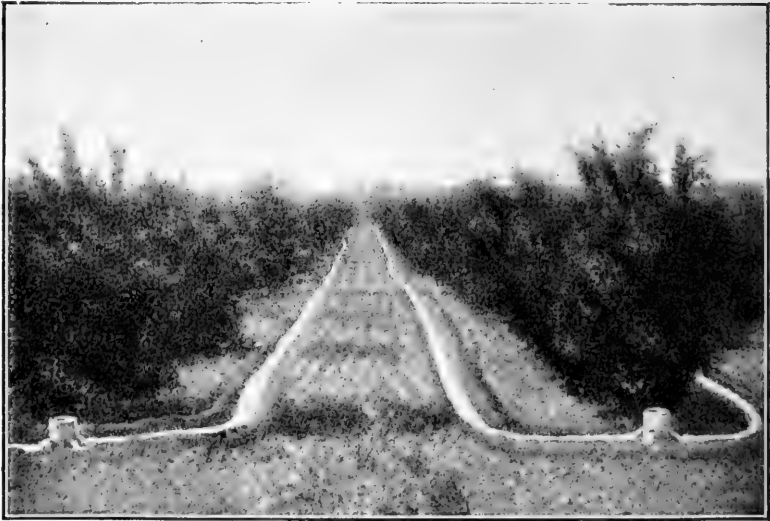

ORCHARD IRRIGATION BY FURROW METHOD.¹

nearest the ditch becomes over-irrigated before the water reaches the further portions.

With this method of irrigation the water is generally made to flow over the embankment by use of a temporary dam. The most convenient form consists of a strong piece of canvas four or five feet square with one edge securely nailed to a tough but light piece of wood that will reach from bank to bank of the ditch. When this is laid in the ditch with the canvas upstream and a few shovels of dirt thrown on its edges, it completely dams the water. It is easily moved from place to place as needed.

All crops planted in rows, such as vegetables, sugar beets, potatoes and fruit, are generally irrigated by the furrow method. Where the rows are close together, the furrows alternate with the rows, being midway

¹ Courtesy of The McGraw-Hill Book Company, N.Y. From "Use of Water in Irrigation," by Fortier.

between them. If they are further apart, as in orchards, two or more furrows for each row of plants are desirable. The length of furrows will depend on the character of soil. If very porous, they should not be more than 300 feet long. In heavy soils, the length may be as much as 600 feet. In this type of irrigation the rows extend at right angles to the ditches, and the water is most conveniently taken from the ditch by distributors previously described. It is usually desirable to turn the water into as many as 50 furrows at one time.

The Check System.—It consists of dividing the field into a number of small compartments, surrounded by low levees. The water is turned in these to the desired depth. This gives a rather complete control of



CELERY UNDER IRRIGATION, SKINNER SYSTEM.¹

the amount of water applied to each unit of ground. The size of the checks depends on the slope of the land, small checks being necessary where the slope is severe. This method is adapted to orchard irrigation.

Where water is conveyed through pipes and there is sufficient water-head for pipe pressure, spraying irrigation may be resorted to. The Skinner system is probably the most successful of the several spray methods. It consists of a series of pipes at intervals of about forty feet, extending across the field to be irrigated. These are connected with a water main which is closed by a valve when not in use. The lines of pipe are supported at a height of about seven feet on posts, in such a way that the pipes may be turned. The pipes are fitted with small nozzles at intervals of about three feet. These should be in straight lines. The water issuing from them under high pressure is thrown a considerable

¹ Courtesy of The Pennsylvania Farmer.]

distance in a fine spray. By turning the pipe, the water is directed to either side of the pipe line at the desired angle.

With the pipes parallel and the supporting posts in line at right angles to them, cultivation may take place in either direction beneath the pipes. While this system is rather expensive to install, it is well adapted to small areas intensively farmed, to truck crops and small fruits. Such systems are common along the Atlantic Seaboard and in some parts of the South.

Duty of Water.—This pertains to the area of land that may be irrigated with a unit of water, such as a "second foot" or a "miner's inch." The wasteful methods of irrigating and lack of knowledge on the part of the farmer result in a low duty. Under favorable conditions the duty should be about 200 acres for each "second foot." It would seem wise that the duty of water should be fixed within reasonable limits by some competent authority for a particular state or irrigation district. Local conditions, such as rainfall, length of growing season and the intensity of agriculture, should be taken into consideration in fixing the duty of water.

When to Irrigate.—How often to irrigate and how much water to apply will depend on local conditions, such as character of soil, kind of crop and weather conditions. Economy in water as well as the labor of irrigating, should make the intervals as long as feasible. Water should be applied until the soil is wet to the full depth to which the roots of the crop in question penetrate. The deeper the soil is wet, the longer may be the interval between irrigations. Lighter and more frequent irrigations penetrate the soil to less depth, increase the labor and result in greater loss of water by direct evaporation. Water should be applied when the crops need it and irrigation cease when the need is fully met. Enough water is better than too much.

Where there is a bountiful winter supply of water and a scant supply during the summer, winter irrigation is recommended. It stores the soil with water and lessens the need during the summer.

Water should be applied to crops abundantly when they are growing most rapidly. Irrigation may be withheld as they approach maturity.

Irrigation Waters.—Irrigation water sometimes becomes so heavily charged with salts that it proves harmful to tender plants. This condition arises either from concentration through evaporation in shallow reservoirs or from passing through alkali soil. Along stream courses, the reckless use of water gives rise to much seepage which returns to the stream lower down. This frequently becomes so plentiful that it forms a supply for another irrigation district further down the stream course. Such water is frequently unsuited for irrigation purposes.

Alkali Troubles.—The rise of alkali is generally caused by over-irrigation. An excess of water causes the ground water table to rise until the gravitational water can reach the surface by capillary attraction. This causes excessive evaporation at the surface of the soil and results

in the accumulation of alkali salts. In time, the concentration will prevent the growth of crops. This can usually be avoided by greater care in irrigating. Where conditions are such that it cannot be avoided in this way, under-drainage should be installed. The alkali may now be washed out of the soil through the underdrains, by flooding the surface with fresh water. The use of alkali waters also stocks the soil with alkali salts. The use of such water should be avoided as far as possible, or the difficulty overcome by drainage and flooding as above mentioned.

REFERENCES

“Practical Farm Drainage.” Elliott.
 “Principles of Irrigation Practice.” Wiltsoe.
 “Irrigation and Drainage.” King.
 “Irrigation Institutions.” Mead.
 “Practical Irrigation.” Bowie.
 “Irrigation.” Newell.
 “American Irrigation Farming.” Olin.
 Utah Expt. Station Bulletins:
 115. “The Movement of Water in Irrigation.”
 118. “Method of Increasing Crop Producing Power of Water.”
 U. S. Dept. of Agriculture, O. E. S. Bulletins:
 177. “Evaporation Losses in Irrigation and Water Requirements of Crops.”
 248. “Evaporation from Irrigation Soils.”
 Farmers’ Bulletins, U. S. Dept. of Agriculture:
 373. “Irrigation of Alfalfa.”
 371. “Drainage of Irrigated Lands.”
 392. “Irrigation of Sugar Beets.”
 394. “Use of Windmills in Irrigation.”
 399. “Irrigation of Grain.”
 404. “Irrigation of Orchards.”
 524. “Drainage on the Farm.”
 673. “Irrigation Practice in Rice Growing.”
 698. “Trenching Machinery Used for the Construction of Trenches for the Drains.”

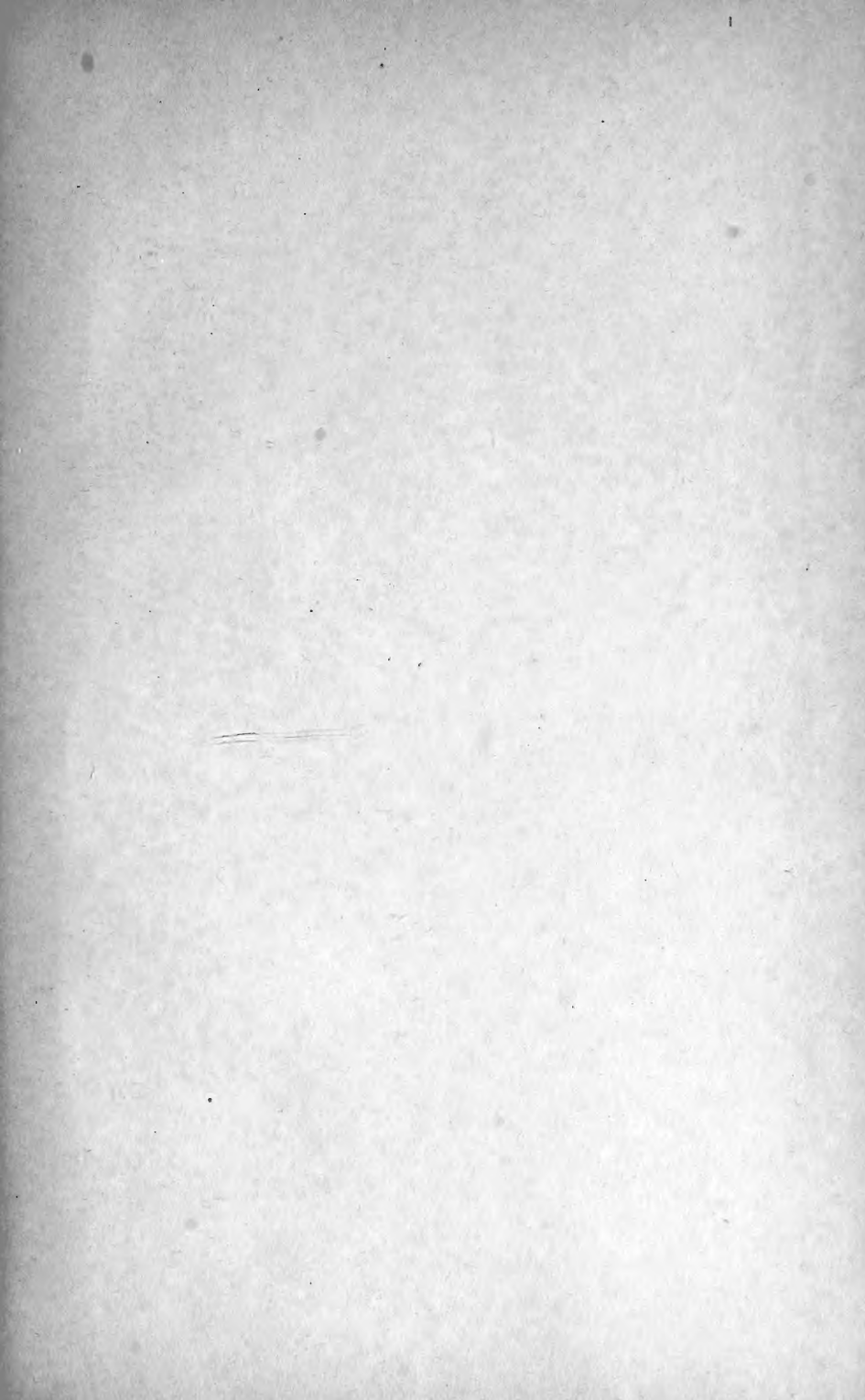





LIBRARY OF CONGRESS



0002683093A