

# SPALDING 1917

L.D. SLADE  
ONE OF THE BEST

COPYRIGHT 1917 BY

A. G. SPALDING & BROS.





# A.C. SPALDING & BROS.

MAINTAIN THEIR OWN HOUSES  
FOR DISTRIBUTING THE

## SPALDING COMPLETE LINE OF ATHLETIC GOODS IN THE FOLLOWING CITIES.

<p><b>NEW YORK</b> Dealers— 124-128 Nassau St. Clydes—523 Fifth Avenue</p> <p><b>NEWARK, N. J.</b> 689 Broad Street</p> <p><b>PHILADELPHIA, PA.</b> 1210 Chestnut Street</p> <p><b>BOSTON, MASS.</b> 74 Summer Street</p>	<p><b>CHICAGO</b> 28-30 So. Wabash Ave.</p> <p><b>INDIANAPOLIS, IND.</b> 130 N. Pennsylvania St.</p> <p><b>CINCINNATI, O.</b> 119 East Fifth Avenue</p> <p><b>CLEVELAND, O.</b> 741 Euclid Avenue</p> <p><b>COLUMBUS, O.</b> 107 South High Street</p>	<p><b>SAN FRANCISCO</b> 156-158 Geary Street</p> <p><b>OAKLAND, CAL.</b> 415 Fourteenth St.</p> <p><b>SEATTLE, WASH.</b> 1204 Second Avenue</p> <p><b>LOS ANGELES, CAL.</b> 435 South Spring St.</p> <p><b>PORTLAND, ORE.</b> Broadway at Alder</p> <p><b>SALT LAKE CITY, UTAH</b> 27 E. 2nd South St.</p>
---	--	--

<p><b>PITTSBURGH, PA.</b> 008 Wood Street</p> <p><b>BUFFALO, N. Y.</b> 611 Main Street</p> <p><b>SYRACUSE, N. Y.</b> 357 So. Warren Street</p>	<p><b>DETROIT, MICH.</b> 121 Woodward Ave.</p> <p><b>WASHINGTON, D. C.</b> 613 14th Street, N.W.</p> <p><b>LOUISVILLE, KY.</b> 328 West Jefferson St.</p>	<p><b>ST. LOUIS, MO.</b> 415 North Seventh St.</p> <p><b>KANSAS CITY, MO.</b> 1120 Grand Avenue</p> <p><b>MILWAUKEE, WIS.</b> 279 East Water Street</p>
--	---	---

<p><b>ROCHESTER, N. Y.</b> 40 Clinton Ave., North</p> <p><b>ALBANY, N. Y.</b> 52 State Street</p> <p><b>BALTIMORE, MD.</b> 110 E. Baltimore St.</p>	<p><b>ATLANTA, GA.</b> 74 N. Broad Street</p> <p><b>NEW ORLEANS, LA.</b> 140 Carondelet Street</p> <p><b>DALLAS, TEX.</b> 1503 Commerce Street</p>	<p><b>DENVER, COL.</b> 622 Sixteenth Street</p> <p><b>MINNEAPOLIS, MINN.</b> 52 Seventh St., South</p> <p><b>ST. PAUL, MINN.</b> 388 Minnesota Street</p>
---	--	---

<p><b>LONDON, ENGLAND</b> 317-318, High Holborn, W. C. 78, Chesapeake, E. C. West End Branch 29, Haymarket, S.W.</p> <p><b>LIVERPOOL</b> 72, Lord Street</p> <p><b>BIRMINGHAM, ENG.</b> New Street House</p>	<p><b>MANCHESTER, ENG.</b> 4, Oxford St. and 1, Lower Mosley St.</p> <p><b>BRISTOL, ENG.</b> 42, High Street</p> <p><b>EDINBURGH, SCOT.</b> 3 So. Charlotte St., (Cor. Princess St.)</p> <p><b>GLASGOW, SCOTLAND</b> 68 Buchanan Street</p>	<p><b>MONTREAL, CANADA</b> 369-71 St. Catherine St., W.</p> <p><b>TORONTO, CANADA</b> 207 Yonge Street</p> <p><b>SYDNEY, AUSTRALIA</b> 204 Clarence Street</p> <p><b>PARIS, FRANCE</b> 35 Boulevard des Capucines 27 Rue Tronchet</p>
--	---	---

Communications directed to A. C. SPALDING & BROS., at any of the above addresses, will receive prompt attention.

# THE SPALDING

TRADE MARK QUALITY AND SELLING POLICY CONSTITUTE  
THE SOLID FOUNDATION OF THE SPALDING BUSINESS

Digitized by the Internet Archive  
in 2010 with funding from  
Lyrasis Members and Sloan Foundation

The  
Winterthur  
Library

## IMPORTANT ANNOUNCEMENT

THE PRICES IN THIS CATALOGUE ARE BASED ON PRESENT COSTS, TO WHICH WILL BE ADDED GOVERNMENT WAR TAX SHOULD SAME BE LEVIED ON CERTAIN ITEMS, WITH THE POSSIBILITY ALSO OF FURTHER ADVANCES DUE TO INCREASING COST OF MATERIALS. ALL PRICES SUBJECT TO CHANGE WITHOUT NOTICE.

AUGUST 5, 1917

*A. G. Spalding & Bros.*

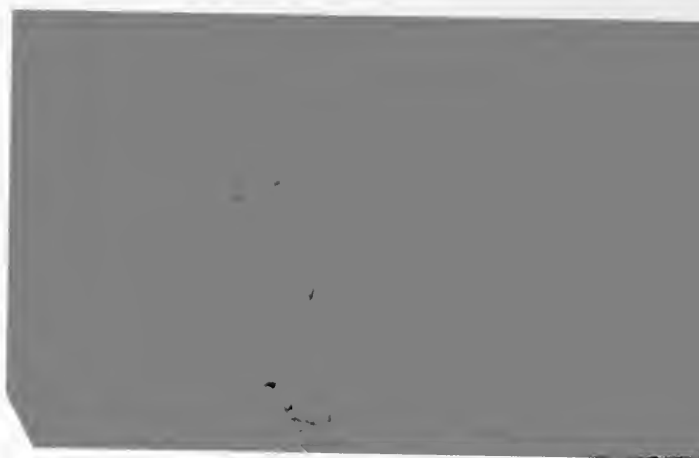

# SPALDING FALL CATALOGUE, 1917

THE SPALDING TRADE-MARK IS REGISTERED IN THE UNITED STATES PATENT OFFICE, AND WE HAVE ALSO PROTECTED OUR INTERESTS BY THIRTY-NINE REGISTRATIONS IN FOREIGN COUNTRIES. INFRINGERS ARE WARNED

## THE SPALDING POLICY



## THE SPALDING GUARANTEE

DIRECT FROM FACTORY TO CONSUMER THROUGH  
THE MEDIUM OF THE RETAIL DEALER

SPALDING ATHLETIC GOODS are on sale in stores located in practically every town of any size in the United States, and at our various stores. (See inside front cover). We prefer that consumers patronize their local dealers, but we will furnish our goods direct to consumers where they cannot be obtained or will not be furnished by the local dealer under the conditions named below.

PRICES ON SPALDING TRADE-MARKED GOODS are based entirely upon the cost of manufacture, with a reasonable manufacturer's profit, and a reasonable profit to the retail dealer added. Sales are made at catalogue prices, except that for special orders by express or distant points, the retail dealer is justified in asking a reasonable amount in excess of our catalogue prices to cover express and other charges.

WE GUARANTEE TO EACH PURCHASER of an article bearing the SPALDING TRADE-MARK that such article will give satisfaction and a reasonable amount of service when used for the purpose for which it was intended and under ordinary conditions and fair treatment.

WE AGREE to repair or replace, free of charge, any such article which proves defective in material or workmanship where subjected to fair treatment: PROVIDED, such defective article is returned to us, transportation prepaid, within thirty days after purchase (except where otherwise stipulated on special guarantee tag attached to certain articles) and accompanied by a letter from the user giving his name and address, and explaining the claim.

THIS IS THE SPALDING CATALOGUE OF EQUIPMENT FOR FALL ATHLETIC SPORTS—FOOT BALL, BASKET BALL, VOLLEY BALL, TRACK AND FIELD ATHLETICS, LACROSSE, FIELD HOCKEY, INDOOR BASE BALL, ETC. COMPLETE INDEX WILL BE FOUND ON NEXT PAGE, ALSO LIST OF ALL SPALDING CATALOGUES, COPIES OF WHICH MAY BE HAD FREE UPON REQUEST TO ANY A. G. SPALDING & BROS. STORE—SEE ADDRESSES ON INSIDE COVER PAGE OPPOSITE.

THE CONTENTS OF THIS CATALOGUE ARE PROTECTED BY COPYRIGHT, AND CUTS, ETC., MUST NOT BE USED WITHOUT PERMISSION OF A. G. SPALDING & BROS.

COPYRIGHT, 1917, BY A. G. SPALDING & BROS.

## TO OUR CONSUMER FRIENDS

May we ask your consideration of the dealers who handle Spalding Athletic Goods? They are the cream of the business—the most reliable and progressive, the fairest minded and most upright. When you see the Spalding Trade Mark displayed by a dealer, you may feel perfectly confident that in dealing with him you are going to be satisfied, because in taking up the sale of the Spalding line he, at the same time, subscribes to the doctrine of positive satisfaction to the customer—the keynote of the whole Spalding selling policy.

Favor the Spalding dealer because when you purchase athletic goods you expect to use them for more than a moment and as you take up athletics for your pleasure and physical benefit, you want to assure yourself the equipment you use is right in every particular that makes for good service and the correct athletic need. The Spalding dealer will give you good advice about your athletic outfit; he will help you out when you need something special, and best of all, he will see that you get the best athletic equipment made, and at fair prices.

# SPALDING FALL 1917 CATALOGUE

## INDEX

	PAGE	Exercisers—	PAGE		PAGE	Shirts—	PAGE
Ankle Supporter . . . . .	13	Elastic . . . . .	61	Lanes for Sprints . . . . .	36	Athletic . . . . .	26
Athletic Library . . . . .	62-64	Home . . . . .	61	Leg Guards—		Shoes—	
Attach'ts, Chest Weight, 46				Field Hockey . . . . .	40	Army . . . . .	32
Aviation Outfits . . . . .	58			Foot Ball . . . . .	9	Basket Ball . . . . .	30
				Leotards . . . . .	27	Fencing . . . . .	44
<b>Bags—</b>		Felt Letters . . . . .	10, 28	Letters—		Foot Ball, College 12, 13	
Striking . . . . .	54-56	Fencing Sticks . . . . .	44	Embroidered . . . . .	28	Foot Ball, Soccer. . . . .	21
<b>Balls—</b>		Field Hockey . . . . .	40	Felt. . . . .	10, 28	Gymnasium . . . . .	30
Basket . . . . .	22, 23	Flags—		Linesman's Measuring		Jumping . . . . .	38, 39
Field Hockey . . . . .	40	College . . . . .	29	Outfit . . . . .	11	Running . . . . .	38, 39
Foot, College . . . . .	3, 4	Foils, Fencing . . . . .	44			Street . . . . .	32
Foot, Soccer . . . . .	20, 21	Foot Balls—				Tramping . . . . .	32
Hand . . . . .	31	Association . . . . .	20, 21	<b>Masks—</b>		Shot—	
Hurley . . . . .	40	College . . . . .	3, 4	Fencing . . . . .	44	Athletic . . . . .	36
Indoor Base . . . . .	25	Foot Ball Clothing . . . . .	7	Nose . . . . .	10	Indoor . . . . .	36
Lacrosse . . . . .	40	Foot Ball Timer . . . . .	11			Skates, Roller . . . . .	43
Medicine . . . . .	31			<b>Mattresses—</b>		Skate Keys . . . . .	43
Playground . . . . .	25	<b>Gloves—</b>		Gymnasium . . . . .	49	Skate Rollers . . . . .	43
Polo, Roller . . . . .	43	Boxing . . . . .	50-53	Wrestling . . . . .	49	Sprint Lanes . . . . .	36
Polo, Water . . . . .	34	Fencing . . . . .	44	Megaphones . . . . .	11	Squash Goods . . . . .	41
Push . . . . .	34	Foot Ball . . . . .	44	Mitts—		Standards—	
Squash . . . . .	41	Hand Ball . . . . .	35	Hand Ball . . . . .	35	Vaulting . . . . .	37
Volley . . . . .	35	Hockey, Field . . . . .	40	Striking Bag . . . . .	53	Volley Ball . . . . .	31
		Lacrosse . . . . .	40	Monograms . . . . .	28	Sticks, Roller Polo . . . . .	43
<b>Bandages—</b>		Goals—		Mouthpiece, Foot Ball . . . . .	10	Stockings—	
Elastic . . . . .	14	Basket Ball . . . . .	23			Athletic . . . . .	15
Canvas, Foot Ball . . . . .	14	Field Hockey . . . . .	40	Needle, Lacing . . . . .	5	Foot Ball . . . . .	15
Bar Bells . . . . .	45	Foot Ball . . . . .	21	Nets—		Golf . . . . .	15
<b>Bars—</b>		Lacrosse . . . . .	40	Basket Ball Goal . . . . .	24	Stop Boards . . . . .	37
Horizontal . . . . .	48	Water Polo . . . . .	34	Indoor Golf . . . . .	42	Striking Bags . . . . .	54, 55
Parallel . . . . .	48	Golf, Indoor . . . . .	42	Volley Ball . . . . .	35	Suits—	
<b>Bases—</b>		<b>Grips—</b>		Numbers, Competitors . . . . .	37	Gym., Women's . . . . .	59, 60
Indoor Base Ball . . . . .	25	Athletic . . . . .	38			Swimming . . . . .	34
Stations, for Relay Races . . . . .	37	Gymnasium, Home . . . . .	49	<b>Pads—</b>		Water Polo . . . . .	34
<b>Bats—</b>		Gymnasium Board, Home . . . . .	49	Basket Ball . . . . .	23	Supporters . . . . .	14
Indoor Base Ball . . . . .	25			Foot Ball . . . . .	8, 9	Ankle . . . . .	13
<b>Belts—</b>		<b>Hammers, Athletic . . . . .</b>	36	<b>Pants—</b>		Wrist . . . . .	15
Leather and Worsted . . . . .	15	Hangers for Dumb Bells . . . . .	45	Basket Ball . . . . .	23	Suspensories . . . . .	14
Wrestling . . . . .	27	Hangers for Indian Clubs . . . . .	45	Boys' Knee . . . . .	27	Swaters . . . . .	17-19
<b>Bladders—</b>		<b>Hats—</b>		Foot Ball, College . . . . .	7	Swivels, Striking Bag . . . . .	56
Basket Ball . . . . .	23	University . . . . .	29	Running . . . . .	39	Swords—	
Foot Ball . . . . .	5, 21	Head Harness—		Pennants, Felt . . . . .	29	Duelling . . . . .	44
Striking Bag . . . . .	56	Foot Ball . . . . .	10	Platforms, Fencing . . . . .	44	Fencing . . . . .	44
Blades, Fencing . . . . .	44	Wrestling . . . . .	27	Platforms, Striking Bag . . . . .	57		
Blankets, Foot Ball . . . . .	29	Health Pull . . . . .	56	Poles, Vaulting . . . . .	37	<b>Tackling Machine . . . . .</b>	11
Boxing Helmet . . . . .	53	Heels, Rubber . . . . .	38	Polo, Roller, Goods . . . . .	43	Take-Off Board . . . . .	37
Braces, Knee . . . . .	9	Helmet—		Potato Race . . . . .	37	Tape, Measuring Steel . . . . .	37
		Aviators . . . . .	58	Protectors—		Tennis Posts, Indoor. . . . .	41
<b>Caps—</b>		Hockey Sticks, Field . . . . .	40	Abdomen . . . . .	14	<b>Tights—</b>	
Skull . . . . .	21	Hurdles, Safety . . . . .	36	Finger, Field Hockey . . . . .	40	Athletic . . . . .	27
University . . . . .	29	Hurley Sticks . . . . .	40	Knee . . . . .	9, 23, 30	Full . . . . .	27
Water Polo . . . . .	34			Thumb, basket Ball . . . . .	24	Full, Wrestling . . . . .	27
<b>Chest Weights . . . . .</b>	46	<b>Indian Clubs . . . . .</b>	45	Push Ball . . . . .	34	Knee . . . . .	27
<b>Circles for Throwing . . . . .</b>	37	Inflaters—		Pushers, Chamois . . . . .	38	Toe Boards . . . . .	37
<b>Corks, Running . . . . .</b>	38	Foot Ball . . . . .	5	<b>Quoits . . . . .</b>	40	Trapeze, Adjustable . . . . .	49
<b>Covers—</b>		Striking Bag . . . . .	53	<b>Racquet, Squash . . . . .</b>	41	Trapeze, Single . . . . .	49
Basket Ball . . . . .	23			<b>Rings—</b>		Trousers, Y. M. C. A. . . . .	27
Foot Ball, Inflated . . . . .	4	<b>Jackets, Foot Ball . . . . .</b>	7	Exercising . . . . .	49	Trunks—	
Soccer Ball . . . . .	21	Javelins . . . . .	36	Swinging . . . . .	49	Worsted . . . . .	27
		Jerseys . . . . .	16	<b>Rowing Machines . . . . .</b>	47	Tug-of-War Belt . . . . .	34
<b>Dancing Slippers . . . . .</b>	60	<b>Knee Pads . . . . .</b>	9, 23, 30			<b>Vaulting Poles . . . . .</b>	37
Discus, Olympic . . . . .	36	Lace, Foot Ball . . . . .	5	<b>Sacks, for Sack Racing . . . . .</b>	37	Volley Ball . . . . .	35
Disks, Striking Bag . . . . .	57	Lacrosse Goods . . . . .	40	Score Books—		<b>Wands, Calisthenic . . . . .</b>	45
Dumb Bells . . . . .	45	Ladies—		Basket Ball . . . . .	23	Watches, Stop . . . . .	11, 37
Dummy, Tackling . . . . .	11	Fencing Goods . . . . .	44	Shin Guards—		Weights, 56-lb. . . . .	36
		Field Hockey Goods . . . . .	40	Association . . . . .	21	Whistles, Referees, 11, 23, 37	
<b>Ear Stopples . . . . .</b>	34	Gymnasium Shoes . . . . .	30	College . . . . .	9	Wrestling Equipment . . . . .	27
Emblems . . . . .	28	Skates, Roller . . . . .	43	Field Hockey . . . . .	40	Wrist Machines . . . . .	56
Embroidery . . . . .	28						

This is the Spalding Catalogue of Athletic Equipment for Fall Sports Only. Our Winter Catalogue in which we will list Ice Skates, Ice Hockey Goods, Toboggans, Snow Shoes, Skis, etc., will be ready for distribution on October 5. Following Spalding Catalogues will be sent FREE on request to any address:

SPRING CATALOGUE—Listing all Base Ball Equipment, etc. SUMMER CATALOGUE—Listing all Tennis and Golf Equipment. BATHING SUIT CATALOGUE.





## The Official Intercollegiate Foot Ball

Patented September 12, 1911

This is the Only Official College Foot Ball, and is used in every important match played in this country. *Guaranteed absolutely if seal of box is unbroken.* Each ball complete in sealed box, including leather case, guaranteed pure Para rubber bladder (not compounded), lacing needle and rawhide lace.

No. J5. Each, \$6.00

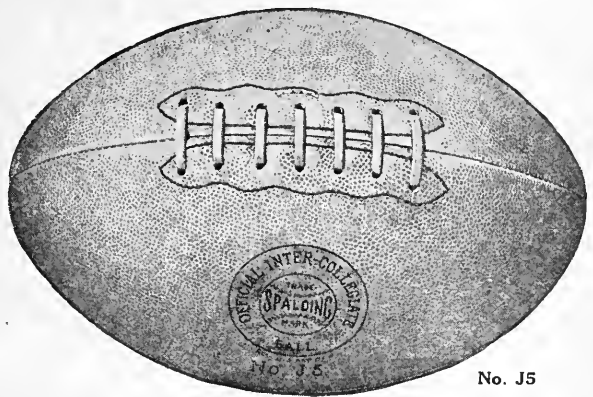

No. J5

WE GUARANTEE every No. J5 Spalding Foot Ball to be perfect in material and workmanship and correct in shape and size when inspected at our factory. If any defect is discovered during the first game in which it is used, or during the first day's practice use, and if returned at once, we will replace same under this guarantee. We do not guarantee against ordinary wear nor against defect in shape or size that is

not discovered immediately after the first day's use. Owing to the superb quality of every Spalding Foot Ball, our customers have grown to expect a season's use of one ball, and at times make unreasonable claims under our guarantee which we will not allow.

*A. G. Spalding & Bros.*

## Spalding "College Special" Foot Ball

Made of Specially Tanned Grain Leather

Patented September 12, 1911

Superior in style and quality to the many balls put on the market in imitation of our Official No. J5 Ball. Each ball put up in a sealed box with guaranteed bladder, lacing needle and rawhide lace.

No. A. Each, \$5.00



No. A

ALL PRICES SUBJECT TO CHANGE WITHOUT NOTICE. ALL ORDERS WILL BE ACCEPTED ONLY SUBJECT TO OUR ABILITY TO SUPPLY THE GOODS. PRICES SHOWN ARE THOSE IN EFFECT ON DATE NOTED BELOW.

### No. 2. SPALDING'S OFFICIAL FOOT BALL GUIDE. Edited by Walter Camp.



This is the only official book on foot ball, and is of vital interest to all connected with the sport, whether as active players or spectators, as it is the book containing the official rules as revised annually by the Foot Ball Rules Committee. It contains reviews on the conditions and workings of the game in the North, South, East and West, and covers all the leading colleges in America. It gives Walter Camp's All-America team, and numerous sectional selections; representative teams and their work; college notes; foot ball data from 1869 to date; field goal records; famous runs; list of officials; captains, coaches and managers of teams; team records and schedules for the current season. Pictorially, all the prominent college and high school teams are shown. . . . Price, 10 cents.



No. B

## Spalding College Foot Ball

Patented September 12, 1911

Selected fine grain leather case. Each ball packed complete in sealed box with guaranteed bladder, rawhide lace and lacing needle. Regulation size.

No. B. Each, \$4.00

## Spalding College Foot Ball

Patented September 12, 1911

Case of foot ball leather, pebbled. Each ball packed complete with guaranteed bladder, rawhide lace and needle in sealed box. Regulation size.

No. F. Each, \$3.50



No. F



No. S

## Spalding College Foot Ball

Patented September 12, 1911

Good quality leather case, pebbled graining. Each ball packed complete with guaranteed bladder, rawhide lace and needle in sealed box. Regulation size.

No. S. Each, \$3.00

## Spalding College Foot Balls

Patented September 12, 1911

Well made leather case, pebbled graining. Each ball packed complete with guaranteed bladder in sealed box. Regulation size.

No. C. Each, \$2.50

Leather case, pebbled graining. Each ball packed complete with guaranteed bladder in sealed box. Regulation size.

No. D. Each, \$2.00



No. C

Don't permit your Foot Ball to become water soaked and then expect it to keep in good playing condition. ALL PRICES SUBJECT TO CHANGE WITHOUT NOTICE. ALL ORDERS WILL BE ACCEPTED ONLY SUBJECT TO OUR ABILITY TO SUPPLY THE GOODS. PRICES SHOWN ARE THOSE IN EFFECT ON DATE NOTED BELOW.



# FOOT BALL

## Rawhide Foot Ball Lace

No. R. Each, 10c.



## Foot Ball Lacing Needle

No. N. Made of annealed steel wire, with wooden handle. A really practical lacer. . . . Each, \$ .15  
No. O. Canvas case to carry inflated foot ball. " 1.50

## "Club" Foot Ball Inflater

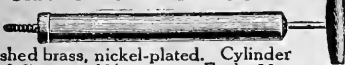

No. 2. Polished brass, nickel-plated. Cylinder 10½ in. and diameter 1¼ in. . . . Each, 60c.

**Foot Ball Inflater**

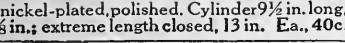

No. 3. Brass, nickel-plated, polished. Cylinder 9½ in. long, diameter 7/8 in.; extreme length closed, 13 in. Ea., 40c.

## Guaranteed College Foot Ball Bladders

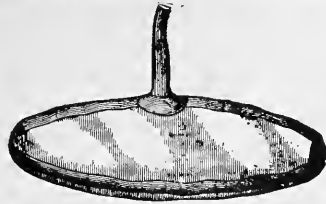

No. OR. For No. J5 Ball. . . . Each, \$1.00  
No. P. For Nos. A, B and F Balls. . . . .90  
No. R. For Nos. S, C and D Balls. . . . .75

All rubber foot ball bladders bearing our Trade-Mark are guaranteed perfect in material and workmanship. Note special explanation of guarantee on tag attached to each bladder. *Don't use mouth to inflate rubber bladders.*

## HOW TO LAY OUT A FOOT BALL FIELD

The following diagram and rules for laying out a foot ball field are reproduced from Spalding's Official Foot Ball Guide and will be found useful to men in the various training camps who may not have a copy of the Guide handy.

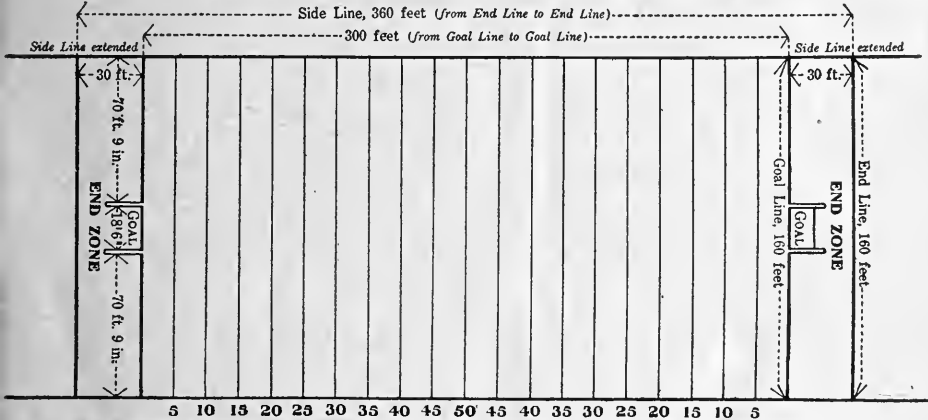

The Field of Play is a Parallelogram bounded by the side lines and goal lines and thus measuring 360 feet by 160 feet.

**Section 1. Field**—The game shall be played upon a rectangular field, 360 feet in length and 160 feet in width. The lines at the ends of the field shall be termed *End Lines*. Those at the sides shall be termed *Side Lines* and shall extend indefinitely beyond their points of intersection with the goal lines. The *Goal Lines* shall be established in the field of play ten yards from and parallel to the end lines. The space bounded by the goal lines and the side lines shall be termed the *Field of Play*. The spaces bounded by the goal lines, the end lines and the side lines shall be termed the *End Zones*.

**Section 2.** These lines shall be marked in white. The Field of Play shall be marked at intervals of five yards with white lines parallel to the goal lines.

**NOTE**—Previous to the beginning of play, the Referee shall see that the field is properly marked.

**Section 3.** The goal posts shall be placed in the middle of each goal line, shall exceed 20 feet in height and be placed 18 feet 6 inches apart, with a horizontal cross-bar 10 feet from the ground.

**No. 2. Spalding's Official Foot Ball Guide.** Edited by Walter Camp.

This is the only official book on foot ball, and is of vital interest to all connected with the sport, whether as active players or spectators, as it is the book containing the official rules as revised annually by the Foot Ball Rules Committee. It contains reviews on the condition and workings of the game in the North, South, East and West and covers all the leading colleges in America. Pictorially, all the prominent college and high school teams are shown. Price 10 cents.

**No. 47R. How to Play Foot Ball.** By Walter Camp, leading authority on the game and editor of the Official Foot Ball Guide. How to play the game as it should be played. Should be read by both the beginner and the seasoned player. Price 25 cents.



ALL PRICES SUBJECT TO CHANGE WITHOUT NOTICE. ALL ORDERS WILL BE ACCEPTED ONLY SUBJECT TO OUR ABILITY TO SUPPLY THE GOODS. PRICES SHOWN ARE THOSE IN EFFECT ON DATE NOTED BELOW.



## SPALDING COLLEGE FOOT BALL EQUIPMENT



WORN BY  
THE PLAYERS  
ON PRACTICALLY  
EVERY COLLEGE  
AND  
SCHOOL TEAM  
IN THE  
UNITED STATES

WE SOLICIT CORRESPONDENCE WITH FOOT BALL COACHES AND OTHERS REGARDING SPECIAL PADS AND OTHER EQUIPMENT FOR PLAYERS FOR WHOM REGULAR DESIGNS MAY NOT BE ALTOGETHER SATISFACTORY. IT IS IMPOSSIBLE TO SHOW IN THIS CATALOGUE THE COMPLETE LINE OF FOOT BALL PADS, BRACES, GUARDS, ETC., THAT WE MANUFACTURE. MANY PROMINENT PLAYERS OWE THEIR PROMINENCE IN GREAT MEASURE TO THE EXCELLENCE OF THE EQUIPMENT WE HAVE FITTED THEM WITH.

THE IMPROVEMENTS WE ARE CONSTANTLY MAKING IN CONSTRUCTION OF OUR ATHLETIC OUTFITS, FOOT BALL EQUIPMENT, ETC., ARE THE RESULT OF OUR FAMILIARITY AND CLOSE TOUCH WITH ATHLETIC CONDITIONS THROUGHOUT THE COUNTRY, TOGETHER WITH OUR ABILITY TO DEVELOP IDEAS AND SUGGESTIONS OF PLAYERS AND COACHES THROUGH OUR UNFQUALLED FACTORY FACILITIES.

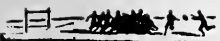

# SPALDING COLLEGE FOOT BALL CLOTHING

Made of either canvas, or drill, as specified in descriptions, specially manufactured for us; the curled hair, wool felt and other padding is most carefully selected, and we use no metal eyelets, all being hand worked.

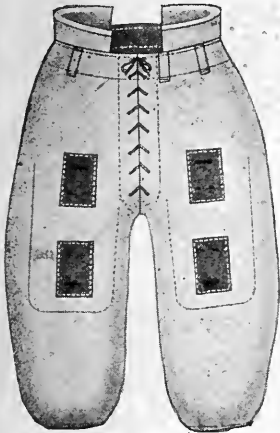

No. PTP

## Spalding Intercollegiate Foot Ball Pants

No. PTP. Equipped with heavy white felt hip and kidney pads, white felt knee pads and a patented fibre thigh guard that will not lose its shape. Thigh guard can be raised or lowered to suit player. Special tunnel belt loops. Note cut of pants turned inside out showing position of padding and special thigh guard pocket.

Pair, \$5.00 ★ \$54.00 Doz.

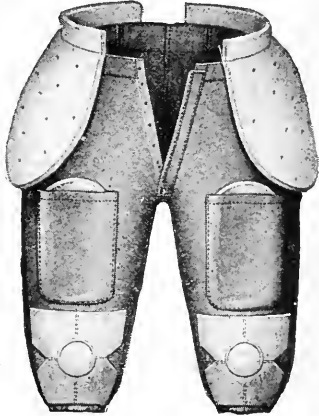

Cut showing arrangement of Padding in No. PTP Pants

## Spalding Unpadded Intercollegiate Foot Ball Pants

No. VTU. This unpadded "shell" provides the proper cover for such special padding arrangement as may be desired by team coaches or trainers. Made with eyelet holes in the waist for lacing hip and kidney pads in and a pocket inside the pants to hold fiber guards, besides leather pieces with lacing eyelets in front for adjusting thigh guards. Canvas half belt with metal buckle.

Pair, \$2.75 ★ \$29.70 Doz.

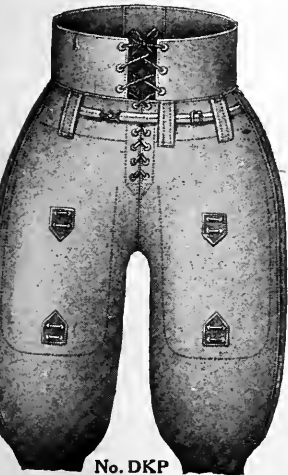

No. DKP

## Spalding "Superior" Foot Ball Pants

No. DKP. Spalding "Superior." Felt padding with fibre reinforcement including extension kidney protection of fiber, canvas covered. Tunnel belt loops. Special quality brown canvas. Supplied on special orders only.

Pair, \$6.50 ★ \$70.20 Doz.

## Spalding Foot Ball Pants CANVAS

No. 3P. Good quality brown canvas. White felt hip and kidney pads, and real cane strips at thighs. Curled hair knee pads.

Pair, \$3.25 ★ \$35.10 Doz.

No. 2P. Good quality brown canvas, well padded and real cane strips at thighs.

Pair, \$2.00 ★ \$21.00 Doz.

No. BP. Brown drill, correctly padded. Each, \$1.25 ★ \$13.50 Doz.

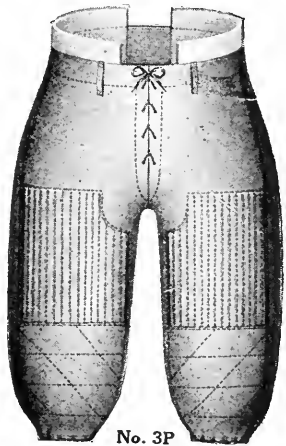

No. 3P

## Spalding Sleeveless Foot Ball Jackets

No. VJ. "Varsity. Light weight, brown canvas. Special quality. Each, \$1.50 ★ \$16.20 Doz.

Union Suits Supplied on Special Order.

Felt Hip Pads listed on Page 8. Jerseys, Page 16. Sweaters, Pages 17-19.

The prices printed in italics opposite items marked with ★ will be quoted only on orders for one-half dozen or more. Quantity prices NOT allowed on items NOT marked with ★

ALL PRICES SUBJECT TO CHANGE WITHOUT NOTICE. ALL ORDERS WILL BE ACCEPTED ONLY SUBJECT TO OUR ABILITY TO SUPPLY THE GOODS. PRICES SHOWN ARE THOSE IN EFFECT ON DATE NOTED BELOW.



No. VJ



## SPALDING CORRECTLY DESIGNED FOOT BALL SHOULDER PADS

No. HYS. Combined shoulder, collar bone and chest protector. One of the most effective pieces of football armor ever constructed. Construction throughout is in strict accordance with official rules, and while it gives the maximum degree of protection to the parts covered, it is light in weight and can be ventilated to any desired extent without affecting strength or degree of protection. Padding of good quality felt. Sole leather molded shoulder pieces, adjustable to size of player.

Each, \$5.00

No. YF. Molded leather shoulder pieces, felt padded, complete with special extra thick felt collar bone protectors and adjusting straps to regulate size. . . Each, \$4.00 ★ \$43.20 Doz.

No. XF. Combined shoulder and collar bone protector. Felt padded. Sole leather molded shoulder caps. . . Each, \$4.00 ★ \$43.20 Doz.

No. XC. Canvas, felt padded combined shoulder and collar bone protector. Leather covered shoulder caps. . . Each, \$3.00 ★ \$32.40 Doz.

No. HC. Canvas combined shoulder and collar bone protector, fiber reinforced, padded with wool felt and canvas covered on inside. Lace adjustment. . . Each, \$2.50 ★ \$27.00 Doz.

No. DFB. For boys. All felt combined shoulder and collar bone protector, elastic adjustment.

Each, \$1.50 ★ \$16.20 Doz.

No. Y. As No. YF (listed above) but without collar bone protectors. Felt padded. Adjusting straps. Supplied on special order only. Ea., \$3.00 ★ \$32.40 Doz.

No. MF. As No. YF (listed above) but moleskin instead of leather; felt padded. \$2.50 ★ \$27.00 Doz.

No. LL. Large, leather, felt padded. 2.50 ★ 27.00 "

No. LM. Medium, leather, style same as No. LL.

Felt padded. Supplied on special order only.

Each, \$2.50 ★ \$27.00 Doz.

No. CF. Small, canvas, similar style to No. LM.

Felt padded. . . . Each, \$1.00 ★ \$10.80 Doz.

### Spalding Shoulder Pads

No. B. Made to fit shoulder. Heavily padded inside and out with wool felt. . . . Each, \$2.50

No. D. Soft black leather covering, padded with heavy felt and fitted with adjusting lace and elastic. Selvage left for attaching to jersey. . . . Each, \$1.25

### Spalding Elbow Pad

No. EW. Soft leather, padded with wool fleece. Pair, \$1.00

**Spalding Hip Pads—Proper shape to attach to pants**  
No. H. Patented style; padding of fiber squares, backed with felt, covered with good quality brown canvas. Complete with heavy elastic adjusting straps connecting the two pads. (Patent applied for.) . . . Pair, \$5.00

No. HS. One pad only, style No. H. No elastic. Each, 2.50

No. 10. White felt, sole leather reinforced. Complete with laces for attaching. . . . Pair, \$3.50

No. HW. White felt, heavy weight, ventilated. Without lacing attachment. . . . Pair, \$1.50

No. HG. Gray felt, otherwise same as No. HW. . . . 1.25

### Covered Shoulder and Elbow Pads

Hand made and correctly padded. Elbow pads made extra thick. Shoulder pads extra long to give full protection. Readily attached to any part of a jersey, but especially adapted to shoulders and elbows. Covered with tan leather and tufted padding, which has all the softness of curled hair and durability of felt.

No. 1. Shoulder Pad. Each, 75c. ★ \$8.10 Dz.

No. 2. Elbow Pad. . . . 75c. ★ 8.10

As above, covered with brown canvas instead of leather

No. 3. Shoulder Pad. Each, 30c. ★ \$3.24 Dz.

No. 4. Elbow Pad. . . . 30c. ★ 3.24 "

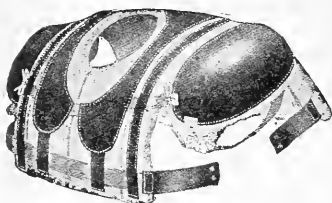

Front View of No. HYS

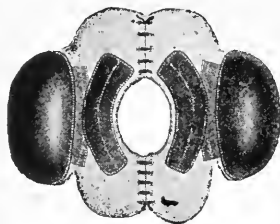

No. XF

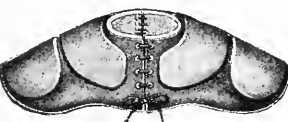

No. HC

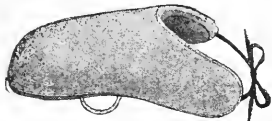

No. B

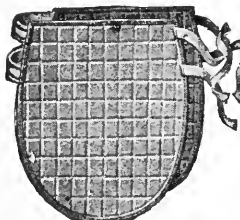

No. H Hip Pad

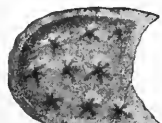

No. 1

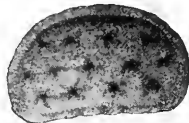

No. 2



No. YF

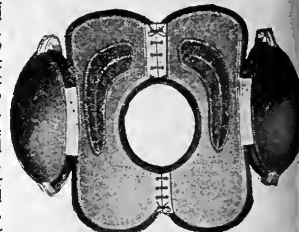

No. XC



No. DFB



No. LL



No. D



No. 10 Hip Pad

The prices printed in italics opposite items marked with ★ will be quoted only on orders for one-half dozen or more at one time. Quantity prices NOT allowed on items NOT marked with ★

ALL PRICES SUBJECT TO CHANGE WITHOUT NOTICE. ALL ORDERS WILL BE ACCEPTED ONLY SUBJECT TO OUR ABILITY TO SUPPLY THE GOODS. PRICES SHOWN ARE THOSE IN EFFECT ON DATE NOTED BELOW.





SPALDING CORRECTLY DESIGNED KNEE, THIGH AND SHIN GUARDS

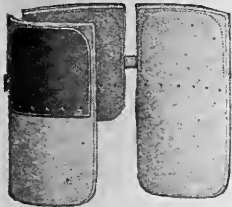

No. MPT

Spalding Hip and Kidney Pads

No. MPT. Triple protection hip and kidney pads. White felt, sole leather covered. . . . . Pair, \$5.00

Spalding Thigh Guards

No. HF. Patented style, with padding of fiber squares, backed and covered with white felt. Size 10 1/2 inches long. Patented Oct. 26, 1915. . . . . Pair, \$2.75

No. HK. Same as No. HF, but backed with gray felt and covered with brown canvas. . . . . Pair, \$2.50

No. TP. Fiber, covered, felt padding on edges, and steel band reinforcement to keep in shape. Light in weight and effective. Pat. Feb. 22, 1916. . . . . Pair, \$2.00



No. HF

Combined Knee Pad and Thigh Guard

Patented February 22, 1916

No. TPK. Combining the No. TP Thigh Guard and No. KP Knee Pad. Complete protection with minimum weight. This combination is becoming more popular each season as its virtues become better known. . . . . Pair, \$4.00



No. TPK

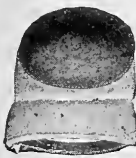

No. 9KP

Spalding New Improved Foot Ball Knee Pad

No. 9KP. Made with solid leather knee cap, padded with wool felt. Conforms with curve of the knee and is the most effective and safest made.

Pair, \$4.00 ★ \$13.20 Doz. Prs.

No. KP. Made entirely of felt, otherwise similar to No. 9KP. . . . . Pair, \$3.00 ★ \$32.40 Doz. Prs.

No. KPX. Soft leather knee cap, felt padded, with wide elastic bandage below knee for extra support, and elastic strap above to hold in place. Pair, \$2.00 ★ \$21.60 Doz. Prs.



Inside view No. TP, showing special felt padding and steel band reinforcement to keep in shape.

Spalding Foot Ball Shin Guards

No. HD2. Patented style, with padding of fiber squares, covered with drill back and front. Length 12 inches. To be worn inside stockings. (Pat. Oct. 26, 1915). . . . . Pair, \$1.50 ★ \$16.20 Doz. Prs.

No. HD. Same as No. HD2, but 9 1/2 in. long. . . . . 1.25 ★ 13.50 "

No. 60. Black leather, backed up with real rattan reeds, felt padding, leather straps and binding. . . . . Pair, \$2.50 ★ \$27.00 Doz. Prs.

No. 12. Pebbled sheepskin, well padded, black leather straps. Pair, \$1.25 ★ \$13.50 Doz. Prs.

No. 9. Canvas, length 10 inches, with reeds. . . . . .60 ★ 6.48 "

No. 7. Molded fiber shin guards to be worn under stockings. Webbing straps inside to ward off shin bone. Bound with felt at ankle. Pair, \$1.00

Spalding Patented Knee Braces

With either of these braces, it is practically impossible to throw knee out of joint. Made after suggestion of Ridge Hart, the old Princeton half-back. Saves knee fracture or injury to joint, yet allows perfect freedom of movement.

No. HSB. Improved style. Adjustable, special steel side braces with leather leg supporting straps. Nicely padded. . . . . Each, \$8.00

No. HKB. On this style, elastic bandages are attached above and below knee and these in order to support ligaments must fit snugly. When ordering it is necessary to state measurements, both above and below knee. Patented April 14, 1914. Each, \$6.00

The prices printed in italics opposite items marked with ★ will be quoted only on orders for one-half dozen pairs or more. Quantity prices NOT allowed on items NOT marked with ★

ALL PRICES SUBJECT TO CHANGE WITHOUT NOTICE. ALL ORDERS WILL BE ACCEPTED ONLY SUBJECT TO OUR ABILITY TO SUPPLY THE GOODS. PRICES SHOWN ARE THOSE IN EFFECT ON DATE NOTED BELOW.



No. HSB



No. KPX



No. 60



No. HKB



## SPALDING HEAD HARNESS

Our Head Harness really protect. They are endorsed by the most prominent trainers in this country. All Spalding Head Harness conform exactly to the Rules of Intercollegiate Association. We are the originators of the special back extension on Head Harness. MENTION SIZE HAT WORN WHEN ORDERING HEAD HARNESS

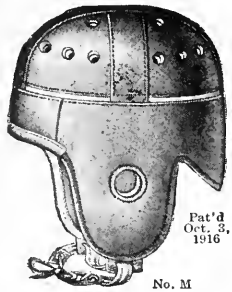

Pat'd Oct. 3, 1916

No. M

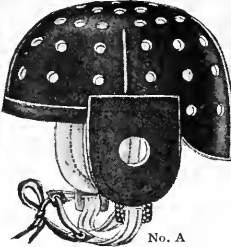

No. A

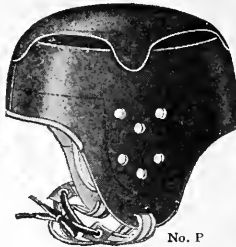

No. P



No. H

**No. M.** With this head harness the top of the head rests against firm elastic strapping which keeps it away from top of head harness. The guard itself is made of firm black leather, felt padded, and perforated for ventilation. There is an elastic adjusting head band, but size of hat worn should be mentioned when ordering. Pat'd Oct. 3, 1916. Ea., \$6.00  
**No. A.** Firm tanned black leather, molded to shape, perforated for ventilation, leather sweatband and extra felt protection at back. Adjustable chin strap. Presents a perfectly smooth surface and, while giving absolute protection, is one of the coolest and lightest made. Mention size hat worn. . . . . Each, \$5.00 ★ \$54.00 Doz.  
**No. P.** Solid black leather, crown open all around. Padded only at top and around ears. . . . . Each, \$4.00 ★ \$43.20 Doz.  
**No. H.** Soft black leather, covered and padded with fine soft yielding felt. Ventilation holes on top. Ea., \$4.00 ★ \$43.20 Doz.



No. B



No. W

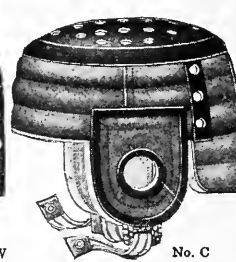

No. C

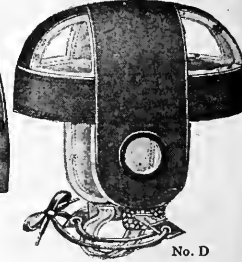

No. D

**No. B.** Soft black leather top and sides, soft leather ear pieces, adjustable chin strap. Top padded with felt, leather sweatband and well ventilated. Sides stitched and felt padded. Mention size hat worn. Each, \$3.50 ★ \$37.80 Doz.  
**No. W.** Full felt padded, well ventilated, black leather, elastic adjustment in front and low back extension. Popular especially with Western colleges. Mention size hat worn. . . . . Each, \$3.00 ★ \$32.40 Doz.  
**No. C.** Soft black leather top, well ventilated; molleskin sides and ear pieces, elastic chin strap. Nicely padded with felt, leather sweatband and substantially made. Mention size hat worn. . . . . Each, \$2.50 ★ \$27.00 Doz.  
**No. D.** Boys'. Brown canvas, nicely padded, light and cool to wear. Mention size hat worn. . . . . 1.25 ★ 13.50 Doz.

### SPALDING NOSE MASKS AND MOUTHPIECES

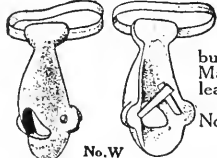

No. W

#### Wendell Patent Nose Masks

Patented November 5, 1912

Invention of Percy L. Wendell, famous line bucker and Captain of 1911 Harvard Foot Ball Team. Made of finest rubber, fitted with piece of soft tanned leather at either side for gripping by back teeth. Amply ventilated.

**No. W.** Regulation size. Each, 60c. ★ \$6.48 Doz.



No. O

#### Morrill Patent Nose Masks

**No. O.** Regulation size, with adjustable mouthpiece. . . . . Each, 50c. ★ \$5.40 Doz.

**No. OB.** Youths' size, with adjustable mouthpiece. . . . . 50c. ★ 5.40 Doz.

**No. 1.** Regulation size, without adjustable mouthpiece. . . . . 50c. ★ 5.40 Doz.

No wire or metal is used in the construction of any Wendell or Morrill Nose Masks.

#### Rubber Mouthpiece



**No. A.** Best quality Pararubber; perfect protection to mouth and teeth. Same as supplied with Nos. O and OB masks. Each, 25c. ★ \$2.70 Doz.

In ordering, specify whether mouthpiece is required for Nos. O or OB masks.

## 2 Felt Numbers for Identifying Foot Ball Players

Furnished in either 7 or 8 inch size, and in any color.

Each, 24c. ★ \$2.60 Doz.

#### Spalding Foot Ball Gloves

**No. 1.** Conibeer Glove. Back of hand protected by piece of sole leather and any strain to the wrist is avoided by leather strap supporter. Glove doesn't interfere with free use of hand. Made for right or left hand. . . . . Each, \$1.50

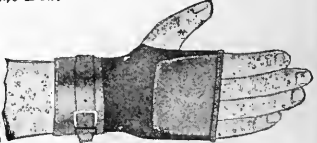

The prices printed in italics opposite items marked with ★ will be quoted only on orders for one-half dozen or more at one time. Quantity prices NOT allowed on items NOT marked with ★

ALL PRICES SUBJECT TO CHANGE WITHOUT NOTICE. ALL ORDERS WILL BE ACCEPTED ONLY SUBJECT TO OUR ABILITY TO SUPPLY THE GOODS. PRICES SHOWN ARE THOSE IN EFFECT ON DATE NOTED BELOW.





**SPALDING FOOT BALL TACKLING DUMMY**

Heavy 10-ounce brown canvas, reinforced inseams and without joining at waist; reinforced at bottom with heavy sole leather. Complete with heavy rope ring for special reinforcement (see cut). *At many of the prominent colleges a pair of foot ball trousers are put on the dummy and held secure by the encircling strap which we furnish with the dummy.* Each, \$16.50

**FOOT BALL TACKLING MACHINE AND RELEASING ATTACHMENT**

Complete equipment, as shown in cut, except uprights and cross-beam, comprising tackling dummy, releasing attachment, with pulley block and connecting rope, and steel cross rod as listed separately below. . . \$38.50

Uprights and cross-beam can be purchased at any sawmill.

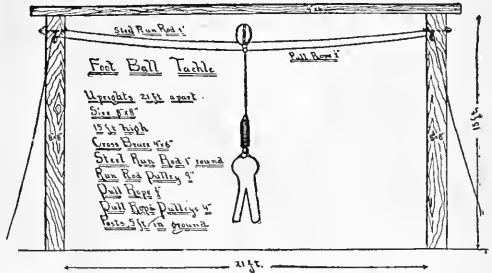

**RELEASING ATTACHMENT**

With pulley block to run on cross rod, spliced to connecting rope. . . . Each, \$10.00

**STEEL CROSS ROD**

Threaded both ends, complete, nuts and washers. Each, \$12.00

**COMBINATION STOP WATCH**

No. D. Continuous timer arranged so entire half may be timed accurately, stopped during interruptions, started again when play is resumed. For timing other athletic events. Registers up to 60 minutes; nickel case. Ea., \$8.00



Releasing Attachment

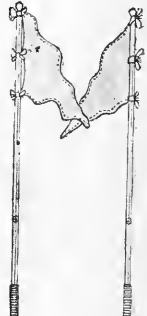

**LAWSON FOOT BALL TIMER** (See also Stop Watches listed on Page 37) Nickel case. . . " 3.00



(See Page 23 for other Whistles.)

**SPALDING FOOT BALL OFFICIALS' HORN**

No. 3W. Loudest horn manufactured. Heard above cheering in places as large as Harvard Stadium or Yale Bowl. Attached to wrist band of leather. \$1.75  
No. 7. Nickel-plated, heavy metal referees' whistle. . . . Each, 50c.

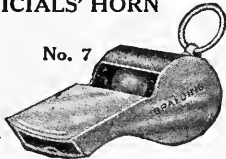

**LINESMAN'S MEASURING OUTFIT**—White painted iron rod uprights, topped with white flags. Chain of special design. Com., \$10.00

**SPALDING "LONG DISTANCE" PREPARED FIBER MEGAPHONES**  
No. 1 1/2. 22-inch Cone. Each, \$2.75  
No. 2. 30-inch Cone. Each, \$3.75  
No. 3. 40-inch Cone. " 5.00  
Stand only, for No. 3, extra, 4.00

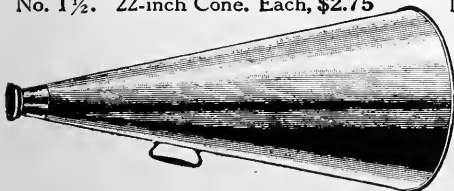

**WATERPROOF CONES**

(For Cheering, etc.)

No. O. 12-inch. Dozen, \$4.00  
No. OX. 20-inch. " 8.00  
No. CX. Coxwains', complete with head harness. . . Each, \$2.75



Linesman's Measuring Outfit

College and School Flags, Pennants, etc., listed on Page 29.

ALL PRICES SUBJECT TO CHANGE WITHOUT NOTICE. ALL ORDERS WILL BE ACCEPTED ONLY SUBJECT TO OUR ABILITY TO SUPPLY THE GOODS. PRICES SHOWN ARE THOSE IN EFFECT ON DATE NOTED BELOW.



## SPALDING FOOT BALL SHOES

Spalding Foot Ball Shoes are worn by the players of every college and school team of any importance in this country, and notably by the following most successful teams: Yale, Princeton, Cornell, University of Pennsylvania, Carlisle, West Point, Annapolis, Michigan, Chicago, Illinois, Wisconsin, Minnesota, Nebraska, Indiana, Iowa, California, Leland Stanford, Washington, Missouri, St. Louis, Arkansas, Syracuse.



No. AX Side View



No. AX Sole

### Spalding Featherweight Shoe

No. AX. Finest kangaroo leather. For fastest players only, not for general or hard usage. Finest materials throughout. Strong, soft laces.

Pair, \$8.50 ★ \$96.00 Doz..



No. A2-OS Side View



No. A2-OS Sole

### Spalding Sprinting Shoe

No. A2-OS. Kangaroo leather. Light in weight yet strongly made. Fine soles with cleats firmly attached; box toes. Use this style shoe instead of No. AX for ordinary play. Strong, soft laces.

Pair, \$8.00 ★ \$90.00 Doz.

**SPECIAL NOTICE**—Spalding "Dri-Foot," used on uppers and soles, greatly adds to wear of Foot Ball Shoes. Can 10 cents.

*The prices printed in italics opposite items marked with ★ will be quoted only on orders for one-half dozen pairs or more at one time. Quantity prices NOT allowed on items NOT marked with ★*

**ALL PRICES SUBJECT TO CHANGE WITHOUT NOTICE. ALL ORDERS WILL BE ACCEPTED ONLY SUBJECT TO OUR ABILITY TO SUPPLY THE GOODS. PRICES SHOWN ARE THOSE IN EFFECT ON DATE NOTED BELOW.**

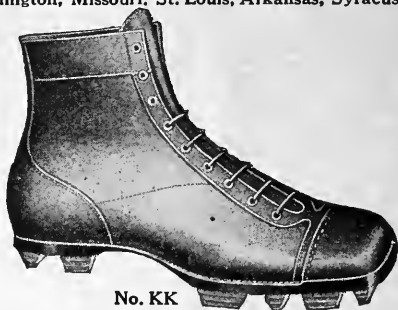

No. KK

### Spalding Special "Kicking" Shoe

No. KK. A specially designed "kicking" shoe. "Kicking" toe is put on either shoe, not on both. Specify which shoe is required with "kicking" toe when ordering. Supplied on special order only. Pair, \$9.00



No. A2-M

### Spalding 'Varsity' Shoe

No. A2-M. Finest selected black leather; thoroughly made. Fine soles with cleats firmly attached; box toes. Strong, soft laces. Equipped with special ankle brace designed by the late Mike Murphy, the famous trainer.

Pair, \$7.50 ★ \$84.00 Doz.



### Kicking Toe

Box toe, for kicking, supplied on any style college foot ball shoe (except Nos. A4 and A5) at time shoe is ordered, not afterward, at an extra charge for fitting one shoe in pair. . . . \$1.50

Illustrating Spalding Foot Ball Ankle Brace with which we equip the No. A2-M style shoe. Designed by the late Mike Murphy, trainer of the University of Pennsylvania Team. Absolutely prevents turning of ankle.

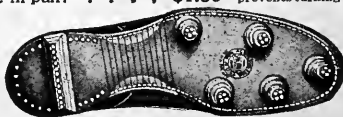

### Mud Cleats

We will supply, on special order, not carried in stock, either Nos. AX, KK, A2-OS or A2-M, for use in wet weather and on muddy fields, equipped with special mud cleats, at an extra charge of . . . . Pair, \$1.00



## SPALDING FOOT BALL SHOES



No. A2-S

### Spalding Club Special Shoe

No. A2-S. Sprinting Shoe, light weight; black selected leather, box toes, good quality, well made. Strong, soft laces. . . . . Pair, **\$6.00** ★ **\$66.00 Doz.**



No. A-3

### Spalding Amateur Special Shoe

No. A-3. Black chrome leather, good quality, machine sewed. A very servicable shoe. Pair, **\$5.00** ★ **\$54.00 Doz.**



No. A-5

### Spalding Sprinting Shoe

No. A-5. Black selected leather, well made through-out. . . . . Pair, **\$6.00** ★ **\$66.00 Doz.**



No. A-4

### Spalding Juvenile Foot Ball Shoe

No. A-4. Made on our special boys' size lasts. Material and general construction similar otherwise to our regular line of men's shoes. Boys' sizes 12 to 5, inclusive. Complete with leather cleats. Pair, **\$3.50** ★ **\$39.00 Doz.**

### Kicking Toe

Box toe, for kicking, supplied on any style college foot ball shoe (except Nos. A-4 and A-5) at time shoe is ordered, not afterward, at an extra charge for fitting one shoe in pair. . . . . **\$1.50**

### SPECIAL NOTICE

Spalding "Dri-Foot," used on uppers and soles, greatly adds to wear of foot ball shoes. . . . . Can, 10c.

### The Spalding Improved Ankle Supporter

(Patented July 14, 1908. No. 892,064.)

Improved on original Hackey patent, of which A. G. Spalding & Bros. were the sole licensees. The patent on this supporter refers particularly to the seamless back, as we make it in all qualities with a molded back, requiring no seam. Worn over or under stocking and supports the ankle admirably, while not interfering in any way with free movements. Relieve pain immediately and cure a sprain in a remarkably short time. In ordering, give size of shoe worn.

No. H2. Good quality tan leather, no seam in back. . . . . Pair, **\$1.50**

No. SH. Good quality sheepskin, well made. Special patented molded back, seamless. . . . . Pair, **\$1.00**

No. CH. Black duck, lined and bound. Special patented molded back, seamless. . . . . Pair, **50c.**

*The prices printed in italics opposite items marked with ★ will be quoted only on orders for one-half dozen pairs or more.*

*Quantity prices NOT allowed on items*

*NOT marked with ★*

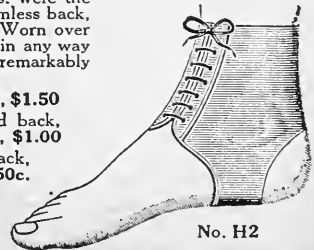

No. H2

**ALL PRICES SUBJECT TO CHANGE WITHOUT NOTICE. ALL ORDERS WILL BE ACCEPTED ONLY SUBJECT TO OUR ABILITY TO SUPPLY THE GOODS. PRICES SHOWN ARE THOSE IN EFFECT ON DATE NOTED BELOW.**

# SUPPORTERS



No. M

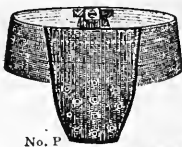

No. P



No. A



No. 1

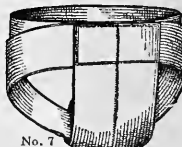

No. 7



No. WS



No. B6



No. 5



No. 3

**The "Mike Murphy" Athletic Supporter**  
**No. M.** Invented by the late Michael C. Murphy, the famous athletic trainer. Elastic waistband and mesh front, with elastic sides. Six sizes, waist measures as follows: 26-28 in., 30-32 in., 34-36 in., 38-40 in., 42-44 in., 46-48 in. . . . . Each, 75c.

**Spalding Elastic Supporters**  
**No. P.** Waistband six inches wide of good quality elastic webbing. Sack is of soft knitted worsted, ventilated. . . . . Each, \$1.50

**No. WS.** Mercerized covered elastic, strong and durable. Particularly for wrestlers. . . . . Each, \$2.25

**Morton Style Supporters**  
**No. 1.** Best Canton flannel. . . . . Each, 25c.

**Spalding Swimming Supporters**  
**No. WX.** Black silk. . . . . Each, \$1.00  
**No. A.** Durable white material. Buttons at side. . . . . 50

**The "Bike" Elastic Supporters**  
 All genuine "Bike" Supporters, as listed below, are made in three sizes: small to fit waist 22 to 28 inches; medium, 30 to 38 inches; large, 40 to 48 inches.

**No. 7.** Improved "Bike." All elastic, no buckles. . . . . Each, 75c. ★ \$8.40 Doz.

**No. 5.** Original "Bike." All elastic, no buckles. . . . . Each, 50c. ★ \$5.40 Doz.

**No. O.** Like No. 5, but mesh non-elastic front. Ea., 35c.

**No. B6.** Same material as other genuine Bike supporters, but with waistband eight inches wide. . . . . Each, \$1.50

**Spalding Aluminum Abdomen Protector**  
**No. 3.** Aluminum edges, well padded with rubber. Elastic cross bands and belt. . . . . Each, \$3.50

**Mike Murphy "Rub-In" Athletic Liniment**  
 Made according to the original formula, exclusively by A. G. Spalding & Bros.  
 Large bottle. Each, 50c. Small bottle. Each, 25c

## SPALDING ELASTIC BANDAGES

Best quality rubber elastic, either plain cotton, mercerized or silk covered, and either knitted or woven to shape as specified below.

### Spalding Elbow Bandage

Give circumference above and below elbow, and state if for light or strong pressure.

- No. 102. Cotton thread, knitted. Each, \$1.00
- No. 202. Cotton thread, woven. Each, 75c.
- No. 102A. Silk thread, knitted. Each, \$2.00
- No. 202A. Mercerized, woven. Each, \$1.50

### Spalding Knee Cap Bandage

Give circumference below knee, at knee, and just above knee, and state if light or strong pressure is desired.

- No. 104. Cotton thread, knitted. Each, \$1.00
- No. 204. Cotton thread, woven. Each, 75c.
- No. 104A. Silk thread, knitted. Ea., \$2.00
- No. 204A. Mercerized, woven. 1.50



### Spalding Shoulder Bandage

Give circumference around arm and chest. Mention for which shoulder required.

- No. 101A. Silk thread, knitted. Ea., \$5.00
- No. 201A. Mercerized, woven. " 3.50
- No. 101. Cotton thread, knitted. " 3.50
- No. 201. Cotton thread, woven. " 2.50

### Foot Ball Head Bandage

ELASTIC

Supplied in two sizes: 3 3/4 inches or 2 3/4 inches wide. Mention which size is required when ordering.

### Spalding Elastic Bandage

Composed of threads of rubber completely covered. The pressure can be applied wherever necessary. To fasten, insert end under last fold.

- No. 30. Width 3 inches, 5 yards long, (stretched). Each, 60c.
- No. 25. Width 2 1/2 inches, 5 yards long, (stretched). Each, 50c.

### Spalding Ankle Bandage

Give circumference around ankle and over instep; state if light or strong pressure is desired.

- No. 105. Cotton thread, knitted. Each, \$1.00
- No. 205. Cotton thread, woven. Each, 75c.
- No. 105A. Silk thread, knitted. Each, \$2.00
- No. 205A. Mercerized, woven. Ea., \$1.50

### Spalding Wrist Bandage

Give circumference around smallest part of wrist, and state if for light or strong pressure.



- No. 106. Cotton thread, knitted. Ea., 50c.
- No. 206. Cotton thread, woven. " 25c.
- No. 106A. Silk thread, knitted. " 75c.
- No. 206A. Mercerized, woven. " 50c.

The prices printed in italics opposite items marked with ★ will be quoted only on orders for one-half dozen or more at one time. Quantity prices NOT allowed on items NOT marked with ★

ALL PRICES SUBJECT TO CHANGE WITHOUT NOTICE. ALL ORDERS WILL BE ACCEPTED ONLY SUBJECT TO OUR ABILITY TO SUPPLY THE GOODS. PRICES SHOWN ARE THOSE IN EFFECT ON DATE NOTED BELOW,



**SPALDING ATHLETIC STOCKINGS**

Supplied on Special Orders Without Feet at No Extra Charge

No. 3-0. Plain colors. Best worsted, white mercerized feet. Tripled toes and heels. For COLORS see below. Pair, \$2.50 ★ \$27.00 Doz.

No. 3-0C. Striped. Best quality worsted, white mercerized feet. Tripled toes and heels, and any style striping. For COLORS see below. Pair, \$2.75 ★ \$30.00 Doz.

**SPALDING RIBBED STOCKINGS**

Supplied on Special Orders Without Feet at No Extra Charge  
Furnished regularly with one stripe 4 inches wide around calf

**STRIPED**—(For COLORS see below.)

No. 1RC. Heavy weight, good quality worsted, white mercerized feet, tripled toes and heels. Pair, \$1.65 ★ \$18.00 Doz.

No. 2RC. Medium weight, Union yarn, white mercerized cotton feet, reinforced toes and heels. Pair, \$1.35 ★ \$14.40 Doz.

No. 3RC. Good quality wool, white cotton feet. Pair, \$1.10 ★ \$12.00 Doz.



No. 3-0

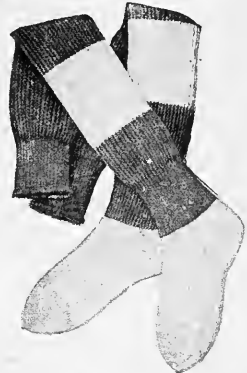

No. 1RC

No. 4RC. Striped cotton, white feet. Furnished with 4-inch calf stripe in stock colors only. No special orders. Pair, 55c. ★ \$6.00 Doz.

**PLAIN COLORS**—(For COLORS see below.)

- No. 1R. Heavy weight, good quality worsted. Feet same as No. 1RC. . . . . Pair, \$1.50 ★ \$16.80 Doz.
- No. 2R. Medium weight, Union yarn. Feet same as No. 2RC. . . . . " 1.25 ★ 13.50 "
- No. 3R. Good quality wool. Feet same as No. 3RC. . . . . " 1.00 ★ 10.80 "
- No. 4R. Cotton. Stock colors. No special orders. . . . . " .45 ★ 4.80 "
- No. BB. Natural white stockings, good weight, worn under regular stockings. . . . . Pair, 15c.

**SPALDING HEAVY SOCKS FOR ATHLETES**

No. SS. Country knit, wool mixture; ribbed and very full in leg to allow for turnover. Supplied in either white or gray. Particularly suitable for camping, also for tramping. . . . . Pair, \$1.00

**COLORS**

STOCK COLORS—ALL PLAIN COLOR STOCKINGS carried in stock in Black, Navy Blue, and Maroon. ALL STRIPED STOCKINGS carried in stock, with one stripe 4 inches wide around calf, in following color combinations. Second color indicates calf stripe.

BLACK AND SCARLET MAROON AND WHITE BLACK AND ORANGE NAVY AND WHITE

SPECIAL ORDERS—ALL PLAIN COLOR STOCKINGS (except No. 4R) supplied in any color on special orders without extra charge. ALL STRIPED STOCKINGS (except No. 4RC) supplied with any style striping and in any colors (not more than two colors) on special orders without extra charge.

N. B.—Three different shades are sometimes called RED. They are Scarlet, Cardinal, and Maroon. Where RED is specified on order Cardinal will be supplied.

**SPALDING LEATHER AND WORSTED BELTS**

**Spalding "Special" Leather Foot Ball Belts**

No. 400. Black leather, 1 3/4-inch, specially shaped for athletic use, particularly foot ball. Heavy harness buckle. . . . . Each, \$1.00

No. 801. Fine 1 1/2-inch leather, Tan or Black. Heavy harness buckle. Each, \$1.00

No. 800. Tan or Black leather, 1 3/4-inch wide. Fine harness buckle. Each, 85c. ★ \$9.20 Doz.

No. 725. 1 1/4-inch, heavy leather, heavy nickeled harness buckle. Tan, Orange or Black. . . . . Each, 75c. ★ \$8.10 Doz.

No. 754. 1 1/4-inch, nickel harness buckle. Tan or Black. . . . . Each, 60c.



No. 400



No. 801

**Spalding Leather Wrist Supporters**

No. 400. Genuine pigskin, lined, in improved English slitted style. . . . . Each, \$1.00

No. 200. Solid belt leather, Tan or Black, double strap-and-buckle. . . . . " .60

No. 300. Solid belt leather, Tan or Black, laced fastening. . . . . " .25

No. 100. Solid belt leather, Tan or Black, single strap-and-buckle. . . . . " .35

No. 50. Grain leather, lined, single strap-and-buckle. . . . . " .50

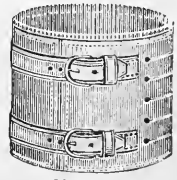

No. 400

Prices printed in italics opposite items marked with ★ will be quoted only on orders for one-half dozen or more. Quantity prices NOT allowed on items NOT marked with ★

ALL PRICES SUBJECT TO CHANGE WITHOUT NOTICE. ALL ORDERS WILL BE ACCEPTED ONLY SUBJECT TO OUR ABILITY TO SUPPLY THE GOODS. PRICES SHOWN ARE THOSE IN EFFECT ON DATE NOTED BELOW.



## SPALDING PLAIN WORSTED JERSEYS

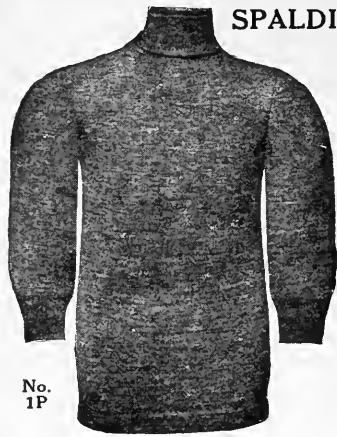

No. 1P

Showing Regular Roll Collar as on Nos. 1P, 10P, 12P, 14P and 15P.

lar. Good quality worsted. Solid colors. Each, \$3.25 ★ \$36.00 Doz.  
 No. 12PV. Furnished in V-neck; otherwise same as No. 12P.  
 Each, \$3.25 ★ \$36.00 Doz.  
 No. 14P. Regular roll collar. Worsted. Solid stock colors: Navy Blue, Black, Gray, and Maroon only. No special orders.  
 Each, \$2.75 ★ \$30.00 Doz.  
 No. 15P. Regular roll collar; lighter quality worsted than No. 14P. Solid stock colors: Navy Blue, Black, Gray, and Maroon only. No special orders.  
 Each, \$2.50 ★ \$27.00 Doz.  
 Any style striping on sleeves or around chest, or both, on Nos. 1P, 1PF, 10P and 10PF jerseys. . . . . 25c. each, extra ★ \$2.70 Doz.  
 Following sizes carried in stock regularly in all qualities: 28 to 46 inch chest. We allow two inches for stretch in all our jerseys and sizes are marked accordingly. It is suggested, however, that for very heavy people a size about two inches larger than coat measurement be ordered to insure a comfortable fit.

A very unprecedented situation on dye stuffs exists at present in this country, owing to the war. We have used every possible effort to safeguard our customers, but we CANNOT GUARANTEE FAST COLORS in our knit goods product, as has been our former custom. A. G. SPALDING & BROS.



No. 1PF

Showing Straight Low Collar as on Nos. 1PF, 10PF and 12PF.

**STOCK COLORS—PLAIN COLORS**—We carry in stock in our line of solid color worsted jerseys listed on this page, in following colors: NAVY BLUE, GRAY, BLACK, MAROON.

**SPECIAL ORDERS**—We also furnish any other colors on special orders, without extra charge except on Nos. 14P and 15P, which are furnished in stock colors only.

**SPECIAL NOTICE**—We will furnish any of the above jerseys, except Nos. 14P and 15P, with one color body and another color (not striped) collar and cuffs in any colors (not more than two colors in any garment), at no extra charge.

**N.B.**—Three different shades are sometimes called RED. They are Scarlet, Cardinal and Maroon. Where RED is specified on order Cardinal will be supplied.

**JERSEYS WITH NECKLACE**—Nos. 1P, 1PF, 10P, 10PF, 12P, or 12PF Jerseys (listed on this page), with necklace stripe of any other color supplied on special orders, at an extra charge of \$1.00 a garment.

**WOVEN LETTERS OR NUMERALS**—We weave into our best grade Jerseys, Nos. 1P and 1PF, Letters or Numerals in special colors as desired. Prices quoted on application. Designs submitted.

### Spalding Cotton Jerseys

No. 5. Light weight cotton; roll collar, full length sleeves. Colors: Black, Navy Blue, Gray. Ea., \$1.25 ★ \$13.50 Doz.  
 No. 6. Cotton, good quality, fashioned; roll collar, full length sleeves. Colors: Black, Navy Blue, Gray, and Maroon. Any other colors supplied on special order . . . . . Each, \$1.50 ★ \$16.20 Doz.  
 No. 6X. Cotton. As No. 6 with striped sleeves in following combinations. Navy with White or Red Stripe; Black with Orange or Red Stripe; Maroon with White Stripe. Other colors on special orders only. . . . . Each, \$1.75

*The prices printed in italics opposite items marked with ★ will be quoted only on orders for one-half dozen or more at one time. Quantity prices NOT allowed on items NOT marked with ★*

**ALL PRICES SUBJECT TO CHANGE WITHOUT NOTICE. ALL ORDERS WILL BE ACCEPTED ONLY SUBJECT TO OUR ABILITY TO SUPPLY THE GOODS. PRICES SHOWN ARE THOSE IN EFFECT ON DATE NOTED BELOW.**



**SPALDING REVERSIBLE COLLAR SWEATERS**

The Sweater, as the athletic garment par excellence, has achieved its position through sheer merit and to-day it is valued more than ever, by those who want comfort when outdoors in any kind of weather.

- No. RSP. (See cut below.) Raglan sleeves and reversible collar. Heaviest weight, special quality worsted. Pearl buttons. Two pockets. . . . . Each, **\$16.50** ★ *\$180.00 Doz.*
- No. AWJP. Regular sleeves, heaviest weight special quality worsted, with pocket on each side. (See cut below.) . . . . . Each, **\$16.50** ★ *\$180.00 Doz.*
- No. WJP. Highest quality special heavy weight worsted, with pocket on each side. Model of No. AWJP, but lighter weight. . . . . Each, **\$11.00** ★ *\$120.00 Doz.*
- No. WWP. Heavy weight, good quality worsted, backed with wool. Model of No. AWJP. Pocket on each side. . . . . Each, **\$9.50** ★ *\$102.00 Doz.*

**COLORS.** Supplied from stock in either Gray, Maroon, White, Cardinal, or Navy. Supplied in any other color, on special order, at no extra charge. Supplied with one color body and another color (not striped) collar and cuffs (any colors) on special orders, at no extra charge.

**STOCK SIZES,** all Sweaters, 28 to 46 inches. We allow four inches for stretch in all our sweaters, and sizes are marked accordingly. It is suggested, however, that for very heavy people a size about two inches larger than coat measurement be ordered to insure a comfortable fit.

**SPALDING ALPACA—Natural Color, NOT DYED—SWEATERS**

No. TSP. (See cut below.) Made from finest alpaca goat yarn. Medium weight. In solid Grays, Browns and Tans; the natural colors of the fleece. Pearl buttons. Two pockets. . . . . Each, **\$16.50** ★ *\$180.00 Doz.*

*Prices noted in italics opposite ★ are quoted only on orders for one-half dozen or more. All prices subject to change without notice.*



No. RSP

No. TSP

No. AWJP

**SPECIAL NOTICE.—ON ACCOUNT OF THE PRESENT UNSATISFACTORY DYE-STUFFS SITUATION, WE ARE UNABLE TO GUARANTEE THE FAST COLOR OF ANY DYED KNIT GOODS. ALPACA NATURAL COLOR SWEATERS, NO. TSP, ARE NOT DYED AND ARE FAST COLOR. ALL PRICES SUBJECT TO CHANGE WITHOUT NOTICE. ALL ORDERS WILL BE ACCEPTED ONLY SUBJECT TO OUR ABILITY TO SUPPLY THE GOODS. PRICES SHOWN ARE THOSE IN EFFECT ON DATE NOTED BELOW.**





## SPALDING REVERSIBLE COLLAR SWEATERS

FOR AUTOMOBILING, SPORTS AND GENERAL WEAR

The most convenient and comfortable style Sweaters for all around wear in all weathers

No. WJJP. High reversible collar. Light weight, best quality worsted, with pocket on each side. (See cut below) . . . . . Each, **\$10.00** ★ *\$108.00 Doz.*  
 No. MJJP. Spalding Jumbo Stitch Sweater. Good quality extra heavy wool in the popular "Jumbo" stitch. Supplied only in Navy Blue, Maroon or Gray. No special orders. Two pockets. Pearl buttons. (See cut below) . . . . . Each, **\$10.00** ★ *\$108.00 Doz.*

No. 2JP. Good quality all wool, Shaker knit, instead of fine worsted. Pearl buttons. Supplied in Gray, Navy Blue, Maroon, Black, Dark Green or Heather Brown only. No special orders. Each, **\$7.50** ★ *\$81.00 Doz.*  
 No. WPC. Good quality wool with cotton mixture. Model of No. MJJP, but Shaker knit. In Gray, Navy Blue or Maroon. No special orders. Each, **\$6.00** ★ *\$64.80 Doz.*

*Above sweaters are all made with the Spalding reversible style collar, as shown in cuts on this page. See also sweaters on Page 17, which are also made with the Spalding reversible style collar.*

## SPALDING COAT STYLE BUTTON FRONT SWEATERS

No. VGP. Best quality worsted, heavy weight, pearl buttons. Two pockets. . . . . Each, **\$9.50** ★ *\$102.00 Doz.*  
 No. DJP. Fine worsted, standard weight, pearl buttons, fine knit edging. Two pockets. . . . . **8.00** ★ *86.40*  
 No. VV. Good quality worsted, backed with wool. Model of No. VGP, but no pockets. Supplied in Gray, Navy Blue, Maroon or White. No special orders. . . . . Each, **\$6.00** ★ *\$64.80 Doz.*

**SPECIAL NOTICE.**--Above sweaters (except Nos. WPC, 2JP, and MJJP) with one color body and another color (not striped) collar and cuffs (in any colors) on special orders, at no extra charge.

**STOCK SIZES.**--28 to 46 inches. We allow four inches for stretch in all our sweaters and sizes are marked accordingly. It is suggested, however, that for people who are at all stout, a size about two inches larger than cost measurement be ordered to insure a comfortable fit.

**STOCK COLORS.**--All sweaters listed on this page (except Nos. WPC, 2JP, and MJJP) carried in stock in GRAY, WHITE, NAVY BLUE, MAROON, and CARDINAL.

**SPECIAL ORDERS.**--In addition to stock colors mentioned, we supply these sweaters (except Nos. WPC, 2JP, and MJJP) in any other color, on special order, at no extra charge. N. B.--Three different shades are sometimes called RED; They are Scarlet, Cardinal, and Maroon. Where RED is specified on order we supply Cardinal.

*The prices printed in italics opposite items marked with ★ will be quoted only on orders for one-half dozen or more.*  
**ALL PRICES SUBJECT TO CHANGE WITHOUT NOTICE. ALL ORDERS WILL BE ACCEPTED ONLY SUBJECT TO OUR ABILITY TO SUPPLY THE GOODS. PRICES SHOWN ARE THOSE IN EFFECT ON DATE NOTED BELOW.**

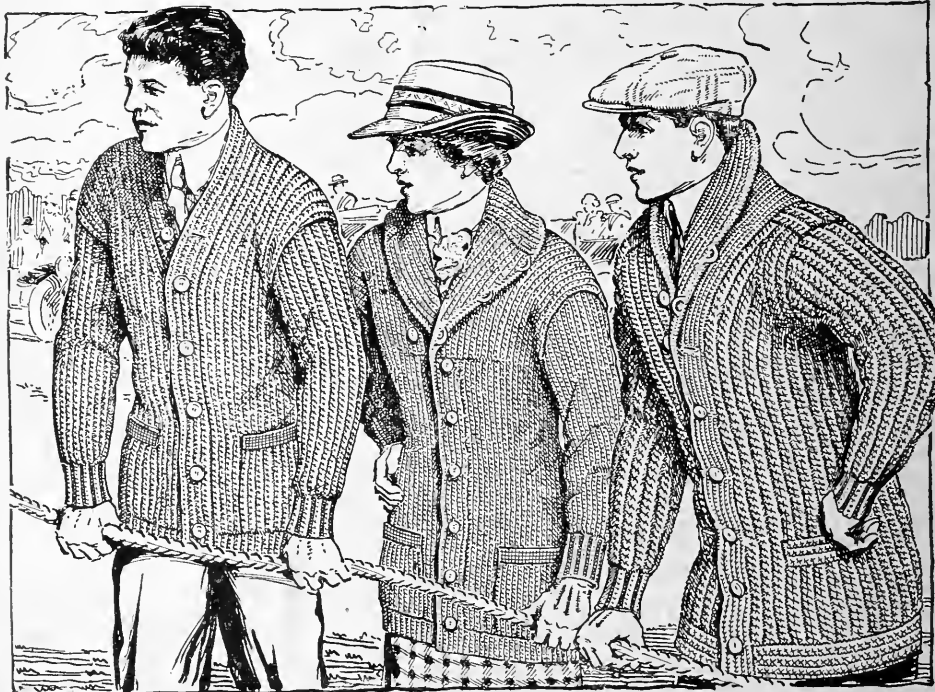

No. VGP

No. WJJP

No. MJJP

**SPECIAL NOTICE.**--ON ACCOUNT OF THE PRESENT UNSATISFACTORY DYE STUFFS SITUATION, WE ARE UNABLE TO GUARANTEE THE FAST COLOR OF ANY DYED KNIT GOODS. ALPACA, NATURAL COLOR SWEATERS, NO. TSP, ARE NOT DYED AND ARE FAST COLOR.



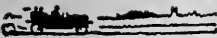

# SWEATERS

## SPALDING "PAL" SWEATER

No. BWJG. Best quality worsted, good weight, no button front, but made with reversible style collar as on our No. A WJP Sweater listed on Page 17. Pearl buttons. (See cut below). . . . . Each, **\$9.50** ★ *\$102.00 doz.*

## SPALDING VEST COLLAR SWEATERS. (See cut No. AG below)

No. AG. Highest quality heavy weight worsted. . . . . Each, **\$10.00** ★ *\$108.00 doz.*  
No. BG. Best quality worsted, good weight. . . . . **8.00** ★ *86.40*

## THE SPALDING SPECIAL TRAINING SWEATERS

No. AA. Heaviest sweater made; 9-inch roll collar; extra long and full. Body, arms and neck put together by hand, not simply stitched up on a machine, as are the majority of garments sold as regular made goods. Each, **\$11.00** ★ *\$120.00 doz.*  
No. A. Special weight, lighter than No. AA, but quality and general makeup identical otherwise. Each, **\$9.50** ★ *\$102.00 doz.*  
No. B. Heavy weight, but lighter than No. A. Identical otherwise. . . . . **8.00** ★ *86.40*

## SHAKER KNIT ROLL COLLAR SWEATER

No. 3. Good quality all wool sweater. Shaker knit, well made throughout. Sizes 30 to 46 inches. Standard weight, lighter than No. B. Roll collar. Carried in stock in Gray, Navy, Black, and Maroon. No special orders. Each, **\$5.00** ★ *\$54.00 doz.*

**SPECIAL ORDERS**--We also supply these sweaters (except No. 3) in any other color, on special order, at no extra charge. N. B.--Three shades are sometimes called R.E.D. They are Scarlet, Cardinal, Maroon. Where Red is specified on order, we supply Cardinal.

**SPECIAL NOTICE**--Solid color sweaters, (except No. 3) with one color body and another color (not artificial) collar and cuffs furnished in any of the colors noted, on special order, at no extra charge.

**STOCK SIZES**--28 to 46 inches chest. We allow four inches for stretch in all our sweaters, and sizes are marked accordingly. It is suggested, however, that for very heavy men, a size about two inches larger than coat measurement be ordered to insure a comfortable fit.

**STOCK COLORS**--All sweaters listed on this page (except No. 3) are carried in stock in Gray, White, Navy, Maroon, and Cardinal.

*Prices printed in italics opposite items marked with ★ will be quoted only on orders for one-half dozen or more at one time. Quantity prices NOT allowed on items NOT marked with ★*

**ALL PRICES SUBJECT TO CHANGE WITHOUT NOTICE. ALL ORDERS WILL BE ACCEPTED ONLY SUBJECT TO OUR ABILITY TO SUPPLY THE GOODS. PRICES SHOWN ARE THOSE IN EFFECT ON DATE NOTED BELOW.**

**SPECIAL NOTICE**--On account of the present unsatisfactory Dye Stuffs situation we are unable to guarantee the fast color of any dyed knit goods.

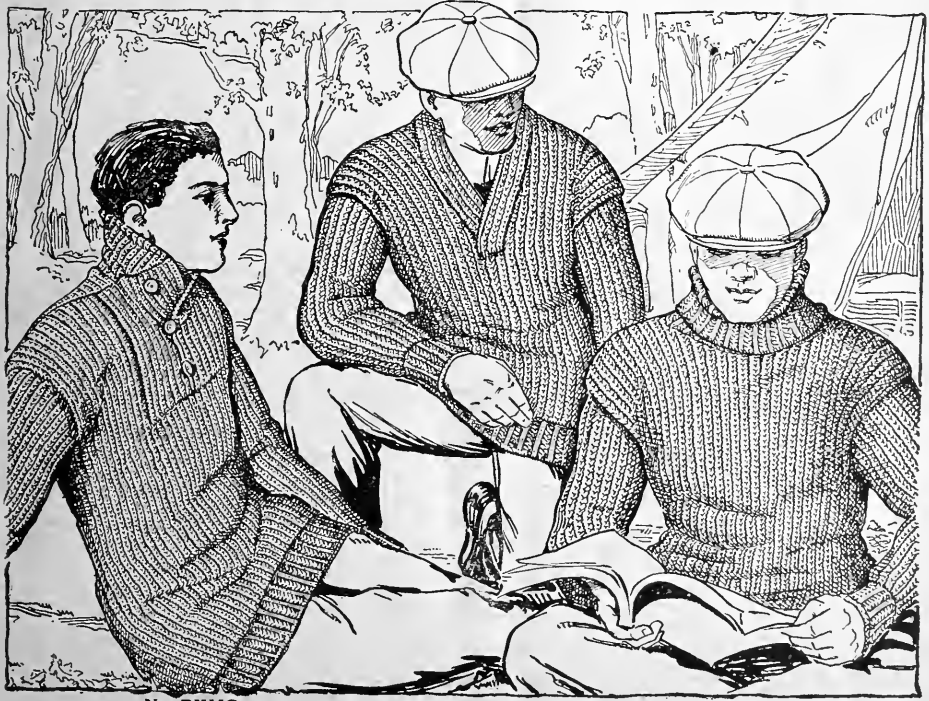

No. BWJG

No. AG

No. AA

# FOOT BALLS



## SPALDING OFFICIAL No. L ASSOCIATION "SOCCER" FOOT BALL



No. L

No. L. The case of our No. L Ball is constructed in four sections with capless ends, neat in appearance and very serviceable. Material and workmanship are of highest quality and fully guaranteed. Each ball is packed complete in sealed box, with pure Para rubber (not compounded) guaranteed bladder, rawhide lace and lacing needle. Contents guaranteed if seal is unbroken. . . . . Each, \$7.50

WE GUARANTEE every Spalding Foot Ball to be perfect in material and workmanship and correct in shape and size when inspected at our factory. If any defect is discovered during the first game in which it is used, or during the first day's practice use, and, if returned at once, we will replace same under this guarantee. We do not guarantee against ordinary wear nor against defect in shape or size that is not discovered immediately after the first day's use. Owing to the superb quality of every Spalding Foot Ball, our customers have grown to expect a season's use of one ball, and at times makes unreasonable claims under our guarantee, which we will not allow.

*A. J. Spalding & Bros*

If game is to be played on wet grounds or during rainy weather use Spalding "Dri-Foot" on the ball (keep oil away from rubber bladder). . . . . Can, 10 cents

## SPALDING

### "OLYMPIC" CHAMPIONSHIP "SOCCER" FOOT BALL No. G

Reg. U. S. Pat. Off.  
No. G. Made in our Leeds factory, England; hand stitched throughout, twelve-piece special tanned English leather cover. Guaranteed bladder. Each, \$7.00

The Spalding No. G Ball has been used exclusively during the past four seasons—1913-14, 1914-15, 1915-16, 1916-17, in all semi-finals and finals of the United States Foot Ball Association.



No. G

### Spalding Official "Gaelic" Foot Ball

No. K. Made with eight sections and "black button" ends. Complete in sealed box, with pure Para rubber (not compounded) guaranteed bladder, rawhide lace and lacing needle. Supplied on special order, not carried in stock. . . . . Each, \$6.50

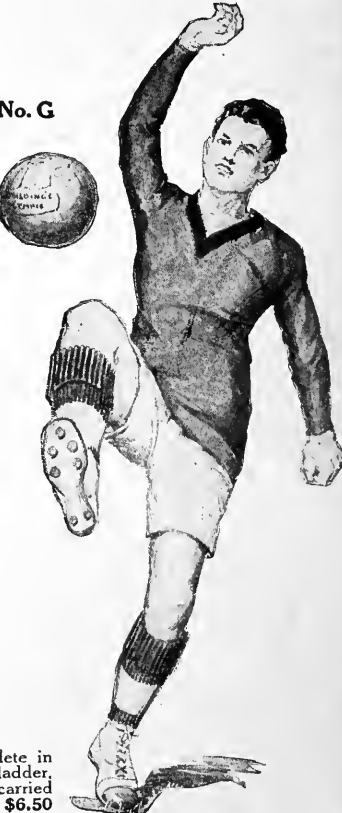

ALL PRICES SUBJECT TO CHANGE WITHOUT NOTICE. ALL ORDERS WILL BE ACCEPTED ONLY SUBJECT TO OUR ABILITY TO SUPPLY THE GOODS. PRICES SHOWN ARE THOSE IN EFFECT ON DATE NOTED BELOW.



# FOOT BALLS

## ASSOCIATION FOOT BALLS

Note Special Explanation of Foot Ball Guarantee on Page 20.



No. O

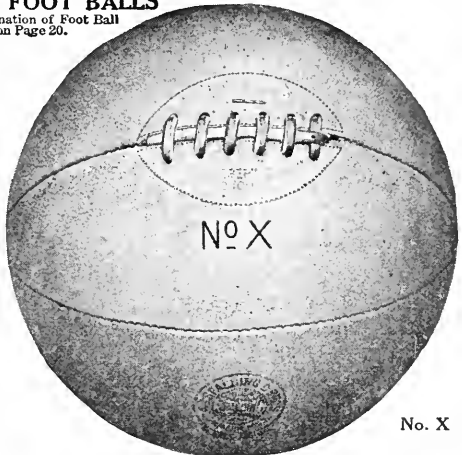

No. X

**No. O. Spalding "Army-Navy" Soccer Ball.** Regulation size. Case is made of best grade English leather with guaranteed bladder. Complete with rawhide lace and lacing needle. . . . . Each, **\$5.00**

**Canvas Cover for Carrying Inflated Soccer Ball No. O3.** Good quality canvas, with leather handles and strap and buckle fastening. . . . . Each, **\$1.50**

**Spalding Association Foot Ball Goal Nets.** No. O. Heavy tarred nets, pegs, guys, and everything necessary except the posts and cross pieces, which can be put up by any carpenter. . . . . Set, complete, **\$18.00**

**No. 55R. SPALDING'S OFFICIAL SOCCER FOOT BALL GUIDE.** Edited by Thomas W. Cahill. Copy, 25c.

**No. X.** Slightly under regulation size. Case of good quality English leather. Guaranteed bladder. Ea., **\$3.50**

### Guaranteed Association Foot Ball Bladders

- No. OB. For Nos. L and G Balls. . . . . Each, **\$1.00**
- No. A. For No. O Ball. . . . . " **.90**
- No. SB. For No. X Ball. . . . . " **.75**

### Spalding Soccer Foot Ball Shoes



**No. RS. Spalding Soccer Shoe.** Drab chrome tan leather, with double thickness box toe. Box toe will hold up under severest usage. Round leather cleats placed according to latest English model. . . . . Pair, **\$6.00** ★ **\$66.00 Doz. Pairs**

**SPECIAL NOTICE**—Spalding "Dri-Foot" used on uppers and soles adds greatly to wear of foot ball shoes. Can, 10c. See Page 27 for Tights and Trunks. Stockings, all styles, listed on Page 15.

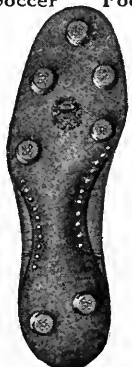

Show the arrangement of cleats on Nos. RS and U Shoes



**No. U. Spalding Soccer Shoe.** Drab horsehide, with special leather box toe and round leather cleats. . . . . Pair, **\$5.00** ★ **\$54.00 Doz. Pairs**  
Soccer Knickerbockers. Special order only. Not carried in stock.

**Spalding Soccer Shirts.** Supplied on special order only. Not carried in stock. Prices and particulars on application. See Page 26 for Striped Knit Shirts.



**Spalding Skull Caps.** Special Orders Only. Any Colors.  
**No. SBS.** Worsted, heavy weight, striped alternate, or solid colors. . . . . Each, **\$1.00**  
**No. SCS.** Worsted, light weight, striped alternate, or solid colors. . . . . **.50**

### Spalding Association Foot Ball Shin Guards

**No. 40.** Leather covered, well padded, with real rattan reeds and cotton felt; ankle pads and leather straps 11 inches long. . . . . Pair, **\$2.50** ★ **\$27.00 Doz. Pairs**  
**No. F.** Canvas covered, otherwise similar to No. 40. . . . . 1.00 ★ 10.80

**No. G.** Canvas covered, no ankle pads, real reed padding and leather tongue; no straps; worn inside stockings. . . . . Pair, **50c.** ★ **\$5.40 Doz. Pairs**

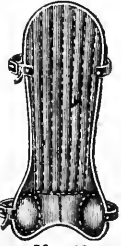

No. 40

The prices printed in italics opposite items marked with ★ will be quoted only on orders for one-half dozen pairs or more at one time. Quantity prices NOT allowed on items not marked with ★

ALL PRICES SUBJECT TO CHANGE WITHOUT NOTICE. ALL ORDERS WILL BE ACCEPTED ONLY SUBJECT TO OUR ABILITY TO SUPPLY THE GOODS. PRICES SHOWN ARE THOSE IN EFFECT ON DATE NOTED BELOW.

# BASKET BALL



## SPALDING OFFICIAL BASKET BALL

No. M. Cover is made in four sections, with capless ends, and of finest and most carefully selected pebble grain leather, special tanned. Extra heavy bladder, made especially for this ball, of extra quality pure Para rubber (not compounded). Each ball packed complete, in sealed box, with rawhide lace and lacing needle, and guaranteed perfect in every detail. . . . . Each, \$9.00



No. M

**WE GUARANTEE** this ball to be perfect in material and workmanship and correct in shape and size when inspected at our factory. If any defect is discovered during the first game in which it is used, or during the first day's practice use, and, if returned at once, we will replace same under this guarantee. We do not guarantee against ordinary wear nor against defect in shape or size that is not discovered immediately after the first day's use. Owing to the superb quality of our No. M Basket Ball, our customers have grown to expect a season's use of one ball, and at times make unreasonable claims under our guarantee, which we will not allow.

*A. J. Spalding & Bros.*



No. M-2

### "SPECIAL" No. M-2 BASKET BALL

No. M-2. Superior to any other except our No. M Official Ball. Pebble grain leather case. Extra heavy guaranteed pure Para rubber bladder (not compounded). Complete in box, with rawhide lace and lacing needle. . . Each, \$7.00



No. H

### SPALDING No. H BASKET BALL

No. H. Made from durable pebbled grain leather. Correct in weight and perfect in shape. Complete with guaranteed bladder, lace and lacing needle. . . . Each, \$6.00

ALL PRICES SUBJECT TO CHANGE WITHOUT NOTICE. ALL ORDERS WILL BE ACCEPTED ONLY SUBJECT TO OUR ABILITY TO SUPPLY THE GOODS. PRICES SHOWN ARE THOSE IN EFFECT ON DATE NOTED BELOW.

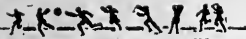

# BASKET BALL



No. PGO

No. 18

### Spalding Playground Basket Balls

### Spalding Practice Basket Balls

No. PGO. Pebbled grain leather. Specially protected seams for playground use. Regulation size. Guaranteed bladder, lace and lacing needle. Each, \$7.00  
 No. PKO. Good quality leather, protected seams. For playground use. Complete with guaranteed bladder, lace and lacing needle. Each, \$5.00

No. 18. Good quality leather cover. Guaranteed bladder, lace and lacing needle. Each, \$4.00

### Spalding Canvas Holder

No. 01. For carrying an inflated basket ball. Useful for teams to carry properly inflated ball. Each, \$1.50

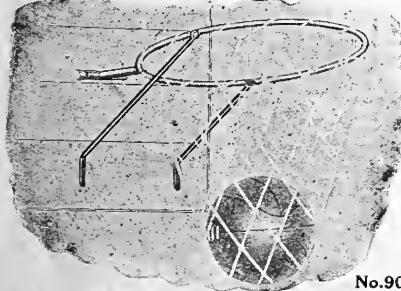

### SPALDING BASKET BALL GOALS

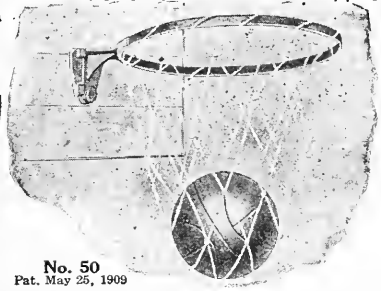

No. 90. Official Goals. So far as we know this is the only drop-forged goal made. Practically unbreakable. Extra heavy nets. Should be used in all gymnasiums. Pair, \$5.00

No. 70. Practice Goals. Japanned. Complete with nets. Pair, \$3.50

Fitting on No. 50 Goals

No. 50 Pat. May 25, 1909

No. 50. Detachable Goals. Detached readily from the wall or upright, leaving no obstruction to interfere with other games or general gymnasium work. Pair, \$7.50

### Spalding Nets, Separate, for Goals

Heavy twine; hand knitted; white. The same as supplied with No. 90 Goals. Pair, 50c.

### Spalding Basket Ball Score Books

- No. 10. Paper cover, 10 games. . . . . Each, 10c.
- No. 11. Cloth cover, 25 games. . . . . " 25c.
- No. A. Collegiate, paper cover, 10 games. . . . . " 10c.
- No. B. Collegiate, cloth cover, 25 games. . . . . " 25c.
- No. W. For Women. . . . . " 25c.

### Spalding Bladders

Guaranteed Quality

No. OM. For Nos. M, M2, H, PGO and PKO balls. Each, \$1.50  
 No. A. For No. 18 ball. . . . .90



### SPALDING BASKET BALL WHISTLES



No. 4



No. 3

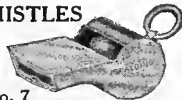

No. 7

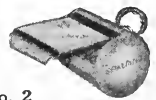

No. 2

No. 4. Horn Whistle, made of heavy metal. Each, \$1.00  
 No. 3. Nickel-plated, special deep tone. . . . .35

No. 7. Nickel-plated, heavy metal whistle. The most satisfactory and loudest of any. . . . . Each, 50c.  
 No. 2. Very reliable and popular design. . . . . 25c.

Stop Watches and other Whistles listed on Page 37. See Page 30 for Basket Ball Shoes

ALL PRICES SUBJECT TO CHANGE WITHOUT NOTICE. ALL ORDERS WILL BE ACCEPTED ONLY SUBJECT TO OUR ABILITY TO SUPPLY THE GOODS. PRICES SHOWN ARE THOSE IN EFFECT ON DATE NOTED BELOW.

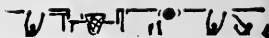

## Spalding Basket Ball Knee Pads and Protectors

No. EF. Combined elbow pad and elastic bandage. Padded with felt strips. The complete woven elastic bandage furnishes support to the elbow while the special arrangement of the felt strips provides protection against bruises. Pair, **\$2.00** ★ *\$21.60 Doz. prs.*



No. EF

No. KF. Same as No. EF, but for knee instead of elbow. Pair, **\$2.00** ★ *\$21.60 Doz. prs.*



No. 9KP

No. 9KP. Solid leather knee cap, heavily padded with felt. Conforms to curve of knee. Leather strap-and-buckle for fastening. Pair, **\$4.00** ★ *\$43.20 Doz. prs.*

No. KP. Made entirely of felt, otherwise similar to 9KP. Pair, **\$3.00** ★ *\$32.40 Doz. prs.*

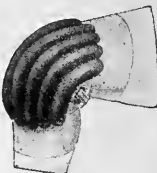

No. KE

No. KE. Combined leather covered roll style knee pad with elastic reinforcement at either end which holds pad in place and gives additional support. Pair, **\$3.00** ★ *\$32.40 Doz. prs.*

No. KPX. Soft leather knee cap, felt padded, with wide elastic bandage below knee for extra support, and elastic strap above to hold in place. Pair, **\$2.00** ★ *\$13.60 Doz. prs.*



KPX

No. KC. Combined canvas covered knee pad lined with felt, and with elastic reinforcement at either end. Pair, **\$1.25** ★ *\$13.50 Doz. prs.*

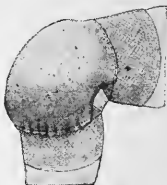

No. KC

### Spalding

### Thumb Protector

No. T. Substantial support for thumb and wrist; will answer for either right or left hand. Each, **75c.**



No. T

## Spalding Special Basket Ball Pants

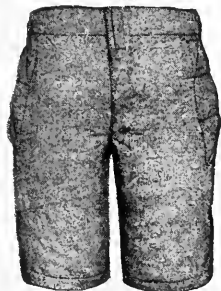

No. 6B



No. 5B

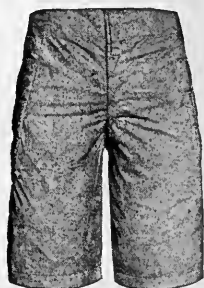

No. 7B

No. 6B. Good quality, Gray or White flannel, padded lightly on hips; very loose fitting. Pair, **\$2.50** ★ *\$27.00 Doz. prs.*

No. 5B. Heavy Brown or White canvas, padded lightly on hips; very loose fitting. " **1.50** ★ *16.20*

No. 7B. White silesia, hips padded; loose fitting. " **1.00** ★ *10.80*

Stripes down sides of any of above pants, extra. Pair, **25c.** ★ *\$2.70 Doz. prs.*

See Page 15 for Stockings. Page 14 for Supporters. Pages 26, 27 for Sleeveless Shirts, Knee Tights, etc. Basket Ball Shoes, Page 30. Women's Gymnasium Suits suitable for Girls' Basket Ball Teams, Pages 59, 60.

The prices printed in italics opposite items marked with ★ will be quoted only on orders for one-half dozen pairs or more. Quantity prices NOT allowed on items NOT marked with ★

ALL PRICES SUBJECT TO CHANGE WITHOUT NOTICE. ALL ORDERS WILL BE ACCEPTED ONLY SUBJECT TO OUR ABILITY TO SUPPLY THE GOODS. PRICES SHOWN ARE THOSE IN EFFECT ON DATE NOTED BELOW.





SPALDING INDOOR BASE BALLS



No. 1

We are using PATENT KAPOK FILLING (Pat. August 11, 1914), in Nos. 1 and 1X Indoor Balls, also in Nos. 14WB, 14-OPB, 12-OPB, 12PB, 14PB, 12PB and 9PB Playground Balls. This filling adds to the life of the ball, makes it more resilient, and so it will float.

No. 1. Size, 17 inches circumference. Special oil tanned leather cover.

Each, \$1.25

No. 2. Sheepskin cover, curled hair filling. Ea., \$1.00

No. 1X. Size, 14 inches circumference. For army games. Special oil tanned leather cover. Each, \$1.25

No. 10A. Size, 10 inches circumference; weight, 5 oz. Special oil tanned leather cover. Curled hair filled.

Each, \$1.00

No. 3. Sheepskin cover, curled hair filling. Ea., \$1.00



No. 14WB

Spalding Water and Beach Ball

No. 14WB. 14 inches. Made with specially prepared horse hide cover, impervious to moisture. Just the ball to use for water sports and play at beaches, camps, etc. Each, \$1.50



PLAYGROUND BALL—Outseam Type  
Style of Nos. 14-OPB and 12-OPB

Spalding Playground and Recreation Base Balls

No. 14-OPB. Outseam style; particularly for outdoor playground use. Size, 14 inches circumference. Horse hide cover.

Each, \$1.50

No. 12-OPB. 12 inches circumference. Otherwise like No. 14-OPB. . . . . Each, \$1.50

No. 17PB. Regularseam. Size, 17 inches circumference. Special horse hide cover. Ea., \$1.25

No. 14PB. 14 inches circumference. Wound a little firmer, but same quality as No. 17PB.

Each, \$1.25



PLAYGROUND BALL—Regular Seam  
Style of Nos. 17PB, 14PB, 12PB, 9PB and 33

No. 12PB. 12 inches circumference. Not official in size, but same quality as 17PB and 14PB balls. Each, \$1.25  
No. 9PB. Specially for use on municipal playgrounds, horse hide cover, but not official in size. . . . . 1.00  
No. 33. White horse hide cover, small size. . . . . .50

Balls for General Recreation

No. 6. Sheepskin cover, 14 in. Each, 50c. No. 9R. Imitation leather cover.  
No. 9. Sheepskin cover, 11 1/2 in. . . . . 25c. Size, 8 1/2 in. . . . . Each, 10c.

SPALDING INDOOR BASE BALL BATS—(Suitable also for Playground Ball)

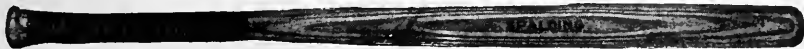

No. 0. Selected second growth ash. Tape wrapped grip. Each, 50c. No. 2. Grip not wrapped. Each, 40c.

SPALDING INDOOR BASES—(Suitable also for Playground Ball)

No. 1. Canvas. 10-ounce duck, unfilled. . . . . Set of 3, \$2.50  
No. 2. Canvas. 8-ounce duck, unfilled. . . . . 2.00  
No. 5. Quilted, stiff canvas, without straps. . . . . 1.25  
No. 3. Indoor Rubber Home Plate. . . . . Each, .50

SPALDING KNEE PROTECTORS—(Suitable also for Playground Ball)

No. KE. Leather covered, roll style padding; with elastic knee bandage. No. KC. Canvas covered knee pad, heavy felt lined; with elastic band, etc.  
Pair, \$3.00 ★ \$32.40 Doz. Pks. Pair, \$1.25 ★ \$13.50 Doz. Pks.



No. KE Knee Pad



No. KC Knee Pad

Complete Catalogue of Base Ball Equipment sent on request.

The prices printed in italics opposite items marked with ★ will be quoted only on orders for one-half dozen pairs or more. Quantity prices NOT allowed on items NOT marked with ★

ALL PRICES SUBJECT TO CHANGE WITHOUT NOTICE. ALL ORDERS WILL BE ACCEPTED ONLY SUBJECT TO OUR ABILITY TO SUPPLY THE GOODS. PRICES SHOWN ARE THOSE IN EFFECT ON DATE NOTED BELOW.



**SPALDING KNIT ATHLETIC SHIRTS**



**No. 10E**

**Spalding Sleeveless Shirts**

**No. 10E.** Sleeveless. Best quality worsted. Carried in stock in Gray White, Navy Blue, Maroon, and Black. Each **\$2.75** ★ **\$29.70 Doz.**  
**No. 600.** Worsted. Carried in stock in Gray, White, Navy Blue, Maroon, and Black. Each, **\$2.00** ★ **\$21.60 Doz.**

Each, **\$2.00** ★ **\$21.60 Doz.**

**No. 700.** Sleeveless. Worsted. Light weight. Carried in stock in Gray, White, Navy Blue, Maroon, and Black. Each, **\$1.75** ★ **\$18.90 Doz.**

**No. 6E.** Sanitary cotton. Bleached White, Navy Blue, Black, Maroon or Gray. Each, **50c.** ★ **\$5.40 Doz.**

**Spalding**

**Quarter Sleeve Shirts**

**No. 6F.** Sanitary cotton. Bleached White, Navy Blue or Black. Each, **50c.** ★ **\$5.40 Doz.**

Each, **50c.** ★ **\$5.40 Doz.**



**No. 601NV.**

**No. 601NV.** Worsted. Quarter sleeves. V-neck. With stripes around neck and sleeves. Supplied on special orders only, one color body, two colors striping (any colors). Each, **\$2.50** ★ **\$27.00 Doz.**

**No. 601N.** Same as No. 601NV, but round instead of V-neck. Special orders only. Each, **\$2.50** ★ **\$27.00 Doz.**



**No. 600S**

**Spalding Sleeveless Shirts**

**No. 600S.** Worsted, with 6-in. stripe around chest, carried in stock in following combinations of colors: Navy with White stripe, Black with Orange stripe, Maroon with White stripe, Black with Red stripe, Gray with Cardinal stripe. Each, **\$2.25** ★ **\$24.30 Doz.**

Each, **\$2.25** ★ **\$24.30 Doz.**

**No. 700S.** Worsted, light weight. Six inch stripe around chest. Color combinations similar to No. 600S. Special order only. Each, **\$2.00** ★ **\$21.60 Doz.**

Each, **\$2.00** ★ **\$21.60 Doz.**

**No. 6ES.** Sanitary cotton, solid color body, with 6-in. stripe around chest, in same combinations of colors as No. 600S. Each, **\$1.00** ★ **\$10.80 Doz.**



**No. 600V**

**No. 600V.** Worsted. Sleeveless. V-neck. Supplied on special orders only, any color. Each, **\$2.00** ★ **\$21.60 Doz.**

Each, **\$2.00** ★ **\$21.60 Doz.**



**No. 6WD**

**Spalding Shirts, with Sash**

**No. 6WD.** Sanitary cotton, sleeveless, with woven sash. Same combinations of colors as No. 600S. Not carried in stock. Each, **\$1.50** ★ **\$16.20 Doz.**

Each, **\$1.50** ★ **\$16.20 Doz.**



**No. 1L**

**Spalding Leotards**

For

**Gymnasium Use, Wrestling, etc.**  
 Supplied on Special Order Only.

**No. 1L.** Combining athletic shirt and trunks. Best quality worsted. Any color. Supplied on special order only. . . . Each, **\$5.50**

**No. 10L.** Good quality worsted. Any color. Supplied on special order only. . . . Each, **\$4.50**

**No. 12L.** Worsted. Supplied on special orders only in any color. Each, **\$3.25**

Each, **\$3.25**

**STOCK SIZES; 26 to 46 inch chest.**

**SPECIAL ORDERS—All shirts listed on this page we furnish in any color on special order, at no extra charge. No more than two colors in any striped garment.**

**See Page 28 for Lettering, Emblems, etc.**

*The prices printed in italics opposite items marked with ★ will be quoted only on orders for one-half dozen or more at one time.*

**ALL PRICES SUBJECT TO CHANGE WITHOUT NOTICE. ALL ORDERS WILL BE ACCEPTED ONLY SUBJECT TO OUR ABILITY TO SUPPLY THE GOODS. PRICES SHOWN ARE THOSE IN EFFECT ON DATE NOTED BELOW.**





## SPALDING TIGHTS AND TRUNKS

STOCK SIZES: 24 to 42 inch waist. STOCK COLORS: Worsted knee and full tights and trunks, except where otherwise specified, Gray, White, Navy Blue, Maroon, and Black. Any other color on special orders, no extra charge.



No. 10B

### SPALDING KNEE TIGHTS

- No. 10B. Best quality worsted.  
Pair, \$2.75★\$29.70 Doz.
- No. 604. Good quality worsted.  
Pair, \$2.00★\$21.60 Doz.



No. 1A

### SPALDING FULL LENGTH TIGHTS

- No. 1A. Best worsted, full fashioned.  
Pair, \$5.50★\$59.40 Doz.
- No. WA. Special wrestling full tights. Specially reinforced. Special orders only.  
Pair, \$6.50
- No. 605. Good quality worsted.  
Pair, \$3.50★\$37.80 Doz.



No. 4

### SPALDING Y.M.C.A. TROUSERS

- No. 4. Flannel.  
Pair, \$2.50★\$27.00 Doz.



No. 2

SPALDING  
WORSTED TRUNKS  
No. 2. Good quality worsted;  
carried in stock in Navy or  
Black.Pr., \$1.75★\$18.90 Dz.



No. 14B

BOYS' KNEE PANTS  
No. 14B. Same quality as  
No. 4 Y. M. C. A. trousers,  
with stripe down side.  
Pair, \$1.50★\$16.20 Doz.

### SPALDING WRESTLING SUPPORTER

- No. WS. Mercerized silk  
elastic, strong and durable.  
Each, \$2.25

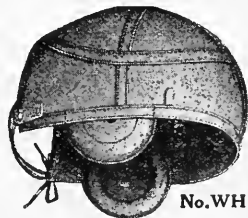

No. WH

SPALDING WRESTLING  
HEAD HARNESS  
No. WH. Always useful; some-  
times indispensable. \$5.00

Wrestling Mattresses listed on Page 49. Sweaters, Pages 17-19. Running and Jumping Shoes listed on Pages 38, 39. Supporters and Suspensories, Page 14. Basket Ball and Gymnasium Shoes, Page 30.  
See Page 28 for Prices on Lettering, Emblems, etc.

The prices printed in italics opposite items marked with ★ will be quoted only on orders for one-half dozen or more at one time. Quantity prices NOT allowed on items NOT marked with ★

ALL PRICES SUBJECT TO CHANGE WITHOUT NOTICE. ALL ORDERS WILL BE ACCEPTED ONLY SUBJECT TO OUR ABILITY TO SUPPLY THE GOODS. PRICES SHOWN ARE THOSE IN EFFECT ON DATE NOTED BELOW.  
PAGE 27—AUGUST 5, 1917



## SPALDING FELT LETTERS, NUMERALS, MONOGRAMS, EMBLEMS

Sewed on Spalding Shirts, Sweaters, Caps, etc.

The prices for different styles of lettering apply for either felt or cloth and include cost of sewing on Spalding garments or caps only if purchased at same time. Numerals are furnished in styles to correspond to letter. Order by number and style as shown in cuts to avoid misunderstanding.



No. 17 No. 18 No. 19

**Felt Letters**  
Sewed on our Hats, Caps, etc.  
Any Style Letters  
(See cuts 17, 18, 19)  
Each Retail Dz.  
1 in., 12c. \$1.39  
1 1/2 in., 13c. 1.47  
2 in., 15c. 1.62

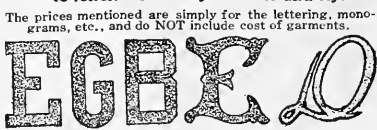

No. 1 Plain Style No. 6 Plain Style No. 2 Special No. 5 Fancy No. 3 Script

**No Stiffening on Back**

Size	Each	Retail	Size	Each	Retail
3 or 4 in.	18c.	\$1.95	9 or 10 in.	48c.	\$5.19
5 or 6 in.	26c.	2.81	11 or 12 in.	60c.	6.48
7 or 8 in.	36c.	3.89			

**Felt Letters and Numerals**  
Felt Lettering sewed on our garments, Either Block (No. 1), Special (No. 2), Fancy (No. 5), or Plain (No. 6), style (see cuts).  
**No Stiffening on Back**      **Buckram Pasted Back**

Size	Each	Retail	Size	Each	Retail
3 or 4 in.	13c.	\$1.11	3 or 4 in.	18c.	\$1.95
5 or 6 in.	18c.	1.95	5 or 6 in.	26c.	2.81
7 or 8 in.	24c.	2.60	7 or 8 in.	36c.	3.89
9 or 10 in.	30c.	3.24	9 or 10 in.	48c.	5.19
12 inch	36c.	3.89	11 or 12 in.	60c.	6.48

Above prices are for one felt letter or numeral on each hat, cap, etc. Two or more letters at proportionate prices.



No. 20 No. 21

**Felt Monograms**  
Sewed on our Hats Caps, etc.  
Two Letters  
(See cuts 20 and 21)  
Each Retail Dz.  
1 1/2 in., 21c. \$2.27  
2 in., 24c. 2.60  
2 1/2 in., 28c. 2.81  
3 in., 30c. 3.24



No. 24 Two Letter Monogram

**Felt Monograms—No Background. Buckram Pasted Back**

Size	Each	Retail	Size	Each	Retail
3 in.	22c.	\$2.38	9 or 10 in.	48c.	\$5.19
4 in.	30c.	3.24	11 or 12 in.	60c.	6.48
5 in.	36c.	3.89			
6 in.	42c.	4.54			
7 in.	60c.	6.48			
8 in.	66c.	7.13			
9 in.	78c.	8.43			
10 in.	84c.	9.08			
12 in.	96c.	10.37			

### Felt Emblems—With Background.

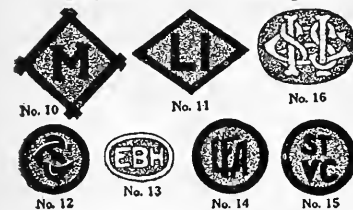

No. 10 No. 11 No. 12 No. 13 No. 14 No. 15

### Silk Hand Embroidered Letters, Numerals, Monograms and Designs on Hats, Caps, Sleeve Bands and Hat Bands

(Raised Work on All Hand Embroidery—Best Quality of Silk Used.)

Silk Hand Embroidered Letters on our Hats, Caps, etc. (See cuts 26, 27, 28)

**Block, Old English or Fancy Style**  
Each Retail Dz.  
1/2 in., 30c. \$3.24  
3/4 in., 36c. 3.89  
1 in., 48c. 5.19



No. 25 No. 26



No. 27



No. 28



No. 29



No. 30

Silk Hand Embroidered Monograms on our Hats, Caps, etc. THREE LETTERS. (See cut 29)

**Block or Plain Style Letters**  
Each Retail Dz.  
3/4 in., 66c. \$7.04  
1 in., 84c. 9.08  
1 1/4 in., \$1.02 11.02

**Plain Style Solid Letter** (See cut 25)  
Each Retail Dz.  
1/2 in., 15c. \$1.62  
3/4 in., 22c. 2.38  
1 in., 30c. 3.24  
1 1/4 in., 36c. 3.89

**Block or Plain Style Letters**  
Each Retail Dz.  
1/2 in., 36c. \$3.89  
3/4 in., 42c. 4.54  
1 in., 66c. 7.13  
1 1/4 in., 78c. 9.33

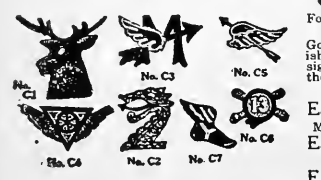

No. C1 No. C2 No. C3 No. C4 No. C5 No. C6 No. C7

**Chenille Emblems**  
For Hats, Caps, Blouses, Sweaters, Coats, etc.  
Good quality and nicely finished. Three sizes. Any design. Cuts show some of the more popular designs.  
Small size, for Caps.  
Each, 30c. ★ \$3.24 Dz.  
Medium, for Shirts, Coats.  
Each, 40c. ★ \$4.32 Dz.  
Large, for Sweater  
Each, 60c. ★ \$6.48 Dz.

**Hand Embroidered Design of Foot Ball on our Hats, Caps, etc.**  
(See cuts 32 and 33)  
1 1/2 inch, outlined. . . . Each, \$ .26 Retail Dz., \$ 2.81  
1 1/2 inch, solid Silk. . . . 1.74

**Winged Foot Design** (See cut 34)  
1 1/2 inch, outlined. . . . Each, 42c. Retail Dz. \$4.54  
Prices for embroidery, felt lettering, etc., quoted above, apply only where the lettering, embroidery, etc., is done at the time we make the hats, caps, etc. On hats, caps, etc., which we have not made or for lettering, etc., done after they have been finished, an extra charge will be made.

The prices printed in italics will be quoted only on orders for one-half dozen or more.  
ALL PRICES SUBJECT TO CHANGE WITHOUT NOTICE. ALL ORDERS WILL BE ACCEPTED ONLY SUBJECT TO OUR ABILITY TO SUPPLY THE GOODS. PRICES SHOWN ARE THOSE IN EFFECT ON DATE NOTED BELOW



# CAPS, HATS

## SPALDING

### UNIVERSITY AND CLASS HATS AND CAPS

No. 202

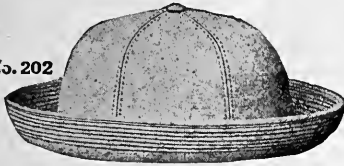

No. 202. Round crown, in Gray, White, Maroon, Black or Navy Blue. Plain brim or brim bound with different color. Supplied on special order only. . Each, \$1.50 ★ \$16.20 doz.

No. 202V



No. 202V. Lower crown and narrower brim than our No. 202 style. Very popular as a regular "Varsity hat." Same colors as No. 202. Supplied on special order only. Each, \$1.50 ★ \$16.20 doz.

No. 300B. "Bull Dog" style school hat, in Gray, White, Maroon, and Navy Blue. Plain or with narrow band of different color flannel. Supplied also on special quantity orders in school colors. . Each, \$1.50 ★ \$16.20 doz.



No. 300B



No. 1

No. 1. University cap, furnished on special orders in either 1 in., 2 in., or 3 in. visor, in Black, Navy Blue, Maroon or Gray. Each, \$1.00 ★ \$10.80 doz.



No. FC

No. FC. Class cap, special design furnished in Gray, White, Maroon, Black or Navy Blue, or on special orders in class colors . . . Each, \$1.00 ★ \$10.80 doz.



No. FT

No. PT. Skull cap of flannel in school or class colors, on special orders. Each, \$1.00 ★ \$10.80 doz.

## SPALDING STITCHED FELT LETTER AND DESIGN PENNANTS

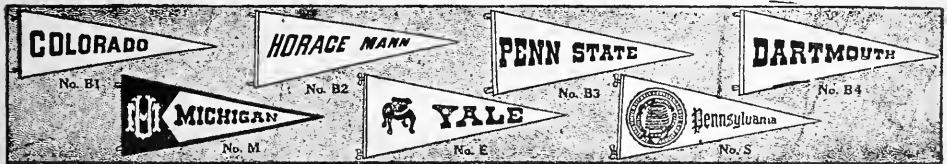

Plain Felt Pennants, with one line any style letters, stitched on

No. B1. Size 9x27 inches . . . Each, 50c. ★ \$5.40 doz.	No. B3. Size 15x36 inches . Each, \$1.00 ★ \$10.80 doz.
No. B2. Size 12x32 inches . . . 75c. ★ 8.10 doz.	No. B4. Size 18x42 inches . . . 1.25 ★ 13.50 doz.
No. M. Pennant. 16x42 inches. With monogram and one line of lettering any style. . . 1.50 ★ 16.20 doz.	No. E. Pennant. 15x36 inches. With Emblem and one line of lettering any style . . . 1.50 ★ 16.20 doz.
No. S. Pennant. 18x42 inches. With Seal and one line of lettering any style . . . 2.00 ★ 21.60 doz.	

## SPALDING BLANKETS

For rowing crews, foot ball and basket ball teams, automobiles, steamer and camp use and all practical purposes of an ordinary blanket. Fine soft texture, well napped and guaranteed strictly all wool. Size 66 inches wide and 76 inches long. Weight three pounds. Colors guaranteed to be strictly fast and washable. Best quality wool felt used for borders, lettering and designs. College, school or fraternity colors matched, the blanket being in one color and the border, letters or design in felt of the second color. When ordering for local high schools or small colleges, do not fail to send us small samples of felt showing correct color. These blankets are not carried in stock—every blanket is made to order . . . . . Each, \$8.00

Special Design Emblems on Blankets, extra, \$1.00 each  
Names, including more than seven letters, extra, 15c. per letter.

The prices printed in italics opposite items marked with ★ will be quoted only on orders for one-half dozen or more. Quantity prices NOT allowed on items NOT marked with ★

ALL PRICES SUBJECT TO CHANGE WITHOUT NOTICE. ALL ORDERS WILL BE ACCEPTED ONLY SUBJECT TO OUR ABILITY TO SUPPLY THE GOODS. PRICES SHOWN ARE THOSE IN EFFECT ON DATE NOTED BELOW.



## SPALDING BASKET BALL SHOES



No. AB



Sole of No. AB Shoe

No. AB. High cut, drab leather, Blucher cut; heavy red rubber suction soles, superior quality.

Pair, \$7.00

No. BBL. Women's. High cut, light; black leather, good quality red rubber suction soles. Supplied on special order only.

Pair, \$5.00



No. BBL



Sole of No. BBL Shoe

## SPALDING SPECIAL CANVAS TOP BASKET BALL SHOES

No. P. Special quality soft rubber soles. These soles absolutely hold on the most slippery floor. Light weight, durable, correct in design. Sizes, 5 to 11 only. No other sizes. Pair, \$3.50 ★ \$37.80 Doz. pairs.

## SPALDING GYMNASIUM SHOES

Gymnasium Shoes must be comfortable and easy, yet fit snugly and give the wearer a sure footing—they must also be durable. Spalding Gymnasium Shoes possess all these good qualities and, in addition, are reasonable in price.

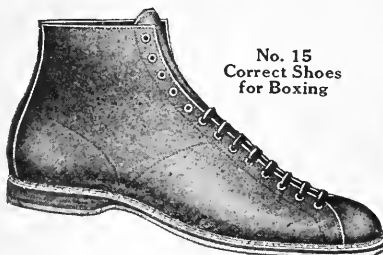

No. 15  
Correct Shoes  
for Boxing

No. 15. High cut, kangaroo uppers; genuine elkskin soles; will not slip on floor; extra light; the correct shoes to wear for boxing. Pair, \$6.00

No. 155. High cut, elk-skin soles, soft and flexible. . . . Pair, \$5.00

No. 166. Low cut, selected leather, extra light electric soles. Pr., \$4.00

No. 66L. Women's low cut, extra light selected leather uppers, electric soles. . . . Pair, \$4.00

No. 21. High cut, black leather; electric soles; sewed and turned, which makes shoes extremely light and flexible. . . . Pair, \$3.50

No. 20. Low cut, otherwise as No. 21; sewed and turned shoes. . . . 2.50

No. 20L. Same as No. 20, but in women's sizes. . . . 2.50

### Knockabout Leather Gymnasium Shoes. Flexible Soles

No. GWH. High cut, special pearl colored leather; flexible soles well made. Pair, \$2.00

No. GW. Low cut, otherwise as GWH. Pr. \$1.50

### Spalding

Special Bowling Shoes No. 148. For bowling and general gymnasium use; light drab chrome tanned leather uppers with electric soles; laces extremely low down.

Pair, \$4.50

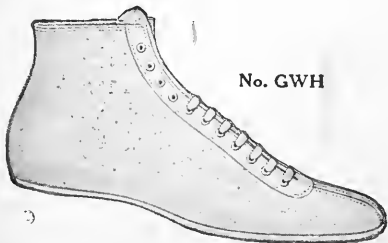

No. GWH

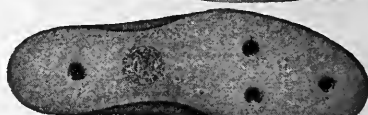

Sole of No. P Shoe

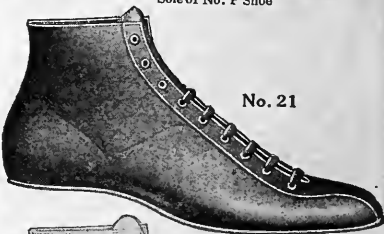

No. 21



No. 148  
Bowling Shoes

Knit Shirts, Tights, and other Gymnasium Wear listed on Pages 26 to 27. Women's Gymnasium Suits suitable for Girls' Basket Ball Teams listed on Pages 59, 60.

Basket Ball Shoes—On orders for five pairs or more, prices in italics, preceded by ★, will apply.

ALL PRICES SUBJECT TO CHANGE WITHOUT NOTICE. ALL ORDERS WILL BE ACCEPTED ONLY SUBJECT TO OUR ABILITY TO SUPPLY THE GOODS. PRICES SHOWN ARE THOSE IN EFFECT ON DATE NOTED BELOW.



**SPALDING GYMNASIUM AND ACROBATIC SHOES**

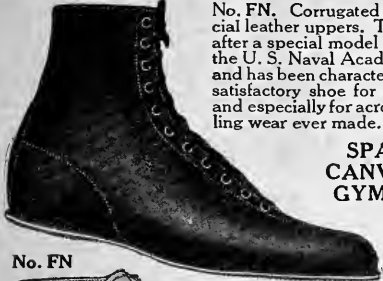

No. FN. Corrugated rubber sole, special leather uppers. This shoe is made after a special model supplied by us to the U. S. Naval Academy, Annapolis, and has been characterized as the most satisfactory shoe for gymnasium use, and especially for acrobatic and wrestling wear ever made. . . Pair, \$5.00

**SPALDING CANVAS TOP GYMNASIUM AND OUTING SHOES**

No. FN



No. FL. Extra high cut canvas acrobatic shoes. (Patented Aug. 17, 1915). Special leather soles, will not harden. Shoes are reinforced where upper and sole are attached. Pair, \$1.75

No. FE. Extra high cut, best quality canvas shoes with leather soles. Especially for acrobatic work. Pair, \$1.50 ★ \$16.20 doz.  
No. E. Low cut canvas, canvas soles. Pair, 35c.

Extra Heavy Rubber Soles



No. HH. High cut, white canvas uppers. Sole surface is similar to our popular gymnasium shoes, No. IH listed below, but of white, best quality rubber, twice as thick. Men's sizes, 6 to 12, inclusive. Pair, \$2.50 ★ \$27.00 doz.

No. HH

No. FL Pat. Aug. 17, 1915

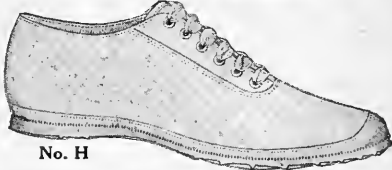

No. H



Showing Sole of Nos. HH, H, IH and I Shoes.

No. HHB. Boys', 11 to 5½, inclusive. Otherwise same as No. HH.

No. H. Men's, same as No. HH, but low cut. Sizes 6 to 12, inclusive.

No. HB. Boys', 11 to 5½, inclusive. Otherwise as No. H.

Pair, \$2.25 ★ \$24.30 doz.  
Pair, \$2.25 ★ \$24.30 doz.  
Pair, \$2.00 ★ \$21.60 doz.

**SPALDING HIGH GRADE CANVAS SHOES**

Best White Rubber Soles. Best Grade White Canvas Uppers

Men's Sizes, 6 to 12, inclusive. Boys' Sizes, 11 to 5½, inclusive

No. IH. High cut, Men's. . . Pair, \$2.00 ★ \$21.60 doz.  
No. I. Low cut, Men's. . . 1.75 ★ 18.90

No. IHB. High cut, Boys'. . . Pair, \$1.75 ★ \$18.90 doz.  
No. IB. Low cut, Boys'. . . 1.65 ★ 18.00

Special Women's Sizes—Narrow Lasts, All Lengths

No. IHL. High cut. . . . . Pair, \$1.85 ★ \$20.00 doz. No. IL. Low cut. . . . . Pair, \$1.65 ★ \$18.00 doz.

**SPECIAL GRADE CANVAS SHOES**

White Rubber Soles. Good Quality White Canvas Uppers

Men's Sizes, 6 to 12, inclusive. Boys' Sizes, 11 to 5½, inclusive

No. WM. High cut, Men's. . . Pair, \$1.40 ★ \$15.12 doz.  
No. WK. Low cut, Men's. . . 1.10 ★ 11.88

No. WMB. High cut, Boys'. . . Pair, \$1.25 ★ \$13.50 doz.  
No. WKB. Low cut, Boys'. . . 1.00 ★ 10.80

**Rubber Reducing Shirts and Sleeves**

- No. R. Rubber Reducing Shirt. . . . . Each, \$13.50
- No. TH. Cotton shirt, heavy weight, wool back; fleece lined; in either Gray or Brown; low collar, long sleeves. Sizes to 42 inches. . . . . Each, \$3.00
- No. T. As No. TH, but medium weight. . . . . " 2.50
- No. THS. As No. TH, but in different color (any color) than Gray or Brown, or with striped sleeves. Furnished on special order. . . . . Each, \$3.50
- No. TS. Same as No. THS, but medium weight. Furnished on special order only. . . . . Each, \$3.00
- No. US. Undershirt for wearing under regular base ball shirt. Gray, with sleeves from elbow down to match trim of uniform. . . . . Each, \$1.75
- Above shirts supplied regularly up to 44 inch chest, over 44 to 50 inches, extra. . . . . .50
- Special colors or striping, extra. . . . . .50

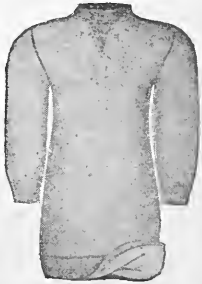

No. T

The prices printed in italics opposite items marked with ★ will be quoted only on orders for one-half dozen pairs or more at one time. Quantity prices NOT allowed on items NOT marked with ★

ALL PRICES SUBJECT TO CHANGE WITHOUT NOTICE. ALL ORDERS WILL BE ACCEPTED ONLY SUBJECT TO OUR ABILITY TO SUPPLY THE GOODS. PRICES SHOWN ARE THOSE IN EFFECT ON DATE NOTED BELOW.



**SPALDING STREET SHOES**

**Ideal Shoes for Street and Business Wear**



No. HS

No. HS. High cut; finest tan calf uppers and vamps, extra heavy full soles. Special order only. Pair, \$10.00

No. LS. Low cut; light extra full soles; otherwise same as No. HS. Special order only.

Pair, \$9.00  
No. SB. High, Blucher cut. Otherwise as No. HS.



No. SB

Pair, \$10.00  
No. VB. High cut, imported kid, black. Rubber heels.



No. VB

Pair, \$10.00  
No. AWB. High, Blucher cut. Finest tan calf uppers and vamps. Spalding "Comfort" last. Heavy extra full soles. Rubber heels. Pair, \$10.00

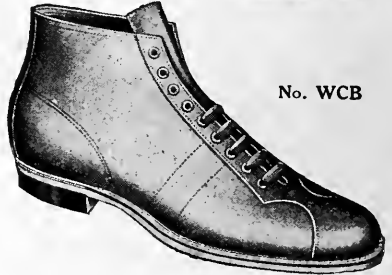

No. WCB

No. WCB. Women's special easy walking style. Selected tan leather uppers. Electric soles; full heels. Pair, \$6.00

**Army Shoes**

No. AOS. A brand new army walking shoe of special athletic last. Made of imported Scotch grained leather. High cut, Blucher style, with double sole throughout, flexible arch and bellows tongue. This shoe is built essentially for rough wear, and designed on lines with particular reference to the highest degree of ease and comfort. Special width heel for added comfort in walking.

Pair, \$12.00



No. AOS

Women's  
Bloomers, Middies,  
etc., listed on  
Pages 59, 60

**Spalding Women's Hiking Boots**

No. WHB. Tramping style, 12 inches high. Soft tan leather, full bellows tongue. Slip soles, with flexible oak tanned outer soles. Pair, \$12.00

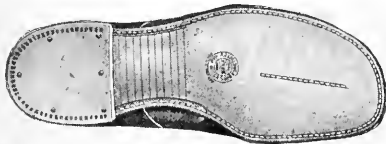

Sole of No. AOS

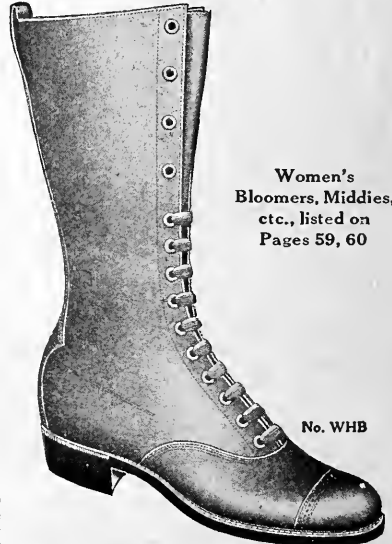

No. WHB

ALL PRICES SUBJECT TO CHANGE WITHOUT NOTICE. ALL ORDERS WILL BE ACCEPTED ONLY SUBJECT TO OUR ABILITY TO SUPPLY THE GOODS. PRICES SHOWN ARE THOSE IN EFFECT ON DATE NOTED BELOW.





# ARMY-NAVY

## SPALDING

THE BOY WHO PLAYS BASE BALL IN HIS OFF TIME AT CAMP IS IN GOOD COMPANY

BALLS, BATS, MITTS GLOVES—EVERYTHING FOR BASE BALL

**ARMY TRAINING CAMPS**  
 A. G. Spalding & Bros. have either a Dealer or a Branch Store near every Army Training Camp and we can arrange for delivering athletic supplies quickly to men who are in training.

**SUPPLIES FOR TRAINING CAMPS**  
**Spalding Dummy Training Gun**



No. DG. Regulation weight and size. Model of Springfield rifle. . . . . Each, \$2.50

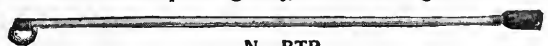

No. BTP. Practical, well made and officially approved. Each, \$1.50

**Spalding Army and Navy Puttees**

No. F. Regulation spiral style, of woven khaki worsted. Excellent quality. . . . . Pair, \$4.50  
 No. 1. Medium weight cowhide. Tan or Black. Sizes: 14, 15, 16, 17 and 18 inches calf measurement. . . . . Pair, \$6.50



**USEFUL ARTICLES FOR MEN IN CAMP**  
**Spalding Knitted Under Vest**

No. A5. Best quality gray worsted, medium weight. Special stitch. Mention coat size or chest measurement when ordering. . . . . Each, \$5.00

**Spalding Money Belts**

No. 1. Regulation style. Pockets for metal money. Waterproof gray canvas. . . . . Each, 75c.  
 No. 2. French model. Pockets for French money, bills, etc. Waterproof gray canvas. Each, \$1.00



**Spalding Swimming Collar**

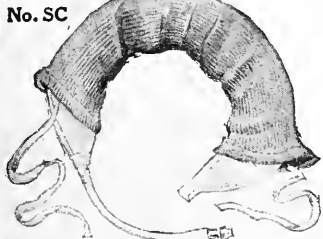

No. SC. Good weight. Pure gum rubber, with extra long rubber inflating stem and knitted cover. Can be worn deflated, and quickly inflated when needed. . . . . Each, \$1.50

**Spalding Cover for Rifle**



No. X. To cover rifle and protect from dust and dampness. Every man needs one . . . . . Each, 50c.

## SPALDING

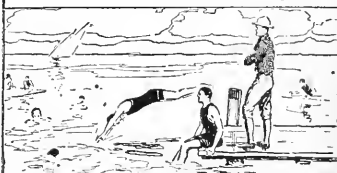

DID YOUR BOY GET A BATHING SUIT BEFORE HE WENT TO CAMP? PERHAPS HE NEEDS SOMETHING ELSE—OUR LINE OF ATHLETIC GOODS IS COMPLETE



Spalding Catalogue of Athletic Equipment for Army and Navy will be sent on request to any address.  
 Spalding Catalogue of Regulation Army and Navy Aviation Equipment will be sent on request to any address.

ALL PRICES SUBJECT TO CHANGE WITHOUT NOTICE. ALL ORDERS WILL BE ACCEPTED ONLY SUBJECT TO OUR ABILITY TO SUPPLY THE GOODS. PRICES SHOWN ARE THOSE IN EFFECT ON DATE NOTED BELOW.

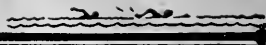

## Spalding Water Polo and Swimming Suits



No. 3R

- No. 3R. Patented combination suit. Best worsted. Solid colors only. Black, Navy Blue, and Gray. Shirt has combination supporter. Arm holes extra large; fastens to trunks at side with invisible catches, making a tight fitting, neat combination. White canvas belt with adjustable buckle forms part of trunks, no drawing tape to knot or break. Pocket for change, etc., inside of trunks. Furnished in regular length and extra long. Suit, \$5.50
- No. 2S. Silk, Navy Blue or Black. One-piece; buttons over shoulder. Suit, \$4.50 ★ \$48.60 Doz.
- No. 4R. Fine quality worsted, made in Navy Blue, and Black. Buttons over shoulder. Suit, \$3.50 ★ \$37.80 Doz.
- No. 2R. Mercerized cotton, Navy Blue, silky finish, sheds water readily; buttons over shoulder. Suit, \$2.00 ★ \$21.60 Doz.
- No. 1R. Cotton, Navy Blue, light weight, snug fitting. Buttons over shoulder. Suit, \$1.00 ★ \$10.80 Doz.

## Frank Ear Stopples

Patented August 5, 1905. Made of soft Para gum. . . . . Pair, 50c.

## Spalding Water Polo Balls

- No. LC. Special leather cover water polo ball. This style is used in games under official rules. Supplied on special order only. Each, \$6.00
- No. 1. Made of white rubber fabric. Inflated with key. Regulation size. . . . . Each, \$2.25

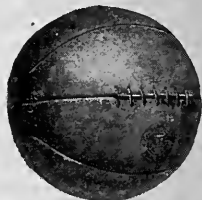

No. LC

## Spalding Official Water Polo Goal Nets

Made in accordance with official rules. . . . . Pair, \$10.00

## Water Polo Guide

No. 129. Directions for playing; official rules. . . . . Each, 10c.

## Official Association Water Polo Cap

- No. WPC. According to official rules it is necessary for polo players to wear caps of this description to enable referee to pick out members of opposing teams. Used also to distinguish swimmers in match races. Made in a variety of colors. . . . . Each, \$1.50
- No. SH. Rubber cap, extra heavy, pure gum. Black only. Large size. . . . . .75
- No. S. Rubber cap, good quality. Black, Tan or Red. . . . . .35
- No. DSC. White duck skull cap, ventilated. . . . . .25



No. WPC

## Spalding Official Push Ball

No. H. Inflated, this ball measures six feet in diameter, and it is so constructed that there is practically no danger of puncturing. The cover is of heavy cowhide, sewn by the same workmen who have been making our foot balls and basket balls for years past. The bladder is made of good quality rubber, but is not guaranteed. This ball is really the only one that should be put in play by teams who wish to avoid disappointing their audience on account of puncture during the course of a game. Made on special order only. Not carried in stock. . . . . Complete, \$350.00



men who have been making our foot balls and basket balls for years past. The bladder is made of good quality rubber, but is not guaranteed. This ball is really the only one that should be put in play by teams who wish to avoid disappointing their audience on account of puncture during the course of a game. Made on special order only. Not carried in stock. . . . . Complete, \$350.00

No. O. Large Cylinder Foot Pump, for inflating push ball.

Each, \$10.00 A Game of Push Ball instead of a Cane Rush

## Spalding Tug-of-War Belt and Sleeve

Supplied on special order only. Not carried in stock.



Correctly designed and substantially made. We supply army, navy and all properly equipped clubs.

Tug-of-War Belt. . . . . Each, \$50.00

Tug-of-War Sleeve or Arm Protection. Each, \$6.00

The prices printed in italics opposite items marked with ★ will be quoted only on orders for one-half dozen or more at one time. Quantity prices NOT allowed on items NOT marked with ★

ALL PRICES SUBJECT TO CHANGE WITHOUT NOTICE. ALL ORDERS WILL BE ACCEPTED ONLY SUBJECT TO OUR ABILITY TO SUPPLY THE GOODS. PRICES SHOWN ARE THOSE IN EFFECT ON DATE NOTED BELOW.





# VOLLEY BALL

## SPALDING VOLLEY BALL

Volley Ball may be played either indoors or out.



No. OV

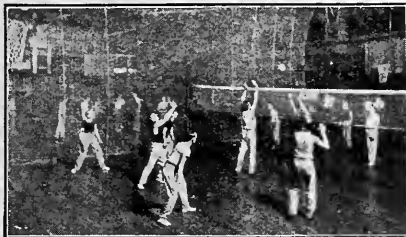

Business Men Playing Volley Ball

## Spalding Volley Ball Nets and Standards

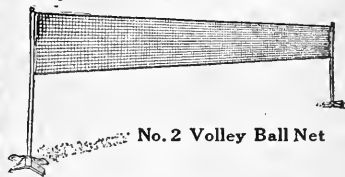

No. 2 Volley Ball Net

- No. P. Posts complete, with guy ropes. **\$2.50**  
 O. Posts complete with spikes. **2.00**  
 No. 2. Standards, 9 feet high. For indoor use. Complete with net. **\$8.50**  
 No. IV. Nets separate, for standards or posts. . . . . Each, **\$1.25**

No. OV. Official style. Best quality white chrome leather. Regulation size and weight. . . . . Each, **\$6.00**

No. RV. Special brown tanned leather. Regulation size and weight. . . . . Each, **\$6.00**

No. W. Good quality leather. Well made practice ball. . . . . Each, **\$3.50**

No. A. Guaranteed bladder, for any of the above volley balls. . . . . Each, **90c.**



## Spalding Medicine Balls

An excellent form of exercise, especially for business men and others engaged in sedentary occupations. Medicine ball exercise develops the chest, exercises the back, arms, legs; in fact, improves the whole system.

Covered (except No. X) with Smooth Tan Leather

- No. 9. 1½-lb. Ball . . . . . Each, **\$5.00**  
 No. 0. 3-lb. Ball . . . . . **6.00**  
 No. X. 3-lb. Ball. Covered with specially durable leather for use in various gymnastic games, such as horse tennis, etc. . . . . Each, **\$7.50**  
 No. 11. 4-lb. Ball . . . . . **7.50**  
 No. 12. 6-lb. Ball . . . . . **9.00**  
 No. 13. 9-lb. Ball . . . . . **12.00**  
 No. 14. 11-lb. Ball . . . . . **14.00**



## Spalding Rubber Hand Balls

- No. 101. Spalding "American Standard." Size 1½ inch. Weight 2¼ ounces. Air pressure 35 pounds. Very fast. . . . . Each, **35c.**  
 No. 102. Black. Size 1½ inch. Weight 1½ ounces. Medium fast. . . . . **35c.**  
 No. 103. Dark rubber. Size 1½ inch. Weight 2 ounces. Medium fast. . . . . **35c.**  
 No. 104. Dark rubber. Size 1½ inch. Weight 2¼ ounces. Medium fast. . . . . **35c.**  
 No. 105. Brown Black. Size 2¼ inch. Weight 1½ ounce. Medium fast. . . . . **40c.**  
 No. 106. Black. Size 2¼ inch. Weight 2 ounces. Fast speed. . . . . **40c.**  
 No. O. Squash Balls, with "overspun" cover. Very popular for hand ball. . . . . **50c.**



## Hand Ball Gloves

No. B. Stiff flat fingers and palm of solid leather. Patented construction and the most practical style glove for the game as played in this country. Patented Jan. 6, 1914. . . . . Pair, **\$4.25**

No. A. Best quality leather; stitched palm. Palm leather lined. . . . . Pair, **\$3.50**

No. 2. Soft tan leather; stitched palm. . . . . **2.00**

No. 3. Fingerless. . . . . **1.25**



No. B

No. A

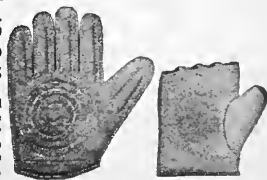

No. 2

No. 3

To obtain the best results from the use of Spalding Hand Ball Gloves and especially the patented No. B style, partially close the hand, so the fingers are at right angles to the palm; by this action the palm of the glove is pressed against the palm of the hand, pushing out any air that might be between the glove and the hand; smoothing out the flesh of the hand, which gives a striking surface without the "cushion" effect, a detriment to really fast and correct hand ball play.

ALL PRICES SUBJECT TO CHANGE WITHOUT NOTICE. ALL ORDERS WILL BE ACCEPTED ONLY SUBJECT TO OUR ABILITY TO SUPPLY THE GOODS. PRICES SHOWN ARE THOSE IN EFFECT ON DATE NOTED BELOW.

# HAMMERS

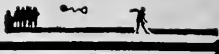

No. 153

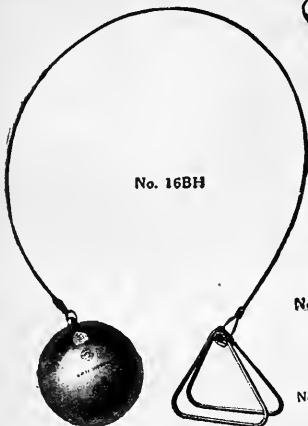

No. 16BH



No. 2

No. MG



Discus

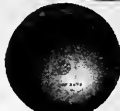

No. 16BS



No. P



Hurdle



No. 3



No. L

## SPALDING "OFFICIAL OLYMPIC" ATHLETIC IMPLEMENTS



A. G. SPALDING & BROS. have been authorized officially to use this stamp on Spalding athletic implements made in accordance with International Amateur Athletic Federation specifications. Implements to be recognized as official, for use in any future Olympic Games, must bear the official I. A. A. F. stamp as shown. Spalding implements are not only officially recognized by the governing athletic bodies of the whole world, but the adoption of "actual use," by every athlete of any prominence in either club, college or school competition, is accorded them because of superiority of construction over the implements made by any other concern.

### Spalding Athletic Hammers

No. 16BH. Spalding "Official Olympic" Brass Shell Head 16-lb. Hammer (Pat. August 20, 1912), including ball-bearing swivel (Patented May 15, 1900). Supplied regularly with double triangle wire grip (Pat. December 22, 1914). . . . . Each, \$10.00  
 No. 12BH. 12-lb. Brass Shell Head Hammer, otherwise same as No. 16BH. . . . . Each, \$9.00  
 Any regular Spalding Hammer listed above furnished with No. MG grip instead of double triangle wire grip.

No. 16IHB. 16-lb. Solid Iron Head Hammer, including ball-bearing swivel (Pat. May 15, 1900); double triangle wire grip. . . . . Each, \$4.50  
 No. 12IHB. 12-lb. Solid Iron Head Hammer, otherwise same as No. 16IHB. . . . . Each, \$4.00  
 No. 8IH. 8-lb. Solid Iron Head Hammer without ball-bearing swivel. Double triangle grip. Each, \$3.00

### Spalding Athletic Shot

No. 16BS. Spalding "Official Olympic" Brass Shell Shot, 16-lb. (Pat. Aug. 20, 1912). . . . . Each, \$9.00  
 No. 12BS. 12-lb. Brass Shell. . . . . " 7.50  
 No. 16IS. 16-lb. Solid Iron. . . . . " 1.75  
 No. 12IS. 12-lb. Solid Iron. . . . . " 1.50  
 No. 24LS. 24-lb. Solid Lead. . . . . " 9.00  
 No. 24IS. 24-lb. Solid Iron. . . . . " 5.00  
 No. 8IS. 8-lb. Solid Iron. . . . . " 1.25  
 No. 5IS. 5-lb. Solid Iron. . . . . " 1.00  
 No. 26. 8-lb. leather covered. . . . . " 7.00  
 No. 5. 5-lb. leather covered. . . . . " 5.00

### Spalding Indoor Athletic Shot

Rubber Covered. Patented December, 1905. Scientifically made; perfectly round; gives fine grip; has proper resiliency when it comes in contact with floor; wears longer than ordinary leather covered; lead dust will not sift out; always full weight.  
 No. P. 16-lb. Ea., \$12.00 No. Q. 12-lb. Ea., \$10.00

### Leather Covered Shot

Method of construction prevents loss of weight even when used constantly.  
 No. 3. 12-lb. Ea., \$8.00 No. 4. 16-lb. Ea., \$9.00

### Spalding "Official Olympic" Hurdle

Patented December 22, 1914. As illustrated above. Three adjustment style. This hurdle is made so that it is instantly adjustable to three different heights required in hurdle races under various rules: 2 feet 6 inches, 3 feet, and 3 feet 6 inches.  
 No. 31. Three Adjustment Hurdle. . . . . Each, \$5.00  
 Set of forty. . . . . 140.00

### Spalding Lanes for Sprint Races

No. L. Spalding Sprint Lanes. Sufficient stakes and cord to lay out four 100-yd. lanes. Stakes are made with pointed ends and sufficiently strong so that they can be driven into hard ground. . . . . Set, \$15.00

**Extra Handles for Athletic Hammers**  
 No. MG. Single Grip Style (see cut). Supplied separately with wire handle. . . . . Each, \$2.00  
 No. FH. Double Triangle Grip, complete with wire handle, furnished separately. . . . . Each, 75c.  
 Leather Case for Athletic Hammers. No. L. Leather Case, to hold either 12 or 16-lb. hammer. Each, \$3.00

**The Spalding "Official Olympic" Discus No. 5**  
 No. 5. Wood center. . . . . Each, \$7.50

**Spalding Practice All-Steel Discus** (Patented March 30, 1915)  
 Same size and shape as No. 5 style, but made all of steel, which forbids its use as an official implement. It is recommended for practice and on account of all-steel construction will give maximum amount of service.  
 No. 15. Spalding "Practice" Discus, all steel. Ea., \$5.00

### Spalding "Youths' Official" Discus

Wood center. Official for Junior Discus Competitions.  
 No. Y. Spalding "Youths' Official" Discus, wood center. . . . . Each, \$5.00

### Regulation 56-lb. Weight

No. 2. Endorsed by all weight throwers. Lead. Packed in box, guaranteed correct in weight. Complete, \$15.00

### Spalding "Official Olympic" Javelin

Made in exact accordance with official specifications.  
**No. 153. Spalding "Official Olympic" Javelin. Ea., \$3.00**  
**SPECIAL NOTICE**—Specifications in the Official Rules covering Javelin throwing are such that in complying with them the Javelin is necessarily quite frail; hence, if it is not thrown with the proper degree of skill it is easily broken and this through no fault of material or workmanship. We are unable, therefore, to guarantee Javelins against breakage while in use. We guarantee only against defective material or workmanship, and in 95 cases out of 100 where a Javelin shaft is broken we have found it the result of faulty manipulation or awkwardness on the part of the performer.  
 Running Pants, Page 39. Athletic Shirts and Tights, Pages 25, 27. Running, Jumping, Hurdling and Pole Vaulting Shoes, Pages 38, 39.

**ALL PRICES SUBJECT TO CHANGE WITHOUT NOTICE. ALL ORDERS WILL BE ACCEPTED ONLY SUBJECT TO OUR ABILITY TO SUPPLY THE GOODS. PRICES SHOWN ARE THOSE IN EFFECT ON DATE NOTED BELOW.**

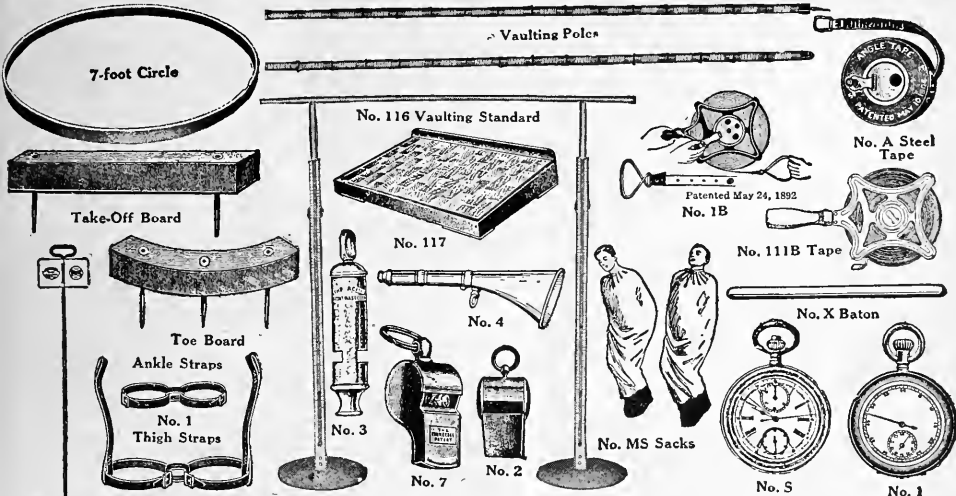

## SPALDING FIELD AND TRACK ATHLETIC IMPLEMENTS

**Spalding Indoor Bamboo Vaulting Poles**  
Tape wound at short intervals. Fitted with special spikes.

No. 10BV. 10ft. Ea., \$4.50 No. 14BV. 14ft. Ea., \$6.50  
No. 12BV. 12ft. 5.50 No. 16BV. 16ft. 7.00

**Spalding Vaulting and Jump Standards**

No. 116. 1/2-in. graduations, 13ft. 6 inches high. \$18.00  
No. 106. Inch graduations, 7ft. high. 10.00  
No. 212. Cross Bars. Officially correct. Hickory. Dz., 6.00  
No. C. Cord, with weight bags at either end. Ea., 2.00

**Competitors' Numbers**

	Manila, Set	Linen, Set
No. 1. 1 to 50	\$ .38	\$2.50
No. 2. 1 to 75	.57	3.75
No. 3. 1 to 100	.75	5.00
No. 4. 1 to 150	1.13	7.50
No. 5. 1 to 200	1.50	10.00
No. 6. 1 to 250	1.88	12.50

For larger meets, on Manila paper only, sets as follows:

No. 7. 1 to 300. Set, \$2.25	No. 16. 1 to 1200. Set, \$9.00
No. 8. 1 to 400. " 3.00	No. 17. 1 to 1300. " 9.75
No. 9. 1 to 500. " 3.75	No. 18. 1 to 1400. " 10.50
No. 10. 1 to 600. " 4.50	No. 19. 1 to 1500. " 11.25
No. 11. 1 to 700. " 5.25	No. 20. 1 to 1600. " 12.00
No. 12. 1 to 800. " 6.00	No. 21. 1 to 1700. " 12.75
No. 13. 1 to 900. " 6.75	No. 22. 1 to 1800. " 13.50
No. 14. 1 to 1000. " 7.50	No. 23. 1 to 1900. " 14.25
No. 15. 1 to 1100. " 8.25	No. 24. 1 to 2000. " 15.00

**Spalding "Official Olympic" Circles**

No. 9. 7 Foot Circle. For shot and weights. Three sections, band iron. Each, \$10.00  
No. 19. 8 Foot 2-inch Circle. For throwing discs. Three sections, band iron. Each, \$10.00

**Spalding Take-off Board**

The Take-off Board is used for the running broad jump. Regulation size; painted. Each, \$3.50

**Spalding Toe Board or Stop Board**

Used when putting the 16-lb. shot, when throwing weights and discs. Regulation size, painted. Each, \$4.00

**Spalding Official Sacks for Sack Races**

Supplied on Special Order only  
No. MS. Men's Sack, reinforced. Official. Ea., \$1.50

**Spalding Official Batons for Relay Races**

No. X. Hollow wood. Correct size, length, weight. Ea., 50c.

We supply everything needed to fit out an athletic field in proper shape, in addition to everything needed by officials in charge. Write us about anything required which is not shown in this catalogue. We are the "official outfitters" for all organized athletic bodies in the United States.

ALL PRICES SUBJECT TO CHANGE WITHOUT NOTICE. ALL ORDERS WILL BE ACCEPTED ONLY SUBJECT TO OUR ABILITY TO SUPPLY THE GOODS. PRICES SHOWN ARE THOSE IN EFFECT ON DATE NOTED BELOW.

Vaulting Poles

7-foot Circle

Take-Off Board

Toe Board

Ankle Straps

No. 1 Thigh Straps

No. 116 Vaulting Standard

No. 117

No. 4

No. 3

No. 7

No. 2

No. OS Sacks

No. 5

No. 1

**Spalding Outdoor Bamboo Vaulting Poles**  
Tape wound; rounded end wound with copper wire; soldered.

No. 100BV. 10ft. Ea., \$4.50 No. 104BV. 14ft. Ea., \$6.50  
No. 102BV. 12ft. 5.50 No. 106BV. 16ft. 7.00

**Indoor Pole Vaulting Board**

No. 117. Made up of sectional blocks of wood placed on end so the spike will not split them. Complete \$16.00

**Official Harness for Three-Legged Racing**

Made according to official rules. Complete set of straps.

No. 1. Official Harness for three-legged racing. Set, \$2.50

**Spalding Referees' Whistles**

No. 7. Nickel-plated, heavy metal whistle. Each, \$ .50  
No. 4. Horn whistle, nickel-plated, heavy metal. " 1.00  
No. 3. Nickel-plated, special deep tone. " .35  
No. 2. Very reliable. Popular design. " .25  
No. 3W. Official Whistle. With wrist strap. " 1.75

**Spalding Stop Watches**

No. S. Combined Chronometer and Stop Watch. Keeps good time and in addition to regular hands has split second hand. Supplied on special orders only. Ea., \$15.00  
No. 1. Stem winder, nickel-plated case, registered to 60 seconds by 1-5 seconds, fly back engaging and disengaging mechanism. Each, \$7.50

**Patent Steel Tape Chain on Patent Electric Reel**

For Measuring Long Distances in Athletic Competitions.  
Superior steel about 1-4 inch wide. The reel allows the entire tape open to dry and can be reeled and unreeled as easily as tapes in cases. Last foot only marked in inches. Supplied on special order only.

No. 1B. 100 ft. long. \$5.00 No. 11B. 200 ft. long. \$7.50

**Official Athletic Steel Measuring Tape**

No. 111B. 300 feet long; has etched markings throughout; feet, inches and eighths. Complete on reel, with convenient wood handle. Each, \$16.50

**Patent "Angle" Steel Measuring Tape**

For laying off base ball diamonds, tennis courts and all kinds of athletic fields. Flush handles with patent automatic handle opener, all mounts—brass nickel plated.

No. A. 50 ft. long, 3/8 in. wide, in leather case. Ea. \$4.00  
No. B. 100 ft. long, 3/8 in. wide, in leather case. Ea. 6.75

**Potato Race Equipment**

Potatoes, official specifications. Set of eight, \$2.50  
Receptacle for potato race. Each, \$3.50

**Spalding Sector Flags**

For marking sector within which shot, etc., must be thrown.  
No. S. Spalding Sector Flags, metal. Each, 75c.



## Spalding "Olympic Championship" Running and Jumping Shoes

All of these (Nos. 3-0, 2-0, 14C, 14H, 14V and 14W, listed below) are fine turned shoes. Finest Kangaroo leather uppers and fine leather soles.

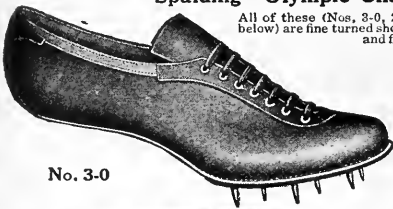

No. 3-0

**Spalding "Monitor" Sprint Running Shoes**  
Patented May 7, 1916  
No. 3-0. Lightest running shoe made. Hand made spikes. Especially for 100 and 220 yards races. Strictly bench made. Pair, \$7.00



No. 14C

**Spalding Short Distance Running Shoes**  
No. 2-0. Extremely light and glove fitting. Hand made steel spikes firmly riveted on. Worn by all champions for short distances, especially 440 and 880 yards and one mile races. Pair, \$6.50



No. 14H

**Spalding Long Distance Running Shoes**  
No. 14C. For long distance races on athletic tracks. Electric heels, flexible shanks. Steel spikes in soles. No spikes in heels. Pair, \$6.00



No. 14V

**Spalding Jumping Shoes**  
No. 14H. Specially stiffened soles. Hand made steel spikes placed as suggested by champion jumpers. Also correct for shot putting, weight and hammer throwing. . . . Pair, \$7.50



**Spalding Pole Vaulting Shoes**  
No. 14V. High cut, special last. Same as we supply to the record holders. Hand made steel spikes in soles; one spike in heels. To order only. . . . Pair, \$7.50



On special orders we will supply Pole Vaulting Shoes with one high and one low cut shoe at no extra charge.



No. MH

**"Olympic Championship" Walking Shoes**  
No. 14W. For competition and match races. Same as used by all champion walkers. . . . Pair, \$6.00

**Spalding Outdoor Jumping Shoes**  
No. 14J. Good quality leather; machine made. Satisfactory quality; durable. Steel spikes. . . . Pair, \$6.00 ★ \$64.80 Doz.

**Spalding Outdoor Running Shoes**  
No. 11T. Calfskin, machine made; solid leather tap sole holds spikes firmly in place. . . . Pair, \$5.00 ★ \$54.00 Doz.  
No. 11. Chrome leather, machine made. . . . 3.50 ★ 36.00 "



**Spalding Marathon Running Shoes**  
No. MH. High cut, but light in weight. Well finished inside so as not to hurt the feet in a long race. Special leather soles, will not wear smooth. Light leather heels. Special quality black leather uppers; welted. Pair, \$6.00

No. MO. Low cut. Otherwise same as No. MH. . . . 5.50

### Spalding Chamois Pushers

No. 5. Fine Chamois skin. Should be used with running, walking, jumping and other athletic shoes.

Pair, 50c.



The prices printed in italics opposite items marked with ★ will be quoted only on orders for one-half dozen pairs or more at one time. Quantity prices NOT allowed on items NOT marked with ★



No E

### Rubber Heels to Be Put Inside Jumping Shoes

No. E. Inside rubber heels for jumping, hurdling and pole vaulting shoes. Pair, 25c.

### Cork Athletic Grips

No. 1. Selected cork, shaped. . . . Pair, 15c.



Spalding "Dri-foot" keeps uppers of all running shoes soft and pliable and adds greatly to their wear. 10c.

ALL PRICES SUBJECT TO CHANGE WITHOUT NOTICE. ALL ORDERS WILL BE ACCEPTED ONLY SUBJECT TO OUR ABILITY TO SUPPLY THE GOODS. PRICES SHOWN ARE THOSE IN EFFECT ON DATE NOTED BELOW.



Spalding Indoor Running and Jumping Shoes



No. 111

Spalding Indoor Running Shoes  
No. 111. Calfskin, special corrugated rubber soles with spikes. Pair, \$4.50  
No. 112S. Good leather uppers and leather soles, short spikes. Pair, \$4.50  
★\$48.60 Doz.



No. 112S



No. 112. Good leather, rubber tap soles. No spikes. Pair, \$4.50  
★\$48.60 Doz.

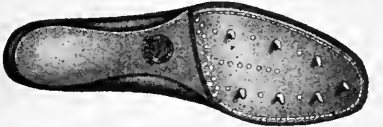

No. 112

No. 114. Leather uppers; rubber tap soles. No spikes. Pair, \$3.50  
★\$37.80 Doz.



No. 210



Spalding Indoor Jumping Shoes  
No. 210. Good quality leather uppers; rubber tap soles and rubber heels. Pair, \$6.00  
No. 210S. Like No. 210, but with spikes. Pair, \$6.50



Spalding Running Pants

Stock sizes: 22 to 42-inch waist, cut good and full in size. Specify size and color when ordering.



No. 3

No. 3. White or Black Sateen. Made with fly front and laced back. . . . . Pair, \$1.00 ★\$10.80 doz.  
No. 4D. White Drill. Specially recommended for indoor or Y. M. C. A. work. Fly front, laced back. Pair, \$1.00 ★\$10.80 doz.  
No. 4F. Equipped with durable and reliable adjusting arrangement at sides. White, Black or Gray twill. Pair, \$1.00  
No. 4C. College style, fly front, wide hips, short legs, no elastic. Made in White, Black or Gray twill. Pair, 75c.  
No. 4. White, Black or Gray twill. Fly front, laced back. . . . . Pair, 75c. ★\$8.10 doz.  
Silk Ribbon Stripes down sides any of these running pants.



No. 4F

Silk Ribbon Stripe around waist on any of these running pants. Pair, extra, 25c. ★\$2.70 doz.  
Pair, extra, 25c. ★\$2.70 doz.

See Page 14 for Supporters and Bandages. Shirts and Tights listed on Pages 26-27.

The prices printed in italics opposite items marked with ★ will be quoted only on orders for one-half dozen pairs or more at one time. Quantity prices NOT allowed on items NOT marked with ★

ALL PRICES SUBJECT TO CHANGE WITHOUT NOTICE. ALL ORDERS WILL BE ACCEPTED ONLY SUBJECT TO OUR ABILITY TO SUPPLY THE GOODS. PRICES SHOWN ARE THOSE IN EFFECT ON DATE NOTED BELOW

# QUOITS



## Spalding Official Iron Quoits

No. O. Made according to official rules. Malleable iron, 8½ inches in diameter, with hand clasp. Set of four, \$12.00

### Spalding Official Quoit Pins

No. X. Steel. Measure 36 inches long by 1 inch in diameter, and are made so that referee can take measurements without difficulty. . . . Pair, \$3.00

### Spalding Rubber Quoits

No. 6. Loaded. Will not slide or roll. Weigh about 5 lbs. to a set. . . . Set of four, \$3.00  
No. 5. Best rubber, plain. . . . 2.00

### Spalding Indoor Quoit Pins

No. J. Made with floor plate and detachable pin; unscrewed when not in use. . . . Pair, 75c.

## Spalding Japanned Iron Quoits

No. 1. 4½ inch diameter, 1½ lbs. . . Set of four, \$ .75  
No. 2. 4½ inch diameter, 2 lbs. . . " 1.00  
No. 3. 5 inch diameter, 2½ lbs. . . " 1.25  
No. 4. 6 inch diameter, 3 lbs. . . " 1.50  
No. W. Wrought Iron Pins. . . . . Pair, .50

### Spalding Quoit Game

No. Q. Two metal stands, with nickel-plated upright pins and six quitta percha quoit rings. Interesting game for indoors, as quotts will not mar furniture or wood-work. . . . Complete, \$5.00  
No. QR. Rings. . . . . Each, .25

## SPALDING FIELD HOCKEY

### The "Applebee 00" Regulation Stick

No. 2S. Ash head, with bulge back of striking surface, rattan cane handle, with whipping. Finest material and workmanship throughout. . . . Each, \$3.50

### Spalding Field Hockey Balls

No. 7. "Grand Prix." Ball as used by best players in England. . . . . Each, \$3.00  
With two coats special elastic white enamel. Per ball, extra, 25c.  
No. B. Seamless, white enameled leather cover; excellent quality. . . . . Each, \$2.00  
No. C. Rubber Cover Composition Ball; superior quality. . . . . Each, \$1.00

### "Applebee 0" Regulation Stick

No. 2B. Plain ash, turned knob, twine wound, Ea., \$2.50

### Rubber Finger Protection

No. R. Pure gum ring. Fits any stick. . . Each, 50c.

### Spalding Regulation Field Hockey Goals

Field Hockey Goals supplied on special order only.  
No. 2. Heavy japanned tubing frame, tarred nets. . . . . Set, \$50.00

### Field Hockey Shin Guards

No. F. Canvas. With ankle protectors. Pair, \$1.00  
No. 40. Leather. With ankle protectors. " 2.50

## SPALDING LACROSSES

"Ceel" Lacrosses. Made for A. G. Spalding & Bros. exclusively. For expert players. Perfect in shape and balance and used exclusively by the New Westminster Team, Champions of the world and holders of the Minto Cup; also by the National Team of Montreal, Champions of National Lacrosse Union; Montreal Team of Montreal, Tecumseh and Toronto Teams of Toronto, etc.

No. CL-1. Defence Model. Each, \$5.00 | No. CL-2. Home Model. Each, \$5.00 | No. CL-3. Goal Model. Each, \$6.00  
No. O Lacrosses. Secondary to the "Ceel" sticks. Frames made of specially selected hickory, strung with best quality clock cord; running strings of thoroughly stretched babish. Defence Model. . . . . Each, \$4.00  
No. O Lacrosses. Home Model. . . . . Each, \$4.00  
No. 2 Lacrosses. Youths' stick. Rawhide strung. 1.50

### Spalding Official Lacrosse Ball

No. G. Gray. Adopted by the N.A.L.U. Each, \$1.00

### Spalding Regulation Lacrosse Goals

Supplied on special order only. . . Complete, \$40.00

### Spalding Lacrosse Gloves

No. A. Special horse hide, best quality, easy fitting, padded palm; correct for lacrosse goal keepers. . . . . Pair, \$3.50  
No. 5. Well padded to protect the bones and joints in the player's hands. . . . . Pair, \$4.00  
For Uniform Equipment suitable for Lacrosse, refer to other pages in this Catalogue; Jerseys, Page 12; Knit Shirts, Page 26; Running Pants, Page 33; Stockings, Page 15. We can also furnish correct style Lacrosse Shoes on special order.

No. HG. Brown leather, padded back and fingers; white buckskin palm, reed padded gauntlet, large and medium sizes. . . . . Pair, \$3.50  
No. L. Unpadded, drab buckskin gauntlet glove. Extra long, very popular. . . . . Pair, \$3.00

### Spalding Hurley Sticks

No. M1. Men's. Each \$1.75 No. M3. Men's. Each 75c.  
No. M2. Men's. " 1.25 No. Y4. Youths' " 50c.

### Spalding Hurley Balls

No. MW. Men's White. . . . . Each, \$1.50  
No. MC. Men's Crown. Ea., \$1.25 No. B. Boys' " .50

ALL PRICES SUBJECT TO CHANGE WITHOUT NOTICE. ALL ORDERS WILL BE ACCEPTED ONLY SUBJECT TO OUR ABILITY TO SUPPLY THE GOODS. PRICES SHOWN ARE THOSE IN EFFECT ON DATE NOTED BELOW.





## A. G. SPALDING & BROS. AUTOGRAPH SQUASH TENNIS RACKETS

Strung with best white gut, calfskin grip. Frame bound at shoulders. Special expert style stringing.

- No. 20A. Model as shown in cut . . . . . Each, \$5.00
- No. 20B. Model as shown in cut . . . . . " 5.00

## SPALDING CHAMPION SQUASH TENNIS RACKETS

Strung with good quality gut, patent non-slipping handle. Frame bound at shoulders.

- No. 19A. Model same as No. 20A . . . . . Each, \$3.50
- No. 19B. Model same as No. 20B . . . . . " 3.50

Used by the most successful and experienced players in this country. Frames of the finest selected white ash. Made in the most careful manner and of best materials, but owing to necessary lightness of material, hard service and frequent abuse, these rackets are not guaranteed.

## SPALDING SQUASH TENNIS BALLS

Adopted as Official by National Squash Tennis Association.

Are finest quality material and workmanship throughout. It will pay you to try them if you are not already familiar with their good points. The idea of the (*overspun*) cover, knitted on the ball and with no seams to rip, is original with us and is a valuable improvement. These balls are carefully made of best materials, but they are not guaranteed.

- No. O. Spalding Championship Overspun Squash Tennis Balls (*Patented*). White or Green covering . . . . . Dozen, \$6.00

## SPALDING SQUASH RACQUETS

Spalding Squash Racquet Bats and Balls are made in the most careful manner and of best materials,

but they are not guaranteed.

- No. 17. Bat. Frames latest approved model; strung with best quality gut; grip wound with white kid; best grade throughout.

Each, \$5.00

- No. S. Balls. Best quality rubber; black;  $1\frac{1}{16}$  inch.

Each, 25c.

## ENGLISH RACQUET BAT

- No. 27. Correct in design and well made. Each, \$5.00



No. O

## SPALDING INDOOR TENNIS POSTS

No. 1D. With Spalding Indoor Tennis Posts it is not necessary to mar the floor in order to set them up, the heavy castings used for bases being sufficiently weighty to hold them secure, and for this reason the Spalding posts are the only ones permitted to be used in armories and halls where the floors must be kept in perfect condition.

Pair, \$12.00

No. 27

No. 1D

Complete Catalogue Tennis Equipment sent on request.

ALL PRICES SUBJECT TO CHANGE WITHOUT NOTICE. ALL ORDERS WILL BE ACCEPTED ONLY SUBJECT TO OUR ABILITY TO SUPPLY THE GOODS. PRICES SHOWN ARE THOSE IN EFFECT ON DATE NOTED BELOW.





## THE GAME OF INDOOR GOLF

Indoor Golf is the best possible substitute for the real game that can be found. It is played with the same clubs and balls as used out of doors. The shots are played with the same amount of strength, and a player is thus able, by keeping in practice all the year around, to improve his or her game. The No. 1 and No. 2 Indoor Nets (see diagrams) show the distances to be made with each club in each pocket.

You can take the score card of any course and, by changing the last figure to a 5 or an 0 to conform with the figures on the net, will make it possible to reach the green in one, two, or three shots. The distances count to the edge of the green. For instance, the first hole is 475 yards long. We will say that on your first shot with a driver you strike in the center pocket, this gives you 200 yards for your first stroke. Your next stroke will be played with a brassie and, if you hit this ball into

the top net, you are given 100 yards for this stroke. You now have 175 yards to the edge of the green and you have several different places to play for. Your choice would probably be a cleek in the top center pocket and, if this is made, you are now on the edge of the green, and placing your ball on the 15 foot mark you putt for a four.

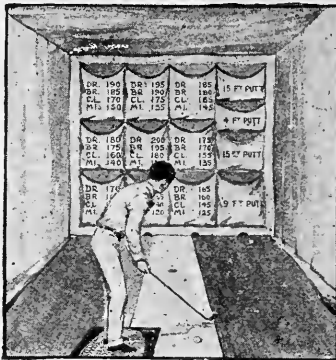

Patented Sept. 6, 1910

Hole No. 2 is 354 yards in length; your first shot strikes in the left center pocket, or 180 yards in one stroke. This leaves you 155 yards to go, and in your attempt to play a mid iron in the top center pocket, the ball strikes the top left hand pocket, giving you a total of 325 yards. It is now necessary to play a mashie shot into the pockets marked 4 feet, 9 feet and 15 feet putt, to determine how far from the hole you stand to putt. The No. 2 Indoor Net is played the same as the No. 1, except that you play the mashie to determine how far you stand away to putt within 60 yards instead of 120, as on the No. 1 net.

### No. 1 INDOOR GOLF OUTFIT

Back Canvas only. 12x14 ft. 13 pockets. Constructed of 8-oz. canvas. Ropes attached at top and bottom for erection. Seams rope reinforced. Each, \$60.00  
Side and Top Nets only. 40x20 ft. With allowance of one foot for irregularity in building when net is erected. Attached to canvas by hooks. Each, \$25.00  
Sundry equipment only. Consisting of Cocoa Mat, for driving; Rubber Stance Mat, for attaching to stance platform; Putting Carpet (without stand) and Score Board. . . . . Complete, \$15.00  
No. 1. Outfit, complete as listed above. Each, 100.00

### No. 2 INDOOR GOLF OUTFIT

Back Canvas only. 9x12 feet, 9 pockets. Otherwise same as No. 1 . . . . . Each, \$50.00  
Side and Top Nets only. 32x20 feet. Made same as No. 1 . . . . . Each, \$20.00  
Sundry equipment only. As with No. 1 outfit. 15.00  
No. 2. Indoor Golf Outfit, complete as listed above. Each, \$85.00

### EXTRA EQUIPMENT

Special Putting Green Carpet. Heavy Nap. Can be used without sand. Furnished with either No. 1 or No. 2 net . . . . . Extra, each, \$12.00

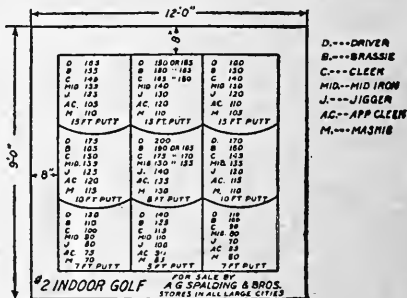
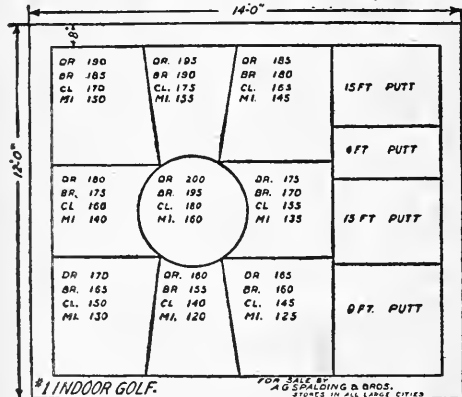

No. 2 Net

### RULES FOR INDOOR GOLF

#### APPLYING TO BOTH No. 1 AND No. 2 NETS

The ball must strike a pocket without glancing from side nets or hitting the floor. If a ball strikes a pocket and glances into the pocket above, it counts in latter, but if it strikes into pocket below, it counts in former. If ball strikes top net with driver, brassie, cleek or mid iron, 100 yards distance is allowed. If ball strikes top net with iron, it is not necessary for the ball to stay in the pocket whereas mashie, the shot is allowed, providing the ball hits an approaching pocket. It is not necessary for the ball to stay in the pocket whereas it strikes to count. If the ball strikes near a seam, and any doubt arises as to which pocket the ball hits, pocket of highest value counts.

#### INSTRUCTIONS FOR ERECTION OF INDOOR GOLF NETS

First, hang the back driving canvas by ropes from the ceiling, leaving about three inches lying on the floor. There should be at least one and one-half feet between the driving canvas and the back wall, and at least two feet away from the side walls; if there is more than one net, they should be two or three feet apart. The side and top nets are then hooked to the back driving canvas and attached to the ceiling. Leave about a foot of these nets lying on the floor so that there is plenty of slack to stop a rebound of the ball. The rubber mat should be nailed on a board and then nailed to the floor about twenty-three feet from the back driving net. The cocoa mat can be used on either side for left or right hand players. Do not attach the cocoa mat to the floor. Lay Putting Carpet on the floor, tack it down, and cut a hole in the floor about three feet from the end nearest the net. Make a mixture of sand and oil, seeing that the sand is thoroughly dry. Cover the putting carpet with this mixture and it will make the best possible putting.

Complete Catalogue Golf Equipment sent on request.

ALL PRICES SUBJECT TO CHANGE WITHOUT NOTICE. ALL ORDERS WILL BE ACCEPTED ONLY SUBJECT TO OUR ABILITY TO SUPPLY THE GOODS. PRICES SHOWN ARE THOSE IN EFFECT ON DATE NOTED BELOW.



# ROLLER POLO

## SPALDING BALL BEARING ROLLER SKATES

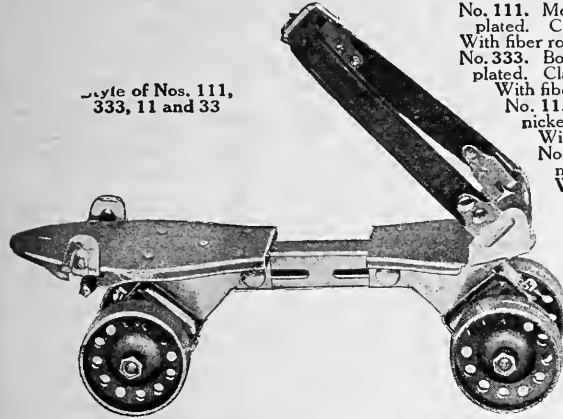

Style of Nos. 111,  
333, 11 and 33

- No. 111. Men's, adjustable from 10 to 11½ inches. Nickel-plated. Clamp toe, single strap heel. . . . Pair, \$3.50  
With fiber rollers instead of steel. . . . 5.00
- No. 333. Boys', adjustable from 7½ to 9½ inches. Nickel-plated. Clamp toe, single strap heel. . . . Pair, \$3.50  
With fiber rollers instead of steel. . . . 5.00
- No. 11. Men's, similar to No. 111, but plain white nickel-plated and not polished. . . . Pair, \$3.00  
With fiber rollers instead of steel. . . . 4.50
- No. 33. Boys', similar to No. 333, but plain white nickel-plated and not polished. . . . Pair, \$3.00  
With fiber rollers instead of steel. . . . 4.50

- No. 222 Women's, adjustable from 10 to 11½ in. Nickel-plated. Clamp toe. Solid leather cup heel. . . . Pair, \$3.50  
With fiber rollers instead of steel. . . . 5.00
- No. 444. Misses', adjustable from 7½ to 9½ inches. Nickel-plated. Clamp toe. Solid leather cup heel. . . . Pair, \$3.50  
With fiber rollers instead of steel. . . . 5.00
- No. 22. Women's, similar to No. 222, but plain white nickel-plated and not polished. . . . Pair, \$3.00  
With fiber rollers instead of steel. . . . 4.50
- No. 44. Misses', similar to No. 444, but plain white nickel-plated and not polished. . . . Pair, \$3.00  
With fiber rollers instead of steel. . . . 4.50

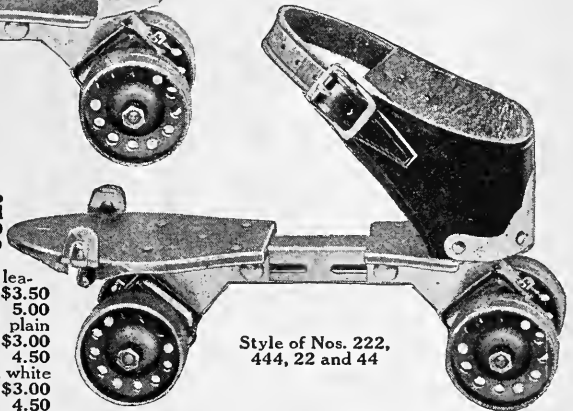

Style of Nos. 222,  
444, 22 and 44

### RELATIVE SIZES OF SHOES AND RINK SKATES

Size of Skate . . . . .	8 in.	8½ in.	9 in.	9½ in.	10 in.	10½ in.	11 in.	11½ in.	12 in.
Size of Shoe . . . . .	1, 1½, 2	2½, 3	3½	4, 4½, 5	5½, 6, 6½	7, 7½	8, 8½	9, 9½	10, 10½

## SPALDING ROLLER POLO STICKS AND BALLS

### Spalding Roller Polo Sticks

- No. B. "Standard," selected second growth ash. . . . Each, 25c.
- No. C. "Junior." . . . . . " 10c.
- No. D. Boys'. . . . . " 5c.

### Spalding Polo Balls

- Polo Ball No. 1. "Official." Made correct and uniform. . . . . Each, \$1.00

Jerseys listed on Page 16. Knee Pants, Page 27.  
Stockings, Page 15. Supporters and Protectors,  
Page 14.

### Extra Rollers for Spalding Ball Bearing Skates



- No. SB. All steel used on Nos. 111 to 444 and 11 to 44. . . . Each, 15c.
- No. FB. Wood fiber, as used on Nos. 111 to 444 and 11 to 44. Each, 50c.



Front View  
No. SB Roller



Side View  
No. SB Roller

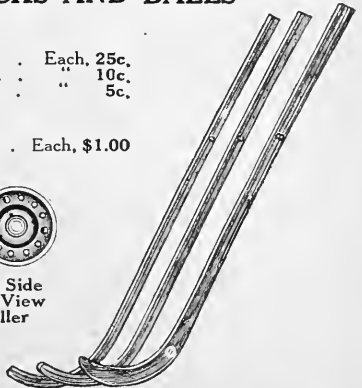

### Key for Spalding Patent Roller Skates

- No. SK No. SK. Steel, nickel-plated. . . . Each, 10c.

ALL PRICES SUBJECT TO CHANGE WITHOUT NOTICE. ALL ORDERS WILL BE ACCEPTED ONLY SUBJECT TO OUR ABILITY TO SUPPLY THE GOODS. PRICES SHOWN ARE THOSE IN EFFECT ON DATE NOTED BELOW.



### Figure 8 Guard Fencing Foils

- No. 7. Iron mountings, corded handle. . . . . Pair, \$2.00
- No. 11. Blued mountings and 34-inch blade. " 3.00
- No. 18. Mountings of brass, and 34-in. blade. " 3.50
- No. 17. Special "Club" Foil, nickel-plated and polished, and 34-inch blade. . . . . Pair, \$5.00

### Bell Guard Fencing Foils

- No. 15. Mountings nickel-plated; 34-in. blade. Pr. \$3.00
- No. 23. Mountings nickel-plated and highly polished; fine 34-inch engraved blade . . . . . Pair, \$6.00

### Fencing Swords

- No. 30. Broadswords, wood. . . . . Pair, \$2.50

### Fencing Sticks

- No. 40. Sticks, complete. . . . . Pair, 80c.
- No. 41. Willow basket handles. . . . . " 40c.
- No. 42. Hickory sticks only. . . . . " 40c.

### Foil Blades

- No. B. Fine Coulaux or Brunon Steel Blades, 34-inch. . . . . Each, 70c.
- No. C. Rubber Foil Buttons. . . . . Pair, 10c.

### Spalding Foil Masks

- Close mesh and strongly made. Trimmings with black patent leather, padded head spring and chin piece.
- No. 1. Face guard only. . . . . Pair, \$3.50
  - No. 2. Face and ear guards. . . . . " 4.50
  - No. 3. Face, ear and forehead guards. . . . . " 5.00

### Spalding Fencing Plastrons

Supplied on Special Order Only

- Good quality leather; heavily padded and quilted.
- No. 2. Chest and right side. . . . . Each, \$3.00
  - No. 3. Chest and right and left side. . . . . " 3.50
  - No. 3L. Women's. Same as No. 3, but shaped for waist. . . . . Each, \$3.50

ALL PRICES SUBJECT TO CHANGE WITHOUT NOTICE. ALL ORDERS WILL BE ACCEPTED ONLY SUBJECT TO OUR ABILITY TO SUPPLY THE GOODS. PRICES SHOWN ARE THOSE IN EFFECT ON DATE NOTED BELOW.

### Spalding Foil Gloves

Made in Rights or Lefts

- No. 1. Short soft leather cuff, nicely padded. Ea., \$1.75
- No. 2. Gauntlet of soft leather, nicely padded. " 2.00
- No. 3. Patent leather, stiff elbow gauntlet, padded. 2.50
- No. 6. Ladies' White Buck Gauntlet Glove. Each, 2.00
- No. 61. White buck, with Gauntlet. . . . . " 2.50
- No. 63. White buck leather, soft gauntlet. " 2.50

### Spalding French Duelling Gloves

(Mousquetaire Pattern)

- No. D. Soft leather, extra long soft gauntlet. Ea., \$2.50

### Spalding Broadsword Gloves

- No. 5. Full padded, stiff elbow gauntlet. Each, \$5.00
- No. 7. Same as above, but shorter cuff. " 4.25

### Spalding Fencing Shoes



No. L. Fencing Shoe

No. L. Drab glove leather, red trimmings. Not carried in stock; supplied on special order only. Specify on order if to be made with or without toe extension sole, and on which shoe. . . . . Pair, \$5.00

No. LW. Women's. Otherwise same as No. L. " 5.00



# DUMB BELLS

## SPALDING SPRING GRIP DUMB BELLS

Manufactured by A. G. Spalding & Bros.

These dumb bells are made in two halves connected by steel springs—as specified in the Sandow patent, which expired August 8, 1916—the effort necessary in gripping, making it necessary to continually devote the whole mind to each movement. This concentration of will power on each muscle involved is what is responsible for the great results obtained through properly exercising with them.

### BLACK ENAMELED BELLS, SPRINGS NICKEL-PLATED AND POLISHED

No. 6. MEN'S.	Seven steel springs.	Pair, \$2.50
No. 5. MEN'S.	Five steel springs.	" 2.00
No. 4. LADIES'.	Five steel springs.	" 1.50
No. 2. BOYS'.	Four steel springs	" 1.25

Spalding Patent Spring Grip Dumb Bells are used by all the greatest athletes in their training.

### SPALDING TRADE-MARK WOOD DUMB BELLS

Model AW. Stained Finish

Good material and superior in shape and finish to best wood dumb bells of other makes. Each pair wrapped in paper bag. Weights specified are for each bell.

½ lb. Pr., 35c.	★ \$3.36 Doz.	¾ lb. Pr., 40c.	★ \$3.90 Doz.	1 lb. Pr., 45c.	★ \$4.44 Doz.
1½ lb. Pair, 55c.	★ \$5.70 Doz.	2 lb. Pair, 70c.	★ \$7.20 Doz.		

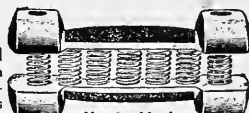

No. 6. Men's



No. 4. Ladies'



No. 2. Boys'

### SPALDING IRON DUMB BELLS

Made on approved models, nicely balanced and finished in black enamel. Sizes 2 to 40 lbs. . . . . Pound 6c. ★ 5c. lb. Over 40 lbs. Pound 8c. ★ 6½c. lb. Bar Bells, weight 25 lbs. or more for complete Bar Bell, supplied regularly with steel handles, length 3 feet between bells. . . . . 12c. lb. ★ 10½c. lb. Bar Bells, weight 25 lbs. or more for complete Bar Bell, with steel handles, either shorter or longer than regular length, as noted above. . . . . 15c. lb. ★ 13½c. lb.

Prices for Bar Bells, weighing other than above, quoted on application. Quantity prices in italics will be allowed on 25 lbs. or more of iron dumb bells or 100 lbs. or more of bar bells.

### SPALDING NICKEL-PLATED DUMB BELLS

Nickel-Plated and Polished

No. 1N. 1 lb. Pr., .40	★ \$4.32 Doz.	No. 3N. 3 lb. Pr., .95	★ \$10.26 Doz.
No. 2N. 2 lb. .65	★ 7.03 "	No. 4N. 4 lb. " 1.15	★ 13.42 "
		No. 5N. 5 lb. Pair, 1.35	★ \$14.58 Doz.

Orders for other weights than 1 to 5 lbs., as listed, cannot be accepted.

### SPALDING TRADE-MARK INDIAN CLUBS—Stained Finish

Good material, and far superior in shape and finish to the best clubs of other makes. Furnished in two popular models. Each pair wrapped in paper bag.

Model BS—Weights specified are for each club.			
¾ lb. Pr., 35c.	★ \$3.36 Doz.	1½ lb. Pr., 55c.	★ \$5.76 Doz.
¾ lb. Pr., 40c.	★ 3.96 "	2 lb. " 70c.	★ 7.20 "
1 lb. " 45c.	★ 4.44 "	3 lb. " 85c.	★ 9.12 "

### SPALDING EXHIBITION CLUBS

Handsomely finished in ebonite; for exhibition and stage purposes. Clubs are hollow, with large body, and although extremely light, represent a club weighing 3 lbs. or more.

No. A. Ebonite finish. Pair, \$3.50. No. AA. With German silver bands. Pair, \$5.00

### INDIAN CLUB AND DUMB BELL HANGERS

Made of Iron and Nicely Japanned

No. 1. . . . .	Pair, 15c.	★ \$1.68 Doz.
No. 1M. Mounted on oak strips. . . . .	" 25c.	★ 2.70 "

### SAVAGE BAR BELL

Especially designed by Dr. Watson L. Savage

Model S. Has large pear shaped ends, with a flexible hickory shaft ¼-inch in diameter, producing a vibratory exercise similar to that obtained with the French wand. . . . . Each, 50c. ★ \$5.40 Doz.



No. A No. AA Model BS

### SPALDING ASH BAR BELLS

### SCHOOL WAND

### CALISTHENIC WAND

No. 3. 3½ feet long. Straight grain maple, black finish. Each, 12c. ★ \$1.20 Doz.

No. 4. 4½ feet long. 1 inch diameter. Black finish. Each, 15c. ★ \$1.44 Doz.

The prices printed in italics opposite items marked with ★ will be quoted only on orders for one dozen pairs or more on sizes up to one pound, and on one-half dozen pairs or more on sizes over one pound in weight. Quantity prices will NOT be allowed on items NOT marked with ★. On Wands and Bar Bells quantity prices will be allowed on one-half dozen or more.

ALL PRICES SUBJECT TO CHANGE WITHOUT NOTICE. ALL ORDERS WILL BE ACCEPTED ONLY SUBJECT TO OUR ABILITY TO SUPPLY THE GOODS. PRICES SHOWN ARE THOSE IN EFFECT ON DATE NOTED BELOW.



## SPALDING CHEST WEIGHT MACHINES

The movements for which these machines were specially designed are calculated to correct defects incident to school and office work, correct flat chest, round shoulders, forward head, regulate digestion and assist nature in the elimination of the waste products of the system, and in conjunction with the bath to produce that buoyant feeling which makes life really worth living. To get best results enter into the exercises as described and illustrated in "Pulley Weight Exercises." Spalding Athletic Library, No. 22R, price 25 cents, with your whole being, so as to induce copious perspiration.

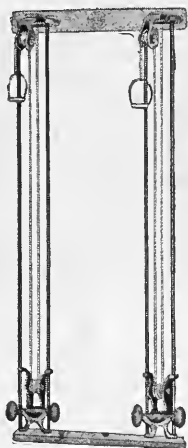

No. 2

### Spalding Chest Weight No. 2

No. 2. A good machine for home use; noiseless and durable. Well made and easy running. Rods are  $\frac{3}{8}$ -inch coppered spring steel. Weights are 5-lb. iron dumb bells, one to each carriage, and may be removed and used as dumb bells. Wall and floor boards are hard wood, nicely finished and stained. All castings heavily japanned. Every part of machine guaranteed free of defect. . . . . Each, \$6.00



No. 12

### Spalding Chest Weight No. 12

No. 12. Especially designed for home exercise. High grade in every particular. Cast iron parts are all nicely japanned. The wheels are iron, turned true on centers, and have hardened steel cone point bearings. Guide rods are spring steel, copper-plated. Weight carriage has removable felt bushings, noiseless and durable. Each handle is equipped with 10 pounds of weights. . . . . Each, \$12.00

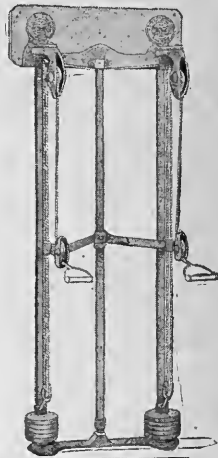

No. 5

### Spalding Chest Weight No. 5

No. 5. Because of its adjustment feature, which permits of all lower, as well as direct chest movements, this machine really combines two machines in one, and is particularly suitable where space is a consideration. The various changes are made by raising or lowering the center arm, requiring but a few seconds. Japan finish. Each machine is equipped with 16 pounds of weights. . . . . Each, \$15.00  
Extra weights for above machine,  $1\frac{1}{4}$  lbs. . . . . .20

Rowing Attachment for No. 5 Chest Weight Shown on Page 47

### Spalding Chest and Neck Attachment

For business men. Overcomes tendency to forward head, due to continuous work at desk. For women, will help develop a nicely rounded neck.

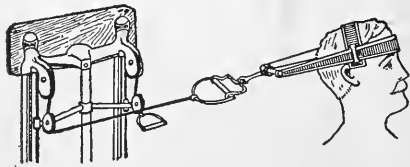

No. 3. Heavy cowhide. Ready for use by simply snapping to one of the handles or both. . . . . Each, \$1.50

### Spalding Foot and Leg Attachment

This provides a local exerciser for all muscles of the leg. As such it is an excellent device for strengthening weak muscles, toning up others, giving exercise to stiff joints.

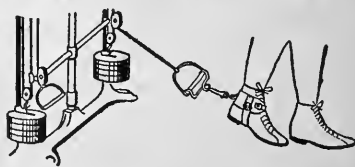

No. 2. Heavy cowhide. Readily attached to one handle or both; can be worn with or without shoe. Each, \$1.50

ALL PRICES SUBJECT TO CHANGE WITHOUT NOTICE. ALL ORDERS WILL BE ACCEPTED ONLY SUBJECT TO OUR ABILITY TO SUPPLY THE GOODS. PRICES SHOWN ARE THOSE IN EFFECT ON DATE NOTED BELOW.



## SPALDING CHAIN BELT ROWING MACHINE No. 600

Suitable Alike for the Athlete or the Ordinary Man or Woman

No. 600. The ideal boat for home use and training purposes. Brings the exercise usually obtained on river or lake into the home or bedroom. Fitted with roller seat and adjustable shoes to fit either a tall or a short person. Thumb-nut arrangement controlling belt allows more or less friction to be thrown into the running parts, imitating the resistance which exists when forcing a row boat through the water. The resistance may be reduced for the weaker sex or increased to suit the strongest athlete. Oars are pivoted in such a way that operator can handle and turn them same as he would during the return and feathering motion with a boat oar. Floor space required, 6 x 5 feet. . . . . Each, \$30.00

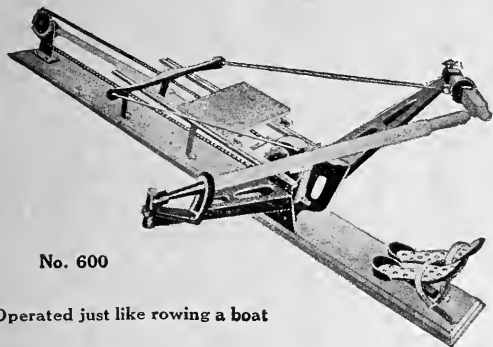

No. 600

Operated just like rowing a boat

## SPALDING FRICTION ROWING MACHINE No. 119

No. 119. The means used to produce the resistance is a simple friction clutch, which takes instant hold at the commencement of the stroke and retains the pressure till its completion, when it instantly releases it, precisely as in a boat. Quickly taken apart without loosening any bolts or screws. Each machine is adjustable to any amount of friction or resistance. *Do not use oil on friction cylinder. If its action is not perfectly smooth a little clear soap rubbed on its surface will properly correct its action.* Floor space required, 4½ x 4½ feet. . Complete, \$20.00

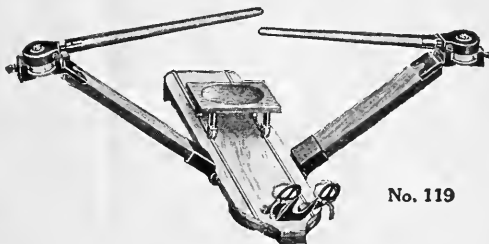

No. 119

## SPALDING ROWING ATTACHMENTS

For use with No. 5 Chest Weight Machines

Particularly suitable for home use. Can be detached from the weight machine quickly and put away in a very small space until the next opportunity for use presents itself. To be used in connection only with chest weights, like Spalding No. 5 (see page 46) which have center arm adjustment, or with handles arranged so that they can be pulled from a bracket close to the floor.

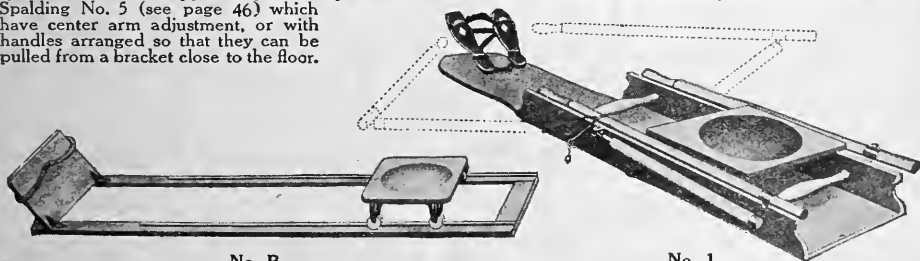

No. R

No. 1

No. R. Designed to fill the demand for a low priced article of this kind, built along substantial lines. Gives entire satisfaction. Floor space required, 4½ feet x 12 inches. . . . . Complete, \$7.50

No. 1. This attachment, as will be noted, has out-riggers and arms similar to rowing machine, and offers a great variety of work when used in connection with chest weight. Floor space required, 4½ x 4½ feet. . . . . Complete, \$10.00

NOTE—These rowing attachments, Nos. 1 and R, can be used only in connection with the No. 5 Type of Chest Weight Machine with Center Bar, shown on Page 46 of this catalogue.

ALL PRICES SUBJECT TO CHANGE WITHOUT NOTICE. ALL ORDERS WILL BE ACCEPTED ONLY SUBJECT TO OUR ABILITY TO SUPPLY THE GOODS. PRICES SHOWN ARE THOSE IN EFFECT ON DATE NOTED BELOW.



## Spalding Adjustable Doorway Horizontal Bar

No. A. Bar of selected hickory, having steel tubular ends into which iron sockets screw, holding rubber cushions. The socket on one end contains a left-hand thread, on the other end a right-hand thread. By fitting the bar in the doorway and turning it with the hands the ends are made to expand, and the friction applied by the rubber against the sides of the doorway is sufficient to sustain the weight of a heavy man.

This bar may be used for chinning exercises, being adjustable to any height, also for abdominal work. Size of doorway in which bar will be used must be stated when ordering, as the adjustment is not great enough to meet all requirements in one size bar. . . . . Each, \$5.00

This No. A Bar is supplied regularly to fit any doorway under 33 inches in width.

Bars to fit wider doorways. . . . . Extra, 50c.

Should not be used in doorways wider than 42 inches. If length more than 42 inches is required, it would be advisable to use a regular horizontal bar. Various styles listed below.

## Spalding Doorway Horizontal Bar

No. 101. The keys fastened to each end of bar fit in the side sockets, which are secured to door jamb and hold the bar firmly in place. The parts are all malleable iron, very light, yet strong enough to sustain the heaviest man. The bar may be quickly removed when not in use leaving no projecting part. Complete, with parts. . . . . \$2.50

This No. 101 Bar is supplied regularly to fit any doorway under 37 inches. Bars to fit wider doorways, extra, 50c. Should not be used in doorways wider than 42 inches. If length more than 42 inches is required, it would be advisable to use a regular horizontal bar. Various styles listed below.

Extra sockets for doorway. . . . . Pair, 50c.

With two pairs of sockets bar may be used for either chinning or abdominal exercises.

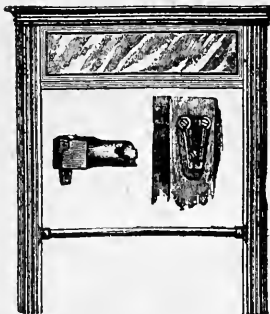

## Spalding Home Parallel Bar

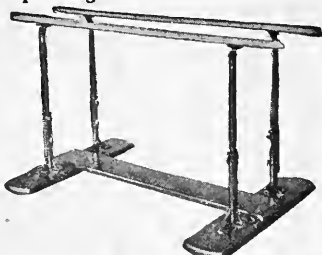

No. 101. Adjustable in height. Base is of hard wood, the uprights are iron and free from any dangerous projections or corners. Hand rails 8 feet long, regular, but may be furnished in any desired length at additional cost. Floor space required, 8 ft. by 4½ ft. Complete, \$35.00

No. 102. Similar to the No. 101 but not adjustable. Floor space required, 8 ft. by 4½ ft. Complete, \$25.00

## Spalding Wall Horizontal and Vaulting Bar

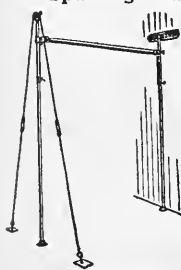

Vaulting Bar in Position

No. 74. An ideal combination where space is an important consideration. Uprights are cold-rolled steel, polished and nickel-plated, and have engraved graduations. The bar proper is selected hickory, with special spring steel core. Floor space required, 6 feet by 5 feet. Height, 7¼ ft. . . . . Complete, \$35.00

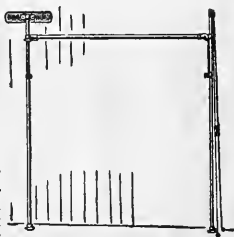

Vaulting Bar Folded Back Against Wall

Spalding Catalogue of Equipment for Gymnasiums sent on application, to interested parties

## Spalding Floor Horizontal Bars

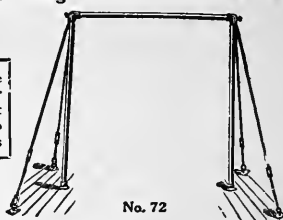

No. 72

No. 72. Wrought iron pipe uprights, detachable iron head pieces, steel guy wires, wrought iron turn-buckles and floor plates; steel core bar. . . . Complete, \$30.00

No. 73. Same as our No. 72, but with solid hickory bar instead of steel core bar. . . . Complete, \$25.00

No. 75. Iron uprights and guys, solid hickory bar. 20.00

Floor space required for either Nos. 72, 73 or 75, 9 feet by 6 feet. Height, 7 3-4 feet.

## Spalding Horizontal Bars



### Steel Core Bars

Hickory bars with core made of special spring steel.

No. 112. 5½ feet. . . . . \$7.50

No. 113. 6 feet. . . . . 8.00

No. 114. 6½ feet. . . . . 8.50

No. 115. 7 feet. . . . . 9.00

### Solid Hickory Bars

Made of selected second growth hickory.

No. 116. 4 feet. . . . . \$2.00

No. 117. 4½ feet. . . . . 2.50

No. 118. 5 feet. . . . . 2.75

No. 119. 5½ feet. . . . . 3.00

No. 120. 6 feet. . . . . 3.25

No. 121. 6½ feet. . . . . 3.50

ALL PRICES SUBJECT TO CHANGE WITHOUT NOTICE. ALL ORDERS WILL BE ACCEPTED ONLY SUBJECT TO OUR ABILITY TO SUPPLY THE GOODS. PRICES SHOWN ARE THOSE IN EFFECT ON DATE NOTED BELOW.





# SWINGING RINGS

## Spalding Home Gymnasium

Combining Swinging Rings, Trapeze, Stirrups, and Swing. Should be in every home where there are growing boys and girls. Simplest and best form of exercise for them.

No. 1. Apparatus is supported by two strong screw-hooks in ceiling, about eighteen inches apart. Can be used out of doors. Straps of extra strong webbing, adjustable to any desired height; rings heavily japanned. Apparatus put up in any room and removed in a moment, leaving only two hooks in ceiling visible. Various combinations can be quickly and easily made. We furnish, in addition, a board adjustable to stirrups, which forms an excellent swing.

Complete, ready to put up, \$7.50

## Spalding Adjustable Trapeze and Swinging Rings

Furnished complete; everything necessary for suspending. The supports are made of extra strong webbing. Perfectly safe under all conditions, and with the adjustable buckle, may be adapted to any ceiling from 16 feet down.

- No. 201. Trapeze. . . . . Each, \$5.00
- No. 301. Swinging Rings. Complete, with 6-inch Japanned Swinging Rings. Pair, \$5.00



Showing complete outfit with exception of trapeze bar which is supplied



Showing Swinging Ring or upper portion of outfit



Showing upper part of Apparatus with Trapeze Bar attached



## Spalding Wooden Exercising Rings

- No. 1. Made of three thicknesses black walnut and maple glued together, with grain crossing. . . . . Pair, \$1.00
- No. 2. Made of one piece solid maple, nicely finished. . . . . Pair, 75c.



## Spalding Swinging Rings

Japanned iron, 6 in. diameter, inside measurement. COMPLETE FOR HOME USE

- No. 1. With 5-foot ropes. . . . . Pair, \$3.50
- No. 2. With 6-foot ropes. . . . . " 3.75
- No. 3. With 7-foot ropes. . . . . " 4.00
- No. 4. With 8-foot ropes. . . . . " 4.25

Rings, leather covered, \$5.00 pair, extra.

WITHOUT ROPES AND CLAMPS

- No. 10. 6-inch. . . . . Pair, \$1.25
- No. 20. 8-inch. . . . . " 1.75
- No. 30. 10-inch. . . . . " 2.25

Sizes mentioned are inside measurements. Rings, leather covered, \$5.00 pair, extra.



No. 201 Adjustable Trapeze



No. 301. Adjustable Swinging Rings

## Spalding Single Trapeze

COMPLETE FOR HOME USE

Prices, including 8 feet of rope or less.

- No. 1. 2 1/2 foot bar. Each, \$3.00
- No. 2. 3 foot bar. Each, \$3.25
- No. 3. 3 1/2 foot bar. Each, \$3.50

## Spalding Trapeze Bars

WITHOUT ROPE

- No. 1B. 2 1/2 feet long, bars only. . . . . Each, \$1.25
- No. 2B. 3 feet long, bars only. . . . . " 1.50
- No. 3B. 3 1/2 feet long, bars only. . . . . " 1.75

## Spalding Mattresses

Covered with best No. 10 white duck, filled with two layers of best one-inch hair felt, closely tufted and strongly sewed. Two inches thick.

- No. 00. Size 3 x 5 feet. . . . . Each, \$10.00
- No. 01. Size 4 x 6 feet. . . . . " 15.00
- No. 02. Size 5 x 6 feet. . . . . " 18.00
- No. 03. Size 5 x 10 feet. . . . . " 30.00

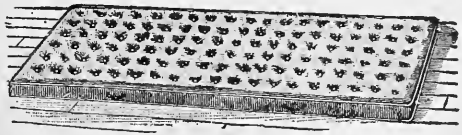

## Special Wrestling Mattresses

Cover heavy quality duck, closely tufted, two inches thick. Complete with corduroy cover to lay over mat and allow six-inch margin on all sides.

- No. WX. Size 12 x 12 feet. . . . . Each, \$100.00
- No. WXX. Size 15 x 15 feet. . . . . Each, \$150.00

Wrestling Tights, Pads and other equipment listed on Page 27. We make special mats with extra heavy covering for gymnasium use. Prices quoted on application.

ALL PRICES SUBJECT TO CHANGE WITHOUT NOTICE. ALL ORDERS WILL BE ACCEPTED ONLY SUBJECT TO OUR ABILITY TO SUPPLY THE GOODS. PRICES SHOWN ARE THOSE IN EFFECT ON DATE NOTED BELOW.



## SPALDING BOXING GLOVES

"CHAMPIONSHIP" STYLES



No. 118



No. 118



No. 115



No. 116

No. 118. 8-ounce. Highest grade made.  
Set of four gloves, \$10.00

No. 115. 5-ounce. . . . Set of four gloves, \$8.00  
No. 116. 6-ounce. . . . Set of four gloves, 9.00

Spalding Boxing Gloves have been used and endorsed by all Champions of the World since the days of John L. Sullivan.

All Spalding Boxing Gloves are hair filled. No cotton or carpet flock is used.



No. 18N



No. 218



No. 12

No. 18N. Set of four gloves. \$8.00  
Spalding Navy "Special" Championship Gloves. Used by the champions of the navy. Special "Sea Green" leather of particularly durable quality; furnished in 8-oz. only; padded laced wristband; patent palm lacing and patent palm grip.

No. 218. Set of four gloves. \$8.00  
Spalding "Club Special" Gloves. 8-oz "Championship" model, full size. Good quality glove leather and careful workmanship. Padded wrist, patent palm lacing and patent palm grip. Superior to any of the gloves put out in imitation of our "Championship" styles.

No. 12. Set of four gloves. \$7.50  
Spalding "Member Special" Gloves. 8-ounce Corbett pattern, good size. Black glove leather trimmed with red leather. Padded wrist, special padded thumb, patent palm lacing and patent palm grip. One of the most practical gloves ever made.

Boxing Shirts, Tights and Trunks listed on Pages 26, 27. Boxing Shoes, Page 30. Supporters, Page 14.

See Nose and Ear Protecting Helmet for Boxing, Page 53

ALL PRICES SUBJECT TO CHANGE WITHOUT NOTICE. ALL ORDERS WILL BE ACCEPTED ONLY SUBJECT TO OUR ABILITY TO SUPPLY THE GOODS. PRICES SHOWN ARE THOSE IN EFFECT ON DATE NOTED BELOW.



## SPALDING BOXING GLOVES



No. 110

No. 110

No. 110. Set of four gloves, \$11.00

**Pupils' Double Wrist Pad.** Large model. Best grade brown glove leather, additionally padded on the forearm and over the wrist to prevent that soreness which is one of the most discouraging features following a brisk lesson in the art of "blocking." Made after the suggestion of one of the most prominent athletic officials in this country. Patent palm grip and palm lacing.



No. 100

No. 100

No. 100. Set of four gloves, \$10.00

**Instructors' 10-ounce.** Special thumb model. Best grade brown boxing glove leather, extra heavily padded over the knuckles and with special large padded thumb to prevent injury to either instructor or pupil. The leather in this glove is particularly durable, and it does not get hard or ruff up when wet or subject to severe usage. Used by the instructors in most of the large gymnasiums and boxing schools and by many prominent pugilists in training. Lace extra far down for ventilation. Patent palm grip.

All Spalding Boxing Gloves are padded with hair. No cotton or carpet flock is used.



No. 14



No. 14

No. 14. Set of four gloves, \$6.00

**5-ounce Regulation.** Brown glove leather. Special padded thumb, wrist and heel; patent palm lacing and palm grip. Used by some of the best organizations for their club contests.



No. 15



No. 15

No. 15. Set of four gloves, \$7.00

**8-ounce Corbett Pattern.** Special olive tanned leather; padded wristband; patent palm lacing; patent palm grip. The proper glove for friendly bouts and use at home.

Boxing Shoes, see Page 30; Tights, see Pages 26, 27. Supporters, see Page 14.  
Nose and Ear Protecting Helmet, see Page 53.

ALL PRICES SUBJECT TO CHANGE WITHOUT NOTICE. ALL ORDERS WILL BE ACCEPTED ONLY SUBJECT TO OUR ABILITY TO SUPPLY THE GOODS. PRICES SHOWN ARE THOSE IN EFFECT ON DATE NOTED BELOW.

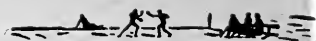

## SPALDING BOXING GLOVES

STYLES FOR FRIENDLY BOUTS AND PRIVATE USE



No. 19



No. 19



No. 21



No. 21

No. 19. Set of four gloves, \$6.50

7-ounce Corbett Pattern. Dark wine color leather. Patent palm lacing. One of the most popular styles. Very durable.

No. 21. Set of four gloves, \$6.00

8-ounce Regular Pattern. Wine color, with brown palm. Patent palm lacing. Padded cuffs.



No. 23

All Spalding Boxing Gloves are padded with hair. No cotton or carpet flock is used.

No. 23. Set of four gloves, \$5.50

New Style Turned End Pattern. Wine colored leather, with brown palm, correctly padded, and patent palm lacing.

No. 24L. Set of four gloves, \$5.00

Brown leather, with khaki palm; padded leather wrist; palm grip and palm lacing.

No. 24K. Set of four gloves, \$4.00

Brown leather, with khaki palm and unpadded wrist; palm grip; not palm lacing.

No. 21F. Set of four gloves, \$4.00

Brown Leathosuede, with moleskin palm; palm lacing; padded wrist.



No. 23

No. 23F. Set of four gloves, \$2.50

Brown Leathosuede, with khaki palm and unpadded wrist; not palm lacing.

No. 24C. Set of four gloves, \$2.00

Gray canton flannel, with khaki palm and unpadded wrist; not palm lacing.

Boxing Shoes, see Page 30. Tights, see Pages 26, 27. Supporters, see Page 14  
Nose and Ear Protecting Helmet, see Page 53

ALL PRICES SUBJECT TO CHANGE WITHOUT NOTICE. ALL ORDERS WILL BE ACCEPTED ONLY SUBJECT TO OUR ABILITY TO SUPPLY THE GOODS. PRICES SHOWN ARE THOSE IN EFFECT ON DATE NOTED BELOW.



# BOXING GLOVES

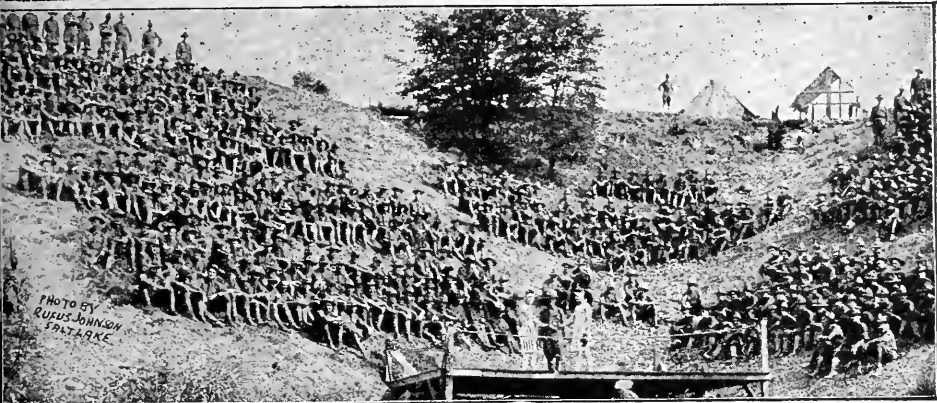

BOXING MATCH IN A NATURAL AMPHITHEATRE IN TEXAS

## SPALDING YOUTHS' BOXING GLOVES

Youths' Boxing Gloves made in exactly the same manner and of similar material to full size gloves and are warranted to give satisfaction.



No. 40



No. 40



No. 25K



No. 25K

No. 40. Set of four gloves, \$5.00

Youths' Size, Turned End Pattern. Wine colored leather, well padded. Patent palm grip; patent palm lacing.

No. 40F. Set of four gloves, \$3.00

Brown Leathosuede with moleskin palm; padded wrist and palm grip; palm lacing.

No. 25K. Set of four gloves, \$3.50

Youths' Size, Regular Pattern. Soft tanned leather. Made with khaki palm.

No. 25F. Set of four gloves, \$2.00

Brown Leathosuede with khaki palm and unpadded wrist; not palm lacing.

No. 25C. Set of four gloves, \$1.50

Gray canton flannel with khaki palm and unpadded wrist; not palm lacing.



No. 25R. **BOXING.** Contains over 70 pages of illustrations showing all the latest blows. They are so arranged that any one can become a proficient boxer. The book also contains pictures of all the well known boxers; a history of boxing; how to box; the correct position; the hands, clenching the fist; the art of gauging distance; the first principles of hitting; he elements of defence; feinting; knockout blow; the chin punch; the blow under the ear; the famous solar plexus knock-out; the heart blow; famous blows and their originators; the kidney punch; the liver punch; the science of boxing; proper position of hand and arm; left hook to face; hook to jaw; how to deliver the solar plexus; correct delivery of a right uppercut; the side step; hints on training, diet and breathing; how to train; rules for boxing, etc., etc. Copy, 25c.

### Boxing Helmet



Complete protection for ears, nose and eyes. Well ventilated. Each, \$3.50

Boxing Shoes, see Page 30. Tights, see Pages 26, 27. Supporters, see Page 14.

ALL PRICES SUBJECT TO CHANGE WITHOUT NOTICE. ALL ORDERS WILL BE ACCEPTED ONLY SUBJECT TO OUR ABILITY TO SUPPLY THE GOODS. PRICES SHOWN ARE THOSE IN EFFECT ON DATE NOTED BELOW.



## SPALDING SINGLE END STRIKING BAGS

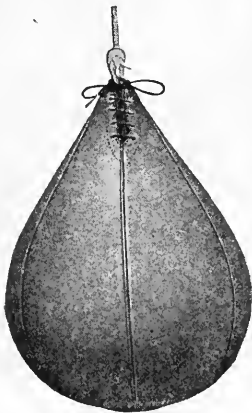

No. 20. Each, \$10.00



No. G. Each, \$9.00

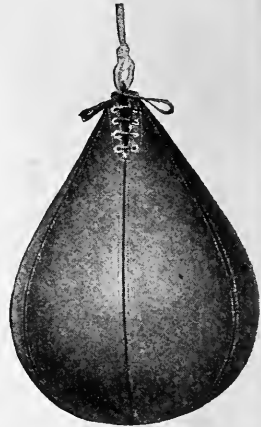

No. 18. Each, \$7.00

No. 20. Made of finest selected brown calfskin, with olive welted seams. A very fast and durable bag for all around use. . . . . Each, \$10.00

No. 20G. Model of our popular No. 20 bag, but made of black horsehide. Very durable. . . . . " 9.00

No. G. This is a heavy, durable gymnasium bag, suitable for all around exercise work and the strongest bag made. The cover is of heavy English grain leather, same as used in our best grade foot balls and basket balls and made in the same way. It will outlast two or three bags of any other make. With loop top. . . . . Each, \$9.00

No. 18. The "Fitzsimmons Special." Made of finest selected olive Napa tanned leather, extra well made; double stitched; red welted seams and reinforced throughout. For training purposes particularly this bag will be found extremely satisfactory in every respect, . . . . . Each, \$7.00

No. 12. Olive tanned leather, specially selected; double stitched, red welted seams and reinforced throughout. Excellent for quick work.  
Each, \$6.00

No. 10. Specially tanned brown glove leather; double stitched, red welted seams and reinforced throughout. Very well made. . . . . Each \$5.00

No. 16. Extra fine tan colored leather, full size and lined throughout.  
Each, \$4.00

Striking Bag Disks and Platforms, see Page 57. Swivels, Page 55.

Shirts, Tights and Gymnasium Wear, see Pages 26, 27.

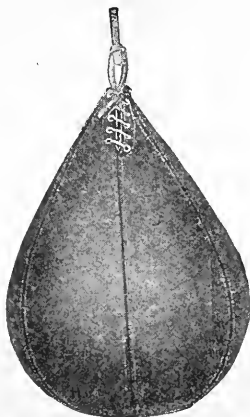

No. 12. Each, \$6.00

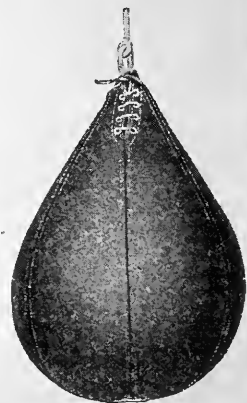

No. 10. Each, \$5.00

ALL PRICES SUBJECT TO CHANGE WITHOUT NOTICE. ALL ORDERS WILL BE ACCEPTED ONLY SUBJECT TO OUR ABILITY TO SUPPLY THE GOODS. PRICES SHOWN ARE THOSE IN EFFECT ON DATE NOTED BELOW.



# STRIKING BAGS

## SPALDING SINGLE END STRIKING BAGS

- No. 16. Extra fine tan colored leather, full size and lined throughout. . . . . Each, \$4.00
- No. 15. Made of olive tanned leather, full size and lined throughout, red welted seams. . . . . Each, \$3.50
- No. 17C. Tan corduroy, horsehide trimmed; leather welted seams. . . . . Each, \$3.50
- No. 17R. Hazel moleskin, leather reinforced top, large size. . . . . Each, \$3.00
- No. 14. Good quality all leather bag; lined throughout. . . . . Each, \$3.00
- No. 16K. Khaki, with leather reinforced top, welted seams. . . . . Each, \$2.50
- No. 15K. Khaki, leather reinforced top. . . . . Each, \$2.00
- No. 14K. Khaki, leather reinforced top. . . . . Each, \$1.50

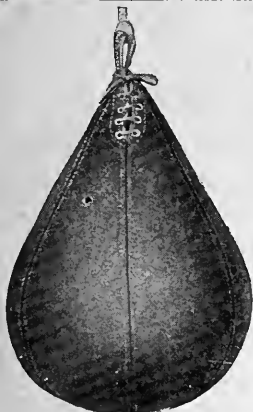

No. 16. Each, \$4.00

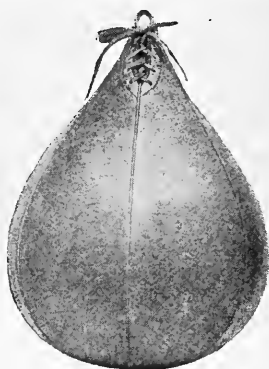

No. 15. Each, \$3.50

## STRIKING BAG BLADDERS



No. 17C. Each, \$3.50



No. 7



No. OS

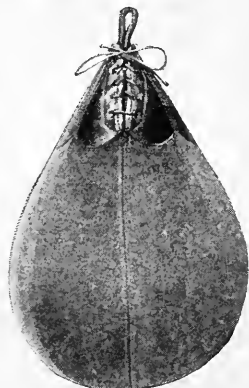

No. 17R. Each, \$3.00

- No. G. For No. G bag. . . . . Each, \$1.75
- No. OS. For any full size top stem bag. " 1.25
- No. 7P. For Nos. 20 and 20G bags. " 1.00
- No. 5. For Nos. 6 and 4 bags. " .90
- No. 5P. For Nos. 16, 12 and 10 bags. " .90
- No. B. For Nos. 3 1/2 and 2 bags. " .75
- No. BP. For Nos. 15 and 14 bags. " .75

The Bladders used in all our Striking Bags are fully guaranteed.

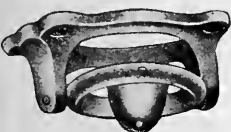

No. 4

## STRIKING BAG SWIVELS

- No. 4. A special swivel, made according to suggestions of experienced bag punchers, with features that overcome disadvantages of ordinary style. Rope can be changed instantly without interfering with any other part of swivel. . . . . Each, \$1.50
- No. 5. Nickel-plated swivel with removable socket for quickly suspending or removing bag without readjusting. . . . . Each, 75c.
- No. 12. Ball and Socket Action. Fastens permanently to disk, nickel-plated. . . . . Each, 25c.



No. 5.  
Top View.  
Showing opening for rope, which is removable.



No. 5.  
Under View.  
Showing neck of swivel, which is fastened permanently.

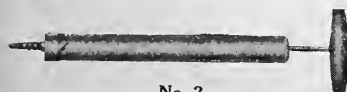

No. 2

## SPALDING BRASS INFLATERS

- No. 2. Club size, cylinder 1 1/2 inches. Each, 60c.
- No. 3. Small size. " 40c.

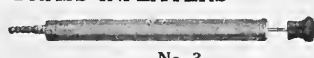

No. 3

ALL PRICES SUBJECT TO CHANGE WITHOUT NOTICE. ALL ORDERS WILL BE ACCEPTED ONLY SUBJECT TO OUR ABILITY TO SUPPLY THE GOODS. PRICES SHOWN ARE THOSE IN EFFECT ON DATE NOTED BELOW.



# STRIKING BAGS



## SPALDING DOUBLE END STRIKING BAGS



No. 6 Each, \$6.00

No. 6. Fine olive tanned leather cover, double stitched, red welted seams. Extra well made throughout. . . . Each, \$6.00

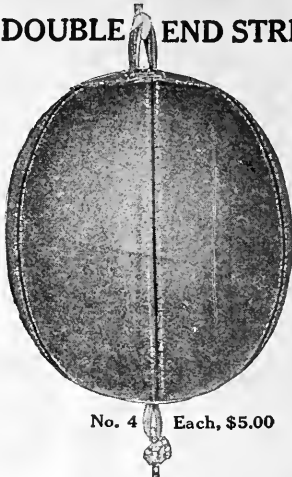

No. 4 Each, \$5.00

No. 4. Regulation size, tan colored leather cover, well made throughout, double stitched. . . . Each, \$5.00



No. 5C Each, \$4.00

No. 5C. Corduroy, horsehide trimmed and reinforced top, leather welted seams. Each, \$4.00

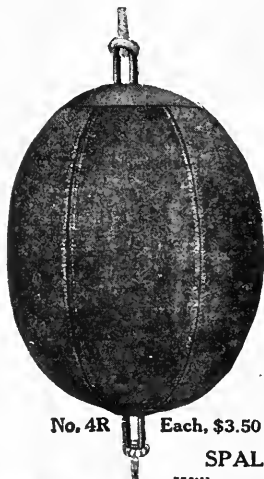

No. 4R Each, \$3.50

No. 3½. Black leather, regulation size, lined throughout, red welted seams. . . . Each, \$4.00

No. 2. Medium size, good quality leather, lined throughout. . . . Each, \$3.50

No. 4R. Hazel moleskin, leather reinforced top. Large size. Each, \$3.50

No. 4K. Khaki, leather reinforced top, welted seams. . . . Each, \$3.00

No. 3K. Khaki, leather reinforced top, good size. . . . . Each, \$2.25

No. 2K. Khaki, leather reinforced top. . . . . Each, \$2.00

Spalding double end bags are arranged so that they may be hung in doorway of closet or some other out of the way place, enabling the flat dweller and others, who have little spare room, to provide themselves with the equipment needed for healthful exercise. All double end striking bags are supplied complete with guaranteed bladder, rubber cord for floor, lace for bag and rope for ceiling attachment. Bladders used in all our striking bags are fully guaranteed. Note special explanation of guarantee on tag attached to each bladder.

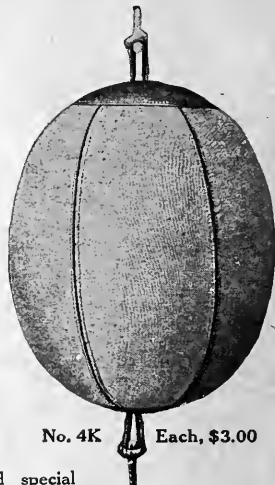

No. 4K Each, \$3.00

## SPALDING STRIKING BAG MITTS

Will protect the hands and are recommended for use with all Striking Bags.



No. 1



No. 4



No. 5

No. 1. Made of olive Napa leather and extra well padded; ventilated palm and special elastic wrist in glove. . . . . Pair, \$2.25

No. 2. Made of soft tanned leather, properly shaped and padded, substantially put together. . . . . Pair, \$1.75

No. 3. Made of soft tanned leather, padded and well made; also made in women's size. . . . . Pair, \$1.25

No. 4. Knuckle Mitt, well padded. . . . . " .75

No. 5. Knuckle Mitt, well padded. . . . . " .40

ALL PRICES SUBJECT TO CHANGE WITHOUT NOTICE. ALL ORDERS WILL BE ACCEPTED ONLY SUBJECT TO OUR ABILITY TO SUPPLY THE GOODS. PRICES SHOWN ARE THOSE IN EFFECT ON DATE NOTED BELOW.

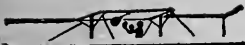

# PLATFORMS

## Spalding "Moline" Platform

No. 1. Adjustable in height, readily attached to any wall, and the side brackets so arranged that it touches three rows of studding. Neat in design and handsomely finished. Each platform supplied with everything necessary for attaching to wall, and crated ready for shipment.

Each, \$15.00

Bag is not included in above price.

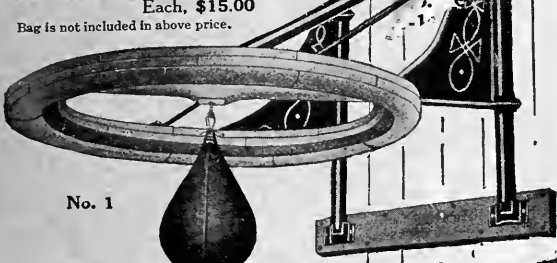

No. 1

## Spalding Moline Disk

No. 1D. Moline Adjustable Disk, including No. 5 Striking Bag Swivel. Combines the adjustable feature of our popular Moline Platform with the practical utility of the solid disk, making the best all-around striking bag disk now on the market.

Each, \$20.00

Bag is not included in above price.

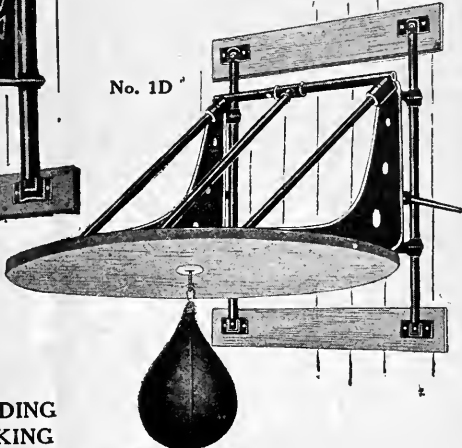

No. 1D

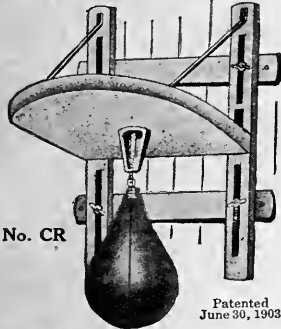

No. CR

Patented June 30, 1903

No. CR. Without Bag, \$8.00

## SPALDING STRIKING BAG DISKS

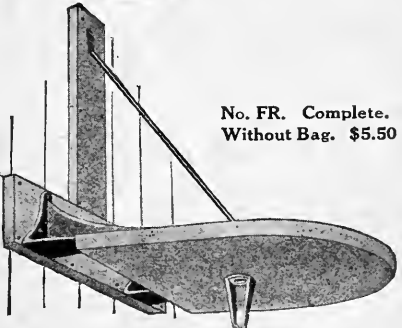

No. FR. Complete. Without Bag, \$5.50

No. CR. Patent adjustable style. Patented June 30, 1903. A striking bag disk must be substantial if it is to be of use, and in the two styles, both adjustable and braced, which we list, this feature has not been neglected, while we have striven to put out a disk which is suitable for home use and moderate in price.

Complete, without bag, Each, \$8.00

No. FR. Wall-braced style. Complete, without bag. Each, \$5.50

## Spalding Adjustable Disk Platform

No. PR. Can be put up in a very small space and taken down quickly when not in use by simply detaching the pipe fixture from the wall plate. The metal disk against which the bag strikes constitutes one of the best features ever incorporated in an arrangement of this character, rendering it almost noiseless and very quick in action. This disk also combines an adjustable feature that is simple to operate and makes it possible for various members of the family to use the same disk.

Complete, with special bag. Each, \$8.00

No. PR. Spalding Adjustable Disk Platform, without bag. . . . . 5.00

Unless otherwise specified on order No. PR platform will be sent WITH bag.

See list of Single End Bags on Page 54 of this catalogue, any of which are suitable for use with these disks.

ALL PRICES SUBJECT TO CHANGE WITHOUT NOTICE. ALL ORDERS WILL BE ACCEPTED ONLY SUBJECT TO OUR ABILITY TO SUPPLY THE GOODS. PRICES SHOWN ARE THOSE IN EFFECT ON DATE NOTED BELOW.



No. PR

Patented April 19, 1904



## SPALDING AVIATION OUTFITS

### Spalding Aviators' Suits

- No. M. Special one-piece leather suit. . . . . Suit, \$65.00
- No. 4. Army cloth Olive Drab suit. Regulation coat and riding breeches. Special order only. Complete, \$35.00
- No. 5. Overall style. . . . . Suit, \$35.00
- Riding breeches, effect. . . . . Suit, \$35.00
- No. 6. One-piece waterproof gabardine suit. . . . . 35.00
- No. 7. Canvas suit, khaki color coat and riding breeches. Regulation style. . . . . Complete, \$25.00
- No. 8. Mechanics' suit. Brown canvas. One-piece, overall style. . . . . Suit, \$3.50
- No. HG. Spalding Aviators' Safety Device. . . . . Each, \$15.00
- Universal Hnasilk Aviators' Life Preserver. . . . . 10.00

### Spalding Leather Coats

- No. E. English Army Coat. Leather, knee length, with belt and three very large pockets. Detachable blanket lining. . . . . Each, \$90.00
- No. A. United States Army leather coat. Double breasted. Detachable blanket lining. . . . . Each, \$75.00
- No. 23. Tan leather, double breasted, military or plain collar, heavy fleece lining. . . . . Each, \$25.00
- No. 2. Tan leather, double breasted, flannel lining, three pockets. Plain or military collar. . . . . Each, \$18.00
- No. 1. Tan leather, double breasted, reversible, corduroy lining, three pockets. . . . . Each, \$15.00

### Spalding Leather Trousers

- No. AT. United States Army leather trousers. Full length. To go with No. A coat. . . . . Pair, \$15.00
- No. 1T. Leather trousers. Full length. Goes with No. 1 coat. . . . . Pair, \$15.00
- No. 1P. Leather pants, riding breeches effect. . . . . 18.00

### Spalding Leather Vests

- No. 1V. Leather; fleece lined. Ea., \$5.00

### Spalding Aviators' Helmets

- No. 16. Heavy molded sole leather, extending far down at back of head. With detachable cape. Each, \$15.00
- No. XX. Combination leather head mask. Hood, goggles and chin-piece. . . . . Each, \$15.00
- No. X. Same as No. XX, but army cloth. . . . . Each, \$10.00
- No. 15. Molded of good quality sole leather. . . . . Each, \$10.00
- No. 14. Adjustable, visor front, back protected. . . . . Each, \$10.00
- No. 11. Extra heavy molded sole leather. . . . . Each, \$9.00
- No. 12. Navy regulation. Extra heavy molded sole leather, fleece lined. . . . . Each, \$7.50

COMPLETE CATALOGUE AVIATION EQUIPMENT SENT ON REQUEST

### Spalding Aviators' Hoods

- No. 4. . . . . No. 16
- No. 6. Leather, fur lined, as worn abroad. . . . . Each, \$10.00
- No. 5. Soft leather, cloth lining. . . . . 5.00
- No. 8. Soft leather, wool lining. . . . . 6.50
- No. 4. Olive drab army cloth. . . . . 3.50
- No. 1. Knitted worsted. Heavy sweater stitch. . . . . 1.50
- No. 1S. Knitted worsted. Jersey stitch. . . . . 1.50
- No. 2. Mole skin. . . . . 1.50
- No. 1. Chin piece. Tan leather, fur lined. . . . . 5.00

### Aviators' Gloves and Mittens

- No. 2N. Navy special gauntlets, black leather, wool lining. Soft gauntlet. Pr., \$6.00
- No. 2M. Navy special mittens. Same as 2N, but mitten shape, no fingers. . . . . 6.00
- No. 2. Army special gauntlet, black leather, wool glove inside. . . . . 6.50
- "Two in One. . . . . 1.25
- No. 0. Worsted, knitted. Pair, \$2.00
- No. 00. Woolen mittens. . . . . 1.25



No. M Suit



No. A Coat  
No. AT Trousers



No. 4



No. 16



No. 2N



No. 0

ALL PRICES SUBJECT TO CHANGE WITHOUT NOTICE. ALL ORDERS WILL BE ACCEPTED ONLY SUBJECT TO OUR ABILITY TO SUPPLY THE GOODS. PRICES SHOWN ARE THOSE IN EFFECT ON DATE NOTED BELOW.



## SCHOOL AND COLLEGE ATHLETIC OUTFITTING

All Spalding Gymnasium Suits, Middies, Bloomers, etc., are made by competent women and girls in the Spalding factory, Sixth Avenue and Pacific Street, Brooklyn, N. Y., under perfect sanitary conditions.



### SPALDING MIDDIES

- No. 54-2. White Jean. . . . Each, \$1.25
  - No. 57-5. Galatea. . . . " 1.75
  - No. 51-1. Khaki (without tie). " 1.75
  - No. 95-1. Government Drill, without braid trimming. . . . Each, \$2.50
  - No. 55-6. Poplin. White, Brown, Navy Blue or Black. . . . Each, \$2.50
  - No. 91-1. Government Drill, with Navy Blue sailor collar, three rows braid trimming (regular naval blouse.) Each, \$3.50
  - No. 69-110. China silk. . . . " 7.50
  - No. 69-111. Mummy silk. . . . " 12.50
  - No. 220-9. French serge, braid trimming. . . . Each, \$6.00
  - No. 222-10. Storm serge, no braid trimming. . . . Each, \$5.50
  - No. 230-93. Flannel. Gray, Navy Blue or Olive Drab. . . . Each, \$3.25 (Embroidered letter, monogram, etc., extra.)
- Any plain style of middies with three rows of braid trimming. . . . Extra, 25c.



### BLOOMERS

- No. 21-2. Black Jean. . . . Pair, \$2.00
- No. 21-3. Black Mummy cloth.. " 2.00
- No. 21-5. Galatea. Navy, Tan or Black. (Other colors on application). . . . Pair, \$2.50
- No. 21-1. Khaki. . . . " 2.75
- No. 21-6. Poplin. Navy or Brown. (Other colors on application.) . . . Pair, \$3.50
- No. 21-12. Serge. Black only. . . . " 4.00
- No. 21-11. Storm serge; all-wool. Black or Navy Blue. (Other colors on application). . . . Pair, \$5.00
- No. 7-13. Storm serge; all wool; tab and pocket. Pair, \$7.00

- No. 7-10. Storm serge; best quality; all wool. " 7.50
- No. 3-10. Best quality storm serge; all wool; improved style. . . . Pair, \$8.00

### KNICKERBOCKERS

- No. 45-9. French serge. . . . Pair, \$7.00
- No. 40-101. China silk. Black. . . . " 5.00
- No. 40-108. Cotton Batiste. . . . " 1.50
- No. 40-109. Satine. . . . " 1.25
- No. 40-1. Khaki. . . . " 2.50

### SCARVES AND KERCHIEFS

- No. MKW. Silk "Government" Middy Kerchief. White, Black and colors. . . . Each, \$1.75
- No. MKH. Silk "Government" Middy Kerchief—Half. Black and colors. . . . Each, \$1.00
- No. LT. Windsor Tie. . . . " .50

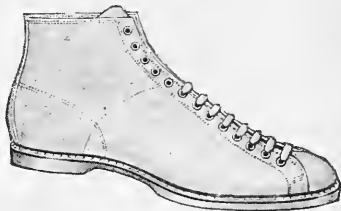

See pages 30, 31 of this catalogue for our regular line of basket ball and gymnasium shoes. We also make special model shoes. Students and instructors at the best girls' schools wear Spalding special shoes.

ALL PRICES SUBJECT TO CHANGE WITHOUT NOTICE. ALL ORDERS WILL BE ACCEPTED ONLY SUBJECT TO OUR ABILITY TO SUPPLY THE GOODS. PRICES SHOWN ARE THOSE IN EFFECT ON DATE NOTED BELOW.

# WOMEN'S SUITS



## SPALDING SWIMMING AND BATHING SUITS

For indoor use, private beaches, etc.

No. NA. "Naida" (Reg. U. S. Pat. Off.) Patented suit. Best quality knitted worsted with brassiere (special feature), Gray trimmed Navy, Gray trimmed White, Navy trimmed White, Black trimmed Red. . . . Suit, \$6.00

No. 4SL. Indoor.

One-piece, close fitting; silk; Black, Gray or White.

Suit, \$5.00

No. 100-6. Poplin, Gray or White.

Each, \$3.50

No. 4RL. Indoor.

One-piece, close fitting; fine quality worsted, all sizes; Black, Navy Gray or plain White.

Buttons over shoulders. . . . Suit, \$3.50

No. 400. Poplin, one-piece, Black or Brown only, button on shoulder, . . . Suit, \$3.00

No. 100-5. Galatea, Light Blue or Gray. 2.50

No. 2RL. Indoor. One-piece, close fitting, extra quality mercerized cotton. Navy Blue or Black; buttons over shoulder. Suit, \$2.00

No. 1RL. Indoor.

One-piece, close fitting; cotton; plain Gray, Black or Navy Blue; buttons over shoulders.

Suit, \$1.00

Water Polo Balls, Etc., Listed on Page 34.

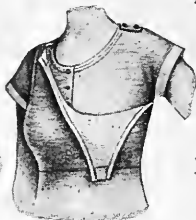

Showing Brassiere  
Pat. Nov. 4, 1913



## SPALDING GYMNASIUM "DANCING" COSTUMES

On special order only

No. 900. Spalding special model, wool batiste without collar and cuffs, and without bloomers.

Each, \$12.00

No. 800. Model of No. 900, Tokio silk, without collar and cuffs, and without bloomers. . . Each, \$10.00

Collars and cuffs extra, according to material selected.



Dancing Costume

## COMMENCEMENT GOWN AND CAP

No. CG. Correct cut, wide sleeve, correct fitting gown of Priestley's Silk Warp Henrietta, with cloth covered mortar board cap. \$11.00

When ordering, give length required, bust measurement, and size of cap worn.

## DANCING SLIPPERS

No. DS. Perfect style for gymnasium and other special dancing. Regular sizes.

Pair, \$3.00

Above size 7, 4.00



ALL PRICES SUBJECT TO CHANGE WITHOUT NOTICE. ALL ORDERS WILL BE ACCEPTED ONLY SUBJECT TO OUR ABILITY TO SUPPLY THE GOODS. PRICES SHOWN ARE THOSE IN EFFECT ON DATE NOTED BELOW.

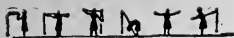

SPALDING HEALTH PULL

SPALDING WRIST MACHINES

No. HP



No. HP. Formed of five cords of heavy elastic, durable in quality. Has two handles, one at each end, and strength may be varied by using with different numbers of cords. A very beneficial article of exercise. . . . Each, \$1.50



Strengthen and develop fingers, hands, wrists, arm and forearm. Cures cramps and stiffness of joints.

- No. 1. Elastic cord, wood handle. Each, 35c.
- No. 2. Elastic cord, cork handle. " 60c.
- No. 3. Metal springs, wood handle. " 40c.

SPALDING ELASTIC EXERCISERS

No. 3. Spalding "Special" Elastic Exerciser, with chart of exercises. Complete in box, with charts, door hinge attachment and package of hooks. Choice of heavy or medium cable. Improved in quality and finish. . . . Each, \$5.00

No. 1. Spalding "Standard" Elastic Exerciser, with a chart of exercises. Complete in box, with door hinge attachment and a package of hooks. Choice of either heavy or medium cable. . . . Each, \$3.00

No. 0. Spalding "Lively" Elastic Exerciser, with chart of exercises. Complete in box, with door hinge attachment and package of hooks. Choice of heavy or medium cable. Each, \$2.00



No. 1

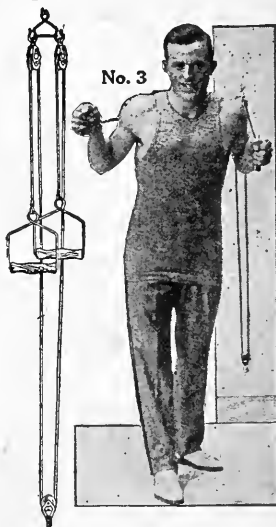

No. 3

EXTRA CABLES

Complete with Swivel Ends, for Spalding Elastic Exercisers

Cables are packed each in individual tubes, convenient for handling or mailing. This also keeps the rubber from the light and air. If not specified, medium tension will be sent.

- Style C. Cable only, for No. 3 Elastic Exerciser. Heavy or medium tension. Each, \$2.50
- Style B. Cable only, for No. 1 Elastic Exerciser. Heavy or medium tension. " 1.50
- Style A. Cable only, for No. 0 Exerciser. Either heavy or medium tension. " 1.25

SPALDING ELASTIC HOME EXERCISER—NO PULLEYS

It is readily attached to door frame, window casing or any convenient place in room, is absolutely noiseless, takes very little space, and can be quickly removed when not in use.

- No. 1H. Heavy Tension Elastic. . Each, \$1.00
- No. 2M. Medium Tension Elastic. " 1.00
- No. 3L. Light Tension Elastic. . " .90

ALL PRICES SUBJECT TO CHANGE WITHOUT NOTICE. ALL ORDERS WILL BE ACCEPTED ONLY SUBJECT TO OUR ABILITY TO SUPPLY THE GOODS. PRICES SHOWN ARE THOSE IN EFFECT ON DATE NOTED BELOW.





## SPALDING'S ATHLETIC LIBRARY



On this and following page are given the titles and a short description of Spalding Athletic Library books now in print, grouped for ready reference. Any 25 cent book listed in Spalding's Athletic Library will be bound in flexible binding for 50 cents each, or any two 10 cent books in one volume for 50 cents.



- No. 1. Spalding's Official Base Ball Guide. Official authority for forty years. Price 10c.  
 No. 1S. Spalding's Official Base Ball Guide. Spanish edition. Price 10c.  
 No. 202. How to Play Base Ball. Price 10c.  
 No. 219. Ready Reckoner of Percentages. Price 10c.  
 By John B. Foster. Averages at a glance. Price 10c.  
 No. 223. How to Bat. No better way of becoming proficient than by reading this book. Price 10c.  
 No. 224. How to Play Outfield. For young players who wish to excel in that position. Price 10c.  
 No. 225. How to Play First Base. No boy trying to gain knowledge should overlook this book. Price 10c.  
 No. 226. How to Play Second Base. Evers, Doyle and E. Collins give ideas to the beginner. Price 10c.  
 No. 227. How to Play Third Base. The most difficult position of the infield; is well written. Price 10c.  
 No. 228. How to Play Shortstop. The views of well-known players are given for beginners. Price 10c.  
 No. 229. How to Catch. Every boy who hopes to become a catcher should read this book. Price 10c.  
 No. 230. How to Pitch. The foremost pitchers in the game give advice to the youngster. Price 10c.  
 No. 231. How to Organize a League; Club; Manage a Club; Train a Team; Captain a Team; Technical Terms. Price 10c.  
 No. 232. How to Run Bases. Gives clear and concise directions for this part of the game. Price 10c.  
 No. 350. How to Score. Shows how to make up a box score and other valuable information. Price 10c.  
 No. 355. Minor League Base Ball Guide. Official book of Association of Minor Leagues. Price 10c.  
 No. 356. Official Book National League. Contains the constitution and playing rules. Price 10c.  
 No. 9. Spalding's Official Indoor Base Ball Guide. Official rules, reports and records. Price 10c.  
 No. 59R. Official Base Ball Record. Edited by John B. Foster and C. D. White. A statistical encyclopedia of the national game. Over 400 pages. Price 25c.  
 No. 75R. How to Umpire. By Billy Evans. Price 25c.  
 No. 2. Spalding's Official Foot Ball Guide. Edited by Walter Camp. The only official book. Price 10c.  
 No. 358. Official College Soccer Guide. Edited by George W. Orton. Official handbook. Price 10c.  
 No. 39R. How to Play Soccer. This is the most complete book on this game published. Price 25c.  
 No. 47R. How to Play Foot Ball. Edited by Walter Camp. Book has been brought up to date. Price 25c.  
 No. 55R. Spalding's Official Soccer Guide. Edited by Thomas W. Cahill. The only book of its kind published in America. Price 25c.  
 No. 157. How to Play Lawn Tennis. A complete and concise description of the game. Price 10c.  
 No. 363. Tennis Errors and the Remedies. The thirty-four common errors of players. Price 10c.  
 No. 1P. How to Play Tennis—For Beginners. This book is invaluable to the novice. Price 10c.  
 No. 2R. Strokes and Science of Lawn Tennis. A most valuable book on scientific tennis. Price 25c.  
 No. 26R. Official Handbook National Squash Tennis Association. Price 25c.  
 No. 42R. Davis Cup Contests in Australasia. Useful as a book of instruction as well. Price 25c.

- No. 57R. Spalding's Lawn Tennis Annual. Edited by F. B. Alexander. Most complete book published on the game. Tells how to lay out a court. Price 25c.  
 No. 76R. Tennis for Girls. A new book. Price 25c.  
 No. 2P. How to Learn Golf. This book is intended to be of service to those starting the game. Price 10c.  
 No. 3R. Spalding's Official Golf Guide. Edited by Grantland Rice. The leading annual. Price 25c.  
 No. 4R. How to Play Golf. Written by the celebrated professionals, Braid and Vardon, in a series of very instructive articles. Price 25c.  
 No. 63R. Golf for Girls. A new book on this ever increasingly popular outdoor pastime. Price 25c.  
 No. 7. Spalding's Official Basketball Guide. The recognized official basketball rule book. Price 10c.  
 No. 7A. Spalding's Official Women's Basketball Guide. Contains official rules; illustrated. Price 10c.  
 No. 193. How to Play Basketball. A well written and instructive treatise on the game. Price 10c.  
 No. 6. Spalding's Official Ice Hockey Guide. The leading annual of the game. Price 10c.  
 No. 14. Curling. By James S. Mitchel. A short history of this famous Scottish pastime. Price 10c.  
 No. 8R. The Art of Skating. By Irving Brokaw. The most complete and lucid book of instruction in the art that has ever been published. Price 25c.  
 No. 20R. How to Play Ice Hockey. By S. Trafford Hicks, former captain Harvard team. Price 25c.  
 No. 28R. Winter Sports. A book which should be read by all lovers of outdoor exercise. Price 25c.  
 No. 72R. Figure Skating for Women. Illustrated with numerous diagrams and pictures. Price 25c.  
 No. 12A. Spalding's Official Athletic Rules. This book is the official guide for all athletes. Price 10c.  
 No. 27. College Athletics. By the late Michael C. Murphy. Invaluable to any athlete. Price 10c.  
 No. 55. Official Sporting Rules. By the late James E. Sullivan. Rules for minor contests. Price 10c.  
 No. 87. Athletic Primer. By the late James E. Sullivan. The only book on this subject that treats on track making, training, timing, etc. Price 10c.  
 No. 156. Athletes' Guide. By the late James E. Sullivan. A monument to his wisdom. Price 10c.  
 No. 178. How to Train for Bicycling. Methods of the best riders when training; food, etc. Price 10c.  
 No. 182. All Around Athletics. Gives the method of scoring the all-around championship. Price 10c.  
 No. 255. How to Run 100 Yards. By an old-time champion, who gives valuable advice. Price 10c.  
 No. 302. Y. M. C. A. Official Handbook. This is a book published for the Y. M. C. A., and is the only official athletic rules book for that body. Price 10c.  
 No. 317. Marathon Running. By the late James E. Sullivan. With marathon racing rules. Price 10c.  
 No. 342. Walking for Health and Competition. A very useful book both for men and girls. Price 10c.  
 No. 362. Track, Relay and Cross-Country Rules of the National Collegiate A. A. Price 10c.  
 No. 3P. How to Become an Athlete. By the late James E. Sullivan. No more capable advice on this subject could be given. Price 10c.  
 No. 4P. How to Sprint. This book shows various types of sprinting and hints on training. Price 10c.





SPALDING'S ATHLETIC LIBRARY

No. 1R. Spalding's Official Athletic Almanac. A yearly statistical record book that is recognized as official. Illustrated. Price 25c.  
 No. 17R. Olympic Games, Stockholm, 1912. Price 25c.  
 No. 45R. Intercollegiate Official Handbook. This is a book every collegian should read. Price 25c.  
 No. 48R. Distance and Cross Country Running. By George Orton, Univ. of Pennsylvania. Price 25c.  
 No. 70R. How to Become a Weight Thrower. By James S. Mitchel, the former champion. Price 25c.  
 No. 246. Athletic Training for Schoolboys. By George Orton, a famous athlete himself. Price 10c.  
 No. 61R. School Tactics and Maze Running; Children's Games. Two books in one. Price 25c.  
 No. 66R. Calisthenic Drills and Fancy Marching for the Class Room; Physical Training for the School and Class Room. By G. R. Borden. Price 25c.  
 No. 71R. Public Schools Athletic League Official Handbook. Edited by Dr. C. Ward Crampton. The official athletic rule book of the P.S.A.L. Price 25c.  
 No. 74R. Schoolyard Athletics. By the late James E. Sullivan. Its title indicates its purpose. Price 25c.  
 No. 128. How to Row. By E. J. Giannini. Coach for a number of years at the N. Y. A. C. Price 10c.  
 No. 129. Water Polo. Treats of every detail in this most interesting of team games. Price 10c.  
 No. 361. Intercollegiate Swimming Guide. Gives information about this aquatic sport in a most clear and most instructive manner. Price 10c.  
 No. 36R. Speed Swimming. By C. M. Daniels, the former world's champion. Price 25c.  
 No. 37R. How to Swim. By a leading authority on swimming. Price 25c.  
 No. 60R. Canoeing and Camping. A new book that has met with great favor already. Price 25c.  
 No. 314. Girls' Athletics. Edited by Elizabeth Burchenal. The official handbook of the Girls' Branch of the Public Schools A. L. of New York. Price 10c.  
 No. 38R. Field Hockey. Edited by Miss C. K. Applebee, Athletic Director at Bryn Mawr. Price 25c.  
 No. 41R. Newcomb. By Clara Gregory Baer. Was designed and copyrighted in 1895. Price 25c.  
 No. 69R. Girls and Athletics. A new book just published on sports suitable for girls. Price 25c.  
 No. 167. Quoits. The author explains the methods used by experts, with illustrations. Price 10c.  
 No. 170. Push Ball. Played with an air-inflated ball six feet in diameter. A side consists of eleven men, but is often played by an entire class. Price 10c.  
 No. 180. Ring Hockey. A new game for the gymnasium which has become very popular. Price 10c.  
 No. 199. How to Play Equestrian Polo. Written by a leading authority on this great sport. Price 10c.  
 No. 201. How to Play Lacrosse. Every position is explained in a simple, concise manner. Price 10c.  
 No. 207. Lawn Bowls. How to construct a green; official rules of the Scottish Bowling Association; laws of the game; scoring, etc. Price 10c.  
 No. 6R. Cricket, and How to Play It. Reprinted from the English edition of the same book. Price 25c.  
 No. 43R. Lawn Games. Archery, Croquet, Volley Ball, Pin Ball, Parlor Hockey, Garden Hockey, etc., are here described. Price 25c.  
 No. 13. The American Game of Handball. This old, yet new, game is still very popular. Price 10c.  
 No. 364. Volley Ball. Contains the official rules and directions for playing the game. Price 10c.  
 No. 49R. How to Bowl, How to score; how spares are made; hints to beginners. Price 25c.  
 No. 50R. Court Games. Squash, Squash Racquets and other court games are described. Price 25c.  
 No. 191. How to Punch the Bag. By Young Corbett, former featherweight champion. Price 10c.  
 No. 282. Official Roller Skating Guide. Directions for becoming a fancy roller skater. Price 10c.  
 No. 11R. Fencing Foil Work Illustrated. This book is an aid to both instructor and pupil. Price 25c.

No. 19R. Professional Wrestling. By Ed W. Smith. Shows how to make and break holds and other very valuable information. Price 25c.  
 No. 21R. Jiu Jitsu. A complete description of this Japanese system of self-defense. Price 25c.  
 No. 25R. Boxing. Contains over 70 pages of illustrations, showing the various blows, posed especially for this book. Rules for boxing. Price 25c.  
 No. 30R. The Art of Fencing. A short, practical and complete exposition of the art. Price 25c.  
 No. 65R. How to Wrestle. Devoted especially to poses by all the principal wrestlers. Price 25c.  
 No. 10R. Single Stick Drill. Single stick exercise is equal to the dumb bell or Indian club. Price 25c.  
 No. 16R. Team Wand Drill. An exercise for both the young man and the business man. Price 25c.  
 No. 22R. Indian Clubs and Dumb Bells and Pulley Weights. By Prof. Edward E. Warman, the noted authority on physical culture. Price 25c.  
 No. 24R. Dumb Bell Exercises. Undoubtedly the best book on this subject ever issued. Price 25c.  
 No. 73R. Graded Calisthenics and Dumb Bell Drills To improve set drills this book is printed. Price 10c.  
 No. 124. How to Become a Gymnast. Any young man can easily follow these instructions and become proficient as a gymnast. Price 10c.  
 No. 254. Barnum Bar End Drill. The positions and figures are diagramed, with explanations. Price 10c.  
 No. 287. Fancy Dumb Bell and Marching Drills. A book for boys; can also be used by girls. Price 10c.  
 No. 14R. Trapeze, Long Horse and Rope Exercises. Very interesting and instructive. Price 25c.  
 No. 34R. Grading of Gymnastic Exercises. Should be in the hands of every physical director, school, club, college, etc. Price 25c.  
 No. 40R. Indoor and Outdoor Gymnastic Games. One of the best books on gymnastics. Price 25c.  
 No. 52R. Pyramid Building. The book contains many half-tone illustrations. Price 25c.  
 No. 56R. Tumbling for Amateurs and Ground Tumbling. Contains suggestions for teachers. Price 25c.  
 No. 67R. Exercises on the Side Horse and on the Flying Rings. Covers various evolutions of a good performer in both specialties. Price 25c.  
 No. 68R. Horizontal Bar Exercises and Exercises on the Parallel Bars. A valuable book. Price 25c.  
 No. 161. Ten Minutes' Exercise for Busy Men. Good exercise that any busy man can follow. Price 10c.  
 No. 185. Hints on Health. A series of articles by Prof. Edward E. Warman. Price 10c.  
 No. 325. Twenty-Minute Exercises. For the man who thinks he cannot find the time to exercise, this book is specially adapted. Price 10c.  
 No. 7R. Physical Training Simplified. This is a complete, thorough and practical book. Price 25c.  
 No. 9R. How to Live 100 Years—And Then Some. Not necessary for one to be an athlete. Price 25c.  
 No. 23R. Get Well; Keep Well. A book of vital importance to those interested in hygiene. Price 25c.  
 No. 33R. Tensing Exercises. Tensing is an exercise which gives beneficial results. Price 25c.  
 No. 51R. 285 Health Answers. A series of paragraphs of interest to everyone. Price 25c.  
 No. 54R. Medicine Ball Exercises. Indigestion Treated by Gymnastics, Physical Education and Hygiene. Really three books in one. Price 25c.  
 No. 62R. The Care of the Body. A book that all who value sound health should read. Price 25c.  
 No. 64R. Muscle Building and Health by Muscular Gymnastics. Price 25c.

"BASE BALL." By the late A. G. Spalding. A book of 600 pages, profusely illustrated with over 100 full page engravings, and having sixteen forceful cartoons by the late Homer C. Davenport, the famous American artist. Mailed postpaid on receipt of price. \$1.00 Net.

