

STABLE BUILDING
AND
STABLE FITTING

GIRAUD.

YOUNG & CO., 12, VICTORIA ST., WESTMINSTER, LONDON,

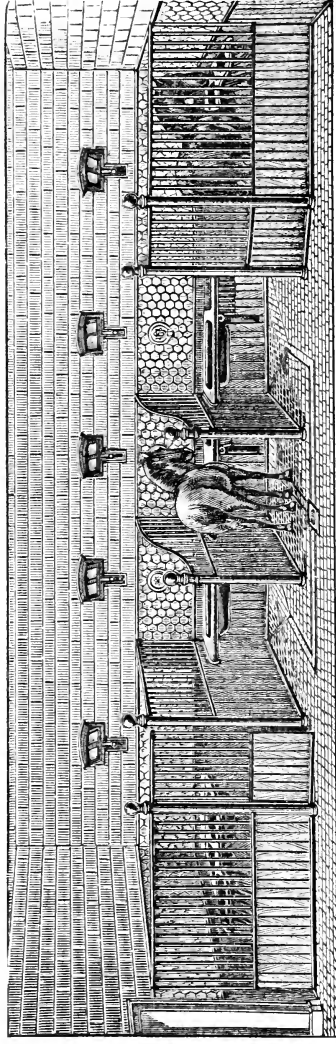

Manufacture and Supply exclusively Iron Stall and Loose Box Divisions and Manger Fittings, Harness-Room Brackets and Fittings, Harness-Room Cases and Tables, Stable Drainage Gutters and Paving, Woodwork and Wall Tiling for Stables, and every requisite for completing Stable ready for occupation.

Iron Cow-House and Piggery Fittings.

YOUNG & CO. SUPPLY ALL THE VARIOUS STABLE FITTINGS DESCRIBED IN "STABLE BUILDING AND STABLE FITTING."

HANDSOMELY ILLUSTRATED CATALOGUE,

Containing 90 pages and hundreds of Engravings, and giving much valuable information as to the fitting up and finishing of interior of Stable, will be forwarded on application.

THE ST. PANCRAS IRON-WORK CO.

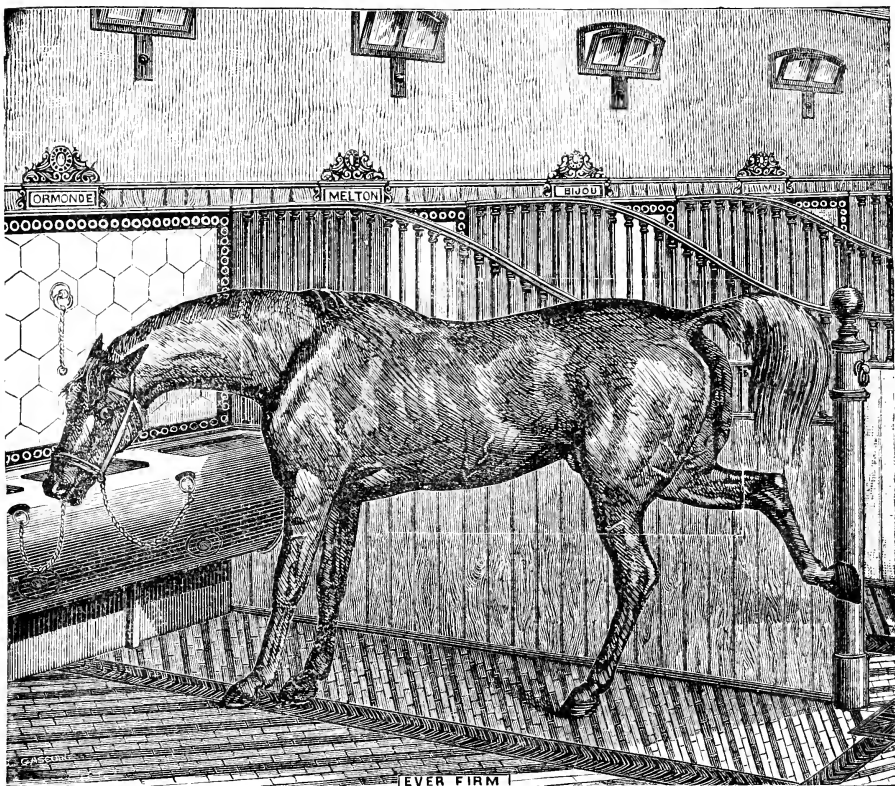

ORIGINAL INVENTORS, PATENTEES, AND MANUFACTURERS OF IMPROVED

STABLE FITTINGS.

Supplied to H.M. The Queen, H.R.H. The Prince of Wales, and many other Sovereigns and Princes;
Noblemen, Gentlemen, Corporations, Railway Companies, Carriers, Tradesmen, &c., &c.

Illustrated Priced Catalogues sent on application to—

THE ST. PANCRAS IRON-WORKS, PANCRAS ROAD, LONDON, N.W.,

WHERE THE SHOW-ROOMS ARE.

TELEGRAPHIC ADDRESS—"EQUITATION, LONDON."

TELEPHONE 7519.



JOHN A. SEAVERNS

STABLE BUILDING

AND

STABLE FITTING:

Webster Family Library of Veterinary Medicine
Cummings School of Veterinary Medicine at
Tufts University
200 Webster Road
North Grafton, MA 01536

STABLE BUILDING

AND

STABLE FITTING:

A HANDBOOK FOR THE USE OF ARCHITECTS,
BUILDERS, AND HORSE OWNERS.

BY

BYNG GIRAUD,

ARCHITECT.

With Fifty-six Plates and numerous Illustrations in the Text.

LONDON:

B. T. BATSFORD, 52, HIGH HOLBORN.

1891.

P R E F A C E.



IN presenting the following pages to the public, the Author believes that he is supplying, in a convenient shape, information on the subject of stable building and fitting, much of which has hitherto been obtainable only in a broadly scattered form. Having been largely engaged in designing buildings for stabling, he has acquired considerable experience in their construction, and in the best methods of draining, paving, lighting, and ventilating them; the result of which will be found embodied in this work.

BYNG GIRAUD.

September 1890.

CONTENTS.



CHAPTER I.

GENERAL REMARKS.

Site for stabling—Aspect—Modern improvements—Improved fittings—Iron stables—An iron homestead—Portable iron stables—Principles of arrangement—Provision for extension—Simplicity in construction
Pages 1-5

CHAPTER II.

PLANNING AND ARRANGEMENT.

Circumstances regulating arrangement—Administrative block—Washing-room—Vestibule to stables—Arrangement of town stables—Rooms over stables—Lairs and hock baths—Examples of stables—"Private stables," Design No. 1—Design No. 2—Design No. 3 (for town or country)—Design No. 4 (Stables for hunters)—Design No. 5 (suburban stables)—Designs Nos. 6 and 7 (town and country stables)—Difficulties in towns—Stables in mews—Design No. 8 ("inclosed")—Stables on upper floors—Dimensions of stables—Convertible stalls and boxes—Portable partitions—Loose boxes with stalls—Capacity of stables—Boxes for hunters—Covered way—Breeding stables—Racing stables—Farm stables—Hay and corn stores—Preparation of fodder—Distribution of fodder—Capacity of hay and corn store—Cubic capacity of hay—Tramway and omnibus stables—Omnibus stables—Tramway stables—Manager's offices, &c. 6-20

CHAPTER III.

CONSTRUCTION.

Shape of building—Treatment of foundations—Concrete—Outside walls—Intermediate walls—Foundation walls—Relieving arches—Stone walls—Walls on arches—Damp courses—Rounded edges—Recessed down

pipes and taps—Rough cast—Depeter work—Facing with tiles, &c.—Smithies—Dressing rings—Isolation—Division walls—Fireproof buildings—Fireproof floors—Concrete floors—Mr. Hyatt's system—Wood floors—Posts for lofts—Sills—Stables on upper floors—Ventilating partitions—Roofs—Lean-to roofs—Common rafters—King-post roofs—Queen-post roofs—Duties of tie-beams—Provisional strength of members—Loft in roof—Open roofs—North London Tramway roofs—Zinc roofs—Templates—Wrought-iron roofs—Roofs at Ponder's End—Slating and Tiling—Covering for walls—Washable distemper—Pointing—Tuck pointing—Colouring brickwork—Wells—Well at Ponder's End—Abyssinian wells—Supply of water—Closets and urinals—Trough closets—Slate urinals—Inclosure walls—Inclosure fences

Pages 21–37

CHAPTER IV.

DRAINAGE.

Drainage requirements—Open surface channels—Wrought iron surface gutters—Open brick channels—Channel bricks and blocks—Drainage of loose boxes—Outlets of gutters—Granite open gutters—Wrought iron covered surface gutters—Drainage in relation to paving—Slope of stalls—Steep inclines—Underground drainage—Jointing pipes in clay—Cement joints—Filling in—Velocity in pipes—Manholes—Inspection pits—Ventilation—Yard gullies—Iron syphon traps—Earthenware traps—Drainage of omnibus and tramway stables—Disposal of sewage—Cesspools—Manure-pit with cesspool—Surface drainage—Rain water—Advantage of soft water 38–49

CHAPTER V.

PAVING.

Requirements of paving—Adamantine clinkers and paviers—Grooved paviers—Tebbutt's "safety brick"—Vitrified bricks—Paving with stocks—Examples of paving—Herring-bone paving—Height of floor—Paving without concrete—Preparing ground—Laying—Composite paving—Granite cubes—Advantages of good paving—Difference in cost—Omnibus stables—Various stone pitching—Cobble stones—Wood paving—Paving of smithy. 50–59

CHAPTER VI.

VENTILATION.

General considerations—Temperature—Cubic contents of stables—Requirements of various horses—Admission of air—Fanlights and louvres—Construction of louvres—Lantern ventilation—Stables at Poplar—Ventilating tiles—Down-cast ventilation—Through ventilation—Ceilings and lofts—Perforated pipes—Head-post ventilators—Boyle's ventilators—Ventilation of upper floors—Glazed ventilators—The Sheringham ventilator—Loose boxes—Cubic contents—Examples

Pages 60-68

CHAPTER VII.

FITTINGS AND DETAILS.

Separation in stables—Cast and wrought iron details—Stall divisions—Ramp panels—Portable partitions—Safety bars—Heel-posts and pillars—Ramps and posts—Fixing posts—Loose box partitions—Loose box doors—Door frames—Swing doors—Latches and locks—Locking bolt—Bales—Safety hooks—The Malet bale suspender—Safety catch—Cleating—Double cleating—Kicking-boards—Mangers—Manger posts—Wrought iron mangers—Water fittings—Crib-biting—Safety mangers—Hay-racks—Loose box sliding bars—Halter tying—Smithy fittings—Hearths, bellows, &c.—Vice bench—Harness-room—Heating apparatus—Boilers—Open boilers—Girth stretchers—Saddle airers—Saddle-horses—Clothes press—Harness—Harness brackets—Coach-houses, warming, &c.—Coach-house doors—Hinges and fastenings—Gate stops—Table—Corn-stores—Machines for food—Food supply—Corn-bins—Preparing food, motive power—Horse-power—Gas engine—Hoisting and gear—Jacob's ladder—Hayloft doors—Hanging and sliding doors—Water supply—Washing apparatus—Valves—Gas supply—Oil lamps 69-96

DESCRIPTION OF PLATES.



- PLATE 1. Private Stables, Design No. 1. Ground floor, and 1st and 2nd floors.
- PLATE 2. Private Stables, Design No. 1. Front elevation.
- PLATE 3. Private Stables, Design No. 1. Elevation to yard and back view of stables; section of stable, and elevation of coach-house and corn store; plan of corn and hay store; general elevation to road; and entrance gates.
- PLATE 4. Private Stables, Design No. 2. Ground plan and elevation to road.
- PLATE 5. Private Stables, Design No. 2. One-pair plan; elevation to yard, and transverse section through stable.
- PLATE 6. Private Stables, Design No. 3. Ground plan and elevation to yard; plan of corn store, hayloft, and roof.
- PLATE 7. Private Stables, Design No. 4. General plan and elevation.
- PLATE 8. Private Stables, Design No. 5. Front elevation and ground plan.
- PLATE 9. Private Stables, Design No. 5. Transverse section, longitudinal section of stable, and plan of hayloft.
- PLATE 10. Private Stables, Design No. 6. Ground floor plan, first floor plan, front elevation, and back elevation.
- PLATE 11. Private Stables, Design No. 7. Ground floor plan, first floor plan, front elevation, and end elevation.
- PLATE 12. Private Stables, Design No. 8. Ground floor plan, first floor plan, and front elevation.

PLATE 13. Paving in various kinds of brick.

PLATE 14. Fig. 1. Paving with circular grooved bricks and wrought-iron open surface gutter. Fig. 2. Staffordshire vitrified blue-brick paving with V-shaped grooves, and open surface gutter bricks. Fig. 3. Semicircular grooved brick paving, with special open surface gutter brick. Fig. 4. Metallic semi-circular grooved paving, 3 inches thick, with metallic open surface gutter.

PLATE 15. Fig. 1. Heel-post secured with concrete. Fig. 2. Heel-post with stone and Lewis bolts. Fig. 3. Heel-post with safety cap. Fig. 4. Rounded end to ramp. Fig. 5. Terminal to posts. Fig. 6. Socket for portable heel-post. Fig. 7. Clutch box for ramp rail.

PLATE 16. Fig. 1. Section of plain ramp rail and sill. Fig. 2. Side view of ditto. Fig. 3. Elevation of loose box:—*a*, top rail; *b*, centre rail; *c*, sill.

PLATE 17. Fig. 1. Elevation of loose-box pillars, and door with iron frame. Fig. 2. Plan of ditto. Fig. 3. Loose-box door at angle of 45°. Fig. 4. Elevation of loose-box door, with wood frame. Fig. 5. Wrought iron mountings for loose-box door.

PLATE 18. Fig. 1. Strong stall partition, with cast iron column, harness brackets and ventilating sill. Fig. 2. Stall division, with ventilating ramp and wrought iron heel-post. Fig. 3. Ditto, with single safety barrier bar. Fig. 4. Ditto, with double safety bar and solid panel.

PLATE 19. Fig. 1. Halter weight-box in wood, with rein guide. Fig. 2. Side view of shackle, with wrought iron guide bar and friction roller. Fig. 3. Halter weight-box of wrought iron with chain. Fig. 4. Stout shackle for cart horses, with wrought-iron stiffening bar. Fig. 5. Wrought iron halter weight-box, with friction roller and strap. Fig. 6. Side view of portable partition and ramp, with clutch-boxes and socket. Fig. 7. Ditto, plain partition for cavalry stables, with portable manger. Figs. 8, 9, and 10. Designs for head-stall fastenings.

- PLATE 20. Mangers. Fig. 1. Method of securing wrought iron trough manger. Fig. 2. Portable cavalry manger. Fig. 3. Elm manger, with oak post and fir bearer. Fig. 4. Section of elm mangers without posts.
- PLATE 21. Mangers—details. Fig. 1. Front view of ring and bolt to manger. Fig. 2. Part view of front, with capping. Fig. 3. Side view of capping. Fig. 4. Section through capping.
- PLATE 22. Mangers for stalls. Fig. 1. Water pot, corn trough, and under-head hayrack. Fig. 2. Corn trough and deep under-head hayrack. Fig. 3. Manger, with water pot and hayrack on top plate. Fig. 4. Ditto, but without water pot. Fig. 5. Wrought iron trough manger, with over-head hayrack. Fig. 6. Patent radial hayrack.
- PLATE 23. Mangers for loose boxes. Fig. 1. Left-hand corner manger complete, with vertical hayrack on plate. Fig. 2. Manger, with under-head hayrack, for loose box or stall. Fig. 3. Left-hand corner manger (complete), with under-head hayrack. Fig. 4. Ditto, without water pot. Fig. 5. Ditto, matched boarded beneath. Fig. 6. Ditto, right-hand corner manger, with large shallow hayrack on plate. Fig. 7. Right-hand corner manger, with under-head rack and back plate cut away. Fig. 8. Deep corner hayrack. Fig. 9. Corner manger for crib-biters. Fig. 10. Corn manger or water trough.
- PLATE 24. Rack and pillar chains. Fig. 1. Flax fastening, with spring safety hook. Figs. 2, 3, 4, and 5. Chains of various patterns. Figs. 6, 7, and 8. Sections of water pot. Fig. 9. Side view of ditto. Fig. 10. Enlarged view of inlet and union. Fig. 11. Manger with water pot. Fig. 12. Corner manger for water or food.
- PLATE 25. Fig. 1. Front elevation of entrance gates and plan of ditto. Fig. 2. Inside elevation of suspended sliding doors. Fig. 3. Detail in elevation. Fig. 4. The same in section.
- PLATE 26. Elevation, section, plan, and details of oak fencing. Fig. 1. Inside view of wicket gate. Fig. 2. Inside view of coach-house door, with patent roller bolt and fastening.
- PLATE 27. Elevation, section, plan, and details for sliding door on rollers.

PLATE 28. Hinges. Fig. 1. Cranked hinges, plan and outside view. Fig. 2. Straight hinges for flush doors, plan and outside view. Fig. 3. Collinge's patent hinges, top and bottom (outside view).

PLATE 29. Brackets. For riding harness :—1. Lady's saddle bracket. 2. Gentleman's ditto. 3. Stirrup bracket. 4. Girth ditto. 5. Bridle ditto. For driving :—6. Pad ditto (for single harness). 7. Ditto for double harness. 8. Collar bracket. 9. Ditto, with martingale and crupper ditto. 10. Bridle ditto. 11. Rein or crupper ditto. 12. Hame or bridle ditto. Heavy cart-horse harness :—13. Breeching bracket, with forged hook for crupper. 14. Bridle bracket. 15. Collar ditto. 16. Double rein hook.

PLATE 30. 1. Wrought iron bracket for pad, for single harness. 2. Bracket for collar, showing one of two, for double harness. 3. Ditto. 4. Ditto for pad ditto. 5. Ditto for bridle ditto. 6. Ditto for pad ditto. 7. Rein or crupper holder.

PLATE 31. General requisites. Fig. 1. Harness-room stove. Fig. 2. Octagon stable hand lantern. Fig. 3. Safety stable lantern for candles. Fig. 4. Showing means of suspending same. Fig. 5. Sliding lantern for oil. Fig. 6. Hurricane lamp. Fig. 7. Galvanised iron sand box. Fig. 8. Box of galvanised iron for brushes, leathers, &c. Fig. 9. Ditto, for soap. Fig. 10. Ditto, for stopping mixture. Fig. 11. Galvanised iron fork hook. Fig. 12. Ditto, implement hook. Fig. 13. Salt rack to be fixed to wall. Fig. 14. Galvanised iron fork and shovel hook. Fig. 15. Carriage setter.

PLATE 32. London General Omnibus Company's general plan of stables at Poplar. A. Stables. B. Loose boxes. C. Surgery. D. Lair. E. Smithy. F. Harness makers' shop. G. Manager's house. H. Entrance gates. I. Gullies. *a*, mangers; *b*, corn chest; *c*, posts supporting hay store; *d*, counter; *e*, sink; *f*, copper; *g*, meter house; *h*, washers' store; *i*, privy; *k*, office; *l*, living room; *m*, kitchen; *n*, scullery; *o*, dust; *p*, w.c.

PLATE 33. Plan of stable and drains.

PLATE 34. Longitudinal section of stable.

PLATE 35. Transverse ditto, showing kicking boards and details of roof.

- PLATE 36. Front elevation of stables.
- PLATE 37. Plan, section, and elevation of loose boxes, and surgery.
- PLATE 38. Plan of stable roof.
- PLATE 39. North London Tramway Company's general plan of stables at Ponder's End. A. Entrance gates. B. Wicket gate. C. Boundary fence. *a*, large meter connected with Gas Company's main in Tramway avenue; *a*, small meter for gas engine; *b*, burners; *c*, screw-down tap; *d*, water trough; *e*, gullies; *f*, valve well; *g*, ventilator to sewer; *h*, man-hole; *i*, chase for down pipes; *j*, smith's hearth; *k*, corn chest.
- PLATE 40. Longitudinal section of stable.
- PLATE 41. Transverse ditto.
- PLATE 42. Elevations of stables, showing longitudinal section of roof of shed.
- PLATE 43. Fig. 1. Transverse section of roof of shed, and inside view of screen. Fig. 2. Transverse section of Mansard roof. Fig. 3. Detail for fixing purlins on iron roof.
- PLATE 44. Details of iron roof (Plate 43, Fig. 1) 40 feet span.
- PLATE 45. Longitudinal section of smithy, and details of hearth.
- PLATE 46. Transverse section of smithy, locking bolt, and dressing ring.
- PLATE 47. Ground floor and first floor; plan of corn store, hay loft, engine house, and tank house.
- PLATE 48. Longitudinal section through corn store and engine house.
- PLATE 49. Details of privy and man-hole.
- PLATE 50. Cambridge Tramways Company. General plan. First floor plans of dwelling and corn store, and plan of roof.
- PLATE 51. Ditto. Elevation to road, and elevation of offices, smithy, loose box, &c., in yard.
- PLATE 52. Ditto:—Elevation of corn store and stables in yard.

PLATE 53. Southampton Tramway's stables. Fig. 1. Plan of lair at Shirley. Fig. 2. Plan of horse track and corn store at Portswood.

PLATE 54. General details for corn stores. Figs. 1, 2, and 3. Plan, detail, and part front view of corn bin. Fig. 4. Section of wooden corn chest. Fig. 5. Section of cast iron column. Fig. 6. Wrought iron corn chest. F'g. 7. Plan and section of cast-iron shoe for post.

PLATE 55. Part plan and transverse section of Messrs. Crosse & Blackwell's stables.

PLATE 56. Part plan and transverse section of Col. Fitzwygram's design for stable.

STABLE BUILDING

AND

STABLE FITTING



CHAPTER I.

GENERAL REMARKS.

Site for stabling—Aspect—Modern improvements—Improved fittings—Iron stables—An iron homestead—Portable iron stables—Principles of arrangement—Provision for extension—Simplicity in construction.

As one approaches the immediate confines of a country mansion, the most conspicuous object is often the clock-tower of the stables; and the block of buildings to which it belongs, with its high enclosure walls and entrance gateway, forms an object of importance second only to the house itself. But although it forms in such case a feature in the landscape, it is of prior importance that its relation with the house shall not become, in any way, an objection to it as a dwelling. At the same time, its aspect and construction may be of grave consequence to the animals housed in it, and where it cannot be altogether placed as the architect would desire—on a gravel slope with a south or south-westerly aspect—provision must be made to modify or altogether counteract the effects of an undesirable situation. Even in the country the aspect of a stable is not always a matter of choice; but a building with plenty of light, well drained and ventilated, and entirely free

from damp, is essential, not only to good appearance and successful grooming, but for the working capacity and health of the horse; and, moreover, in a stable where these requirements are complied with, an economy is effected even in the food. Food supplies, in a measure, the absence of warmth; and a horse which is kept in a stable sufficiently near to the temperature of his own body, will eat less, with the same beneficial result, than one which is in a cold stable; so that, apart from all considerations of humanity, it is a commercial mistake of the gravest kind to put a valuable animal into a cold or badly ventilated stable, and is the cause of many of the diseases to which horses are liable. "Unless," says a writer on this subject, "animals are placed in circumstances congenial to their habits and necessities, it is in vain to look for any remedy, and whatever plan may be designed for their improvement, nothing will be found to be of service unless it is in accordance with the natural and ascertained laws of health."

Modern im-
provements.

If in modern times no improvement has taken place in the breed of horses, their existence in European countries has become one of greater comfort than in the past, and such stables as were formerly common are now only to be met with where the owner is heavily handicapped by poverty, and even in such cases there is generally an effort to do the best possible. The drainage and improved sanitation of towns admit of stables being erected in our midst without injury to the health of the community, and at the same time tend greatly to improve the condition of the horse.

Improved
fittings.

The modern fittings of stables have become in every respect more conducive to this end; iron—painted, galvanised, and enamelled—being liberally used at home and abroad.

Iron stables.

Stables have been sent out to Egypt, and other countries infested by ants, with fittings entirely of this material; the stalls and loose boxes being lined from the floor to the top of the manger with plates of iron, and the divisions between the stalls, instead of having the usual wood cleating, being fitted

with steam-hammered, perfectly-fitting wrought iron plates, secured and strengthened by double-grooved pieces between the middle rails and sills of the partitions. Whether the use of iron, especially of wrought iron, is expedient to this extent, must be a question of experience; but as the hardest wood is often reduced to a fragile shell in a single night by a visitation of ants, it would seem, in such countries as Africa and India, for instance, to be, in conjunction with masonry and cement, the only available material.

An iron homestead, to accommodate 100 cattle, and attached to a farm of 400 acres, has been built by Mr. Humphreys, of Albert Gate, from a design by Mr. Clark, and as the arrangement is unique in its way, a short description of the stables and yards may not be out of place. The range of buildings is only one story high; the stalls and boxes are connected with the mixing-room and chaff-house by means of covered passages, so that the animals may be fed without being disturbed, in the manner shown on Plate 1. They are lighted from the roof by skylights, and adjoin a covered yard. The cart, implement, and tool-house, including a workshop, are placed in immediate proximity to the stables. The stores for hay, straw, roots, &c., are all in close relation to the mixing floor and machinery for the preparation of food. There are two open and two covered yards in this design, the former being, of course, provided with feeding-sheds for the cattle. The description of roof well suited for this kind of yard will be found on Plate 44, and by the necessary increase of its several members may be made to a much wider span, without the use of intermediate posts, and also afford ample scope for ventilation.

Galvanised corrugated iron has been in use for many years, for temporary and portable buildings, and has been largely used for stables. These are usually constructed of fir framing, mortised; so as to be taken to pieces and re-erected without difficulty. They are built with air spaces and filled in also

An iron homestead.

Portable iron stables.

4 STABLE BUILDING AND STABLE FITTING.

with felt, which renders them warm in winter and cool in summer, and are lined with $\frac{5}{8}$ or $\frac{3}{4}$ inch match-boarding. Buildings of this description should not be left entirely open to the apex of the roof, but should be half-ceiled with the match-boarding, and ventilated on the ridge.

Principles of arrangement.

In the several succeeding chapters the author has endeavoured to illustrate the various circumstances which control the principles of stable building, and regulate the provisions to be made in town and country. The buildings, consisting of stables, separate loose boxes, coach-houses, corn and hay stores, &c., as well as those other constructions rendered necessary where large studs of horses are kept, either for public vehicles, for business purposes, or for pleasure, have been treated as questions which have advanced in all their provisions with the progress of the times; commencing with the planning and arrangement of the buildings, and passing severally to the important questions of construction, drainage, paving, ventilation, and fittings, and the numerous details of construction.

Provision for extension.

An important consideration in the construction of stabling is the provision for its possible extension. In large establishments it is customary to provide a separate accommodation for carriage horses, hunters, hacks, and others; and if the possible increase of the stud is kept in view when the buildings are designed, a great deal of expense and trouble may be saved, and if planned in the form of a quadrangle this is not a difficult matter. By means of the Table in Chapter VII., the provision for fodder can also be correctly calculated and sufficient margin allowed in the bins and hay-loft for a reasonable increase. The size of the yard can be regulated by the inclosure walls; and in the country, whether stabling be attached to the house or situated some distance from it, a liberal area should be allowed for this purpose. In the former case the arrangement should be such that, having set down at the entrance to the mansion, the carriage should be able to reach the stabling without passing again through the entrance gate-

way ; in this case it will be best to have a separate entrance to the stable yard.

It is unnecessary to encroach on the succeeding chapters by any reference to the distribution of the buildings in the yard. Simplicity in construction. The stables for private and public uses, illustrated and described in the following pages, with the several details of their fitting, are chiefly those which have been designed or adopted by the author ; and, in carrying them out, he has sought always the simplest and most efficient methods, with the use of those fittings which, without being affected by fashion, or the promotion of some untried invention, have been found by experience to be the most moderate in cost, and to best answer their purpose.

CHAPTER II.

PLANNING AND ARRANGEMENT.

Circumstances regulating arrangement—Administrative block—Washing-room—Vestibule to stables—Arrangement of town stables—Rooms over stables—Lairs and hock baths—Examples of stables—"Private stables," Design No. 1—Design No. 2—Design No. 3 (for town or country)—Design No. 4 (Stables for hunters)—Design No. 5 (suburban stables)—Designs No. 6 and 7 (town and country stables)—Difficulties in towns—Stables in mews—Design No. 8 ("inclosed")—Stables on upper floors—Dimensions of stables—Convertible stalls and boxes—Portable partitions—Loose boxes with stalls—Capacity of stables—Boxes for hunters—Covered way—Breeding stables—Racing stables—Farm stables—Hay and corn stores—Preparation of fodder—Distribution of fodder—Capacity of hay and corn store—Cubic capacity of hay—Tramway and omnibus stables—Omnibus stables—Tramway stables—Manager's offices, &c.

Circumstances
regulating
arrangement.

THE planning and arrangement of stables, with their necessary contingent buildings, are dependent on many circumstances, but chiefly upon the locality, the number of horses for which accommodation is required, and the nature of their employment. Aspect is also a matter of some importance, but it does not affect the relative positions of the buildings in the yard, and cannot be considered an essential point, except for racers and brood-mares. In order to secure the most favourable aspect, stables are sometimes built with a door at either end, to be closed or left open according to the prevailing wind, and in large stables, doors are sometimes placed on all four sides; a very good scheme in theory, but rarely compatible with the arrangements of a convenient plan.

Administra-
tive block.

The administrative department, such as the residence of the

coachman, the mess-rooms and sleeping apartments of the grooms, the harness, saddle, washing-rooms, and stores, should be in a central position, but easily accessible from the stalls and loose boxes. Where special provision is made for washing, as in the case of hunters, the washing-room should adjoin the saddle-room, or form a part of an ante to the stable, into which the saddle-room may be made to open.

This room should have plenty of light, and a liberal provision for hot and cold water, but in ordinary cases the horses are either groomed in their stalls, in a box set aside or built for that purpose, or outside the stable, sometimes under cover on a paved area, as shown on Plates 1 and 6. Washing-room.

A good arrangement is obtained by an archway entrance to a vestibule, with access on either side to the stalls and loose boxes, where a convenient place can be found for a boiler and sink. This plan ensures a freedom from draughts, where the aspect is not a good one, and affords a shelter for the groom. Vestibule to stables.

In the country, where the area of the yard is seldom limited and almost any aspect can be obtained, the greatest facility will be found for the disposition of the several buildings; but even in London, where inclosed spaces have been secured, some examples of the best description of stabling exist. In Sackville Street, Piccadilly, there are some well-planned stables for a large number of horses. In the front, on either side of the entrance gates, are two four-stall stables; two separate coach-houses, loose boxes, a stable for two horses on night duty, washing-boxes, and harness-rooms, are arranged round the court yard. On its right and left hand are two separate staircases, one leading to the coachman's residence, and the other to the grooms' and helpers' rooms, and sleeping apartments. Arrangement of town stables.

If the site allows it, stables are better without rooms or lofts above them, unless the floors are made of concrete; for if the grooms' apartments are over the horses, and divided from them by a wooden flooring only, the noise is liable to disturb their rest at night; and if the hay-loft is over the stable, the Rooms over stables.

forage is contaminated by the gases rising from below. When the old-fashioned overhead hay racks were used this was still more objectionable, as the dust also fell through the trap by which the racks were supplied, on to the horses' heads, and rooms were usually approached by an open staircase, exposing the dwellers constantly passing up and down to possible contagion from a glandered horse.

Lairs and hock
baths.

A lair, or large loose box, is a useful addition to an extensive establishment. It should be fitted up with a boiler, from which a channel may be carried to a portion divided off for the purpose of a warm bath. A loose box, easily convertible into a hock bath, is illustrated on Plate 39; it is supplied with a cold-water tap and drain, and may be used as a bath by the simple expedient of boarding up the doorway to the height required; any escape of water being provided against by a little clay puddling.

Examples of
stables.

A series of twelve plates, embracing eight separate designs, and called for the sake of distinction "Private Stables," shows a variety of arrangements varying chiefly with the required accommodation, and provided with the latest and most serviceable appliances for keeping the occupants in a healthy and useful condition.

Design No. 1.
Private stables

The arrangement illustrated by Design No. 1, and extending over Plates 1, 2, and 3, is a provision for a large stud of horses in the country, capable of future extension by additional stabling on the right. The administrative block in the centre has extra provisional accommodation for attendants and stores, so also has the corn-store situated over the coach-house, having been designed with a view to this enlargement. This building has boxes for hunters and a harness-room on the left, and the probationary boxes L, to which any doubtful cases of illness can be relegated, previous to their removal to the infection wards M, on the right.

These are cut off from all communication with the other stables, and when the attendant comes from them, he passes

at once into the fresh air, whilst the inmates of the sick boxes, without being disturbed, can be fed or inspected by means of the passage at the back. This passage also forms a private entrance for the owner or superintendent of the stables, who can thus enter the yard at any time without passing through the central offices.

The first floor consists of a sitting-room or kitchen, a chamber 18 feet by 12 feet, which may be used as a mess-room, three bedrooms, and a bath-room. The second floor has two bedrooms and two store-rooms, and from this floor there is a steep staircase leading to the clock-turret above. The entrance gateway and a portion of the south inclosure wall are shown on Plate 3.

In the Design No. 2, illustrated by Plates 4 and 5, also for the country, but for a smaller number of horses, the hay and corn store, where the fodder is also cut, bruised, and mixed, is over the coach-house, and a shoot passing through the wall discharges the food, when prepared for consumption, into a bin in the washer's room below. This room, provided with a copper and sink, adjoins the harness-room, in which a bench is fitted up for cleaning bits, spurs, &c., the glass case for their reception being placed in the recess adjoining the fire-place. The transverse section is taken through the stalled portion of the stable, and looking to the left shows a partition of the loose box and the interior of the end stall in elevation. Access to a living-room and bedroom for a groom is obtained by a staircase from the porch, and above is a clock-chamber or store.

Design No. 2.
Private stables

A design will be found on Plate 6, which, with slight modifications, can be adapted to either town or country. The harness and washer's rooms are situated, as in the former design, between the coach-house and the stable, a position which, as it forms the centre of administration, will be found most convenient as a general rule. There are four stalls in this stable, with a loose box opening to the air, and shut off from

Design No. 3.
For town or
country.

the building. The hay and corn is stored and mixed over the harness-room, and discharged by a shoot into the washer's room.

Design No. 4. On Plate 7, which shows some stabling designed for hunters, Stables for hunters. it will be seen that the corn-store and hay-loft are over the mixing-room and archway, with a couple of rooms for the men above the harness-room. The ground plan of this design is that of Mr. Walsh, better known as "Stonehenge."

Design No. 5. The Design No. 5, providing for a pair of horses only Suburban stables. (shown on Plates 8 and 9), is more especially suited for the suburbs, for the country, or for any site where the length of the frontage is not so much a consideration as it usually is in towns, and where space sufficient for ventilation and light is available in the rear; but as this particular design is also ventilated in the roof and lighted in the front, it may be adapted to a mews, or where there is no area at the back, although the frontage, 40 feet, is in excess of what is usually allowed for this situation. The stable, harness-room, and coach-house, are entered from an ante, open to the yard by an elliptic arch; a staircase from the harness-room leading to the corn-store and hay-loft above it, from which a shoot descends with the food, whence it is removed to a bin in the stable, as shown on Plate 9. Suburban stables, however, of limited accommodation, having stalls for only two or three horses, are most frequently built at the side of the house, and approached from the road.

Designs Nos. 6 and 7. Town and country stables. Difficulties in town. The Designs Nos. 6 and 7 (Plates 10 and 11), more especially illustrate the difference in the arrangement of town and country stables. In town the cost of land restricts the areas, and also reduces the frontages of stables. This, together with the rights of the adjoining properties and the necessary Acts of Parliament, do not leave the architect the same scope for the arrangement of his plan as he possesses in the country, or even in the suburbs. In the latter case, where perhaps only one or two horses are kept, the stabling can be built in a small inclosed

yard at the rear of the house, and should be approached, if possible, by a lane or mews.

Where a stable is built in a mews, the length is at right-angles to, and not parallel, as it should be, to the frontage. A reference to Plate 11 will show, at a glance, the advantage of the latter over the former arrangement; more light is admitted and a thorough ventilation is obtained, which can be regulated at will.

The plan on Plate 10 is that of some stabling in a mews under the most favourable condition, having a yard at the back, and the liberal allowance of 36 feet frontage, viz. 17 feet 6 inches for the stable, and 19 feet 3 inches for the coach-house; a couple of apartments over the latter, well lighted and ventilated, being thus obtained, with a hay-loft (30 feet by 17 feet 6 inches), in which the food can be prepared and passed down a shoot into the bin at A. The coach-house in a mews, however, is often only 8 feet 6 inches, or 9 feet in width, and if two carriages are kept, they are put one behind the other. The minimum frontage which should be allowed for a coach-house and stable of this description may be taken at 25 feet, measuring from centre to centre of the party walls, which allows 15 feet 6 inches for the width of the stables, and 8 feet 6 inches for the coach-house. Where a small area can be obtained in the rear (or better still, the 100 feet superficial required by the building Act for a *dwelling*), a much better arrangement can be devised, without which the harness-room must be lighted with a skylight, and the groom's apartments will be limited, or entrench on the hay-loft.

It need scarcely be added that the loose box, which is generally situated at the back, the best place all things considered, being the quietest part of the stable, is often dark and difficult to ventilate, and in these respects unsuited to its purpose.

An example of a stable for the country is shown by Design No. 8 (Plate 12), with a centre washing-house for the horses

Stables in
mews.

Design No. 8.
"Inclosed."

and carriage, having direct access to the stable, coach-house, and harness-room; and by means of a passage to a loose box, entirely shut off by a 9-inch wall, carried up to the roof. The coach-house is closed to the washer's room by revolving shutters, and the stable and harness-room on either side by ordinary doors. The hay and corn store is reached from this central room, and has a pair of sliding doors over the entrance gateway. The stable and loose box have a south-western aspect. This plan may be varied on the upper floor to provide a sleeping-room for the groom; and the coach-house could be also carried up to afford additional accommodation if required. The whole is inclosed within the entrance gates.

Stables on
upper floors.

Owing to the value of land in towns, the plan referred to in the preceding chapter of having stables on upper floors is now becoming very general, and is a good substitute for the limited accommodation obtained in a mews, especially as regards the position of loose boxes. In such a structure the ground floor can be devoted to coach-houses, with a central yard, approached through an archway, from which the upper floors are reached by the necessary slopes, provisions being made on each floor for the corn-stores, harness-room, washing-boxes, &c., with an asphalted yard, and dwelling for the grooms upon the roof. The stables in such a building can be well lighted and ventilated from the roadway, and from the yard. Those designed for Messrs. Crosse and Blackwell by the late R. C. Roumieu, and illustrated on Plate 54, are thus described in the *Builder* of April 15th, 1876:—"These premises have a central open space (the height from the floor to ridge being 40 feet), round which, on the ground floor, are recesses for eighteen vans and stabling for four horses, with store spaces for straw and fodder, harness-rooms, and a yard for dung, water-closets, &c., with a double inclined plane of an easy ascent to the principal stable floor. On the stable floor are stalls for thirty-five horses, and a loose box for a sick horse,

with a fodder-box and chaff-room. In the front towards the street, in the floor above, are the stablemen's living and bedrooms, &c., with windows looking into the open space above the stable, so that a view can be taken at any moment of the whole of the stable on the upper floor. The area is lighted by a continuous lantern, with lights to open upon centres, to ensure good ventilation ; and gas is laid on for night."

The size and general proportions of an ordinary stable may be pretty accurately arrived at from its cubic measurement, which ought to give from 1100 to 1500 cubic feet of air per horse ; a minimum width of 16 feet 6 inches, or from that to 18 feet, according to the arrangement of the plan (which may be modified by the introduction of loose boxes), being sufficient for a stable having a single row of stalls, as shown on Plates 4, 6, 8, 10, 11, and 12. Taking the first-named width of 16 feet 6 inches, being 9 feet 6 inches from the wall to the centre of the heel-post, and 7 feet for the passage, with a width for each stall of 6 feet 2 inches from centre to centre of partitions, and a height of 12 feet to the ceiling, a cubic contents of 1221 feet per horse is obtained. For a stable containing a double row of stalls having a ceiled roof and passage in the centre, as much as 29 feet is sometimes allowed, as shown on Plate 56. Taking 9 feet 6 inches for the stalls, 10 feet for the passage, and 12 feet for the height, this gives a cubic capacity of 1073 feet, scarcely sufficient if there were no opening in the ceiling, which, in this case, utilises the space in the roof. The author considers that for ordinary horses, where a stable of this kind is ceiled, a width of 28 feet and a height of 13 feet, are the most desirable dimensions, giving a cubic contents of 1122 feet per horse ; but that if open to the roof, as shown on Plate 41, 27 feet in width is sufficient, being 8 feet for the passage, and 9 feet 6 inches for the stalls on either side, with a height of 10 feet 6 inches to the underside of the tie-beam, or springing of the roof. This gives a cubic contents of 1260 feet ; but this question is largely dependent on that of ventilation,

Dimensions
of stables.

and is further dealt with in Chapter V. The length of a stable can be easily obtained by multiplying the width of the stalls (say 6 feet 2 inches) by the number of horses to be accommodated in a single row, and by half the number to be provided for in a stable with a double row of stalls. The stables above described are suited for carriage and coach horses, hacks, and the like, and have an available area in the stalls of 57 feet, but this would not be sufficient for racers or hunters, or the larger class of horses devoted to heavier work.

Convertible stalls and boxes.

Several schemes have been devised for converting two stalls into a loose box, or a loose box into two stalls. The middle heel-post *a*, Fig. 1, consists of a column secured at the base, and also at the roof, with two revolving sockets, top and bottom; through this the centre portion *b* of the two

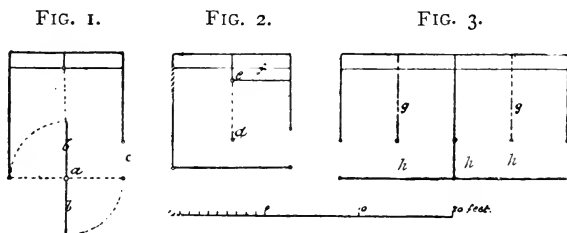

stalls is made to slide, and thus close up the posterior ends of the stalls by a quarter turn of the column, the door to this converted loose box being in the outside partition at *c*. Another arrangement, Fig. 2, consists of a movable heel-post at *d*, and a head-post turning on a pivot hinge at *e*. This renders the area *f*, however, a useless space, liable to accumulate dust and débris.

Neither of these plans are entirely satisfactory, for either the stalls, as stalls, will be unnecessarily long in proportion to their width, and suitable only for hunters, or there will be insufficient depth in them for loose boxes, or not sufficient width for stalls;

in fact, they must be either too large or too small, and are deficient in, or overdone with, manger accommodation.

The movable parts, such as sockets and hinges, of all these designs are made in brass, to prevent their being rusted up when they are left some time without shifting.

Fig. 3 is a less costly and thoroughly practical arrangement for conversion, where it is desired to make temporary additional provision by putting up the movable partitions *g,g*, removing the portions marked *h*, and thus converting the two loose boxes into four stalls.*

A combination of loose boxes and stalls under the same roof is the ordinary plan adopted in private gentlemen's stables, and expense is considerably lessened by this arrangement, a minimum area of 121 superficial feet (11 feet square) being given to the boxes. On Plate 12 will be found a plan for a small stable, having two stalls and one separate loose box with washing-place in the centre, and coach-house at the back; but this very convenient provision for washing carriages and horses has, in many cases, to be sacrificed to contingencies of space, and the advantage of an isolated loose box is lost. On Plate 6 will be found a design for a more effectually detached loose box than usual. A cube of 12, containing 1728 cubic feet, may be taken as adequate for an ordinary loose box, which may be increased to 2000 in those built expressly for infirmaries.

The several provisions, speaking generally, which give to each stable accommodation for twenty, twelve, or ten horses, afford also the greatest facility for supervision, ten being a fair allotment for one man. A stable, therefore, containing twenty horses would be provided with two attendants, and they would have the advantage of mutual assistance, which is frequently required, whilst a stable containing twelve or ten would have but one man. There is, however, the liability of a more rapid spread of epidemic with the larger number of horses in one stable, and since assistance can soon be obtained in a yard, or

* See also Figs. 6 and 7, Plate 19, for portable partitions.

from an adjoining stable, the smaller number, as arranged on this plan (except where the nature of the site renders it impracticable), may be considered the best.

Boxes for
hunters.

Hunters, owing to the exhausting character of their work, should have plenty of room for recruiting and repose; boxes, as a rule, are most suitable for them, and these should be at least 12 feet square; this gives an area of 144 feet super, whilst some authorities consider they should have double this amount, to give them plenty of room to roll. Mr. G. Tattersall says they should be 22 feet long and 13 feet wide, with a 12-foot passage and height of 12 feet. Four or six boxes are sufficient in one building, as the horses are less likely to be disturbed when housed in small numbers, and the stable is more easily kept at one temperature. It is convenient to have some of them convertible into stalls upon the simplest principle.

A design for a stable for hunters is shown on Plate 7, in which the stalls are 12 feet by 12 feet, and by means of a portable heel-post and partition, can be converted into stalls of the ordinary width (6 feet), and the six marked A can be made into closed loose boxes by putting up doors in the position of the dotted lines, and adding about 2 feet of partition, or the temporary provision of a safety bar might be used (as shown on Plate 18, Figs. 3 and 4).

Covered way.

A covered way for exercising the horses under shelter, and passing entirely round the yard, is a common and useful provision, and helps to shade the stables in the time of extreme heat. It should be made 7 or 8 feet wide and 9 feet high.

Breeding
stables.

In breeding stables the yard should be particularly well sheltered, the boxes having a south-west aspect and a dry soil. For barren and brood mares they should be respectively about 12 and 15 feet square, with a well-screened shed to keep them from the wet when they are allowed to be loose.

Racing
stables.

“Nimrod,” writing from his experience of the best type of racing stables, seems to consider that the proportionate number of loose boxes to stalls should be in the ratio of about six to

seven ; and in a model plan arranges them on two opposite sides of a rectangular yard. The centre of one side is occupied by a passage leading to a riding school at the back, on either side of which are situated four boxes and four stalls. On the opposite side, and in the centre, is the coach-house, with the drying-room on one side, and the saddle and harness-room on the other ; a building with six stalls for hacks on the left-hand side of the yard, and four more loose boxes on the right, occupy the remaining spaces, thus leaving a free passage for air between the two ranges of buildings. The rooms for the boys are placed over the drying-room, coach-house, and harness-room, and the hay and straw loft over the stalled stable. The stalls are 6 feet wide by 12 feet deep, with a 12-foot walk in the rear, and the boxes 10 feet wide and 18 feet in depth. A pump occupies the centre of the yard.

On farms, the stable-buildings, in the form of a quadrangle (a Farm stables. shape in which all large stabling is now usually built), are a conspicuous portion of the homestead group, and a south or west aspect in the yard can generally be selected without detriment to the other buildings ; in fact, where stables are built with a passage in the centre, and stalls on either side, and with windows opposite each other, to produce a through ventilation, an east and western aspect is by no means a bad one, provided the stables are well sheltered from the extreme severity of the easterly winds. Farm-stables, like those for omnibus and tramway horses, should be plainly and strongly built, but with the same regard to sanitary requirements, and precautions against damp, that are considered necessary for more valuable horses.

Having decided the number of horses for which provision has to be made, the position of the corn-store and hayloft depends Hay and corn stores. chiefly on the site, but the storage cannot be conveniently separated from the cutting, bruising, and mixing of the food especially if large quantities have to be dealt with ; and where machinery is used for this purpose the engine-house should be divided from the stores by a party wall (as a precaution against

fire), through which the motive power can be transmitted for working the several appliances, as shown on Plates 47 and 48. Even where horse-power is used, as in the case of the Southampton Tramways (Plate 53, Fig. 2), it is better, for obvious reasons, to have a party wall.

Like the coach-house, the corn-store may be a separate building, or, together with the grooms' apartments, form a portion of a central block. In Plates 1, 2, and 3 it will be seen that the author has placed the corn-store and mixing-room over the coach-house, accessible for storage from the public road, but reached by a staircase only from the yard.

It is advisable to have the water tank in the immediate locality of the stores, with a stand-pipe and hose in connection with the supply, as fully described in Chapter VII.

Preparation
of fodder.

The hay may be stored and cut on the first floor, the corn being stored, bruised, and mixed with the cut hay, delivered by means of a shoot, on the floor below, as designed at the stables at Portswood; or the whole operation may be performed on the first floor, as shown on Plate 53, and the food lowered in sacks.

Distribution
of fodder.

These operations are performed by the London General Omnibus Company, principally at their central depôts, and the mixed food is thence despatched in sacks by three-horse vans to the numerous stables situated in all parts of London; and at Southampton the stables at Shirley are supplied from the depôt attached to those at Portswood. In the former case the cost is minimised by the concentration, owing to the large number of stables supplied.

Capacity of
hay and corn
store.

To obtain the area and capacity of a space to be devoted to the storage of hay and straw, it is necessary to arrive at the cubic contents they will require. A truss of new hay or straw occupies about 11 cubic feet, a space therefore measuring 8 feet 3 inches by 8 feet by 6 feet high will give a superficial area of 66 feet, and have a cubic capacity of 396 feet; it will hold exactly thirty-six trusses (equal to one load), which, sup-

posing a horse to consume 16 lbs. a day, would afford a supply for 135 days, and taking the same area with a height of 9 feet, it would provide for one and a half loads. On Plate 11 the portion of the loft inclosed on the plan by the dotted lines and marked *a*, is suggested as a space to be devoted to storing hay and straw, the larger portion being for corn, machinery, and mixing, and the remainder for passage.

A truss of old hay weighs 56 lbs., and a truss of new hay 60 lbs.; but various circumstances contribute to the fluctuation of their cubic contents—the character of the grass land from which the hay is cut, the size and consequent weight of the stack (which may weigh from 88 lbs. to 200 lbs. per cubic yard), and its age (hay is considered old after September). The size of the trusses vary from 7·50 to 11·25 cubic feet; the smaller measuring 3 feet by 2 feet by 1 foot 3 inches, and the larger 3 feet by 2 feet 6 inches by 1 foot 6 inches. Cubic capacity
of hay.

It is calculated that for every acre of grass made into ensilage, 300 cubic feet capacity of silo is required, and one ton of ensilage is pressed into a space of 50 cubic feet.

Tramway and omnibus stables differ materially in their arrangement from those already dealt with as “Private Stables,” additional buildings being required, such as the foreman’s dwelling, smithy, workshop, harness-maker’s shop, and lamp-room (which should be an isolated building), but as the harness is kept in the stables, there is no necessity for a harness-room, beyond the store in which provisional sets of harness are kept. Tramway and
omnibus
stables. It is only in large establishments that a smithy is necessary, and it is generally an economy in the case of omnibus and tramway stabling to provide a fitter’s and harness-maker’s shop a design for a smithy will be found on Plates 45 and 46. The loose boxes are built in a row, and do not form part of the stables; they should be about 5 per cent. on the number of horses provided for. One of these is often fitted up as a surgery, as shown on Plate 37, and is used by the veterinary surgeon on his periodical visits to the stables.

Omnibus
stables.

Plate 32 shows accommodation for 160 omnibus horses, with provision in dotted lines for another 40, making 200 in all. The hayloft in this plan occupies a position over two of the stables (which contain 20 horses each, and are 54 feet long by 25 feet wide). There is also a covered shelter for omnibuses, formed with iron trusses, boarded and slated, and covering part of the space between the two ranges of stables, and under which the horses are washed.

Tramway
stables.

Plates 39 and 50 illustrate severally the arrangement of the North London and the Cambridge tramway stables. The former accommodates 120 horses (12 in each stable), and the latter has eighteen stalls, a loose box, and two closed stalls for restless horses, under one roof. There is also a separate loose box for isolation. In his design for the Southampton stables (at Portswood and Shirley), the author carried out much the same plan as in North London, each stable being divided into twelve stalls, but the awkward shape of the land at Portswood did not admit of so convenient an arrangement of the other buildings as at Ponder's End for the North London. In the former yard, as at Cambridge, the corn store is over the car shed, but the loft door opens to the yard instead of to the public road, and the step ladder is placed in the mixing room, as shown on Plate 53, Fig. 2, whereas at Cambridge the loft is reached from the yard.

Manager's
offices, &c.

The manager's offices, or the foreman's dwelling, should be at the gateway to the yard, or at the entrance to the company's property, as on Plates 32 and 50. At Ponder's End the manager's house was built at the junction where the company's road to the stables leaves the highway; at Poplar it forms the first of a terrace built for the accommodation of the men. Sufficient land is commonly taken for this purpose, and the men thus become tenants of the company, and are in the immediate vicinity of their work.

CHAPTER III.

CONSTRUCTION.

Shape of building—Treatment of foundations—Concrete—Outside walls—Intermediate walls—Foundation walls—Relieving arches—Stone walls—Walls on arches—Damp courses—Rounded edges—Recessed down pipes and taps—Rough cast—Depeter work—Facing with tiles, etc.—Smithies—Dressing rings—Isolation—Division walls—Fireproof buildings—Fireproof floors—Concrete floors—Mr. Hyatt's system—Wood floors—Posts for lofts—Sills—Stables on upper floors—Ventilating partitions—Roofs—Lean-to roof—Common rafters—King-post roofs—Queen-post roofs—Duties of tie-beams—Provisional strength of members—Loft in roof—Open roofs—Gabled roofs—North London Tramway roofs—Zinc roofs—Templates—Wrought iron roofs—Roofs at Ponder's End—Slating and tiling—Covering for walls—Washable distemper—Pointing—Tuck pointing—Colouring brickwork—Wells—Well at Ponder's End—Abyssinian wells—Supply of water—Closets and urinals—Trough closets—Slate urinals—Inclosure walls—Inclosure fences.

ALL buildings for the purpose of stabling should be rectangular; but this is often rendered impracticable by the shape of the site, as shown on Plates 50 and 53. Circular or oval ranges of buildings are also sometimes erected for hunters, with a view of obtaining a more convenient shape for the covered ride usually attached, in the form of a verandah, to the front of these buildings, and supported by iron columns; but in this form they are more costly in construction, and wholly unsuited for ordinary stables.

After setting out the work upon the ground, the architect will be guided in the excavations by the character of his design and the nature of the soil; upon these the dimensions of the trenches and the depth and proportions of the concrete

Shape of building.

Treatment of foundations.

will depend. This will vary considerably in the case of stable buildings, but should never be less than 9 inches under the foundations of a corn store, for instance, or the walls of stables which are built in several floors. A section of an ordinary stable wall, 14 inches thick, with the level of the floor, is shown on Fig. 4; but even here the depth of excavation may occasionally require exceptional treatment. A case of this kind occurred to the author,

FIG. 4.

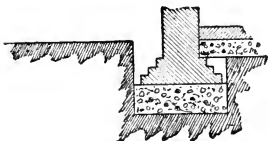

where a peat bog occupied a considerable area of the site, with a depth of 10 feet to the gravel upon which it was proposed to build. In this instance, holes were sunk to the gravel, and piers of concrete, 3 feet square, carried up to within a short distance of the ground-level; arches were then thrown from pier to pier, consisting of three rings of brick in cement, rising slightly above the finished level of the stable floor, and upon these the walls were built; by this means a great saving was effected in the brickwork, and the stalls were unusually dry.

A good concrete, giving the proportions of 1 in 8, is to be obtained by the use of the boxes shown in Fig. 5.

Concrete.

FIG. 5.

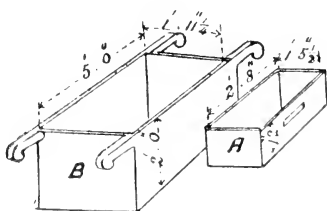

| | | | | |
|---|---------------------------------------|----------|-------|------|
| A | to be filled once with cement | equal to | 3'85 | } 27 |
| A | ,, ,, twice with washed sand | ,, | 7'70 | |
| B | ,, ,, once with screened gravel | ,, | 19'30 | |

cubic feet.

This is not equal to a cubic yard of concrete mixed, which takes 30 cubic feet of ballast and sand, and $3\frac{3}{4}$ cubic feet of lime, measured dry. Thames ballast contains about two parts of gravel to one of sand.

All outside walls for stables should be one and a half brick thick, as damp and cold easily penetrate through 9-inch work. Outside walls.

In the walls forming the divisions between stables, piers 14 or 18 inches wide may be used, as shown on Plates 34 and 35, by which means the intermediate brickwork can be reduced to 9 inches, the piers projecting $2\frac{1}{4}$ inches from either face of the wall, but they should occur at those places only where the principals of the roof are sustained, and will be improved in appearance if the angles are finished with bull-nosed bricks; it is better, however, to carry the 14-inch work to about 3 feet 9 inches from the level of the floor. This is especially necessary where provision is made by brick corbelling for the support of the manger, as shown on Plate 20, Fig. 4; and care must be taken in construction that the sailing courses, as they are termed, consist entirely of headers built in cement; each of the four courses (the extreme projection of which is $4\frac{1}{2}$ inches), should break joint with the one below it; all brick corbels should be executed in this way; those for the support of wall plates, for instance, though the author does not recommend their use. Intermediate walls.

The brickwork in all cases should be carried through beneath the openings for doors, drains, &c., and the fixing of the door-frames to the brickwork should, in the case of stables, be especially strong. The frames should be secured by pieces of hoop-iron screwed to three wooden bricks built firmly into the brickwork at equal distances on each side of the opening, and these, together with all other frames, bedded and pointed in lime and hair. Foundation walls.

Relieving arches must also be turned over; all the openings as shown on Fig. 6, which illustrates the window of a corn store, swung on pivots. Relieving arches.

Stone walls.

If the stables are built in stone countries, of rough, irregular, or laminous materials, the external walls should be at least 20 inches thick, and built and pointed in cement up to the level of the paving when the soil is such as to require special prevention against damp.

FIG. 6.

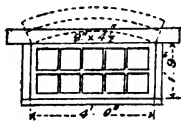

FIG. 7.



Walls on arches.

The walls are sometimes built on arches, with a view of cutting them off more thoroughly from damp.

Damp courses.

Stoneware forms one of the best materials now in use for damp courses. It is made for this purpose in the form of vitrified blocks, with groove and tongue joints, to suit any thickness of wall, as shown by Fig. 7. Staffordshire bricks built in cement, two thicknesses of slates also in cement, or asphalt $\frac{1}{2}$ inch thick, are effectual also as damp courses. A dry area even, all round the building, may be sometimes rendered necessary in swampy districts; in fact, the more the damp is cut off, by the intervention of space, the better; and this is the chief value of the stoneware damp courses.

Rounded edges.

All sharp corners, liable to injure the horses, should be avoided; the angles in the yards, and especially the outside edges of all door jambs (where the doors are not hung flush with the outer face of the wall, in which case they should be rounded on the inner angle), are unsafe, unless carried up with rounded corners to the height of at least 8 feet, as shown in Fig. 8, and also on Plate 27. This is done with a specially moulded brick (Fig. 9), known as "Cliff," or "Burt's No. 8 bull-nosed bricks." These bricks may also be advantageously used in forming window-sills, where the windows are so low down as to render the ordinary square stone projecting sill a

possible cause of injury to passing horses ; in this case they must be built in flush with the wall.

Cast-iron rain-water pipes, and even water taps, are best protected by being recessed in the walls, as they are necessarily

Recessed
down pipes
and taps.

FIG. 8.

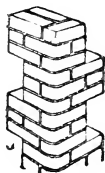

FIG. 9.



more liable to be broken in stables than in other buildings. The former should be in chases, built as the work progresses, by inserting a piece of wood of sufficient scantling for the diameter of the pipe, and building round it to the required height. It will be seen in the accompanying designs that the down pipes, both in and outside the buildings illustrated are mostly recessed (see *i*, Plate 39).

A good effect is produced for the walls of stables and coach-houses by the use of rough castwork ; the mixture for this purpose is made with washed gravel, mixed with hot hydraulic lime and water. This is cast upon a prepared surface from large trowels whilst it is in a semi-liquid state. To prepare the ground a layer of coarse stuff is "pricked up," upon which a second layer of a similar kind is spread. Whilst the latter is wet, and in progress, the material is thrown upon it, and forms a rough coating, which is at once coloured with lime-wash and ochre.

A still better result may be obtained by what is known as "Depeter work," consisting of small stones pressed into the material whilst soft. Both of these operations may be performed on the outer surface of rough brickwork, or upon brick nogging,

and have found considerable favour in rustic designs for stabling, especially in conjunction with ornamental tile facing. But the character of the construction, as well as the materials used, are dependent largely on locality, and may be influenced also by the style of existing buildings.

Facing with
tiles, &c.

A cheap and effective method of covering the gables, and walls of the upper floors of stable buildings, often used in union with rough cast and half timber work, is illustrated by Fig. 9A,

FIG. 9A.

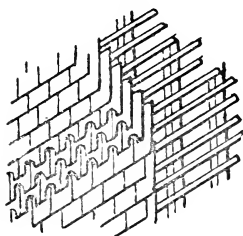

and also shown on Plates 6 and 7. The face of the timber framing is covered with oak laths and tiles, the hidden and upper part of each tile being pointed with lime and hair mortar. The framing may be finished on the inner side with the usual lath and plaster, or treated as brick-nogging, and filled in with brickwork of the necessary thickness. Ornamental concrete slabs,

plain or stamped with a pattern, may be also successfully employed.

Smithies.

Smithies are only used in large establishments where special buildings are required for shoeing. Omnibus and tramway stables are usually provided with them, and also with fitters' and harness-makers' shops.

The author has found that the design on Plate 45 has afforded general satisfaction to the several companies for whom it has been built. The whole of the hearth is constructed in brickwork in cement, including the hood, which is supported by a wrought angle iron 4 inches by 4 inches by $\frac{1}{2}$ -inch, in such a manner that the weight is thrown effectually on to the outer wall. The flues of these hearths should always be cored throughout with cow-dung mortar. It will be seen by referring to the sections on Plates 45 and 46, that the light, which if possible should be northerly, is admitted from a nearly vertical

sash fixed at the height of 13 feet, immediately under the slope of the roof, and should have an available area of one-tenth of that of the walls.

A smithy of this size will afford sufficient accommodation for 200 horses, and dressing-rings are provided, as shown at R, on Plates 45 and 46, for the shoeing of three horses at a time; these are firmly bolted through the wall, as exhibited in detail on Plate 46, Fig. 2.

Loose boxes, when designed for large stables, as shown on Plates 1, 32, and 39, or exclusively for the use of invalided horses, can only properly fulfil their purpose by being not only built as far away as possible from the other stables, but by being separated completely from each other.

The division wall should, therefore, be carried up to the under side of the roof, or continued in inch boarding as shown on Fig. 2, Plate 37. The walls should be rendered in cement or carefully pointed, and, together with the inside of the louvres in the roof and all internal woodwork, be frequently limewhited. The walls dividing these boxes may be one brick in thickness, but all the external walls should be built in $1\frac{1}{2}$ brickwork. They are provided with eaves, gutters, or with parapet walls, double-tile creasing, and cement fillets, as shown on Fig. 1, Plate 37. The roof in this case is covered with zinc, and the wall plates are partly supported by corbels of brick in cement. The louvres are covered with close $\frac{3}{4}$ -inch boarding and plain zinc.

The question of fireproof buildings is one which has for some years past exercised the ability of the profession, with, until lately, very little practical result. It is certain that wood has often more effectually opposed the destructive progress of a conflagration than iron.

If floors cannot be made absolutely fireproof, they can be constructed to check the progress of fire. Those of the hay and corn stores, upon Plates 3, 10, 11, and 12, are designed with a view of protecting the iron used in the construction as

much as possible from the action of the heat; for the destruction of a building, in the event of fire, where iron girders are exposed, may be pretty safely anticipated. Fig. 10 shows a longitudinal section in part, of a concrete floor composed of

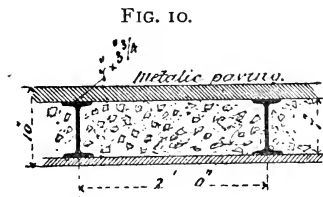

one part of Portland cement, one part of sand, and four parts of broken flints or pumice-stone, sufficiently small to pass through a ring $1\frac{3}{4}$ inches in diameter; a layer, 2 inches thick, of metallic paving is spread on the top of

the concrete, and the under surface covered with Hittings' patent fireproof plaster, forming a ceiling to the floor below. A floor of this description, or finished with $1\frac{1}{4}$ inch of asphalt, presents an excellent surface for mixing the food upon, and the posts of the corn-bins, shown in Figs. 1, 2, and 3, Plate 54, can be fixed firmly into the concrete while the work is in progress. The concrete must be perfectly set where asphalt is used, before it is laid on.

Concrete floors.

The method of constructing floors by embedding wrought-iron grills in cement or plaster of Paris (answering the purpose of our concrete*), was first used by the French, and was adopted for the floors of the Louvre.

Mr. Hyatt's system.

Mr. Thaddeus Hyatt has gone very deeply into the use of concrete for floors, and has published a work, the result of many experiments, which shows conclusively the great strength of floors having wrought-iron cores embedded in this material.

Wood floors.

Although preference should be given to these floors for corn stores, and where machinery is used, over those of the ordinary construction in wood, a very perfect close-jointed floor may be made of the latter material, in favour of which a strong prejudice exists, as it is reputed not only to maintain but improve the condition of grain. On Plates 47 and 48 will be found

* The Système Thusnè, Système Vaux, and others.

a floor of this description. In this case the joists are 9 inches by 3 inches, and 26 feet 6 inches long; they are supported in the centre by a longitudinal girder, 10 inches by $4\frac{1}{2}$ inches, 40 feet long, and resting at either end on the stone template of a brick pier and built into the wall, with three cast-iron columns as its intermediate supports. The joists have two rows of herring-bone strutting, one on either side of the girder, and are 15 inches from centre to centre. The columns, which are shown in detail by Fig. 5, Plate 54, are 9 feet 9 inches in height, and weigh $3\frac{3}{4}$ cwt. each. They are socketed into a block of Portland stone, resting on concrete. The boards are $1\frac{1}{2}$ inches thick, planed on the upper surface, and grooved and tongued with hoop iron.

Posts of wood are also used as supports, in many cases fitted into cast-iron sockets, as shown in Fig. 7 on the same Plate, bedded on stone or concrete, and tenoned into the under side of the girder. The floors of corn-stores should be made to carry a weight of $2\frac{1}{2}$ cwt. per foot super.

The floor of the corn-store and hayloft over the car-shed at Cambridge was boarded, and Fig. 11 shows a section of the oak sill and rolled girders carrying the floor over the gateway to the car-shed at H, on Plate 51.

The construction of stables upon upper floors, referred to in the last chapter, may be carried out in two different ways; either by means of arches built in rings of brickwork in cement and springing from rolled or cast-iron girders (the former are now in most frequent use), or of rolled-iron joists bedded in concrete, as previously described, the method now most commonly followed.

In those erected for Messrs. Crosse and Blackwell's stables, the former method was adopted. The brick arches, carrying

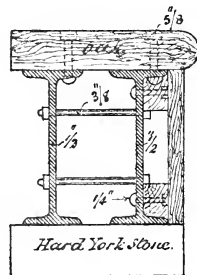

FIG. 11.

Sills.

Stables on upper floors.

the first floor (13 feet above the ground level), were filled in and levelled up with finely-broken bricks, upon which was spread a layer of Messrs. Wilkinson's granite paving, V-jointed, in imitation of stones. The inclined approaches, branching to the right and left, having a slope of 1 in 5, the ascent commencing with a single incline at the back of the yard, were covered with planks, having wood fillets firmly spiked on at every 30 inches, and the surface was tarred. It is kept constantly and thickly strewn with tan.

Ventilating partitions.

The stall partitions have ventilating partitions of iron resting upon small blocks of stone, thus raising the sill about 3 inches above the level of the floor, and giving a through ventilation to all the stalls, as shown in Fig. 1, Plate 18.

A large iron tank supplies the water-troughs, and a hose was arranged for the purpose of washing down the stalls, and also for use in the event of fire. A section and plan of these stables will be found on Plate 55.

Roofs.

The treatment of roofs is an important part of construction ; in those for covering stables, as little iron as possible should be used, as it rapidly corrodes and requires constant painting. The span is seldom sufficient in a private stable to render it necessary, for the sake of economy, that a roof framed entirely in iron shall be used, as in the case of a livery stable-yard or that of a shed for a tramway or omnibus company, where it is also requisite to dispense with intermediate supports.

Lean-to roof.

That which is known as a lean-to roof is used when the span does not exceed 10 or 12 feet. It consists of common rafters only (sometimes with an intermediate purlin), these are 12 inches apart, notched on to a wall-plate on one wall, and resting against or built into the other, against which the roof leans.

Common rafters.

Above this span, and up to 20 feet, the common rafters are carried by a central ridge, from which they slope to the wall-plate on either side, at an angle depending on the nature of the material with which the roof is covered ; they are braced by a collar-tie, and, when there is a ceiling, are additionally

strengthened by the ceiling joists being secured to the foot of the rafters.

For roofs from 20 to 30 feet span, a king-post and principal rafters are required, which, together with the struts, form what is known as a truss, or principal, and sustain the purlins in a longitudinal direction about every 10 or 12 feet, and upon which, in their turn, the common rafters are supported, as shown on Plate 35. Above this span it is usual, if timber is employed, to use a queen-post roof.

King-post roofs.

Queen-post roofs.

The thickness of the tie-beam for the roofs of lofts and stables varies with the purposes it may be called on to fulfil, but in wood is rarely made so light as to perform its duties as a tie *only*. It has often to carry the weight of shafting or of a ceiling, and to withstand the effect of machinery in motion, as shown on Plate 48; or it may have to support the bales and the poles from which they are suspended, as shown on Plate 35; or, through the heel posts, may have to resist the shocks from the vagaries of a kicking horse; it may also have to carry the floor of a loft.

Duties of tie beams.

A case is illustrated on Plate 41, where the members of the roof were made of extra (provisional) strength, with a view to the conversion of the buildings into fitter's shops for the introduction of steam tramways.

Provisional strength of members.

The best accommodation for the storage of fodder, when it is considered desirable to utilise the space in the roof for the purpose of a loft, will be found in the method of construction illustrated on Plate 43, Fig. 2.

Loft in roof.

The design for the open roof on Plates 34 and 35, and that also on Plates 40 and 41, have both been found successful examples in practice. The interior of such roofs may be preserved and kept wholesome by being wrought and painted, or left rough and well-sized and limewhited.

Open roofs.

The somewhat complicated construction of roof shown in the first of these designs has two gables at right angles with the longitudinal section of the king-post roof, for the purpose of

Gabled roofs.

lighting and ventilation, with a shutter on butt hinges in each, and a smaller gable with louvres at the opposite end. This roof is covered with corrugated tiles.

North London
Tramways
roofs.

The roof illustrated by Plates 40 and 41 is covered with Vielle Montagne zinc of the Italian pattern, and therefore, but for the above-named provision, might have been made lighter in some of its members. This is laid upon 1-inch diagonal boarding, wrought on the underside for painting, with wood rolls or rafters $1\frac{3}{4}$ inch wide nailed to it, the latter being rounded to receive the corrugations of the zinc, as shown on Fig. 12. Where the boarding is dispensed with, the rafters are 3 inches by $1\frac{3}{4}$ inch.

FIG. 12.



Zinc roofs.

The additional depth is also used with the boarding, and allows a space for air between the two materials, an advantage (where zinc of sufficient thickness is used) in a stable or corn store.

Templates.

The pole plates, purlins, and longitudinal timbers of the stables above referred to rest on small York stone templates 9 inches by 9 inches by 3 inches, built into the walls, whilst those of the girders, to which the heel posts are tenoned, are 18 inches by 9 inches by 3 inches. It is not a good plan to secure the heel posts to any members of the roof, the timbers of which should be made of sufficient section to transmit its weight to the external walls. In this case the longitudinal girders do not support the principal of the roof, and a slight camber is given to the tie-beam.

Wrought
iron roofs.

For the covering of yards and sheds, where the span is over 30 feet, wrought-iron trusses are preferable to wood; although the purlins to receive the boarding should be of the latter material. These may be secured to the principal rafters either

by knees, or by small L-irons running the entire length of the purlins.

The roofs of the car-sheds at Ponder's End are illustrated on Plates 42, 43, and 44, and show the construction and details of a roof with wrought-iron trusses for a span of 40 feet. These roofs were glazed for the length of 72 feet on either side, with Rendall's patent glazing, which does not require the use of putty, a method not only successful in keeping out the wet, but in providing against the dripping of the condensed water from the under surface of the glass. The other portions of these roofs were covered, like the stables, with zinc of the Italian pattern and No. 16 gauge.

Roofs at
Ponder's End.

Slates and tiles are both indifferently used for the roofs of stable buildings, but the latter are more in harmony with the style of building usually adopted for this purpose in the country.

Slating and
tiling.

In all well-finished stables the rough surface of the brick-work over the mangers should be rendered with cement, or covered with glazed tiles or other material of a non-absorbent nature, such as slate, to a height of at least 2 feet above the top of the manger, as shown on Plates 40 and 41, the remainder of the walls, if economy is to be considered, being carefully pointed and well whitewashed in two coats. In private stables this space cannot be better treated than with tiles, as in Plates 5 and 9. Where there is plenty of light, however, the highly glazed white tiles, which are a great advantage in a dark stable, have been found to try the eyesight of the horses. This has led to the manufacture, by the St. Pancras Iron Company, of a tile made of glass, which, with a slightly roughed and veined surface of green, is very effective and perfectly non-absorbent. Under the mangers the wall is better covered with matched boarding, to correspond with the stall divisions, or rendered with cement.

Covering for
walls.

If the whole surfaces of the walls are covered with plaster or cement, an agreeable tint of great durability can be given to them by the use of Duresco distemper or Morse's water-colour,

Washable dis-
temper.

both of which can be washed without injury to the surface, and are much less expensive than paint for inside work. The Duresco will cover, in two coats, from 200 to 300 square yards, and for outside surfaces (such, for instance, as the dado, shown on Plate 42) from 100 to 200 square yards.

Pointing.

The best description of pointing for all stable buildings is "a neat struck and ruled joint" for the outside work. The internal walls, when prepared for whitewash only, to be finished with what is called "a neat struck and fair joint," the walls being well cleaned down and stopped.

Tuck pointing.

Tuck pointing for external work is not durable, and it is better to confine this description of pointing to the arches of doors and windows, and the decorative parts of cornices, where coloured bricks are used, to quoins, &c., and where it can be executed in putty.

Colouring brickwork.

The custom of colouring brickwork has become objectionably frequent, and is generally done to hide the inferior quality of the bricks, or to conceal defects in the work ; it has also an evil effect on the lime used in the pointing.

Wells.

A great deal of importance is necessarily attached to the water supply of stables, which, if not supplied by a company, is usually drawn from a well. There are often circumstances in which it can be obtained from a reasonable depth, and free from impregnation ; such an opportunity presented itself to the author at Ponder's End.

Well at Ponder's End.

The water for these stables was drawn from a stratum of gravel resting on the London clay. The well, which was situated between the New River and the River Lea, yielding a constant and liberal supply of pure water (which had been well filtered by its passage through 10 feet of gravel and sand), was lined with rock concrete tubes. These tubes, shown on Fig. 13, are silicated by the Victoria Stone Company's process, are made of a dense cement concrete, and have been for many years in use in the United States. They are manufactured by Messrs. Sharp, Jones, & Co., for sewers from 12 to 36 inches in

diameter, the larger size being well adapted for steining wells, and where extra strength is required on account of additional depth they can be cemented at the joints and surrounded by concrete. Those used at Ponder's End were 3 feet inside diameter, $2\frac{1}{2}$ inches in thickness, and 3 feet in depth, and weighed 250 lb. each. They had an O.G. edge for joining, which can be rendered watertight with cement.

The author has also been successful in obtaining an abundant supply of water by the use of Messrs. Legrand and Sutcliff's Abyssinian tubes. Three of these were sunk and connected with an horizontal cast-iron main, and the number may be easily multiplied to meet an increased demand.

It will be clearly seen that the quantity of water supplied by these wells does not so much depend on the diameter of the tubes, as upon the character of the stratum from which the supply is drawn, and it is better in most cases to sink a series of 3-inch tubes, about 30 feet apart, and connect them as above described, than to depend on one of larger diameter.

Closets and urinals for the men engaged in a stable yard should be erected in a part where they are least in view, and be protected by a screen wall, as shown on Plate 49; this illustrates a closet of rather a primitive description, but of the kind which is chiefly constructed for large stable yards, consisting of a trough with $4\frac{1}{2}$ -inch brick in cement dwarf wall as a riser, with $4\frac{1}{2}$ -inch by $2\frac{1}{4}$ -inch fir kerb built into the walls at each end, and notched into the sills of the separating screens. The trough *a* is built up in concrete and rendered ($\frac{3}{4}$ inch thick) in Portland cement, having a slope of 1 in 24 to the out-fall, and is provided with a valve by which it can be freely flushed. The walls are pointed and twice limewhited. The flooring is formed of 6 inches of broken brick, covered with

FIG. 13.

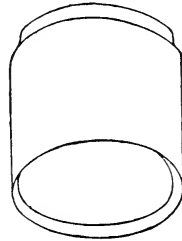

Abyssinian wells.

Supply of Water.

Closets and urinals.

3 inches of metallic paving. The roof is of zinc (No. 16 gauge), on $\frac{3}{4}$ -inch rough boarding. The door frame has a transom, over which it is left open for ventilation.

A series of closets upon this principle, of a somewhat better description, having an earthenware trough and automatic flushing apparatus, as shown in Fig. 14, has been patented by Messrs. Bowes, Scott, & Co.

FIG. 14.

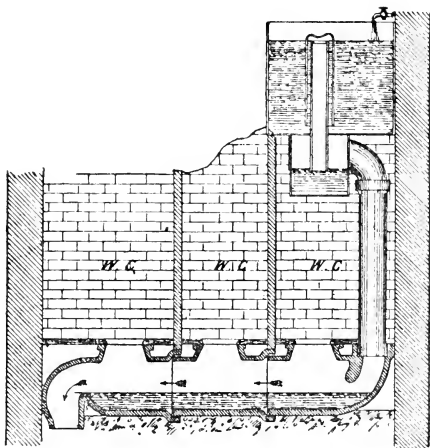

Trough closets.

Slate urinals.

The best description of urinals for stable yards, are those with slate divisions, which should not be less than 2 feet apart, 5 feet 6 inches high, 1 foot 6 inches wide, and $1\frac{1}{4}$ to $1\frac{5}{8}$ inch thick. The riser forming the trough should be also of slate, and fixed at an angle of 75° with the level of the paving. The back may be of slate or of brickwork rendered in cement.

Inclosure walls.

The inclosure walls and fences of yards may be taken at a minimum height of 7 feet; an example of each, as erected at Ponder's End, will be found in the positions A and C, on

Plate 39. The wall at A (Plate 25) is built of white stocks with splayed plinth and details of red brick.

The piers of the entrance gates are the same, but are chamfered, and have a red brick necking fillet and Portland stone caps.

On Plate 26 will be found the inside view and details of the Inclosure fencing at C. The thick black lines on the diagrams *a* and *b* fences. represent the saw cuts, by which the rails and vertical boarding are obtained ; the former are tenoned into the oak posts, the butt ends of which are left rough and charred up to ground level.

CHAPTER IV.

DRAINAGE.

Drainage requirements—Open surface channels—Wrought iron surface gutters—Open brick channels—Channel bricks and blocks—Drainage of loose boxes—Outlets of gutters—Granite open gutters—Wrought iron covered surface gutters—Drainage in relation to paving—Slope of stalls—Steep inclines—Underground drainage—Jointing pipes in clay—Cement joints—Filling in—Velocity in pipes—Manholes—Inspection pits—Ventilation—Yard gullies—Iron syphon traps—Earthenware traps—Drainage of omnibus and tramway stables—Disposal of sewage—Cesspools—Manure-pit with cesspool—Surface drainage—Rain water—Advantage of soft water—Remarks.

Drainage requirements.

THE most perfect system of drainage for stables, is that which carries away most completely, the largest volume of sewage in the shortest space of time, and affects the surface level of the paving least. The importance of this consideration can only be thoroughly understood in connection with the succeeding chapter.

Open surface channels.

Open surface channels are strongly to be recommended for the interior drainage of stables; they are freer in their action than underground drains, as they are kept clean by the constant sweeping and washing of the stable, and the difficulties which arise from disturbing the surface of the ground in the event of a stoppage, are confined to the main drain or the larger tributaries in the yard. These channels can be made of the material with which the stable is paved—viz., of brick, Wilkinson's or other metallic paving, or of iron. A good surface gutter may also be formed in granite cubes, if they are carefully selected, laid to proper falls, and pointed in cement; but

this is more especially suited for the stables of the heavy kind of draught horses.

A serviceable wrought-iron open-surface gutter is shown on Plate 14, Fig. 1, the invention of Mr. Spooner of the Royal Veterinary College. It is roughed on the surface, and provided with riveted lugs for bedding on concrete; and, owing to its shallow character, is easily kept clean. This kind of gutter is only equalled by one of a similar curve, or slightly deeper, executed in Wilkinson's granite asphalte, or some similar metallic paving, and grooved to form a foothold, as shown in Plate 14, Fig. 4. A gutter of this kind is more likely to keep its level if laid upon concrete than upon the usual bed used for these materials—viz., a depth of 6 inches of broken bricks, and is without the disadvantage of joints, inseparable from iron gutters of every description.

The ordinary open brick channel, shown on Plate 14, Fig. 2, when formed of the hard semi-circular Staffordshire gutter bricks, wears too slippery, and yet presents so sharp an edge in the gutter as frequently to cut the hocks of horses as they stretch their legs over it or rise to their feet. With a view to obviate this difficulty, the author designed the form of brick, illustrated in Fig. 15, and on Plate 14, Fig. 3, which has the advantage of the iron gutter, first designed by Mr. Spooner, but afterwards somewhat modified in shape by the St. Pancras Iron Company. Although the stable may be paved with brick, the gutter may be formed with metallic paving, and sufficiently grooved to prevent any slipping on its rounded surface, which should form a flat curve.

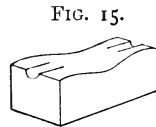

Channel bricks and blocks of various sizes, to correspond with the grooved, and chamfered bricks, of which the several pavings (more fully described in the succeeding chapter) are composed, are made by several firms. Figs. 16 and 17, manufactured by Mr. J. Hamblet, are excellent shapes for the stopped

ends, and junctions of surface gutters. Fig. 18 shows a perforated gutter brick by the same maker.

Drainage of
loose boxes.

It is not so easy to combine a complete system of open surface drainage with the best method of paving a loose box.

FIG. 16.

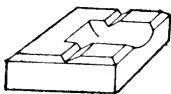

FIG. 17.

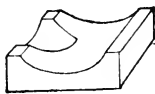

FIG. 18.



The most natural means would seem to be a central gully, to which the watersheds of the floor may be made to converge with the shortest gradient, and the liquid be got rid of as quickly as possible. By any of the plans shown on Plate 13, A, B, C, or D, the slope of the paving is reduced to the minimum, and the floor of the box when grooved can be made practically level. But there is a great advantage, in a sanitary point of view, in having both stalls and loose boxes free from gullies, and this the author has endeavoured to obtain in his designs shown on Plates 10 and 11, without making the slope any longer in the loose boxes than in the stalls, by means of open surface gutters.

The drainage of the loose boxes, shown on Plate 11, is treated in the same way as in the stall *b*, on Plate 13, and by this means a very good system of open surface draining is obtained with an easy slope to the principal drain, representing an incline of 1 in 80. On Plate 10, also, a system of open surface drains is shown, and the slope of the loose box is that of the stalls; but, as a question of paving, as giving the best foothold upon a grooved floor with the most level surface, the principle of a covered gutter with a fall, or that of a central trap, is undoubtedly the best.

The square openings in the wall on either side of the door, as shown on Plate 41, through which it is usual to discharge the surface drainage into the gully immediately outside, do

Outlets of
gutters.

not appear sufficiently large, nor should they be situated in positions to admit any draught to the detriment of the horses, an objection which has been raised by the advocates of covered drainage. A good position for a gully is immediately inside the wall, if this objection is seriously entertained. Major-General Sir F. Fitzwygram, in his work, suggests that an open-surface gutter should be carried, not less than 12 feet beyond its passage through the wall, before joining the underground drain, and considers it acts as a sort of natural trap to prevent solid matter from passing into the drains, and also keeps the effluvia from reaching the stable (see Plate 56), but both these duties should be performed by an efficient trap. The whole length of the surface gutter being well flushed in washing, the liquid should pass at once through the wall; and, by means of a syphon trap and pipe, as shown on Plates 8 and 9, reach the subterranean system quickly.

When open surface gutters are formed in the granite paving of the passage, as in the tramway stables at Southampton, however well the cubes may be laid, they should have a fall of not less than 1 in 60, the gutter starting at a level with and dividing its fall with the slope of the passage.

Wrought iron surface gutters, having perforated movable covers, shown in Fig. 19, are now much in use in stables where open-surface gutters are objected to, but they are more liable to be choked, and if left uncovered are dangerous to the horse; while those of cast iron are still less desirable, as they are more liable to be broken.

The objection that the litter in open-surface gutters is not kept so dry is scarcely a valid one, since of the whole area of the stall, it is only the actual surface of the gutter itself (a small one), that will be especially dry, or dryer than it would be with an open surface of sufficient fall.

Granite open gutters.

Wrought iron covered surface gutters.

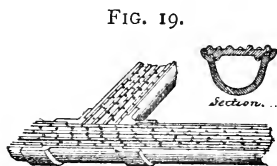

Drainage in relation to paving.

The effective drainage of a stable depends a great deal upon the material and character of the paving, which is dealt with in the succeeding chapter. The stalls should not have a greater incline than 1 in 80, or $1\frac{1}{2}$ inch in every 10 feet, unless they are paved with granite, when it may be increased to 1 in 60 or 2 inches in 10 feet, as the rougher surface impedes the velocity.

Slope of stalls.

On Plate 10 it will be seen that the granite paving at the head of the stalls and loose box commences an inch lower in each as it approaches the outlet at O, and this gives a fall of 1 in 60, and the same to the gutter in the passage. On Plate 11 this difference is increased to 2 inches, and the incline in stalls and loose boxes reduced to 1 in 80; whilst the principal gutter has the same fall to O.

Steep inclines.

A steeper incline than that of $1\frac{1}{2}$ inch in the length of a stall is not only unnecessary when the paving is of brick or asphalt, but it puts a strain upon the horses and affects those especially which do not lie down to sleep. Many consider that a stall should be perfectly level, and for use in such instances a gutter is made having a level wrought-iron perforated top with cast-iron invert for bedding on concrete, and a slope of 1 or $1\frac{1}{2}$ inch in the length of the stall.

The section, Fig. 19A, is that of a gutter, manufactured by Messrs. Cottam and Willmore, having a fall of 1 in 120 (equal to an inch in 10 feet), and used in union with their syphon trap, shown in Fig. 26A. By the use of these gutters the paving of a stall can be made perfectly level in its length, with a fall, from either side to the centre, of $\frac{3}{4}$ of an inch for brick and $\frac{1}{2}$ an inch for asphalt. The loose boxes can be drained in the same way. The cover is made very strong by an iron rib running along the centre, and altogether it forms one of the best examples of surface drainage.

FIG. 19A.



Underground drainage.

Vitrified stoneware pipes, with socket joints, form the best description of underground drainage. They should be laid as straight as possible, with a uniform fall, which for 4-inch pipes

need not exceed 1 in 100, giving a velocity of 3 feet per second; they should be without right-angled junctions or sharp bends, and the gradients may be regulated in long distances by a judicious use of cesspits.

These pipes are often jointed in clay, which can only be considered superior to cement in exceptional cases; where, for instance, the ground is liable to subsequent settlement, this would cause a fracture to a too rigid line of pipes. The joints should have two layers of tarred yarn forced into the bottom socket, and the entire remaining space between the spigot and socket filled up with tempered clay, well driven home with proper tools. The joint, externally, should also be enveloped in a band of clay. Jointing pipes
in clay.

In most cases, however, the use of Portland cement is to be recommended, in preference to clay, and it is sometimes necessary to take the precaution of bedding the pipes half way up in a concrete cradle. The caulking should be done all round with oakum or gaskin, which will prevent the cement escaping through the joints. Wooden scrapers should also be used as the work proceeds, to remove any portions of cement that may afterwards harden and stop the passage. All liquid should be carefully excluded from the pipes until the cement is set, nor should they be covered in until it has completely hardened. It is a good plan to let the socket of every pipe rest on a bedded brick that the joints may be more effectually caulked. The cement used should consist of one part of cement and two parts of clean sharp sand. Cement joints.

In all cases where the ground has to be filled in, a liberal use of water by means of a hose should be allowed to run into it, so that as firm a bed as possible may be obtained for the concrete and paving. Filling in.

Four-inch drain pipes, as shown on Plates 32 and 50, will suffice as branches from the stables and gullies, but they should be of 6-inch diameter from the men's closets, and have a fall of not less than 1 in 150, which will give the same velocity Velocity in
pipes.

as a 4-inch drain with a fall of 1 in 100, viz. 3 feet per second, both pipes running half-full under the same conditions. A 9-inch pipe would have a fall of 1 in 225, a 12-inch pipe a fall of 1 in 300, and an 18-inch pipe a fall of 1 in 450. The size of the main drain is regulated by the number of horses, but is rarely required to be above 9 inches.

Manholes.

Manholes, inspection, and ventilating pits are, with few exceptions, necessary only in long lengths of drains; but the first of these is often required at important junctions. The author was, on one occasion, obliged by the authorities to construct a small manhole on premises where he was carrying out some stable buildings simultaneously with a drainage scheme for the town, as illustrated by the manhole $\frac{1}{2}$ on Plate 39. Plans and Sections of one of these manholes, with the angle footiron used, are illustrated on Plate 49. It is of exceedingly simple and inexpensive construction, and was built for an egg-shaped sewer, 2 feet by 3 feet.

Inspection pits.

Pits for the purpose of inspection and cleansing are built with the pipes running through them, having a 2-foot length of pipe with a movable section, as shown on Fig. 20; by the

FIG. 20.

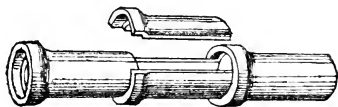

insertion of a chisel at the ends, the upper piece may be detached, and replaced. The pits are closed in with air-tight covers. A drain should be ventilated at every 300 feet. A cement-jointed vertical drainpipe built into a chamber of brick in cement is one of the simplest methods. The outlet should have a strong cast-iron grating (bedded on cement brickwork), as shown in Fig 21. The inside surface of the brickwork, at both ends of the pipe being rendered $\frac{3}{4}$ -inch thick with Portland cement.

Yard gullies may be made in the form shown in Fig. 22 Yard gullies. of brickwork, built and lined with cement, having a 2-inch York stone trap and cast-iron cover; or in stoneware up to

FIG. 21.

VENTILATOR.

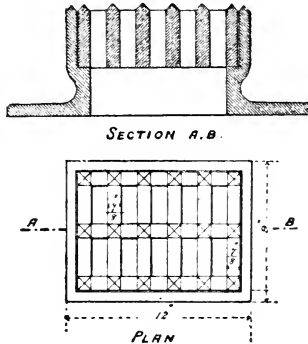

18 inches diameter. The former is best suited for a large yard, where there is a considerable flush of water and a very small percentage of soil conveyed by the pipes; but for small areas and general purposes, the stoneware gullies, Figs. 23 and 24,

FIG. 22.

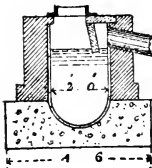

FIG. 23.

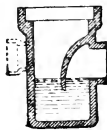
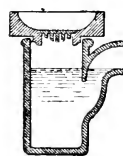

FIG. 24.



manufactured by Messrs. Doulton, will be found most effectual. They can be obtained with outlets of varying sizes.

The use of the syphon trap in some form or other, has Iron syphon traps.

become now almost universal. The old-fashioned bell which encouraged the lodgment of deposit, and was seldom properly flushed, has never been satisfactory; it was frequently rendered useless by the removal of the bell for the purpose of sweeping refuse into the drain, the trap often being thus laid aside and not afterwards replaced. Fig. 25 is a production in which the

FIG. 25.

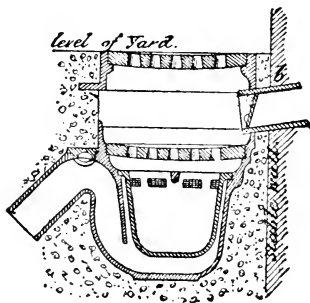

FIG. 26.



syphon forming the trap for the drainage of a stable is cast in one piece with the pot, and effectually prevents any tampering with its action as a water seal. It can be had with the outlet either at the bottom or the side. The trap Fig. 26 is even more simple in construction, and is easily cleaned; but more difficult to fix with the 4-inch earthenware pipes. In this

FIG. 26A.



trap also, the syphon arrangement forms a part of the pot and cannot be separated from it.

The syphon trap illustrated in Fig. 26A is another example of improved stable drainage when used in connection with the gutter shown in Fig. 19A. The latter passes through the stable wall at *b*, dispensing with horse and mare pots and all underground drainage in the stable.

Earthenware
traps.

Fig. 27 is an earthenware syphon trap, shown also in plan on Plate 8, where it is built into the wall of the stable. These traps are made with the outlet connection at the side or the

back, as shown by the dotted lines. The ordinary size measures 8 inches square on the outside at the top, but they can be also obtained in other sizes, and fitted either with iron gratings or perforated earthenware covers.

Plates 33, 34, and 35, illustrate the covered drainage of omnibus and tramway stables, containing a large number of omnibus and tramway stables.

FIG. 27.

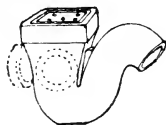
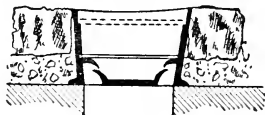

FIG. 28.



horses in each building. The stable illustrated on Plate 33 contains twenty horses, and has an area of 1350 feet super. It is trapped by two brick gullies (14 feet from each end wall) built in $4\frac{1}{2}$ -inch brickwork and also rendered inside with cement; they are 12 inches square, their depth being regulated by their position on the line of pipes. The pot is of strong cast iron, shown in Fig. 28. The loose boxes shown on Plate 37 are each drained in the centre by a similar gully, the paving having a uniform fall of 1 in 50 from all sides. These boxes are 10 feet by 10 feet, and have, therefore, an area to be drained of 100 feet.

The ultimate disposal of the sewage, after its passage through the pipes, depends upon whether it is taken to a cesspool, often the case with stables in the country, or to a system of public sewers.

In the designs numbered 1 and 4, on Plates 1 and 7, it will be seen that the drainage is taken to a central cesspool. It will be necessary to describe the construction of the first of these cesspools only, which acts in the double capacity of cesspool and dung-pit, and is marked K on the plan. This cesspool, designed to receive the drainage from the surrounding buildings, is 6 feet in diameter and 9 feet deep, and contains

9 cubic yards. It is built in brick in cement in two half-brick rings, well grouted, and resting on a bottom of Portland cement concrete, which projects 6 inches beyond the external radius of the wall, the latter having a backing of 9 inches of puddle, composed of well-tempered clay. The interior is rendered throughout in Portland cement $1\frac{1}{2}$ inch thick. The top is domed over with concrete, the upper surface sloping funnel-shape to a central iron grating 2 feet 6 inches in diameter, acting also as a manhole, through which the manure is drained into the cesspool.

Manure-pit
with cesspool.

The manure-pit is 9 feet in diameter, and the walls are carried up to a height of 2 feet 9 inches above the level of the yard. The whole can be covered with a roof if it is considered necessary to protect the manure from being diluted by the rain which would filter into the cesspool, the more solid refuse would be removed in the ordinary manner by a barrow.

Surface
drainage.

In large stables, a separate system of drainage is sometimes added to receive the surface water, such as the washing of the yard and the rainfall, and to convey it to an adjacent ditch, and if this is done the value of the manure is considerably increased.

Rain water.

As a large area is usually supplied by the roofing of stables, it is often worth while to collect the rain water into a submerged tank. This may be made entirely of concrete and lined with cement, which has been done by the Author in three or four cases. Earthenware pipes of 3-inch diameter with a fall of 1 inch in 10 feet, are usually large enough for the purpose, but where the length is considerable, 4-inch pipes are necessary. The tank must of course be of corresponding dimensions to the area of the roofs, taking the rainfall (in London) at 24 inches per annum; and the water can be raised by an ordinary hand-pump.

Advantage
of soft water.

It is unnecessary to comment upon the superiority of soft water over hard for medical purposes, and for cleaning harness,

but for the former purpose it should be filtered, as it is likely to collect impurities from the roofs; sometimes, by upward filtration through sand and gravel, the tank itself may be made to perform this duty.

The Author cannot pass from this section of his subject without dwelling for a moment upon the imperative necessity of the strictest supervision whilst the pipes for drainage are being laid, for errors may be then committed which cannot always be afterwards detected, and if capable of repair, are only so at considerable inconvenience and cost, when the drains are covered in and the yard and stables are paved, and a great many, or may be all, the pipes are under concrete.

CHAPTER V.

PAVING.

Requirements of paving—Adamantine clinkers and paviers—Tebbutt's "safety brick"—Vitrified bricks—Paving with stocks—Examples of paving—Herring-bone paving—Height of floor—Paving without concrete—Preparing ground—Laying—Composite paving—Granite cubes—Advantages of good paving—Difference in cost—Omnibus stables—Various stone pitching—Cobble stones—Wood paving—Wood flooring—Paving of smithy.

Requirements of paving. ALL paving should fulfil the following requirements, viz. it should be watertight, easily cleaned, durable, and not slippery. These conditions may be said to be most nearly approached by the use of the adamantine or Dutch clinker, when bedded on concrete. Very few of the latter, which has been in use for centuries in Holland, now find their way into England, mainly owing to our improved manufacture of an article equal, if not superior in quality, and much less in cost.

Adamantine clinkers and paviers.

The adamantine clinkers of the best quality, and in most general use for first-class stables, causeways, yards, and passages, are 6 inches long, $1\frac{3}{4}$ inch wide, and $2\frac{1}{2}$ inches deep. Laid flat it takes 70, on edge 120, and in herring-bone pattern 136, to pave a yard super, and 1000 of this dimension weigh 18 cwt. For stables they are also made with chamfered edges as shown

FIG. 29.

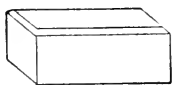

in Fig. 29. A plain orange adamantine clinker may be obtained, well suited for coach-houses, 6 inches by $1\frac{3}{4}$ inch by $2\frac{5}{8}$ inches deep; of these the same number per square

yard are required, viz. 120, and they weigh 20 cwt. per 1000. The clinkers above described have a sandy surface, and a very agreeable colour, varying between a pale yellow and a deep orange. A brown Welsh pavior is also manufactured, chamfered on all the edges for reversing, and measuring 8 inches by $2\frac{5}{8}$ inches by $2\frac{5}{8}$ inches; 60 of these will cover one yard surer, and 1000 weigh 37 cwt. These are made of the same size in 6 panels, with semicircular grooves, but in this form they weigh only 36 cwt. per 1000. Other varieties of these bricks are to be obtained, composed, it is said, of the identical clay from which the Roman pottery and bricks were made, most of them either chamfered or traversed by V or semicircular grooves as in Fig. 30. The latter, where laid in a diagonal direction with a central groove, or open surface gutter, are most easily kept clear. This is illustrated on Plate 6, and on Plate 13, in the stall *d*. The grooves may have a maximum slope of $\frac{1}{2}$ inch in their length, equal to 1 in 96. Fig. 31 exhibits a specially splayed brick to

FIG. 30.

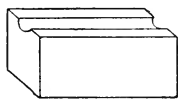
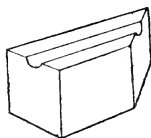

FIG. 31.



avoid the difficulty and waste of cutting for this description of laying.

Paviors, with semicircular grooves crossing them diagonally, are also made, to facilitate this method of paving, so that, although the brick may be laid transversely with the stall, as in A, Plate 13, the drainage will take a diagonal course towards the centre.

The grooves of a paving should not exceed 5 inches in distance, from centre to centre; but where the smaller

size grooved clinker is used, this is reduced to $1\frac{3}{4}$ inch; whilst in those with a diagonal groove (the width of the brick being 3 inches), the distance will be found to work to about $4\frac{1}{2}$ inches.

All descriptions of chamfered bricks must be truly moulded, carefully laid, and well grouted, or they are open to the objection of allowing the urine and washings to soak into the foundations, as they form channels at the joints. It is rightly considered that by the use of the semicircular grooves, the drainage is rendered more efficient, and the paving can be laid at a less inclination than it would otherwise require, say, $1\frac{1}{2}$ instead of 2 inches in the length of a stall. The V-shaped grooves and chamfered joints are frequently not only too deep and sharp, so that they secrete the refuse, and are not completely cleaned by sweeping; but the liquid does not pass in the most direct line to the gutter, and is reduced in velocity by the diminished gradient of a zigzag course, where the grooves run at right angles with each other.

Tebbutt's
"safety
brick."

One of the strongest recommendations put forth by Mr. Tebbutt, the inventor of an entirely new kind of stable brick, is its facility for surface drainage. This brick has eight regular

FIG. 32.

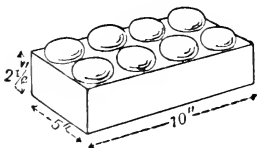

circular protuberances on its surface, as shown on Fig. 32, the knobs being $2\frac{1}{2}$ inches across, an inch high, and $\frac{3}{4}$ of an inch apart. They possess something of the appearance of the old cobble stones flattened down, and have, to a great extent, their advantage in giving a foothold,

without the imperfect drainage the old system created. The rounded surface of each protuberance is intended to guide the hoof downwards against the next knob, when foothold is required; especially when the hoof is placed at an angle to the floor in the act of rising. A very perfect system of drainage appears to the author to be obtained in the use of these

bricks; the straw resting upon the several raised surfaces, allows the urine to be drained from beneath it, and a less amount of material, it is claimed, is necessary, than is often put down upon a slippery pavement, to render the foothold less uncertain. The gutter brick, Fig. 33, is laid in conjunction with this paving; but the slope given to form the channel should be sufficient, with a flat surface between the excrescences, to form a good open surface gutter, without the deep and narrow groove, which it may be found difficult to keep clean and free, and was objected to so strongly in the old form of cast-iron gutters. This paving has only been lately used; but in the stables where the author has examined it, the opinion expressed by the grooms of the ease by which it can be kept clean is in its favour. It may be added that it has taken the Silver Medal at the International Inventions Exhibition, and the Gold and Silver Medals at the last two Architectural Exhibitions. Twenty-six will pave 1 yard.

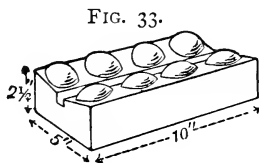

Blue Staffordshire paviors, also known as vitrified or metallic bricks, are made with one, two, and three transverse V-shaped grooves, and one longitudinal groove in the centre, thus a brick 9 inches by $4\frac{1}{2}$ inches is divided into 4, 6, and 8 panels; they are also made with a single transverse groove across the centre, as shown in Fig. 2, Plate 14, giving two panels to each, and of sizes varying from that of a clinker to 14 inches by 9 inches by 4 inches. The following table (p. 54) gives those in ordinary use, with the number required per superficial yard, and their weights per 1000.

Clinkers, 6 inches by $2\frac{1}{2}$ inches by $1\frac{3}{4}$ inch on the face, are also made in this material, chamfered and plain, and a useful size, 9 inches by $4\frac{1}{2}$ inches by 3 inches on the face, with semicircular grooves.

The bricks of this description, manufactured by Mr. J.

| Length. | Width. | Depth. | No. per yard. | Weight per 1000. | Length. | Width. | Depth. | No. per yard. | Weight per 1000. |
|---------|-----------------|-----------------|---------------|------------------|-----------------|-----------------|-----------------|---------------|------------------|
| Inches. | Inches. | Inches. | Super. | Cwt. | Inches. | Inches. | Inches. | Super. | Cwt. |
| 9 | 4 $\frac{1}{2}$ | 2 | 32 | 55 | 9 | 3 | 4 $\frac{1}{2}$ | 48 | 80 |
| 9 | 4 $\frac{1}{2}$ | 2 $\frac{1}{2}$ | 32 | 63 | 8 $\frac{1}{2}$ | 4 $\frac{1}{4}$ | 2 $\frac{1}{2}$ | 36 | 60 |
| 9 | 4 $\frac{1}{2}$ | 2 $\frac{3}{8}$ | 32 | 67 | 8 $\frac{1}{2}$ | 4 | 2 $\frac{1}{2}$ | 40 | 50 |
| 9 | 4 $\frac{1}{2}$ | 2 $\frac{3}{4}$ | 32 | 72 | 8 | 2 $\frac{5}{8}$ | 2 $\frac{3}{8}$ | 60 | 36 |
| 9 | 4 $\frac{1}{2}$ | 3 | 32 | 75 | 5 $\frac{1}{2}$ | 5 $\frac{1}{2}$ | 3 | 48 | 65 |
| 9 | 3 | 3 $\frac{1}{2}$ | 48 | 69 | 4 $\frac{1}{2}$ | 4 $\frac{1}{2}$ | 3 | 64 | 50 |

Hamblet, underwent a test by Mr. D. Kirkaldy, and were found to offer a resistance to crushing of from 8,582 to 10,185 lbs. per square inch; they are, therefore, extremely hard and durable; when broken they should be very dark in section, but for first-class stables their sombre colour is somewhat against them. An equally hard brick of a lighter colour would be extensively used.

Paving with
"stocks."

Ordinary stock bricks are frequently used for paving, but they are too soft for the purpose; they wear in uneven hollows, and absorb and retain moisture, rendering the stable damp and unhealthy. If used, they should be carefully selected, laid to break joint, and a grouting composed of two parts of washed sand and one of Portland cement, made to about the consistency of cream, should be well worked into the joints. 36 flat, and 52 on edge, will pave 1 yard super; 450 weigh one ton.

Examples of
paving.

Several methods of paving in brick, which may be either plain or grooved, are illustrated on Plate 13. The loose boxes, A, B, C, and D, are drained by a central syphon trap (Fig. 24), to which the pavement, on each side, converges; B having a wrought-iron covered gutter, with a prolonged branch to carry off the waste from the water-trough, which, in this instance, as also in those of the stalls, *a* and *d*, form part of the mangers. These two stalls are paved severally with transverse and diagonal courses; the former having a wrought-iron covered gutter, and the latter, the open surface channel of wrought iron described

in the previous chapter. C illustrates a stall paved laterally with grooved bricks, having a fall of $\frac{1}{2}$ inch to 3 feet 6 inches to an open surface gutter, formed of the gutter-brick shown in Fig. 3, Plate 14, or made in granite asphalte. The stall *b* could be fitted with a covered or open surface drain, stopped at the mitre, about 4 feet from the wall, where the fall from the manger brings the drainage to a central point; in addition to this the slope, as shown in Fig. 4, Plate 20, may be formed under the manger.

All these principles of paving have their several merits for stalls and loose boxes, but the best effect in brick paving for passages, yards, causeways, and coach-houses is produced by the herring-bone pattern, Fig. 34, especially where clinkers are used.

The floor of a stable, at the entrance, should be at least 2 inches above the general level of the yard, at a point in a line about 10 feet at right-angles with the outer face of the wall, to which point it should fall in a uniform slope forming the paved causeway running along the front of the stables, illustrated on Plates 1 and 39, and upon which the horses are usually groomed.

Bricks and granite cubes are sometimes laid in mortar on a bed of ashes or sand, where there is a good substratum of gravel, but it does not make permanent and substantial work. Portland cement concrete forms the best bed for a floor, whether it consists of brick, granite, wood, or cement, and should be 6 inches deep, especially for heavy horses, to withstand the constant pounding of an iron-shod hoof.

Before the concrete is spread, the surface of the ground must be prepared, being made perfectly solid and levelled to the requisite falls. The materials should be gauged dry in boxes, and mixed as described in Chapter III., the proportion being one of Lias lime, or Portland cement, to seven of ballast. When

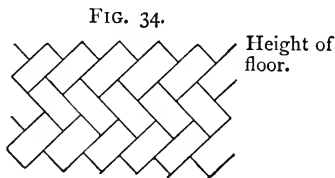

Herring-bone paving.

Paving without concrete.

Preparing ground.

the concrete is set, the surface should be floated over with a mixture of clean sharp sand and cement in equal proportions, and levelled, with a straight-edge, to the thickness of about $\frac{1}{4}$ of an inch, the bricks being thoroughly saturated with water and laid in this state, allowance being made for embedding them in the cement.

Laying.

The Author has before referred to the necessity of care in producing a uniform level, and regulating the joints, especially of grooved and chamfered paviers; and this can only be done by separately adjusting them with a small trowel to a line stretched along the proposed finished surface of the paving. When the bricks are set, a mixture of pure cement, of about the consistency of cream, should be spread over the pavement and swept backwards and forwards with a broom, well into the joints, being cleaned off at once with sawdust before it has time to harden on the floor.

Composite paving.

Stewart's metallic paving, and Wilkinson's, of Newcastle, are practically of the same value as a paving, their chief ingredient being Portland cement, laid on 6 inches of cement concrete, or on a layer of 6 or 9 inches of clean broken bricks. Roughed with semi-circular grooves they form a good flooring, and without the grooves, are particularly suitable for corn stores and coach-houses. When used for a stable, as shown on Plate 6 and Plate 14 (Fig. 4), the grooves can be deepened to their outfall after the floor is laid and set; this can also be done when clinkers are used, and although it adds to the cost, the surface of the floor in this case can be made almost level, its fall being divided with the grooves. Paving of this description should be laid in two thicknesses, or it cracks and peels off, and if laid on broken bricks must have an average thickness of $3\frac{1}{2}$ inches, to resist the effect of the constant stamping of the horses. If properly laid it is very durable, hardens with age, and wears with a sandy surface.

Granite cubes. Jersey or Welsh granite cubes, as used in random paving for yards, are equal to a paving of bricks, unless they are adaman-

tine clinkers, where both are laid on 6 inches of concrete. The vitrified bricks share with the granite the disadvantage of becoming slippery with wear, without the advantage possessed by the granite, which is capable of being re-roughened.

For stalls, loose boxes, coach-houses, &c., a flooring of brick or metallic paving is more easily washed and has a better appearance; but no description of paving can supply the necessity for the frequent and active use of the besom, and no stable can be thoroughly clean and healthy if the bedding is not entirely taken out once a day, the stable completely swept, and the drains well flushed.

The difference in cost is in favour of granite, and where the traffic is heavy, it is certainly a more suitable material, if it is laid to proper currents and grouted with cement.

The Author has frequently used granite for the passages of stables, in conjunction with brick, metallic paving, and wood in the stalls, the surface gutter being laid in purpose-made bricks, or formed in the metallic material.

The whole of the stables, loose boxes, and yards of the London General Omnibus Company, are paved with these granite cubes, with the exception of the portions marked *a* on Plates 32 and 33, consisting of a strip 18 inches in width, for receiving the debris from the mangers, and the areas *b, b*, occupied by the corn chests. These are paved with hard paviers, laid on concrete like the cubes, and grouted in cement. One super yard of these cubes is equal to 3 cubic feet, and one ton will lay $6\frac{1}{3}$ yards of paving.

The following is a list of the stone pitching most generally in use, and found to answer best for paving, with the number of yards super the several descriptions will cover per ton.

| | | | | | | |
|-----------------------------|-----------|----------------|-------|-------|-----|------|
| Rowley rags | will pave | $4\frac{1}{2}$ | yards | super | per | ton. |
| Macclesfield stone pitching | | $5\frac{1}{4}$ | .. | .. | .. | .. |
| Leicester | | $4\frac{1}{2}$ | .. | .. | .. | .. |
| Neury | | $4\frac{1}{2}$ | .. | .. | .. | .. |
| Mount Sorrel (4" x 4") .. | | 6 | .. | .. | .. | .. |

Cobble stones. When carefully selected, and laid by an expert, the boulders not being too small, the old cobble stones form a durable paving, and give a good foothold to the horse. But they are unsanitary for stables, and require, owing to their irregular character, a great deal of flushing in yards and passages.

The Shirly and Portswood stables, designed by the Author for the engineer to the Southampton Tramways, are paved with wood blocks; but the passages, for the width of 7 feet 6 inches, have a granite paving with a sunk surface channel on each side, which conveys the drainage through two holes in the front wall to an outside syphon-trap. A width of 10 feet is also laid in granite along the front of the stables.

Wood paving. Wood has been frequently used as a paving, especially where sawdust is adopted in the place of straw—a material much in use a short time since in many of the large London stables—even where they were paved with stone. Its advocates contend that it is warmer, especially when laid on wood, that it is more healthy for the horse, and affords the body more uniform repose; it is no doubt cheaper, and can be procured where straw is difficult to obtain. The absorbent nature of wood, however well covered with sawdust or straw, the unequal character of the cubes, and the likelihood of a flooring so laid being improperly swept and drained, and becoming impure, and its want of durability, have always appeared to the Author insurmountable objections to its use, except in case of smithies. The blocks used are generally of spruce, either 9 inches by 4 inches by 4 inches, or 9 inches by 4 inches by 6 inches.

Wood flooring. Some years ago a paving was introduced, consisting of perforated planks, raised a few inches above an impervious floor which was drained from beneath.

Another description of wooden floor was perfectly level, and consisted of fir strips (creosoted) $3\frac{1}{2}$ inches by 2 inches, laid diagonally in two laps turning on centres, and meeting in a mitre, so as to give access to the receptacle beneath, a space of half-an-inch being left between the boards for the drainage. The

wooden surface thus formed was studded with nails having heads of about $1\frac{1}{4}$ inch in diameter, and closely hatched to form a foothold.

Creosoted wood blocks, 9 inches long, 3 inches wide, and 6 inches deep, may be recommended, however, as the paving of that portion of a smithy on which the hearth is built, the remainder, where the horses stand to be shod, being laid with 4-inch granite cubes, an open surface gutter dividing the two portions from each other, as in Plate 50, where a dotted line is shown indicating the boundary of the wood paving. The blocks should be laid in parallel courses, breaking joint, and spaced about half an inch apart, carefully cut and fitted, and finally grouted with a mixture of boiled pitch and tar.

CHAPTER VI.

VENTILATION.

General considerations—Temperature—Cubic contents of stables—Requirements of various horses—Admission of air—Fanlights and louvres—Construction of louvres—Lantern ventilation—Stables at Poplar—Ventilating tiles—Down-cast ventilation—Through ventilation—Ceilings and Lofts—Perforated pipes—Head-post ventilators—Boyle's ventilators—Ventilation of upper floors—Glazed ventilators—The Sheringham ventilator—Loose boxes—Cubic contents—Examples.

General con-
sideration.

THE natural tendency of heated vitiated air to rise to the highest point in a chamber affords the greatest facility for ventilating a stable, if means are provided in the roof, or at the ceiling level, for its immediate escape: when this is not afforded, it cools and descends, and, mixing with the atmosphere, is breathed over again by the horses; and as in this state it is largely impregnated with carbonic acid gas (which when heated is lighter than pure air), it is hardly necessary to point out its evil effect upon the health and working capacity of the horse.

Before so much attention was paid to the subject of ventilation it was no uncommon thing for those who had the charge of horses to shut off, as much as possible, the admission of fresh air by stuffing the openings in their stables with straw and even nailing sacking over the windows; and a great deal of superstition still exists, which results in the sacrifice of free ventilation and light for the sake of warmth, in the endeavour to exclude what are supposed to be injurious draughts.

There is a great advantage, where the position of the building allows it, in having the windows at a sufficient height and

opposite each other, so that a through ventilation may be sustained, and the sashes closed or opened, as the direction of the wind may dictate, or the temperature of the stable necessitate. A stable having this advantage should have the double aspect of north-west and south-east, or nearer to the north and south than to the east and west; the entrance being towards the south, and the heads of the horses to the N.N.W., as the light admitted from a northern direction is more uniform in character than any other, and better for the sight.

The temperature of a stable should vary with the kind of work in which a horse is engaged; the maximum should not be over 65° at any time, nor should it be allowed to fall below 45° . For most horses an average between 50° and 60° is the best and most easily maintained. As a rule, the greatest difficulty will be found in keeping it sufficiently cool. To a great extent the automatic action of the ventilators hereafter described can be depended on; for the rest, the aspect of the stable in relation to the prevailing wind and the infallibility of natural laws must be considered in the use of what may be called the provisional appliances.

In a well-ventilated stable an even temperature may be maintained by a daily observation of the prevailing wind, attention to the increased or lessened pressure of the atmosphere as the horses are admitted or discharged from the building, and by opening or closing the windows as the case may require. It need scarcely be added that a barometer will greatly facilitate the necessary observations.

The conditions in a stable vary much more than in a house, though the same argument holds good with regard to the former, viz. that it is not sufficient to consider the cubic contents if the necessity of the constant, and at intervals, the complete change of air, is lost sight of. It is impossible, as the best authorities admit, to establish any comparison as to the cubic contents required for a horse, with that which is necessary for a human being; the latter is more susceptible to change of temperature,

Temperature.

Cubic contents
of stables.

and, living upon animal food, gives off more noxious gases ; he requires therefore a larger cubical space, but cannot endure so low a temperature. General Fitzwygram considers, from his "experience gained in barrack stables and elsewhere, that with the concomitants of good ventilation, good drainage and paving, light, and cleanliness, 1200 cubic feet, with a ground area of 87 feet super per horse are sufficient, though probably the minimum required for maintenance of health."

Requirements
of various
horses.

For omnibus and tramway horses, and those employed by carriers, tradesmen, &c., about 1000 cubic feet may be considered a sufficient allowance of air, but the larger description of horses belonging to contractors and brewers have a proportionate increase, owing to the larger size of the stalls they occupy, which should not be less than 7 feet wide. Hunters and racers obtain the greatest amount, also due to the very large surface area it has been, perhaps falsely, considered they require for rest, which in some cases amounts to over 280 feet super (exclusive of passages), and gives a cubic contents of from 3000 to 3400 feet. For a great part of the year a stall of this description would require to be warmed. Carriage horses, again, which are generally more closely confined than the ordinary working horse, should not have less than 1100 to 1200 cubic feet.

Admission of
air.

The steady supply of a sufficient quantity of fresh air to replace the impure, without that spasmodic action in the form of draughts which is the result of bad ventilation, is accomplished in stables in many ways. A recuperative process is always going on by the natural pressure of the atmosphere under doors, and through the smallest crevices ; but this is not sufficient, and in lofty stables especially (stables should not have a greater height than 12 or 13 feet without an outlet in the roof) the air rapidly stagnates. The admission of this additional amount of fresh air, to take the place of that which is encouraged to escape from the roof, should be based upon the simple expedient of exhaust and supply, but automatic arrangements for this purpose are not to be entirely depended

upon for the thorough ventilation of stables. Where the temperature is suddenly raised and vitiated by the introduction of horses warm from their work, something more is required, which will, especially in hot weather, afford an additional impetus to the immediate escape of the foul air whilst it is *heated and buoyant*, and for this purpose fanlights and louvres in the roof are the most effective provisions.*

A fanlight over the door, except in the case of a smithy or washer's room, is preferable to fixed louvres, as the fresh air is admitted too much in the character of a draught, especially in the cold winter nights, when the louvres in the roof will be found sufficient, and the window over the door can be closed.

The blades, moreover, of louvres are often fixed at an improper angle, and allow a current of cold air to pass in without impinging, as it should do, on the slats. A draught will often strike a wall and rebound, and thus reach a part of the stable it could not otherwise affect. This may exist to a serious extent in a gale, and often leads to louvres being rendered non-effective by a stuffing of straw. The slats to fixed louvres should not be at a less acute angle than 55° . They should be 6 inches wide, and the frames have at least five slats in every 2 feet of height; by this arrangement they overlap each other sufficiently to give an upward direction to the air, as shown on Fig. 35, and they may be made, by a simple arrangement, to open and close like a venetian shutter.

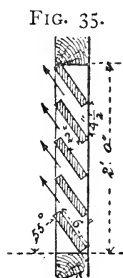

The stable illustrated on Plates 40 and 41 is, with the exception of a fanlight over the door, entirely lighted from the roof by eight fanlights, which form a continuous lantern. These

* Supposing the air to be changed three times in every hour, a stable containing 1200 cubic feet per horse, would give to each animal 3600 cubic feet of air per hour; being at about one fourth the velocity at which it could be removed in that time, without creating a draught, at a temperature of 60° Fahr.

are hung on central pivots, and opened or closed by lines and pulleys. By this arrangement the temperature can be lowered to any extent, and the lights are placed beyond the convenient reach of any device for darkening the stable; in addition to which, there are two glazed ventilators of the description used in churches, in the end wall of each stable, as shown on Plate 56.

Stables at
Poplar.

The plates from 32 to 38 inclusive, illustrating the stabling of the London General Omnibus Company at Poplar, show a system which offers great facilities for ventilation in the roof. These stables are 54 feet long by 25 feet wide by an average height of 14 feet 6 inches, which gives 19,575 cubic feet. The gables and the four kerbs "*a*" contain severally 460 cubic feet and 32 cubic feet, making a total of 20067 cubic feet, which, divided by 20, the number of horses in the stable, gives 1003 cubic feet per horse. The loose boxes are 10 feet by 10 feet by an average height of 12 feet 3 inches, making 1225 cubic feet; and, allowing 20 cubic feet for the louvred ventilators (Plate 37), gives 1245 cubic feet per horse. In dealing with loose boxes where, as in this case, they are treated as separate buildings from the stables, on account of possible contagion, the Author has found 12 feet by 12 feet a more convenient size, as affording greater facility for shifting a horse in the event of operation, &c. The kerb *a*, which opens in the form of a trap in the roof of these stables, should only be used on exceptional occasions (as it produces a too rapid change), and be kept entirely closed during the winter. This description of ventilation is open to the same objection which attaches to ordinary sashes and frames, viz. that of admitting a direct current of cold air to play upon the horses when opened, as they are on their admission, warm from their work.

Ventilating
tiles.

An additional and not so violent a method is afforded by the use of corrugated tiles, as shown in Fig. 36. The tiles being laid dry, a space is left under them through which a large portion of impure air escapes as it rises to the roof. They are especially

serviceable laid in this way for the roofs of smithies, as the smoke also quickly passes through the interstices; and in washers' rooms and where a copper is used, the steam passes rapidly away.

FIG. 36.

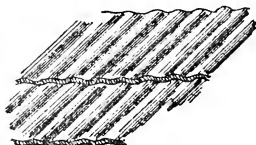

FIG. 37.



In crowded localities, where structural arrangements render it impossible to obtain a supply of air direct through an external wall, it is necessary to use a down-cast ventilator, by means of which the fresh air is driven down a vertical shaft into the stable; an arrangement of this kind, by Messrs. Boyle, is illustrated by Fig. 37. It is constructed on the principle of a wind-sail, and the shaft can be recessed in the wall as a down-pipe, or the ventilator affixed at the eaves, or, in a more ornamental form, on the ridge of the roof; or the extraction and supply shafts could be carried up in one stack together with the flue of the harness-room boiler, from which pipes for warming the stable and coach-house are fed, and the whole of the mechanical and automatic arrangements have one centre of operation.

It is a good plan, when there is an absence of through ventilation, to create a subsidiary circulation, by leaving a space of about 4 inches between each partition and the wall; this would be kept up, without reaching the horse in the form of a draught. Cavalry stables, built as a rule to accommodate 14 or 16 horses, with a couple of spare stalls in each stable, have usually a space under the manger passing through the partitions, and running from end to end of the stable, as shown in Fig. 7, Plate 19, with a space also for ventilation below the partition. The latter provision is considered by many as a

doubtful advantage, tending to produce diseases of the hock, by creating a draught along the surface of the floor.

Ceilings and
lofts.

Few first-class stables are now constructed without being wholly, or partially ceiled; and it not only improves the interior in appearance, but contributes largely in keeping the stable at a regular temperature, making it warmer in the winter and cooler in the summer; in fact, in racing stables, where additional warmth has been required, a false floor has been sometimes made and strewn with stubble or straw.

The space thus created in the roof cannot be considered a good receptacle for the storage of food, if the flooring, being of wood, is not closely jointed and of unshrinking material. If true facilities are created in such a loft for the free passage of air over the fodder by means of a louvre in the gable at each end, and it would thus be kept in a dry and wholesome condition; but unless the floor is of concrete, or the ventilation of the stable below complete, the noxious gases would be likely to find their way through an ordinary floor into the upper chamber, as they did in the old system of construction, where there was an open connection with the loft from the stable below.

The design on Plates 40 and 41 can be partially ceiled, leaving the lantern in the roof open to the stable for its entire length, and although this would reduce the cubic contents nominally from 1150 to 960 per horse, it would leave the through ventilation by means of the louvres in the gables intact, but in this case it would be improved by the addition of another 12 inches to the height.

General Fitzwygram's design, as shown on Plate 56, may also be either ceiled at the underside of the tie-beam at *c*, leaving, as he suggests, a longitudinal opening about 3 feet wide, and nearly the whole length of the stable; or it could be left open to the roof; but in the former case the cubic contents would be largely reduced, though the space between the ceiling and the roof would be left for circulation; or a ceiling could be attached to the underside of the principal rafters, without

materially affecting the air in the roof. The iron gratings at α , which extend for nearly the whole length of the stable, allow the vitiated air to escape, whilst the fresh air enters at the air bricks below the manger in every stall.

The air is sometimes admitted at this place through a perforated iron pipe, with inlets in the external wall running the whole length of the stable at a height of about 1 foot 9 inches from the ground.

At the Corporation stables of the police at Aberdeen, the fresh air is admitted to the stables through the head-posts of the traverses, communicating with a longitudinal duct of this description; the foul air being carried off through openings in the ceiling, connected with Buchanan's current ventilator on the ridge of the roof.

Inventors have departed so widely from the simple laws of nature before referred to, and first applied successfully to buildings by the Haydens, of Trowbridge, that the success achieved by Messrs. Boyle in the application of their air-pump exhaust and down-cast ventilators is not surprising. By means of an ingenious bell-mouthed arrangement, a large body of external air is collected and forced into active operation. It exhausts a central chamber which terminates the outlet pipe; and to supply the vacuum formed by this means, the foul air from the stable rushes up the shaft, and passes from the building. Fig. 38 shows the form of this ventilator, which can be attached to the end of a pipe, or affixed to the ridge, as illustrated on Plate 9.

It will be seen that this system is especially adapted for the ventilation of those buildings, already described as consisting of more than one floor, as horizontal flues, having openings in the ceilings, can be carried between the floors, passed up the walls, and concentrated in these extraction ventilators on the ridge; by means of a divisional plate, the currents from the branches are prevented from striking each other, and possibly

FIG. 38.



Ventilation of upper floors.

creating an adverse current ; or a central extraction shaft may be used, connected with openings in the walls, to flues between the floors, or immediately under the ceiling, and terminating above the roof, with an induced up-current cowl.

Glazed ventilators.

Defective vision, weakness of the sight, and (notwithstanding the ignorant belief that horses put on flesh in darkened stables) injury to health, and neglected sanitation, are the usual consequences of the absence of light. By the use, therefore, of glazed ventilators, as shown on Fig. 39, and on Plates 3, 8, and 9, the double purpose of lighting and ventilating the stable may be accomplished.

The Sheringham ventilator.

Where stables are lighted from the roof, by swing sashes or other means, Sheringham's ventilators, illustrated by Fig. 40,

FIG. 39.

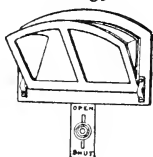
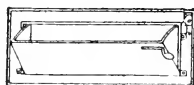

FIG. 40.



are most frequently used. They are made of galvanised iron, and fitted with brass pulley, line, and balance weight, and an external grating for the admission of air, $13\frac{1}{2}$ inches by 6 inches ; but the principle of their construction can be applied to any opening.

Loose boxes.

Loose boxes should be ceiled on the underside of the rafters, if used for infirmaries, and are improved by a separate louvre ventilator to each roof, as shown on Plate 3.

Cubic contents.

From 1500 to 2000 cubic feet of air per horse are required for loose boxes of this kind, as the fresh air is not so freely or so frequently admitted as in a stall.

Examples.

In the series of designs of "private stables," the various methods of ventilation which the Author has ventured to advocate in this chapter, are illustrated, many of them having been carried into most successful operation.

CHAPTER VII.

FITTINGS AND DETAILS.

Separation in stables—Cast and wrought iron details—Stall divisions—Ramp panels—Portable partitions—Safety bars—Heel-posts and pillars—Ramps and posts—Fixing posts—Loose box partitions—Loose box doors—Door frames—Swing doors—Latches and locks—Locking bolt—Bales—Safety hooks—The Malet bale suspender—Safety catch—Cleating—Double cleating—Kicking-boards—Mangers—Manger posts—Wrought-iron mangers—Water fittings—Crib-biting—Safety mangers—Hayracks—Loose box sliding bars—Halter tying—Smithy fittings—Hearths, bellows, &c.—Vice bench—Harness-room—Heating apparatus—Boilers—Open boilers—Girth stretchers—Saddle airers—Saddle-horses—Clothes press—Harness—Harness brackets—Coach-houses, warming, &c.—Coach-house doors—Hinges and fastenings—Gate stops—Corn-stores—Machines for food—Food supply—Corn-bins—Preparing food, motive power—Horse-power—Gas engine—Hoisting and gear—Jacob's ladder—Hayloft doors—Hanging and sliding doors—Water supply—Washing apparatus—Valves—Gas supply—Oil lamps.

HORSES are separated in the stables either by boarded partitions, otherwise known as traversers, by poles, chiefly used in cavalry stables, or by bales. In first-class stables the partition usually consists of an ornamental heel-pòst, an iron grating, or ventilating ramp, as it is called, with a top and intermediate rail; and a sill which receives the bottom ends of the boards, the top ends of which fit into a groove in the underside of the intermediate rail, as shown on Plate 18, Fig. 2

Great varieties of these details are now manufactured in wrought as well as in cast iron, and are consequently lighter and yet stronger than cast-iron fittings. The objection that the

Separation in stables.

Cast and wrought iron details.

former is more easily affected by oxidation is not sufficient to outweigh the advantages gained where strength is required, as, for instance, in the heel-post; and the ironwork in a private gentleman's stables, where the best designs are used, and where they are not likely to suffer from neglect in the matter of cleaning and painting. On the other hand, there is less opportunity for ornamental detail in wrought iron than in cast, and it is impracticable to execute much of the work, such as name-plates and numbers, the bosses of head-stall fastenings, and the heads of posts in wrought iron. All iron, when used in stables, is largely affected by the salts of ammonia, and breaks out in a sort of tubercular eruption, the injury to the fittings by oxidation being only a question of time or neglect. This is considerably modified if the iron is galvanised—an expensive process, which renders wood, where it can be used, as in roofs, a more desirable material.

Stall divisions.

Examples of a simple description of stall-divisions will be found severally on Plates 16 (Figs. 1 and 2), and Plate 18 (Fig. 1), consisting of the ordinary boarding only, with a top and bottom rail. In the latter illustration the deficiency of a ventilating ramp is partially supplied by spaces beneath the sill; but this is not so good as the through ventilation afforded at a higher level in the partition, shown in Fig. 2 on the same Plate.

Ramp panels.

The maximum height of the middle rail in a stall being only 4 feet 6 inches (though it is often a foot lower) brings the horse into more immediate companionship with its neighbour by the use of an open ramp. This is not, however, always desired, and panels or solid ends, shown on Plate 18 (Fig. 4), are often fitted into the head of the partition. It is supposed that the horses are irritated by seeing each other whilst feeding, and if the particular combination of hayrack and manger illustrated on Plate 22 (Figs. 3 and 4), now considered to be the best for feeding, are used, it becomes a necessity, as a horse, having eaten his own allowance, may endeavour to obtain through the

open bars the food of his neighbour in the adjoining stall, and thus upset the amicable relation which should exist between companions and neighbours. Messrs. Barton & Ballard, in this case, fill in the ordinary ramp bars, for a distance of about 3 feet 6 inches, with wood, to which sheet iron is screwed, and this can be easily removed.

Portable partitions, such as those on Plate 19 (Figs. 6 and 7), are made with clutch boxes, to ensure their easy removal. Portable partitions. Fig. 7 illustrates the stable fittings of the officers' quarters at the barracks on the western heights at Dover, as fitted up by Messrs. Barton and Ballard. It will be seen in this case that a clutch is rendered necessary at both ends of the ramp rail, as the iron column which does duty for the heel-post is carried up to support the roof; but on Fig. 6, where the post is only of the ordinary height (about 6 feet), the ball *l* is made to unscrew, and the end of the rail being dropped into a slot in the post, is kept in position when the ball or finial is replaced. The ramp or top rail, as the case may be, can be thus removed for the purpose of renewing any broken boards, without injuring the wall or disturbing the heel-post. The sills of stall divisions are also made with a movable piece near the heel-post, to facilitate repairs. An enlarged diagram of the socket of the portable post at *K*, and the clutch box and socket at *f* and *g* will be found on Plate 15 (Figs. 6 and 7).

The safety bar is a contrivance of a temporary nature for shutting off the adjoining stalls and preventing any occupant which may get loose inflicting injury on the other horses. Safety bars. On Plate 18 (Fig. 3) a safety bar *a* is shown partially drawn from its sheath in the partition. When required, it is pulled out and dropped into a socket fixed into the wall. Fig. 4 shows a similar arrangement having two bars. Thus, for instance, any of the stalls in the plan on Plate 7 might be converted into temporary loose boxes by this means, as indicated by the dotted lines.

It is suggested by the makers that when these bars are

partially drawn out they may be used as temporary brackets for harness.

Heel-posts
and pillars.

The pillars of loose boxes and the heel-posts of stall divisions, which vary from $3\frac{1}{2}$ to 6 inches in diameter, according to the description of horse for which they are used, are manufactured also in cast and wrought iron. Of the latter, the St. Pancras Iron Company claim to be the original makers. The posts are made of solid welded plate iron, having bases cast round them forming a plinth to the height of 6 inches above the level of the paving, and adding, by this extra thickness, materially to its strength at that part which is the weakest, and also, from its position, the most liable to be fractured.

Ramps and
posts.

The ornamental heads of these posts are most frequently of cast iron, those of superior manufacture being of brass, whilst the rings for pillar reins, or chains, which are fixed in front of the post, or on either side, are also of brass or wrought iron, and will be found illustrated on Plate 15 (Fig. 5).

A design providing a temporary post hook for hanging harness has been patented which goes back into a flush recess in the post when not in use; but it appears to the Author an unnecessary element of danger in the event of the hook being carelessly left projecting into the passage, which is likely to happen except in the case of loose boxes where they can be placed much higher than in stalls. That the plainer these posts are made the better, seems admitted by the manufacturers, as partitions are made dispensing even with the finials to the posts, the ramp rail finishing with a flat cap or rounded end in place of a ball, as shown on Plate 15 (Figs. 3 and 4), so that the leg may slide off if thrown over the partition by violent kicking. These divisions are, however, unsightly in appearance, and in the plain round ball, at the height of 6 feet from the ground, there does not appear any great element of danger. It is very different in the case of a projecting iron hook, or the safety bar before alluded to, when partially drawn out for the same purpose, and only a little over 4 feet from the ground.

A design of the Author's for bedding posts in concrete will be found on Plate 15 (Fig. 1), open spaces being left in the casting for the purpose of working the concrete into the cavity in the base, and thus forming a key which holds it firmly in position, as the concrete hardens into a solid mass. The system of setting the posts in concrete is not so general as that in which they are secured to a stone, but is to be strongly recommended, as all the ironwork should be fixed before the paving is laid, and it is an easy matter to adjust these posts when there is nothing but the concrete to deal with. Portland or hard York stone is most frequently used for the purpose. The stone is partially bedded in or beneath the concrete (Plate 15, Fig. 2), the posts being secured by a flange fastened by Lewis bolts to the stone, and leaded. Although this method secures to posts a perfectly immovable position, so long as the stone remains sound and in its place, it has the disadvantages which often attend the letting of iron into stone, viz. causing it to split from corrosion of the iron, or through frost. Of course, if it is under concrete it is safer, and with the addition of the pavement above, it is not likely to be reached, *in a stable*, by the frost.

Loose box partitions are made like those of stalls when the boxes are grouped in the same building with them, and differ only in the top rail, which is horizontal instead of being ramped, as shown on Plate 16 (Fig. 3). Tastes vary as to the depth of the grating forming the upper portion of a loose box enclosure, but it should be made lower in the door and front than in the divisional partitions, to give the attendant an uninterrupted view of the interior; in the former it varies between 2 and 4 feet. Where it adjoins a stall, by the introduction of an inverted ramp, as shown on Plate 17 (Fig. 3), the middle rail of the loose box is made to correspond in height and curve to the top rail of the stall division, and in this case the ironwork is about 2 feet 8 inches in its greatest depth at the heel-post, and about 6 inches at the head of the stall; the woodwork below having a minimum of 4 feet 8 inches.

Loose box doors.

The doors of loose boxes are made to roll back upon small wheels, as shown in Fig. 41, or they are hung to open outwards, or to swing both ways, but should never be constructed to open inwards, as a horse often takes up his position immediately inside the door, and would effectually prevent its being opened. The door should not be less than 3 feet 8 inches in width, the posts being fixed at 3 feet $8\frac{1}{2}$ inches, thus giving a quarter of an inch play on either side. A considerable amount of stiffness is added to the doorway by a wrought-iron bar connecting the posts at the top, and forming an arch, as illustrated on Plate 17 (Fig. 1).

FIG. 41.

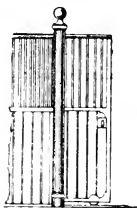

Door frames.

The framework of the door may be made of iron, or have a partial mounting only of that material, as shown on Plate 17 (Figs. 4 and 5).

Swing doors.

An example of a swing door manufactured by Messrs. Denning & Cook will be found on Plate 17 (Figs. 1 and 2), which has also the advantage of being taken down without the removal of any bolts or screws, simply by being lifted off the pivots.

The position of the doors depends upon the plan of the stable. On Plate 1 the doors are all placed in front, and they can be hinged or made to slide. On Plate 16 (Fig. 3) will be found the elevation of a loose box with the door in this position, whilst on Plate 17 (Fig. 3) a loose box is shown, supposed to occupy a corner of a stable (as on Plates 10 and 11), the position of the door being at an angle of 45° with the partitions.

Latches and locks.

Considerable attention has been given to the latches, locks, and handles of loose box doors, with the view of avoiding injury to the horses in passing in and out, and also to prevent their opening the door from the inside, as they have been often known to do with the tongue. A section and front view of a mortise safety latch which falls into a recess when the door is open, is

shown by Fig. 42; *b* shows the position of the tongue when the door is shut, which will be seen also by the dotted lines on the section, and *a* when the door is open. A mortise lock and handle is also represented by Fig. 43, the latter being flush

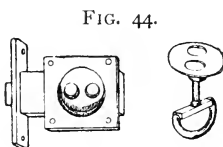
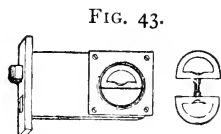
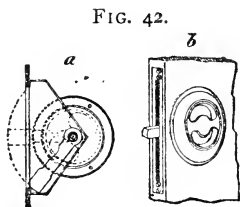

with the lock on both sides of the door. Another design for a loose box mortise latch with flush handle is shown by Fig. 44. This is manufactured for $1\frac{3}{4}$ and 2-inch doors.

A design which has been very generally used by the Author Locking bolt. for the external doors of stables and loose boxes is shown on Plate 46. Answering only as a bolt during the day, it may be secured by night by means of a padlock, and if small bolts are used where indicated by the square heads, is a secure, as well as a ready and easy method of fastening; but it frequently happens that these bolts are only screwed on from the outside, and, of course, can be easily removed.

Brewers', carriers', omnibus and tramway companies' horses, Bales. &c., are usually divided in their stables by bales. These are suspended at one end either from bale-poles extending the whole length of the stables, and secured by cleats to the upper surface of tie-beams, as upon Plates 34 and 35, from longitudinal girders, as shown on Plates 40 and 41, or from a hook in the ceiling. Each bale is attached at the other end by a wrought-iron link to the manger, and protected by sheet iron

for the length of about 3 feet. They are made of elm or oak, and should not be less than 2 inches thick. Their position and dimensions are illustrated by Fig. 45, the upper bale being regulated to the height of 1 foot 1½ inches from the level of the paving.

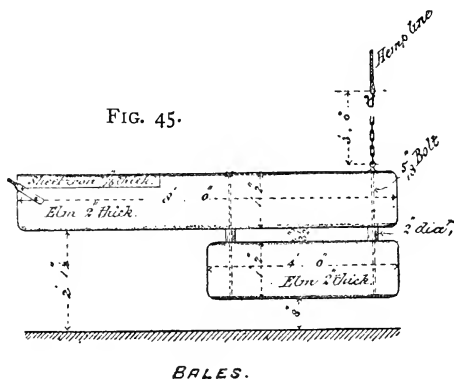

Safety hooks. Although the use of bales brings the horses in nearer relation to each other—and with this view they are frequently alternated with partitions, so that the two horses running together at day are only divided at night by a bale—their use can only be excused on the ground of want of space, or economy. On the other hand, being constantly knocked about, they are soon worn out and destroyed; they are also (unless provided with proper safety hooks) dangerous to the horses; as they are in the habit of getting their legs over them when kicking, and in the absence of a provision of this kind it is better to use a rope which can be severed in emergency) than a chain. Fig. 46 is a diagram of a hook used for this purpose. By striking the ring *a* in an upward direction, the hook which is hinged at *b* is disengaged, and the bales fall of their own weight to the ground, and release the horse, but considerable injury may be incurred before the

arrival of assistance. The Malet bale-suspender fulfils the intention of its inventor in this respect, by immediately releasing the horse without assistance when he is cast. It consists of a self-acting steel spring, *a a*, Fig. 47, with an opening at

The Malet
bale-sus-
pender.

FIG. 46.

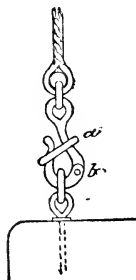
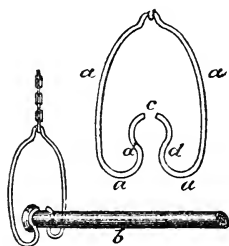

FIG. 47.



c through which the bale *b* is dropped into position, and pressure exerted at *d* releases the bale. The bronze medal of the Inventions Exhibition was awarded Colonel Malet for this invention, which is especially adapted for cavalry, by whom the bale is much used; and by means of a pole it can be applied also to the swing bale illustrated by Fig. 45.

Another design, in some respects of a still better pattern, because it is more compact and offers less opportunity of injury to the horse, is manufactured by Messrs. Cottam and Willmore, of Winsley Street, and is shown on Fig. 47A. In the event of an accident, the ring being pushed up from its position to that shown at *A*, the catch *C* releases the bolt *B* from its casing, and allows the bale and wooden roller to fall; by lifting the bale the bolt may be replaced in its former position, and the ring, now at *A'*, forced down over the catch. Safety catch.

The boarding of loose boxes and stalls, or the cleating, as it is technically called, should be made of the best well-seasoned red deals, oak, teak, or pitch pine; and, although the boards Cleating.

are nearly always placed in a vertical position, they are sometimes preferred horizontal, as on Plate 56. In this case eight deals form a very good height for a stall division, but a strong

FIG. 47A.

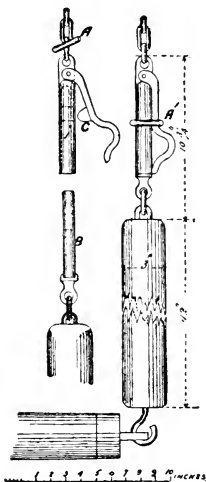

Double
cleating.

FALE.

Kicking-
boards.

cast-iron grooved frame, or wrought channel iron, must be firmly secured in the wall to receive the ends of the boards. This method does not recommend itself as superior to the ordinary fixing, although it has been suggested that it is tougher in resisting the heels of the horses, and less likely to open at the joints. This latter should not happen if the wood is sufficiently seasoned, is of the necessary thickness, and is properly grooved and tongued.

For the stalls of especially powerful horses the partitions should be made in two thicknesses of $1\frac{1}{4}$ -inch deal, one placed vertically and the other horizontally, both being ploughed and tongued and let into the post in the ordinary way. An example of an extra strong stall division with cast-iron column 4 inches in diameter, fitted with harness-bracket and hooks, will be found on Plate 18 (Fig. 1). The boarding, $2\frac{1}{2}$ inches in thickness, is let into a stout cast-iron ramp rail and wrought-iron sill. The extreme height is 7 feet, which is sufficient for all horses under 16 hands.

Where the walls of stalls are unprotected, either by cement or boarding, and the brickwork is consequently exposed to the heels of the horse occupying either of the end stalls, it is necessary to provide what are known as kicking-planks, consisting of series of elm or oak boards about 4 feet in height, 12 inches wide, and $1\frac{1}{2}$ inch thick. These should be firmly spiked to

bond timbers (4 inches by 3 inches, and 5 feet 6 inches long) built into the wall, and bedded in lime and hair, with three 5-inch spikes to each plank, the bottom of the boards being buried 3 inches below the level of the paving, as shown on Plate 35.

The chopped food which is now so universally given to Mange . horses, has simplified the construction of mangers, especially in large stables where the water is provided in troughs in the yard.

A plain trough of oak or elm boards, bound on the outer edge with sheet iron and firmly secured to the wall, may be considered the best and most economic manger for farm horses and the like, and they can be made for about half the cost of the simplest ones in iron. A manger of this description, designed by the Author, is illustrated on Plate 20 (Fig. 4), the enlarged details of which will be found on Plate 21. It will be seen that by an arrangement of the washers, the bolts which help to secure the manger to the wall, and at the same time prevent the horse from tossing out his food, are made to carry the rings for halter-tying. This kind of manger is exceedingly strong, and dispenses with the inconvenient post and cross-bearer shown on Plate 20 (Fig. 3), which is, however, sometimes preferred when the manger runs along an external wall; but if the brickwork is 14 inches thick, and the bolts as well as the sailing courses are built in with cement for about four courses in height, the manger will be found sufficient to resist the most eccentric antics of any horse, and is especially suited for heavy contractors' horses, and for those of brewers and farmers.

When the wooden posts are used they should be left rough Manger posts. and bedded in concrete, after having been charred or well coated twice with tar, otherwise the moisture, by finding its way along the surface of the wood, will cause its rapid decay. Where bales are used and divisions between the manger in the absence of partitions rendered imperative, they should be capped with sheet iron let in flush with the surface and secured

to the wood with countersunk screws. To this division one end of the bale can be firmly secured. In the long undivided trough, often used in farm stables, depredations will be committed upon each other by the horses whilst feeding, and if they are not made at least 12 inches deep the food will be thrown out. With a view to prevent this, they are sometimes sloped inwards towards the top, but are liable in this shape to secrete the dirt and become foul.

Wrought-iron
mangers.

A very good plain wrought-iron manger can be made after the pattern on Plate 20 (Fig. 1), but it should be galvanised, and this adds about 33 per cent. to the cost of a similar one in plain wrought iron, but is only very slightly in excess of one in enamel. A single trough manger, about 6 feet long, with a square overhead rack 2 feet 6 inches in length, which will be also found on Plate 22 (Fig. 5), can be obtained in enamelled, plain, or galvanised iron. These mangers, although admirably fulfilling the requirements of strength and economy, are not appropriate for a gentleman's private stable, and those made of iron for this purpose are manufactured in great variety and treated in several ways. They are made plain and painted; they are galvanised only, or galvanised and painted; and they are also to be had partly enamelled and partly painted or galvanised, the inside of the water-trough and manger-pan only being enamelled. Much attention has also been given to mangers with a view to protect the horses from injuring their heads with the fittings beneath, for which purpose matched boarding, as shown on Plate 23, Fig. 5, carried down to various depths, is used, and a manger is also sold by Messrs. Cottam and Willmore, in which the fittings have a guard of wrought iron bars carried with an inward slope from the under side of the manger-plate to the paving. These arrangements also prevent the bedding from being thrown up underneath the manger instead of being properly cleared out from the stall every day.

It would be impossible in a work of this kind to illustrate the

numerous descriptions of mangers to be obtained from the several manufacturers, but upon Plates 22 and 23 those in most general use will be found.

An ordinary manger of simple construction is illustrated on Water fittings Plate 24, Fig. 11, with waterpot, manger for chopped food or corn, and shallow under-head hayrack of wrought iron. The water can be turned on and drained away through one orifice, and carried off by a waste pipe into the drain or into a central open gutter in the stall. It is admitted into and withdrawn from the trough by a double-action cock, through a rose or by a flush inlet in the side, and a similar outlet at the bottom of the trough, as shown on Plate 24. The front of this manger has a large roll to prevent the mouth of the horse being caught, as it may be in some mangers, and the edges are overhung on the inner side to avoid any waste of the food. Portable enamelled water-pots are the best for racers and hunters, as they can be removed when it is considered that the horses have had sufficient; or if fixed, they can be fitted with drop covers. The infirmary loose boxes, *L*, on Plate 1, have provision for portable quadrant mangers, and they are easily washed and replaced or removed altogether for a time, if desirable.

The vice of crib-biting, if vice it can be always called, since it Crib-biting. often originates in pain, has been provided against by many ingenious inventions. That of Professor Varnel's is one of the most practical, as it leaves the horse without anything to bite. In this arrangement, when the manger is not pulled out for use, which is done by a strap as shown in Fig. 48, it fits into a recess, leaving a perfectly smooth surface as in Fig. 49. Water-troughs and hayracks are made upon the same principle. The dotted lines in the side view, Fig. 50, illustrate the position of the latter when not in use. The space required at the back for the action of the manger may be increased in width to form a passage, as shown at the back of the boxes *M*, on Plate 1, the mangers being replenished from behind without disturbing the horse by entering the stable.

Another method designed for the confusion of crib-biters is that of a roller forming the outer edge of the manger, which revolves when the horse attempts to grasp it with his mouth.

FIG. 48.

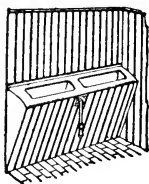

FIG. 49.

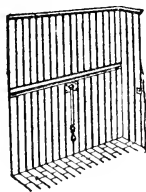
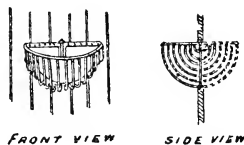

FIG. 50.



Safety
mangers.

The Author is indebted to the St. Pancras Iron Company for the illustration, Fig. 51, which shows an arrangement for the special protection of the horse, and also illustrates some

FIG. 51.

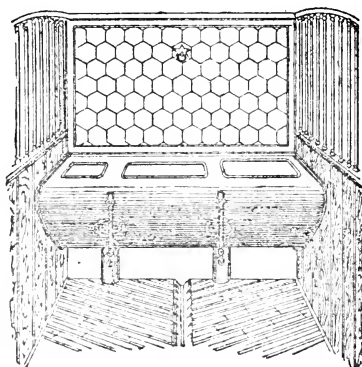

of the most recent fittings to stalls of a superior description. This manger is provided with a wrought iron curved front, presenting a perfectly smooth surface of considerable depth, and gradually sloping to the wall.

As objections are frequently raised to the principle of under- Hayracks. head hayracks, and the height of the old-fashioned rack, considerably above the manger, is equally condemned, manufacturers have turned their attention to the construction of a rack on a level with the manger which possesses the happy medium, although by its use in stalls it cuts off the through ventilation, to a great extent, from those on either side. Plate 22, Figs. 3 and 4, and Plate 23, Figs. 1 and 6, show four racks of this description, from which it will be seen that the horse feeds through the vertical bars, and by the use of a sloping grid, the hay is brought to the front of the rack. These grids are usually provided with a pan to receive the hay seeds, and they are thus removed from the rack by a portable tray.

In loose boxes, horses are either given their entire freedom, Loose boxes. or they are secured to a head-stall fastening, or permitted a Sliding bars. limited freedom by means of a sliding bar, as shown in Fig. 52,

which, being placed between the manger in one corner and the water-pot in the other, allows them to move from side to side. This bar, which should be countersunk in a plate securely fastened to

FIG. 52.

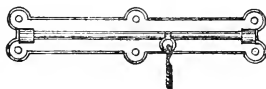

the wall, is made about 4 feet 6 inches in the bar, and 5 feet including the plate. It is provided with a runner and chain which travels along the bar as the horse moves to either side. In ordinary loose boxes, however, such as those on Plate 39, it is not usual to provide any other head-stall fastening than a wrought-iron dressing ring secured with a $\frac{3}{4}$ -inch bolt through the wall, a large detail of which will be found on Plate 46. A few of a superior character for more ornamental fittings are also shown on Plate 19, Figs. 8, 9, and 10.

Halter-tying weight boxes, for fixing beside the manger of a Halter-tying. loose box, or beneath it in a stall, together with several examples of rack-and-pillar chains, are illustrated on Plates 19 and 24; these, which are of various kinds, are fully described in the

“*Description of the Plates,*” and are all for the purpose of securing the horse in the stable or whilst it is being dressed, at the same time affording it sufficient freedom when it is feeding or at rest.

Smithy fittings.

The fittings of a smithy are not of a numerous kind, the hearth being the most important. This is usually a solid construction of brickwork, and is fully described in Chapter III., although a very heavy hood of iron is now frequently used as a substitute for brickwork.

Hearths, bellows, &c.

A portable hearth, as shown in Fig. 53, is a great convenience where a limited number of horses are kept. It is known as the “Cyclops” hearth, and may be fitted with a blower or ordinary bellows, or with a fan worked by means of a simple hand-wheel and strap. The latter produces a welding heat in less time than an ordinary bellows. The two descriptions of bellows used in smithies are illustrated by Figs. 54 and 55 ;

FIG. 53.

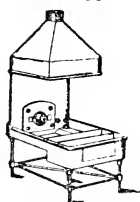

FIG. 54.

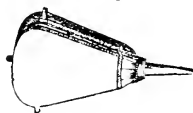
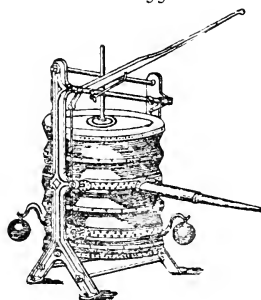

FIG. 55.



the latter is now in most general use, and occupies the least area. The anvil blocks should be 3 feet by 1 foot 6 inches in dimension, and consist of a block of yellow timber let into the floor and bedded in concrete to the depth of at least 1 foot 9 inches.

Vice-bench.

The smithy should also be fitted with a vice-bench of the

height of 3 feet 1 inch from the floor-level, and from 8 to 10 feet in length, carried upon strong 3-inch bearers wedged into the wall, and supported on legs 3 inches square firmly secured into the floor. A series of louvre slats, at least five in number, should be fixed in the space over the door, as shown on Plate 45.

A very important section of the fittings for stables are those in connection with the harness room, and of these the first which present themselves are those for keeping the harness free from damp. Mildew, which is now universally admitted to be of vegetable growth, springing from spores carried by the air, and finding a congenial substance for development in *damp* leather, rapidly spreads over harness which is left in stables or harness rooms insufficiently warmed, damp, or unventilated.

No harness room can therefore be considered complete without some means by which a regular temperature can be maintained, and as a supply of hot water should always be ready, a boiler is one of the first requirements. "The Loughborough," a view of which will be found on Plate 31, Fig. 1, has been designed, among many more, for this purpose, and can be further made to heat a row of pipes in an adjoining coach house or washer's room. It can be built into a fire-place, as in Plate 8, or stand out in the open, and the sockets placed either at the back or the sides as may best suit the construction of the building and the position of the coil or line of pipes. This boiler is 25 inches in height, 17 inches wide, and 13 inches deep.

For small harness rooms a close stove (Fig. 56) about 10 inches wide by 18 inches deep, either of wrought or cast iron, with a portable boiler to contain from one to two gallons fitted to the top is sufficient; but an open grate is always more useful for drying saddles or girths. Convertible grates of this description are made, varying from 2 feet 6 inches to 3 feet in width, which

FIG. 56.

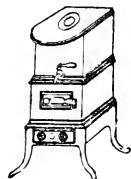

Boilers.

can be altered into a close fire at will ; they are also made for large rooms with a boiler for supplying hot water for gruel, &c., and separate provision for feeding hot water pipes for heating purposes.

Open boilers. In tramway and other stables of the kind, hot water for all purposes is obtained by means of an open boiler built in brick in cement, in a room set aside for the attendants, and used by the visiting veterinary surgeon, generally situated somewhere convenient to the loose boxes, as shown on Plates 37 and 50. In these cases the harness brackets are fixed in the stables. They consist of a deal board 5 feet long, about 12 inches wide, and $1\frac{1}{2}$ inch thick, chamfered at the edges and fitted with two stout ash pegs, two iron harness brackets, and two rein hooks.

Girth stretchers. Girth stretchers are very necessary articles for preserving the shape of the girths whilst they are drying, and are principally made of two patterns ; of varnished wood, having straps for six girths, as shown on Fig. 57, or hinged, and of enamelled iron, made in the form of a screen for standing before an open grate, as in Fig. 58.

FIG. 57.

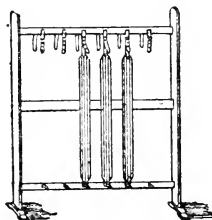
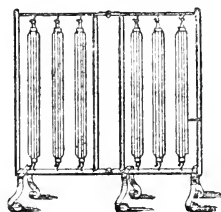

FIG. 58.



Saddle airers. Saddle airers are also required for keeping the saddle open and in its proper shape whilst being dried before the fire or out of doors. They can be obtained painted, enamelled, or covered with leather. Fig. 59 shows a wooden frame for this

purpose, which can be had in polished oak or well-seasoned fir, and exhibits the saddle strained in its position for drying. One in enamelled or galvanised iron is also illustrated by Fig. 60.

FIG. 59.

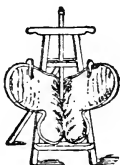

FIG. 60.



A combination of a table and saddle-horse is a useful article of furniture for harness rooms, and is shown open as a table by Fig. 61, and closed as a saddle-horse by Fig. 62. The

FIG. 61.

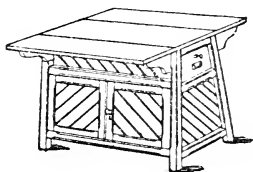
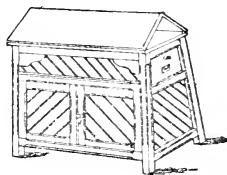

FIG. 62



lower portion is fitted up as a cupboard with two drawers above it.

Another description of harness-cleaning horse, constructed like the above to receive two riding saddles, one at each end, is shown on Fig. 63. This is fitted with a wrought-iron shaft, having collar, pad, and bridle hooks for single and double harness. It has also two flaps on hinges, making temporary shelves resting on bearers which are drawn out from beneath, and when closed form cupboards for tools.

A table or counter of a larger description is also used, and makes a capacious press for clothing where there is a large stud

of horses. These, as well as the horses, are sometimes fitted with casters for the convenience of moving about.

Harness.

Bits, curbs, spurs, and the smaller ornamental details of harness, especially those of steel, are best preserved from damp in glass cases lined with cloth. In some establishments, as in the Queen's stables, whole suites of harness are thus provided for. They may be fitted up over the fireplaces or in recesses, if possible upon an inner wall, to secure them from the action of damp.

FIG. 63.

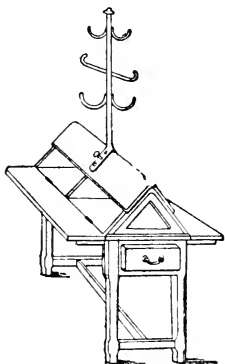

Harness
brackets.

A variety of the most modern brackets for riding and driving harness are exhibited on Plates 29 and 30, and more fully described in the Description of Plates. They are made of enamelled iron, and to admit the freest ventilation through the several parts. These can be fastened to the matched boarded

lining of the harness room, and should bear beneath them the names of the several horses to which the harness belongs.

Coach-houses,
warming, &c.

The principal fittings of a coach-house are confined to its warming apparatus, which depends to some extent on the arrangement of the several buildings, but is most generally accomplished by means of hot-water pipes in connection with the harness-room boiler. Coach-houses should be kept to a level temperature, as variations of heat and cold are as injurious to varnish as the damp is to the lining and leather of carriages and harness. A stove, as shown on Plate 8, may be made to perform the double duty of heating both the harness-room and coach-house; or, if the plan does not admit of this arrangement, the latter may be warmed by an arterial circulation carried beneath the floor, or concentrated in a nest of pipes from the boiler of an open grate, as on Plates 10 and 11, or from a closed stove.

As much light is not desirable in a coach-house, a light over the entrance doors, as on Plate 8, a portion of which may be made to swing, or a single window about 8 feet above the level of the ground, will be found sufficient.

The doors may be hung on hinges or made to slide, either past each other, or to the right and left, or the entrance may be closed by revolving shutters of iron or wood as shown on Plate 12. Either of these is more convenient than a central movable post.

Collinge's hinges, shown on Plate 28 (Fig. 3) are the best for coach-houses and entrance-gates, and are made upon the principle of the ball-and-socket, the latter forming a receptacle for oil as shown on Fig. 64, the overhanging lip serving to exclude the wet and dust. For jambs or piers of stone or brickwork, they are manufactured with fangs, as shown on Fig. 65. Fastenings are used of various kinds, one of the best and simplest being the ordinary locking bar, supplemented, *where the doors are hung on hinges*, by bolts at top and bottom. An ingenious combination of the two has been registered by the St. Pancras Iron Company, and is illustrated on Plate 26 (Fig. 2), including also a stop which fixes the door when open. A bolt with a wheel attached to the bottom, works up and down in a slide to allow of the door passing over rough ground, such as the granite paving of a yard, without raising the bolt, a socket being securely let into the ground into which the wheel drops. This wheel can be made to carry some of the weight of the door if the course over which it has to travel is sufficiently level, and the door may be opened and closed by lifting the bolt from the socket, which can be done by the foot.

Coach-house door.

Hinges and fastenings.

FIG. 64.

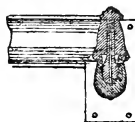

FIG. 65.



FIG. 66.



FIG. 67.

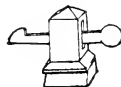

Gate stops.

The ordinary "let down" stop is represented by Fig. 66, and a catch suited only for an entrance gate is shown in Fig. 67.

The doors of smithies should be provided with 7-inch tower bolts and 8-inch rim locks.

Corn stores.

The accompanying table is for the purpose of ascertaining the size of a bin required for any quantity of food.

| | Per cubic foot. lbs. | Per bushel. lbs. | Cubic feet per cwt. |
|---|----------------------------|---------------------|------------------------|
| Barley | 42'375 | 54'37 | 2'643 |
| ,, new | 39'000 | 50'04 | 2'872 |
| ,, meal | 27'500 | 35'28 | 4'073 |
| Beans, whole | 50'875 | 65'27 | 2'201 |
| ,, bruised | 27'875 | 35'76 | 4'018 |
| Bran | 11'125 | 14'27 | 10'067 |
| Chaff | 5'750 | 7'38 | 19'478 |
| Maize, large (whole) | 46'000 | 59'02 | 2'435 |
| ,, ,, (bruised) | 39'625 | 50'84 | 2'826 |
| ,, small | 48'000 | 61'58 | 2'333 |
| Oats | 33'500 | 42'98 | 3'343 |
| ,, new | 31'188 | 40'01 | 3'591 |
| ,, bruised | 20'000 | 25'66 | 5'600 |
| Oat meal | 38'000 | 48'75 | 2'947 |
| Peas | 49'125 | 63'03 | 2'281 |
| Mixture {16 lbs. oats } {10 lbs. chaff } | 13'000 | 16'68 | 8'615 |

1,728 cubic inches = 1 cubic foot.
 27 ,, feet = 1 ,, yard.
 1'283 ,, ,, = 1 bushel.
 2218'192 ,, inches = 1 ,,

Various questions present themselves for consideration in providing the fittings for the storage and preparation of fodder, depending chiefly on the number of horses and their kind.

Corn is stored in a framed and matched boarded chamber, as illustrated on Plate 47, shut off by a door having a lock and key, from the other part of the store, or in bins, as shown on Plates 5 and 53. A detailed illustration of one of these latter receptacles, which are made to vary in size according to the

required capacity and plan of the store, will be found on Plate 54 (Figs. 1, 2, and 3). The bin is 6 feet square by 2 feet 8 inches high, and (supposing the corn to be within 2 inches of the top) contains 70 bushels. As the corn diminishes in the bin, the boards (8 inches deep) may be removed at pleasure from the grooves.

The advantage of bruising oats has been long admitted as an Machines for food. economy in feeding; when thus treated they have been found to go one-half further in measure, whilst the horse is kept in better condition. Machines are made for this purpose which will crush from $1\frac{1}{2}$ to 6 cwt. per hour by manual power, and of course a great deal more when worked by a gas engine, or by steam, or horse-power. Some of these machines are made with a steel barrel, having two cutting edges and a cutting plate of hard metal fitted on each side, so that when turned in one direction it will kibble peas, beans, and maize, and if reversed will kibble barley and oats. Chaff-cutters and mixing-machines of various sizes and power are also manufactured. The latter consists of an archimedean screw, by which means the chaff and bruised corn are thoroughly turned over and mixed together.

The daily supply of mixed food for horses usually consists of Food supply. 16 lbs. of corn and 10 lbs. of chaff, making a total of 26 lbs. A chest, therefore, such as that represented on Plate 54 (Fig. 4), being 3 feet by 2 feet by 4 feet, contains 24 cubic feet, and as there are 13 lbs. of this mixture to every cubic foot, this chest would hold a day's supply for a stable for 12 horses. A chest to contain 4 bushels, as shown on Plate 54 (Fig. 6) can be obtained in japanned or galvanised iron, and various others of different sizes and shapes, some being made with sloping lids.*

* The Winchester bushel, which was the former standard for England and originally kept at Winchester, was measured by a law of King Edgar observed throughout the kingdom. It contained 2150·42 cubic inches and the gallon 268 $\frac{1}{2}$ cubic inches. The Imperial standard bushel now used contains 2218·19 cubic inches. The proportion of the latter to the former therefore is about 32 to 33, viz., 32 pecks, bushels, or quarters of the new measure are equal to 33 of the Winchester measure.

To arrive at the contents of a bin or chest in bushels, multiply the cubic contents by 0·779.

Corn bins.

Corn bins are sometimes marked with a gauge, which gives at a glance their contents in bushels, horizontal lines of paint being drawn at every 5 bushels, with shorter intermediate lines marking the height of every bushel, so that a close approximate of the amount in the bin can be ascertained by levelling the corn to the nearest line of the gauge.

Preparing food ; motive power.

The fittings for cutting, bruising, and mixing the materials for food, depend on the means which are used for carrying out these operations, and whether manual, horse, or engine power. In stables where only a few horses are kept, the chaff is cut and the corn bruised by manual power only, and is usually passed down into the stable (sometimes into the corn-chest itself) by means of a shoot, which may be made (if desired) as shown on Fig. 68, with a contrivance after the manner of a shot-belt to measure the exact amount of food required for each horse's meal.

FIG. 68.

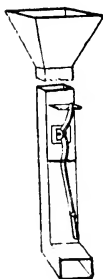

Horse power.

Where horse-power is employed a large area has to be devoted to the track. At the Portswood stables, for instance, shown on Plate 53, Fig. 2, where two horses are employed, an area of 600 feet super is occupied. The gear for a single horse, illustrated by Fig. 69, is for a machine with a 36-inch driving wheel. The pinion shaft revolves at a speed of 7 to 1, and by means of a separate intermediate motion to $33\frac{1}{2}$ to 1 of the horse.

Gas engine.

Very much preferable as a motive power, where there is sufficient work for a horse, is a small gas engine. At the stabling designed by the Author for 120 horses, and illustrated on Plate 39, a small Crossley gas engine of $3\frac{1}{2}$ horse-power, in addition to lifting the water for all purposes to a height of 30 feet, was successfully employed in working a hoist for lifting the sacks of corn to the upper floor, a large size chaff-cutter

and heavy bruiser, and in lifting the corn into the hopper. An engine of this description can be worked at the cost of $\frac{3}{4}d.$ per horse-power per hour, or $\frac{1}{2}d.$ per hour in excess of that for steam. It has an advantage over the latter, and especially over horse-power, both in economy of time and space. It is always ready for use, and only requires the ignition of the gas jets, and a turn of the wheel, to set it in motion.

FIG. 69.

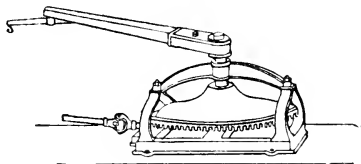

For heating ordinary boilers and furnaces any kind of coal may be used. Anthracite is the best fuel for gas engines, on account of its freedom from vapours, and greater cleanliness.

The shafting, $2\frac{1}{2}$ inches in diameter (with the position of the several pulleys and brackets), for transmitting the power to the machinery on the upper floor, is shown on Plates 47 and 48; the chaff-cutter making about $4\frac{1}{2}$ cwts., and the bruising mill bruising from 4 to 5 bushels per hour.

The hoist before referred to, connected with the motive power by the ordinary shafting and gear, as shown on Plate 47, or a wheel (illustrated on Plate 8), or a small crane for light work, as shown on Plate 51, are generally considered sufficient for the purposes of lifting in ordinary stables, but where several loads of hay have to be stored in a limited time, and steam or a large gas engine is in use, a portable Jacob's ladder is a great saving.

This contrivance consists of two endless bands of leather running parallel with each other, but not at too great a rate to prevent a truss of hay being placed on each of the pairs of arms, which project from the straps, and convey the trusses in continuous procession to the loft.

Where sliding doors are used (and they are much more convenient for haylofts than those with hinges), it will be found

Hoisting and gear.

Hayloft doors.

the best method to suspend them from a wrought-iron or steel rail, as shown on Plate 25, Figs. 2, 3, and 4. It will be seen from these diagrams that the supports can be placed sufficiently close to save a light rail from any deflection, being only 3 feet

FIG. 70.

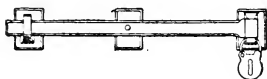

from centre to centre for a doorway 6 feet in width. At the same time they are acting as stops, and bring the doors to their proper position when shut; and if secured by the locking bar (Fig. 70) they do not

require any other fastening, if the supports are placed in the positions indicated, for they cannot be pushed either to the right or left when the bar is fast.

Hanging and sliding doors.

The ordinary way of hanging with the strap suspending from and secured to one side of the door only, so that the ends of the brackets may be passed in sliding has a tendency to tip the bottom of the door inwards, as it is not in equilibrium. Another example of a sliding door will be found on Plate 27, with wheels running on a rail secured to a sill framed with the door posts. This door is also provided with two sliding inspection panels *a, a*, for viewing the inside of a stable without disturbing the inmates. An enlarged detail of the wheel and frame will be found on the same plate.

Water supply.

The water required for the various purposes of stabling may be drawn from a well on the premises, or supplied from without. In either case the same system of distribution will be required, although it is usual in the latter case, and where much water is consumed, to have a meter with a stop cock (protected by a meter house) as some check upon the supply. In the stables illustrated on Plate 39 the pipes are shown in thick dotted black lines, the gas supply being represented in full strong lines. The water in this instance is raised to a wrought-iron cistern having a capacity of 2000 gallons, and placed on the top of a tank house. This is done by means of a $3\frac{1}{2}$ -inch double-barrel brass pump, fitted with a common vacuum vessel

and 2-inch suction and delivery pipes. The tank is situated 20 feet above the level of the yard, giving a pressure at the valve *f* in the yard (allowing for friction) of about 15 lb. per square inch.

A hand nozzle, marked *a* on Fig. 71, with copper-riveted hose *b* and gun-metal union for joint *c*, is provided, for the purpose of washing the carriages by aid of the above pressure, at any part of the yard. Indiarubber hose of small dimensions may be used, but they are not equal in durability to those of leather made by Messrs. Merryweather and others.

Washing apparatus.

FIG. 71.

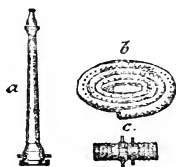
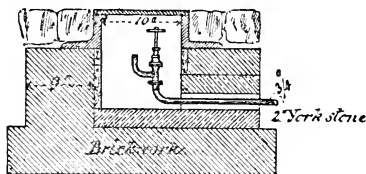

FIG. 72.



The valve wells shown by Fig. 72 are built in brick, in cement, lined with a rendering $\frac{3}{4}$ -inch thick of Portland cement, and for the purpose of protection have a strong hinged cover of cast iron.

The valves consist of a loose screw-down hydrant with hand-wheel and screwed outlet to receive the hose pipe; they are also fitted with a gun-metal cap and chain. The most convenient place for these valves, which can be used wherever a pressure is to be obtained sufficient for the purpose of washing carriages, depends upon the plan of the stabling, and the position of the carriage to be washed will be limited only by the length of the hose, the latter being also used for washing out the stable and boxes and flushing the drains.

Valves.

Gas is now most generally used for lighting where it is within easy reach, and in large stables is laid on upon the principle shown on Plate 39. It will be seen that where a gas engine is

Gas supply.

used a supplementary meter *a* is attached, supplied through one of larger size which registers the entire amount and is placed immediately within the boundary of the premises. The pipes are carried from the principal main, diminishing in diameter as they approach the several burners most remote from their supply. All the burners in this case are $\frac{3}{8}$ inch in diameter, the gas engine of $3\frac{1}{2}$ horse-power being equal to about 25.

Oil lamps.

Where the gas works are too far removed from the site of the stabling to be available, oil lamps, as shown on Plate 31, Fig. 5, can be made to shift from stall to stall as the groom proceeds with his work, or can be moved by the aid of runners along the whole length of a stable. The safety lamp, Fig. 3, on the same plate, made for burning candles, can be treated in this way if its use is preferred to oil.

I N D E X.

A.

Aberdeen Corporation stables, 67
 Abyssinian wells, 35
 Accommodation, 15
 Administrative block, 6
 Admission of air, 62
 Advantage of good paving, 57
 — of soft water, 48
 Ants, destruction by, 2
 Arches, relieving, 24
 Area of stalls, 14
 Arrangement of buildings, 4, 6, 7
 Aspect, 1, 6
 Attendants, number of, 15

B.

Bale-poles, 75
 Bales, 75
 Ballast, 23
 Bedding posts, 79
 Bellows, 84
 Bevelled bricks, 51
 Boarding, 78
 Boilers, 85
 Bolts through mangers, 79
 Bosses and head stall rings, 83
 Bowes, Scott, & Co.'s closets, 36
 Boxes for concrete, 22

Boxes for hunters, 16
 Boyle's ventilators, 67
 Brackets for harness, 86, 88
 Brass fittings, 14
 Breeding stables, 16
 Bricks, bull-nose, 25
 — grooved, 51
 — gutter, 39
 — paving, 50
 — stock, 54
 Broken boards, 71

C.

Cambridge Tramways, 29
 Capping to mangers, &c., 76,
 79
 Care in paving, 56
 Carriage shed, 33
 Cast iron, 69
 Caulking, 43
 Cavalry stables, 71
 Ceilings and lofts, 66
 Cement, 43
 — rendering, 33
 Central depôts, 18
 Cesspool, 47
 Chaff-cutting, 91
 Chains, 83
 Chamfered bricks, 52

Channel bricks, 39
 Choice of site, 1
 Chopped food, 18, 19
 Cistern, 95
 Clay jointing, 43
 Cleating, 77, 78
 — double, 78
 — horizontal, 78
 Clinkers, 50
 Closets, 36
 Clothes press, 87
 Clutch boxes, 71
 Coach house doors, 89
 — houses, 88
 Cobble stone paving, 58
 Collinge's hinges, 89
 Colouring bricks, 34
 Columns, 29
 Combination loose box and stalls,
 15
 Common rafters, 30
 Concrete, 22
 — mixing, 22
 — piers, 22
 — slabs, 26
 — tubes, 35
 Construction, 21
 — of louvres, 63
 Convertible grates, 85
 — loose boxes, 14
 Corn bins, 92
 — bruising, 91
 — chamber, 91
 — chest, 91
 — shoots, 92
 — stores, 17, 90
 — store window, 24
 Corner bricks, 25
 — mangers, 81
 Corrugated tiles, 65
 Cost of gas engine, 93
 Cottam and Willmore's traps, 46

Crosse and Blackwell's stables, 12,
 29
 Cubic capacity of bins, 92
 — — of hay, 19
 — — of hayloft, 18
 — — of stables, 15, 61
 — feet of grain per cwt., 90

D.

Damp course, 24
 Depeter work, 25
 Description of fodder, 18
 — of timber, 77
 — of plates, xi.
 Difficulties in towns, 10
 Dimensions of stables, 13
 Dinning and Cook's swing door,
 74
 Disposal of sewage, 47
 Division walls, 27
 Door frames, 74
 Double cleating, 78
 — row of stalls, 14
 Doulton and Co.'s traps, 45
 Downcast ventilation, 65
 Down pipes, 25
 Drainage, 38
 — in relation to paving, 39
 — of loose boxes, 40
 Draughts, 62
 Dressing-rings, 27
 Dung-pits, 48
 Duresco distemper, 33
 Duty of tie-beams, 31

E.

Earthenware traps, 45
 Economy of piers, 23
 Elm mangers, 79
 Entrance gates, 37

Examples of paving, 55
 — of stables, 8
 Excavations, 21
 Extensions, 4

F.

Fanlights, 63
 Farm stables, 17
 Fastenings, 75, 94
 Fencing, 37
 Fireproof buildings, 27
 — floors, 27
 Fitter's shop, 19
 Fittings, cast and wrought-iron, 75,
 94
 Fitzwygram, General, arrangement
 by, 41
 Fixing posts, 73
 Flooring of corn store, 28
 Fodder, 91
 Footings, 22
 Foundations, 21
 Framed wood floor, 59
 Frames for loose-box doors, 74

G.

Gabled roof, 31
 Gates, 37
 Gate stops, 90
 Gas burners, 96
 — engines, 93
 — meters, 96
 — pipes, 96
 — supply, 96
 Gear for preparing fodder, 93
 General remarks, 1, 60
 Girders, 29
 Girth stretchers, 86
 Glass tiles, 38
 Glazed tiles, 33

Glazed ventilators, 68
 Granite open gutters, 41
 — paving, 57
 Gravel, 23
 Grids for hay racks, 83
 Grills for floors, 28
 Guard bars for mangers, 80

H.

Halter tying, 83
 Hanging doors, 19
 Hard paviers, 54
 Harness brackets, 88
 — cleaning horse, 87
 — maker's shop, 19
 — room, 85
 Hay, cubic capacity, 19
 Hayden's principle of ventilation,
 67.
 Hayloft, 17
 — doors, 94
 Hayracks, 83
 Head-post ventilators, 67
 Hearth for smithy, 84
 Heating, 85, 88
 Heel-posts and pillars, 72
 Herring-bone paving, 55
 — strutting, 29
 Hitching's plaster, 28
 Hock baths, 8
 Hoisting gear, 93
 Homestead, 3
 Hood in smithy, 84
 Hoop iron, 23
 Horse for cleaning harness, 95
 Horse-power, 92
 Horses, improvement of, 2
 Hunting stables, 10, 16
 Hyatt's concrete floors, 28
 Hydrants, 95

I.

- Inclosure fences, 37
 — walls, 36
 Inspection pits, 44
 — provision for, 81
 Intermediate walls, 23
 Iron corn-chests, 91
 — homesteads, 3
 — mangers, enamelled, 80
 — — galvanised, 80
 — — — and painted, 80
 — — — painted, 80
 — stables, 2
 — syphon traps, 45
 — wrought and cast, 69
 Isolation, 45

J.

- Jacob's ladder, 94
 Jointing pipes, 43
 — — in cement, 43

K.

- Kicking boards, 78
 King-post roofs, 31
 Kirkaldy's brick tests, 54

L.

- Lairs, 8
 Lamps, 96
 Lantern ventilation, 63
 Lean-to roof, 30
 Leicester granite, 58
 Level of floor, 55
 — of stalls, 42
 Light and air, 62, 68
 Lime whitening, 34
 Living accommodation, 7, 9, 13
 Locking bar, 94
 — bolt, 75
 Locks for loose boxes, 75

Lofts, 31

- London General Omnibus Com-
 pany's stables, 57, 64
 Loose boxes, 73
 — box doors, 74
 — — mangers, 81
 — — size of, 16
 — — with stalls, 15
 Loughborough stove, 85

M.

- Machinery, 91
 Macclesfield stone, 58
 Malet's bale suspender, 77
 Manager's house and office, 20
 Mangers, 79
 — with posts, 79
 — wrought iron, 80
 Manholes, 44
 Manure pit, 48
 Measurement of food, 92
 Mews, 11
 Mixed food, 22
 Mixing concrete, 22
 — machine, 91
 Morse's water colour, 33
 Mount Sorrel granite, 58

N.

- New hay, 19
 Newry granite, 58
 Nimrod on stables, 16
 North London Tramway stables, 32
 Number of bricks per yard, 50, 51,
 53, 54, 55

O.

- Oak posts to mangers, 79
 Oil lamps, 96
 Omnibus stables, 20, 57
 Open brick channels, 39

Open roofs, 31
 — surface channels, 39
 Ornamental posts, 72
 Outlet of gutters, 40
 Outside walls, 23

P.

Panel to ramp, 70
 Partitions, 70
 Paving bricks, 50
 — granite, 57
 — metallic, 56
 — requirements of, 50
 — smithy, 59
 — without concrete, 56
 — wood, 58
 Paviers, 51
 Peat bog, 22
 Perforated pipes, 67
 Piers in concrete, 22
 Pillars of loose boxes, 72
 Pipes (drain), 42
 Pitch pine, 77
 Plank flooring, 59
 Planning, 6
 Pointing, 34
 Portable hearths, 84
 — iron stables, 3
 — partitions, 71
 — mangers, 81
 — ramps, 71
 — water pots, 72
 Portwood stables, 92
 Post hook, 72
 Posts to lofts, 29
 Pounds of grain per cubic foot, 90
 — — — per bushel, 90
 Preparing ground for paving, 56
 Private stables, 8
 Provisional strength for roofs, 31
 Pump, 95

Q.

Queen-post roofs, 31
 Queen's stables, 88

R.

Racing stables, 16
 Rain water, 48
 — — drains, 48
 — — tanks, 48
 — — pipes, 25
 Ramps, 72
 — panels, 70
 — rails, 70
 — rounded, 23
 Recessing down pipes and taps, 25
 Rendall's glazing, 33
 Rendering walls, 33
 Requirements of horses, 1, 62
 Revolving shutters, 12
 Rock concrete tubes, 35
 Roley rags, number of yards super
 per ton, 58
 Roofs, 30
 — at Ponder's End, 30
 — common rafter, 30
 — king-post, 31
 — lean-to, 30
 — lofts in, 31
 — open, 31
 — queen-post, 31
 — wrought iron, 32
 — zinc, 32
 Rooms over stables, 7
 Rough cast, 25
 Rounded corners, 23
 — ramps, 72

S.

Saddle airer, 86
 — horse, 87
 — room, 7

- Safety bars, 71
 — catch, 77
 — hook, 77
 — mangers, 82
 Sailing courses, 79
 Separation in stalls, 69
 Shafting, &c., 93
 Shape of buildings, 21
 Sherrington ventilators, 68
 Shirley stables, 18
 Shoot for corn, 92
 Simplicity of construction, 5
 Size of loose box, 15
 Sizes of bricks, 50, 52, 54
 Slate urinals, 36
 Sliding bar, 83
 — doors, 74
 Slope in stalls, 42, 57
 Smithy, 26
 — fittings, 84
 Soft water drains, 48
 — — tank, 48
 Southampton Tramway stables, 18
 Stable doors, 94
 Stables, 1
 — for hunters, 10
 — for racers, 16
 — in mews, 11
 — in Sackville street, 7
 — in the country, 9
 — in towns, 10
 — on upper floors, 12, 29
 Stall divisions, 70
 Stalls, 13, 17
 — with loose boxes, 15
 Steep inclines, 42
 "Stonehenge," 10
 Stone walls, 24
 — ware damp courses, 24
 Stop ends to gutters, 40
 Stopping openings, 60
 St. Pancras Iron Company's stalls, 82
 Stuart's metallic paving, 56
 Suburban stables, 10
 Superficial area, 14
 Supervision, importance of, 49
 Surface drainage, 48
 Surgery, 19
 Suspended doors, 94
 Syphon traps, 45
- T.**
- Table of capacity of grain, 90
 — of vitrified bricks, 54
 Tank, 95
 Tattersall, Mr. G., on hunting
 stables, 16
 Temperature of stables, 61
 Templates, 32
 Thames ballast, 23
 Thickness of walls, 23
 Through ventilation, 65
 Timber in roofs, 31
 Town and country stables, 9, 10
 Tramway stables, 19
 Treatment of foundations, 21
 Trough closets, 36
 Tuck pointing, 34
- U.**
- Underground drainage, 43
 Upper floors, 12, 69
 Urinals, 36
- V.**
- Valves, 96
 Various kinds of stone paving, 58
 Velocity in drains, 43
 Ventilating heel-posts, 67
 — partitions, 30
 — tiles, 65
 — upper floors, 67

Ventilation, 45, 60
 Vestibule of stables, 7
 Vice bench, 84
 Vitrified bricks, 53

W.

Walls on arches, 24
 Washable distemper, 33
 Washer's room, 9
 Washing carriages, 95
 — room, 7
 Water fittings, 81
 — pot, 81
 — supply, 95
 Weight and capacity of grain, 90
 — of stock bricks, 55
 — of vitrified bricks, 54
 Well, 34
 — for value, 95

Wilkinson's paving, 39
 Wood floors, 28
 — paving, 58
 Wrought iron capping, 76, 79
 — — covered surface gutters,
 41
 — — mangers, 80
 — — roofs, 32
 — — surface gutters, 39

Y.

Yard gullies, 45
 Yards, 4

Z.

Zigzag drainage, 52
 Zinc roofs, 32

PRIVATE STABLES.

DESIGN N° 1.

Byng Garaud, Architect.

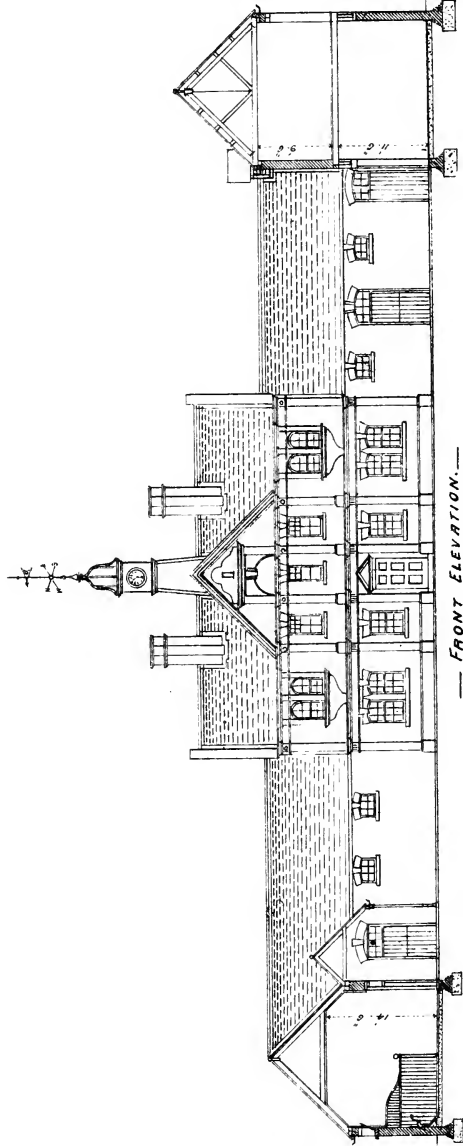

FRONT ELEVATION.



PRIVATE STABLES . DESIGN NO 1. *Byng Giraud, Architect.*

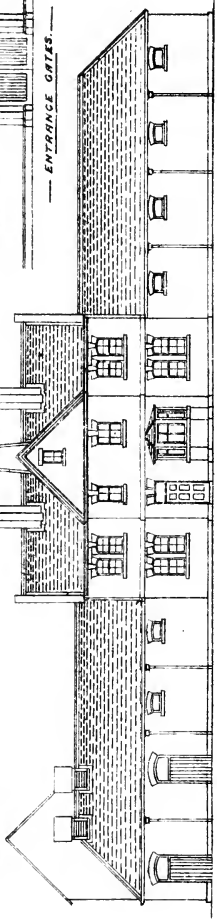
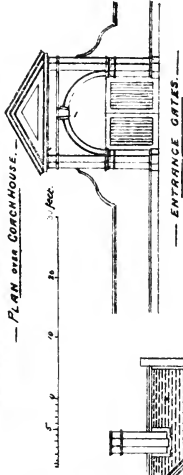
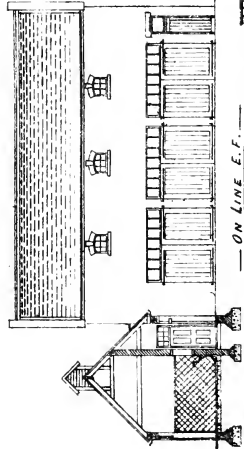
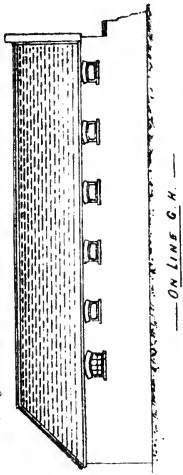
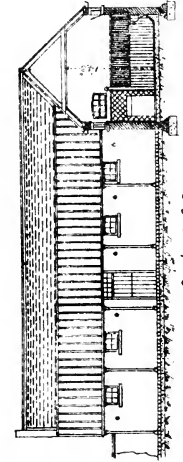

PRIVATE STABLES. DESIGN N^o 2. Byng Giraud Architect.

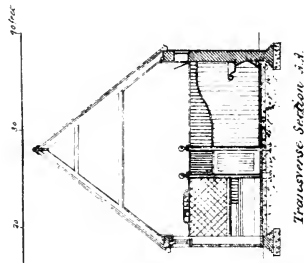
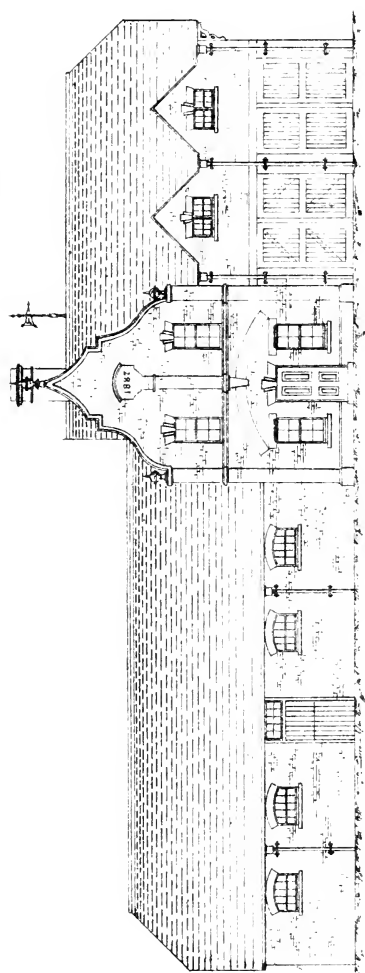

Transverse Section. s. 1.

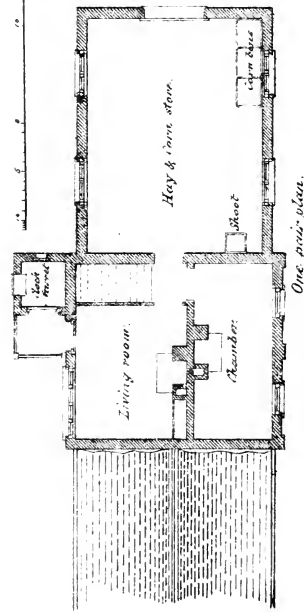

One pair plan.

PRIVATE STABLES.

DESIGN N^o 3.

Byns Giraud, Architect.

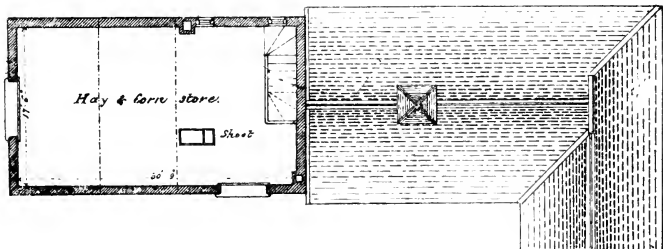
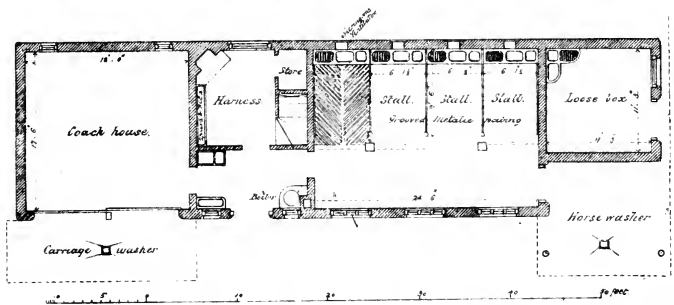
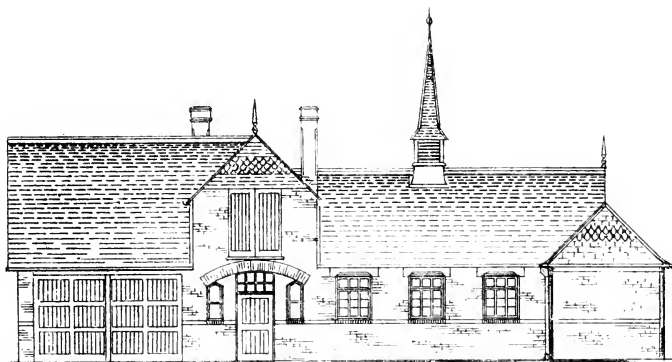

PRIVATE STABLES.
 DESIGN N^o 4.
Arrangement by Strehenve.

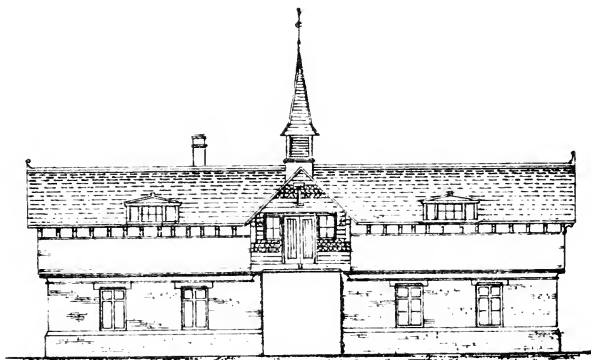

ELEVATION.

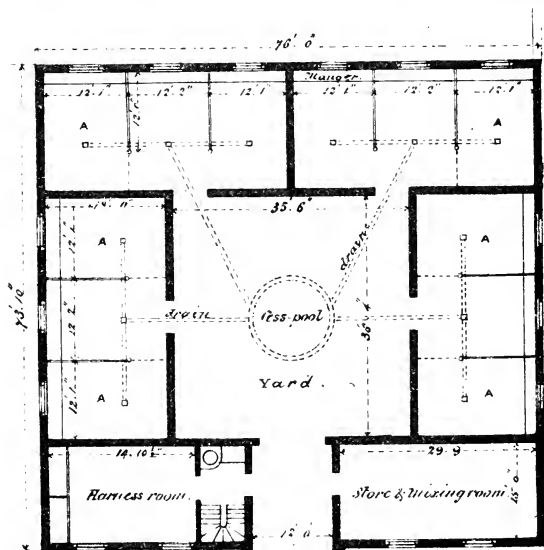

PLAN.

PRIVATE STABLES.

DESIGN N^o 5.

Byng Giraud, Architect.

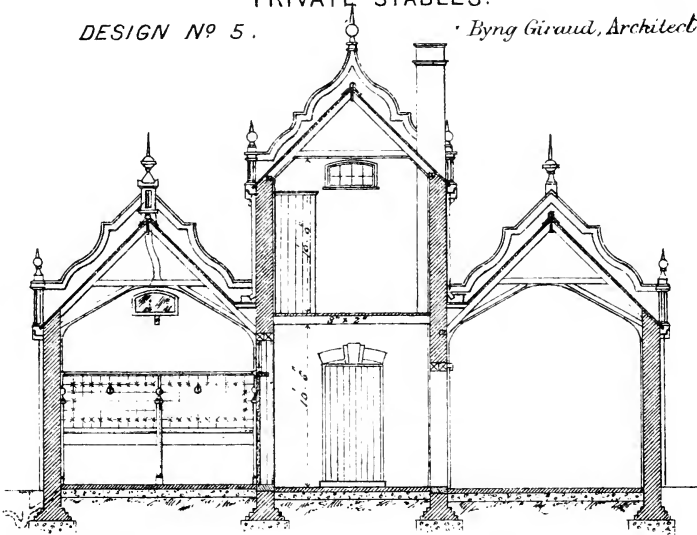

— SECTION ON LINE C. D. —

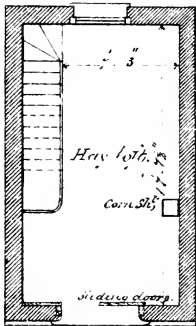

— FIRST FLOOR PLAN —

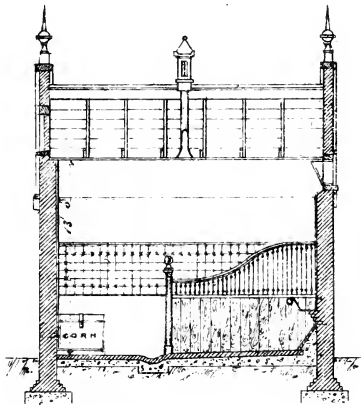

— SECTION ON LINE A. B. —

10 9 8 7 6 5 4 3 2 1 0

0

20

30 feet

PRIVATE STABLES.
 DESIGN N° 6 FOR TOWNS
B. Giraud Architect, Etc.

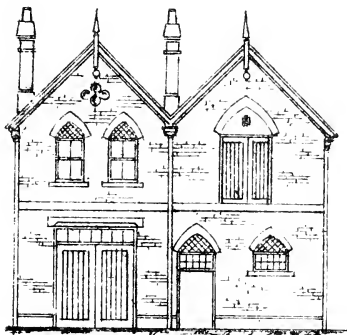

FRONT ELEVATION.



BACK ELEVATION.

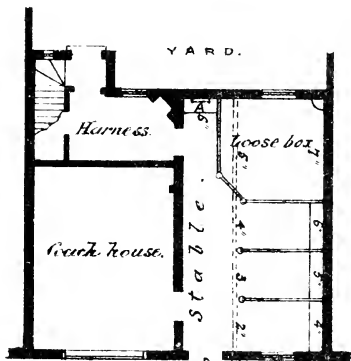

GROUND FLOOR PLAN.

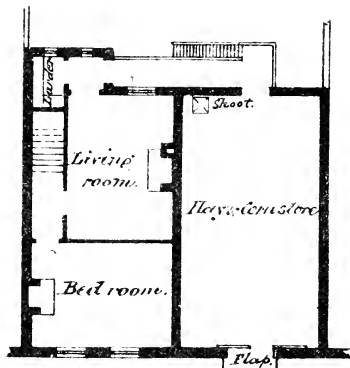

FIRST FLOOR PLAN.

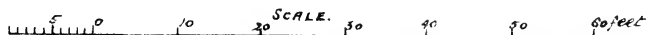

PRIVATE STABLES.
DESIGN NO 7 FOR COUNTRY

B. Giraud Architect, Etc.

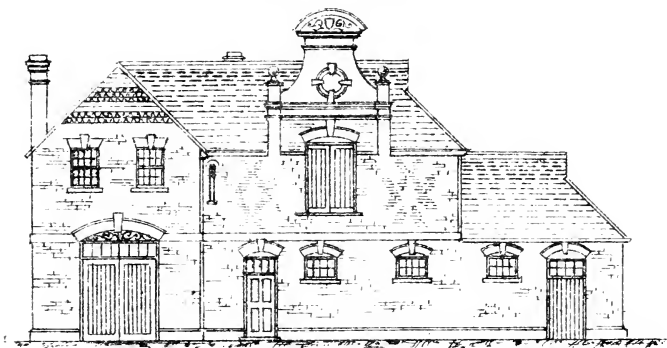

FRONT ELEVATION.

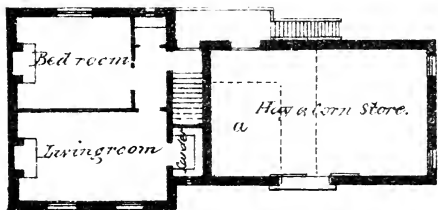

FIRST FLOOR PLAN.

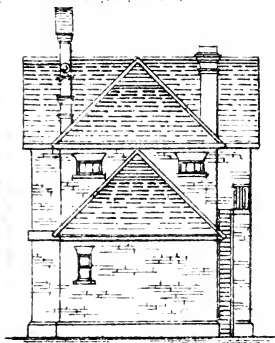

END ELEVATION.

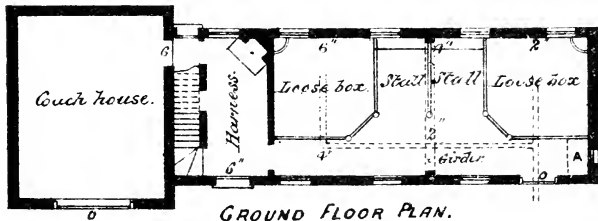

GROUND FLOOR PLAN.

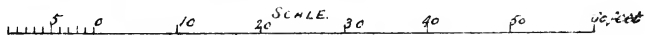

PRIVATE STABLES.

DESIGN NO 8.

Byng Giraud,

Architect.

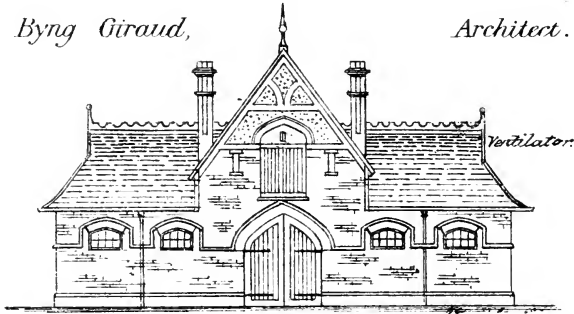

ELEVATION.

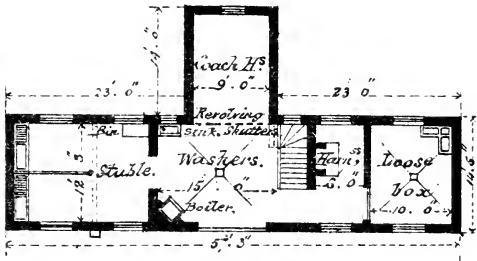
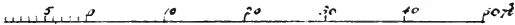

GROUND PLAN.

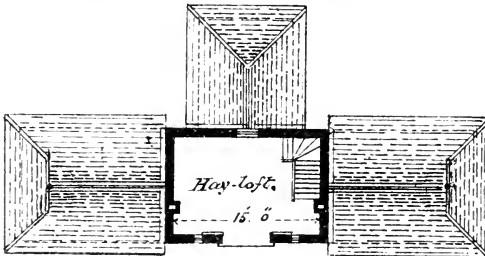

ONE PAIR PLAN.

PAVING.

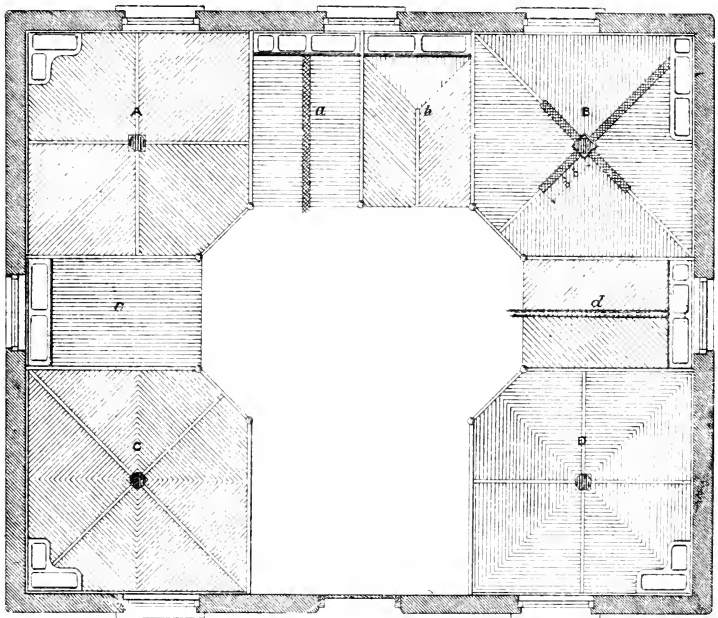

10 9 8 7 6 5 4 3 2 1 0 10 20 11 12

PAVING.

Fig. 1.

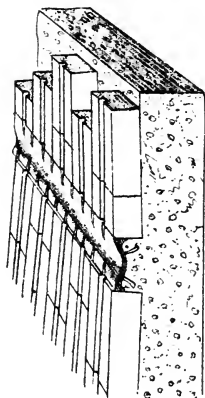

Fig. 2.

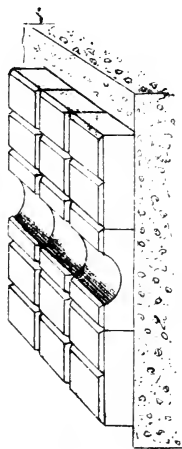

Fig. 3.

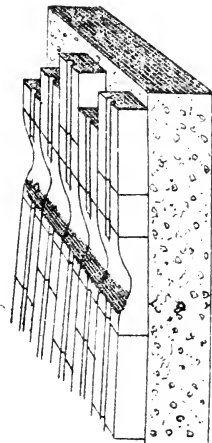
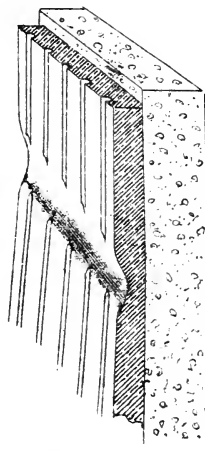

Fig. 4.



HEEL POSTS.

ENLARGED VIEW.

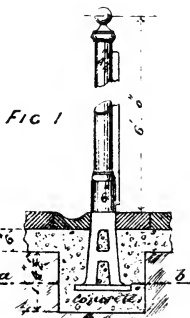

FIG 1

Plan at a.b.

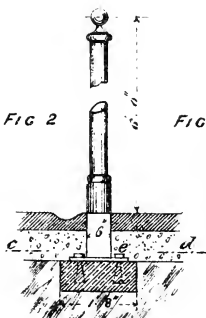
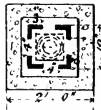

FIG 2

Plan at c.d.

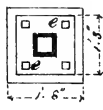

FIG 5.

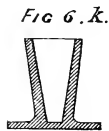

FIG 6.k.

CLUTCH BOX.

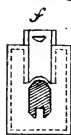

FIG 7

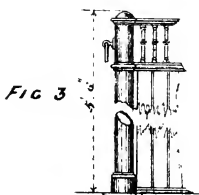
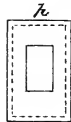

FIG 3

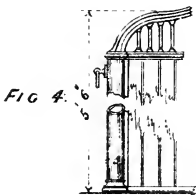

FIG 4

Inches 12 0 1 2 3 4 5 6 7 8 9 10 feet

SCALE FOR FIGS: 6 & 7 ONLY.

Inches 0 1 2 feet

RAMP RAILS.

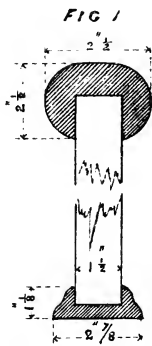

ENLARGED SECTION.

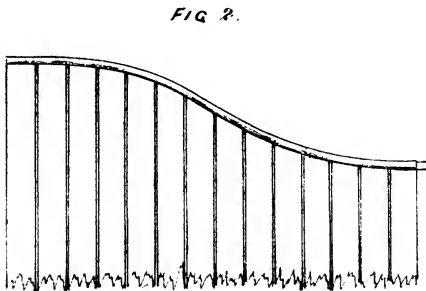

ELEVATION.

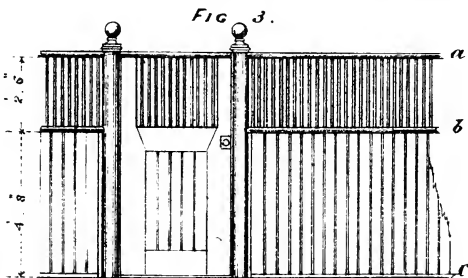
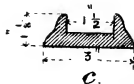
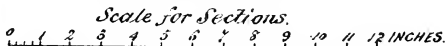
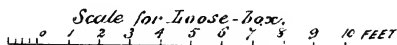

LOOSE-BOX.

LOOSE BOXES.

FIG 1

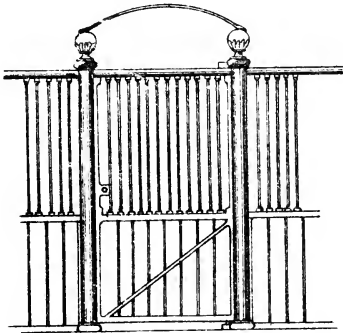

ELEVATION.

FIG 4.

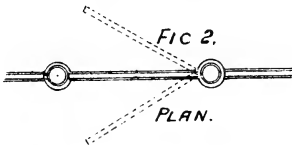
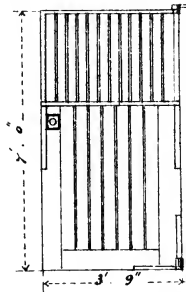

FIG 2.

PLAN.

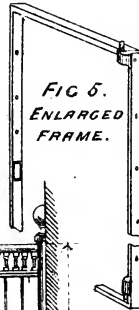
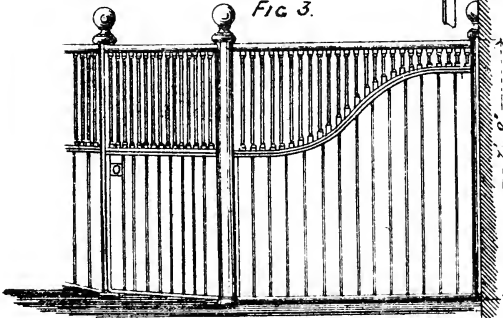
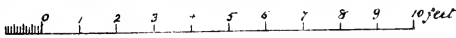

FIG 5.
ENLARGED
FRAME.

FIG 3.



ELEVATION.



STALL PARTITIONS.

FIG. 1.

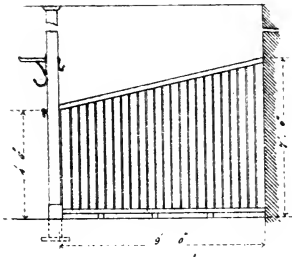

FIG. 2.

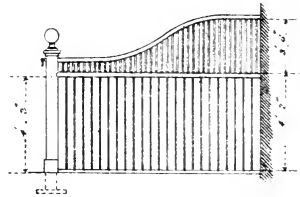

FIG. 3.

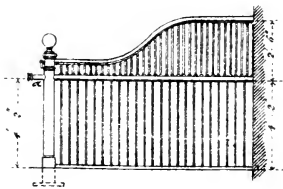
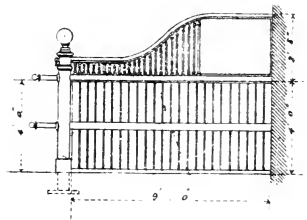

FIG. 4.



PARTITIONS AND STALL FITTINGS.



FIG 1

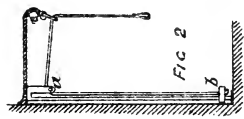

FIG 2

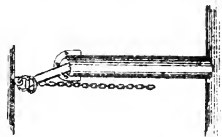

FIG 3.

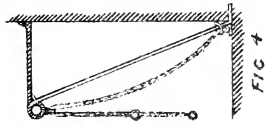

FIG 4

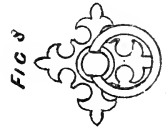

FIG 8

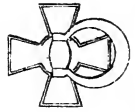

FIG 9

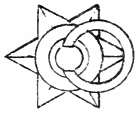

FIG 10.

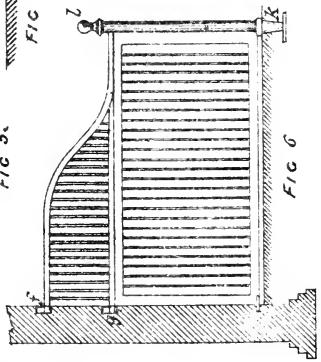

FIG 6

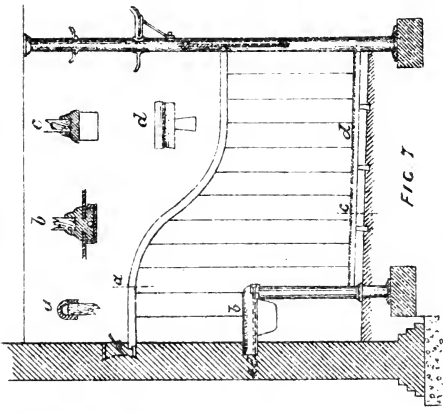

FIG 7

Scale for Figs 1, 2, 3 & 5. In. 1 2 3 4 5 6 7 8 9 10 15 20 feet.

MANGERS.

FIG 1.

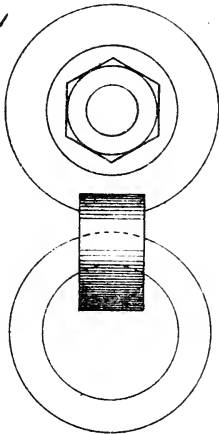

FIG 2.

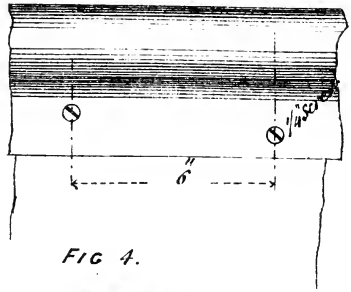

FIG 4.

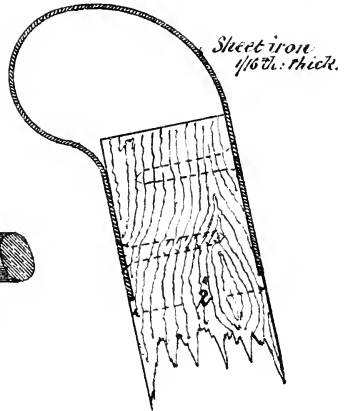
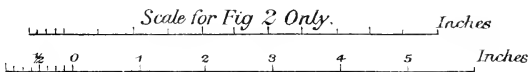
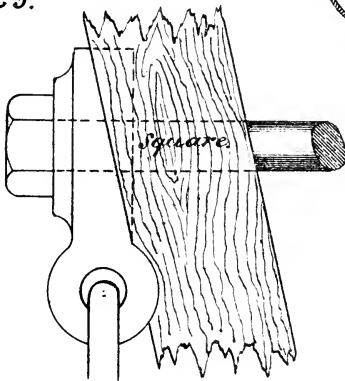

FIG 3.



MANGERS AND HAY-RACKS,
STALLS.

FIG. 1.

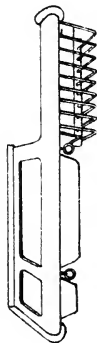

FIG. 3.

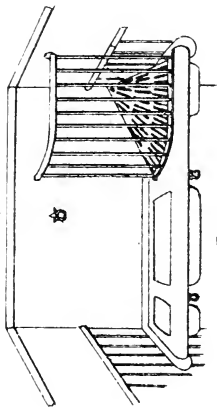

FIG. 5.

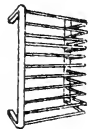

FIG. 2.

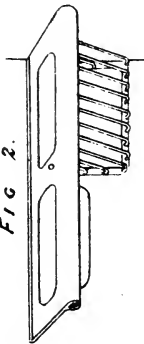

FIG. 4.

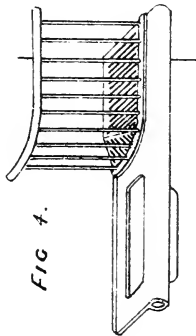
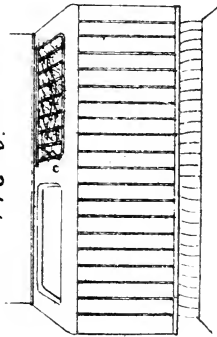

FIG. 6.



MANGERS.
LOOSE BOXES.

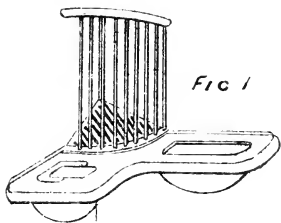

FIG 1

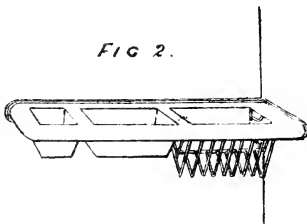

FIG 2.

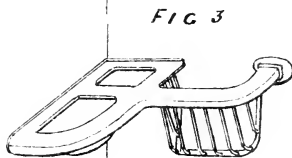

FIG 3

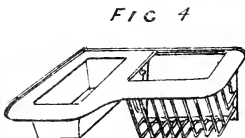

FIG 4

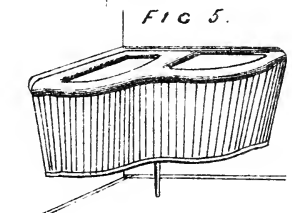

FIG 5.

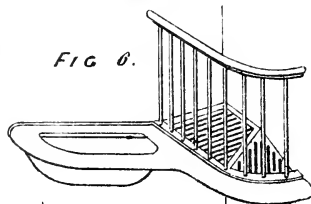

FIG 6.

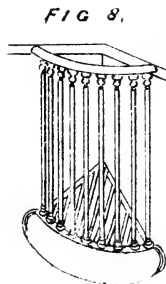

FIG 8.

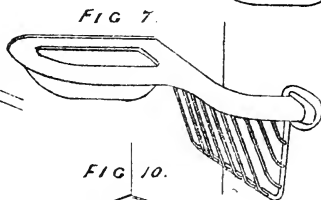

FIG 7.

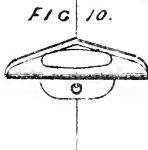

FIG 10.

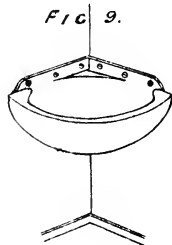

FIG 9.

STALL FITTINGS.

FIG 1



FIG 2



FIG 3.



FIG 4



FIG 5.



FIG 6



FIG 8.



FIG 9



FIG 7.



Supply. Waste
on off.

FIG 10.

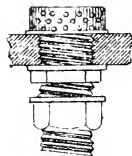

FIG 11

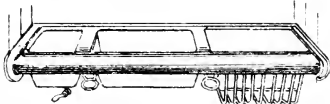
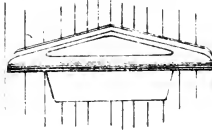

FIG 12.



12 9 0 1 2 3 4 5 feet

GATES AND DOORS

FIG. 1

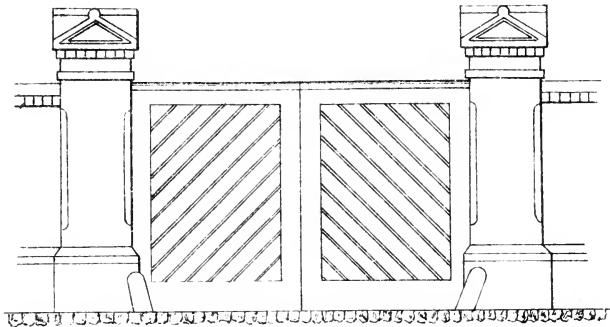

ENTRANCE GATES.

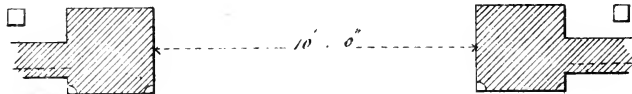

PLAN.

FIG. 2

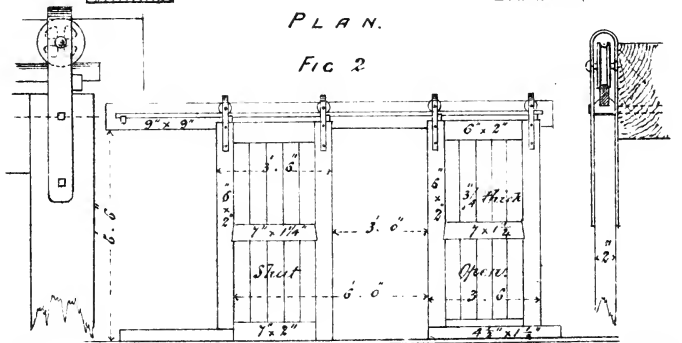
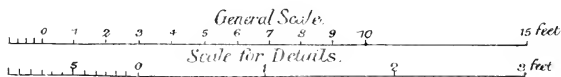

FIG. 3.

DOORS FOR CORN STORE.

FIG. 4.



FENCE AND GATES

ELEVATION.

SECTION.

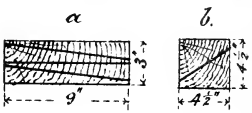
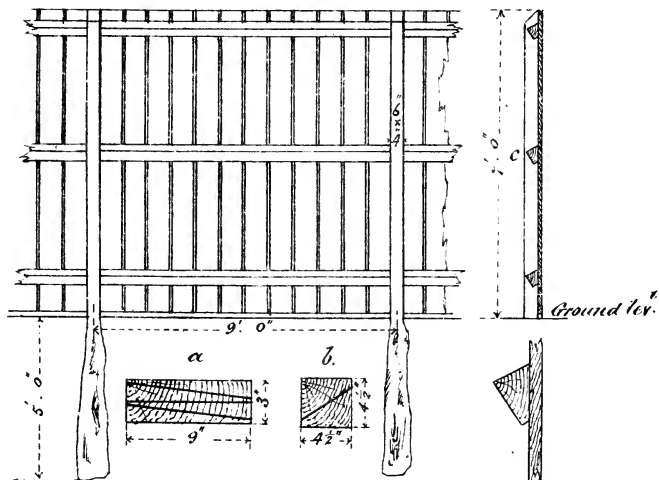

PLAN.

ENLARGEMENT AT C.



FIG 1

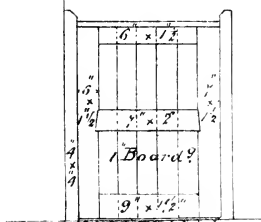
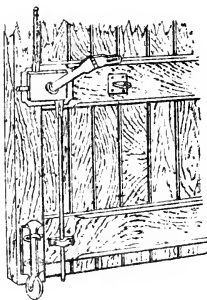

FIG 2.



SLIDING DOORS.

Elevation of Stable Door.

Enlarged Detail.

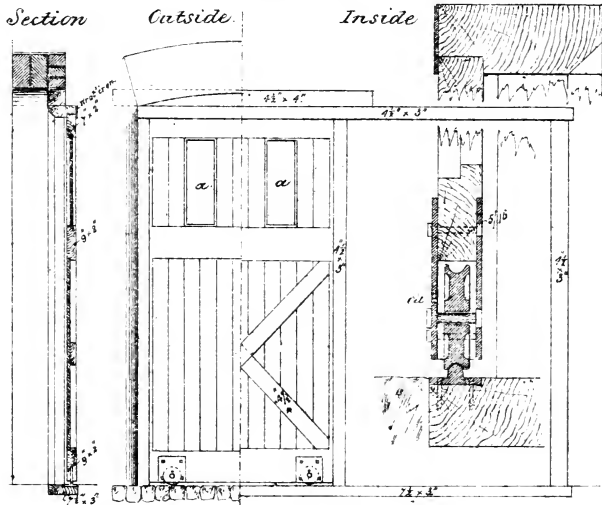

Plan.



Scale for Elevations, Plan & Section.

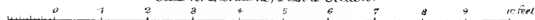

Scale for Enlarged Detail.

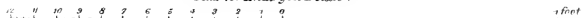

HINGES

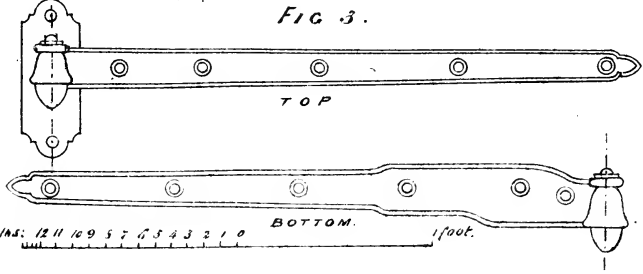
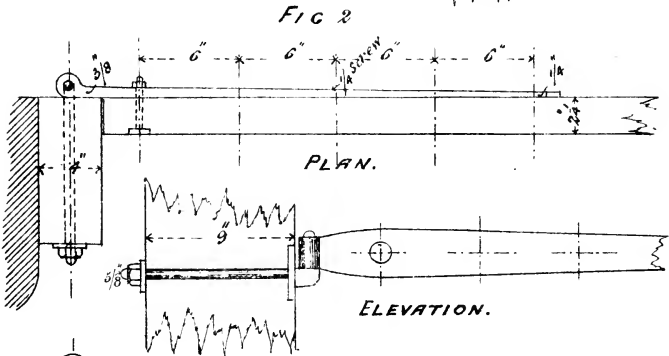
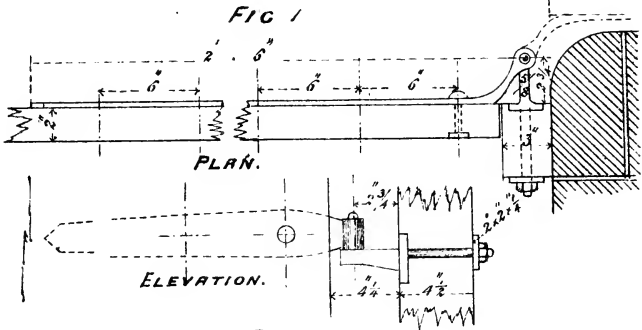

HARNESS BRACKETS

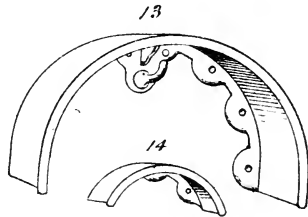
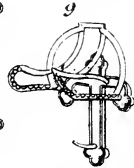
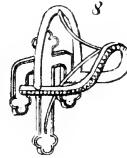
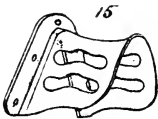
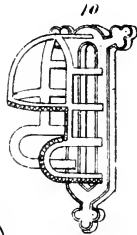
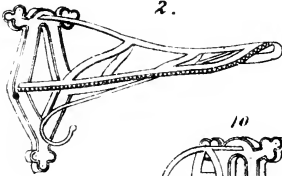
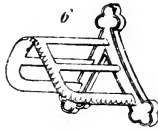
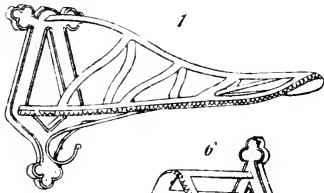

HARNESS BRACKETS.

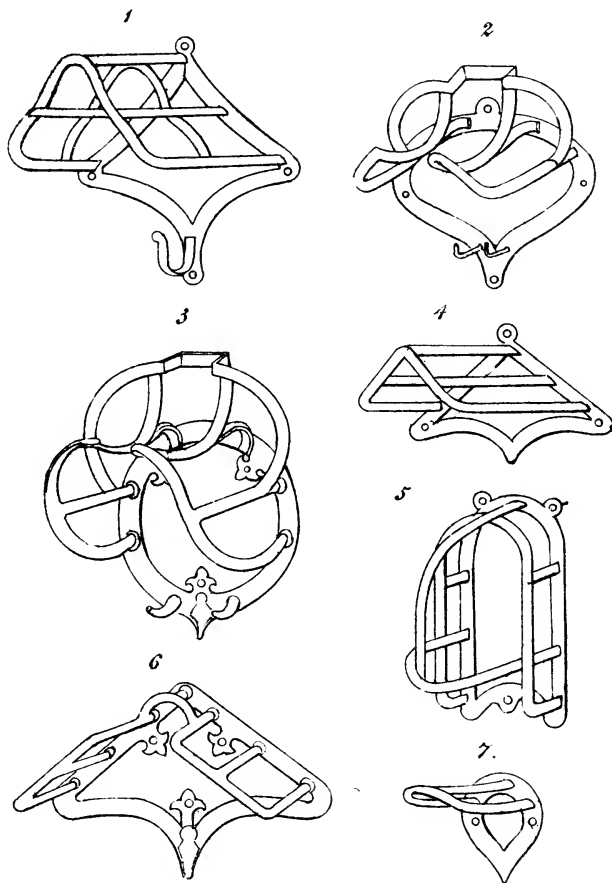

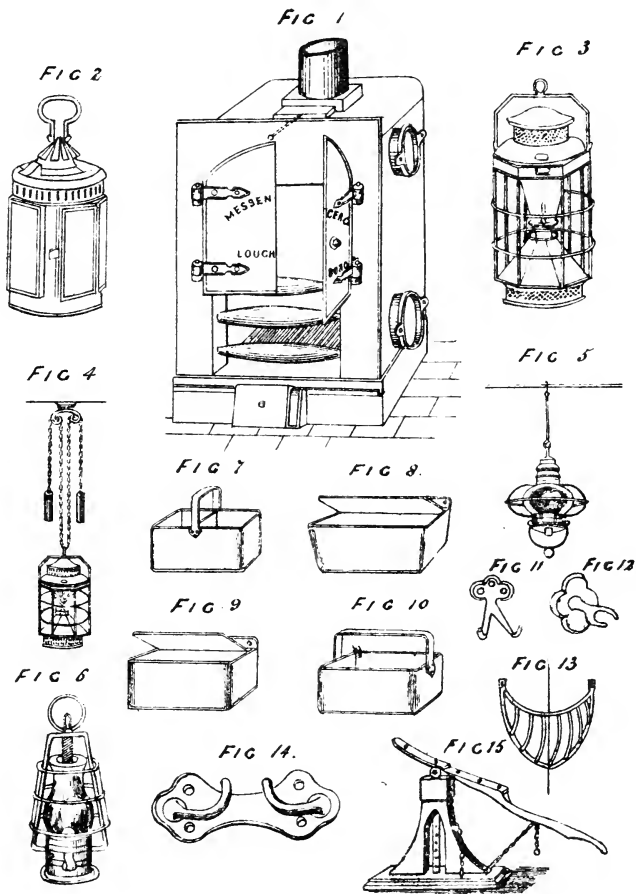

PLAN OF THE LONDON GENERAL OMNIBUS COMPANYS STABLING AT POPLAR.

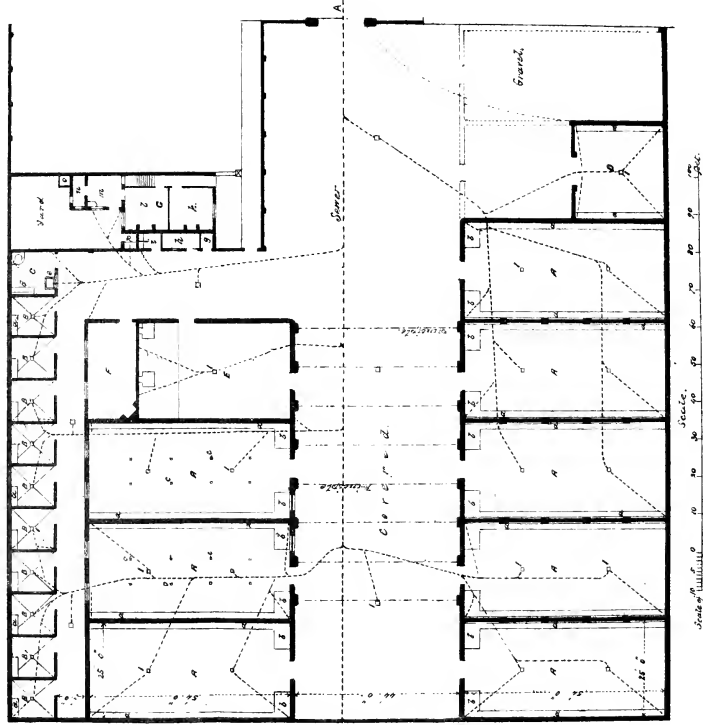

LONDON GENERAL OMNIBUS COMPANYS STABLES.

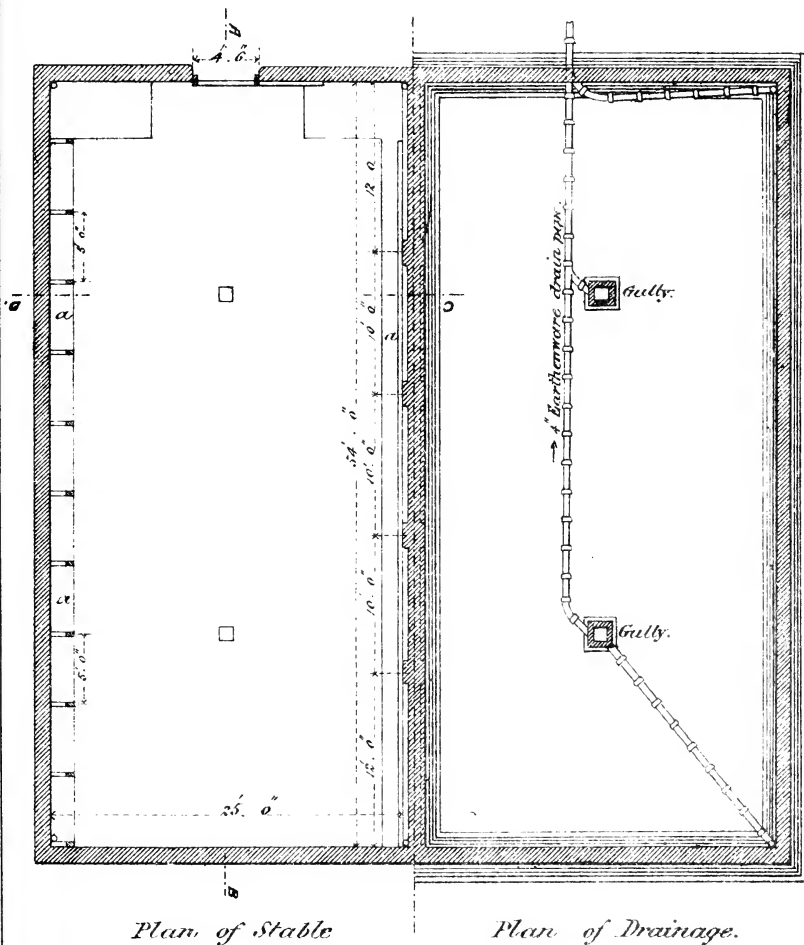

10 9 8 7 6 5 4 3 2 1 0

SCALE.

10

20 feet.

LONDON GENERAL OMNIBUS COMPANYS STABLES.

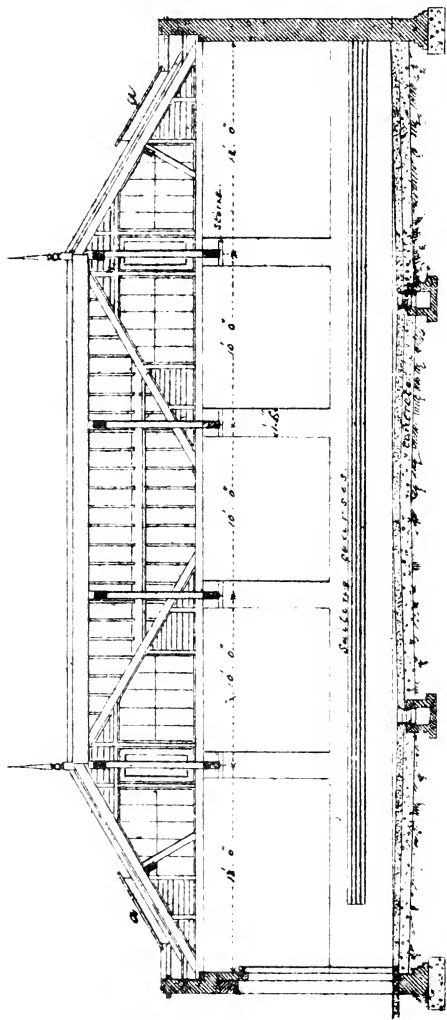

Longitudinal Section A. B.

Scale. 1" = 10 feet

LONDON GENERAL OMNIBUS COMPANYS STABLES.

Enlarged Details a. b.

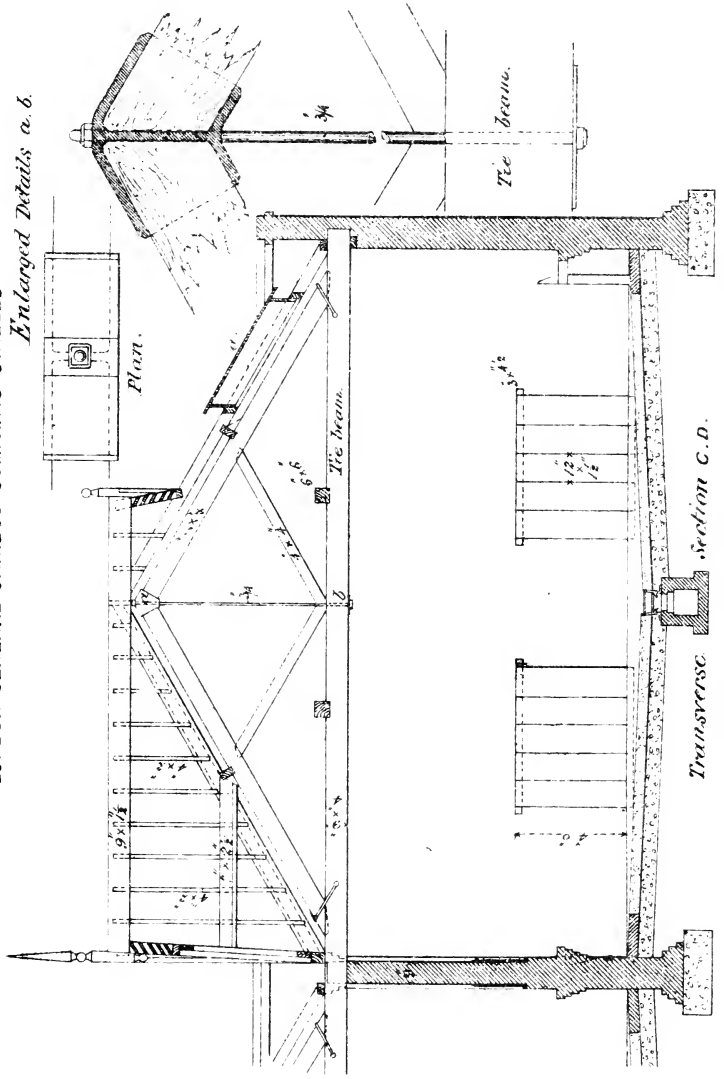

10 9 8 7 6 5 4 3 2 1 0

SCALE FOR ENLARGED DETAIL

3/4"

10/16"

LONDON GENERAL OMNIBUS COMPANYS STABLING.

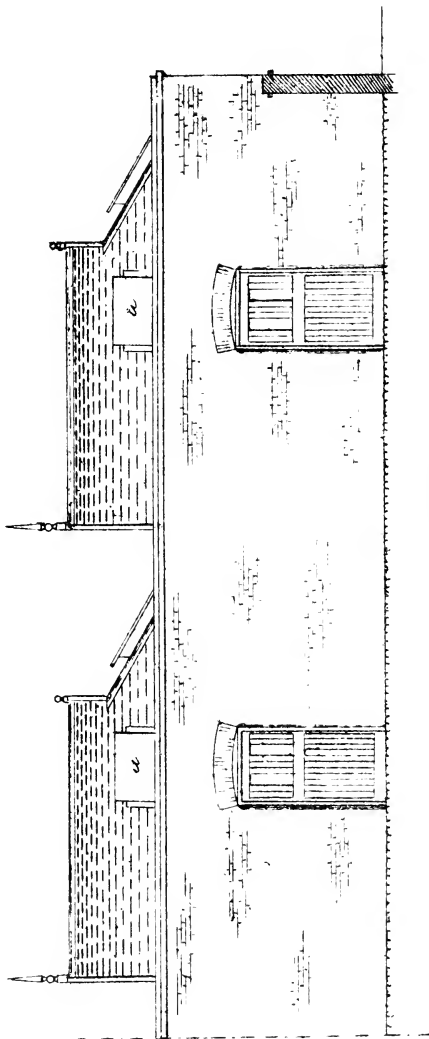

Elevation of Stables

1.

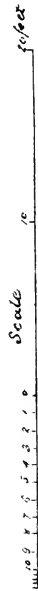

LONDON GENERAL OMNIBUS COMPANYS STABLES.
LOOSE BOXES & SURGERY.

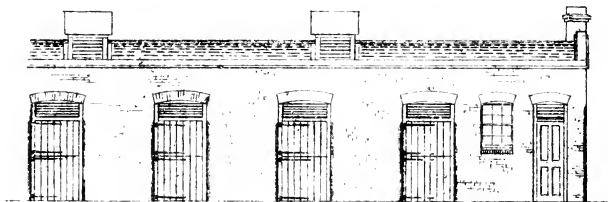

Elevation.

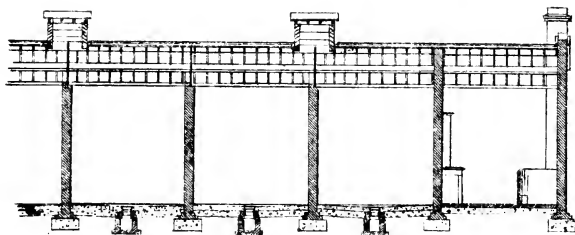

Longitudinal Section A. B.

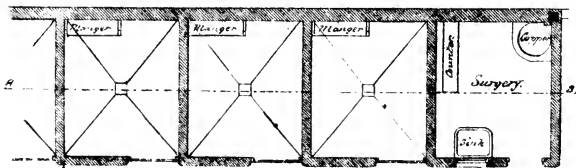

Plan.

Scale
0 2 4 6 8 10 20 feet

LONDON GENERAL OMNIBUS COMPANY'S STABLES.

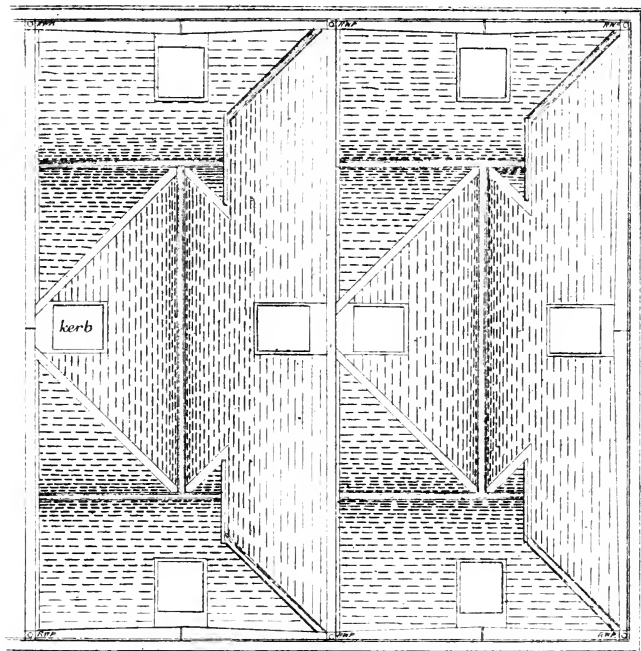

Plan of Roofs.

Scale. 10 feet.

NORTH LONDON TRAMWAYS.

HENRY VIGNOLES M.I.C.E. ENGINEER

BYNG GERRARD Architect.

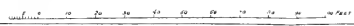
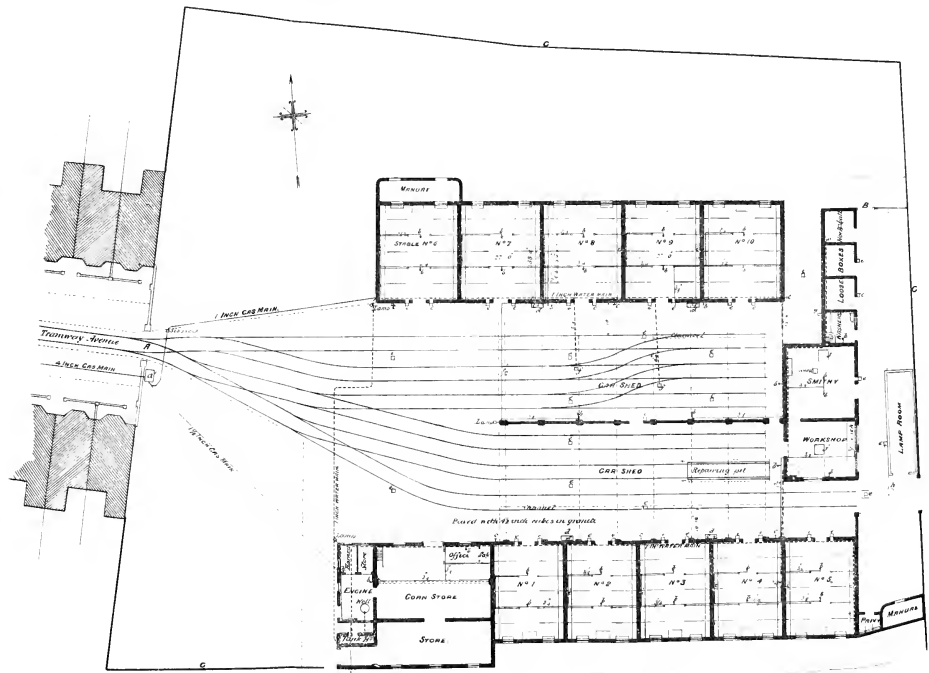

NORTH LONDON TRAMWAY STABLES.
Byz Giraud, Architect.

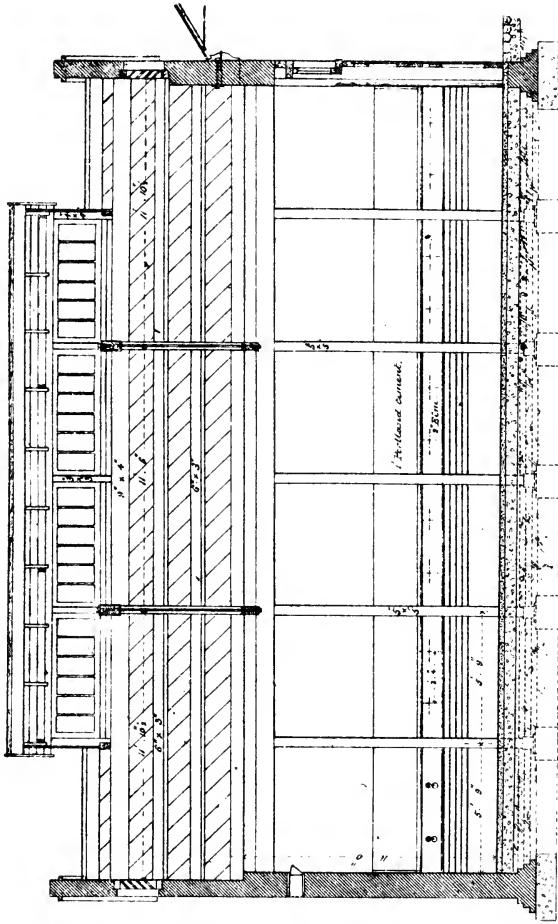

LONGITUDINAL SECTION.

10 feet.

NORTH LONDON TRAMWAY STABLES
Byng Graud, Architect.

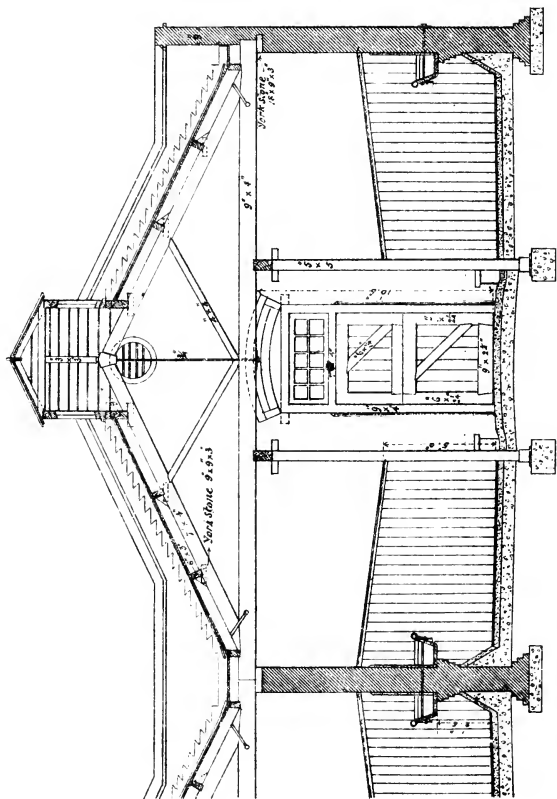

— TRANSVERSE SECTION. —

1 2 3 4 5 6 7 8 9 10 11 12 13 14 15 16 17 18 19 20 21 22 23 24 25 26 27 28 29 30 31 32 33 34 35 36 37 38 39 40 41 42 43 44 45 46 47 48 49 50 51 52 53 54 55 56 57 58 59 60 61 62 63 64 65 66 67 68 69 70 71 72 73 74 75 76 77 78 79 80 81 82 83 84 85 86 87 88 89 90 91 92 93 94 95 96 97 98 99 100

NORTH LONDON TRAMWAY STABLES.
Byng Giraud Architect.

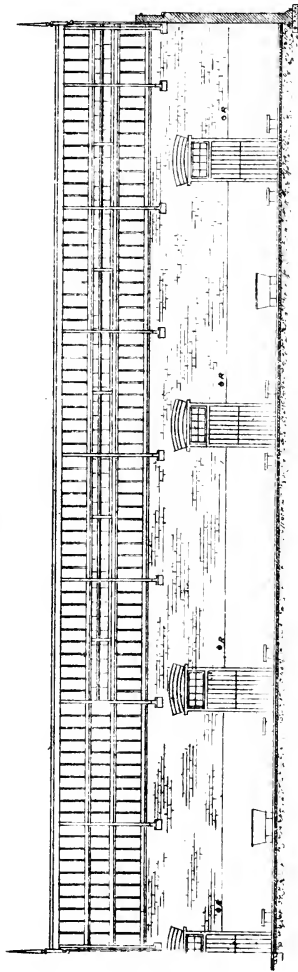

— ELEVATION LOOKING SOUTH. —

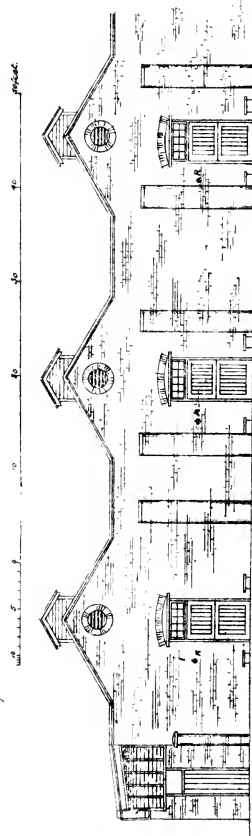

— ELEVATION LOOKING NORTH. —

IRON ROOF 40 feet Span.
Bying Girard & Archt.

FIG. 1.

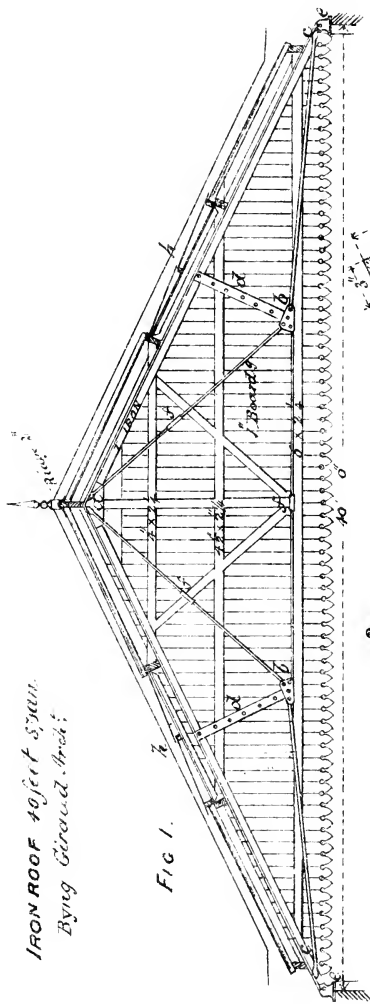

FIG. 2.

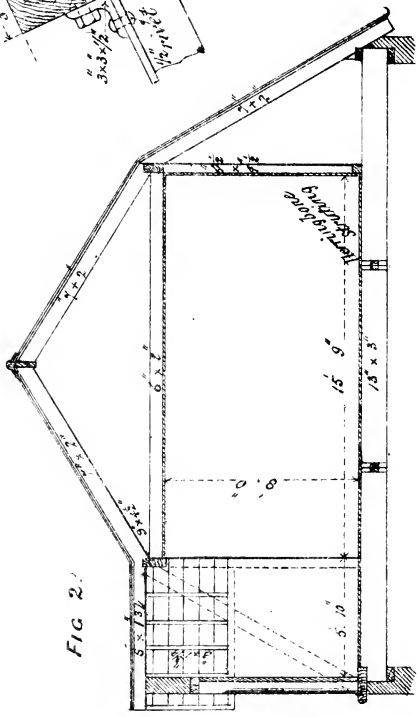
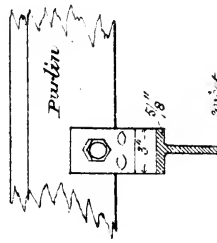
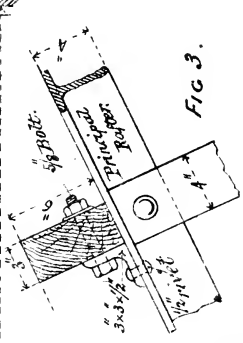
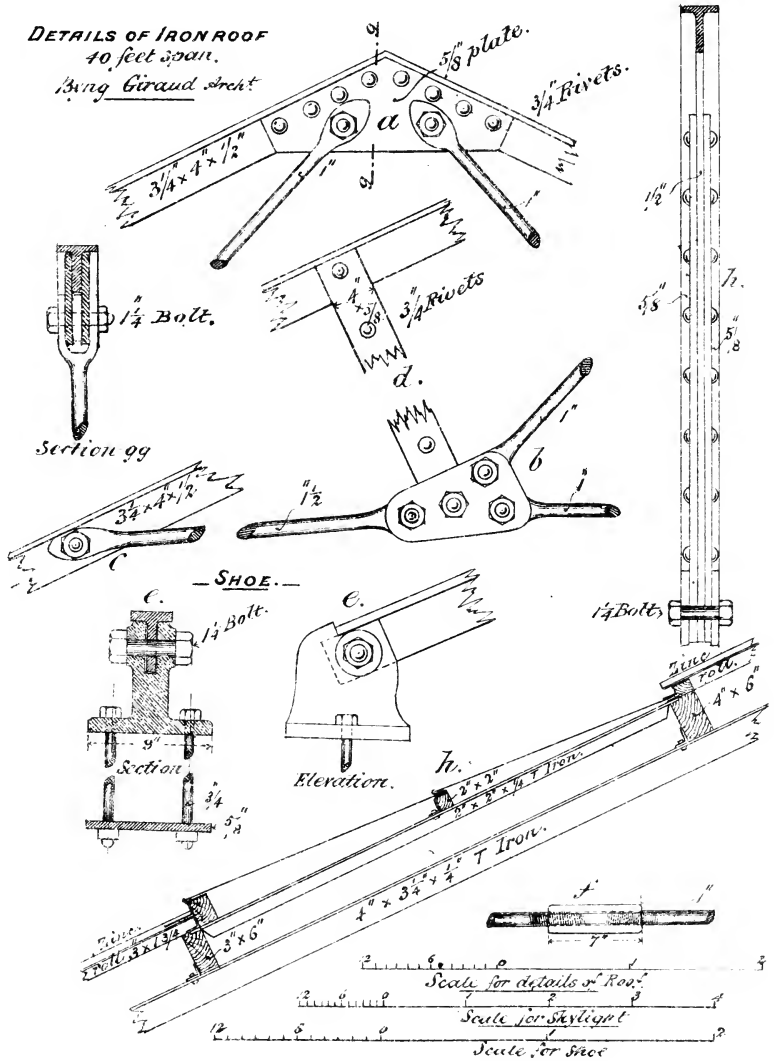

FIG. 3.



1 2 3 4 5 6 7 8 9 10

DETAILS OF IRON ROOF
40 feet span.
By Giraud Arch't



NORTH LONDON TRAMWAY STABLES.

Byng Giraud, Architect.

SMITHY.

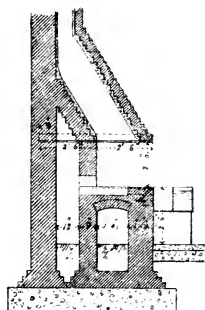

Longitudinal Section

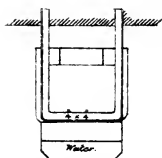

Plan at A.B.

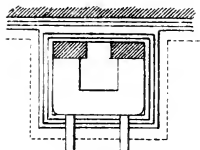

Plan at C.D.

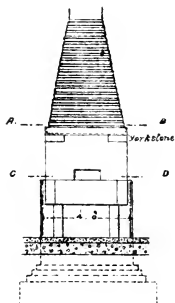

Elevation

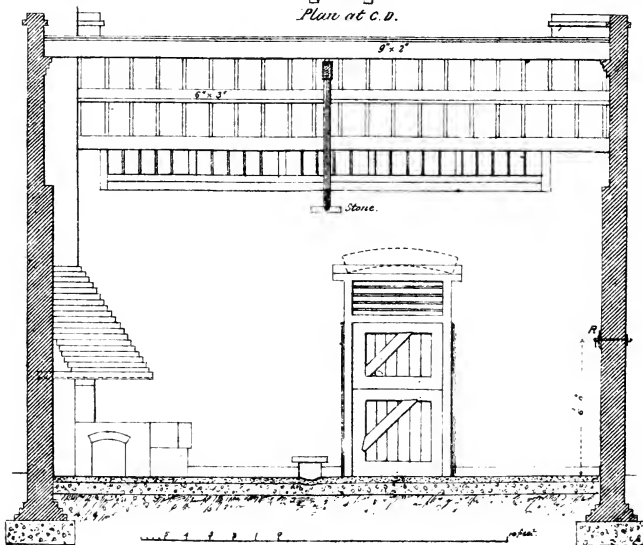

NORTH LONDON TRAMWAY STABLES.

Byng Giraud, Architect.

SMITHY.

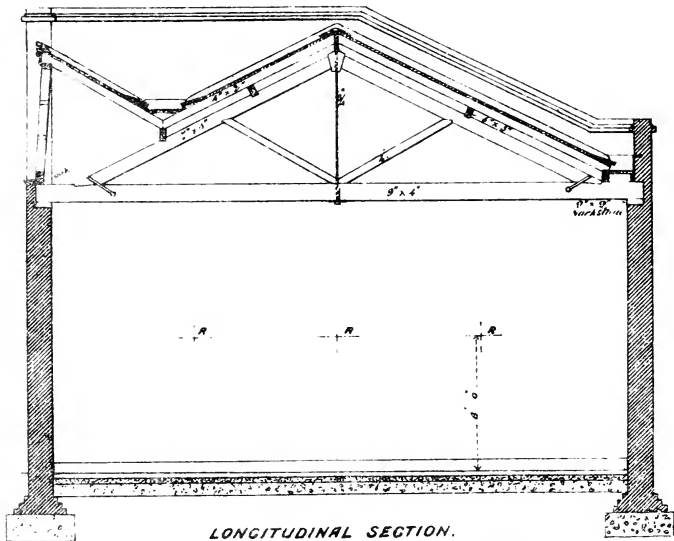

LONGITUDINAL SECTION.



FIG 1

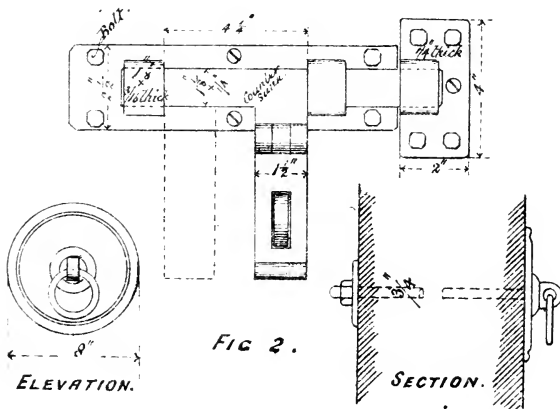

FIG 2.

ELEVATION.

SECTION.



DRESSING RINGS AT R

NORTH LONDON TRAMWAY STABLES. *Byng Giraud, Architect.*

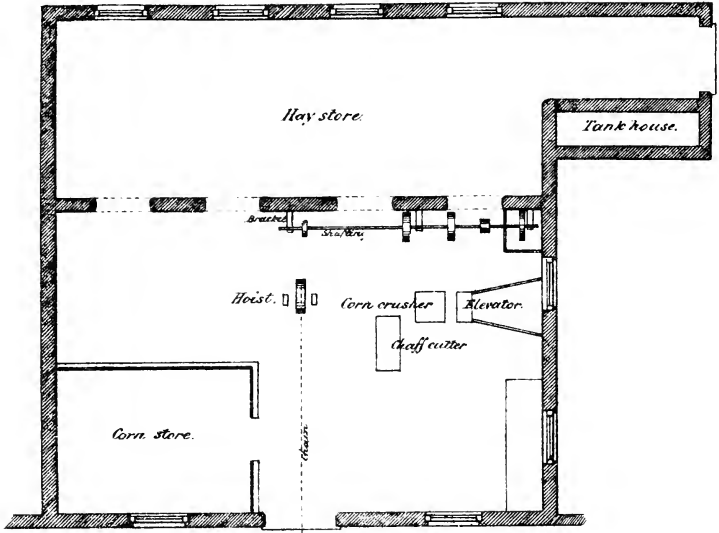

FIRST FLOOR.

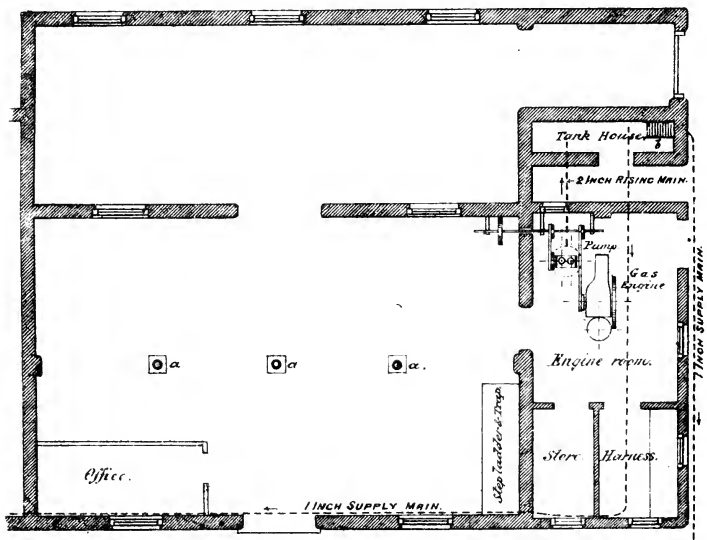

GROUND FLOOR.

NORTH LONDON TRAMWAY STABLES.

Byng Giraud, Architect.

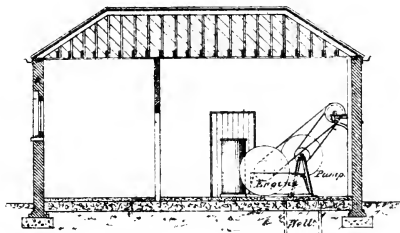

LONGITUDINAL SECTION THRO' ENGINE HOUSE

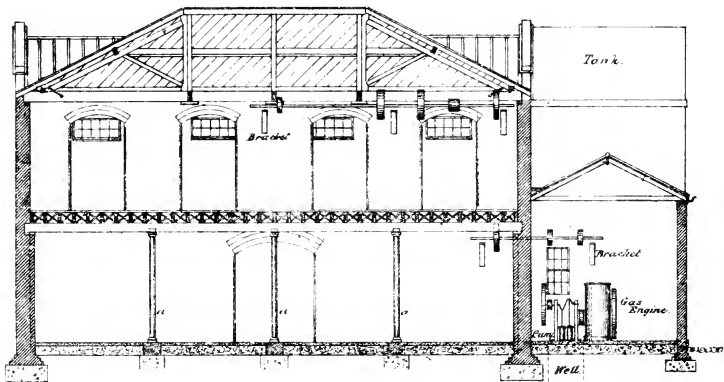

LONGITUDINAL SECTION THRO' CORN STORE.

ENGINE HOUSE.

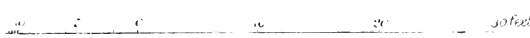

DRAINAGE.

NORTH LONDON TRAMWAY STABLES.
Byng Giraud Archt^s

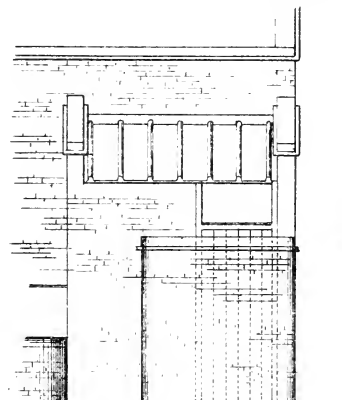

ELEVATION

Mens closet.

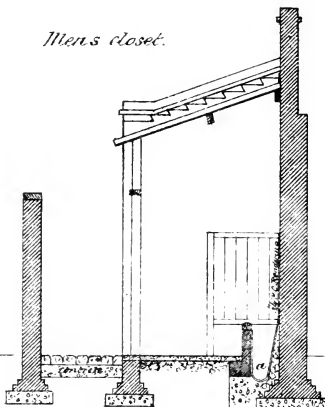

TRANSVERSE SECTION

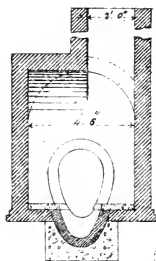

Man hole (A)

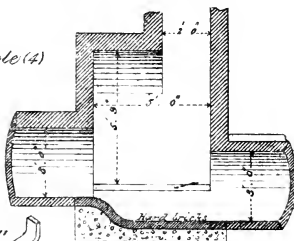

Foot iron

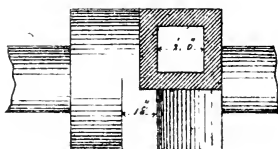
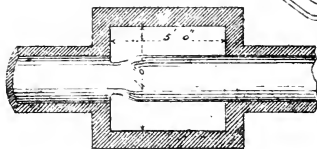

INS 12 0 1 2 3 4 5 6 7 8 9 10 ft

CAMBRIDGE TRAMWAY STABLES.

THOMAS FLOYD Engineer

BYNG CIAAUD Architect.

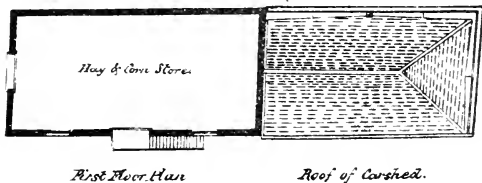
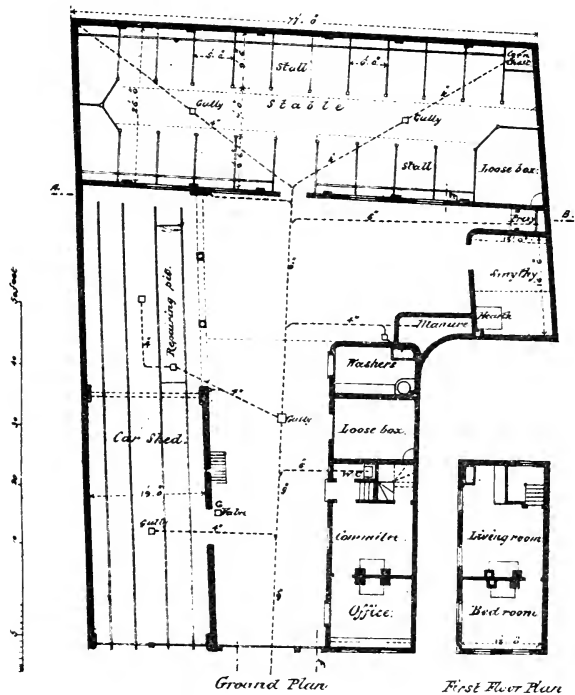

CAMBRIDGE TRAMWAY STABLES.

Byna Giraud, Architect.

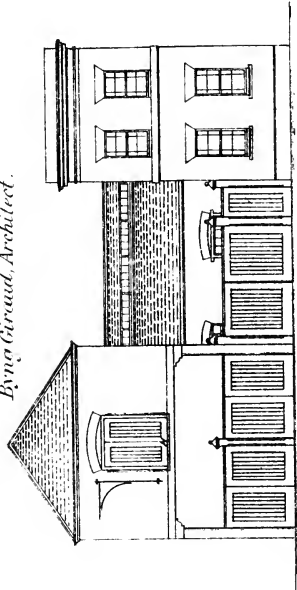

— ELEVATION TO ROAD. —

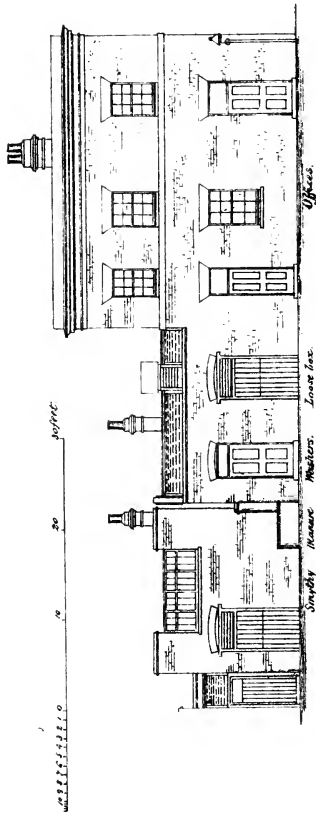

ELEVATION TO YARD.

CAMBRIDGE TRAMWAY STABLES.
H. Giraud, Architect.

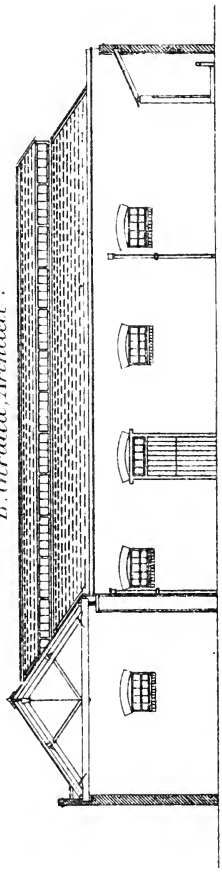

SECTION OF CARSHED.

ELEVATION OF STABLE LINE A.B.

Scale.
0 10 20 30
feet

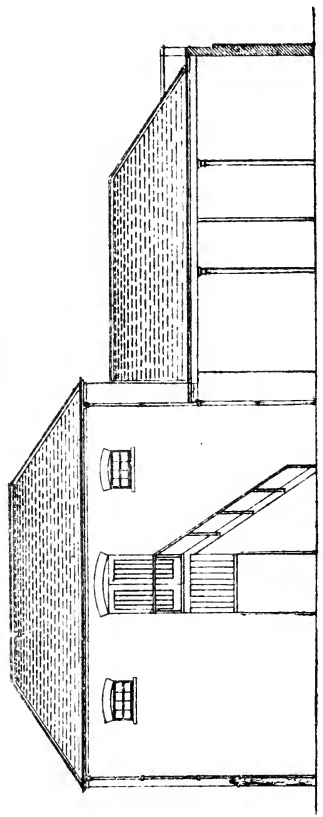

ELEVATION OF CORNSTORE & CARSHED.

SOUTHAMPTON TRAMWAY STABLES, PORTSWOOD.

Byng Giraud, Architect.

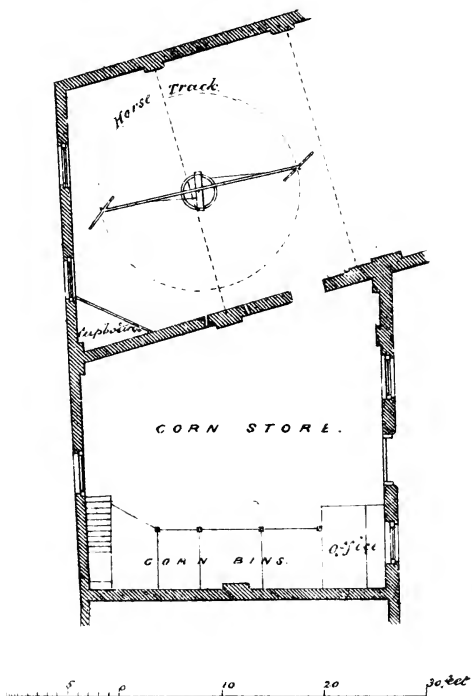
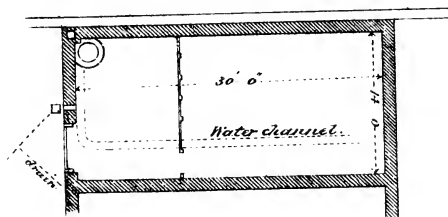

CORN STORE.

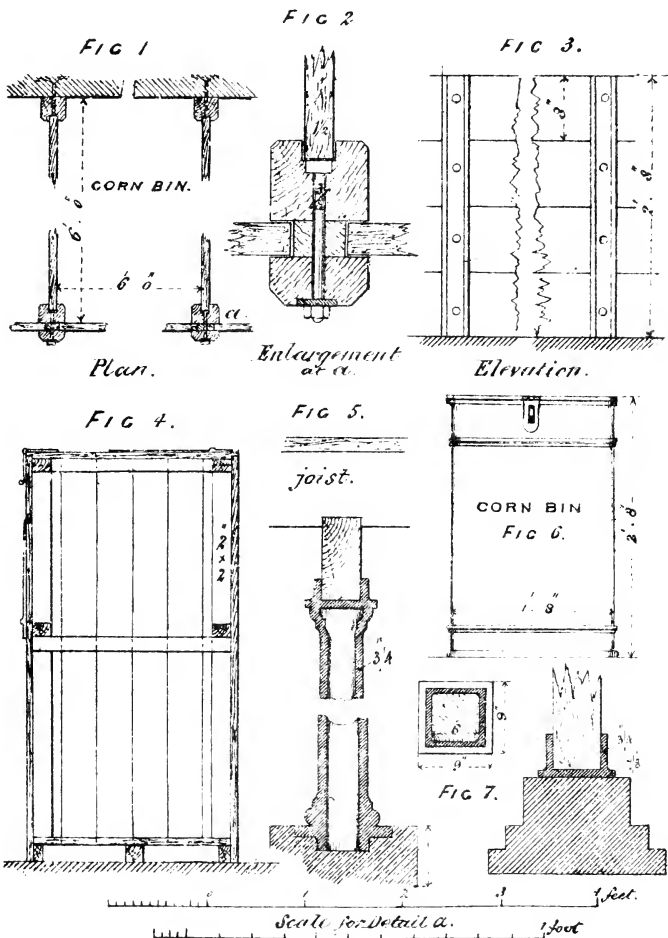

MESS^{RS} CROSSE & BLACKWELL'S STABLES.

THE LATE R. C. ROUMIEU ARCHT

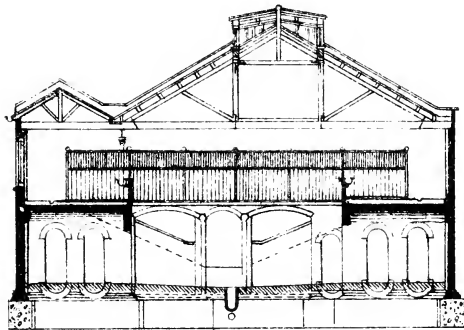

SECTION A. B.

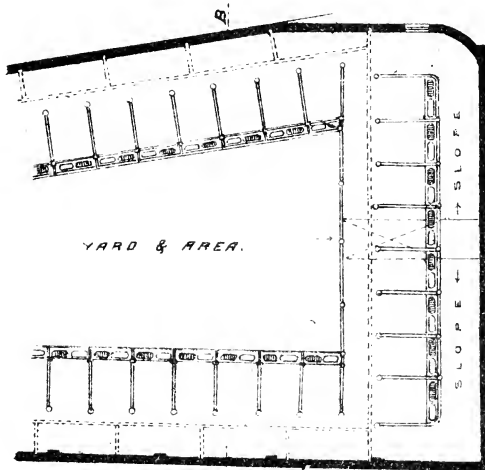

FIRST FLOOR.

10 5 0 10 20 30, etc.

COLONEL FITZWYGRAM'S DESIGN.

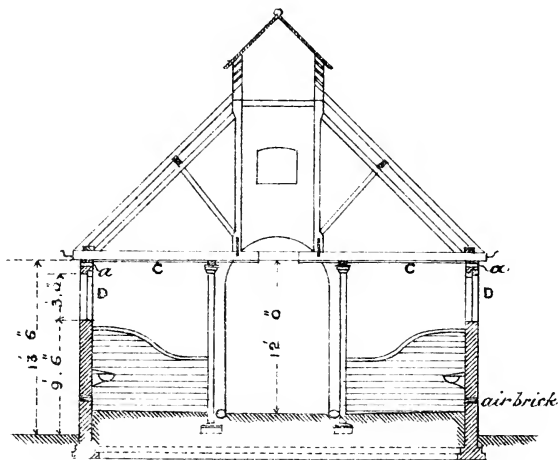

SECTION A. B.

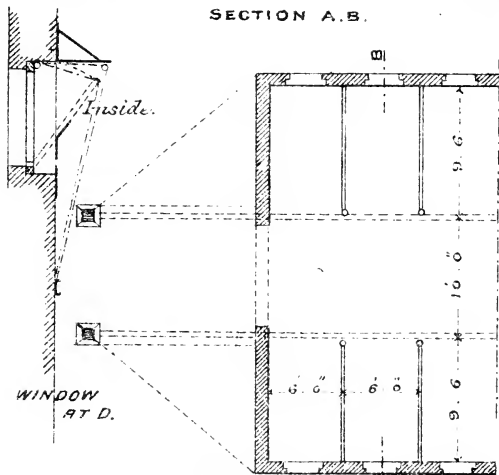

PART PLAN.



Webster Family Library of Veterinary Medicine
Cummings School of Veterinary Medicine at
Tufts University
200 North College Street
Medford, MA 02155

PAYING FOR STABLES, &c.

“ADAMANTINE CLINKER,” REGD. GOLD AND SILVER MEDALS.

This Paving is supplied to Her Majesty, H.R.H. Prince of Wales, and other Members of the Royal Family; also to the principal Nobility of this, and foreign countries.

Clinkers are supplied, direct from Works, or by the leading Stable Fitters and Builders' Merchants.

CAUTION.—As there are spurious articles in the market, all genuine Clinkers are stamped “Adamantine Clinker, Regd.”

TOWERS & WILLIAMSON,
ADAMANTINE CLINKER WORKS,
LITTLE BYTHAM, GRANTHAM.
WORKS ESTABLISHED 1850.

*Fourth Edition, revised and enlarged, Royal 8vo, cloth, Price 10s. 6d.;
nett, 8s 6d.; or 9s. post-free.*

THE PLUMBER AND SANITARY HOUSES :

A PRACTICAL TREATISE ON THE
PRINCIPLES OF INTERNAL PLUMBING WORK,
OR THE BEST MEANS FOR EFFECTUALLY EXCLUDING NOXIOUS GASES FROM OUR HOUSES.
WITH A CHAPTER ON COWL TESTING.

By **S. STEVENS HELLYER.**

With 27 Lithographic Plates, and 262 Illustrations in the Text.

“The best treatise existing on Practical Plumbing.”—*The Builder.*

“The book is one with which every Architect and Builder, and we might say every Householder should become conversant.”—*The Engineer.*

“The most complete English Treatise published.”—*The Building News.*

“Unquestionably the best Manual of Plumbing Practice.”—*The Sanitary Engineer.*

“A valuable practical work on everything relating to Plumbing work within the House.”—*The Lancet.*

PUBLISHED BY
B. T. BATSFORD, 52, High Holborn, London.

PRACTICAL WORKS for the use of Architects, Surveyors, Builders, &c. Published by B. T. BATSFORD, 52, High Holborn, London.

Estimating; a method of Pricing Builders' Quantities for Competitive Work without the use of a price book. By a Practical Estimator. Second Edition, carefully revised. Crown 8vo, cloth. Price 6s. 6d.; nett 5s. 6d.

Repairs; How to measure and value them in Competition. A Handbook for the use of Builders, Decorators, &c. By GEORGE STEPHENSON, Author of 'Estimating.' Crown 8vo, cloth. Price 3s. 6d.; nett 3s.

"We recommend all young men in the Building Trades who are likely to be called upon to do any estimating, to obtain this little book and make it their pocket *vade-mecum*."—*Illustrated Carpenter and Builder.*

The Orders of Architecture—Greek, Roman, and Italian. Selected from Normand's Parallels and other Authorities. With 3 New Plates, specially prepared for this work. Edited with Notes by R. PHENÉ SPIERS. 20 Plates. Folio, cloth. Price 10s. 6d.; nett 8s. 6d.

A Treatise on Shoring and Underpinning, and generally dealing with Dangerous Structures. By CECIL HADEN STOCK. With numerous Illustrations on 10 lithographic plates. Demy 8vo, cloth. Price 4s. 6d.; nett 3s. 9d.

Examples of Iron Roofs of all Designs and Spans up to 75 feet. With Complete Details, Weights, and Diagrams of Strains for each Principal. Simplified and Tabulated for the use of Architects, Engineers, and Students. By THOMAS TIMMINS, C.E. 4to, cloth. Price 12s. 6d. nett.

"A very useful work for the architect and engineer. We can commend the work, and very specially to Students."—*British Architect.*

Strains in Structures; A Text Book for Students. By G. A. T. MIDDLETON, Associate R.I.B.A. Illustrated by 89 Diagrams. Crown 8vo, cloth. Contents:—I. Loads on Supports—II. Shearing Stresses in Cantilevers and Beams—III. Stresses in Flanges—IV. Rectangular Beams—V. Method of Designing a Wrought-Iron Girder—VI. Columns and Struts—VII. Framed Cantilevers—VIII. Framed Beams and Girders—IX. Roofs, Dead Load only—X. Roofs, Wind Pressure and Combined Loads. Price 4s.; nett 3s. 4d.

APPROVED BY THE SCIENCE AND ART DEPARTMENT.

Building Construction and Drawing (Elementary Stage, Part I.); specially adapted for the use of Students in Science and Technical Schools. Compiled by CHARLES F. MITCHELL (Lecturer on Building Construction and Technical Carpentry and Joinery). Revised by the Technical Teachers of the Polytechnic Institute, Regent Street. With 550 Illustrations, fully dimensioned. Second Edition, revised. Crown 8vo, cloth. Price 3s.; nett 2s. 6d.

MR. BANISTER FLETCHER'S TEXT BOOKS FOR ARCHITECTS & SURVEYORS.

Arranged in Tabulated Form, and fully indexed for ready reference.

Quantities. Fifth Edition, revised and enlarged. Containing the following Supplementary Chapters:—Cubing—Forms of Fair Bills—Priced Schedules—The Law—and examples of the "taking off" of Bricklayer of the entire Front, and also of every Trade for the Drawing Room in the same Villa. With 5 lithographic plates, comprising elevation, 2 sections, and 2 plans. Crown 8vo, cloth. Price 6s.; nett 5s.

The Metropolitan Building Acts; comprising the principal Acts, and the latest Amendment Acts, Rules, Orders, &c., giving the most recent legal decisions, and illustrated with 22 coloured plates, showing the thickness of walls, plans of chimneys, &c., &c. Also, Part I. of the Act, in tabulated form, for easy reference. Crown 8vo, cloth. Price 6s. 6d.; nett 5s. 6d.

Dilapidations. Third Edition, much enlarged, with all the most recent Legal Cases and Acts. The legal portion revised by E. UTTERMARE BULLEN, Esq., Barrister-at-Law. Crown 8vo, cloth. Price 6s.; nett 5s.

Light and Air; with Methods of Estimating Injuries, Reports of most recent Cases, &c. Second Edition, revised and enlarged. With 17 coloured diagrams, &c. The legal portion revised by E. UTTERMARE BULLEN, Esq., Barrister-at-Law. Crown 8vo, cloth. Price 6s. 6d.; nett 5s. 6d.

