

NOAA Technical Memorandum NMFS

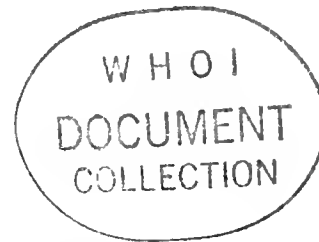

July 1981



**STATUS REPORTS ON
WORLD TUNA AND BILLFISH STOCKS**

NOAA-TM-NMFS-SWFC-15

U.S. DEPARTMENT OF COMMERCE
National Oceanic and Atmospheric Administration
National Marine Fisheries Service
Southwest Fisheries Center

MBL/WHOI



0 0301 0040912 4

NOAA Technical Memorandum NMFS

This TM Series is used for dissemination and timely communication of preliminary results, interim reports, or special purpose information, and have not received complete formal review, editorial control, or detailed editing.



July 1981

**STATUS REPORTS ON
WORLD TUNA AND BILLFISH STOCKS**

Presented at

**TUNA RESEARCH WORKSHOP
San Clemente, California
December 15-17, 1980**

NOAA-TM-NMFS-SWFC-15

National Marine Fisheries
Southwest Fisheries Center
La Jolla, California 92038

U.S. DEPARTMENT OF COMMERCE
Malcolm Baldrige, Secretary

National Oceanic and Atmospheric Administration
Dr. John V. Byrne, Administrator

National Marine Fisheries Service

William H. Stevenson, Acting Assistant Administrator for Fisheries

TABLE OF CONTENTS

	<u>Page</u>
Introduction	2
A Synopsis of the Tuna and Billfish Status of Stocks Report. . .	5
STATUS OF STOCKS REPORT	
Atlantic Ocean	
Yellowfin tuna.	9
Bigeye tuna	34
Skipjack tuna	55
Southern albacore	78
Northern albacore	87
Indian Ocean	
Tunas	99
Billfishes.	118
Pacific Ocean	
Eastern tropical yellowfin tuna	143
Eastern tropical skipjack tuna.	163
Western skipjack tuna	182
Western yellowfin tuna.	196
Southern albacore	212
Northern albacore	228
Northern bluefin tuna	246
Swordfish	256
Striped, blue, and black marlins.	277
Appendix: List of Conference Attendees.	301

INTRODUCTION

The National Marine Fisheries Service's Southwest Fisheries Center's (SWFC) second Workshop on Tuna and Billfish Research was held at the San Clemente Inn, San Clemente, California, on December 15-17, 1980. This report summarizes the results of that workshop and reproduces the reports on the status of tuna stocks that were presented at the workshop.

A total of 26 persons participated in the meeting, including 24 from the SWFC and two from the NMFS Office of International Affairs. A list of attendees and their organizational affiliation is given in the Appendix. David Mackett, Planning Officer for the SWFC, was the Workshop Coordinator.

The purpose of the Workshop was to review the situation regarding a number of tuna and billfish stocks of importance to the U.S. and to improve the Center's near-term and long-range research plans. Before the Workshop began, 16 Status Reports written by SWFC staff and collaborators, covering some 25 different species or stocks of Atlantic, Pacific, and Indian Ocean tuna and billfish, were distributed to the participants. These reports give a short description of the fishery, present an overview of the nature and degree of U.S. and foreign interest in the fishery, and discuss the current status or condition of the stocks. Recommendations for further analyses, data collection, or research programs regarding the fishery are also given. The Status Reports include most of the world's tuna stocks of direct and indirect interest or importance to the U.S. commercial and recreational fishermen, canning industry, and consumers. The full reports are presented in this document.

Authors presented highlights of their reports to the Workshop participants and questions and comments were solicited from the group. In addition to the Status of Stocks Reports, the Director of the Office of International Fisheries Affairs presented an overview of the status of international tuna fishery problems and the state of international and bilateral negotiations concerning them. On the basis of the reports, presentations, discussions, and rapporteurs' summaries, the Center Director, Honolulu Laboratory Director, and the Chief of the Oceanic Fisheries Resources Division (OFRD), meeting as the Tuna Program Board (TPB), made a number of decisions regarding future SWFC program emphasis and direction. These decisions were discussed in the Workshop and subsequently assignments were given to SWFC staff for completing and documenting the work plans¹.

The Workshop concentrated on the stock assessment and fishery evaluation aspects of the Center's tuna research program, but some time also was devoted to a discussion of the tuna-environment interaction

¹The first Workshop was held September 11, 1979, at the same location.

studies. The presentations and discussions were held in the context and framework shown in Figure 1, which depicts the elements contributing to the overall goal of the Center's tuna research program, i.e., the delivery of tuna resource management information and advice to NMFS, Department of State, U.S. Commissioners of international commissions, U.S. delegates and negotiators participating in bilateral or international negotiation missions, and fisheries managers in both the international and national arenas.

SWFC TUNA PROGRAM: FUNCTIONAL MODEL

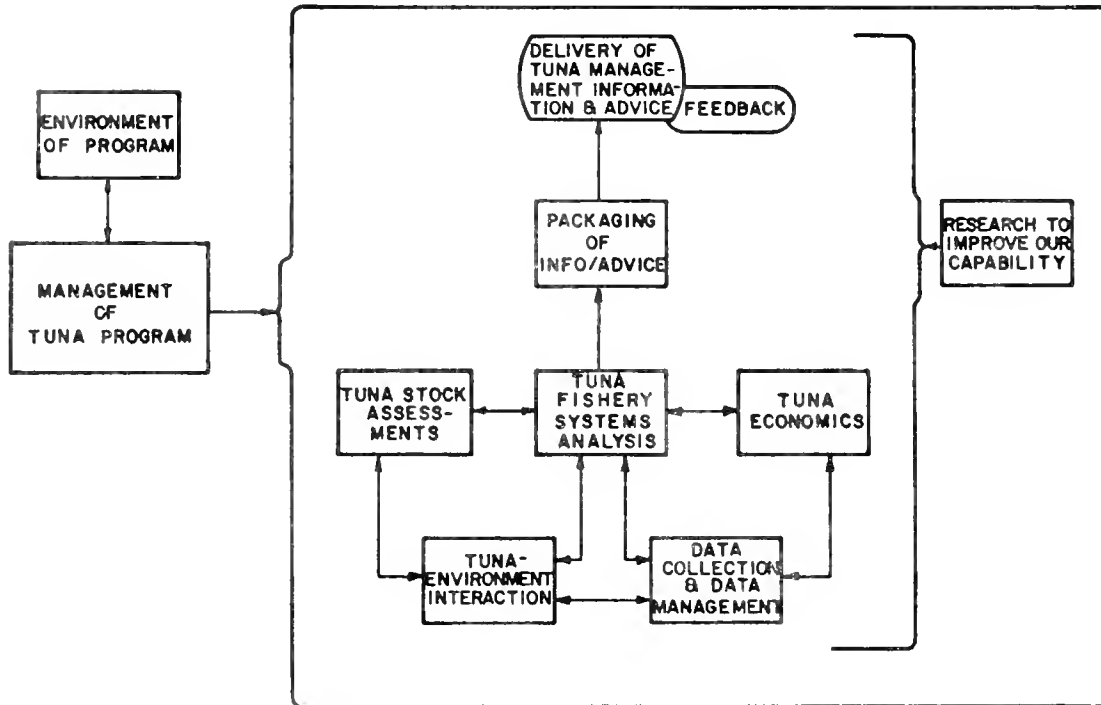

Figure 1. The SWFC's Tuna Program is geared to the delivery of tuna management information and advice to U. S. Commissioners and U.S. negotiators. Several functions must be performed to deliver the information required for good management decisions; these functions include stock assessments, economic analysis, data management, analysis of fish environment interactions and a system analysis function that ties the specialized information together. Research in any or all elements may be required to improve overall quality; management of the program, because of its diversity and complexity, is given special consideration.

A SYNOPSIS OF THE TUNA AND BILLFISH STATUS OF STOCKS REPORTS

The current evaluation of the status of tuna stocks and tuna fisheries is based on a large number of foreign and domestic data sources, and analyses performed by NMFS scientists or by international or foreign fishery agencies. Many of the evaluations presented here are the results of international fishery workshops in which NMFS/SWFC scientists participated. Expert judgement is required in choosing the analytical techniques to be applied and in interpreting the results; therefore, care has been taken in setting forth the results of each analysis in order to indicate its reliability and to point out where weaknesses in the data or techniques may exist. This is especially indicated in light of possible discrepancies in the data or inconsistencies in the outcome or conclusions of similar analyses.

The papers presented herein summarize the available information and conclusions to be drawn for some 25 species or stocks of the world's tuna and billfish. In several cases it is not known whether a species is represented by a single breeding population or by two or more separately breeding stocks. Whenever prevailing opinion or overwhelming evidence is present to strongly suggest the presence of separate stocks, we have separated the analyses and results accordingly and presented these in separate papers, e.g., south and north Atlantic albacore. However, in some cases where there is some evidence to suggest that two or more stocks of the same species may be present, or where it is of interest to investigate the hypotheses of separate stocks, we have performed the analyses under both the single and multiple stock hypotheses (if sufficient data exist) and have presented the results in a single paper, e.g., Pacific swordfish or Atlantic skipjack.

A summary of the reasonable conclusions to be drawn from the current status of stocks is given in Table I. Each species or stock is evaluated in terms of whether or not catches could be increased by (1) simply increasing the effort expended, or (2) instituting certain management measures. These overly simplified categories are modified somewhat by the information presented in the matrix. (NOTE: The reader should be cautioned that, in order to give a quick overview, most of the qualifying remarks about the reliability of these conclusions have been stripped from the original text as it was lifted from the detailed status of stock papers and placed in the table.)

The question arises as to why the SWFC performs tuna stock assessments and fishery evaluations when the U.S. fishery seems to be relatively healthy economically and opportunities for tuna fishery development are fairly well identified. Often a remark about the difficulty and uncertainty of success of international negotiations accompanies the question.

The answer to why this work is required lies in the analysis and comparison of (1) the tuna fisheries' value to the United States, (2) the

Table 1.
 Conclusions to be Drawn from the Status of Tuna Stocks
 Concerning the Level of Annual Sustainable Catches
 Relative to Current Effort and Possible
 Management Measures

Species/Stock/Fishery	Catch at or near MSY with about optimum effort being expended under current fishery management	Increase in catch likely with an increase in effort	Increase in catch likely with change in management provisions
<u>ATLANTIC OCEAN</u>			
Yellowfin	Catch near MSY especially in eastern Atlantic	Eastern Atlantic, no; western Atlantic, possibly with increased surface effort	Uncertain
Bigeye	No	Yes, an annual 11,000 to 80,000 mt increase is likely	Some increase to be expected with increase in age of first capture
Skipjack	Unknown	Yes, MSY cannot be calculated but information suggests potential yield higher than current catch especially in western Atlantic.	Unknown
Albacore, S. Atlantic	—	Yes, increases of from 6,000 to 10,000 mt seems possible	No, yield-per-recruit already high at 7.7 kg for long-line
Albacore, N. Atlantic	Near MSY with current age structure of catch	Small increase in average annual catch likely with increased effort, but recruitment highly variable so probably not prudent to increase effort substantially	Yes, but only with severe restrictions on surface fisheries
<u>INDIAN OCEAN</u>			
Albacore	Appears fully exploited	—	—
Bigeye	Unknown	Lightly exploited, but actual potential unknown	—
Yellowfin	Longline catch appears to be at maximum	Yes, especially by surface fisheries	—
Skipjack	?	?	?
Blue marlin	—	—	Possibly, but there may be errors in total catch estimates which would affect conclusion
Striped marlin	—	Some small increase appears possible	—
Black marlin	Appears to be fully or over-exploited	—	Unknown
Swordfish	—	Increase in catch appears likely	—
Sailfish	—	Yes, potential yield much higher than maximum annual catch thus far	—
<u>PACIFIC OCEAN</u>			
Yellowfin, E. Pacific	No, recent catches and effort above MSY and optimum with current age structure	No	Yes, increasing the age of first capture would yield substantial improvements in total catch over time
Skipjack, E. Pacific	—	Increases in catch likely with increased effort, especially if smaller fish are caught without affecting recruitment	—
Yellowfin, W. Pacific	Yes, especially for longline	Some increase in surface fishery catches possible; total yield may increase	—

Table 1. (cont.)

Skipjack, W. Pacific		Stock appears under-exploited	—
Albacore, S. Pacific	Currently about 25 below MSY	Yes, may be feasible with expansion of surface fishery	Possible to reduce long-line effort substantially with little reduction in catch.
Albacore, N. Pacific	Substantial gains unlikely with fishery in present configuration of longline and surface effort	-	Potential increases possible, currently being evaluated
Bluefin, N. Pacific	-		Western Pacific-eastern Pacific catches have declined substantially but at present cause and therefore cure are unknown. Analyses will be performed
Swordfish	Recent catches are near MSY	-	Fishery Management Plan (FMP) being developed under Pacific and Western Pacific Fishery Management Councils. Preliminary Fishery Management Plan (PMP) in effect
Blue marlin	No	No	Unknown, stock appears "overfished"
Black marlin	Appears fully exploited	Possibly, but large increases probably not sustainable	Unknown
Striped marlin	Catches near MSY	Modest increases in effort may increase yield on Pacific-wide basis	Unknown

existing and potential threats to diminishing that value seriously, and (3) the costs of developing and using information and analysis to preserve that value and to mitigate or avoid problems.

First, let us investigate the value of tuna fisheries to the American citizen, consumer, worker, businessman, and taxpayer. Estimates put the total annual retail value to the United States (in the form of canned products of U.S. catches and foreign (whole) fish imports for canning) at \$1,288,000,000 - nearly \$1.3 billion annually.

The existing and potential threats to the maintenance of this \$1.3 billion annual value to the U.S. are varied and complex. This value, which is based on a living renewable resource, is threatened with diminution from inadvertent or willful overfishing by foreign or domestic fisheries - perhaps in pursuit of small short-term gains at great long-term costs to future Americans. Major threats to preserving this value can occur if U.S. fishermen are denied access to fishing grounds within the fishing or economic zones established by foreign countries - fish caught by U.S. fleets are an important factor in avoiding a "fish OPEC" situation. Similar threats to limit the world's total supply of tuna (which supports the U.S. supply of imported fish for processing in American canneries) can occur on a multi-national scale. Thus, the success of the tuna fisheries of Japan, Korea, and Taiwan are of interest to the U.S. as well. The fact is that all the tuna stocks and fisheries of the world are linked, if not by principles of nature and the biological responses of the tuna resource to fishing and environmental changes, then by the complexities of international economics, demographics, and markets on a global scale.

The U.S. tuna fishery - its supply, harvest, processing, and marketing - is carried out within the world-wide multi-national arena of foreign affairs. On the international scale, one cannot negotiate fishing access to foreign waters, negotiate international conservation measures, or negotiate for long-term larger annual benefits in place of smaller diminishing short-term gains without being prepared, and being prepared means being informed. Information about the world's tuna stocks and the world's tuna fisheries is vital to the effort to preserve the resource and the valuable U.S. tuna industry and its products for the benefit of all Americans.

The annual cost incurred by the SWFC in obtaining information on tuna resources and the fishery is \$1.2 million - about 15% of the Center's budget and less than one-tenth of one percent (0.01%) of the annual value of the U.S. fishery.

David J. Mackett
Workshop Chairman
Southwest Fisheries Center
La Jolla, California

STATUS REPORTS ON
WORLD TUNA AND BILLFISH STOCKS

STATUS REPORT: ATLANTIC YELLOWFIN TUNA

by

Atilio L. Coan, Jr.

Southwest Fisheries Center
Oceanic Fisheries Resources Division
La Jolla, California

ABSTRACT

The status of Atlantic yellowfin tuna stocks remained unchanged from 1979 to 1980. Production model analyses indicate that the stocks are being fished at high levels, especially in the eastern Atlantic. Increase in fishing effort with the fishery operating within its present geographical boundaries is unlikely to produce substantial gains in yield.

In 1973, a minimum size regulation was adopted for Atlantic yellowfin tuna to decrease fishing mortality on small fish and to increase yield-per-recruit (YPR). Analyses indicate that a slight increase in YPR has occurred for some fisheries since the adoption of the regulation. These gains may be less than predicted due to discarding of undersized fish.

Estimates of recruitment to the Atlantic yellowfin fishery have held relatively constant. Based upon these assessments, Atlantic yellowfin tuna stocks should be carefully monitored.

I. DESCRIPTION OF THE FISHERY

Atlantic yellowfin tuna are caught by multispecies fisheries located throughout the tropical regions of the Atlantic Ocean; skipjack and bigeye tunas are also caught. Three principal fishing methods are used in these fisheries: purse seine, baitboat, and longline. Analyses of Atlantic yellowfin tuna fisheries usually consider fisheries in two geographical regions: an eastern Atlantic fishery and a western Atlantic fishery, divided at 30° W longitude (Figure 1).

I.A. History of the Fishery

I.A.1. Eastern Atlantic Fishery

Baitboats from France and Spain started the eastern Atlantic surface fishery for yellowfin tuna in 1955 and purse seiners entered the fishery in the early 1960's. The longline fishery started in 1957 with the Japanese longline fleet. Currently, 14 countries participate in the eastern Atlantic surface fishery and 6 countries participate in the longline fishery.

The major participants in the eastern Atlantic fisheries are the French-Ivory Coast-Senegalese-Moroccan (FISM), Spanish, Korean/Panamanian, and U.S. fleets. These fleets caught 90% of the average eastern Atlantic yellowfin tuna catches during the period 1975 to 1979 (Figure 2a).

I.A.2. Western Atlantic Fishery

The yellowfin tuna fishery in the western Atlantic, started by the Japanese in the 1950's, is primarily a longline fishery. Catches are concentrated in areas off Brazil and Venezuela, with some catches in the Gulf of Mexico and off the U.S. east coast (Figure 1). Surface fisheries for yellowfin tuna in the western Atlantic have existed from time to time off Venezuela and off the U.S. east coast, but the catches have been small (highest reported catch is 5,000 mt).

The major participants in the western Atlantic fishery are Korea/Panama, Japan, Venezuela, Cuba, and the U.S. These fleets accounted for 88% of the total western Atlantic yellowfin catch during the period 1975 to 1979 (Figure 2b).

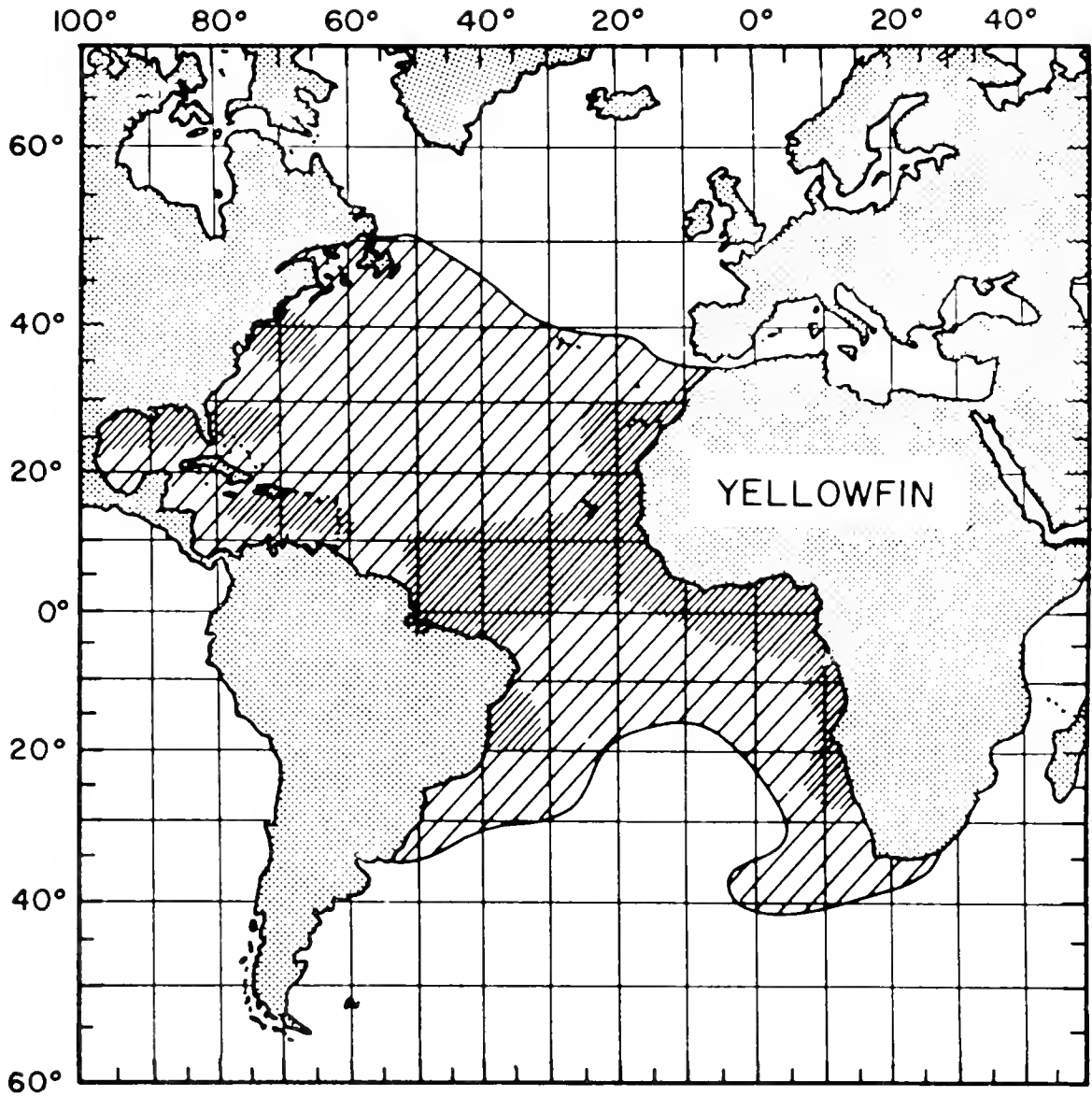
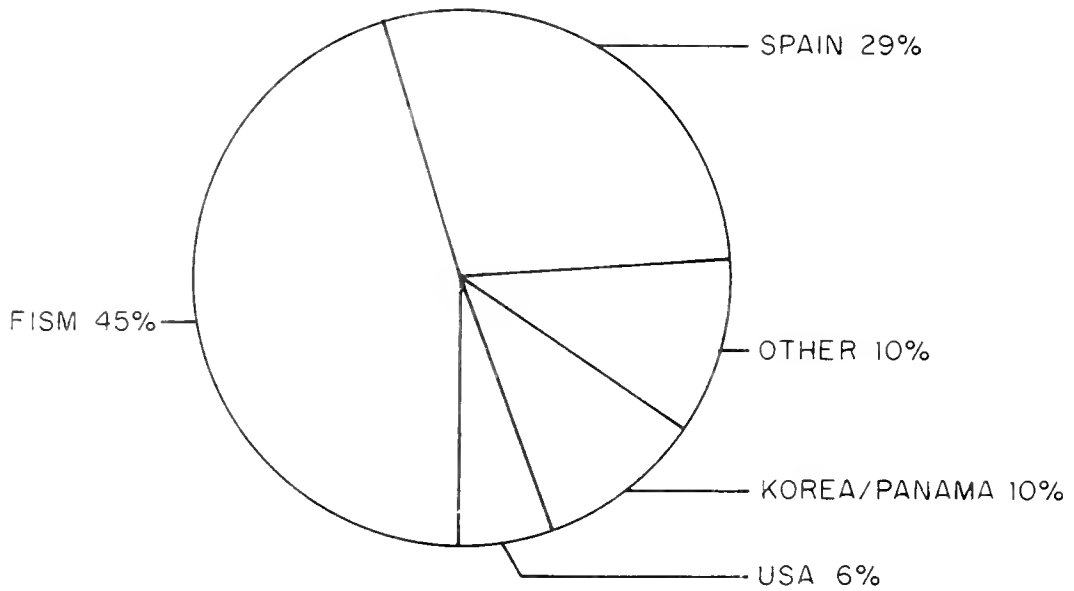

Figure 1. Areas of the Atlantic Ocean currently or historically fished for yellowfin tuna. Densely hatched areas indicate areas of greatest fishing intensity.

A



B

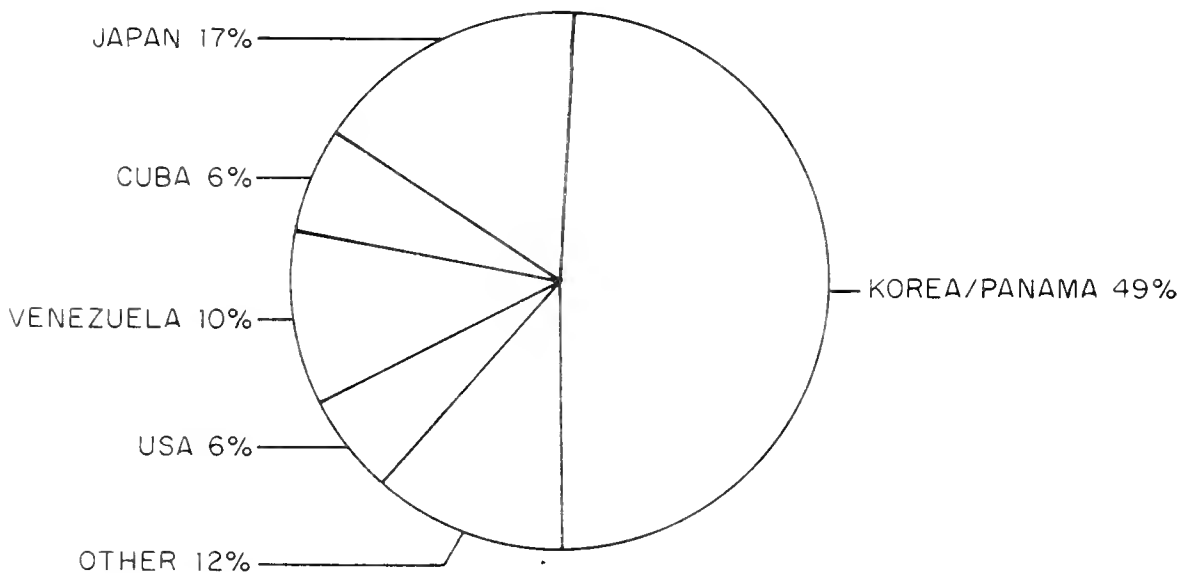

Figure 2. a) Major participants in the eastern Atlantic surface and long-line fishery for yellowfin tuna, 1975 to 1979.
b) Major participants in the western Atlantic surface and long-line fishery for yellowfin tuna, 1975 to 1979.

I.B. Trends in Catch and Effort

I.B.1. Eastern Atlantic Fishery

Catches of yellowfin tuna for the eastern Atlantic longline fishery peaked in 1973 at 25,000 mt, then decreased gradually to an estimated 5,000 mt in 1980 (Figure 3a). Surface fishery catches, in contrast, increased from 36,000 mt in 1966 to a record high of 110,000 mt in 1979. Estimated surface catches in 1980 decreased to 95,000 mt (preliminary estimates).

Estimated fishing effort for the eastern Atlantic longline fishery from 1967 to 1977 is shown in Figure 4a. Effort increased to a high of 91 million hooks in 1973, then decreased to 43 million hooks in 1977. Estimated fishing effort for the eastern Atlantic surface fishery from 1967 to 1979 was estimated by dividing the total eastern Atlantic surface yellowfin catch by catch-per-unit-effort for the FISM fleet, the major harvester (Figure 4b). Surface fishery effort increased from 8,000 standard days absence (SDA) in 1967 to 57,000 SDA in 1979.

I.B.2. Western Atlantic Fishery

Catches from the western Atlantic longline fishery have fluctuated between 7,000 mt and 15,000 mt during the period 1966 to 1980 (Figure 3b). Surface fishery catches have fluctuated from a high of 4,700 mt in 1978 to a low of 600 mt in 1976.

Estimated effort for the western Atlantic longline fishery increased from 25 million hooks in 1967 to 65 million hooks in 1973, then fluctuated between 46 and 58 million hooks from 1974 to 1977 (Figure 5). No estimates of surface effort are available for the western Atlantic.

I.C. Value of Catch

The 1979 U.S. average ex-vessel price for yellowfin tuna was \$893/mt for fish less than 3.2 kg and \$1,047/mt for fish greater than 3.2 kg. Based on an average price of \$970/mt, the value of the 1979 eastern Atlantic longline and surface yellowfin tuna catch (130,00 mt) was approximately \$126 million. The western Atlantic catch (11,100 mt) was worth approximately \$11 million.

A

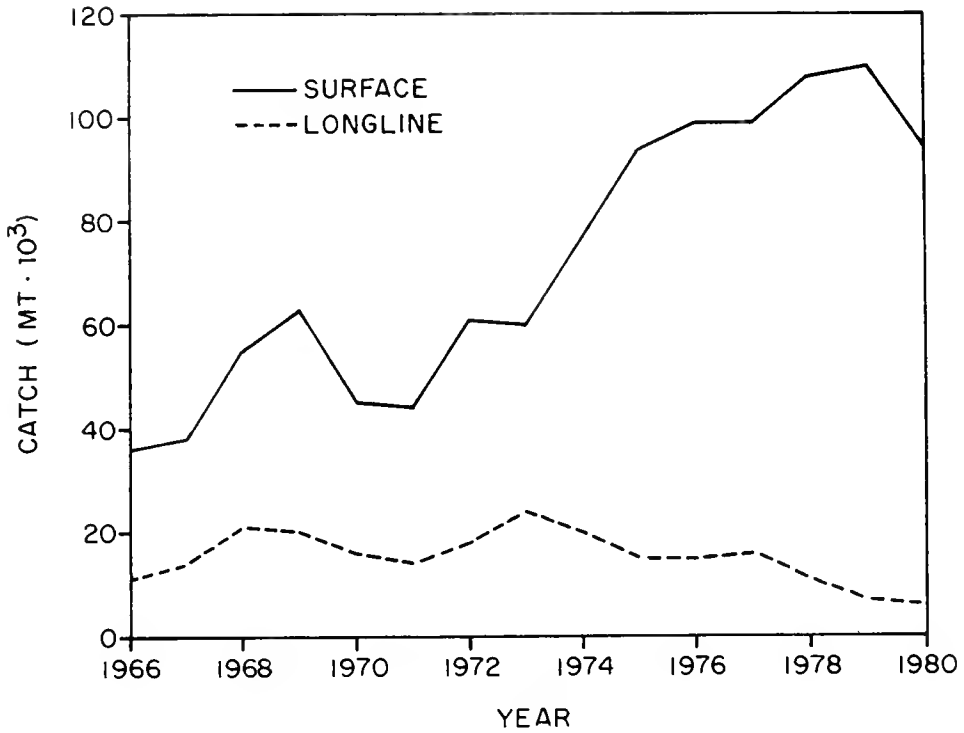

B

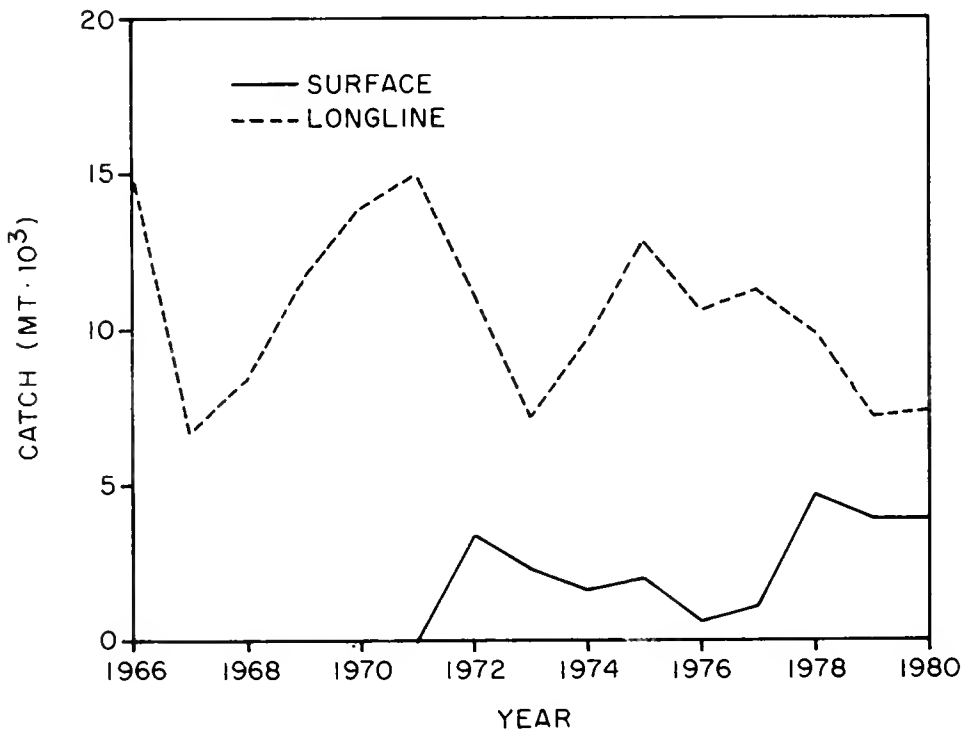

Figure 3. a) Total catch of yellowfin tuna using surface and longline fishing gear in the eastern Atlantic, 1966 to 1980.

b) Total catch of yellowfin tuna using surface and longline fishing gear in the western Atlantic, 1966 to 1980.

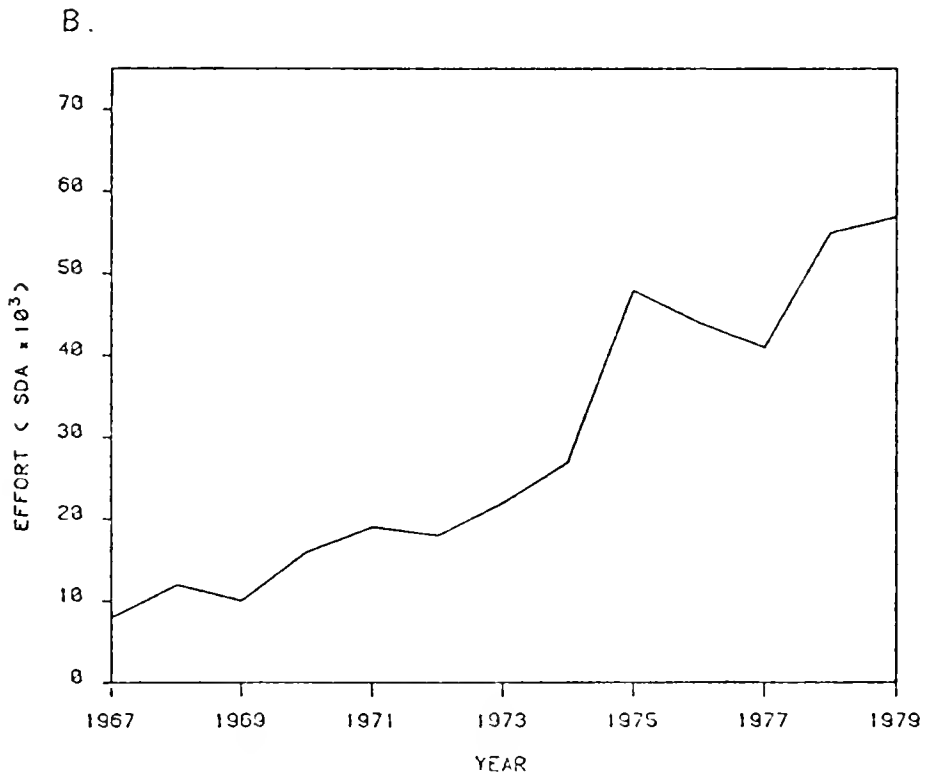
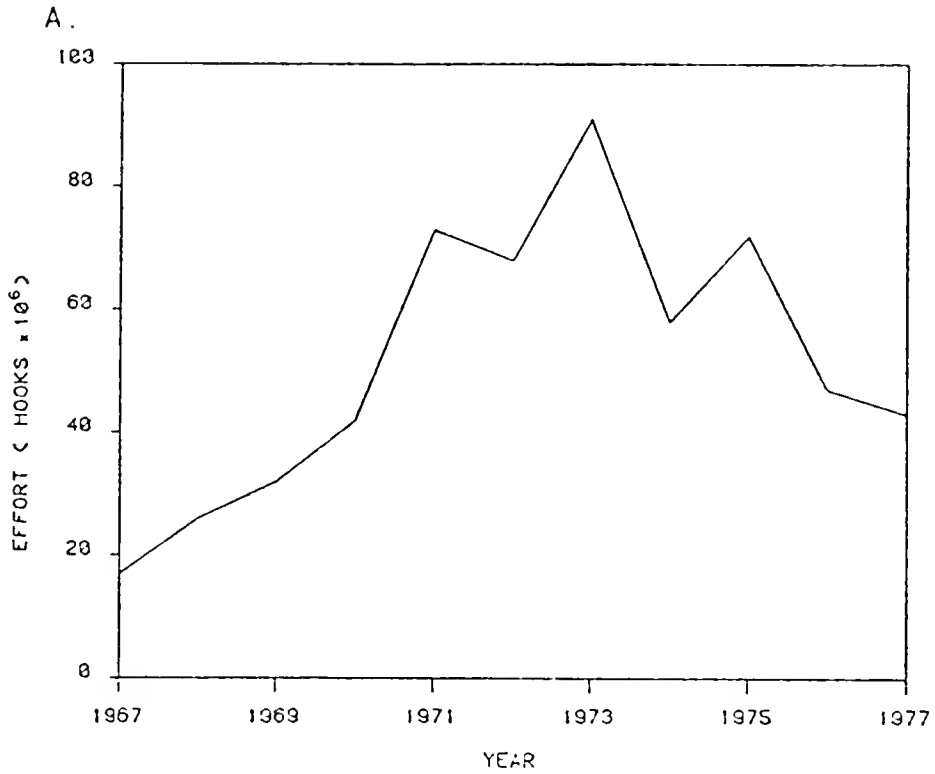

Figure 4. a) Fishing effort (number of hooks) on yellowfin tuna from the eastern Atlantic longline fishery, 1967 to 1977.

b) Fishing effort (standard purse seine days absence, SDA) on yellowfin tuna from the eastern Atlantic surface fishery, 1967 to 1979.

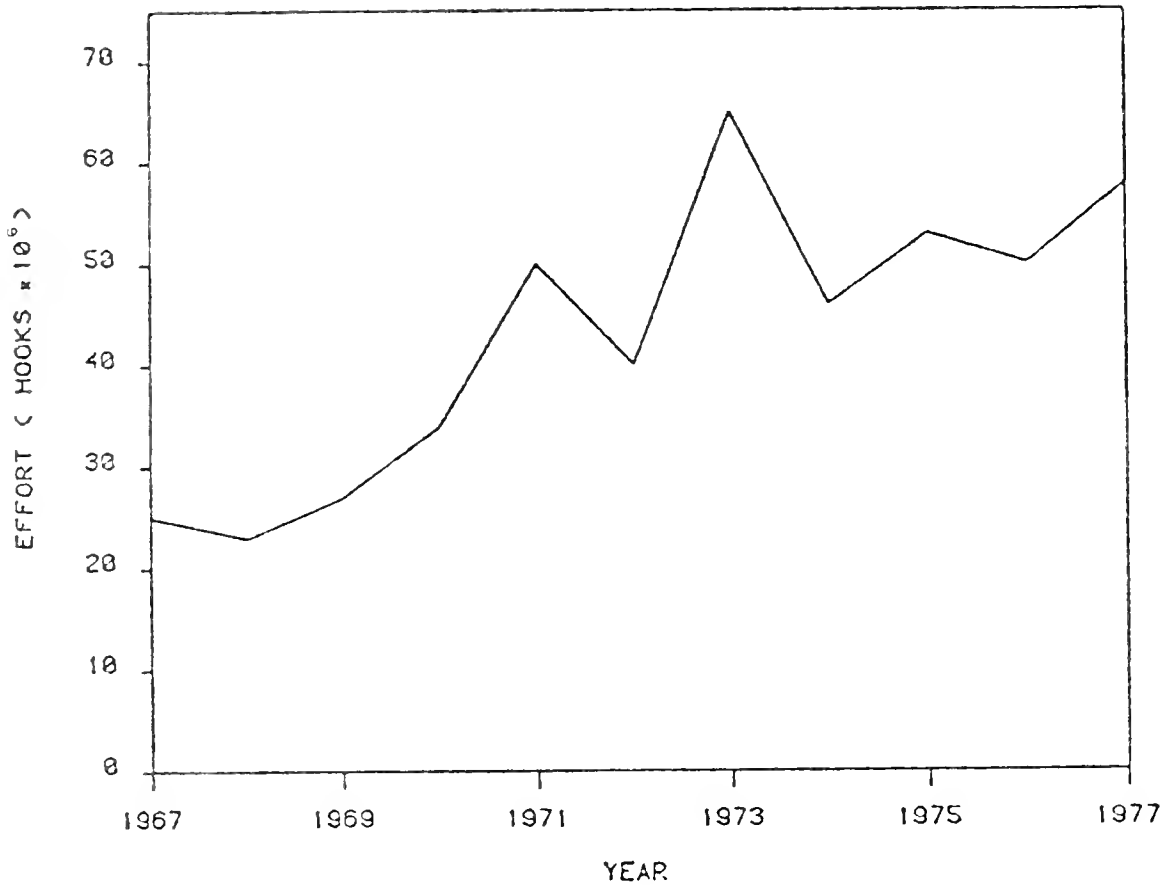

Figure 5. Fishing effort (number of hooks) on yellowfin tuna from the western Atlantic longline fishery, 1967 to 1977.

I.D. Current Management of the Fishery

Yellowfin tuna fisheries in the Atlantic Ocean are managed cooperatively by the 19 member nations of the International Commission for the Conservation of Atlantic Tunas (ICCAT). The Commission adopted a yellowfin minimum size regulation in July 1973 that states

". . .that the Contracting States take the necessary measures to prohibit any taking and landing of yellowfin tuna weighing less than 3.2 kg.

Notwithstanding the above regulation, the Contracting States may grant tolerances to boats which have incidentally captured yellowfin weighing less than 3.2 kg, with the condition that this incidental catch should not exceed 15% of the number of fish per landing of the total yellowfin catch of said boats."

The size regulation was adopted to decrease fishing mortality on young yellowfin tuna and increase yield-per-recruit.

II. NATURE AND SIGNIFICANCE OF U.S. AND FOREIGN PARTICIPATION IN THE FISHERY

The U.S. interest in Atlantic yellowfin tuna is concerned with: 1) harvesting by our domestic fleet, 2) processing of domestic and foreign catch, 3) consumption of the canned product, and 4) maintaining a reliable and steady market for yellowfin through conservation measures.

Only part of the U.S. tropical tuna fleet, predominately an eastern tropical Pacific industry, fishes in the Atlantic Ocean. These vessels usually enter the fishery in the summer soon after the yellowfin tuna regulatory area (CYRA) in the eastern tropical Pacific is closed to yellowfin fishing, and usually return to the Pacific by December. The fleet is composed mainly of large purse seiners. The number of U.S. vessels that annually participate in the fishery peaked in 1972 (40 vessels), dropping to 12 vessels in 1979 (Figure 6a). Only 6 U.S. vessels fished in the Atlantic in 1980. The yellowfin catch of these vessels peaked in 1969 (18,791 mt) and has averaged 7,400 mt from 1967 to 1979 (Figure 6b). The 1979 U.S. Atlantic yellowfin catch of 3,200 mt was worth approximately \$3 million (the entire industry catch was 141,000 mt worth \$137 million). Preliminary U.S. catch of yellowfin and bigeye in 1980 (the two species are not separated in preliminary figures) was 8,500 mt.

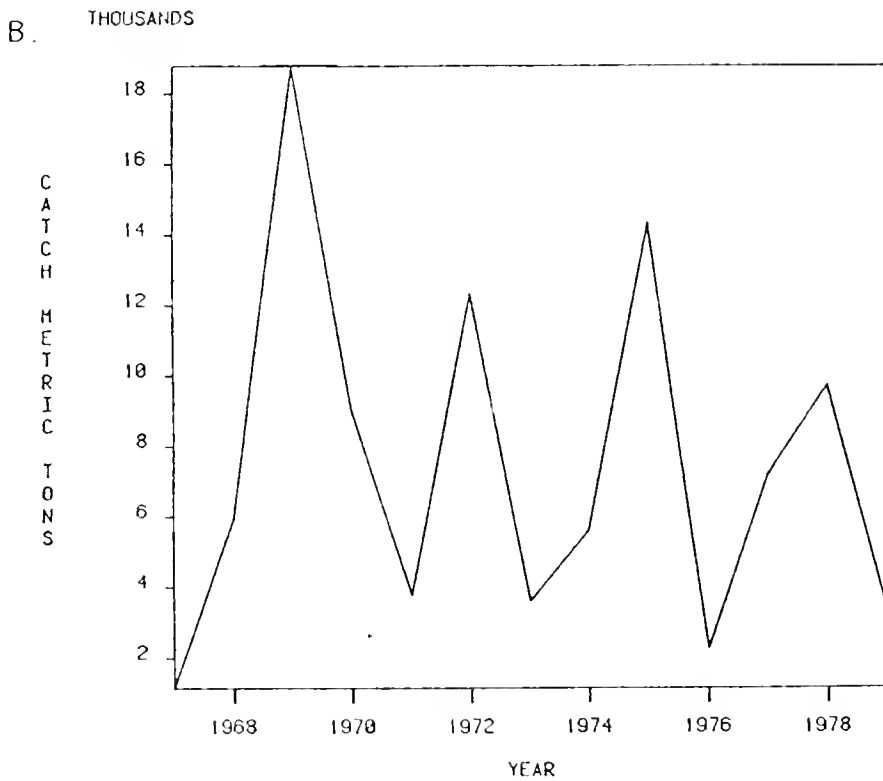
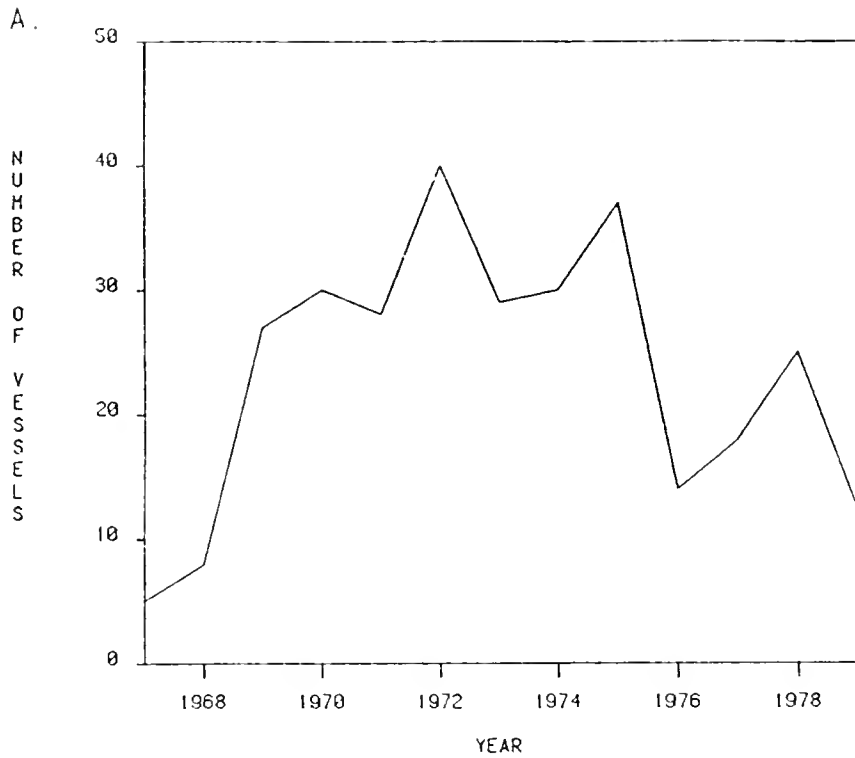

Figure 6. a) Total fishing effort in number of U.S. vessels fishing in the Atlantic Ocean, 1967 to 1979.
b) Total catch of yellowfin tuna for U.S. vessels fishing in the Atlantic Ocean, 1967 to 1979.

U.S. imports of Atlantic yellowfin and bigeye tuna averaged approximately 12,000 mt during 1970 to 1979 (yellowfin and bigeye imports are not reported separately). The value of the 1979 imported catch (7,800 mt) was approximately \$8 million. Virtually all domestic and imported catches of Atlantic yellowfin tuna are packed and consumed in the U.S. Annual total consumption of Atlantic yellowfin tuna is approximately 15,200 mt worth about \$14 million.

Future participation by U.S. and foreign vessels in the Atlantic yellowfin fishery is difficult to determine. Based on past performance and the current status of the stocks, the FISM and Spanish fleets should continue to dominate surface catches, and the Korean/Panamanian and Japanese fleets should dominate longline catches. New fisheries developing off South Africa and Brazil may increase foreign participation. Future U.S. participation is partially dependent on catches in the CYRA and the outcome of regulatory measures in this area. If conditions remain as present, U.S. participation should not increase from that in 1980 (6 vessels). The U.S. fleet in 1978 to 1980 increased their fishing activity in the western Atlantic off Venezuela. Whether this increase will continue in 1981 is unknown.

III. STATUS OF THE STOCKS

III.A. Stock Structure

No conclusive evidence is available on Atlantic yellowfin tuna stock structure. Separate longline catch rate maxima in the eastern and western Atlantic have been observed and larval studies have identified important spawning areas off Brazil and in the Gulf of Guinea. Studies show lower gonad indices for yellowfin tuna off Brazil than in the eastern Atlantic, leading to the hypothesis of separate eastern and western stocks in the Atlantic Ocean. Since this evidence is inconclusive, analyses have employed both single and two stock hypotheses.

Recent catches of yellowfin tuna off Cape Agulhas, South Africa, have raised the question of whether these fish were from an Indian Ocean population or an Atlantic Ocean population. Additional studies are needed to answer this question.

The hypothesis of separate yellowfin stocks available to surface and longline gears has been suggested. Current evidence, although not conclusive, indicates that there is a high seasonal and annual correlation of CPUE indices between the two gears. Therefore, until new evidence is available, fish caught by surface and longline gears are provisionally thought to be of the same stock.

III.B. Stock Assessment and Fishery Evaluation

III.B.1. Trends in Catch-per-Unit-Effort

The only available Atlantic-wide catch-per-unit-effort (CPUE) series is for the longline fishery (Figure 7a). CPUE estimates decreased from 0.9 fish per hundred hooks in 1967 to 0.4 in 1975. Since 1975, CPUE estimates have fluctuated between 0.4 and 0.6 fish per hundred hooks.

The best available eastern Atlantic CPUE series is for the FISM purse seine fleet. CPUE decreased from 6.2 mt/standard day absence (SDA) in 1969 to 1.9 in 1979 (Figure 7b).

III.B.2. Results of Production Model Analysis

No definite evidence on stock structure exists; therefore, production model analyses used to assess stock status have been performed under two stock structure hypotheses: 1) total Atlantic stock, and 2) separate eastern and western Atlantic stocks. Data from each stock structure have been analyzed with three production models: 1) the asymptotic model, where $m = 0$, 2) the Gompertz model, where m approaches 1, and 3) the logistic model, where $m = 2$. In each case, m is the skewness parameter of the fitting equation.

III.B.2.a. Total Atlantic stock

Based on the degree of fit index (r^2), the $m = 0$ ($r^2 = 0.995$) production model best fits the data (Figure 8). However, the r^2 values for the $m = 1$ ($r^2 = 0.992$) and $m = 2$ ($r^2 = 0.992$) models are essentially the same. Therefore, the choice of the most appropriate model is impossible at this time. While the $m = 0$ model implies that sustainable catch theoretically never declines at very high levels of effective fishing effort, it is clear that, at some high level of effective fishing effort, the stock will become so depressed that recruitment and sustainable catch will decline. It is not known at what level of fishing effort this will occur and caution must therefore be exercised when drawing conclusions from higher effort levels beyond the limits of the available data.

Estimates of maximum sustainable yield (MSY) of yellowfin from the total Atlantic stock range from 119,000 mt to 144,000 mt depending upon the model being used (Figure 8). MSY occurs at an optimum effort (f^*) of 51,000 standard days absence (SDA) for the $m = 2$ model, and at 54,000 SDA for the $m = 1$ model. Optimum effort is not defined for the $m = 0$ model. The preliminary estimate of the 1979 catch

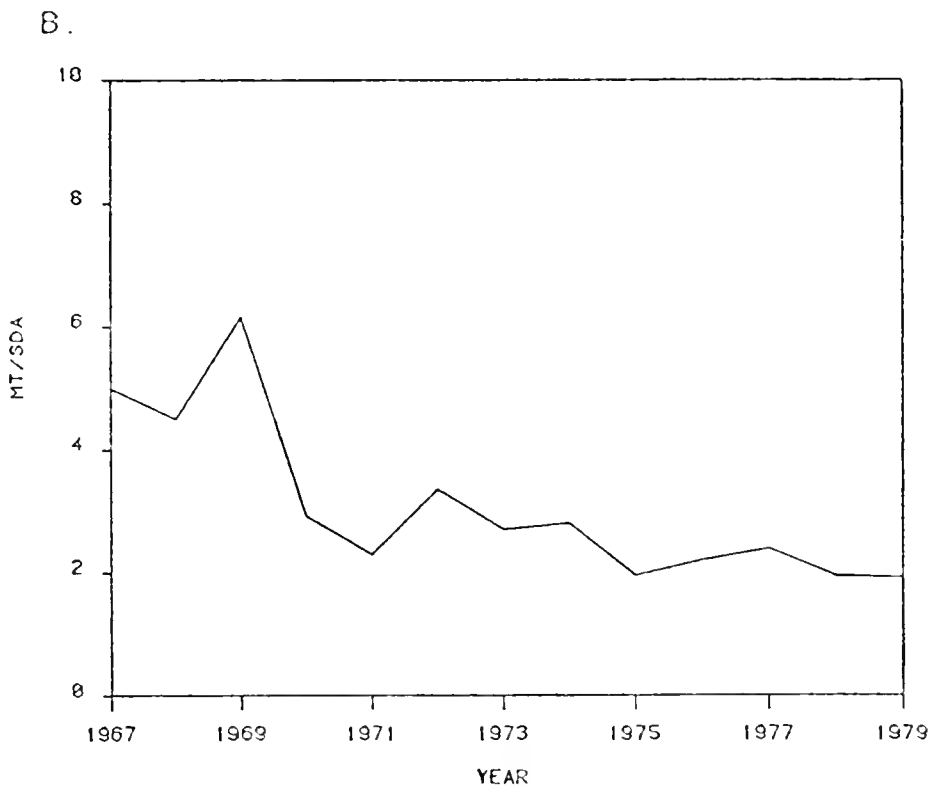

Figure 7. a) Catch-per-unit-effort (number of fish/100 hooks) from the Atlantic longline fishery for yellowfin tuna, 1967 to 1978.
b) Catch-per-unit-effort (metric tons/standard purse seine days absence) from the eastern Atlantic surface fishery for yellowfin tuna, 1967 to 1979.

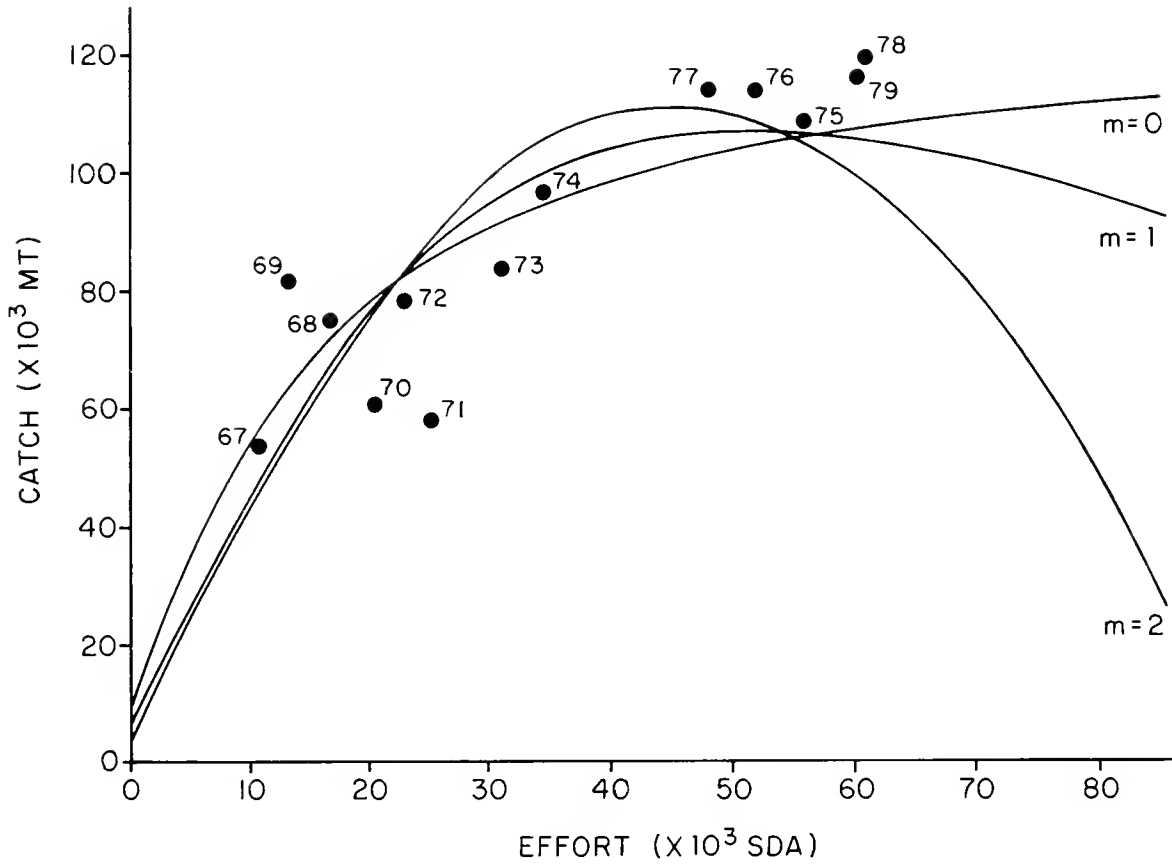

Figure 8. Equilibrium yield curves generated from data of the total Atlantic surface and longline fishery for yellowfin tuna, 1964 to 1979.

(130,000 mt) is within the range of MSY estimates and is at an effort level of 68,000 SDA.

III.B.2.b. Separate eastern and western Atlantic stocks

Production model analyses were performed assuming separate east and west stocks. The models were applied to two eastern Atlantic data sets: 1) data from the surface and longline fishery, and 2) data from the surface fishery only.

The $m = 0$ model best fits data sets 1 and 2 where $r^2 = 0.990$ and 0.972 , respectively. Results suggest that MSY is between 94,000 and 133,000 mt, depending on the model and data set chosen (Figures 9 and 10). Optimum effort is 43,000 to 46,000 SDA for the $m = 2$ model, and 49,000 to 52,000 SDA for the $m = 1$ model. The 1979 catch is 116,300 mt for data set 1 and 109,500 mt for data set 2. Current fishing effort levels are 13 to 24% greater than f^* .

As with the total Atlantic stock data, r^2 values for the $m = 1$ and $m = 2$ models were only slightly different than for the $m = 0$ model. Therefore, MSY estimates are presented for all three models because objective criteria for choosing among the different models are unavailable. If $m = 1$ or $m = 2$ is true, and the fishery is currently operating under equilibrium conditions, then any increase in effective fishing effort will not result in any notable increase in sustained yield. If $m = 0$ is true, however, increases in effective fishing effort can result in increased sustained yield and decreased CPUE.

The models were fitted to data from the longline fishery in the western Atlantic. Results give MSY values ranging from 16,000 mt to 22,000 mt at effort levels of 25 million and 35 million hooks (Figure 11) for the $m = 1$ and $m = 2$ models, respectively. Current catches are at or below MSY and current levels of fishing effort are above those giving MSY. The results suggest that total catch by the longline fishery in the western Atlantic will not increase with increased fishing effort.

III.B.3. Results of Yield-per-Recruit-Analysis

Yield-per-recruit analyses performed on the hypothesized eastern Atlantic stock indicate that increases in yield-per-recruit to the fishery as a whole can be obtained with an increase in size-at-first-capture or a moderate increase in fishing effort (Figure 12). The outcome is different for the different gears: the longline fishery would gain in yield-per-recruit by any increase in size-at-first-capture up to about 120 cm; the purse seine fishery would gain by any increase in size-at-first-capture.

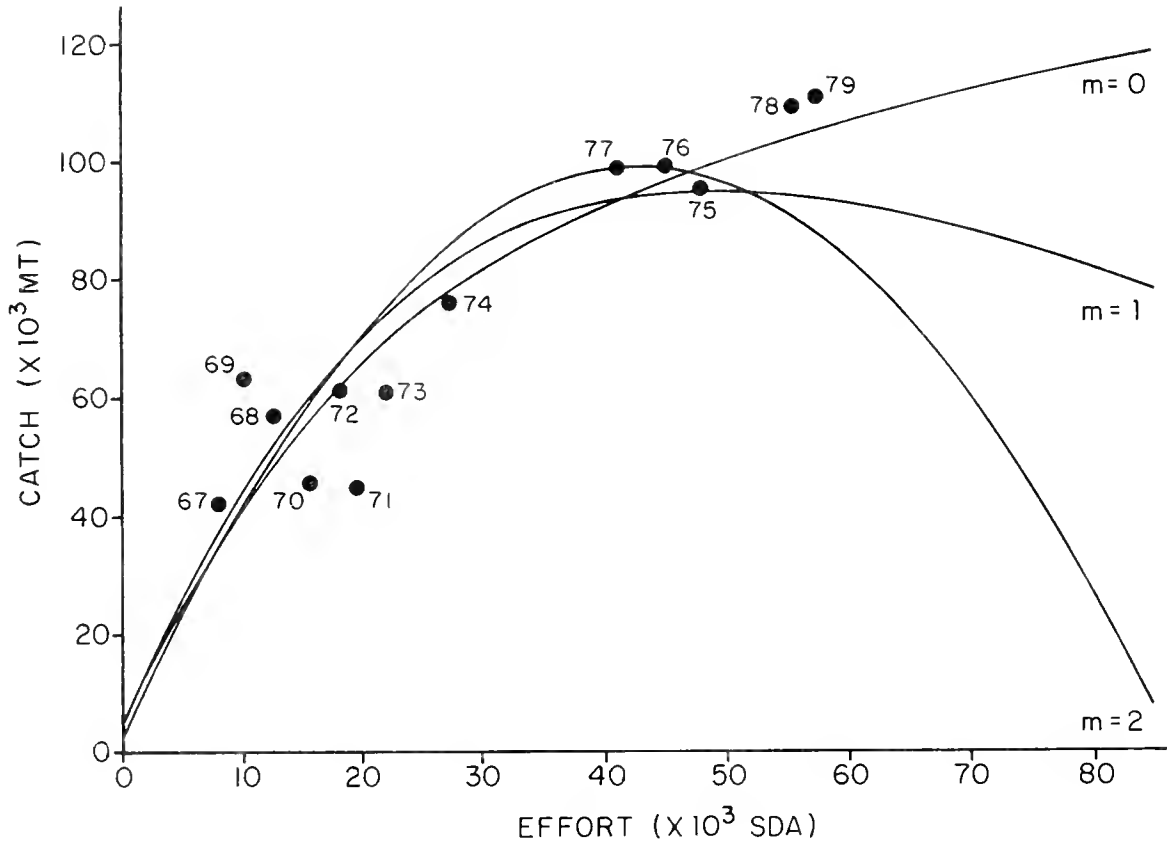

Figure 9. Equilibrium yield curves generated from data of the eastern Atlantic surface fishery for yellowfin tuna, 1969 to 1978.

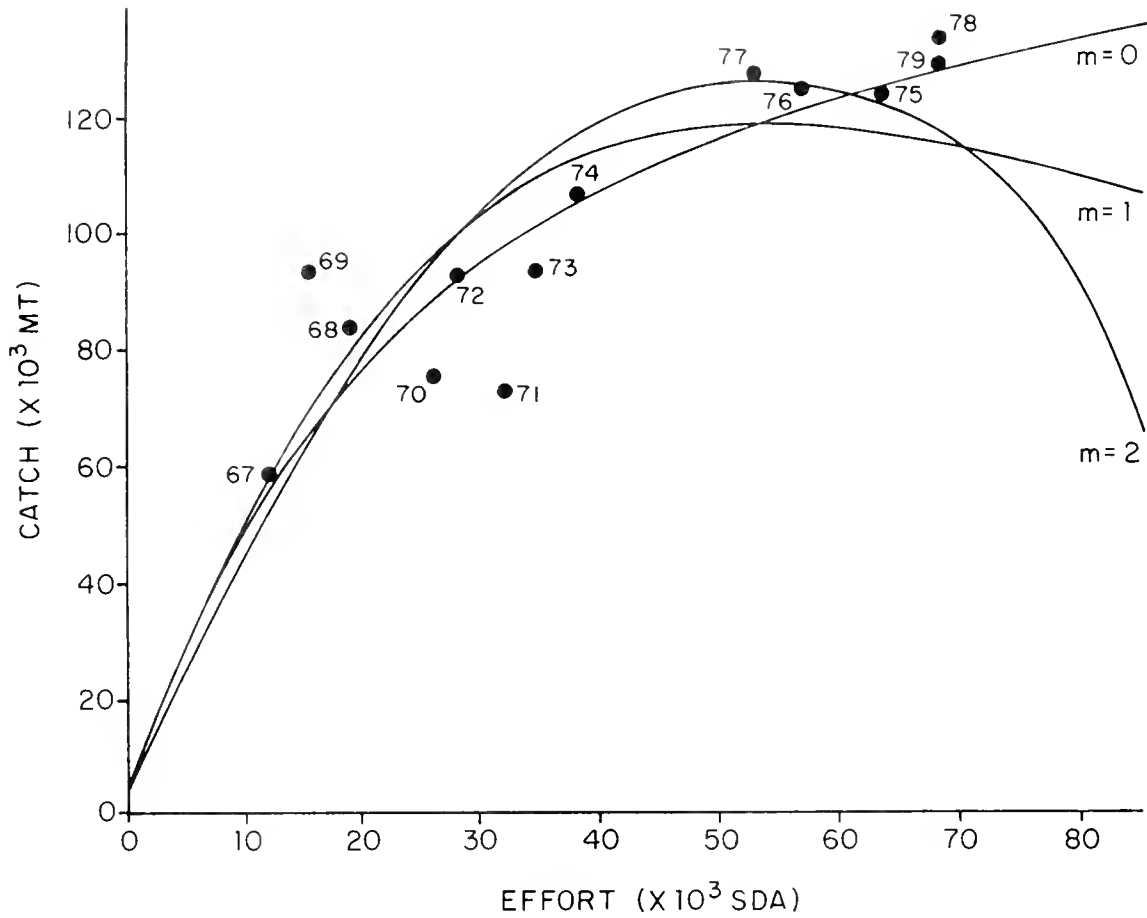

Figure 10. Equilibrium yield curves generated from data of the eastern Atlantic surface and longline fishery for yellowfin tuna, 1964 to 1979.

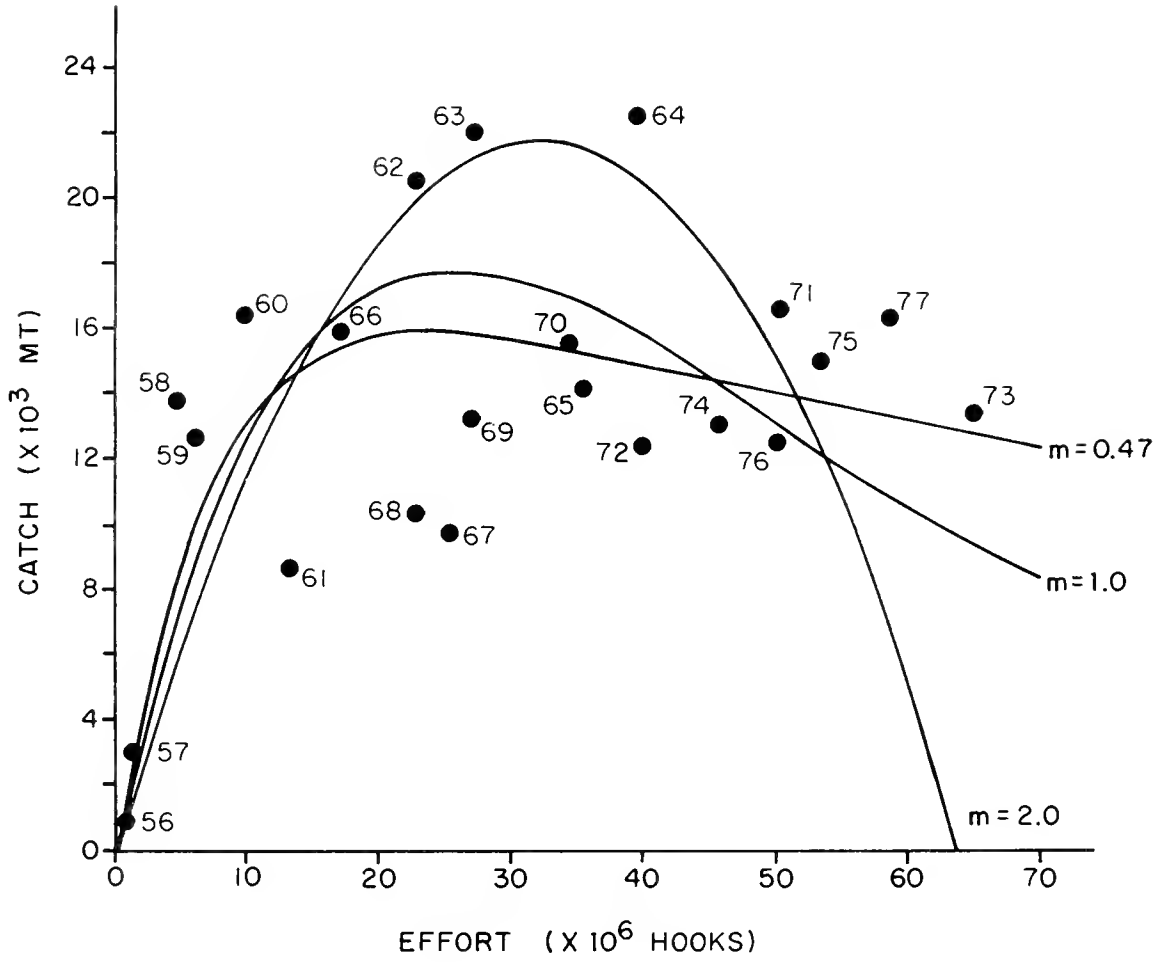

Figure 11. Equilibrium yield curves generated from data of the western Atlantic longline fishery, 1956 to 1977.

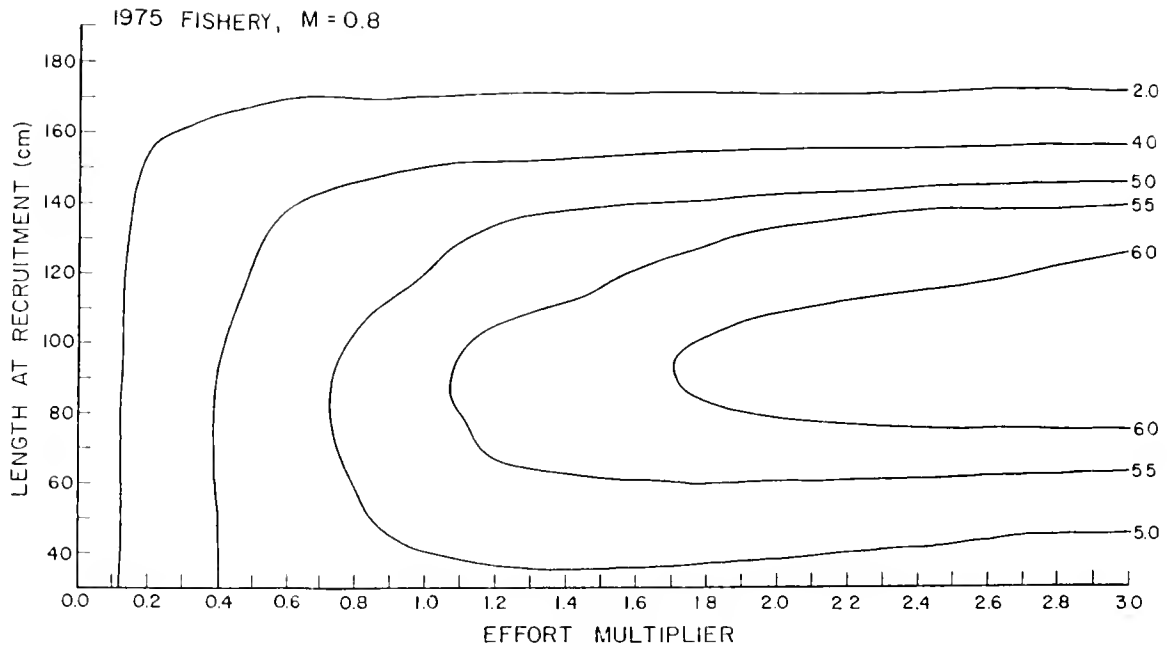

Figure 12. Yield-per-recruit isopleths for the eastern Atlantic surface and longline fishery in 1975. Natural mortality $M=0.8$.

The situation with respect to changes in minimum landing size is more complex. If fishermen avoid catching small fish, then the benefits to the fishery as a whole will occur as predicted by the yield-per-recruit model. On the other hand, if small fish continue to be caught, and are discarded dead, there may be little or no increase in effective size-at-first-capture, and therefore, no benefit. Available data show that Japanese Tema-based baitboats apparently discarded 1,130 mt of undersized yellowfin in 1977 while landing only 2,488 mt. Higher rates of discarding were noted for two trips of Tema-based baitboats accompanied by Ghanaian technicians in 1978 (6,660 mt). Therefore, the actual yield-per-recruit to the fishery may be less than predicted.

III.B.4. Results of Spawner/Recruitment Analysis

No spawner/recruit relationships have been defined for Atlantic yellowfin tuna. Studies were conducted which analyzed recruitment of yellowfin tuna to the eastern Atlantic fisheries. Estimates of recruitment to age 1 in the 1965 to 1968 year-classes varied between 12 million and 26 million fish. The 1969 to 1972 year-classes have held relatively constant at approximately 24 million fish (Figure 13). No trends in recruitment are evident.

Increased catches over the past decade do not appear to have had an adverse effect on recruitment. However, the catch-per-unit-effort of the longline fishery has decreased, suggesting that the spawning stock has declined. In view of this trend and of the increased catches of large fish by purse seiners, the size of the spawning stock and the possible effect on subsequent recruitment need to be monitored.

III.B.5. Results of Other Analyses/Simulations

None available.

III.C. Current Evaluation of Stocks and the Fishery

Regardless of the stock structure assumed, Atlantic yellowfin tuna stocks are heavily fished, particularly in the eastern Atlantic. Given the present geographical distribution of the fishery and pattern of fishing by different gears, it is unlikely that appreciable increases in yield can be achieved by increasing the amount of fishing effort. Increases in total catch which have occurred in recent years are largely due to the effect of geographical expansion of the area of fishing in the eastern tropical Atlantic. It is not known to what extent a further expansion can be achieved, or what further increases in catch might result from such an expansion.

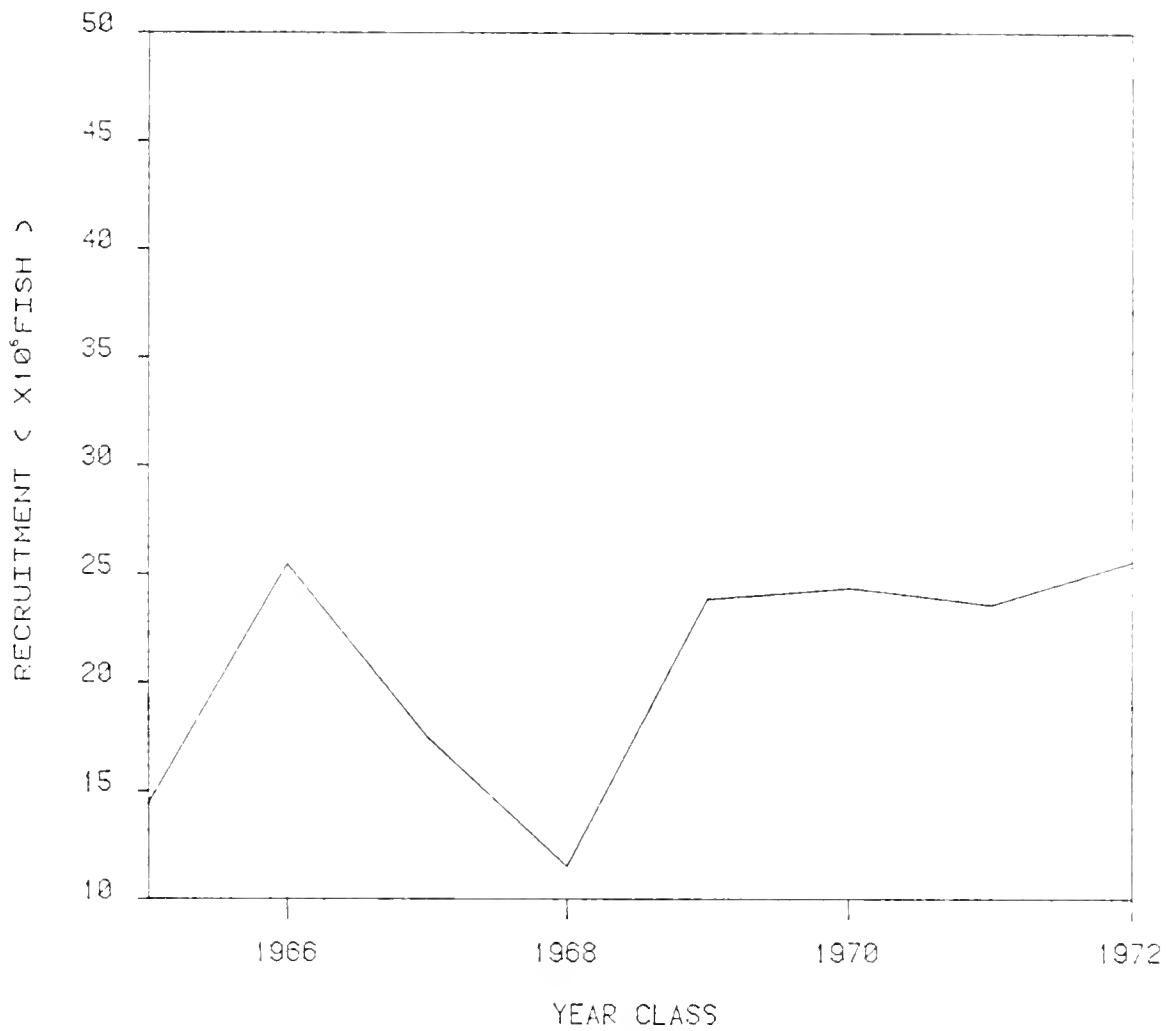

Figure 13. Estimated recruitment to age 1 of yellowfin tuna from the eastern Atlantic Ocean by year of birth, 1965 to 1972.

Total yield to the fishery partially depends on the sizes of fish caught. Any increase in the effective size-at-first-capture should increase yield up to a point. Conversely, increased fishing on small yellowfin would tend to decrease the total long-term yield.

III.C.1. Effects of Regulations

On the basis of several studies, ICCAT, in 1973, adopted a minimum size limit on Atlantic yellowfin of 3.2 kg or 55 cm. It was estimated that under the then-current fishing pattern, this would either give a small increase in yield-per-recruit (YPR) or, if undersized fish were discarded dead, would not affect the YPR. Since the regulation was adopted, the fisheries have changed dramatically: purse seine catches have increased greatly and have shifted to larger fish, catches of both baitboats and longliners have decreased, and there has been a shift to smaller fish by the baitboats.

Analyses were conducted to assess the amount of change in YPR since the adoption of the regulation. Results indicated that YPR for the entire fishery increased anywhere from 3 to 18% since the adoption of the regulation. The longline fishery experienced a 57% reduction in equilibrium yield-per-recruit, the purse seine fishery a 55% increase, and the baitboat fishery a 45% decrease. The longline fishery's decrease in yield-per-recruit was probably due to increased competition from purse seine fisheries. The purse seine fishery's increase in yield-per-recruit was due to increased effort on larger fish. The baitboat's decrease in yield-per-recruit was due to reduced effort on large fish and increased effort on very small fish.

The regulation may also have resulted in increased occurrences of undersized yellowfin tuna being landed as bigeye tuna, and increased dumping of dead undersized fish at sea. Several ICCAT member countries have initiated research to quantify the extent of discards at sea, to describe in detail the areas where juvenile yellowfin tuna are available, and to describe the interaction between juvenile yellowfin and juveniles of other tuna species.

A size regulation on bigeye tuna, similar to that on yellowfin tuna has also been adopted by ICCAT members to increase the yield-per-recruit of bigeye tuna and to reduce the landing of undersize yellowfin tuna as bigeye. Additional measures to reduce the taking of small yellowfin tuna are being evaluated by ICCAT's Juvenile Tuna Working Group. The Group has identified areas of high juvenile tuna catches and is looking at different alternatives to the current size limit.

IV. STATUS OF CURRENT RESEARCH NEEDS AND EFFORTS

IV.A. Major Research Problems

1) The growth relation of yellowfin tuna, particularly during the juvenile period, needs to be better defined. Age composition of the catch is an important input to cohort analyses and therefore important for accurate estimates of recruitment and fishing mortality. Completion of this research would lead to better, more accurate estimates and, therefore, better management advice.

2) The existence of a spawner/recruit relationship for yellowfin tuna needs to be investigated. Completion of this research would lead to a better understanding of the status of Atlantic yellowfin tuna stocks.

3) Verification is needed of the various stock structure hypotheses: single stock of longline and surface-caught yellowfin, mixing of an Indian Ocean stock with Atlantic yellowfin, and separate eastern and western Atlantic stocks or a single Atlantic stock. Clarification of the stock structure issue would lead to more accurate assessments of the status of Atlantic yellowfin tuna.

4) Alternative management schemes for reducing the catch of small yellowfin tuna should be analyzed. Although the current management scheme has increased yield-per-recruit as intended, small yellowfin tuna continue to be landed by some purse seine and baitboat fisheries that are experiencing difficulties in implementing the 3.2 kg size limit.

5) Continued research on the relationship between environmental parameters and abundance, availability, and vulnerability of Atlantic yellowfin tuna is needed. Current abundance estimates are partially based on sea surface temperature. Since production models are based on these estimates, verification of the technique may be critical.

IV.B. Current Research Efforts

Current Atlantic yellowfin tuna research is concentrated on the following subjects:

1) Trends in fishery statistics: catch, effort, CPUE, and size-frequency (SWFC).

2) Development of new fisheries and their relation to stock structure (ICCAT).

- 3) Fecundity of yellowfin tuna off southern Brazil (ICCAT).
- 4) Relationship between occurrences of yellowfin tuna and sea surface temperature (SWFC).
- 5) Techniques to estimate economic value of the eastern Atlantic surface fishery (SWFC).
- 6) Status of stocks: production models, yield-per-recruit (SWFC).
- 7) Management problems, alternative management schemes, sampling problems (SWFC).

IV.C. Future Research Needs

Future research on Atlantic yellowfin tuna should center on the following activities:

- 1) Refining and extending studies of alternate management schemes. Discrepancies in the data sets and procedures used in initial analyses should be resolved. Effects of different management schemes on multispecies catches, yield-per-recruit, economics, etc., should be considered.
- 2) Investigating the relationships between environmental parameters and abundance, availability, and/or vulnerability of stocks.
- 3) Investigating the interaction between surface and longline gear.

IV.C.1. Suggested Approach and Methods

- 1) U.S. single-set data should be evaluated for possible use in improving knowledge of species composition and fish size composition of schools. A model should be developed to predict movements of the fishery due to different management alternatives and to predict benefits to the fishery, yield-per-recruit, undersize catches, and multispecies catches, based on fishery, economic, and environmental assumptions.
- 2) Data sets from other geographical regions, or utilizing other species, could be used to test the technique of using sea surface temperature to separate effort by species, for example.

IV.D. Status of SWFC Data Base

Data on Atlantic yellowfin tuna at the Southwest Fisheries Center are currently considered adequate for population assessments. There are

problems in the data sets and analytical data procedures being used, however, which need to be resolved:

1) Data set and procedures used in alternative management schemes need to be reviewed and standardized.

2) A plan to assure that the SWFC data system is supplied with, or notified of, all changes to data sets must be developed. Methods of choosing which samples should be used in the case of duplicate sampling of fleets must be standardized.

3) Growth in size of the current data sets and the need for more interactive processing necessitate a reevaluation of the current data base system for cost reasons. Most of the data have been converted to the B7800 and use of other file structures is now being investigated.

The following data will be required in the future:

1) French length-frequency samples by smaller than 5 x 10-degree areas to use for alternate management scheme analyses.

2) U.S. Atlantic single-set data extracted from IATTC data bases and placed on the SWFC bases.

3) Continued sampling of transshipments to Puerto Rico for species and size composition.

4) Data reflecting more complete coverage of the Korean baitboat and Spanish purse seine fisheries.

STATUS REPORT: ATLANTIC BIGEYE TUNA

by

Atilio L. Coan, Jr. and Wesley Parks

Southwest Fisheries Center
Oceanic Fisheries Resources Division
La Jolla, California

ABSTRACT

Recent total annual Atlantic catches of bigeye tuna have averaged 41,000 mt. Major participants in the fishery include Japan, Korea, Spain, and the USSR. The U.S. takes bigeye along with yellowfin and skipjack tuna in its eastern Atlantic tropical tuna purse seine fleet. Recent U.S. catches have been less than 500 mt.

The stock structure of bigeye tuna in the Atlantic is uncertain. Hypotheses include a single Atlantic-wide stock and separate north and south stocks. Catch-per-unit-effort shows slight decreasing trends.

Production model analysis estimates MSY in the range of 52,000-123,000 mt. Recent catches are below MSY. Recent estimated effort levels are 25 to 50% less than optimum effort. Analyses suggest that with current fishing patterns, increasing age-at-first-capture would slightly increase equilibrium yield-per-recruit.

The International Commission for the Conservation of Atlantic Tunas adopted a minimum size limit of 3.2 kg for bigeye tuna in 1979. The regulation, intended to increase yield-per-recruit, has not been in effect long enough for its effectiveness to be assessed.

I. DESCRIPTION OF THE FISHERY

Bigeye tuna are distributed throughout the Atlantic Ocean between 50° N and 40° S latitudes (Figure 1). Catches in the north Atlantic are concentrated in the west at 40° N latitude and in the east at 20° N latitude. South Atlantic catches are concentrated in the west at 30° S latitude and in the east at 10° S latitude.

I.A. History of the Fishery

The Atlantic fishery for bigeye tuna began in 1956 when the Japanese longline fleet expanded operations from the Pacific into the Atlantic Ocean. Longline continues to be the principal gear capturing bigeye. However, in recent years surface gears (purse seine and baitboat) have taken a greater proportion of the catch (from 17% in 1972 to 37% in 1978). The surface fishery for bigeye tuna is a multi-species fishery which also takes yellowfin and skipjack.

The major participants in the north Atlantic fishery are the Japanese, Korean, Spanish, and Portuguese fleets. These fleets together caught 80% of the average north Atlantic bigeye catch during the period 1975 to 1979 (Figure 2a).

The major participants in the south Atlantic fishery for bigeye tuna are the fleets of Japan, Korea, Russia, and Taiwan. These fleets caught 74% of the south Atlantic catch of bigeye during the period 1975 to 1979 (Figure 2b).

I.B. Trends in Catch and Effort

I.B.1. North Atlantic Fishery

Catches for the north Atlantic longline fishery peaked in 1974 at 26,000 mt and decreased to approximately 10,000 mt in 1979 (Figure 3a). Catches for the surface fishery also peaked in 1974 at 13,000 mt and averaged 10,000 mt during the 1975 to 1979 period. The provisional 1980 north Atlantic longline and surface fishery catch is 21,400 mt.

Fishing effort (in number of hooks) for bigeye tuna in the north Atlantic reached a peak of 165 million hooks in 1975, then decreased to 85 million hooks in 1977 (Figure 4a). Effort for the Canary Island baitboat fleet however, remained relatively constant (10,000 days at sea) during the 1975 to 1978 period (Figure 4b).

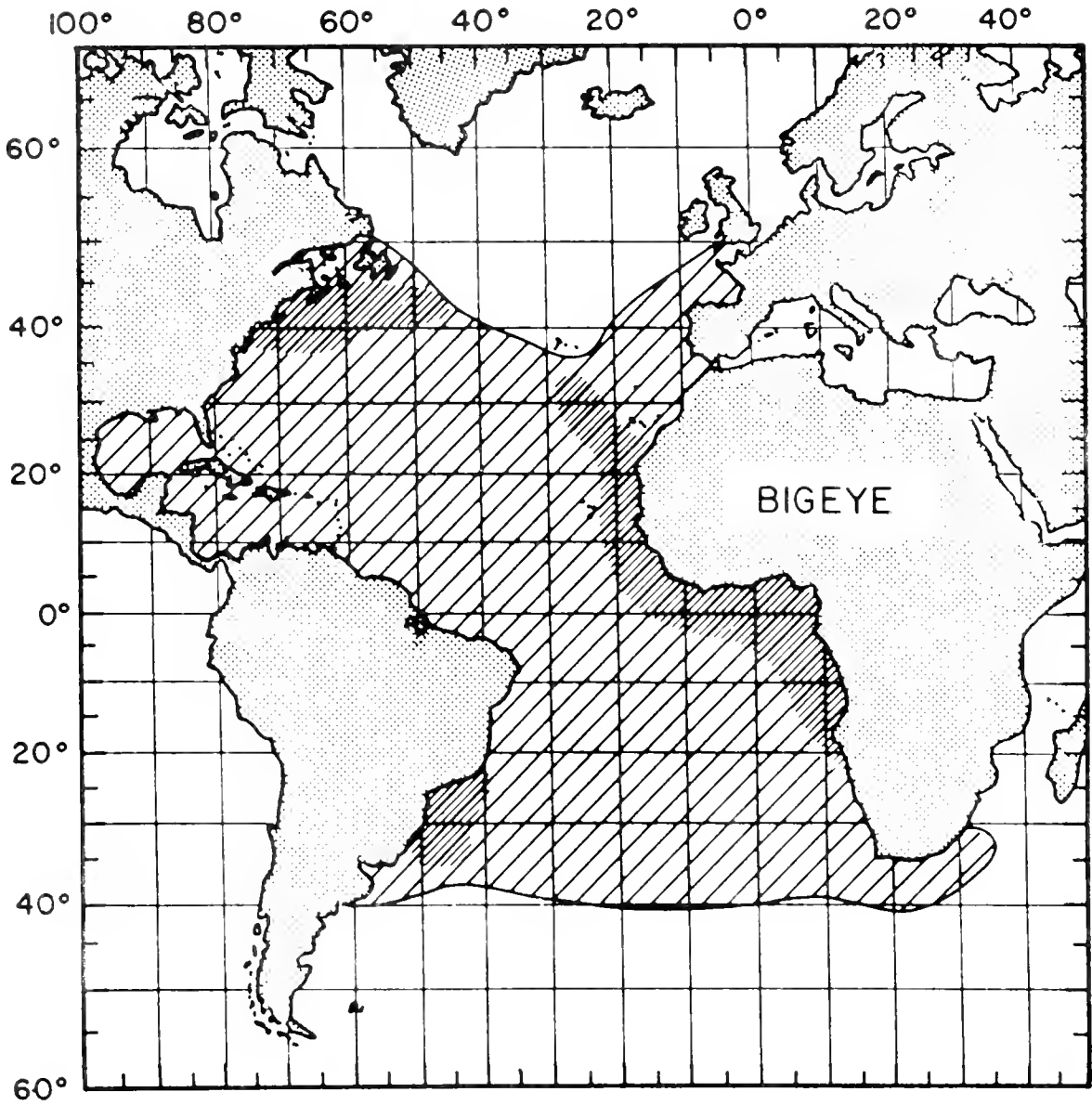
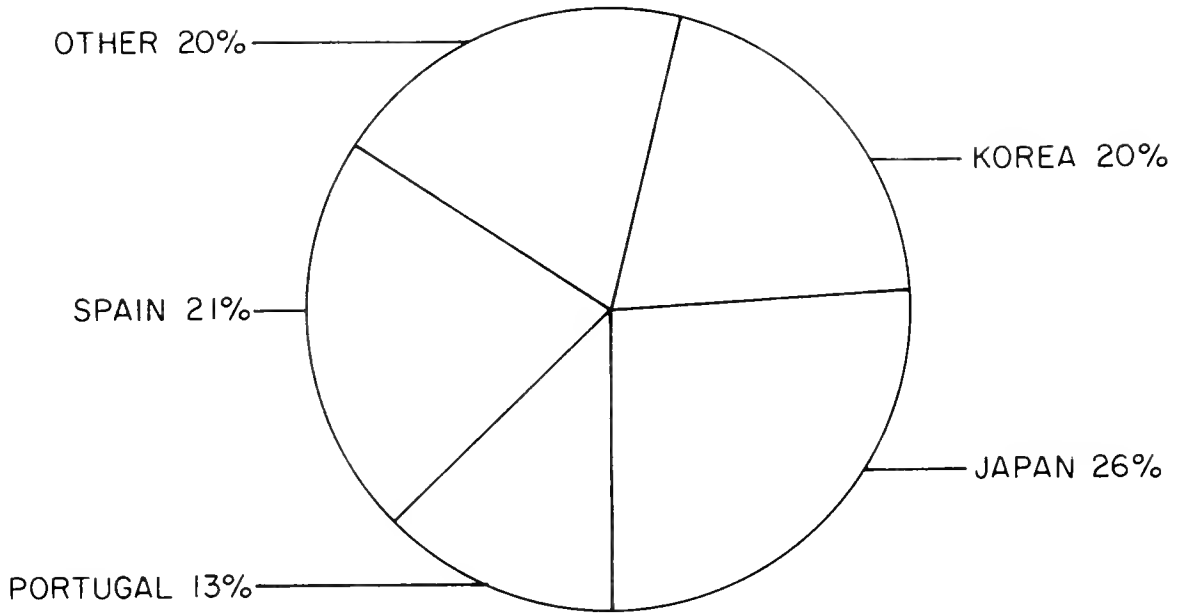

Figure 1. Areas of the Atlantic Ocean currently or historically fished for bigeye tuna. Densely hatched areas indicate areas of greatest fishing intensity.

A



B

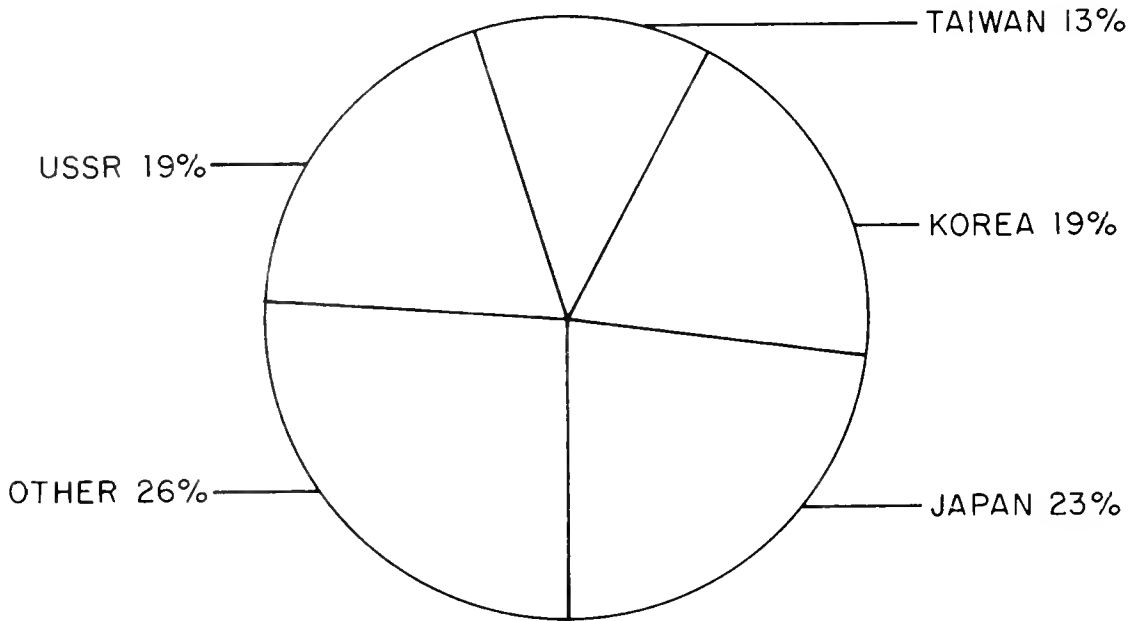
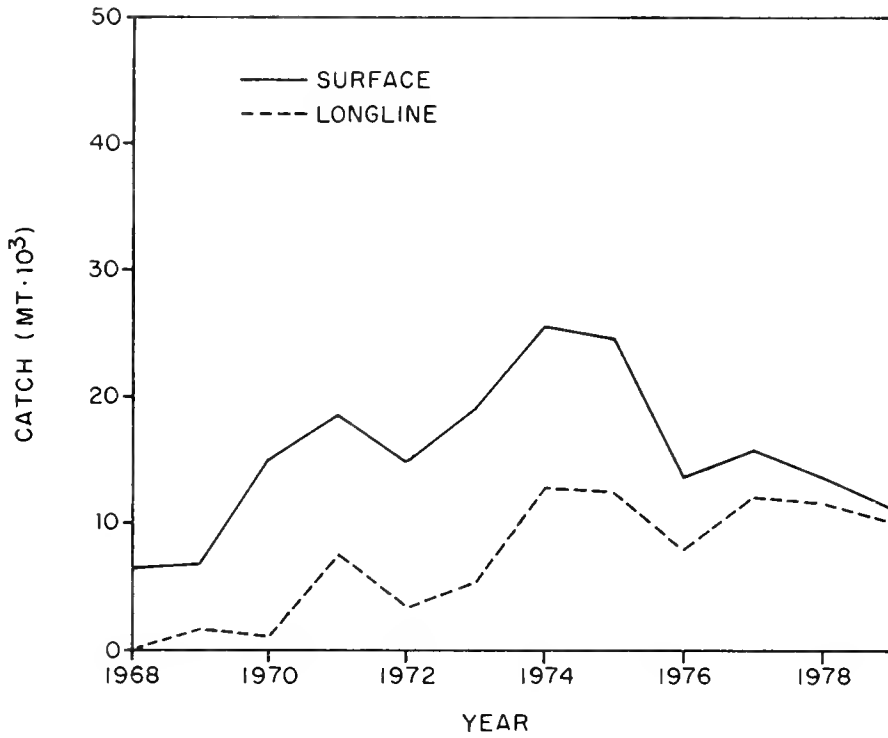

Figure 2. a) Major participants in the northern Atlantic surface and longline fishery for bigeye tuna, 1975 to 1979.
b) Major participants in the southern Atlantic surface and longline fishery for bigeye tuna, 1975 to 1979.

A



B

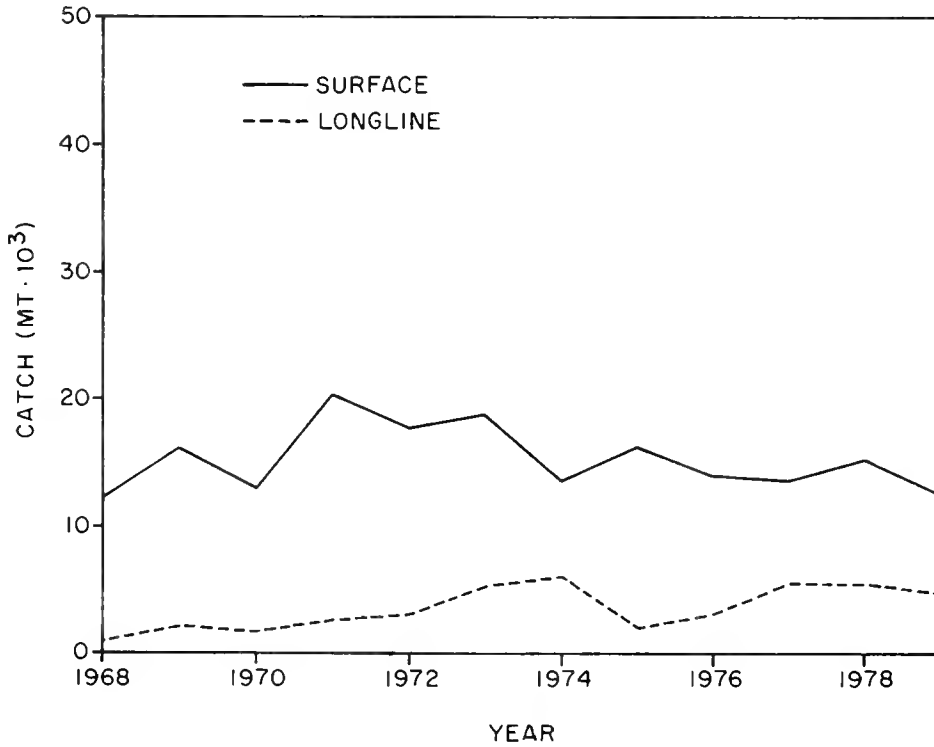
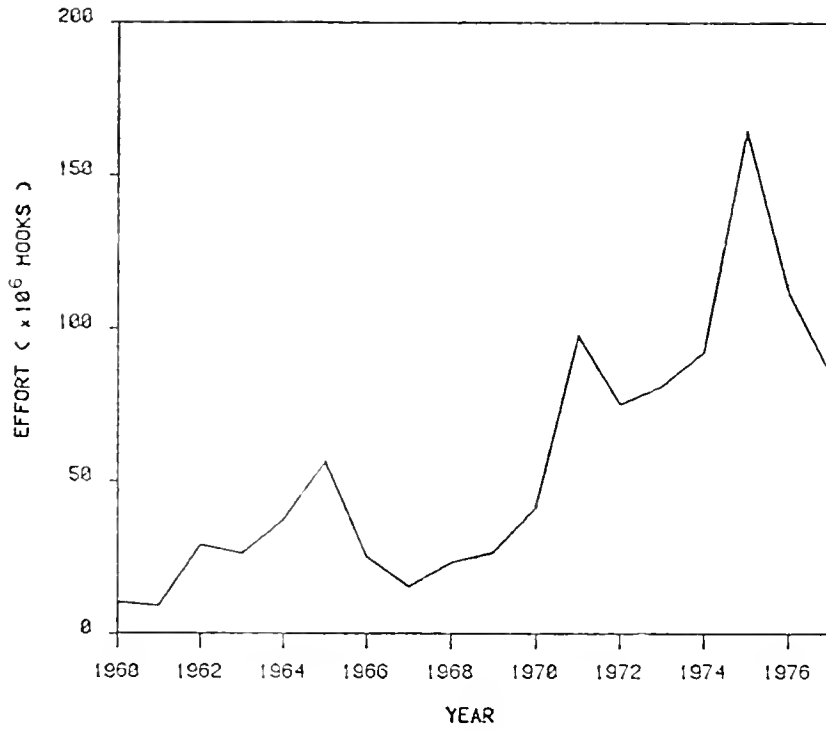

Figure 3. a) Total catch of bigeye tuna from surface and longline gears fishing in the northern Atlantic, 1968 to 1979.
b) Total catch of bigeye tuna from surface and longline gears fishing in the southern Atlantic, 1968 to 1979.

A.



B.

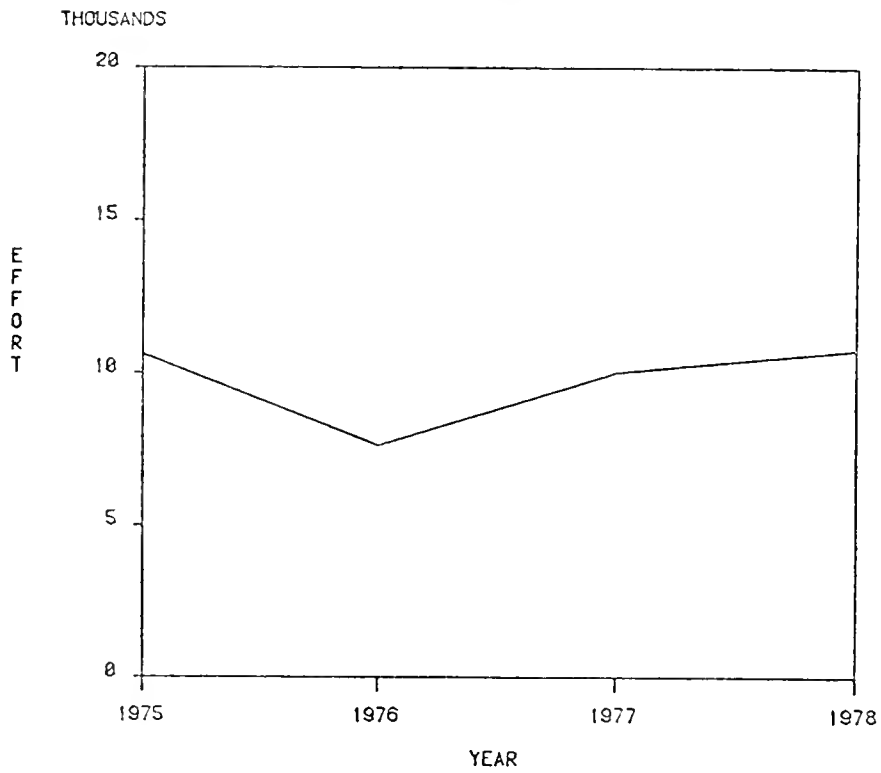

Figure 4. a) Fishing effort in hooks for the longline fishery in the northern Atlantic, 1960 to 1977.

b) Effort in days at sea for the Canary Island bait-boat fleet, 1975 to 1978.

I.B.2. South Atlantic Fishery

Bigeye catches for the south Atlantic longline fishery peaked in 1971 (20,000 mt), then gradually declined to 12,000 mt in 1979 (Figure 3b). Surface fishery catches peaked in 1974 (6,000 mt) and, after a brief decline, remained relatively constant at 5,000 mt between 1977 and 1979. The provisional 1980 south Atlantic longline and surface fishery catch is 13,600 mt.

South Atlantic longline effort increased from 7 million hooks in 1960 to 94 million hooks in 1976 (Figure 5). No reliable measure of effort is available for the surface fishery.

I.C. Value of Catch

In the United States, yellowfin and bigeye tunas are marketed at the same prices: \$893/mt (1979, average ex-vessel) for fish less than 3.2 kg and \$1,047/mt for fish greater than 3.2 kg. Based on an average price of \$970/mt, the value of north Atlantic bigeye caught by all fisheries in 1979 was \$21 million; the total south Atlantic bigeye catch was worth \$16 million. The total 1979 U.S. bigeye catch was worth approximately \$200,000.

I.D. Current Management of the Fishery

In 1979, the International Commission for the Conservation of Atlantic Tunas (ICCAT) recommended to their member nations that they adopt a minimum size limit regulation for bigeye tuna. The regulation states:

"That the Contracting Parties take the necessary measures to prohibit any taking and landing of bigeye tuna (Thunnus obesus) weighing less than 3.2 kg until December 31, 1983.

Notwithstanding the above regulations, the Contracting Parties may grant tolerances to boats which have incidentally captured bigeye tuna weighing less than 3.2 kg with the condition that this incidental catch should not exceed 15% of the number of fish per landing of the total bigeye catch of said boats."

This size regulation was adopted to 1) increase yield-per-recruit of bigeye tuna by reducing fishing mortality on small fish, and 2) reduce the misreporting of small yellowfin tuna in landings as bigeye tuna. The U.S. adopted these regulations for bigeye tuna in early 1981.

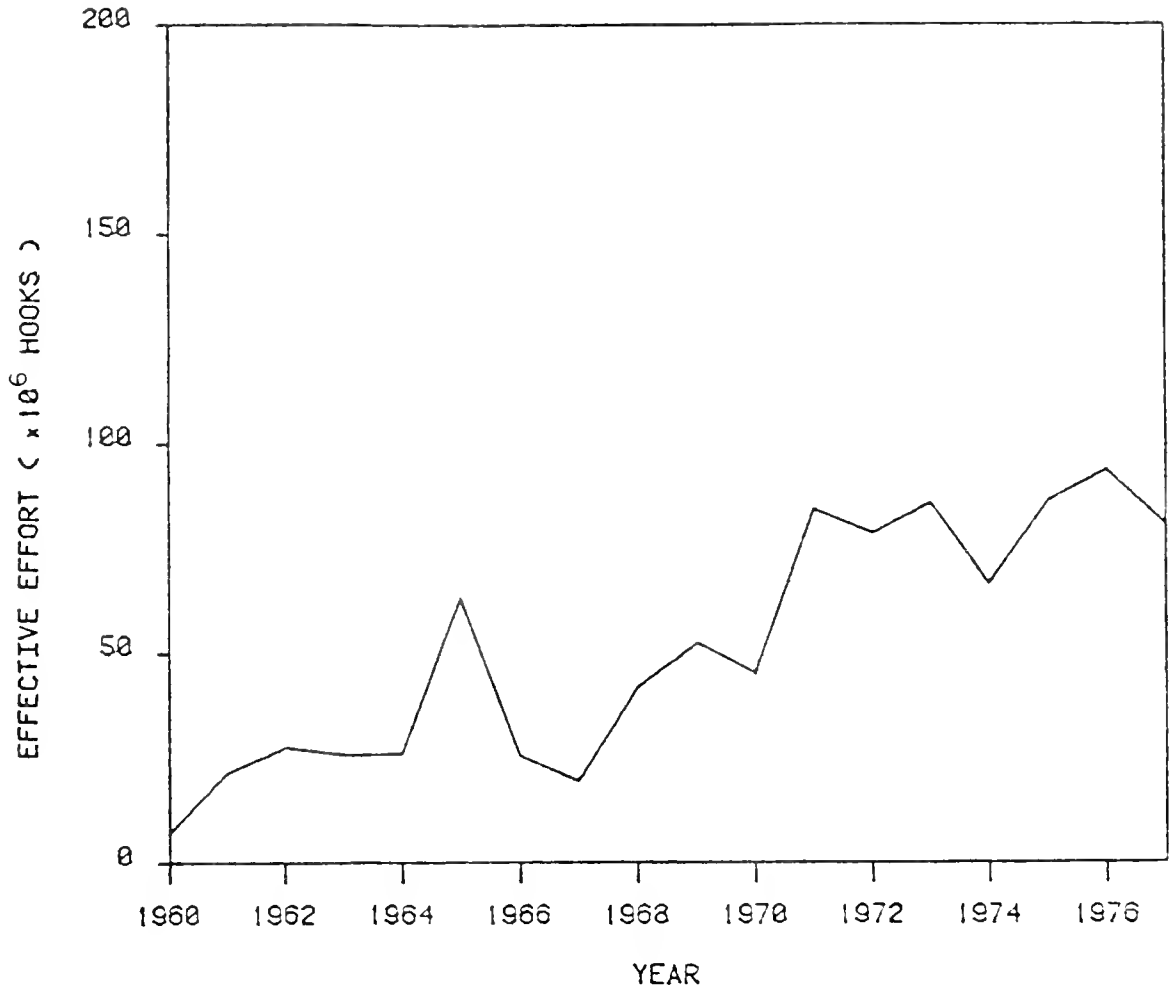

Figure 5. Effective effort in hooks for the longline fishery in the southern Atlantic, 1960 to 1977.

II. THE NATURE AND SIGNIFICANCE OF U.S. AND FOREIGN PARTICIPATION IN THE FISHERY

United States tuna processors utilize domestic and foreign-caught bigeye tuna for canning as light meat tuna. The highest recorded U.S. Atlantic bigeye tuna catch (865 mt) occurred in 1974 (Figure 6). In 1979, the U.S. catch was 200 mt. The amount imported is difficult to determine since bigeye and yellowfin tuna are not separated in import reports. The preliminary U.S. catch of yellowfin and bigeye in 1980 (preliminary figures do not separate catches of the two species) was 8,500 mt.

U.S. participation in the Atlantic fishery (which is a multi-specific tropical tuna fishery catching bigeye, yellowfin, and skipjack tuna) is not expected to increase above 1980 levels (6 vessels). Future foreign participation in the fishery is difficult to estimate with any degree of certainty but is not anticipated as long as the fisheries continue operating within their current geographical boundaries and current fishing methods.

III. STATUS OF THE STOCKS

III.A. Stock Structure

Bigeye tuna are distributed throughout the Atlantic Ocean (Figure 1). Scientists have hypothesized separate north and south Atlantic stocks. Evidence for this includes a decline in hook rates in the equatorial Atlantic and preliminary evidence of separate spawning areas, one in the northern and one in the southern tropical areas.

Recapture of bigeye tuna tagged in the eastern Atlantic indicate that the fish generally remained in areas of tagging off Dakar and Point-Noire, except for a single fish that exhibited northward migration from the Gulf of Guinea to the area off Dakar after one year. Since evidence of either a single or separate northern and southern stocks is inconclusive, two hypotheses are used in stock assessments: 1) a single Atlantic stock, and 2) two independent stocks separated at approximately 5° N latitude.



Figure 6. Total catch of bigeye tuna for U.S. vessels fishing in the Atlantic Ocean, 1968 to 1979.

III.B. Stock Assessment and Fishery Evaluation

III.B.1. Trends in Catch-per-Unit-Effort

Annual bigeye tuna hook rates were estimated from Japanese longline fleet catch/effort data (Figure 7). Hook rates in both the northern and southern Atlantic exhibit similar gradually decreasing trends except for differences in peak hook rate years. Hook rates peaked in 1974 in the northern Atlantic and 1969 in the southern Atlantic.

No reliable CPUE estimates are available for surface fisheries.

III.B.2. Results of Production Model Analysis

The logistic ($m=2$), the Gompertz (m approaches 1), and the asymptotic ($m=0$) production models have been used to assess the status of Atlantic bigeye tuna. Because division of the stocks is uncertain, analyses have been performed under hypotheses of a single Atlantic stock and separate north and south Atlantic stocks.

III.B.2.a. Total Atlantic stock

The latest available analysis utilized data for the total Atlantic fishery for the period 1961-1978 (Figure 8). Estimates of equilibrium maximum sustainable yield (MSY) ranged from 51,900 mt to 60,100 mt for $m=2$ and $m=1$ models, respectively. The $m=0$ model gave an MSY estimate of 123,200 mt. Objective criteria fail to indicate any of the three models as best. The 1978 catch was 45,700 mt. The 1978 estimated effective effort was 25% to 50% less than the optimum effort (f^*) corresponding to MSY for the $m=2$ and $m=1$ models, respectively. Optimum effort for the $m=0$ model is undefined. The 1979 catch was approximately 42,000 mt. No estimate of effective effort is available for 1979.

III.B.2.b. Separate north and south Atlantic stocks

Bigeye tuna fishery data were separated into northern and southern fisheries and production models fit to each data set. The models were applied to data representing the northern fishery for the period 1961-1978. Estimates of MSY were 35,200 mt for the $m=2$ model, 41,100 mt for the $m=1$, 89,600 mt for the $m=0$ model (Figure 9). The 1978 catch was 25,200 mt at an estimated effective effort 45% to 64% less than f^* for the $m=2$ and $m=1$ models, respectively. The 1979 catch was approximately 22,100 mt.



Figure 7. Hook rates (number of fish/100 hooks) for bigeye tuna caught by longliners in the northern and southern Atlantic Ocean, 1961 to 1978.

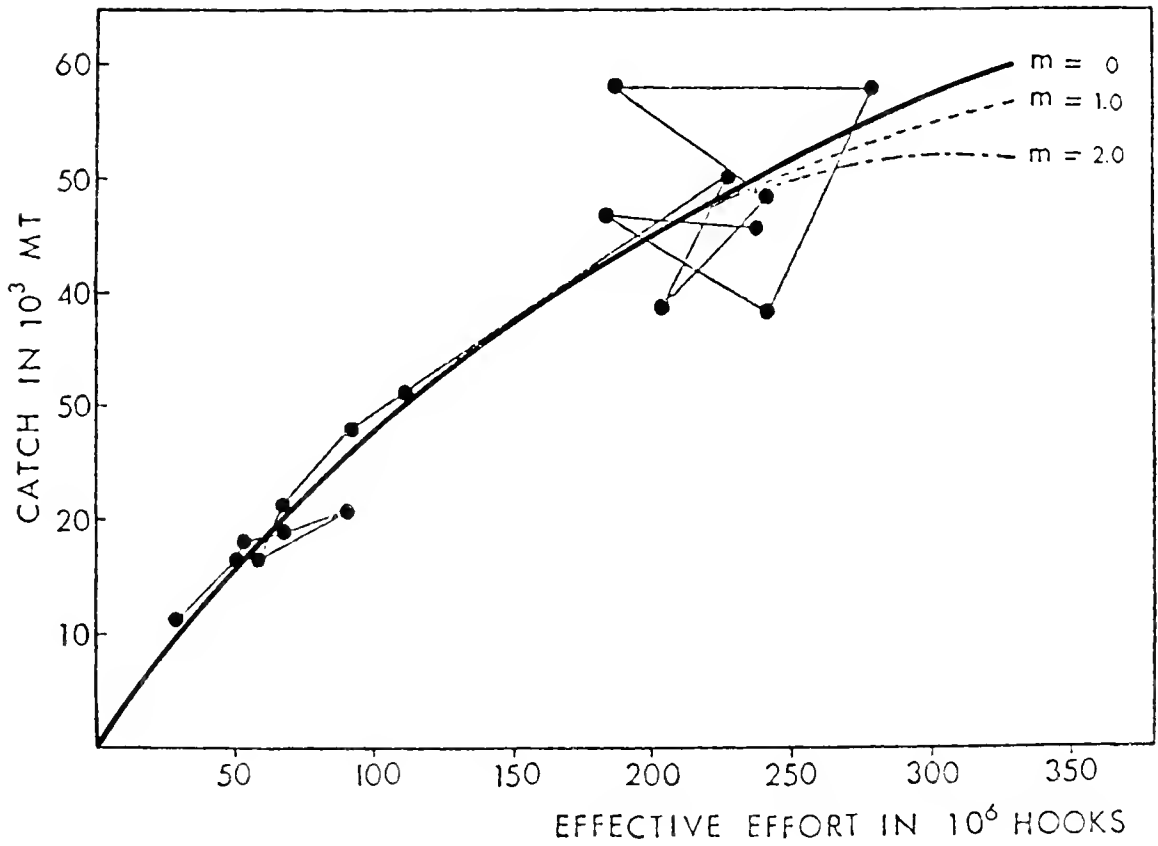

Figure 8. Equilibrium yield curves for bigeye tuna in the whole Atlantic Ocean, 1961 to 1978.

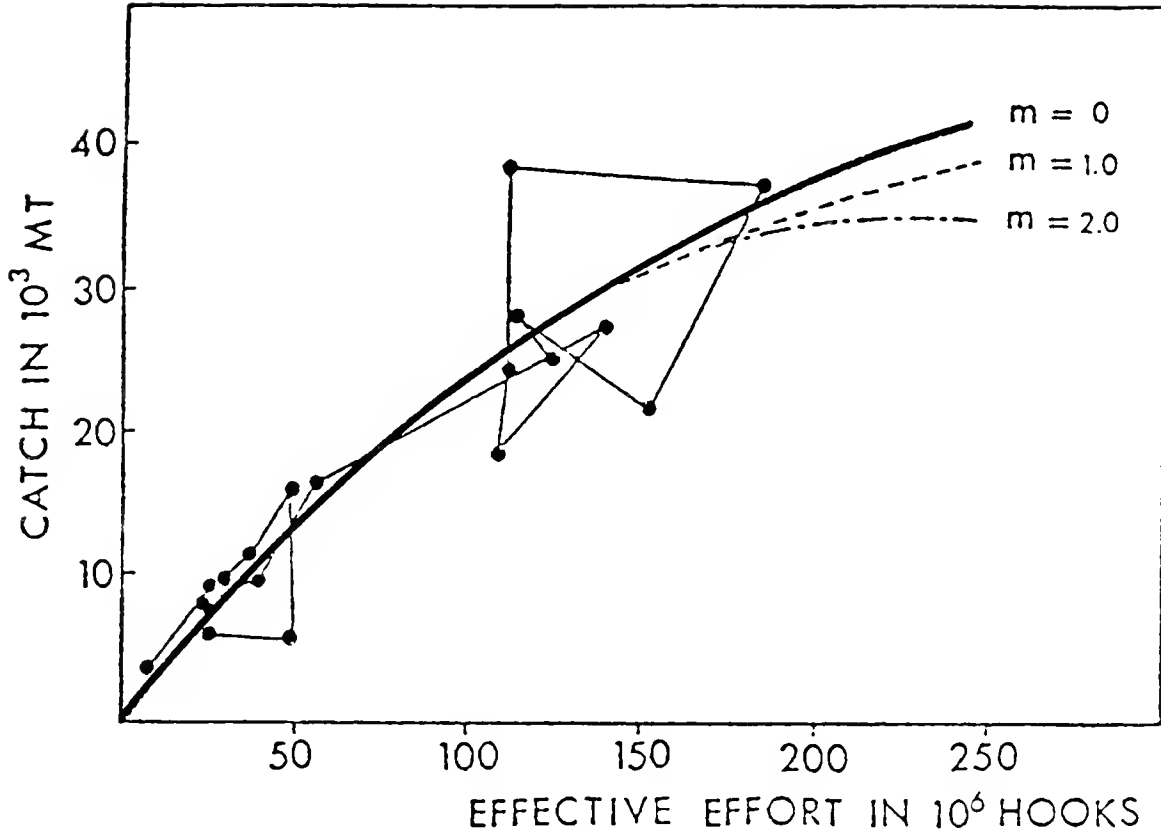

Figure 9. Equilibrium yield curves for bigeye tuna in the northern Atlantic Ocean, 1961 to 1978.

These models were also applied to data from the south Atlantic fishery. Estimates of MSY were 21,000 mt for the $m=2$ model, 25,500 mt for the $m=1$ model, and 49,000 mt for the $m=0$ model (Figure 10). The 1978 catch was 20,500 mt at an estimated effort 3 to 41% less than f^* for the $m=2$ and $m=1$ models, respectively. The 1979 catch was approximately 20,100 mt.

III.B.3. Results of Yield-per-Recruit Analysis

Yield-per-recruit analyses have been used in the past to assess the status of bigeye tuna stocks, and were the basis of the size limit proposal in 1979. A new analysis was performed in 1980 by ICCAT's Working Group on Juvenile Tropical Tunas. Results confirmed that increasing size-at-first-capture from approximately 0.9 kg (30 cm fork length) to 3.2 kg (54 cm) would increase yield-per-recruit to the fishery, especially at higher levels of effort (Figure 11).

III.B.4. Results of Spawner/Recruitment Analysis

Recruitment to age-1 for year-classes 1967 to 1973 was estimated (Figure 12). Only longline data from the total Atlantic fishery were considered. Depending on the natural mortality rate chosen, estimates vary moderately and no general trend is apparent.

III.B.5. Results of Other Analyses/Simulations

None available.

III.C. Current Evaluation of Stocks and the Fishery

Results of the production model analyses indicate that Atlantic bigeye tuna are currently being fished below levels corresponding to MSY. All models indicate that increases in yields are available with increases in effort. Until the fishery operates at higher effort levels it is impossible to select the appropriate model and MSY.

Any increase in size-at-first-capture should increase yield-per-recruit to the fishery. The feasibility of increasing size-at-first-capture for the baitboat fleets, however, is questionable. Since these fleets take small bigeye tuna with catches of skipjack, any increase in size-at-first-capture may result in decreased skipjack catches. Continued increases in catches of small bigeye should result in decreases in yield-per-recruit.

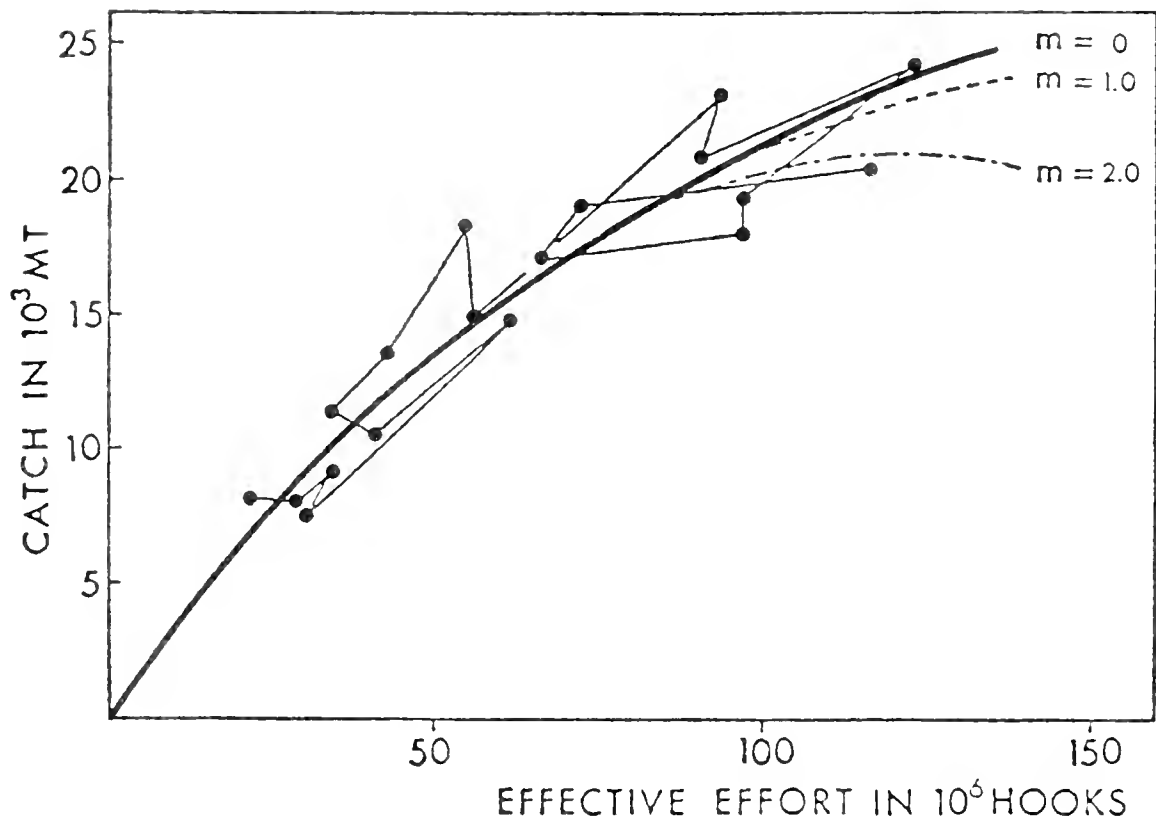

Figure 10. Equilibrium yield curves for bigeye tuna in the southern Atlantic Ocean, 1961 to 1978.

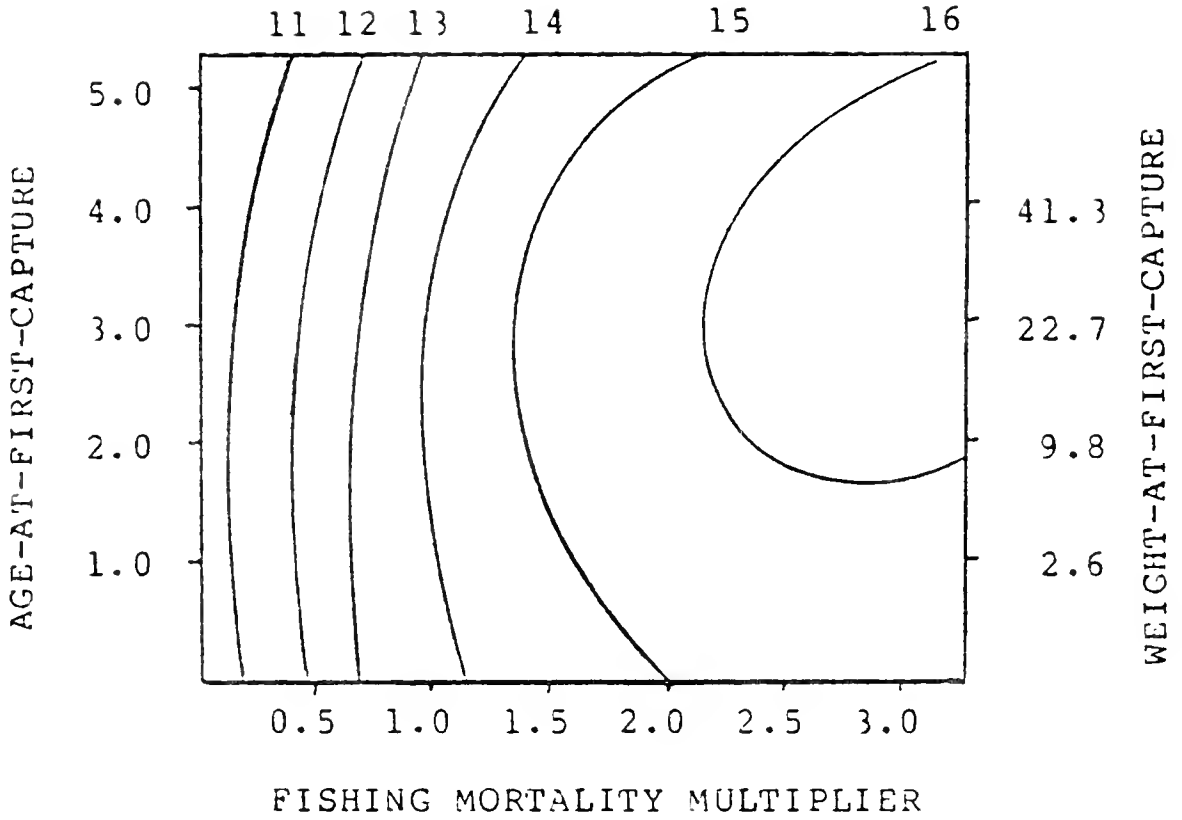

Figure 11. Equilibrium yield-per-recruit (kg) for Atlantic bigeye tuna for combinations of age- (weight)-at-first-capture and multiples of fishing mortality.

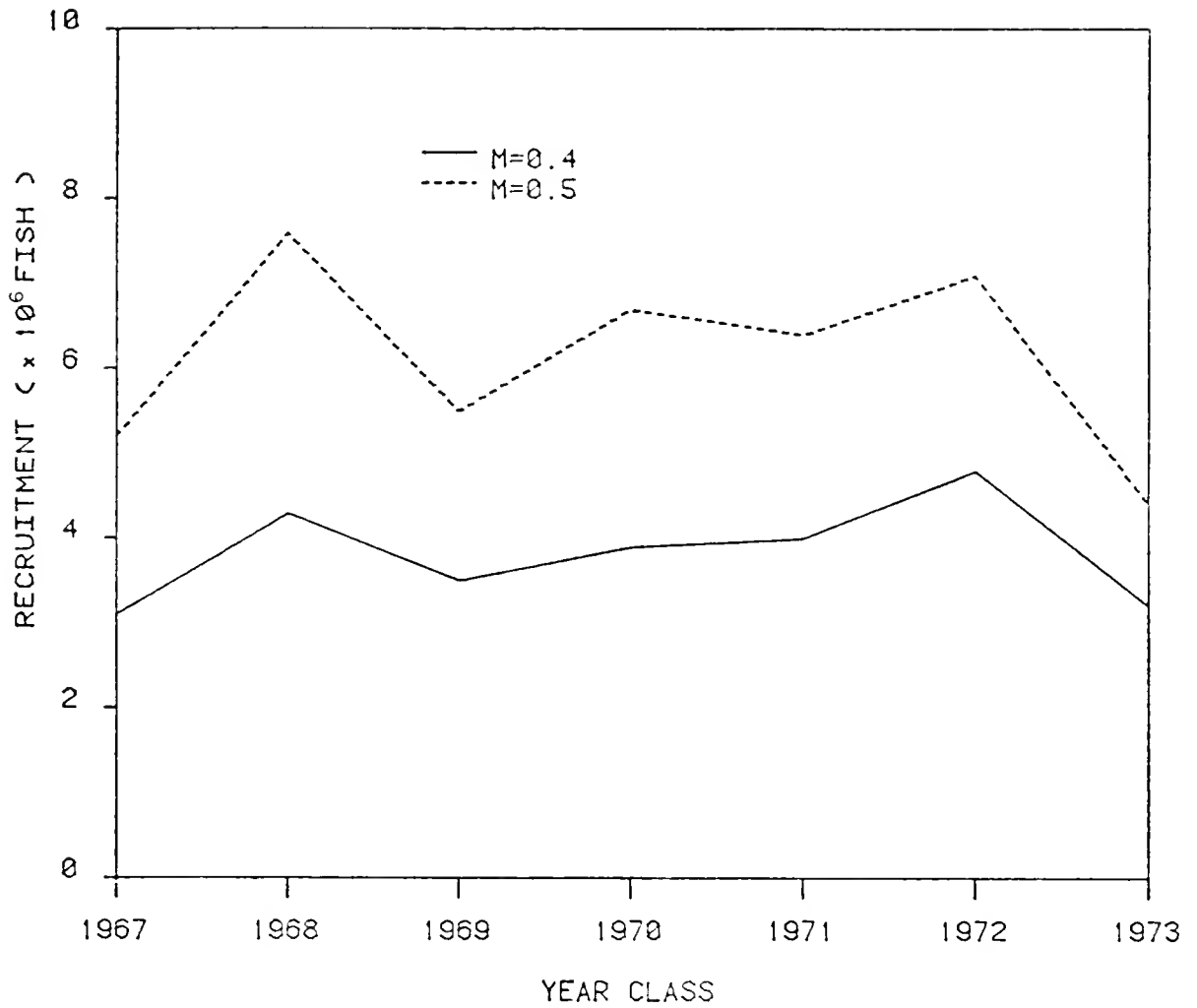

Figure 12. Estimated recruitment to age 1 for Atlantic bigeye tuna under two assumed values of natural mortality, M .

III.C.1. Effects of Regulations

The current size regulation for bigeye tuna has not been in force long enough to assess its specific effects. Theoretically, the size limit should increase yield-per-recruit to the fishery.

At its 1980 meeting, ICCAT's Working Group on Juvenile Tropical Tunas assessed the effects of area-time closures designed to protect small yellowfin and bigeye tunas, and thus increase yield-per-recruit. Potential gains to yellowfin-bigeye catches were contrasted to possible losses to catches of skipjack tuna in multi-species surface fisheries. Six fishing areas having combined monthly catches of yellowfin and bigeye tuna in excess of 50 mt were identified (Figure 13). Twenty-three area-month combinations were chosen for detailed examination. The following conclusions were made:

1) Ignoring losses to catches of skipjack tuna, closing any or a combination of these strata would result in a maximum gain of 10% to yellowfin-bigeye catches.

2) Assuming that skipjack tuna not taken in closed strata would be taken in other areas or at later times, an overall gain in at least yield-per-recruit of bigeye and yellowfin would result from closures. Yield-per-recruit to baitboats would decrease while yield-per-recruit to purse seiners, which catch a broader size range of fish, would increase.

3) It was assumed that any skipjack tuna not taken would be lost, and that these losses would particularly affect baitboats. Although available data were insufficient to predict skipjack losses, the consensus of the Working Group participants was that losses to skipjack catches would exceed gains to yellowfin/bigeye catches. The Group concluded that imposing the area-time closures investigated would probably result in a decrease in the combined catch of yellowfin, bigeye, and skipjack tuna.

IV. STATUS OF CURRENT RESEARCH NEEDS AND EFFORTS

IV.A. Major Research Problems

The uncertainty of the composition of the Atlantic bigeye stock structure makes it difficult to evaluate and assess the effect of the fishery upon this tuna. Analyses of models and determination of MSY, therefore, can only be regarded as "best guesses." In addition, the ICCAT minimum size limit regulation has not been in effect long enough to determine its effect upon the fishery.

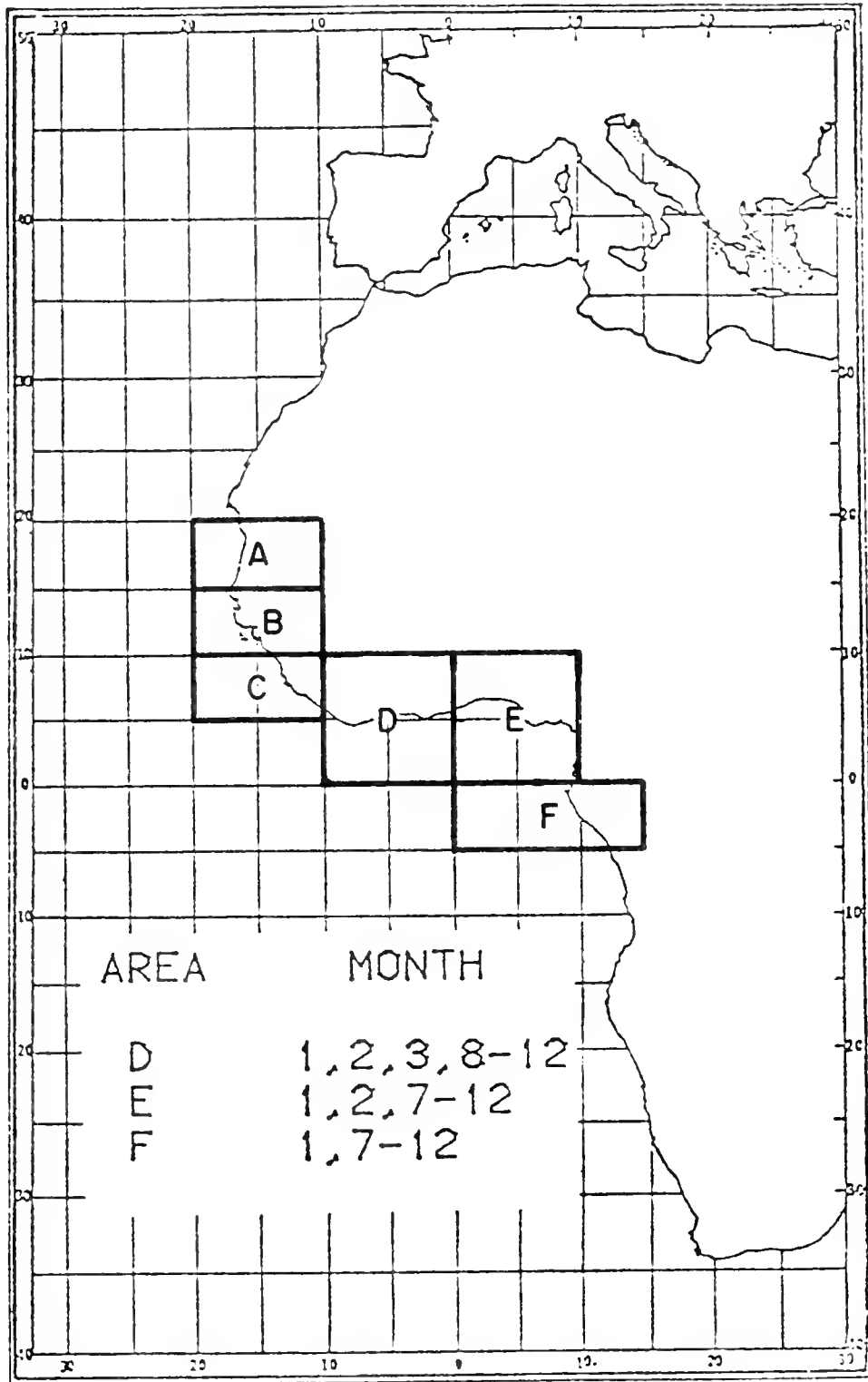

Figure 13. Areas investigated for effect of time-area closures by Juvenile Tuna Working Group. Area-times listed are strata investigated in detail.

IV.B. Current Research Efforts

Current Atlantic bigeye tuna research is very limited. Research at the SWFC has concentrated on evaluation of available data for cohort, yield-per-recruit, and recruitment analyses; areas where small bigeye and yellowfin tunas are caught are also being identified.

IV.C. Future Research Needs

IV.C.1. Suggested Approach and Methods

The following projects should be undertaken in order to improve management of the fishery:

1) Re-estimate population parameters: length-weight relation, growth rates (particularly for small fish), and mortality rates.

2) Investigate stock structure to include the relationship of currently hypothesized northern and southern stocks, and the relationship between longline and surface-caught bigeye tunas.

3) Evaluate the adequacy of current data to analyze yield-per-recruit and spawner/recruit.

4) Investigate the impacts of alternate management schemes for yellowfin tuna on bigeye tuna. The extent of mixing of species and sizes of fish should be determined and considered in any management scheme for yellowfin or bigeye tunas.

IV.D. Status of SWFC Data Base

All currently available Atlantic bigeye tuna data reside on SWFC data bases. Available fishery data (catch, catch/effort, and size composition) for the longline fishery are minimally adequate for stock assessments, but those for the surface fishery are sparse and inadequate for assessments. Additional biological data are needed for both longline and surface fisheries in order to assess population parameters and evaluate stock structure problems. Misreporting of bigeye tuna as yellowfin, although improving, continues to be a problem. Species-composition sampling at all landing and transshipment ports should be continued to alleviate this problem.

STATUS REPORT: ATLANTIC SKIPJACK TUNA

by

Richard H. Evans and Norman Bartoo

Southwest Fisheries Center
Oceanic Fisheries Resources Division
La Jolla, California

ABSTRACT

Eastern Atlantic skipjack tuna stocks are currently fished at a high level (100,000 mt in 1980) while western Atlantic stocks are fished at a low level (9,000 mt in 1980). CPUE indices for both the French-Ivory Coast-Senegal-Moroccan and Tema-based fleets, which are quite different and show no clear trend over time, are not considered to be adequate estimators of abundance. Available evidence indicates that neither western or eastern Atlantic skipjack stocks are overfished at this time, and both stocks may effectively support increased fishing effort. This seems especially true for the western Atlantic, where a developing fishery off Brazil accounted for 80 percent of the western Atlantic catch in 1980.

I. DESCRIPTION OF THE FISHERY

I.A. History of the Fishery

Skipjack tuna fisheries began to develop in the eastern Atlantic about 1955 when baitboats from France and Spain moved into the area off Dakar (Figure 1) to fish for yellowfin tuna. This fishery expanded and by 1960 was operative year-round between the Canary Islands and Point Noire. Purse seiners entered the fishery in the early 1960's. Carrying capacity of the combined purse seine and baitboat fleets has increased steadily through the 1960's and 70's and currently stands at more than 60,000 mt (Table 1). Principal participants in the fishery are the FISM (French, Ivory Coast, Senegal and Moroccan) and Tema-based baitboat fleets (the latter including Japan, Korea, Panama and Ghana), and the FISM, Spanish, and U.S. purse seine fleets (Table 2, Figure 2). These fleets, which exploit yellowfin, bigeye, and skipjack tuna, have increased their combined effort continually since 1968.

Skipjack tuna catches in the western Atlantic are quite small (less than 10% of the total) compared to the eastern Atlantic. Until 1980, the principal participants in this fishery were baitboats from Cuba and purse seiners from the United States (Figure 3) fishing in the Caribbean. In 1980, catches by Brazilian baitboats off Brazil were estimated at 7,000 mt or about 80% of the projected 1980 catch for the western Atlantic.

I.B. Trends in Catch and Effort

During the period 1969-1979, catches of skipjack in the total Atlantic varied between 60,000 and 117,000 mt (Figure 4). The 1980 catch was projected to be 109,000 mt.

I.B.1. Eastern Atlantic Fishery

Catches in the eastern Atlantic fluctuated between 26,300 mt and 113,200 mt during 1969-1979. The carrying capacity of the combined eastern Atlantic baitboat and purse seine fleets has increased steadily since 1968 (Figure 5). During this period, the number of U.S. purse seiners fishing in the eastern Atlantic has fluctuated between 9 and 40 ships, with 12 U.S. purse seiners fishing in the eastern Atlantic in 1979 (Figure 6). Fishing effort on skipjack tuna in the eastern Atlantic, as indexed by data for the FISM purse seine fleet, increased markedly (Figure 7) from less than 30,000 standard days fishing (SDA) in 1972 to more than 65,000 SDA in 1973. Since then, FISM skipjack effort has fluctuated between 40,000 and 60,000 SDA per year. The level in 1979 was about 58,000 SDA days per year.

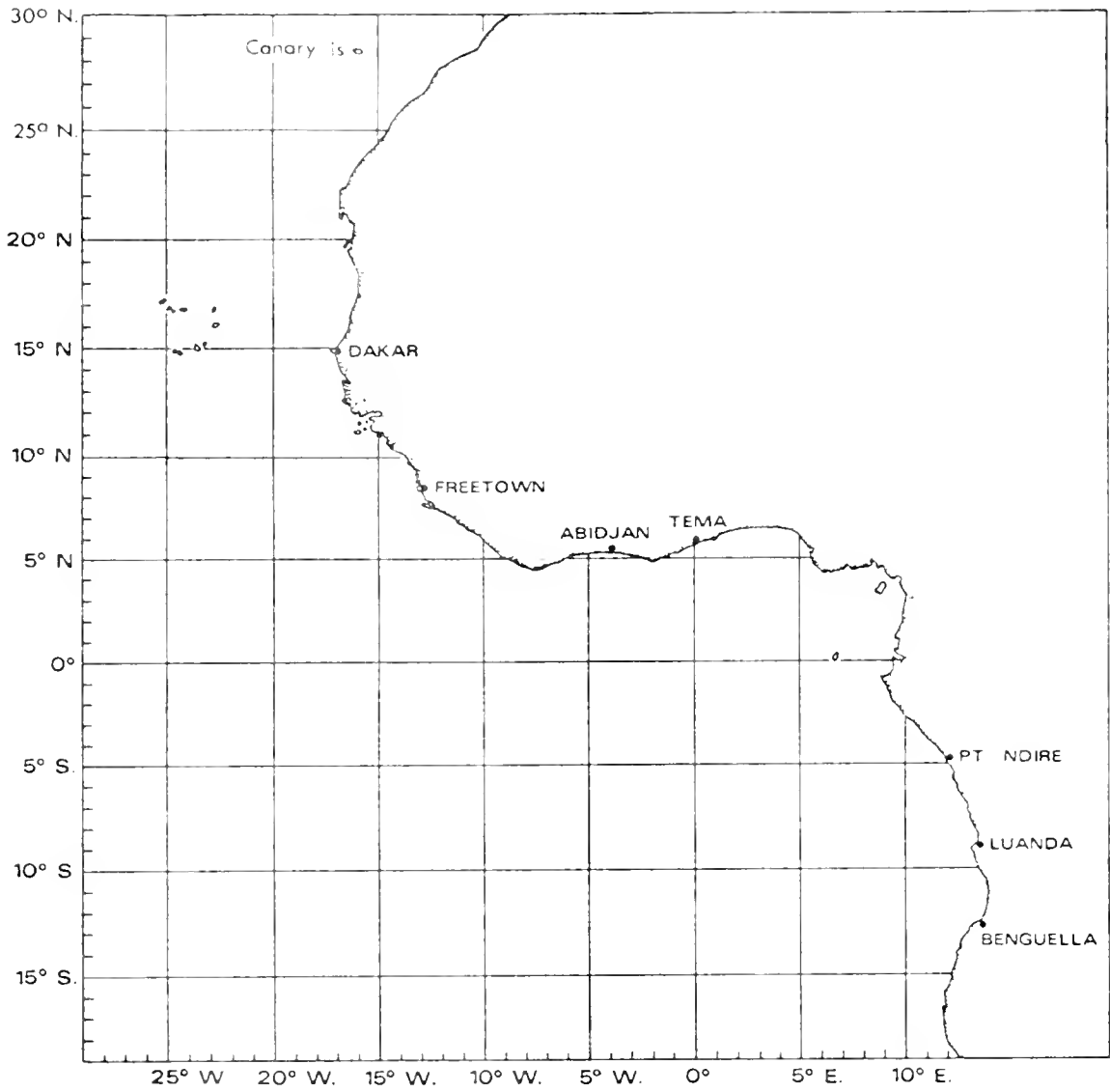

Figure 1. Area in the eastern tropical Pacific where skipjack tuna fisheries began to develop around 1955.

Table 1. Estimated carrying capacity (thousands of metric tons) for purse seiners and baitboats fishing in the eastern Atlantic Ocean.

	1968 ¹	1969 ²	1970 ²	1971 ²	1972 ²	1973 ²	1974 ²	1975 ²	1976	1977	1978	1979	1980 ⁶
Carrying capacity													
BB - Ivory Coast-Senegal.....	3.9	3.6	3.4	2.8	2.7	2.1	2.0	1.8	1.3	1.2	1.3	1.3	1.3
BB - Tema-based ⁴	1.2	0.9	0.9	1.2	2.6	4.0	5.4	3.6	5.4	5.4	5.4	3.6	3.0
Total BB	5.1	4.5	4.3	4.0	5.3	6.1	7.4	5.4	6.7	6.6	6.7	4.9	4.5
Others ⁵											1.9	1.9	
PS - FIS	1.6	4.8	5.8	7.2	9.2	12.4	14.5	17.2	17.5	17.0	18.9	19.5	19.5
PS - Spain	1.1	1.2	2.7	3.6	5.6	7.5	9.1	14.0	17.2	20.4	24.3	25.2	28.8
PS - U.S.A. ³	0.6	4.4	5.4	3.8	7.9	2.9	5.5	10.4	1.7	4.2	10.5	3.2	3.7
PS - Others													5.0
Total PS	3.3	10.4	13.9	14.6	22.7	22.8	29.1	41.6	36.4	41.6	55.6	49.8	56.0
Total BB + PS	8.4	14.9	18.2	18.6	28.0	28.9	36.5	47.0	43.1	48.2	62.3	54.7	61.0

1. Estimates from ICCAT Biennial Report, 1974-75, Part II (1975).

2. Estimates for 1969-1975 from Peter Miyake (SCRS/77/13) (except FIS).

3. U.S.A. estimate weighted by the number of months on the spot.

4. Includes Japan, Korea, Panama and Ghana.

5. Portugal

6. Provisional estimates.

7. Ghana, Congo, USSR

Table 2. Atlantic skipjack catch (1000 MT).

	1969	1970	1971	1972	1973	1974	1975	1976	1977	1978	1979	1980 ¹
TOTAL	29.1	49.5	75.1	72.6	76.0	117.2	61.4	76.6	117.1	106.6	88.9	109.2
SURFACE - EAST ATLANTIC	26.3	46.9	72.4	71.0	72.8	113.2	57.3	72.9	113.7	99.7	80.3	97.2
-PURSE SEINE	14.8	31.1	50.0	50.6	51.3	76.5	37.6	35.2	63.9	59.3	38.6	64.6
FIS	2.0	8.8	14.2	14.8	8.4	24.0	11.5	15.4	28.8	22.9	15.7	27.1
JAPAN	.7	3.5	6.2	3.4	1.5	.9	.1	0.	0.	0.	0.	0.
SPAIN	6.4	6.5	12.2	20.2	10.7	31.6	18.1	16.8	27.0	24.9	18.5	32.0
USA	4.7	11.8	16.2	12.2	21.2	20.0	7.4	1.8	5.9	6.0	2.1	3.5
OTHERS	.1	.6	1.2	.1	1.3	.1	.5	1.2	2.3	4.7	2.3	2.0
-BAITBOAT	11.4	15.8	22.3	20.2	21.5	36.5	15.2	27.5	40.3	38.5	40.6	31.5
ANGOLA	1.8	.9	1.9	1.5	1.3	3.4	.6	1.5	3.8	3.2	3.6	5.1
FIS	3.7	4.4	5.8	3.8	3.3	4.5	1.8	2.2	2.7	3.3	3.3	2.9
GHANA	0.	0.	0.	0.	.1	.7	1.3	2.1	3.5	2.6	3.9	
JAPAN	4.9	7.5	11.7	10.1	13.0	18.7	3.7	15.0	16.5	14.6	14.7	20.0
KOREA + PANAMA	0.	0.	0.	.7	1.1	3.1	6.3	4.4	7.6	11.1	13.9	
SPAIN	.8	1.8	2.7	4.1	2.6	5.4	.8	.6	.7	.5	1.3	1.5
OTHERS	.1	1.1	.1	.0	.1	.7	.7	1.6	5.2	3.1	0.	2.0
-OTHER GEARS	.1	0.	.1	.1	.0	.1	4.5	10.2	9.4	1.9	1.1	1.1
-SURFACE - WEST ATLANTIC	.1	0.	1.6	1.3	2.5	3.1	3.2	3.5	3.0	6.3	5.4	9.0
Brazil											1.9	7.0
SURFACE - UNCL. REGION	0.	0.	.2	0.	0.	0.	0.	0.	0.	0.	0.	0.
UNCL. GEARS	1.7	2.6	.8	.3	.7	.9	.8	.2	.4	.6	3.3	3.0

1. Preliminary estimates.

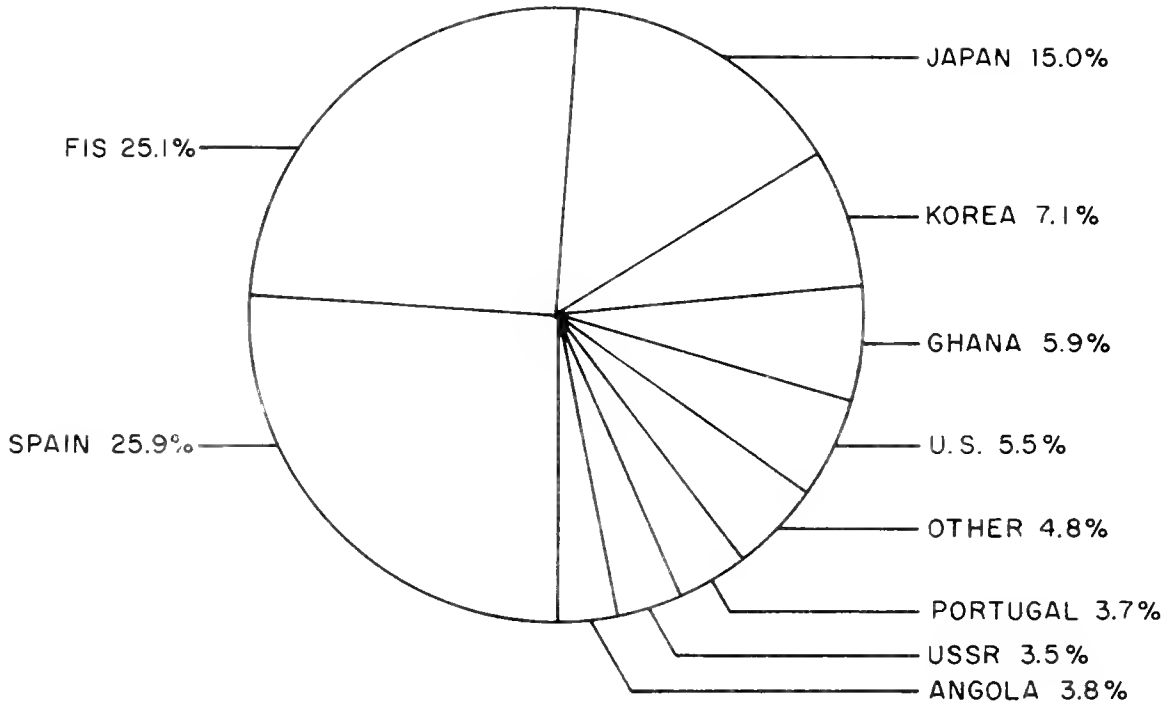

Figure 2. a) Percentage of annual catch by country for eastern Atlantic skipjack tuna 1975-79. Average annual catch is 86,539 mt.

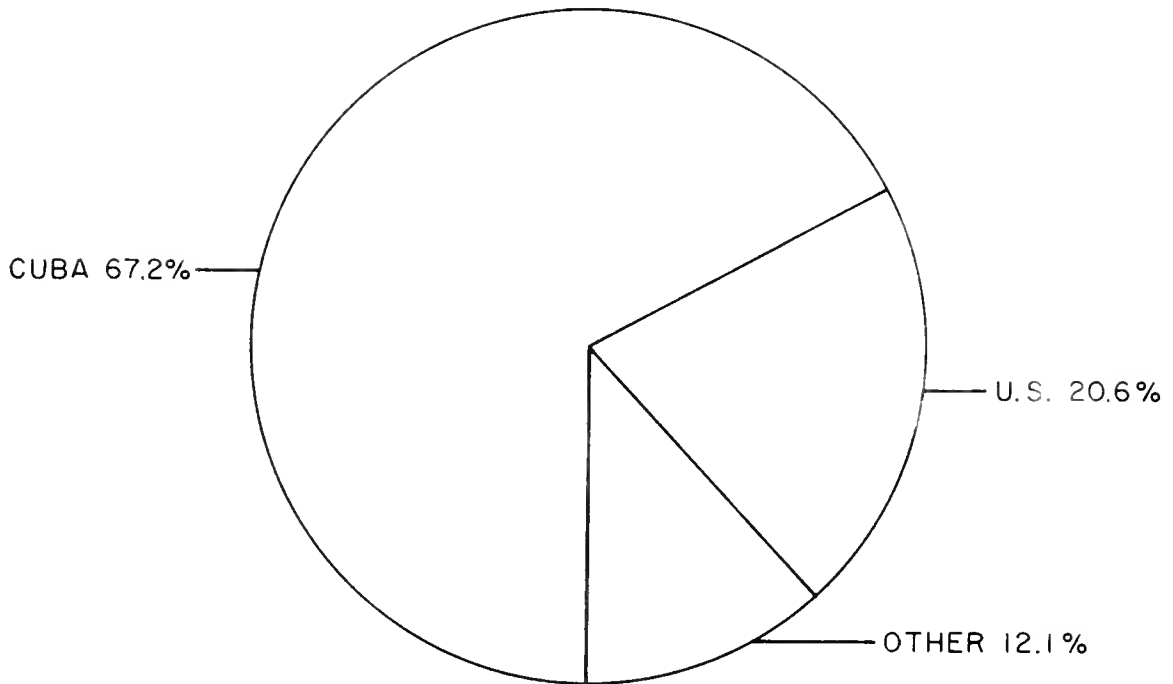

Figure 3. Percentage of annual catch by country for western Atlantic skipjack tuna, 1975-79. Average annual catch is 3,361 mt.



Figure 4. Total and U.S. skipjack tuna catch for the eastern Atlantic, 1966-80. 1980 value is estimated.

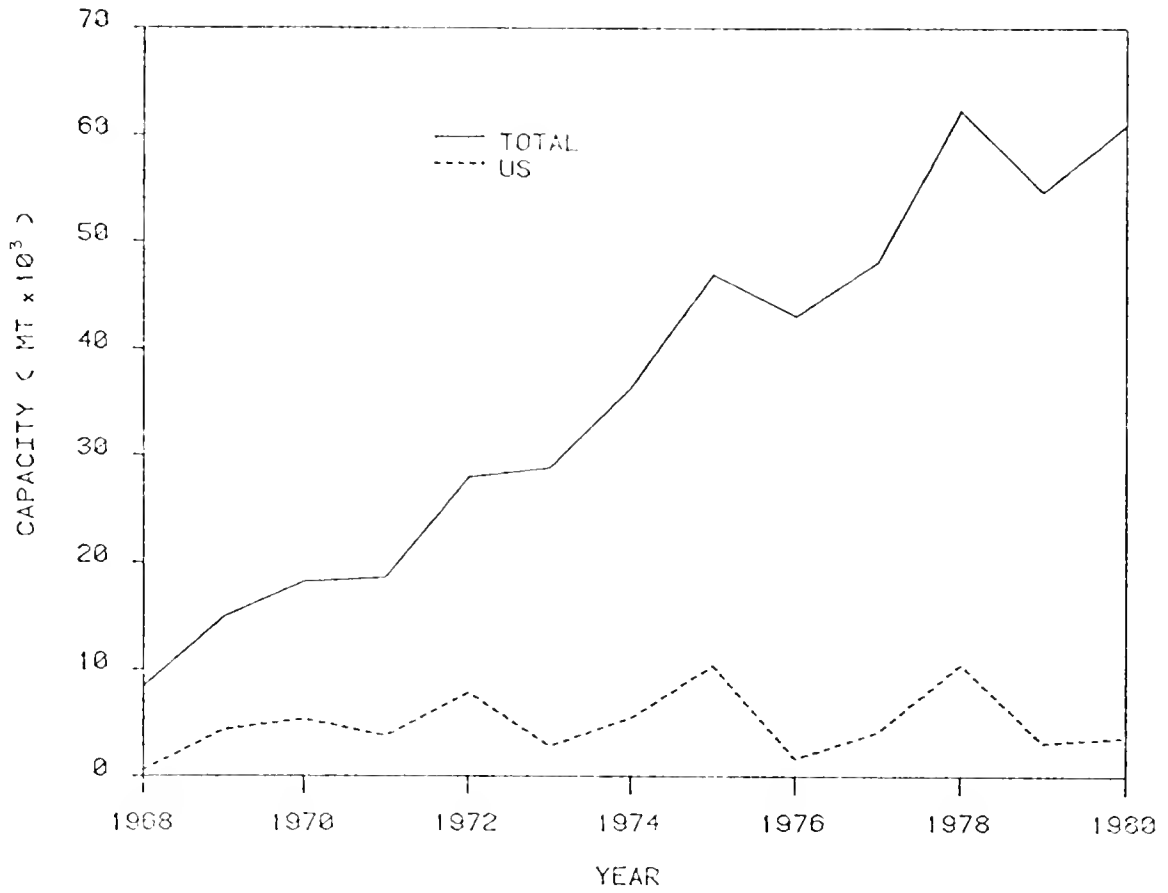

Figure 5. Carrying capacity of the baitboat-purse seine fleet in the eastern Atlantic, 1968-80. 1980 value is estimated.

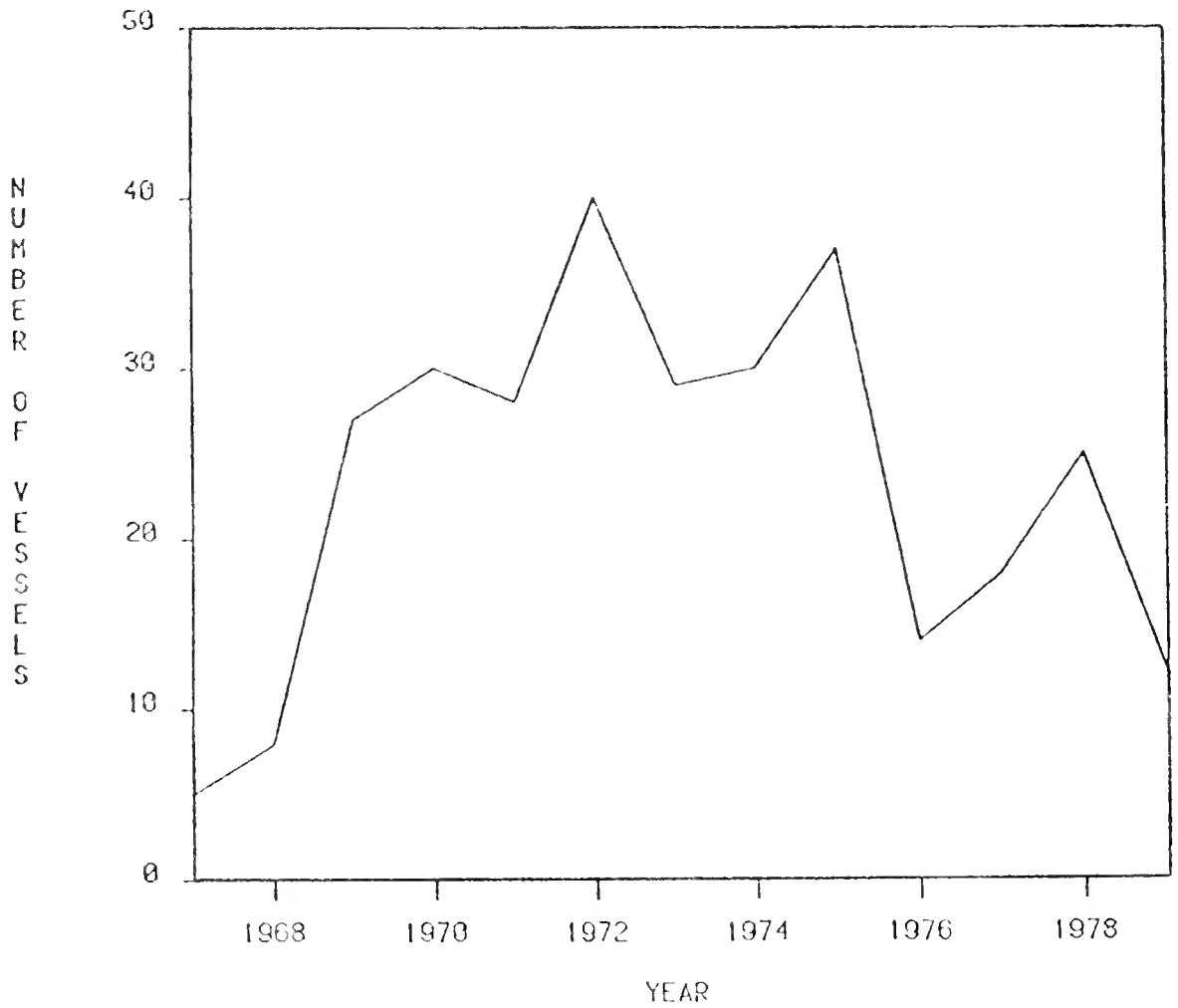

Figure 6. Number of U.S. purse seiners fishing in the eastern Atlantic, 1968-79.

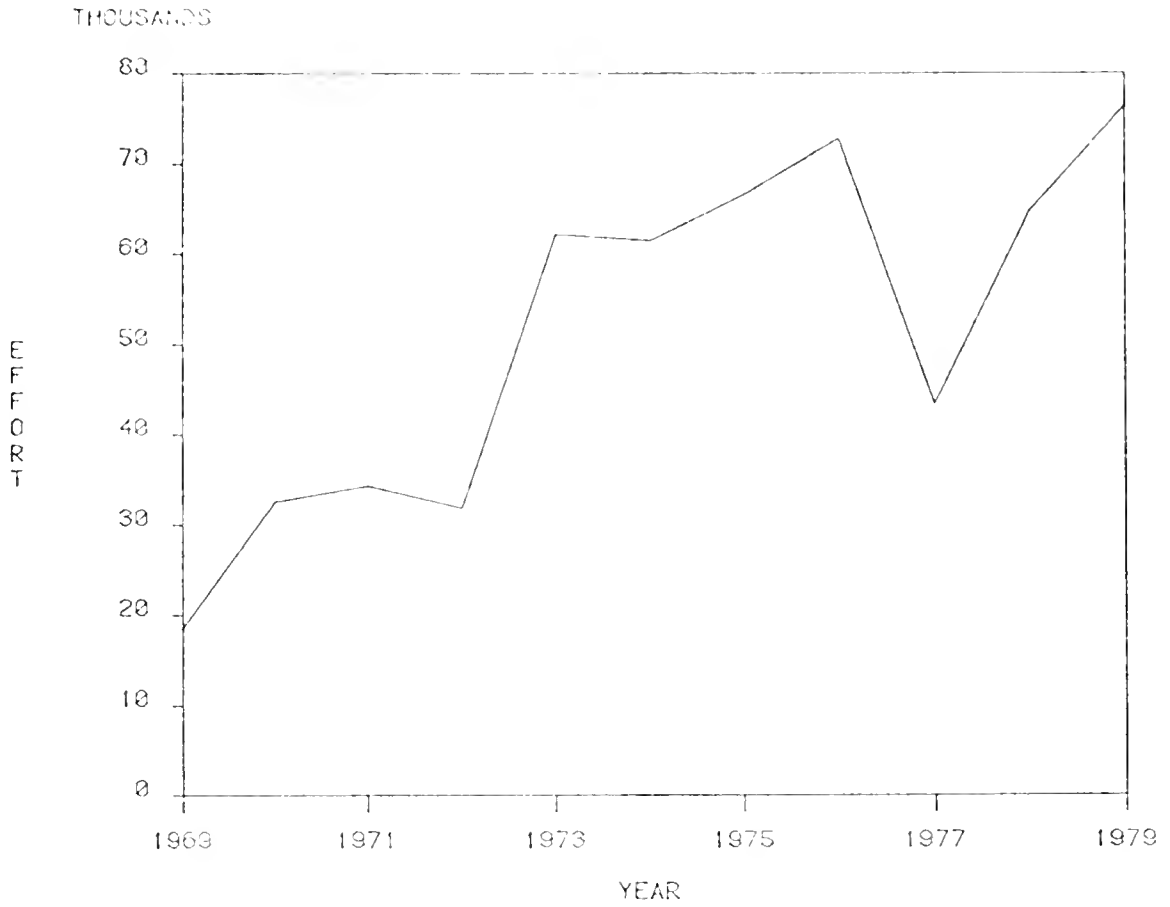

Figure 7. Fishing effort for skipjack tuna in standard days fishing per year for the eastern Atlantic, 1969-79.

I.B.2. Western Atlantic Fishery

Skipjack catches in the western Atlantic have fluctuated markedly in recent years. From 1966 through 1972, the catch varied from 1500 mt to 2700 mt, with a slight downward trend over time (Figure 8). Since 1972 the catch trend has been generally upward, increasing much more sharply in 1978 with the addition of the Brazilian catch.

The United States fleet has traditionally been only marginally involved in the western Atlantic skipjack tuna fishery. The U.S. catch peaked at 1700 mt in 1978, then declined to 730 mt in 1979. No fishing effort data are available for the western Atlantic.

I.C. Value of Catch

In 1979, skipjack tuna weighing less than 1.8 kg brought an average of \$635/mt in the U.S., while skipjack larger than 1.8 kg brought \$771/mt. Assuming an average of \$703/mt, the value of the 1979 eastern Atlantic catch (75,600 mt) was in excess of \$53 million. The U.S. portion of the catch had a value of more than \$3.9 million. At the average 1980 U.S. price (\$952/mt), the 1980 eastern Atlantic skipjack catch (99,900 mt) had an estimated value of more than \$95 million.

Based on an average value of \$703/mt, the 1979 western Atlantic catch of skipjack had a value of more than \$2.4 million. The U.S. portion of this catch had a value of \$574,000. The 1980 western Atlantic catch had an estimated value of about \$8.9 million (\$952/mt).

In 1978 United States tuna processors imported more than 50,000 mt of Atlantic skipjack which, at an average value of \$632/mt, had a value of more than \$31 million.

I.D. Current Management of the Fishery

There are presently no ICCAT or U.S. regulations for Atlantic skipjack tuna in effect. It should be noted that ICCAT minimum size regulations are in effect for both Atlantic yellowfin and bigeye tunas. Since these tunas are taken in a multispecies fishery with skipjack tuna in the eastern Atlantic, these regulations impact the skipjack tuna fishery.

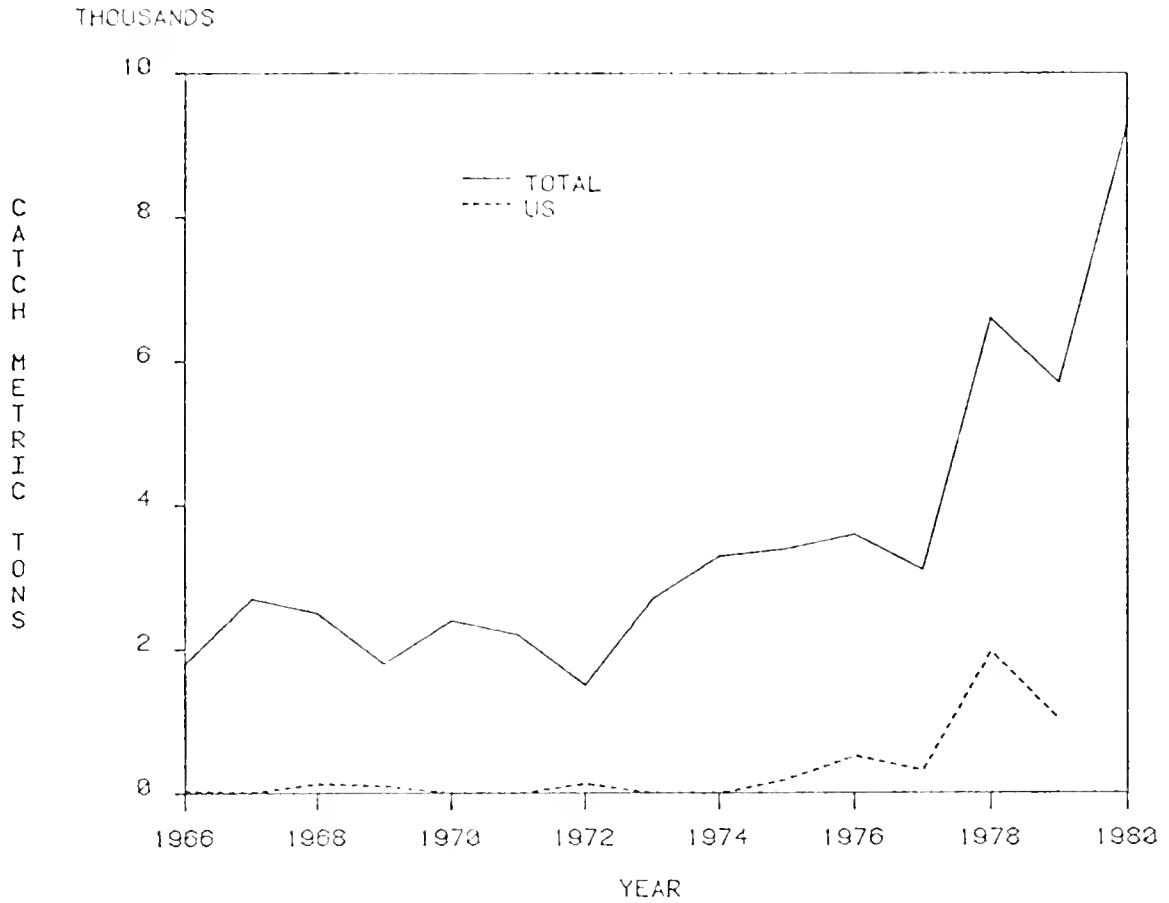

Figure 8. Total and U.S. skipjack tuna catch for the western Atlantic, 1966-80. 1980 value is estimated.

II. NATURE AND SIGNIFICANCE OF U.S. AND FOREIGN PARTICIPATION IN THE FISHERY

II.A. Eastern Atlantic Fishery

Significant United States participation in the Atlantic skipjack tuna fishery began in 1967 with three U.S. tuna purse seiners fishing off Africa. Their success attracted other U.S. seiners to the eastern Atlantic fishery. In 1972, 40 American tuna seiners in the eastern Atlantic fishery caught 12,000 mt of skipjack tuna. Since then American participation has fluctuated between 6 (1980) and 37 vessels (1975). The largest U.S. catch (21,200 mt) was taken in 1973 by 29 purse seiners. The 1980 U.S. catch is projected to be 2,700 mt, 3% of the eastern Atlantic total. The bulk of the skipjack tuna catch in the eastern Atlantic is made by FISM and Tema-based baitboats and FISM seiners. Their catch is expected to account for 50% of the 1980 total catch. Spanish purse seiners are expected to catch about 32% of the 1980 total. In recent years, the catches of Angola, Portugal, and the USSR have increased. Two Soviet purse seiners are reported to have fished in the Gulf of Guinea in 1980.

II.B. Western Atlantic Fishery

Fishing by U.S. seiners in the western Atlantic has been primarily by seiners transiting between the Gulf of Guinea and Puerto Rico or the eastern tropical Pacific. Since 1975, however, U.S. seiners have spent more time searching for skipjack in the western Atlantic, and have accounted for almost 20% of the total (Figure 3) through 1979. The catches of both Cuba and the U.S., who together took 88% of the total catch, have been relatively constant in recent years (1971-77). These catches have been almost exclusively from the Caribbean.

A new fishing area off Brazil and Argentina is currently being exploited by Brazilian baitboats. Catches for this area totaled 670 mt in 1978. This figure jumped to 1900 mt in 1979 and was projected to be 7000 mt for 1980. This new area is quite large and appears to have potential for increased exploitation.

III. STATUS OF THE STOCKS

Due to the nature of the fishery (i.e., primarily surface gears exploiting only one young age group), population assessment techniques utilized for other tuna species give inconclusive results for skipjack. The need for further information to assess stock status is emphasized by the International Skipjack Year program currently being coordinated by ICCAT.

III.A. Stock Structure

Little is known about the structure of Atlantic skipjack tuna stocks. A separate east-west stock has been hypothesized and indeed skipjack catch has been traditionally segregated into eastern and western Atlantic components. Results of tagging programs in 1980 by the United States in the Caribbean, the Spanish in the Canary Islands, and the Japanese in the Gulf of Guinea should provide information bearing on this problem.

III.B. Stock Assessment and Fishery Evaluation

III.B.1. Trends-in-Catch-per-Unit-Effort

Available skipjack tuna catch-per-unit-effort (CPUE) estimates for the eastern Atlantic include those for the FISM and Tema-based fleets. These estimates are dissimilar because they are based on different units of effort. In addition, neither of these eastern Atlantic CPUE estimates provides a valid index of abundance because skipjack availability varies markedly from year to year. This problem is further complicated by some vessels, including FISM fleet units, fishing skipjack only in times of low yellowfin/high skipjack availability. The FISM and Tema-based fleet CPUE indices, are, however, the only information available for inferring skipjack abundance in the eastern Atlantic.

The FISM estimate is considered to be the most representative of the two eastern Atlantic CPUE estimates and is presented in Figure 9. CPUE for 1969-1979 fluctuated between one and three metric tons per fishing day, with no apparent trend over time.

No CPUE index currently exists for the western Atlantic.

III.B.2. Results of Production Model Analysis

Plots of fishing effort, catch, and CPUE from the FISM purse seine fleet in the eastern Atlantic are presented in Figure 10. Attempts to fit the production model to these data have failed to produce a viable relation between surplus production and effort. Due to spotty fishing effort and small catches in the western Atlantic (9,000 mt annually), production model analysis for western Atlantic has not been attempted.

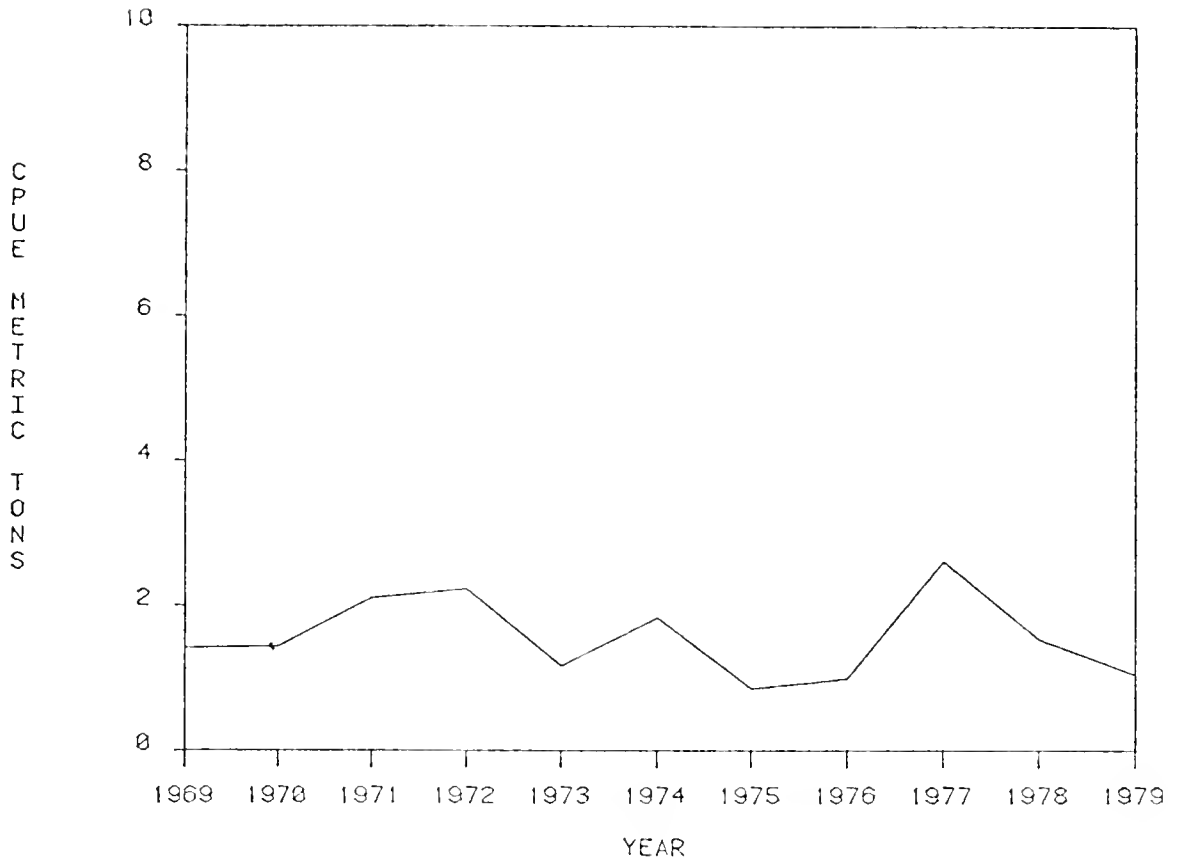

Figure 9. Average catch-per-unit-effort (CPUE) for skipjack tuna in the eastern Atlantic, 1969-79.

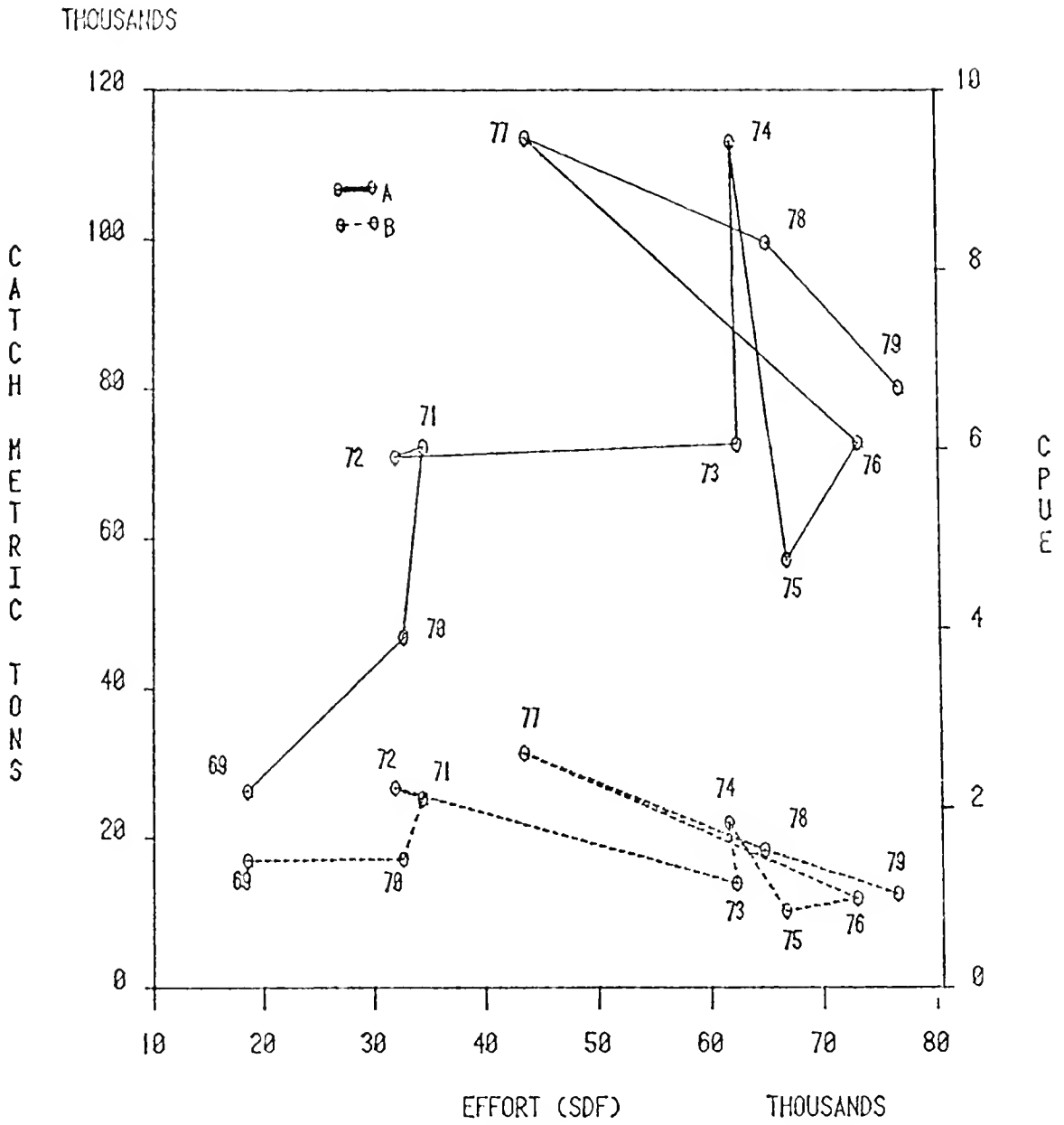

Figure 10. a) Relation between catch (mt) and effort (SDF-standard days fishing), 1969-79.

b) Relation between CPUE (mt/SDF) and effort (SDF), 1969-79.

III.B.3. Results of Yield-per-Recruit Analysis

A yield-per-recruit analysis for eastern Atlantic skipjack was performed at the second ICCAT workshop on juvenile tunas held in Brest, France, in 1980. In formulating the analysis, the workshop participants noted that uncertainties associated with identification of year-classes due to year-round spawning of eastern Atlantic skipjack made the resultant analysis questionable. This analysis (Figure 11) indicates that for high and low levels of skipjack tuna recruitment there is little benefit to be expected from an increase in the age-at-first-capture.

III.B.4. Results of Spawner/Recruitment Analysis

No spawner/recruit analysis is available for Atlantic skipjack tuna stocks.

III.B.5. Results of Other Analysis Simulations

None available.

III.C. Current Evaluation of Stocks and the Fishery

Skipjack tuna in the eastern Atlantic are currently fished at a high level while western Atlantic skipjack are fished at a low level. The yield from the stock(s) is unknown, but available information suggests that the potential yield is larger than current catch levels indicate, especially in the western Atlantic.

IV. STATUS OF CURRENT RESEARCH NEEDS AND EFFORTS

Major research activities for Atlantic skipjack tuna are currently underway in conjunction with ICCAT's International Skipjack Year Program. To date they include tagging of skipjack and collection of data for maturity/fecundity studies, ageing studies, stomach analysis, and environmental studies. Further research and data collection by ICCAT participants are planned for 1981 in these areas and in the areas of exploratory fishing, improved fishery statistical sampling, and larval studies.

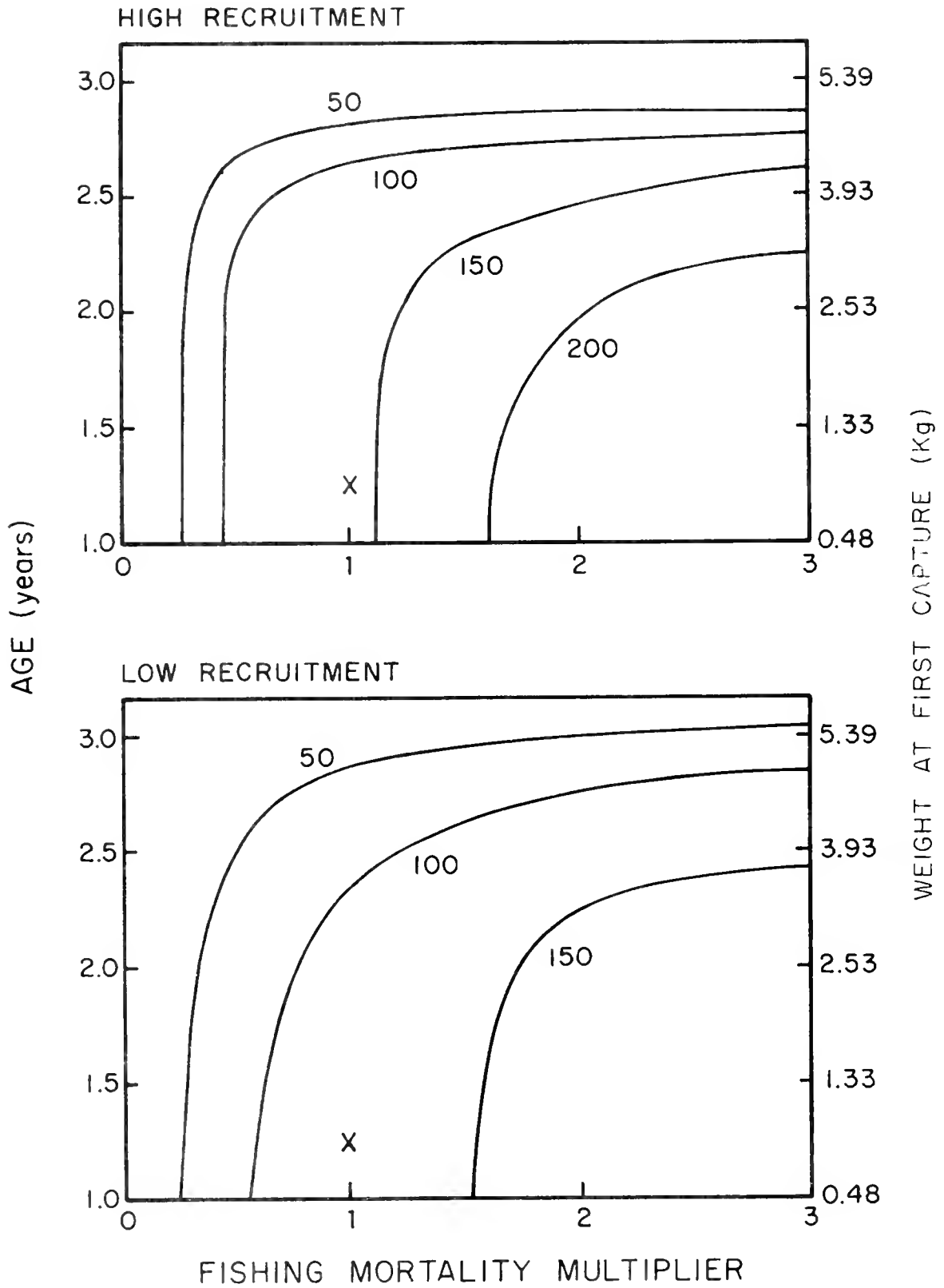

Figure 11. Equilibrium yield-per-recruit for Atlantic skipjack for two hypothetical recruitment levels (A - high recruitment of 356×10^6 fish; B - low recruitment of 143×10^6 fish) for combination of fishing mortality multiplier and age (weight at first capture). X = present situation.

IV.A. Major Research Problems

1) Improved skipjack tuna fishery statistics must be collected to allow accurate assessment of stock condition and development of management strategies. This applies to traditionally fished areas as well as areas with developing fisheries (such as off Brazil and Ascension Island).

2) No reliable index of abundance currently exists for eastern Atlantic skipjack stocks. CPUE indices computed from data for FISM and Tema-based fleets use different units of effort and therefore cannot be compared. In addition, CPUE for the FISM fleet is not thought to be proportional to skipjack abundance because vessels fish for this species only in times of low yellowfin availability. No viable abundance index exists for eastern or western Atlantic skipjack fisheries.

3) Minimum size regulations for bigeye and yellowfin tuna affect skipjack tuna fisheries because all three species may be captured in the same time/area. The impact of these regulations on skipjack fisheries needs to be assessed. Such assessment can be used to infer the efficacy of alternate management schemes for conserving yellowfin and bigeye (e.g. time/area/closures).

IV.B. Current Research Efforts

1) Improved estimates of the skipjack length/weight relation, natural mortality, and growth have been developed.

2) A preliminary assessment of the effects of minimum size regulations for bigeye and yellowfin on skipjack catch has been performed.

3) Sex ratios and age at maturation of skipjack landed at Dakar (1977-79) have been determined.

4) Migration patterns for skipjack dart-tagged and tetracycline-marked in the Canary Islands (1979-80) have been examined.

5) Skipjack caught south and southeast of Brazil between 1978 and 1980 have been examined to determine length/weight and gilled-gutted weight/weight relationships.

6) School species composition and aggregation phenomena associated with tuna schools in the Gulf of Guinea (1979-80) have been examined.

7) Current status of Atlantic skipjack stocks have been assessed using production model analysis techniques.

8) The use of sea surface temperature as an index for partitioning fishing effort on skipjack and yellowfin tuna has been examined.

9) The economic value of eastern Atlantic tuna fisheries has been assessed.

IV.C. Future Research Needs

Proposed future research projects are listed below, together with suggested methods of study and sources of information.

IV.C.1. Suggested Approach and Methods

1) Catch/effort data from FISM and Tema-based fleets need to be examined to verify or establish suitable CPUE indices for eastern Atlantic skipjack tuna stock(s). The feasibility of applying these same techniques to catch/effort data for the western Atlantic should then be assessed.

2) Distribution and migration patterns of Atlantic skipjack stocks need to be examined using tag return results from ISY tagging programs.

3) Growth and stock structure of eastern and western Atlantic skipjack stocks need to be compared using data to be collected by ISY programs (e.g., length/frequency data for skipjack captured off Brazil, Ascension Island, and in the Gulf of Guinea).

4) Location, seasonality, intensity, and physiological triggering mechanisms related to skipjack spawning need to be examined.

5) Preliminary assessments of interactions of small yellowfin, bigeye, and skipjack have been performed. The techniques and data used in these assessments need to be re-examined and preliminary results verified or altered as required.

6) Environmental data taken during the SWFC skipjack tagging cruise in the Caribbean should be compared with skipjack school sightings to determine if these results agree with published environment/availability relations for other geographic areas.

7) The identification of skipjack habitat vulnerable to surface fishing gear off Brazil and Argentina (Figure 12) in 1979 preceded the establishment of a substantial fishery in that area in 1980. The seasonal and areal fluctuations of this habitat area need to be examined.

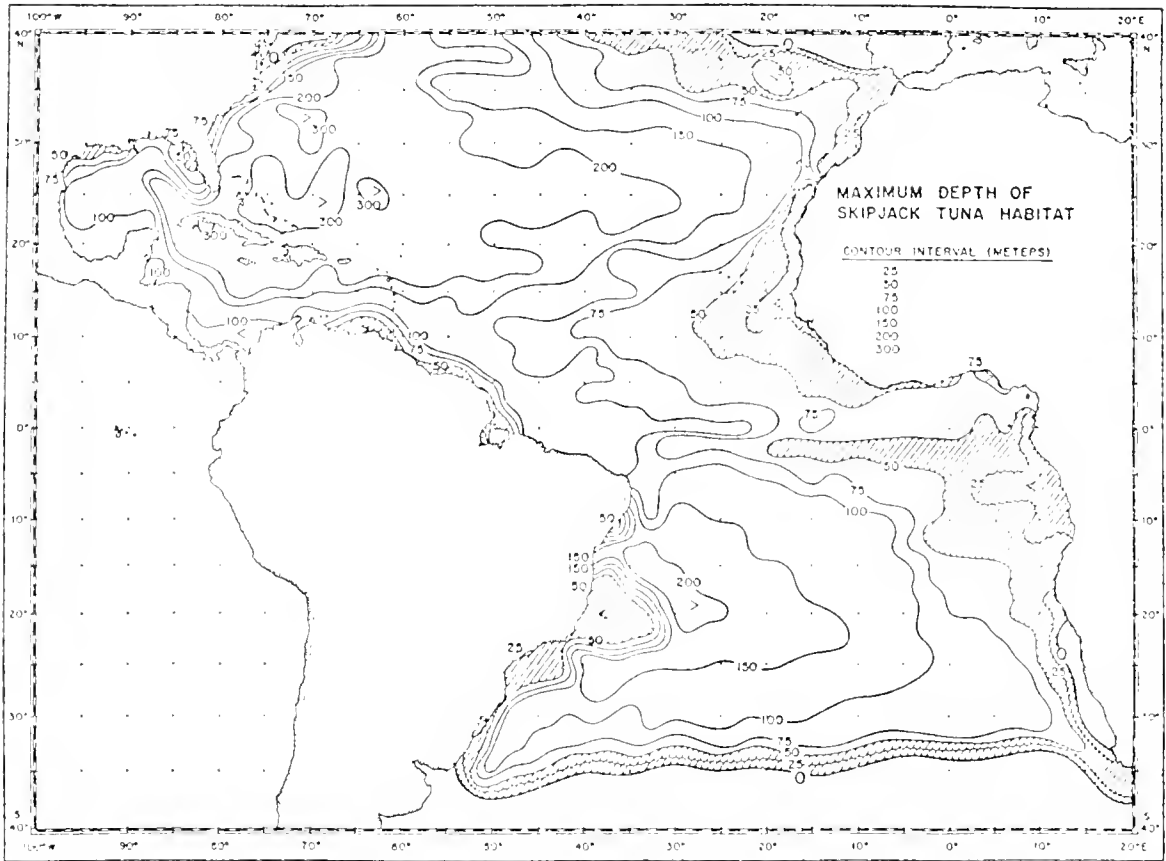

Figure 12. Annual mean contours of maximum depth of skipjack tuna habitat. Hatched areas indicate habitat depths of less than 50 meters.

8) An assessment of potential skipjack biomass in the area indicated in (7) above should be undertaken to determine if the area can support a substantially larger fishery.

IV.D. Status of SWFC Data Base

La Jolla Laboratory data bases for Atlantic skipjack tuna contain all available fishery data. Ancillary marine environment data bases necessary for the studies proposed in (6), (7), and (8) of Section IV.C.1. are at PEG.

STATUS REPORT: SOUTH ATLANTIC ALBACORE

by

Norman Bartoo

Southwest Fisheries Center
Oceanic Fisheries Resources Division
La Jolla, California

ABSTRACT

Annual catches from the south Atlantic albacore stock have remained near 22,000 mt for the last few years. Current annual effort levels are near 100 million hooks, the level reached in 1972. Available evidence indicates that the stock is currently producing catches about 25% below estimated MSY and that a relatively high yield-per-recruit of about 7.7 kg is being realized. The south Atlantic albacore fishery supplies about 40% of the U.S. annual consumption through imports.

I. DESCRIPTION OF THE FISHERY

Albacore in the Atlantic Ocean are distributed from approximately 50° N to 40° S latitude although most catches come from temperate waters (Figure 1).

I.A. History of the Fishery

The south Atlantic fishery began in 1956 when longliners, principally from Japan, began fishing in the Atlantic. Japan dominated the industry from 1956 through the mid-1960's. Since then Taiwan and Korea have greatly increased their share of the catch (Figure 2).

I.B. Trends in Catch and Effort

Albacore catches in the south Atlantic rose steadily from 20 mt in 1956 to an early peak of 36,000 mt in 1966. Following a 45% drop in recorded catch in 1967, the catch rose erratically to a record high of 42,000 mt in 1972. Since 1972 the catch has been in the 20,000 to 23,000 mt range (Figure 3), with a reported catch in 1979 of 22,000 mt. Longline effort has increased from near zero in 1956 to a peak of 100 plus million effective hooks in 1972 and 1973. Since 1973, effective effort has remained high, near 100 million hooks.

I.C. Value of Catch

Reliable ex-vessel price data for foreign fleets are not readily available. Assuming a value of \$1,800 per mt (the approximate price paid U.S. fishermen), the south Atlantic albacore catch averaged about \$36 million per year from 1973 to 1977. The 1979 catch was worth about \$40 million.

I.D. Current Management of the Fishery

There are no international fisheries management measures currently in force for the south Atlantic albacore stock.

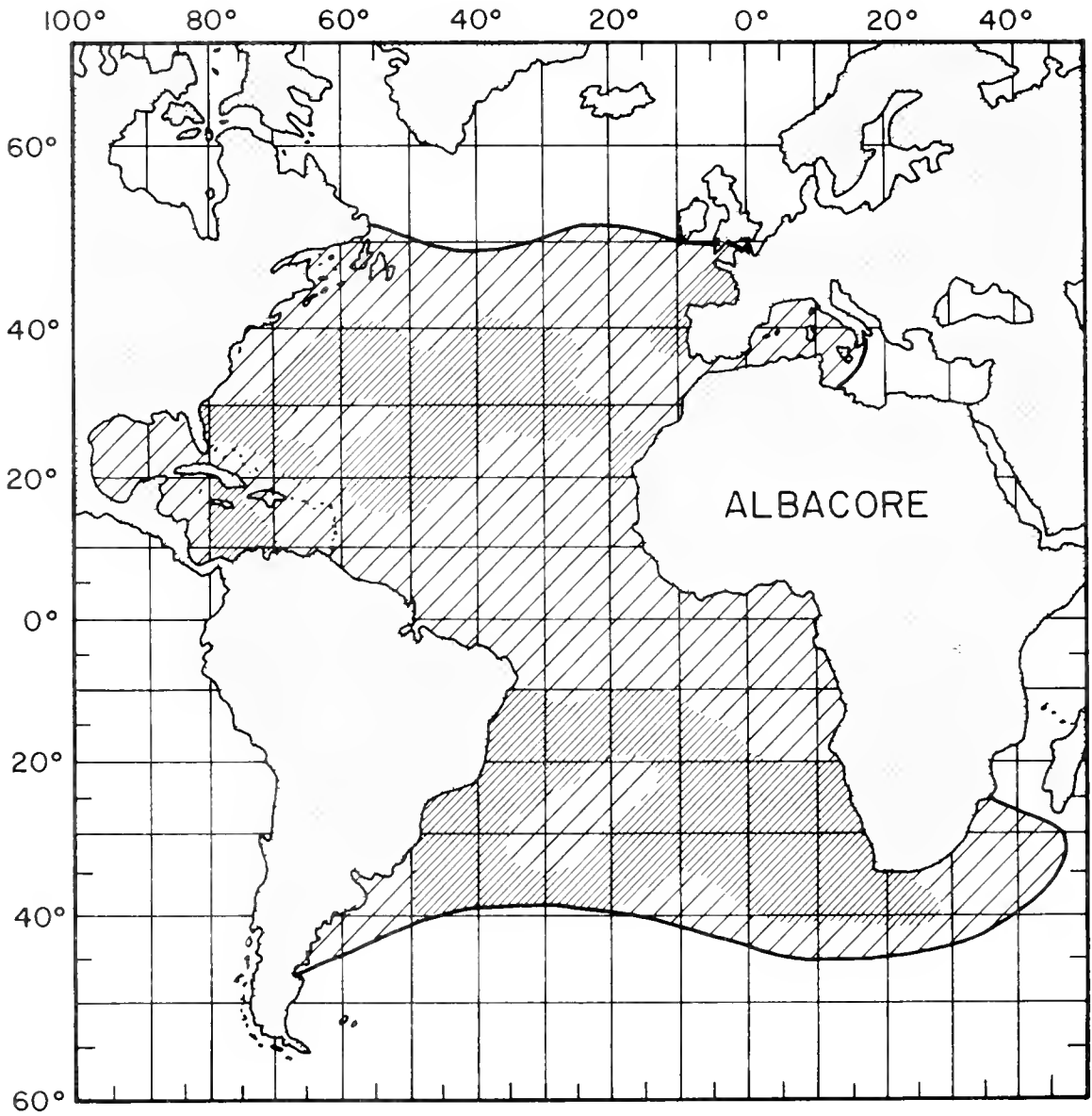

Figure 1. General distribution of albacore in the Atlantic (bold hatching) and location of fisheries (fine hatching).

SOUTH STOCK

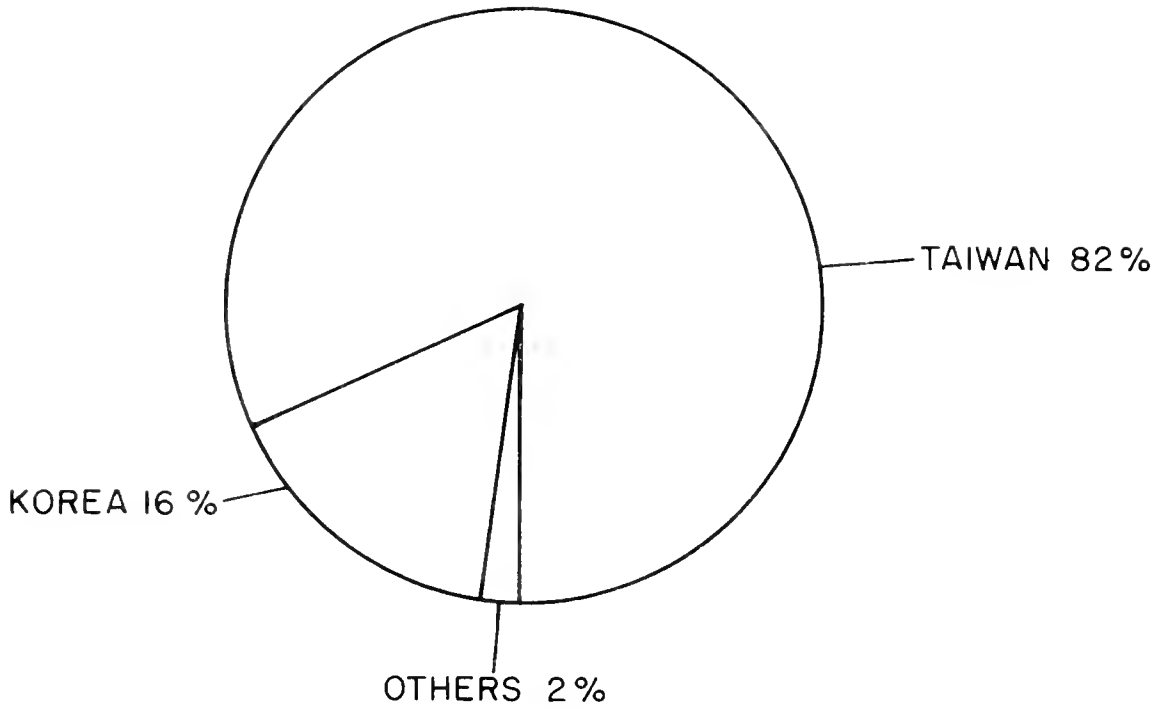

Figure 2. Percentages of south Atlantic albacore catches taken by major fishery participants.

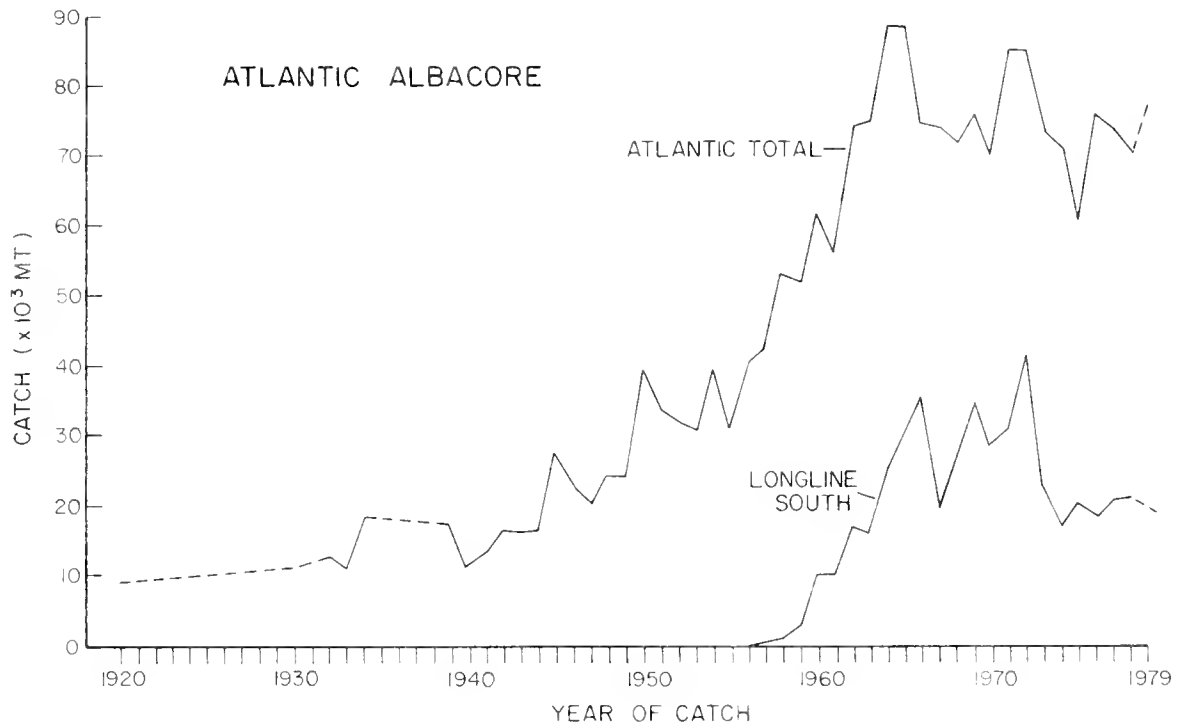

Figure 3. Comparison of annual catch of south Atlantic albacore by longline fishery to Atlantic total (north stock surface, south stock longline, and north stock longline fisheries).

II. NATURE AND SIGNIFICANCE OF U.S. AND FOREIGN PARTICIPATION IN THE FISHERY

The U.S. does not actively participate in the south Atlantic albacore commercial fisheries, but is interested in the south Atlantic albacore stock. The U.S. is a signatory to the ICCAT convention and as such has indicated its willingness to conserve the Atlantic tuna stocks.

About 45% of the total Atlantic albacore catch, mostly caught by longline, is imported into the U.S. for domestic consumption. This imported Atlantic albacore accounts for about 40% of the total annual U.S. albacore consumption. The remaining 60% comes from imports from other oceans and domestic catches. For comparison, the U.S. domestic fishery provides about 15 to 20% of the albacore consumed in the U.S. The U.S. currently consumes about 45% of the world's total albacore catch.

III. STATUS OF THE STOCKS

III.A. Stock Structure

This analysis assumes that the Atlantic albacore population is composed of north and south stocks separated at the equator. The assumed stock separation is based primarily on longline catch rates which decline near the equator. Secondary support is given by the different reactions of the longline CPUE, both north and south, to increased fishing pressure in the north.

III.B. Stock Assessment and Fishery Evaluation

III.B.1. Trends in Catch-per-Unit-Effort

The south stock is fished only by longline. The catch-per-unit-effort for the stock shows an expected gradual decline following a peak value in 1960 (Figure 4), indicating a reduction in adult abundance. Longline effort has increased from near zero in 1956 to a peak of 100 plus million effective hooks in 1972 and 1973. Since 1973 effective effort has remained high, near 100 million hooks.

III.B.2. Results of Production Model Analysis

Results of production model analysis for the south stock (Figure 5) indicate an estimated MSY in the 28,000 to 32,000 mt range. The catch in recent years has been below this level although catches in the

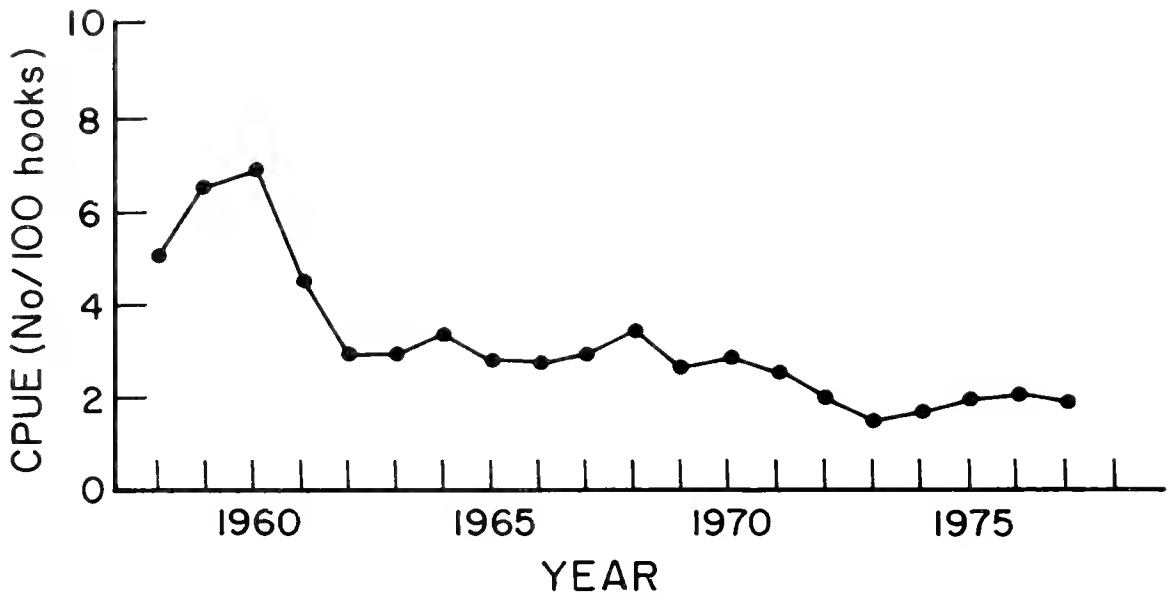

Figure 4. Catch-per-unit-effort for Atlantic albacore longline fisheries on the south stock.

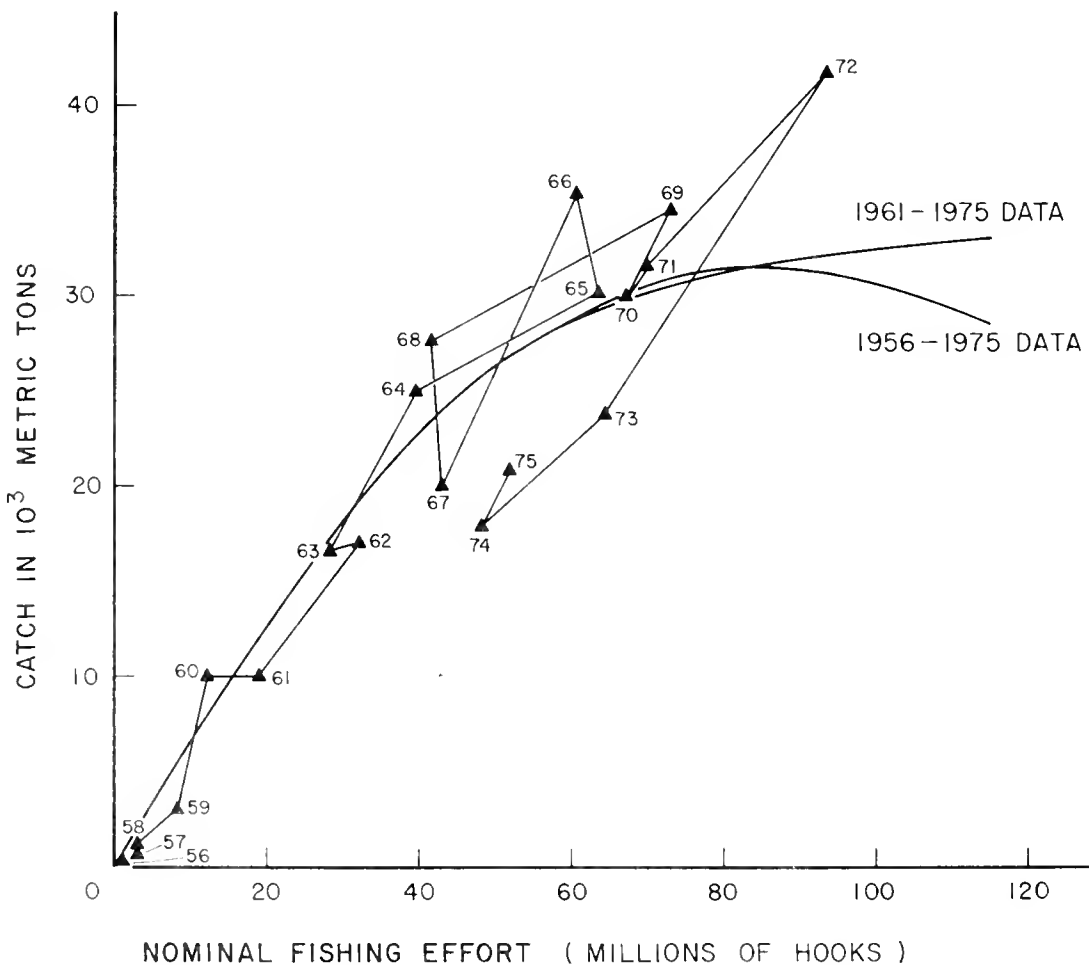

Figure 5. Production model results for south Atlantic albacore.

late 1960's and early 1970's were close to MSY. The 1979 catch of 22,000 mt was below MSY, with effort levels below that required for MSY.

III.B.3. Results of Yield-per-Recruit Analysis.

The south Atlantic fishery is producing a yield-per-recruit of about 7.7 kg. Because of the nature of the longline fishery, virtually no increase in yield-per-recruit is likely to occur by maintaining fishing effort and increasing size-at-first-capture. Furthermore, increases (up to 40%) in effort with the same size-at-first-capture will produce little change in yield-per-recruit values.

III.B.4. Results of Spawner/Recruitment Analysis

No spawner/recruit relationship has been established for this stock. Estimates of recruitment to age 3 from the 1960 to 1966 year-classes (from cohort analyses) show relatively constant values of about 3.6 million fish per year.

III.B.5. Results of Other Analyses/Simulations

None available.

III.C. Current Evaluation of Stocks and the Fishery

Evidence available for the south Atlantic albacore stock indicates the stock is currently being exploited about 25% below MSY. The stock appears to be producing a yield-per-recruit which is near the maximum for the mode of fishing used. No problems with recruitment have been found.

IV. STATUS OF CURRENT RESEARCH NEEDS AND EFFORTS

IV.A. Major Research Problems

The south Atlantic albacore stock has shown no immediate research needs although the representativeness of longline CPUE as an indicator of stock abundance should be investigated.

IV.B. Current Research Efforts

The current U.S. research effort on south Atlantic albacore is limited to monitoring the research efforts of foreign scientists through ICCAT.

IV.C. Future Research Needs

As stated, the representativeness of longline CPUE as an indicator of stock abundance should be investigated.

IV.D. Status of SWFC Data Base

The data base for south Atlantic albacore at SWFC is adequate and up-to-date. New data are supplied by ICCAT as available.

STATUS REPORT: NORTH ATLANTIC ALBACORE

by

Norman Bartoo

Southwest Fisheries Center
Oceanic Fisheries Resources Division
La Jolla, California

ABSTRACT

The north Atlantic albacore stock is fished by longline and surface gears. Surface catches (38,000 mt in 1979) have declined about 25% since 1960. Longline catches in 1979 were 11,000 mt. Available evidence indicates that MSY is about 60,000 mt, which is 10% to 15% above recent years' catches. Yield-per-recruit to the north Atlantic albacore fisheries is about 3.8 kg, with some increase possible with fishery changes. Recruitment indices indicate that spawning stock is low and recruitment highly variable. The fishery appears to be heavily exploited.

I. DESCRIPTION OF THE FISHERY

Albacore in the Atlantic Ocean are distributed from approximately 50° N to 40° S latitude, although most catches come from temperate waters (Figure 1).

I.A. History of the Fishery

The north Atlantic albacore fishery developed as a surface fishery (troll and baitboat) in the Bay of Biscay in the 1920's and continued as such until 1956 when an Atlantic-wide longline fishery developed. Both surface and longline fisheries have operated continuously from 1956 to the present.

Six relatively separate albacore fisheries (and participants) can be identified in the north Atlantic:

1) Surface (France and Spain) troll fishery - 2-5 year-old fish, mostly juveniles in the Bay of Biscay to the Azores.

2) Summer live-bait (Spain) fishery - 2-6 year-old fish, mostly juveniles in the Bay of Biscay.

3) Autumn live-bait (France and Spain) fishery - 5-12 year-old adults, from Spain to the Azores since 1974.

4) Year-round (Spain and France) live-bait fishery - 5-12 year-old adults, from the Iberian Peninsula to the Canary Islands, since 1970.

5) Winter (Taiwan) longline fishery - 4-7 year-old young adults, in the northern Atlantic.

6) Summer (Korea) longline fishery - 5-12 year-old adults in the northern Atlantic.

A total of 10 countries, Taiwan, Cuba, France, Grenada, Japan, Korea, Norway, Portugal, Spain, and Trinidad, have reported north Atlantic albacore catches to ICCAT. The vast majority of the reported recent years' catches have been made by France, Spain, and Taiwan in the fisheries noted above (Figure 2).

I.B. Trends in Catch and Effort

Data on catch for the longline and surface fisheries by country, gear, and year are available from and summarized by the International Commission for the Conservation of Atlantic Tunas (ICCAT). Trends in catch by year are shown in Figure 3. The fishery began about 1920 with reported

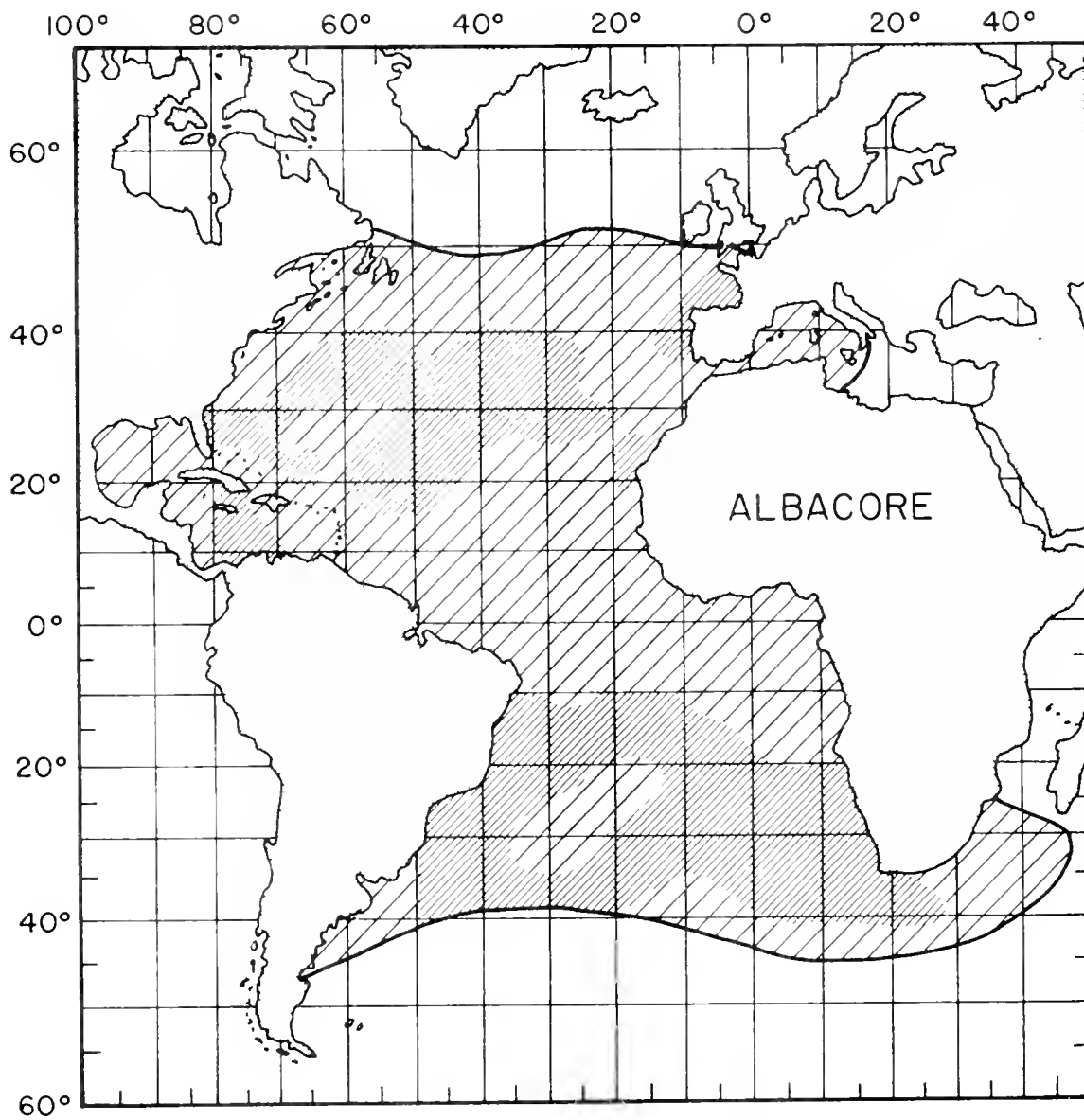

Figure 1. General distribution of albacore in the Atlantic (bold hatching) and location of fisheries (fine hatching).

NORTH STOCK

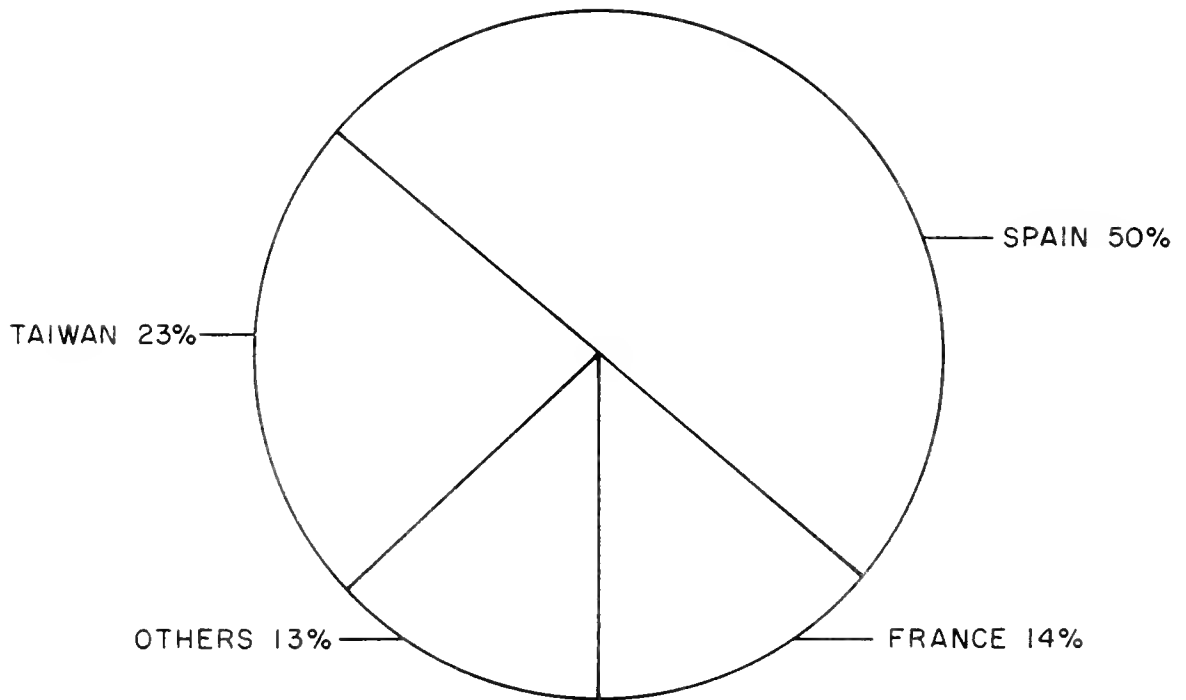

Figure 2. Percentages of north Atlantic albacore catches taken by major fishery participants.

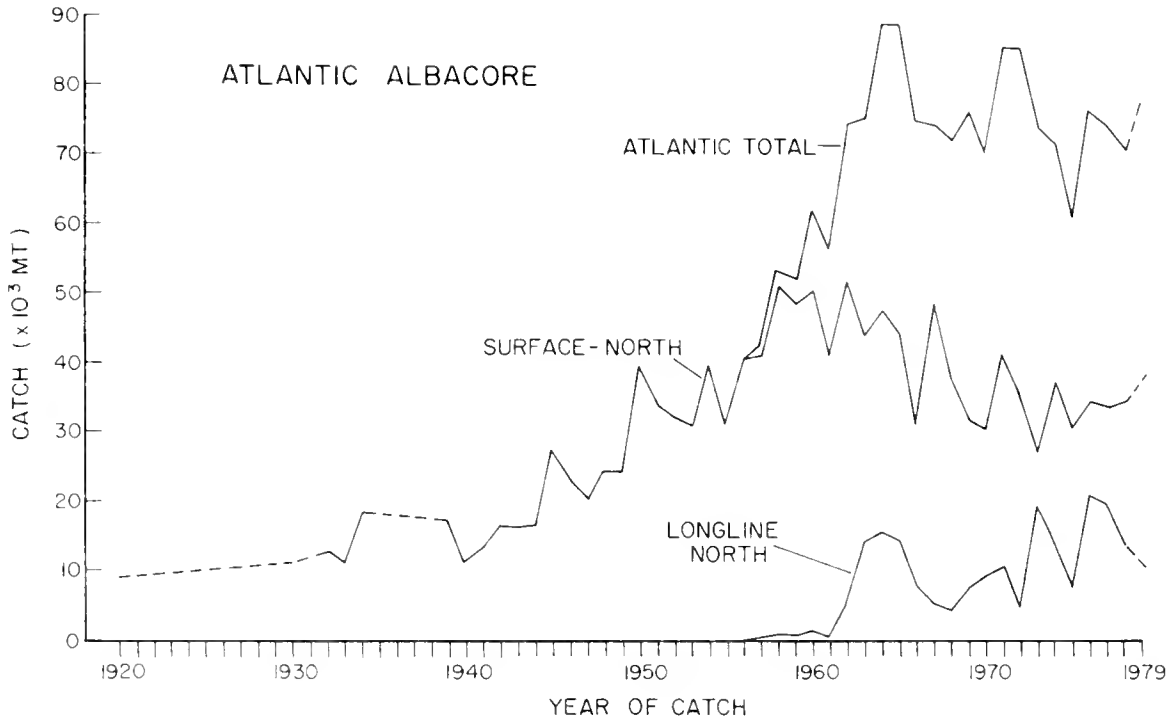

Figure 3. Comparison of annual catch of north Atlantic albacore by fishery (longline and surface) to Atlantic total (includes south longline fishery).

catches near 10,000 mt. Catches increased slowly at first, then rapidly rose to 41,000 mt in 1956. Surface catches fluctuated in the 40,000 to 50,000 mt range from 1956 to 1967, then dropped to 27,000 mt during 1967 to 1973. Catches from 1974 to 1978 again rose near 34,000 mt but generally maintained the general downward trend started in 1960. The surface fishery apparently concentrates on albacore of ages 1, 2, and 3 years. In 1979 the surface fisheries took 38,000 mt.

Longliners began fishing for north Atlantic albacore in 1956 with catches of only a few tons. Catches rose steadily to a peak of 15,000 to 16,000 mt in the 1963 to 1965 period. After the 1965 catch year (Figure 3), longline catches dropped to the 5,000 to 8,000 mt range through 1969. By 1971 the catch rose to 11,000 mt, then declined to 6,000 mt in 1972. The 1973 to 1978 catches were somewhat higher, ranging from 9,000 to 24,000 mt with an average catch of 17,000 mt. The longline fishery apparently concentrates on adult albacore of age 5 and older. The 1979 longline catch was 11,000 mt.

The entire north Atlantic albacore fishery produced yields from 10,000 mt in 1920 to 41,000 mt in 1956, with a peak of 69,000 mt in 1964. The entire 1958 to 1965 period experienced fluctuating catches from 41,000 to 69,000 mt, averaging about 55,000 mt per year. Since 1965, the catches, while fluctuating, have generally declined to the 45,000 to 55,000 mt range. In 1977, 1978, and 1979 the catches were 52,000 mt, 48,000 mt, and 48,000 mt, respectively.

Longline effort has continuously increased from near zero in 1956 to about 65 million effective hooks in 1973. Since 1973 the effort has remained generally constant, near 60 million hooks. Standardized surface effort grew from about 18,000 fishing days in 1920 to about 92,000 fishing days in 1967. Since 1967, surface effort has declined about 40%, to about 55,000 fishing days.

I.C. Value of Catch

No reliable data are available on the foreign ex-vessel values for the catch. However, in 1980 the U.S. albacore fishermen received about \$1800 per mt (ex-vessel). Based on this price, the 1977, 1978, and 1979 north Atlantic albacore catches are valued at about \$90 million, \$86 million, and \$87 million, respectively.

I.D. Current Management of the Fishery

No international fisheries management measures are currently in effect for the north Atlantic albacore stock.

II. NATURE AND SIGNIFICANCE OF U.S. AND FOREIGN PARTICIPATION IN THE FISHERY

The U.S. does not actively participate in the Atlantic albacore commercial fisheries but is interested in the Atlantic albacore stocks. The U.S. is a signatory to the ICCAT convention and as such has indicated its willingness to conserve the Atlantic tuna stocks.

About 45% of the total Atlantic albacore catch, mostly caught by longline, is imported into the U.S. for domestic consumption. This imported Atlantic albacore accounts for about 40% of the total annual U.S. albacore consumption. The remaining 60% comes from import from other oceans and domestic catches. By comparison, the U.S. domestic fishery provides about 15 to 20% of the albacore consumed in the U.S. The U.S. currently consumes about 45% of the world's total albacore catch.

III. STATUS OF THE STOCKS

III.A. Stock Structure

This analysis assumes that the Atlantic albacore population is composed of north and south stocks separated at the equator. The assumed stock separation is based primarily on longline catch rates which decline near the equator. Secondary support is given by the differential reaction of the longline CPUE, both north and south, to increased fishing pressure in the north.

III.B. Stock Assessment and Fishery Evaluation

III.B.1. Trends in Catch-per-Unit-Effort

Catch-per-unit-effort (based on catch/100 hooks) for the longline fishery on north stock has followed a gradual and continuous decline (Figure 4). Catch-per-unit-effort (based on weight) for the major surface fisheries shows a slight downward trend (Figure 5).

III.B.2. Results of Production Model Analysis

A production model analysis for the logistic growth assumption was presented in 1980 by ICCAT (Figure 6). Results indicate that Maximum Sustainable Yield (MSY) is about 60,000 mt at near or slightly above current effort levels. Catches in 1979 were about 48,000 mt.

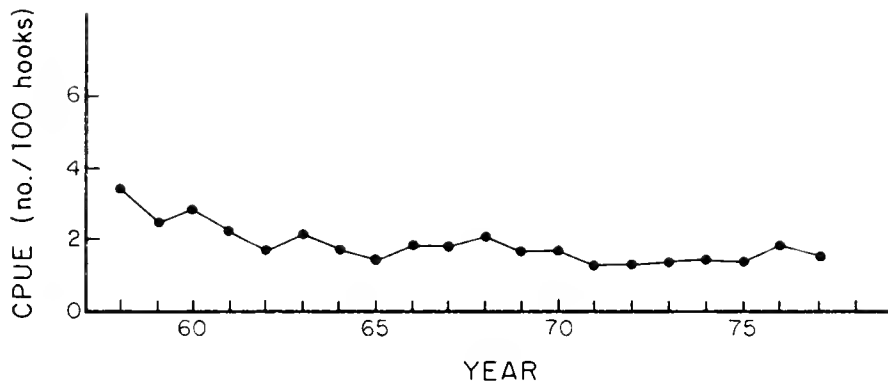

Figure 4. Catch-per-unit-effort for Atlantic albacore longline fisheries on northern stocks.

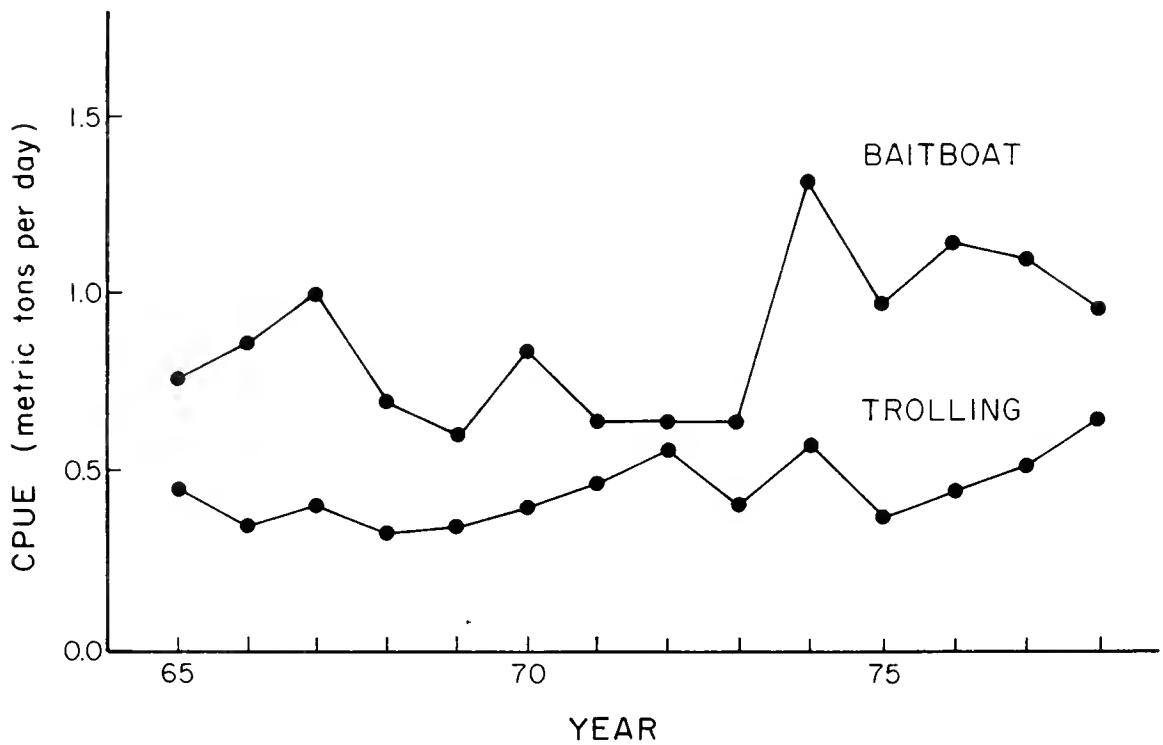

Figure 5. Catch-per-unit-effort for the north Atlantic baitboat and troll fisheries.

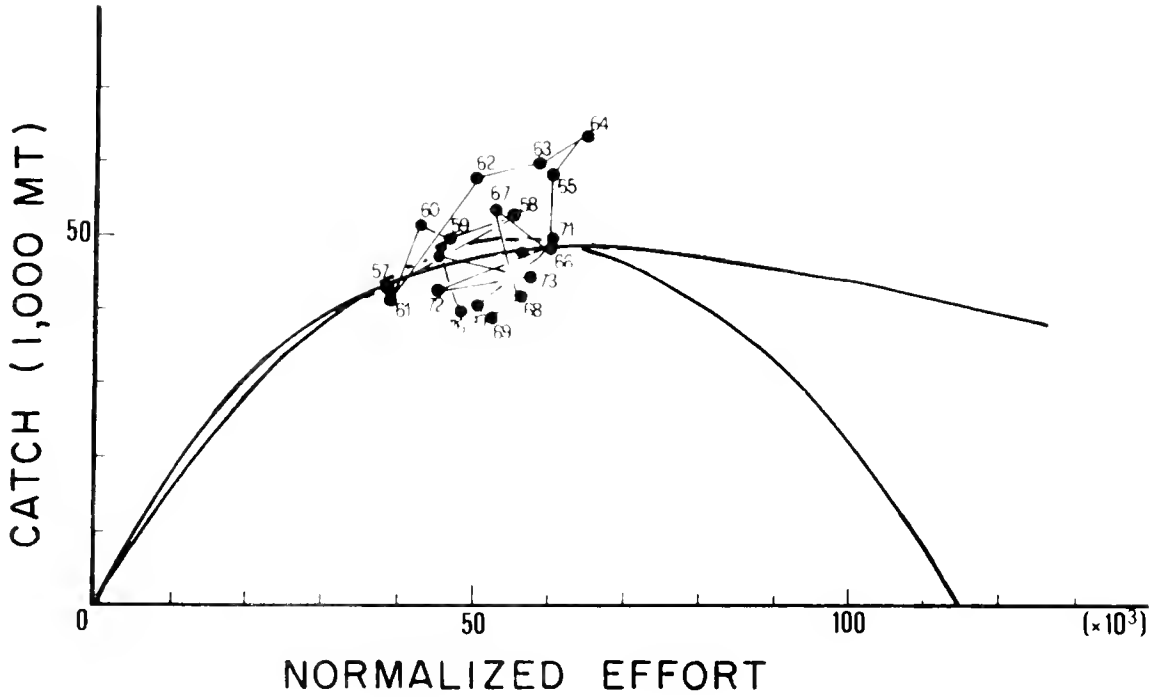

Figure 6. Production model results for north Atlantic albacore

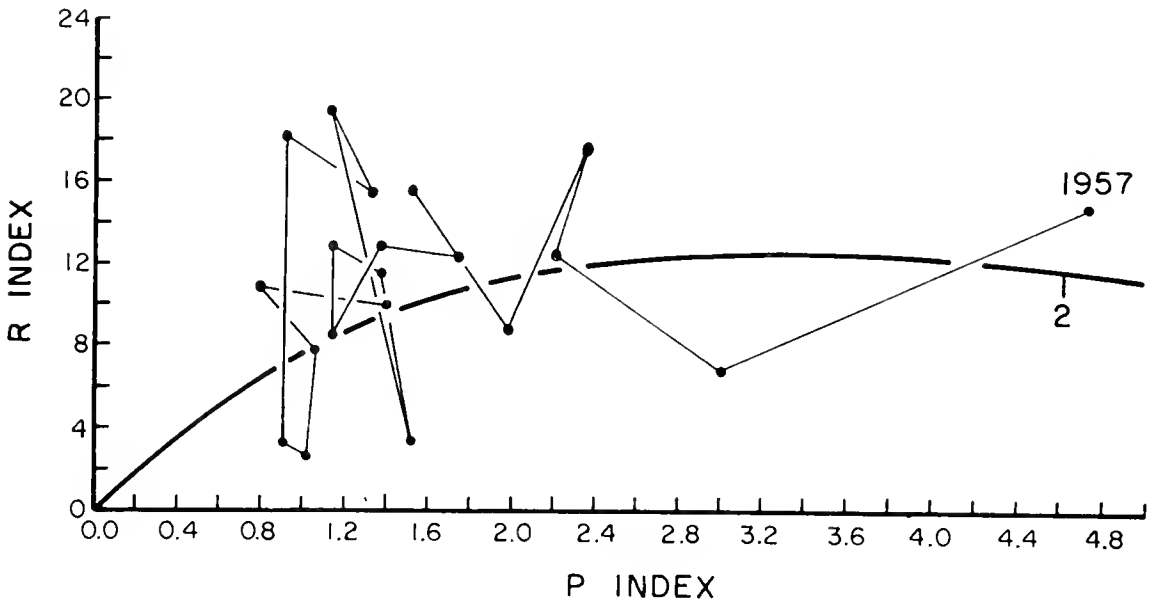

Figure 7. Relationship between parent (P) stock and recruitment (R) levels for north Atlantic albacore.

III.B.3. Results of Yield-per-Recruit Analysis

Fisheries on the north Atlantic stock were realizing a yield-per-recruit of about 3.8 kg in the 1970's, with a size-at-recruitment of about 40 cm. Maintaining the current effort levels and increasing size-at-first-capture to about 65 cm should produce about a 25% increase in yield-per-recruit. This size-at-recruitment, however, will likely impact the existing surface fisheries severely. Maintaining the current size-at-recruitment and increasing or decreasing effort up to 20% will produce no significant changes in yield-per-recruit. 1980 ICCAT results indicate that changes in the surface fisheries patterns may be increasing yield-per-recruit.

III.B.4. Results of Spawner/Recruitment Analysis

Analysis of spawner and recruit indices for the north stock in recent years has caused concern at ICCAT. Current levels of spawning stock indices appear to be about 15% to 20% as great as those observed in the late 1950's (Figure 7). Indices of recruitment show a possible declining trend with increasing variability. Recruitment as measured by CPUE indices dropped from a value of about 16 in 1957 with relatively little estimated variance, to a mean value of about 12 in the last 5 years with variance increasing five-fold. Recent work indicates the probability of a year-class failure may be as high as 10% to 20%.

III.B.5. Results of Other Analyses/Simulations

None available.

III.C. Current Evaluation of Stocks and the Fishery

The available analyses indicate that the north Atlantic albacore stock appears to be fished near MSY. Yield-per-recruit is not near a maximum value, owing to substantial amounts of small fish in the catch. However, little change appears possible without large changes in the structure of the fisheries. The decline in recruitment (related to the low yield-per-recruit) and apparent increases in variability, make a year-class failure, as measured by the recruitment index, a real possibility.

IV. STATUS OF CURRENT RESEARCH NEEDS AND EFFORTS

IV.A. Major Research Problems

1) Effort needs to be standardized to determine its effect on production model results.

2) The robustness of current stock assessment techniques must be evaluated with regard to assumed parameters, and variability and bias in basic data.

These should indicate whether more conclusive management advice and recommendations are possible, using existing model/data combinations.

IV.B. Current Research Effort

1) Conventional stock assessments of foreign fisheries are being analyzed, using production model, spawner/recruit, and cohort analyses.

2) Work is being done on the estimation of confidence intervals about spawner/recruit relationships.

IV.C. Future Research Needs

IV.C.1. Suggested Approach and Methods

1) The effects of changing effort standardization methods on production model results can be examined using available data and a variety of standard and new analytical methods.

2) The robustness of current assessment techniques with available data can be investigated using Monte Carlo and sensitivity analyses. Results of this research are applicable to all species.

IV.D. Status of SWFC Data Base

The data base for north Atlantic albacore at SWFC is adequate and up-to-date. New data are supplied by ICCAT as available.

STATUS REPORT: TUNAS IN THE INDIAN OCEAN

by

Fletcher V. Riggs

Southwest Fisheries Center
Honolulu, Hawaii

ABSTRACT

The status of stocks of four species of tuna (albacore, bigeye, yellowfin, and skipjack) in the Indian Ocean were analyzed. Since 1962 estimated annual catch of albacore in the Indian Ocean has fluctuated widely between 10,000 and 28,000 mt. The estimated catch for 1978 was 14,600 mt. MSY lies between 15,000 and 20,000 mt. A yield-per-recruit assessment suggests no gain in yield-per-recruit from harvesting the younger fish as fishing effort moved into more southerly waters. This stock appears fully harvested and there appears to be no reason for concern over the future of the stock at this time.

Estimated annual catch of bigeye tuna in the Indian Ocean reached a high of 48,600 mt in 1978. A production model analysis did not produce a reliable prediction of MSY. The yield curve showed increasing catch with effort and did not reach an asymptote. This stock appears to be only lightly exploited.

Yellowfin tuna in the Indian Ocean are fished by surface and longline gears. Estimated annual catch fluctuated widely from 1952 to 1978 but exhibited a general upward trend. The estimated total catch for 1978 was 62,500 mt. Production model analyses based on available longline fishery data suggest an MSY for that fishery of around 40,000 mt. Due to rather inaccurate total catch estimates, however, MSY may be higher. It is unlikely that longline catch could be increased appreciably above the current level. However, it is generally felt that there is a potential for increased landings of yellowfin tuna by surface fisheries.

The surface skipjack tuna fishery in the Indian Ocean is relatively undeveloped. Catches have fluctuated from 1965 on a generally rising trend. Estimated catch for 1978 was 32,600 mt. There have been no quantitative assessments of the Indian Ocean skipjack tuna stock.

I. DESCRIPTION OF THE FISHERY

I.A. History of the Fishery

Commercial longline fishing for albacore (Thunnus alalunga), bigeye tuna (T. obesus), and yellowfin tuna (T. albacares) in the Indian Ocean, started after World War II although exploratory fishing by Japanese vessels in the early 1930's had indicated the presence of tunas in the eastern Indian Ocean. Intensive commercial longline fishing in the Indian Ocean began in 1952 in the eastern sector and rapidly expanded westward to reach the African coast by 1956 (Figure 1) (Nakamura et al. 1956; Kikawa et al. 1969). Countries currently maintaining longline fleets in this area include Japan, Korea, Taiwan, U.S.S.R., and Sri Lanka. Vessels from Australia, India, Madagascar, Maldives, Pakistan, Sri Lanka, Democratic Republic of Yemen, Seychelles, and Oman catch surface yellowfin tuna (Wetherall et al.¹).

The surface skipjack tuna (Katsuwonus pelamis) fishery in the Indian Ocean is still relatively undeveloped. Most of the catches of skipjack tuna, and a smaller but growing proportion of the catches of yellowfin tuna, are made in localized fisheries along the coastline of the various countries bordering the ocean and around the many island groups. The origins of these fisheries are obscure and their historical accounts are few and fragmentary.. In Sri Lanka (Ceylon), skipjack tuna are taken by trolling gear, drift nets, and pole-and-line. Use of the pole-and-line method dates back to 1919 in Sri Lanka and in Minicoy, Laccadive, and Maldivian Islands to 1909 (Sivasubramaniam 1965). Countries reporting skipjack tuna catches in the Indian Ocean include Australia, Comoros, Indonesia, Japan, Korea, Maldives, Mauritius, Seychelles, and Sri Lanka (Food and Agriculture Organization of the United Nations [FAO] 1979).

I.B. Trends in Catch and Effort

Albacore - The estimated annual catch in the Indian Ocean rose from 100 metric tons (mt) in 1952 to 17,700 mt in 1962. From 1962 to 1978, the estimated annual catch fluctuated widely, reaching a high of 28,200 mt in 1974 (Table 1 and Figure 2).

¹Wetherall, J. A., F. V. Riggs, and M. Y. Y. Yong. 1979. Some production model analyses of tuna and billfish stocks in the Indian Ocean. SWFC Admin. Rep. H-79-7, Nat. Mar. Fish. Serv., NOAA, Honolulu, Hawaii, 12 p. Prepared for the Workshop on the Assessment of Selected Tunas and Billfish Stocks in the Indian and Pacific Oceans, Shimizu, Japan, 13-22 June 1979.

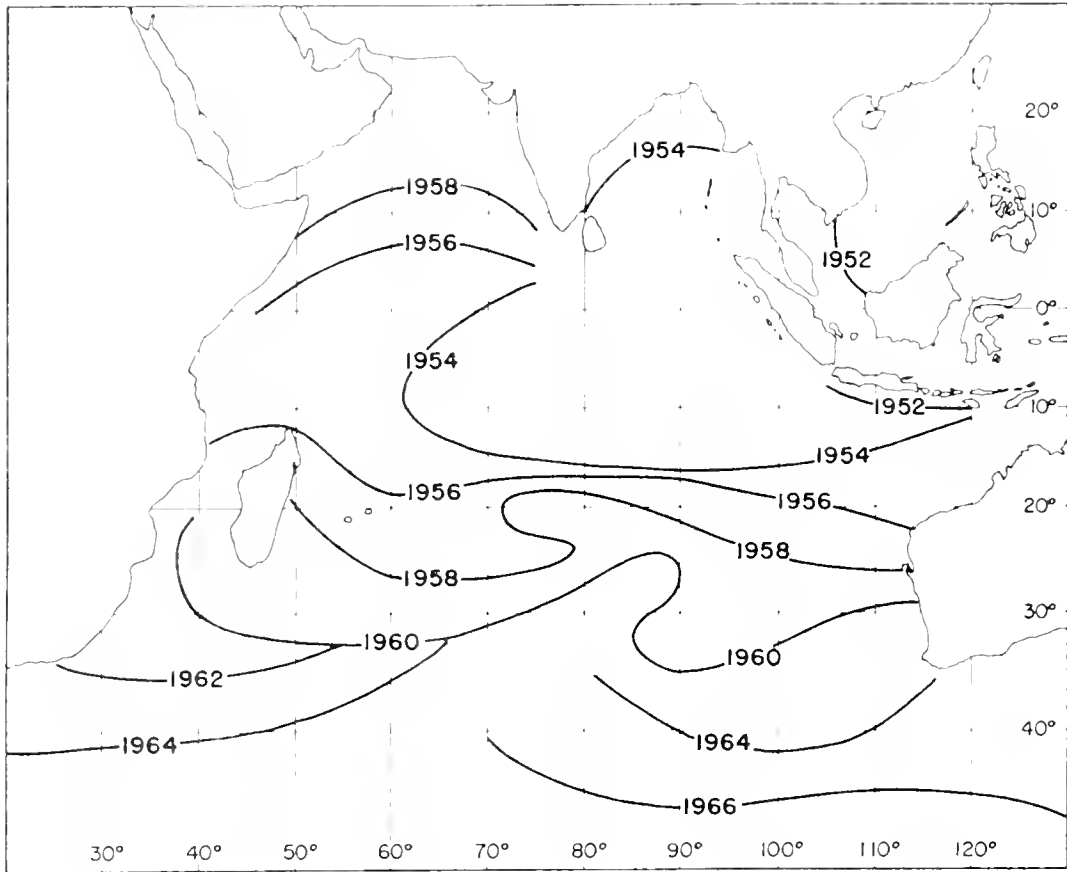

Figure 1. The expansion of Japanese longline fishing grounds in the Indian Ocean. (Adapted from Kikawa et al. 1969).

Table 1.--Estimated total catches of tunas in the Indian Ocean.

Year	Albacore ¹	Bigeye tuna ¹	Yellowfin tuna ¹	Skipjack tuna ²
1952	0.1	1.5	8.9	
1953	1.1	3.6	13.3	
1954	2.8	8.0	25.1	
1955	3.3	10.3	47.1	
1956	4.8	14.0	65.5	
1957	4.7	13.3	37.3	
1958	6.3	12.8	27.6	
1959	10.4	10.4	26.8	
1960	11.1	17.0	42.5	
1961	15.4	15.5	37.4	
1962	17.7	19.9	55.1	
1963	12.6	14.2	29.4	
1964	18.1	19.0	30.1	
1965	12.4	20.1	34.5	13.2
1966	17.3	26.4	56.8	16.0
1967	23.7	26.9	44.8	18.1
1968	17.4	38.7	88.1	16.6
1969	21.9	27.4	61.7	18.7
1970	15.2	24.8	42.6	29.7
1971	10.2	22.8	50.9	31.4
1972	11.7	18.1	47.4	20.1
1973	22.1	16.0	41.2	25.1
1974	28.2	27.7	43.5	41.3
1975	11.2	39.7	51.4	36.2
1976	14.9	29.8	56.4	38.4
1977	11.4	36.8	70.5	30.3
1978	14.6	48.6	62.5	32.6

¹Data for albacore, bigeye tuna, and yellowfin tuna for 1952-77 from FAO in press and for 1978 from FAO 1979.

²Data for skipjack tuna for 1965-69 from FAO 1974, for 1970-72 from FAO 1976, for 1973 from FAO 1977, and for 1974-78 from FAO 1979.

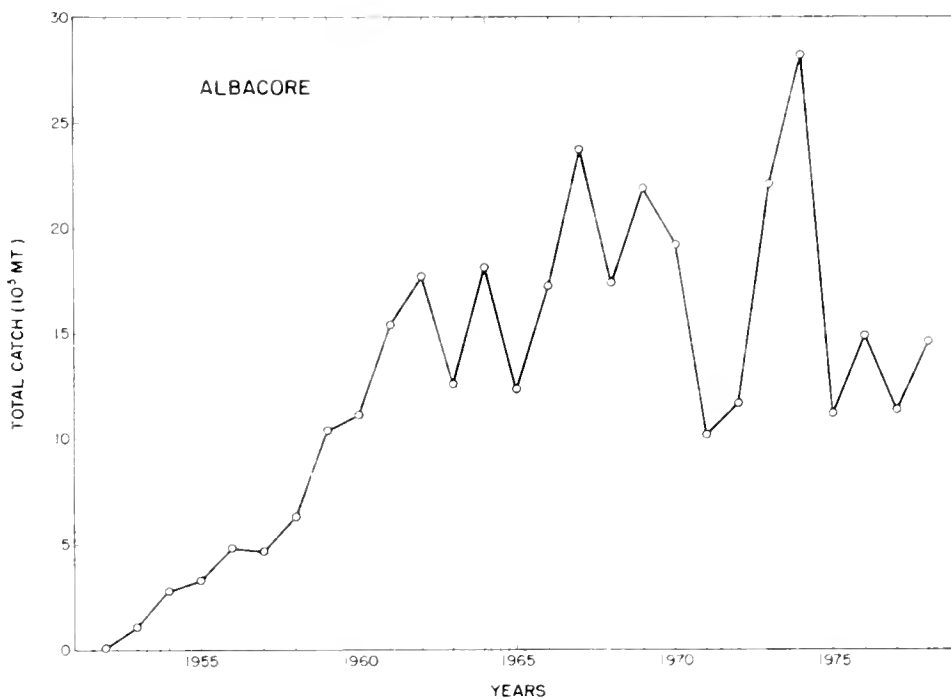

Figure 2. Estimated total catch of albacore in the Indian Ocean (Data from Table 1.)

Bigeye tuna - The estimated annual catch increased steadily from 1,500 mt in 1952 to 38,700 mt in 1968, then declined temporarily to 16,000 mt in 1973. Annual catch estimates after 1973 rose sharply to the 1978 high of 48,600 mt (Table 1 and Figure 3).

Yellowfin tuna - The estimated annual catch fluctuated widely from 1952 to 1978 but suggests a general downward trend. Years with relatively high catches include 1956 (65,500 mt), 1968 (88,100 mt), and 1977 (70,500 mt) (Table 1 and Figure 4).

Skipjack tuna - The catch fluctuated with a generally rising trend from 13,200 mt in 1965 to a peak of 41,300 mt in 1974; it then declined to 32,600 mt in 1978 (Table 1 and Figure 5).

Reliable statistics of nominal effort are available only for Japanese and Taiwanese longline vessels (Figure 6). Japanese effort rose to a high of 126 million hooks in 1967, followed by a general decline to 67 million hooks in 1978. The effort by Taiwan, beginning in 1967, rose rapidly to 53 million hooks within the first 3 years, then experienced a gradual decline to 34 million hooks in 1973. Taiwanese effort then rose again sharply, reaching its highest value of 57 million hooks in 1974; it then declined to 26 million hooks in 1977.

Although not included in Figure 6, an increasing proportion of the total longline effort in recent years may be attributed to Korean vessels. Japanese longline effort shifted away from yellowfin tuna in earlier years to albacore, then bigeye tuna, and is currently targeted on southern bluefin tuna, T. thynnus.

I.C. Value of Catch

No information on the value of catch is available. Presumably most of the tunas caught in the longline fishery are landed in Japanese, Korean, and Taiwan ports.

I.D. Current Management of the Fishery

None of the tunas in the Indian Ocean is under management.

II. NATURE AND SIGNIFICANCE OF U.S. AND FOREIGN PARTICIPATION IN THE FISHERY

There is no known current U.S. participation or direct investment in the Indian Ocean tuna fisheries. A quantity of tuna landed by foreign

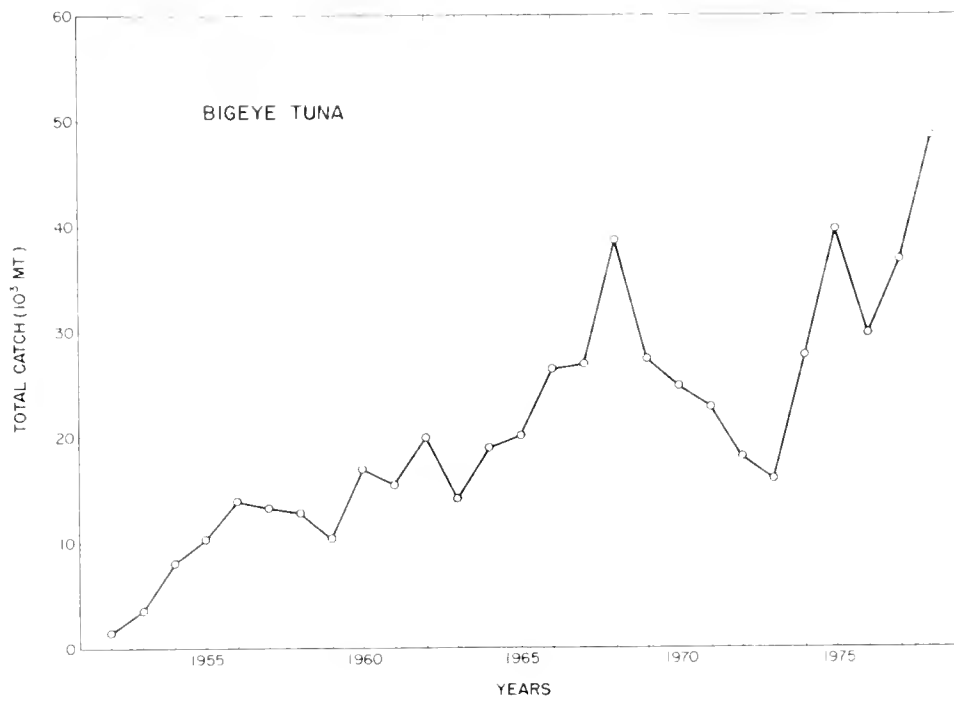

Figure 3. Estimated total catch of bigeye tuna in the Indian Ocean.
(Data from Table 1.)

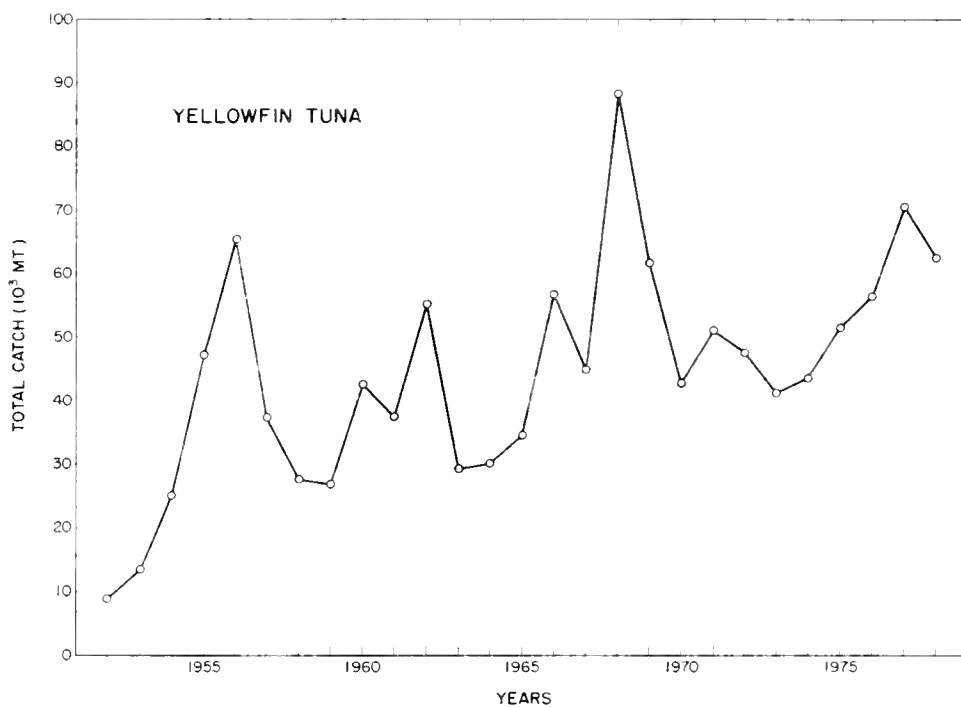

Figure 4. Estimated total catch of yellowfin tuna in the Indian Ocean. (Data from Table 1.)

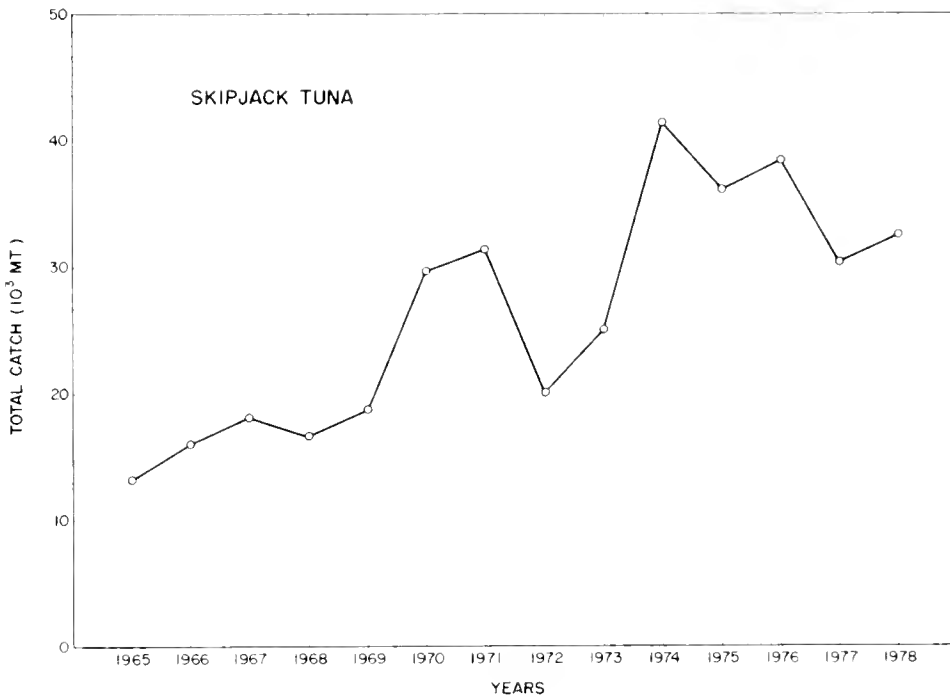

Figure 5. Skipjack tuna catch in the Indian Ocean.
(Data from Table 1.)

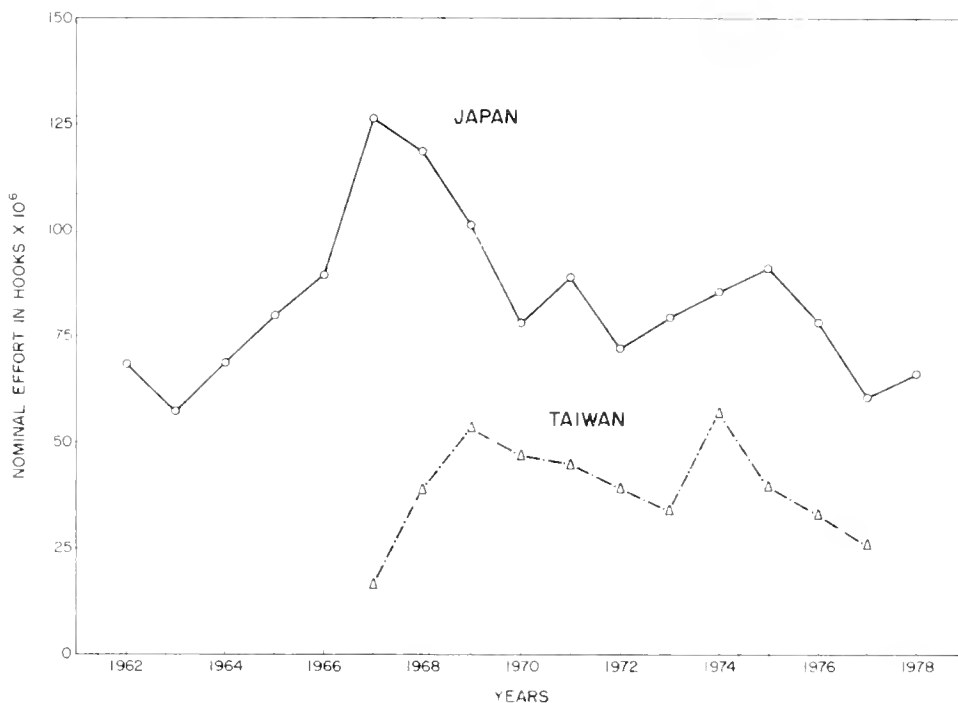

Figure 6. Nominal effort in 10⁶ hooks by Japanese and Taiwan longline vessels in the Indian Ocean. (Japanese data from Fisheries Agency of Japan, Research Department 1980 and Taiwan data courtesy of R. T. Yang, National Taiwan University, Taiwan, Republic of China.)

interests, however, may be imported into the U.S.; the actual volume or value is unknown.

The significance of the tuna fisheries in the Indian Ocean relative to other oceans to nations with long-range longline fleets may be reflected in the proportion of total nominal effort that is expended in the Indian Ocean. For the Japanese longline fleet, 15% of the total hooks set were in the Indian Ocean in 1978; for the Taiwan fleet the most recent figure was 25% in 1976. This is in contrast to the middle and late 1960's with relatively higher values of 27% for Japan and 50% for Taiwan.

III. STATUS OF THE STOCKS

III.A. Stock Structure

It was assumed at the 1979 Shimizu Workshop (Food and Agriculture Organization of the United Nations [FAO], in press) that there are single stocks of albacore and bigeye tuna in the Indian Ocean. The yellowfin tuna resource was believed to be composed of either two stocks (east and west of about 100° E longitude) or a single stock. No information on skipjack tuna stock structure was available for this report.

III.B. Stock Assessment and Fishery Evaluation

III.B.1. Trends in Catch-per-Unit-Effort

Abundance indices have been recently computed for Indian Ocean albacore, bigeye tuna, and yellowfin tuna over the period from 1952 to 1976 (Wetherall et al., see footnote 1).

The abundance index for albacore tripled in the first few years of the fishery, but subsequently declined steadily to less than 10% of its peak value (Figure 7). The abundance index for bigeye tuna has fluctuated moderately but generally shows an overall downward trend since 1952. The apparent abundance in recent years, however, is still about 50% of its initial value (Figure 8). The abundance index for yellowfin tuna has show a steady decline since 1954 to levels about 15% of the initial values (Figure 9).

Catch-per-unit-effort statistics are not available for Indian Ocean skipjack tuna.

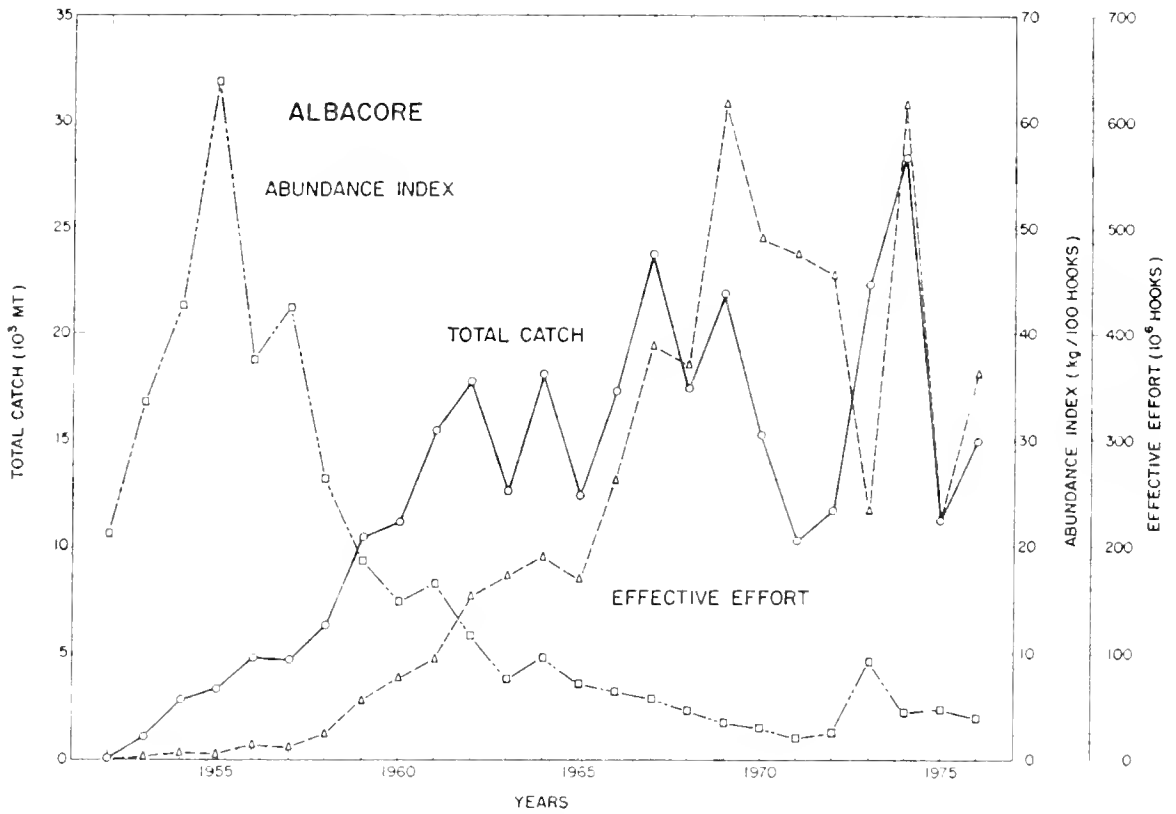

Figure 7. Estimated total catch (10^3 MT), relative abundance (kg/100 hooks), and effective effort (10^6 hooks) for Indian Ocean albacore.

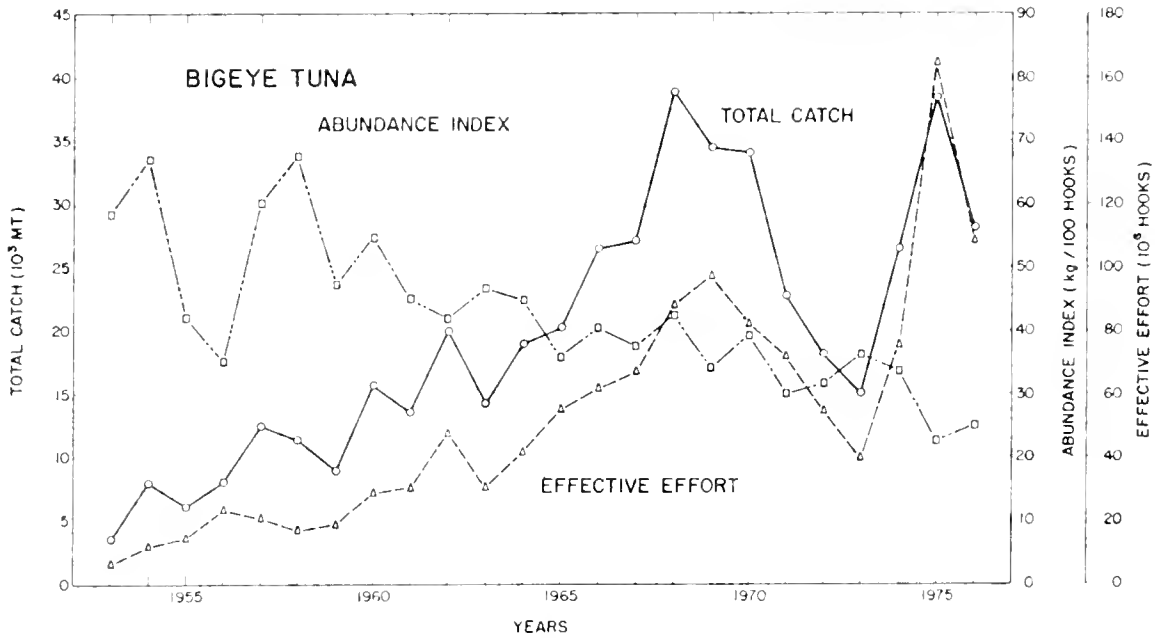

Figure 8. Estimated total catch (10^3 MT), relative abundance (kg/100 hooks), and effective effort (10^6 hooks) for Indian Ocean bigeye tuna.

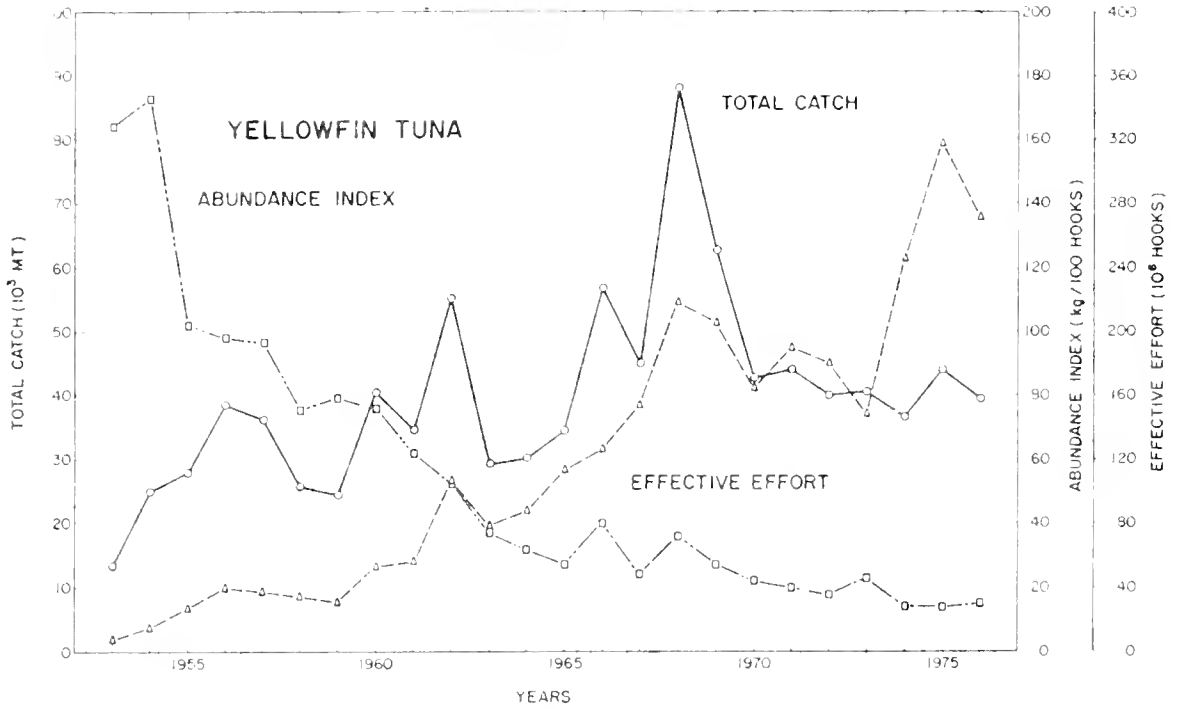

Figure 9. Estimated total catch (10^3 MT), relative abundance (kg/100 hooks), and effective effort (10^6 hooks) for Indian Ocean yellowfin tuna.

III.B.2. Results of Production Model Analysis

Production model analyses have been applied to Indian Ocean albacore, bigeye tuna, and yellowfin tuna data (Kume and Morita², Suzuki³, and Wetherall et al., see footnote 1). No assessment studies have been done on skipjack tuna.

Albacore - A MSY (maximum sustainable yield) between 15,000 and 20,000 mt was suggested by production model analyses. A yield curve appeared to be asymptotic and there was little change in the catch although effort doubled from 1966 to 1974.

Bigeye tuna - A production model analysis did not produce a reliable prediction of MSY. The yield curve showed increasing catch with effort; effort levels were not high enough to indicate a maximum or asymptotic yield.

Yellowfin tuna - Production model analyses based on available data suggested an MSY of around 40,000 mt. However, because total catch estimates are rather inaccurate, it may be premature to pinpoint an MSY for this fishery, except to indicate that it is thought to be between 40,000 and 60,000 mt.

III.B.3. Results of Yield-per-Recruit Analysis

A yield-per-recruit assessment of Indian Ocean albacore by Suda (1973) suggested no gain in yield-per-recruit from harvesting the younger fish as fishing effort moved into more southerly waters.

III.B.4. Results of Spawner/Recruitment Analysis

Stock size indices by age for Indian Ocean yellowfin tuna have been calculated under the one- and two-stock hypotheses (Suzuki, see footnote 3). No relationship between stock and recruitment was evident.

²Kume, S., and Y. Morita. 1979. Brief review of the fishery biology of bigeye tuna in the Indian Ocean and its stock assessment. Prepared for the Workshop on the Assessment of Selected Tunas and Billfish Stocks in the Indian and Pacific Oceans, Shimizu, Japan, 13-22 June 1979.

³Suzuki, Z. 1979. Stock assessment of yellowfin tuna in the Indian Ocean exploited by tuna longline fishery. Prepared for the Workshop on the Assessment of Selected Tunas and Billfish Stocks in the Indian and Pacific Oceans, Shimizu, Japan, 13-22 June 1979.

III.B.5. Results of Other Analyses/Simulations

None available.

III.C. Current Evaluation of Stocks and the Fishery

Albacore - The Indian Ocean albacore stock appears to be fully harvested. The consensus at the Shimizu Workshop (FAO, in press) was that there appears to be no reason for concern over the future of the stock at this time.

Bigeye tuna - The Indian Ocean bigeye tuna stock appears to be only lightly exploited. It is impossible at this time to assess what potential exists for surface fisheries on this species.

Yellowfin tuna - It is unlikely that longline catch of Indian Ocean yellowfin tuna could be increased appreciably above the current level. However, it is generally felt that there is a potential for increased landings of this species by surface fisheries. While an increased surface fishery might reduce the abundance of yellowfin tuna available to longliners, the total catch would probably increase.

IV. STATUS OF CURRENT RESEARCH NEEDS AND EFFORTS

IV.A. Major Research Problems

Several research needs were identified at the 1979 Shimizu Workshop (FAO, in press).

Yellowfin tuna - Studies were recommended to 1) analyze, under various hypotheses, the sensitivity of stocks, catch, etc., because an adequate data base will not be available for some time; 2) estimate coefficients of mortality, particularly in relation with fishing effort; 3) determine changes in effectiveness of fishing gear, particularly in relation to total fishing effort; 4) apply production model analyses to the catch in terms of number of fish and fishing effort, because a) the size frequencies are functions of fishing intensity, and b) there is an uncertainty in applying a fixed age-size key to estimate the age composition; and 5) determine hypothetical yields for various new fishing strategies.

Bigeye tuna - It was recommended that a study of the population relationship of bigeye tuna in the Banda Sea and in the Indian Ocean be carried out. Research on population parameters was not considered of high priority.

Albacore - The workshop recommended that an effort should be made to determine precisely which data are missing and needed for minimally sophisticated stock assessments such as production models and cohort analyses.

Skipjack tuna - Aside from localized studies, research on this species has been almost nil.

IV.B. Current Research Efforts

There are currently no research efforts by the SWFC on Indian Ocean tunas. Details of research being done by other agencies are not available for this resport.

IV.C. Future Research Needs

There is an overall need to enhance and strengthen the Pacific and Indian Ocean tuna data base and to monitor fishing activities and developments in these areas more closely.

The Shimizu Workshop (FAO, in press) pinpointed the following data needs:

- 1) More accurate estimates of yellowfin tuna catch, particularly for the surface fisheries.
- 2) Yellowfin catch, effort, and size-frequency data by temporal-spatial strata for yield-per-recruit and stock structure studies.
- 3) Improved data from that segment of the longline fishery which targets on yellowfin, albacore, and bigeye tuna: the available analyses, based on data from the Japanese longline fishery, are now inadequate because Japanese longliners now target on southern bluefin tuna.
- 4) Fishing effort and other biological data for the yellowfin and bigeye tuna surface fisheries.
- 5) Unpublished albacore catch and effort data thought to exist in government and industry files.
- 6) Improved catch and effort data for skipjack tuna in the various localized surface industries.

IV.D. Status of SWFC Data Base

Data on Indian Ocean tunas maintained and currently used at the Honolulu Laboratory consist of Japanese and Taiwanese longline catch and effort statistics. Some catch and effort data for Korean longline vessels are available but questions on interpretation have precluded use.

LITERATURE CITED

- Food and Agriculture Organization of the United Nations.
1974. Catches and landings, 1973. FAO Yearbook Fish. Stat. 36, 590 p.
1976. Catches and landings, 1975. FAO Yearbook Fish. Stat. 40, 334 p.
1977. Catches and landings, 1976. FAO Yearbook Fish. Stat. 42, 323 p.
1979. Catches and landings, 1978. FAO Yearbook Fish. Stat. 46, 372 p.
- In press. Summary report of the Workshop on the Assessment of Selected Tuna and Billfish Stocks in the Pacific and Indian Oceans, Shimizu, Japan, 13-22 June 1979. FAO Fish. Rep.
- Fisheries Agency of Japan, Research Department.
1980. Annual report of effort and catch statistics by area on Japanese tuna longline fishery, 1978. Fish. Agency Japan, Res. Dep., 241 p.
- Kikawa, S., T. Koto, C. Shingu, and Y. Nishikawa.
1969. Status of tuna fisheries in the Indian Ocean as of 1968. Far Seas Fish. Res. Lab., S. Ser. 2, 28 p.
- Nakamura, H., Y. Yabuta, and K. Mimura.
1956. Longline fishing grounds in the Indian Ocean. Indo-Pac. Fish. Council., Proc., 6 Sess., Sect. 2 and 3: 220-238.

Sivasubramaniam, K.

1965. Exploitation of tunas in Ceylon's coastal waters. Bull.
Fish. Res. Stn., Ceylon 18: 59-73.

Suda, A.

1973. Observation on the recent status of tuna longline fishery in
the Indian Ocean. Far Seas Fish. Res. Lab., S. Ser. 7: 41-70.

STATUS REPORT: BILLFISHES IN THE INDIAN OCEAN

by

Howard O. Yoshida

Southwest Fisheries Center
Honolulu, Hawaii

ABSTRACT

Billfishes are caught primarily as a by-catch on longline gear set to catch tunas in the Indian Ocean. Most of these billfishes appear to be sold in Japan where striped marlin brings the highest price, followed by swordfish, blue marlin, and black marlin. Tentative results from production model analyses indicate that no significant increase in total yield can be expected for blue and black marlin, whereas striped marlin yields could increase with increased effort. Swordfish and sailfish stock do not appear to be adversely affected by current levels of fishing efforts. Additional statistics must be collected from the fleets of participating nations to give a clearer picture of stock status in these waters.

I. DESCRIPTION OF THE FISHERY

I.A. History of the Fishery

The billfishes (blue marlin, Makaira nigricans, striped marlin, Tetrapturus audax, black marlin, M. indica, swordfish, Xiphias gladius, sailfish, Istiophorus platypterus, and shortbill spearfish, T. angustirostris) are widely distributed and have generally similar distributions in the Indian Ocean (Figure 1). Billfishes are caught only incidentally by longliners because the target species in the Indian Ocean are the various tunas. Major participating fleets include those of Japan, Taiwan, and Korea, although Tanzania and the U.S.S.R. also report billfish catches from the Indian Ocean to the FAO (Food and Agriculture Organization of the United Nations 1977). Indonesian vessels and sport fishermen in South Africa, Kenya, Seychelles, and western Australia probably catch a small amount of billfishes.

According to Ueyanagi (1974), the Japanese longline fishery around the Lesser Sunda Islands began expanding into the Indian Ocean in 1952 (Figure 2). By 1956, Japanese vessels were fishing in African coastal waters and by 1958, they had reached the northern limit of the Indian Ocean. Subsequent expansion was southward. By 1964, longline operations had reached 40° S latitude, the southern limit of billfish distribution. Further southward expansion was solely for the southern bluefin tuna. Longline boats of Taiwan and Korea began fishing in the Indian Ocean in 1954 and 1967, respectively (Honma and Suzuki 1972).

I.B. Trends in Catch and Effort

The estimated total billfish catch from the Indian Ocean amounted to 7,804 mt (metric tons) in 1975 and 7,062 mt in 1976 (Wetherall et al.¹). The catch is listed by species, country, and year in Table 1. Data for catch, relative abundance, and effective effort are available from 1952 to 1976 (Table 2).

¹Wetherall, J. A., F. V. Riggs, and M. Y. Y. Yong. 1979. Some production model analyses of tuna and billfish stocks in the Indian Ocean. SWFC Admin. Rep. H-79-7, Natl. Mar. Fish. Serv., NOAA, Honolulu, Hawaii, 12 p. Prepared for the Workshop on the Assessment of Selected Tunas and Billfish Stocks in the Indian and Pacific Oceans, Shimizu, Japan, 13-22 June 1979.

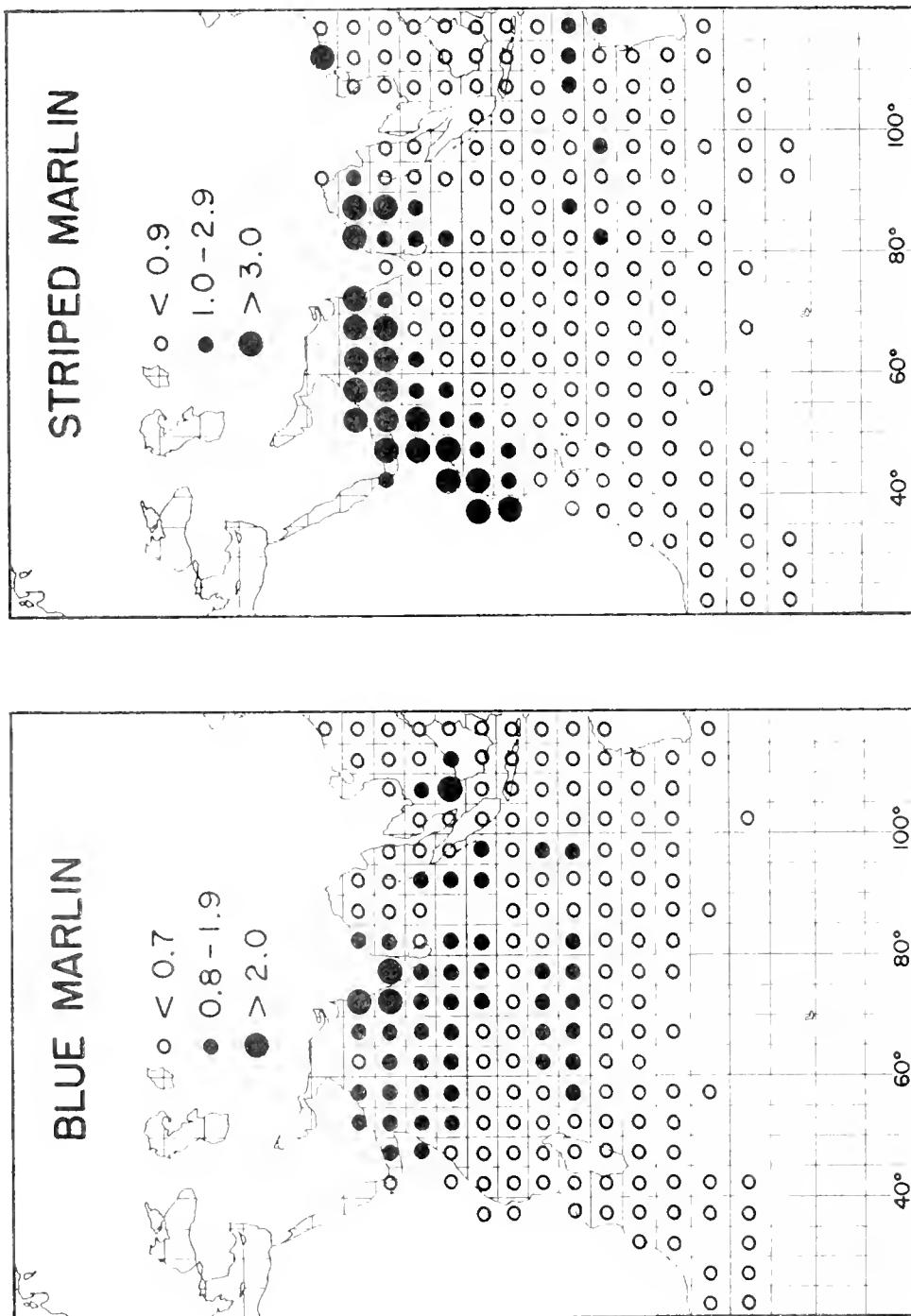

Figure 1.--Distribution of billfishes in the Indian Ocean (adapted from Shomura 1980).
Circles indicate mean catch rates (number of fish/1,000 hooks.)

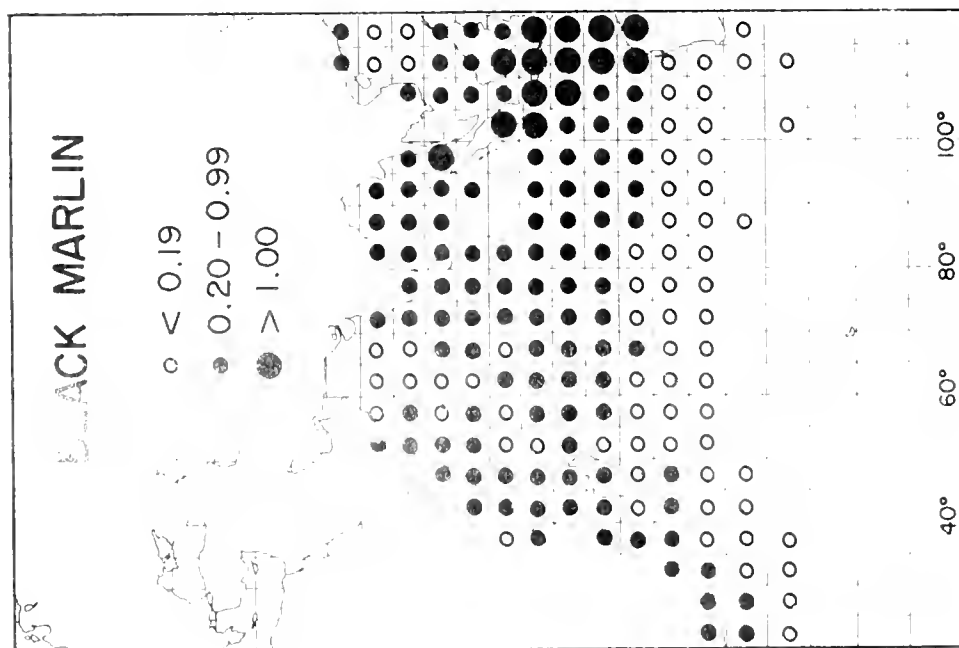
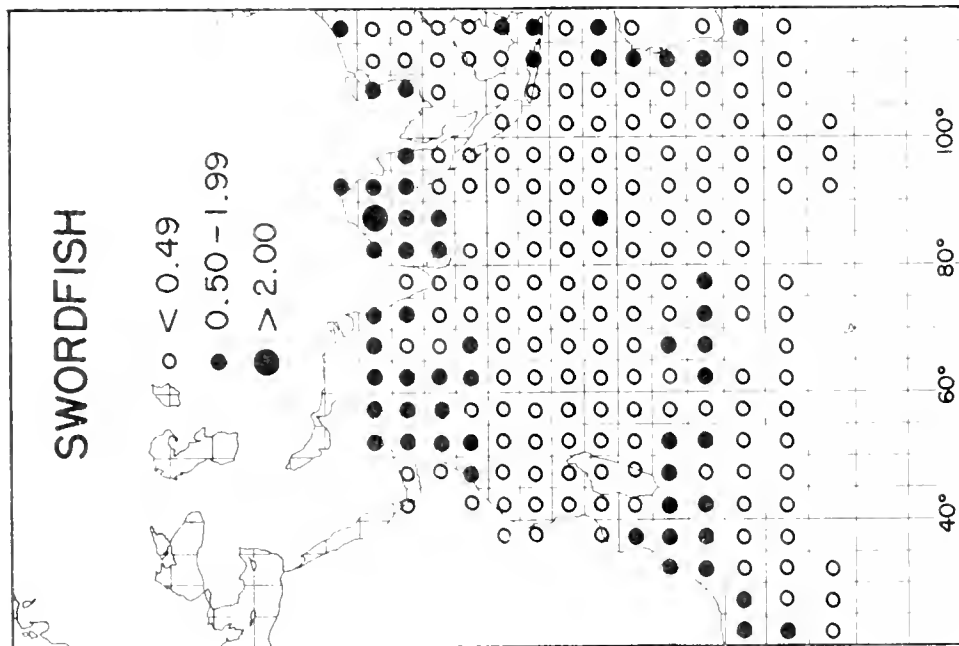

Figure 1.--Continued.

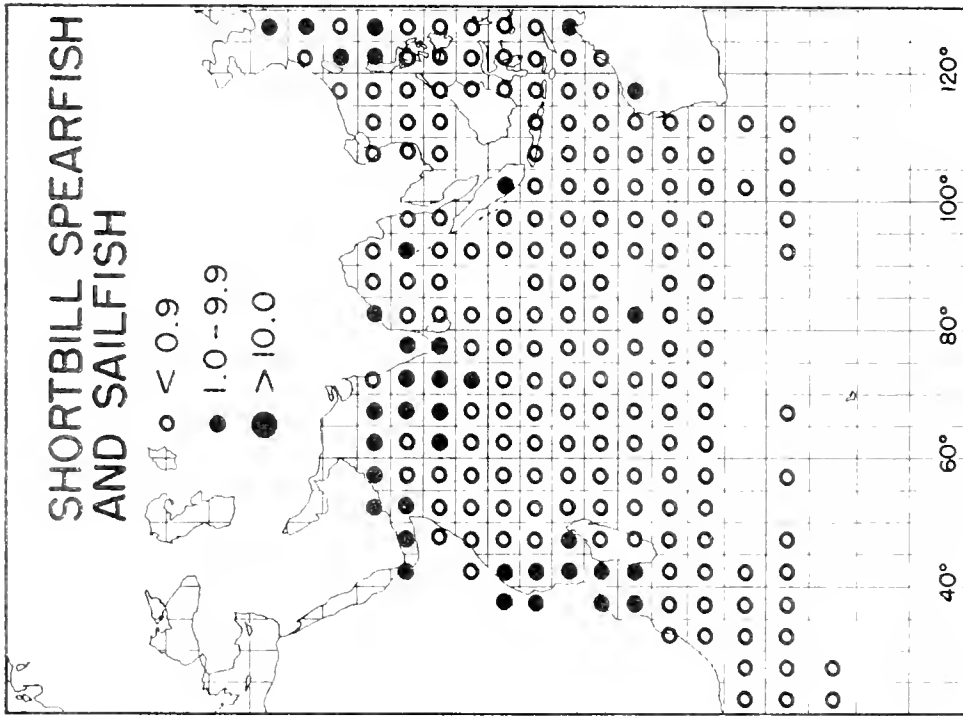

Figure 1.--Continued.

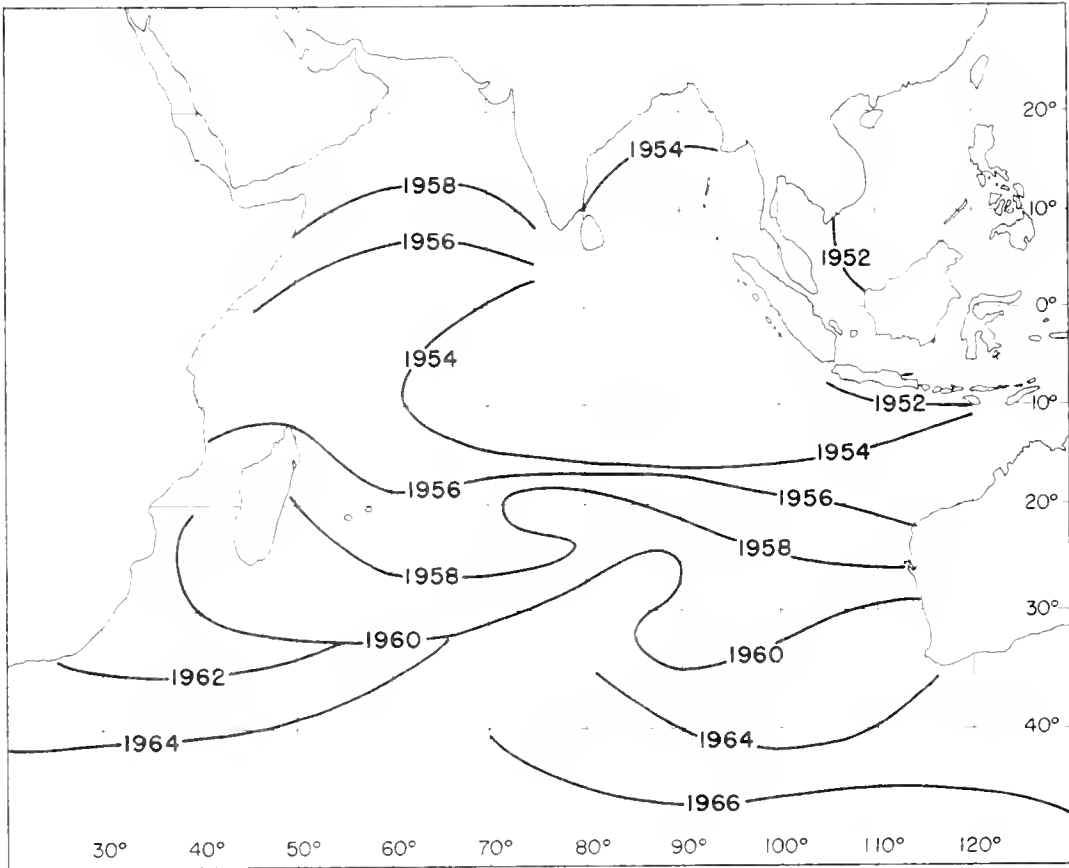

Figure 2.--The expansion of Japanese longline fishing grounds in the Indian Ocean. (Adapted from Kikawa et al. 1969).

Table 1.--Estimated annual catches (metric tons) of billfishes of the Indian Ocean by species and country, 1975 and 1976.

Country	Blue marlin	Striped marlin	Black marlin	Swordfish	Sailfish
1975					
Japan	700	900	500	700	200
Taiwan	447	344	192	291	511
Korea	1,130	870	495	244	280
1976					
Japan	300	500	200	300	200
Taiwan	343	819	78	371	261
Korea	872	2,082	198	398	140

Table 2.-Estimated total catch (metric tons) relative abundance (kg/100 hooks) and effective effort (10⁶ hooks) for Indian Ocean billfishes. (From Wetherall et al. see text footnote 1.)

Year	Blue marlin			Striped marlin			Black marlin			Swordfish			Sailfish		
	Catch (MT)	Abundance index (kg/100 hooks)	Effective effort (10 ⁶ hooks)	Catch (MT)	Abundance index (kg/100 hooks)	Effective effort (10 ⁶ hooks)	Catch (MT)	Abundance index (kg/100 hooks)	Effective effort (10 ⁶ hooks)	Catch (MT)	Abundance index (kg/100 hooks)		Catch (MT)	Abundance index (kg/100 hooks)	
											North	South		North	South
1952	800	49.35	1.62	100	5.60	1.78	300	8.99	3.34						
1953	2,000	23.86	8.40	300	4.24	7.10	800	9.17	8.72						
1954	3,300	16.78	19.70	800	5.23	15.32	1,100	10.11	10.87	200	1.38		200	1.90	
1955	3,600	14.21	25.38	780	4.42	17.66	1,080	11.10	9.72	240	2.06		180	1.41	3.90
1955	4,950	10.58	47.17	1,740	3.99	43.72	1,500	7.87	19.06	480	2.00		300	0.97	2.29
1957	3,800	9.09	41.87	1,800	3.36	53.64	1,400	6.29	22.24	300	1.30		300	1.61	1.84
1958	4,100	11.07	37.09	1,700	3.56	47.89	1,200	9.57	12.31	500	1.72	1.47	400	1.90	0.92
1959	4,300	8.94	48.17	2,100	4.26	49.38	1,200	6.83	17.56	500	1.15	2.10	500	3.07	1.84
1960	3,700	6.17	60.06	2,000	2.70	74.19	1,700	5.93	28.64	600	1.36	1.40	500	2.29	2.98
1961	3,200	5.07	63.28	2,400	2.39	100.82	1,400	4.50	31.14	700	1.26	1.33	500	2.63	1.84
1962	3,100	5.08	61.10	1,800	2.24	80.53	1,800	5.17	34.81	900	1.17	1.12	800	2.34	3.90
1963	2,634	3.84	68.63	1,783	2.01	88.93	1,451	4.50	32.27	1,051	1.22	1.40	675	1.70	2.52
1964	3,740	4.32	86.66	1,886	1.85	102.09	1,654	4.23	39.13	1,254	1.10	1.40	777	1.51	1.84
1965	3,878	2.95	131.53	3,335	2.45	136.61	1,344	3.42	39.33	1,344	1.22	1.05	1,222	2.73	3.21
1966	3,354	2.84	132.51	4,163	1.92	216.80	1,391	4.09	34.00	1,391	1.24	1.12	1,296	2.24	3.21
1967	4,074	2.59	157.54	4,463	1.34	334.90	1,548	3.64	42.50	1,831	1.46	1.05	1,972	3.12	3.90
1968	4,036	2.26	178.85	3,436	1.55	226.58	2,460	4.18	58.83	1,971	1.32	0.91	1,630	2.34	2.98
1969	3,875	1.86	208.19	4,729	1.31	361.45	2,339	4.27	54.76	2,284	1.35	1.33	1,187	1.80	3.67
1970	3,038	1.72	177.35	3,110	1.00	313.06	1,845	2.65	69.55	2,255	1.25	1.40	1,016	3.17	3.90
1971	2,532	2.03	124.97	2,052	0.94	222.82	1,435	3.24	44.31	1,583	1.10	1.61	1,349	2.63	3.44
1972	2,509	2.82	89.08	1,511	0.79	191.88	893	1.89	47.29	1,554	1.62	1.96	1,145	2.87	4.36
1973	1,891	3.28	57.69	1,117	1.03	108.48	709	1.93	36.67	1,148	1.05	1.12	429	2.09	5.05
1974	2,370	3.30	71.94	2,800	1.31	214.01	1,342	1.98	67.83	1,771	1.32	0.84	652	2.09	4.59
1975	2,277	1.86	22.33	2,114	1.37	154.43	1,187	1.93	61.39	1,235	1.21	1.19	991	1.51	3.21
1976	1,515	1.88	80.68	3,401	1.92	177.13	476	1.75	27.14	1,069	1.26	1.12	601	2.39	5.28

Blue marlin catches rose to a high of 4,980 mt in 1956, fluctuated between 4,980 and 2,634 mt from 1956 to 1970, and dropped to 1,515 mt in 1976 (Figure 3). Striped marlin catches reached a high of 4,729 mt in 1969 and have since varied between 1,117 and 3,401 mt (Figure 4). Black marlin catches increased to a peak of 2,460 mt in 1968 and have generally decreased since then (Figure 5). Swordfish catches amounted to almost 2,300 mt in 1969 and 1970. There was a steady rising trend before those years and an irregularly declining trend after (Figure 6). The trend of sailfish catches was up before 1967, when 1,972 mt were caught, then declined to present levels (Figure 7).

I.C. Value of Catch

Most of the Indian Ocean billfish catch is presumed to have been sold in Japan. The average monthly ex-vessel prices at Yaizu, Japan, for blue, striped, and black marlins, and swordfish, from January 1978 to May 1979 ([U.S.] National Marine Fisheries Service 1978-1979), are presented in Table 3. During that period, striped marlin, the most valuable of the billfish species, sold for \$2,316 a short ton to \$4,345 a short ton. Swordfish prices were usually better than blue marlin prices which, in turn, were usually better than black marlin prices. Swordfish prices ranged from \$2,129 a short ton to \$2,833 a short ton; blue marlin, \$1,933-\$3,156 a short ton; and black marlin, \$1,638-\$2,744 a short ton.

I.D. Current Management of the Fishery

None of the billfishes in the Indian Ocean are currently under management.

II. NATURE AND SIGNIFICANCE OF U.S. AND FOREIGN PARTICIPATION IN THE FISHERY

The U.S. is interested in the billfishes of the Indian Ocean as a resource, but is not actively involved in fishing for them.

III. STATUS OF THE STOCKS

III.A. Stock Structure

The extant data on the spawning areas and the geographical variation in catch rates suggest a single stock of blue marlin in the

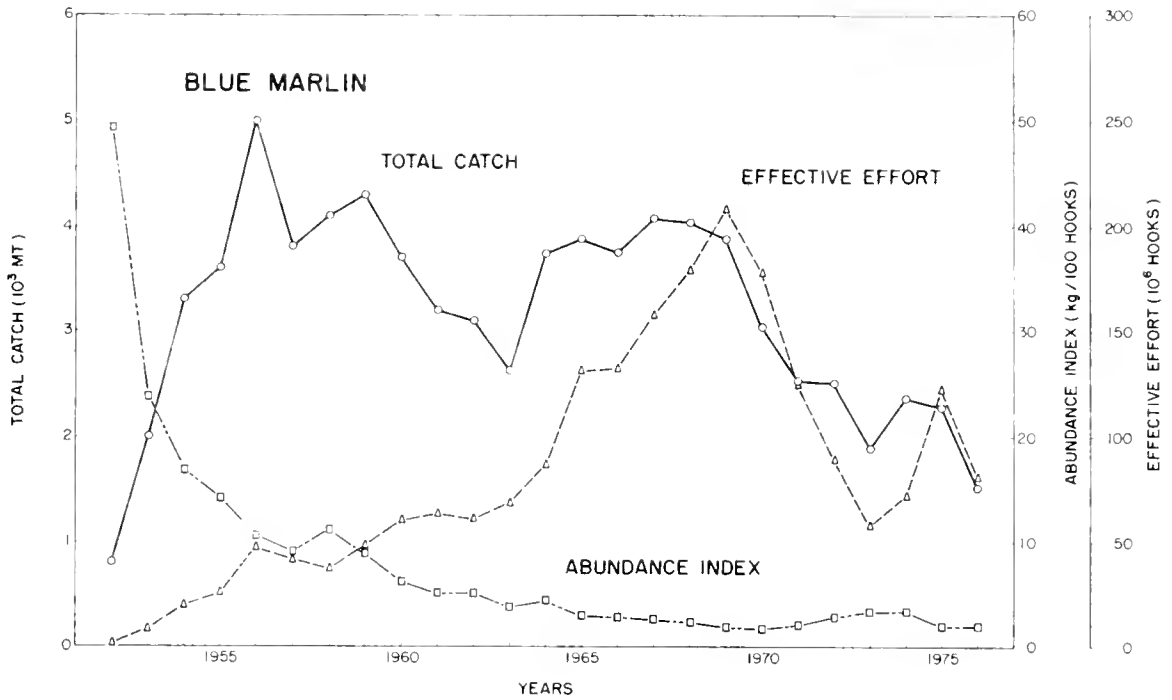

Figure 3.--Estimated total catch (10³ MT), relative abundance (kg/100 hooks), and effective effort (10⁶ hooks) for Indian Ocean blue marlin. (From Wetherall et al. see text footnote 1.)

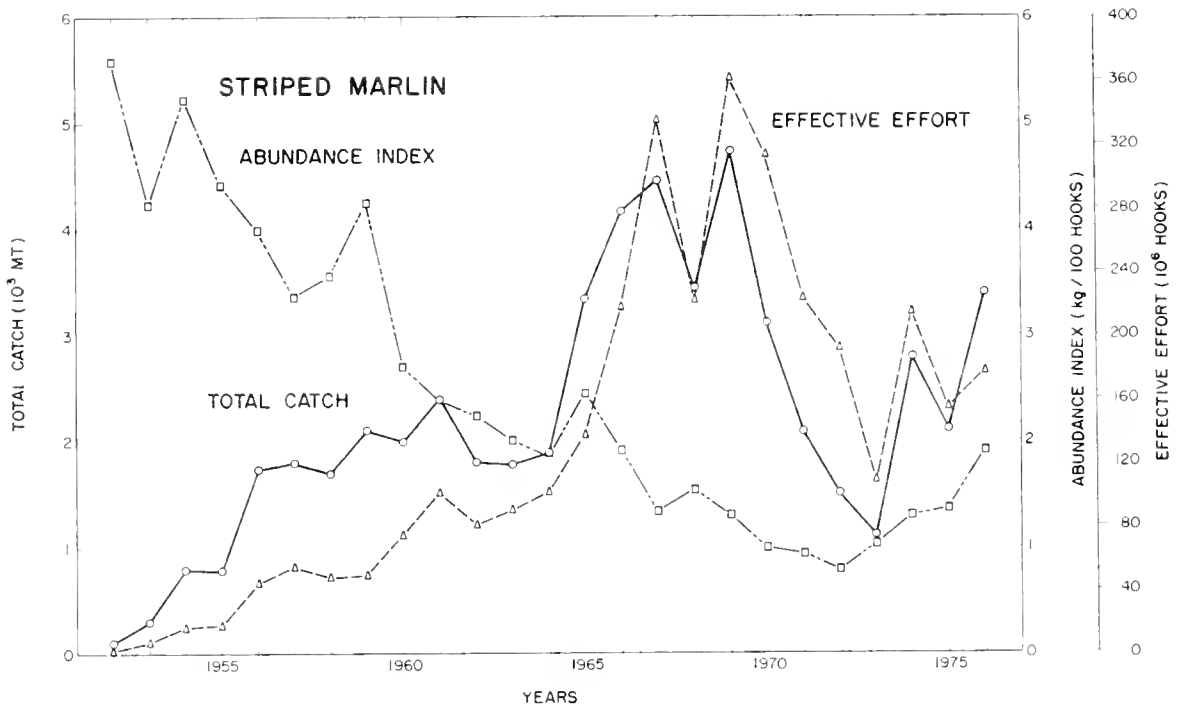

Figure 4.--Estimated total catch (10^3 MT), relative abundance (kg/100 hooks), and effective effort (10^6 hooks) for Indian Ocean striped marlin. (From Wetherall et al. see text footnote 1.)

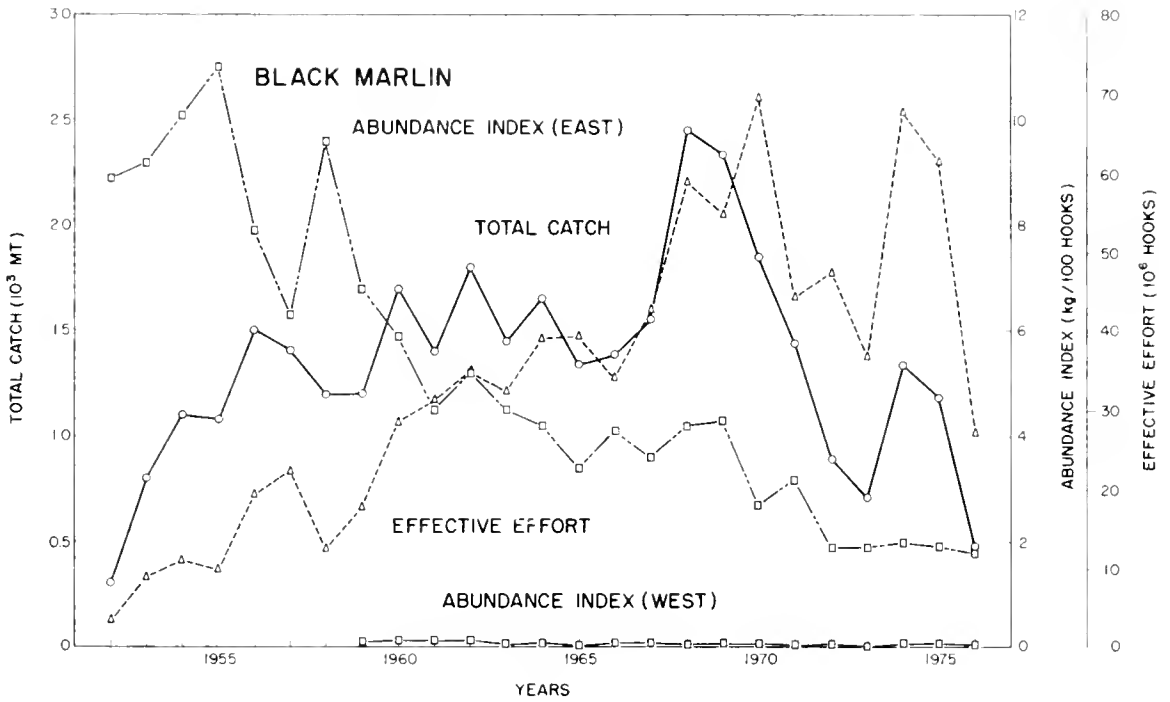

Figure 5.--Estimated total catch (10³ MT), relative abundance (kg/100 hooks), and effective effort (10⁶ hooks) for Indian Ocean black marlin. (From Wetherall et al. see text footnote 1.)

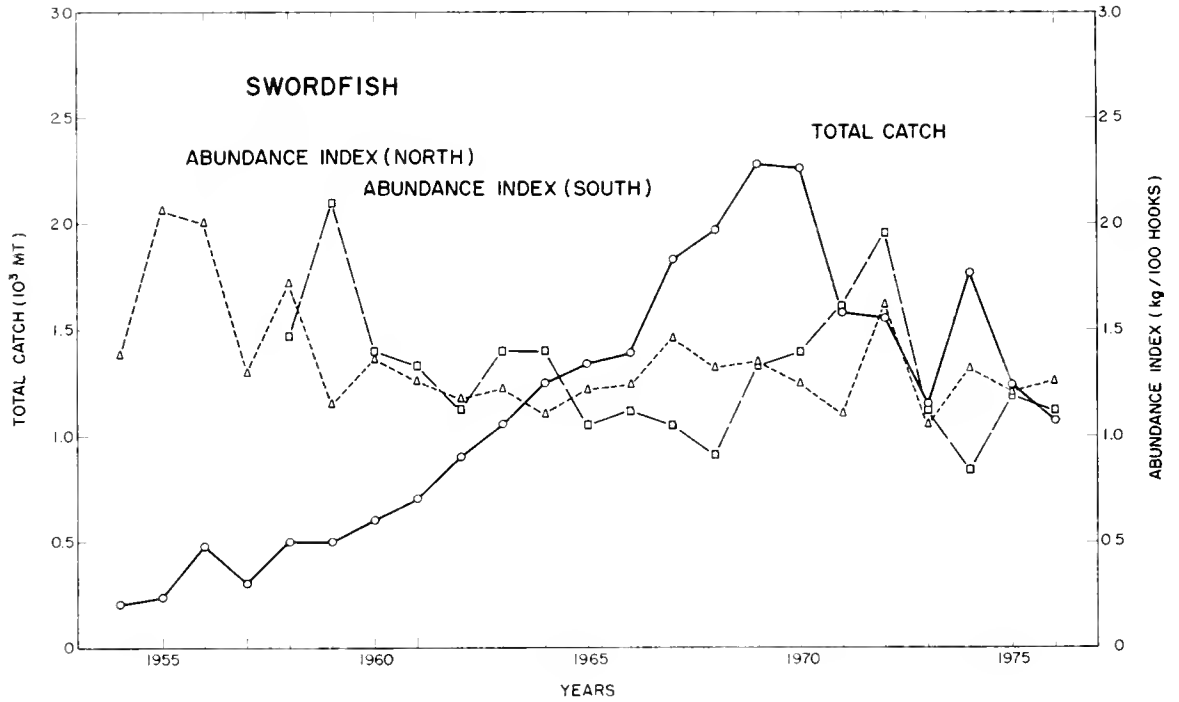

Figure 6.--Estimated total catch (10³ MT) and relative abundance (kg/100 hooks) for Indian Ocean swordfish. Abundance indices are given for two index areas. (From Wetherall et al. see text footnote 1.)

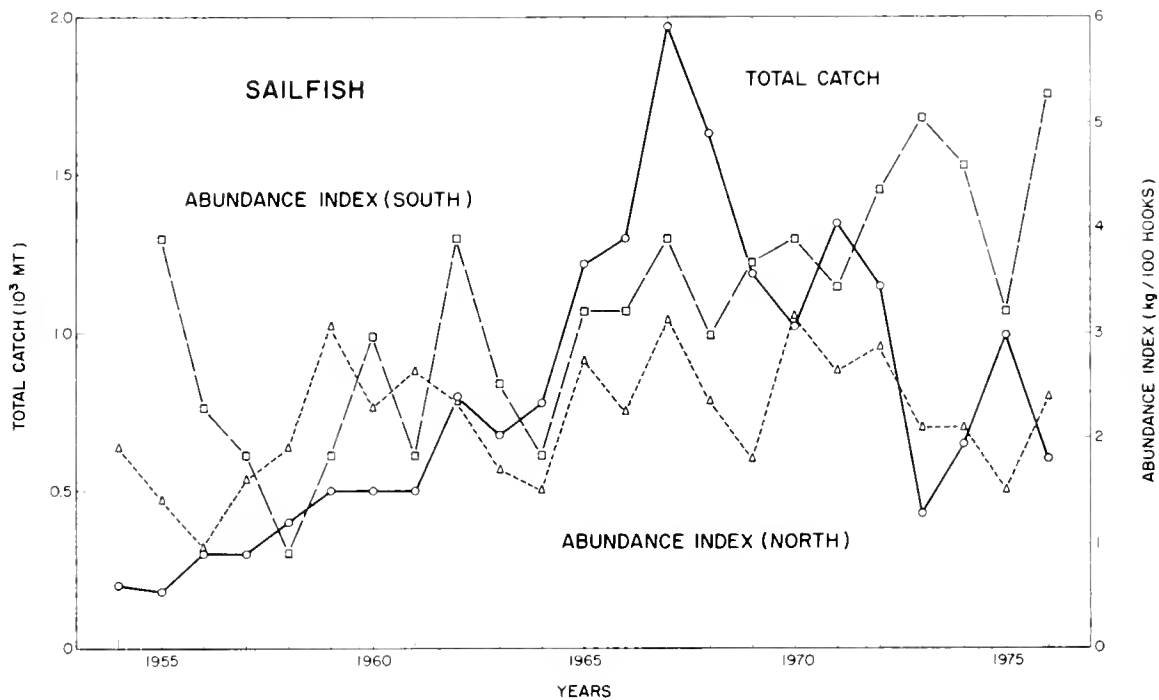

Figure 7.--Estimated total catch (10³ MT) and relative abundance (kg/100 hooks) for Indian Ocean sailfish. Abundance indices are given for two index areas. (From Wetherall et al. see text footnote 1.)

Table 3.--Monthly average ex-vessel prices of billfishes (U.S. dollars per short ton) at Yaizu fish market, January 1978-May 1979. (From [U.S.] National Marine Fisheries Service 1978-1979.)

Month	Striped marlin	Blue marlin	Black marlin	Swordfish
1978				
January	3,482	2,009	2,605	2,423
February	2,823	2,326	2,070	2,503
March	3,452	2,299	2,025	2,647
April	2,722	2,515	2,082	2,833
May	2,614	2,112	1,929	2,343
June	2,462	1,991	2,090	2,263
July	4,345	2,122	2,272	2,658
August	2,507	2,275	1,638	2,826
September	2,903	2,039	1,943	2,769
October	2,856	2,412	2,055	2,793
November	3,981	3,165	2,202	2,590
December	2,698	2,323	1,934	2,703
1979				
January	4,141	1,933	2,744	2,455
February	4,046	2,027	2,059	2,440
March	4,095	2,510	1,871	2,580
April	2,316	2,658	1,730	2,232
May	2,489	2,626	1,818	2,129

Indian Ocean. There are few definitive data to support either a single or multiple stock hypothesis, but similar types of data suggest the possibility of multiple stocks for striped marlin, black marlin, swordfish, and sailfish in this area.

III.B. Stock Assessment and Fishery Evaluation

III.B.1. Trends in Catch-per-Unit-Effort

There was a decline in the catch-per-unit-effort over the 1952 to 1976 period in the Japanese longline fishery for blue marlin (Figure 3), striped marlin (Figure 6), and black marlin (Figure 5). Catch rates for swordfish have not declined significantly (Figure 6), and catch rates for sailfish (including small amounts of shortbill spearfish) have been quite variable although a general increase over the 1952 to 1976 period is evident (Figure 7).

III.B.2. Results of Production Model Analysis

The following production model analyses were applied to available data for Indian Ocean billfishes to obtain a better indication of the status of the stocks (FAO, in press):

The production model analysis for blue marlin suggested a MSY (maximum sustainable yield) of 3,400-3,600 mt achievable with substantially less effort than has recently been expended (Table 4). However, the curve fits the data points poorly (Figure 8), suggesting that there may be significant errors in the total catch estimates.

For striped marlin, assuming a single stock, the MSY from the production model analysis is 3,500 mt at a level of effort considerably more than the highest effort expended to date (Table 4). Annual catches at effort levels of 150 to 300 million hooks are widely variable about the equilibrium yield curve (Figure 9).

The estimated MSY for black marlin is 1,400 to 1,500 mt (Table 4). Optimum effort is less than those of recent levels but the yield-effort curve (Figure 10) is quite flat. Effort levels of 40 to 60 million hooks have resulted in catches with considerable variation about the equilibrium yield curve. The catch data points for 1972 to 1976 are below the curve, whereas the points for 1968 to 1971 are all above the curve, suggesting the possibility of some systematic bias in the above estimates.

The data for swordfish suggest that longlining has had no significant impact on the swordfish population, so no production model analysis was attempted.

Table 4.--Results of production model analyses for Indian Ocean blue marlin, striped marlin, and black marlin.
(From Wetherall et al. see text footnote 1.)

Smoothing period (year)	Striped marlin				Blue marlin				Black marlin			
	\hat{MSY} (MT)	\hat{E}_{opt} (10^6 hooks)	\hat{M}	Fit index	\hat{MSY} (MT)	\hat{E}_{opt} (10^6 hooks)	\hat{M}	Fit index	\hat{MSY} (MT)	\hat{E}_{opt} (10^6 hooks)	\hat{M}	Fit index
1	3,215	449	0.10	1.0000	3,572	229	0.05	0.9774	1,526	173	0.75	1.0001
2	2,930	219	0.24	1.0128	3,652	71	0.62	1.0282	1,484	158	0.63	1.0001
3	3,557	∞	0.00	1.0022	3,527	77	0.63	1.0023	1,430	170	0.35	1.0000
4	3,153	607	0.07	1.0008	3,377	78	0.52	1.0008	1,397	217	0.17	1.0000

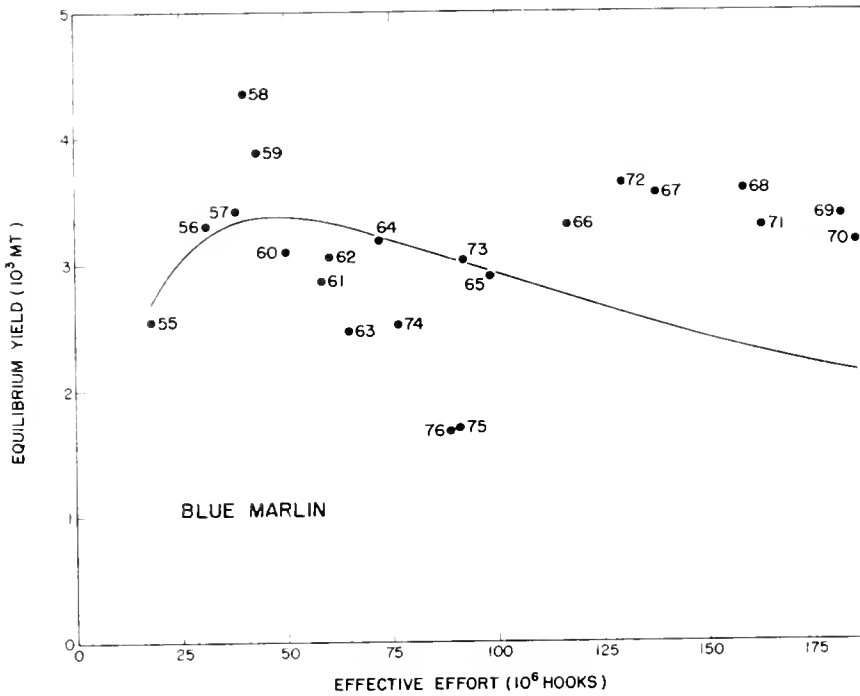

Figure 8.--Predicted relationship between equilibrium yield (10³ MT) and effective effort (10⁶ hooks) for Indian Ocean blue marlin, based on production model analysis. (From Wetherall et al. see text footnote 1.)

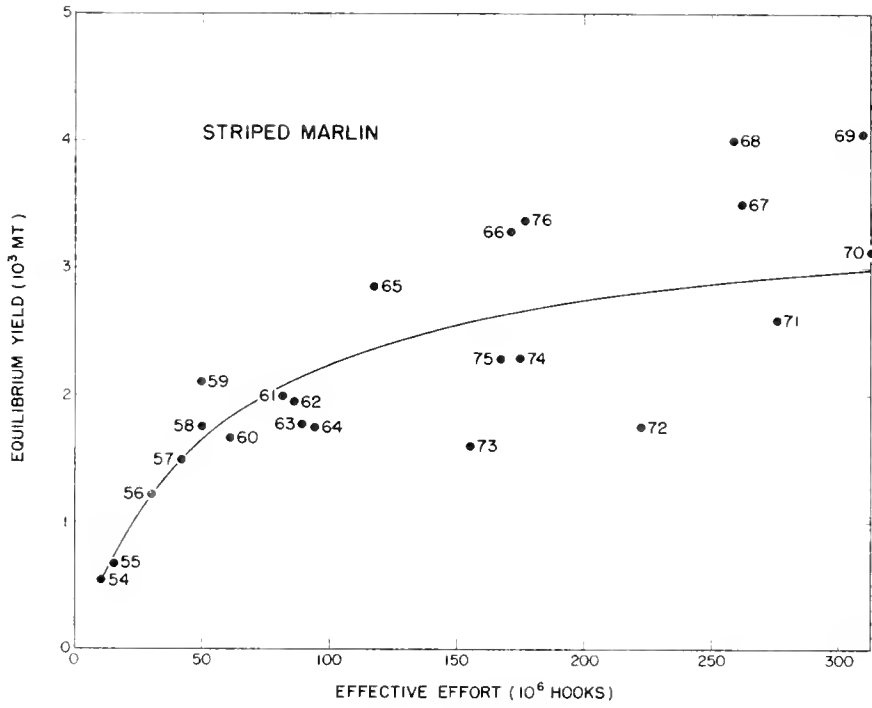

Figure 9.--Predicted relationship between equilibrium yield (10^3 MT) and effective effort (10^6 hooks) for Indian Ocean striped marlin, based on production model analysis. (From Wetherall et al. see text footnote 1.)

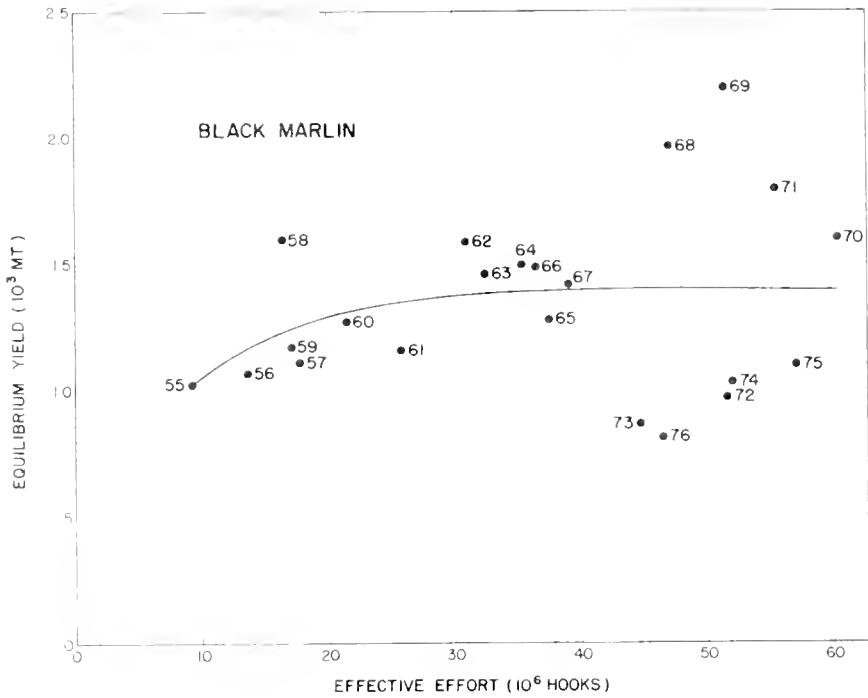

Figure 10.--Predicted relationship between equilibrium yield (10³ MT) and effective effort (10⁶ hooks) for Indian Ocean black marlin, based on production model analysis. (From Wetherall et al. see text footnote 1.)

The sailfish data, like the swordfish data, indicate the stock has not been affected by fishing. The potential yield for sailfish is probably much higher than the maximum annual catch taken thus far.

III.B.3. Results of Yield-per-Recruit Analysis

None available.

III.B.4. Results of Spawner/Recruitment Analysis

None available.

III.B.5. Results of Other Analyses/Simulations

None available.

III.C. Current Evaluation of Stocks and the Fishery

Because of deficiencies in estimates of total catch for Indian Ocean billfishes, the results of the production model analyses given above should be considered tentative. However, the substantial decline in catch-per-unit-effort for blue marlin and black marlin since the inception of the longline fishery suggests that no significant increases in total yield can be expected for these stocks. The potential for increased striped marlin yields appears to be somewhat greater; the stocks of swordfish and sailfish do not appear to have been appreciably affected by the effort expended to date.

IV. STATUS OF CURRENT RESEARCH NEEDS AND EFFORTS

IV.A. Major Research Problems

Better assessments of the status of Indian Ocean billfishes are needed which will require considerable improvements in fishery statistics. Steps should be taken to correct deficiencies in species identification and to provide for the acquisition of catch data by species.

IV.B. Current Research Efforts

Compared to the study of other species, research on billfishes in the Indian Ocean has been considered of low priority and there are few published papers on the subject in the literature. Based on the results of longline fishing, a study of the distribution and biology of striped marlin in the Indian Ocean was published in 1978 (Pillai and Ueyanagi 1978). Two background papers^{1,2} on the assessment of Indian Ocean billfishes were presented at the Workshop on the Assessment of Selected Tuna and Billfish Stocks in the Pacific and Indian Oceans held in Shimizu, Japan, in June 1979 (FAO, in press).

Current research efforts on Indian Ocean billfishes include studies on their general biology at the Central Marine Fisheries Research Institute, India, and studies on their biology and population dynamics at the Far Seas Fisheries Research Laboratory Shimizu, Japan.

IV.C. Future Research Needs

1) Because research on Indian Ocean billfishes has been considered of low priority, these species have been the subject of comparatively little research. Estimates of growth rates, mortality rates, and recruitment for Indian Ocean billfishes are needed.

2) One of the first attempts at assessing the status of Indian Ocean billfishes was made at the Shimizu Workshop (FAO, in press). It was pointed out that deficiencies in estimates of total catch for Indian Ocean billfishes made the reliable assessment of potential yield and optimum fishing effort difficult. Reliable assessment of the status of Indian Ocean billfishes requires considerable improvements in the fishery statistics. In particular, steps are needed to improve basic requirements such as correctly identifying species and allowing for separate recording of the catch of each species in longline logbooks.

I.V.C.1. Suggested Approach and Methods

First priority should be given to collecting statistics of total catch. Data on fishing effort, size composition, and detailed locality of capture are also essential for stock and fishery assessments. Participants at the Shimizu Workshop strongly recommended that countries landing large quantities of tuna (but collecting inadequate fishery

²Honma, M., and S. Ueyanagi. 1979. Stock assessment of billfishes in the Indian Ocean. Prepared for the Workshop on the Assessment of Selected Tunas and Billfish Stocks in the Indian and Pacific Oceans. Shimizu, Japan, 13-22 June 1979.

statistics) take action to improve their data. The same holds true for the billfishes. In addition to national data collection efforts, the statistics cannot be effectively organized, disseminated, and evaluated until regional institutions are organized to accomplish these tasks.

IV.D. Status of SWFC Data Base

Published billfish fishery statistics from Japan and Taiwan are in the data base maintained at the Honolulu Laboratory, which also contains data obtained through contacts with scientists in Japan and Taiwan. Data from Korean longline operations, however, are lacking. Attempts should be made to obtain these missing data and to improve the accuracy of data collected.

LITERATURE CITED

- Food and Agriculture Organization of the United Nations.
1977. Catches and landings, 1976. FAO Yearbook Fish. Stat. 42, 323 p.
- In press. Summary report of the Workshop on the Assessment of Selected Tuna and Billfish Stocks in the Pacific and Indian Oceans, Shimizu, Japan, 13-22 June 1979. FAO Fish. Rep.
- Honma, M., and Z. Suzuki.
1972. Stock assessment of yellowfin tuna exploited by longline fishery in the Indian Ocean, 1959-1969. [In Jpn., Engl. Abstr.] Bull. Far Seas Fish. Res. Lab. (Shimizu) 7: 1-25.
- Kikawa, S., T. Koto, C. Shingu, and Y. Nishikawa.
1969. Status of tuna fisheries in the Indian Ocean as of 1968. Far Seas Fish. Res. Lab., S. Serv. 2, 28 p.
- Pillai, P. P., and S. Ueyanagi.
1978. Distribution and biology of the striped marlin, Tetrapturus audax (Philippi), taken by the longline fishery in the Indian Ocean. Bull. Far Seas Fish. Res. Lab. (Shimizu) 16: 9-32.
- Shomura, R. S. (editor).
1980. Summary report of the Billfish Stock Assessment Workshop, Pacific resources. NOAA Tech. Memo. NMFS-SWFC-5, 58 p.
- Ueyanagi, S.
1974. A review of the world commercial fisheries for billfishes. In R. S. Shomura and F. Williams (editors), Proceedings of the International Billfish Symposium, Kailua-Kona, Hawaii, 9-12 August

1972, Part 2. Review and Contributed Papers, p. 1-11. U.S. Dep. Commer., NOAA Tech. Rep., NMFS SSRF-675.

[U.S.] National Marine Fisheries Service.
1978-1979. Foreign fishery information release. Supplement to Marketing News Report.

STATUS REPORT: EASTERN TROPICAL PACIFIC YELLOWFIN TUNA

by

Samuel F. Herrick, Jr.

Southwest Fisheries Center
Oceanic Fisheries Resources Division
La Jolla, California

ABSTRACT

The status of eastern Pacific yellowfin tuna has been evaluated using general production models and age-structured models. Results of the production model analyses indicate that the eastern Pacific yellowfin fishery is currently operating at levels above maximum sustainable yield. The age-structured analyses raise concerns over the increased dependency of the fishery on age-1 fish. Recent increases in age-1 catches could lead to a decrease in yield-per-recruit and a diminished potential yield. Heavy fishing on a succession of poor recruit classes could reduce the adult population such that recruitment failure occurs. Efforts to reverse these trends in the near future are complicated by a failure to reach agreement on a mechanism for implementing an eastern Pacific yellowfin conservation program in 1980.

I. DESCRIPTION OF THE FISHERY

The eastern Pacific Ocean yellowfin tuna fishery is primarily conducted within an area known as the eastern tropical Pacific (ETP), which is bounded by 40° N latitude, 30° S latitude, 150° W longitude, and the west coasts of North, Central, and South America. For management purposes, the Inter-American Tropical Tuna Commission (IATTC) divides the ETP into two subregions: 1) the Commission Yellowfin Regulatory Area (CYRA), and 2) the remaining area outside the CYRA (Figure 1). Longline and surface gears (baitboats, purse seiners, and bolicheras) are used to catch skipjack, bigeye, bluefin, and albacore tunas in the ETP, as well as yellowfin tuna.

Jig boats or trollers also fish in the ETP for tuna but tend to concentrate their fishing effort in the northern fringe of the CYRA. Jig boat catches of yellowfin tuna are usually incidental to those of albacore, the target species, and therefore make only a minor contribution to the ETP yellowfin catch.

I.A. History of the Fishery

Catches of yellowfin tuna were reported by U.S. baitboats fishing inshore areas off southern California as early as 1919. Baitboats dominated the fishery until the late 1950's, when major technological advancements in gear precipitated a large scale conversion to purse seining. Between 1958 and 1960 the purse seine component of the eastern Pacific tuna fleet soared from 13% to 54%, and by the end of 1960 the purse seine fleet was operating throughout its present north-south range, from California to Peru. As the fishery extended southward, many Latin American nations, attracted by the performance of the U.S. purse seiners, started developing their own tuna fleets. Since then the fishery has grown fairly steadily, and by 1979 vessels from 18 countries were participating in the fishery. In terms of numbers, the 1979 ETP combined surface fleet consisted of 81% purse seiners, 14% baitboats, 4% bolicheras (small purse seiners of less than 45 mt carrying capacity) and 1% jig boats. The purse seiners accounted for 98% of the ETP carrying capacity, with baitboats, bolicheras, and jig boats contributing the remaining 2%.

Fishing for yellowfin tuna in the ETP west of the CYRA and east of 150° W longitude developed following World War II, when Japanese longliners expanded their range of operations eastward from the western Pacific. Japanese longliners began fishing in the ETP in the late 1950's, and longliners from Taiwan and South Korea entered the fishery in 1962 and 1965, respectively. Until the late 1960's, fishing in the "outside" area was conducted solely by longliners. Large purse seiners began to fish in the outside area in 1968-1969, two years after the yellowfin quota system was established for the CYRA.

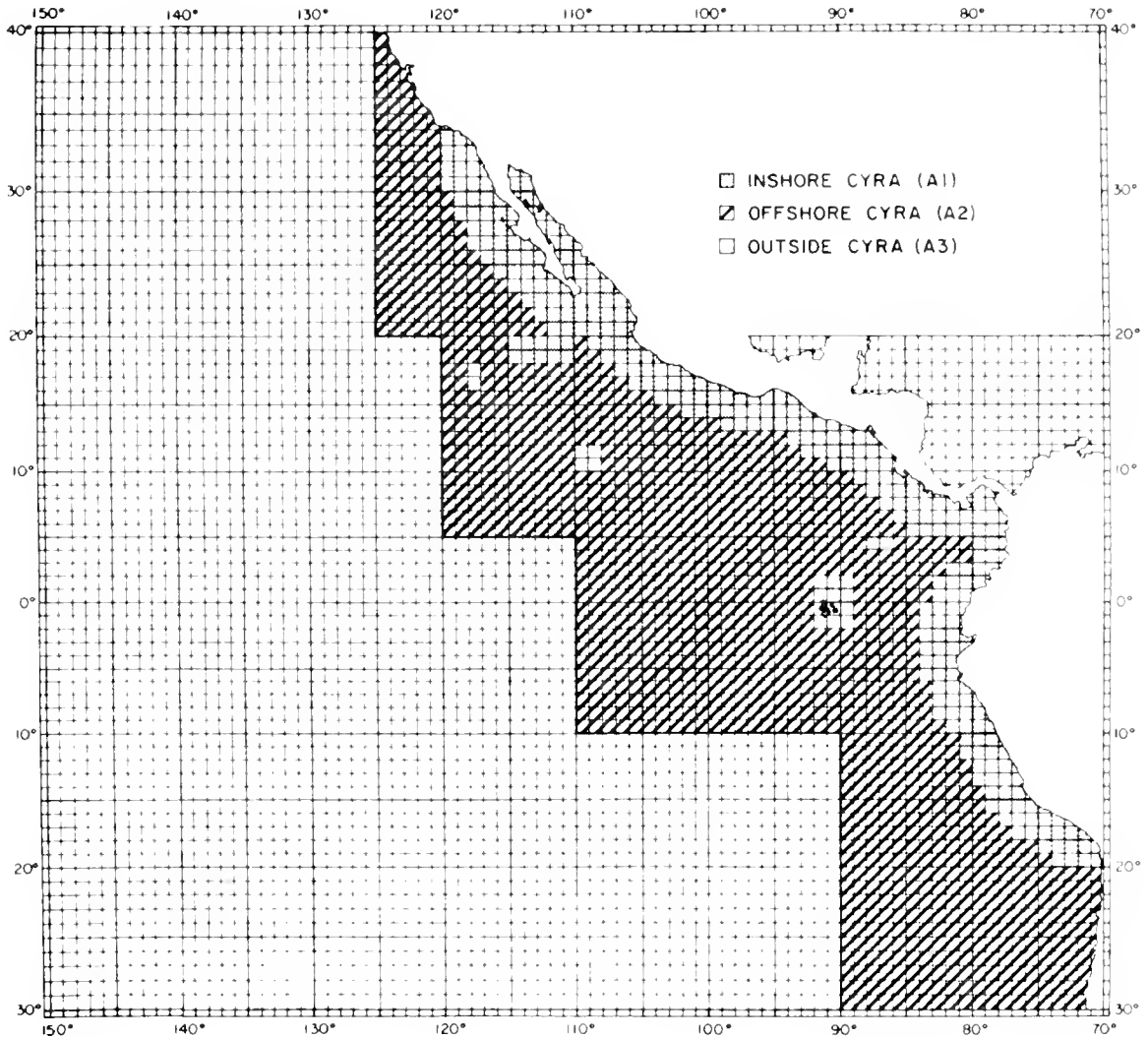

Figure 1. The eastern tropical Pacific Ocean showing the historical area of the fishery for yellowfin tuna, the more recently fished area within the Commission's Yellowfin Regulatory Area (CYRA), and the area outside the CYRA.

In recent years, the U.S., Japan, Korea, Taiwan, and Costa Rica have participated in the outside fishery, with the U.S. responsible for more than 95% of this area's yellowfin catch. The surface catches of yellowfin from the outside area have ranged from a low of 1,100 mt in 1968 to a high of 46,000 mt in 1976. Since 1976, the yellowfin catch from the outside area has decreased dramatically (13,000 mt in 1979).

In 1979, the U.S. was the leading participant in the overall ETP yellowfin fishery with 61% of the catch, followed by Mexico (13%), and Ecuador (5.5%) (Figure 2). Other countries that contributed to the 1979 ETP yellowfin catch included Bermuda, Canada, Colombia, Congo, Costa Rica, Japan, Korea, Netherlands, New Zealand, Nicaragua, Panama, Peru, Senegal, Spain, and Venezuela.

I.B. Trends in Catch and Effort

Catches of yellowfin tuna from the ETP have been reported as far back as 1919, when approximately 300 mt were landed in California. Catches increased steadily thereafter (except for a decrease during World War II) to approximately 102,000 mt in 1950. Catches declined in the 1950's to a low of 63,000 mt in 1954 but rebounded sharply, with the introduction of the modern purse seine technology, to 109,000 mt in 1961. From 1966 to 1979 an annual quota was placed upon yellowfin caught within the CYRA and the catch trend during that period reflected the quota: 83,000 mt from the CYRA in 1966 to a preliminary catch of 177,000 mt in 1979 (Figure 3).

Because the ETP tuna fishery exploits both yellowfin and skipjack tunas over much of the areas fished, it is difficult to distinguish fishing effort by species. However, estimates based upon yellowfin catch and yellowfin catch-per-standard-days-fishing in Class-3 (92 to 182 mt carrying capacity) purse seine units show effort increasing from approximately 18,000 standard days in 1967 to approximately 78,000 standard days in 1979. Estimates using yellowfin catch from the outside area and catch-per-day-fishing in Class-6 (greater than 365 mt carrying capacity) purse seine units indicate that effort increased from approximately 900 days in 1969 to approximately 4,000 days in 1974, then declined to 1,800 days in 1979.

I.C. Value of Catch

Of the major ETP fishing nations, ex-vessel yellowfin prices are available only for the U.S. United States ex-vessel prices for yellowfin tuna in 1979 were \$1,044/mt for yellowfin greater than seven (7) pounds, and \$890/mt for yellowfin less than seven (7) pounds. Based upon an average U.S. ex-vessel price of \$967/mt, the 1979 yellowfin catch of 177,000 mt from within the CYRA generated approximately \$171 million in landings revenue. The yellowfin catch from outside the CYRA (13,000 mt) generated approximately \$13 million. The ex-vessel revenue generated by the combined 1979 yellowfin catch inside and outside the CYRA was approximately \$184 million.

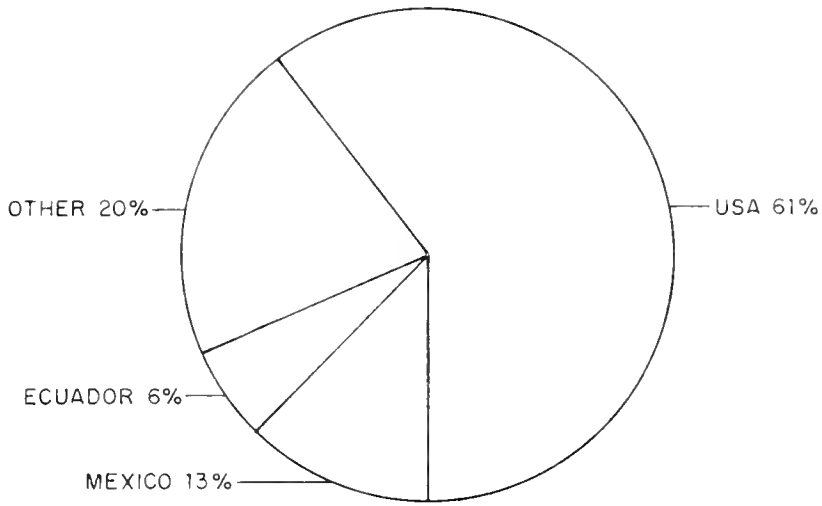

Figure 1. Major participants in the eastern tropical Pacific Ocean yellowfin tuna fishery based upon percent of total catch in 1979.

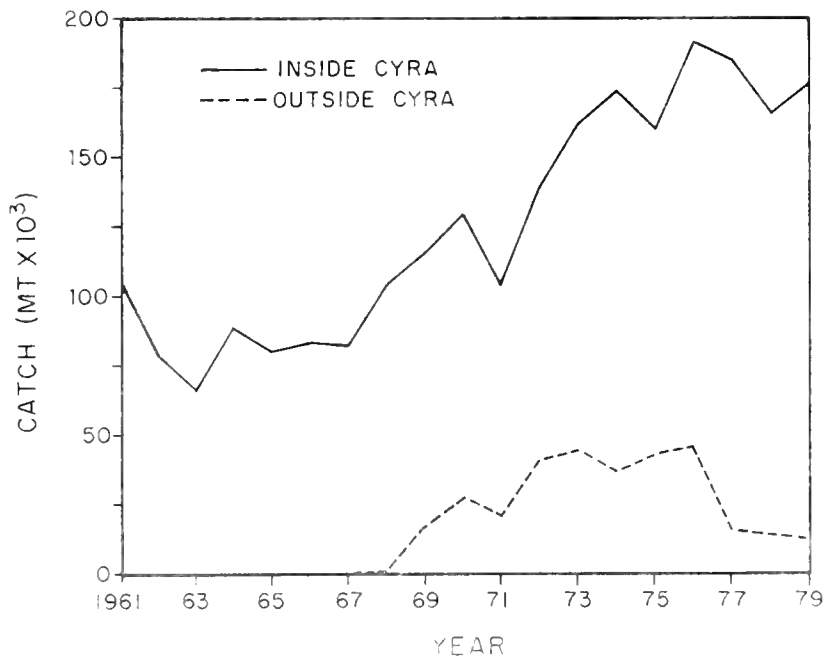

Figure 2. Catches of yellowfin tuna from inside and outside of the CYRA in the eastern tropical Pacific.

I.D. Current Management of the Fishery

In 1950 the Inter-American Tropical Tuna Commission (IATTC) was formed through a Convention between the Republic of Costa Rica and the United States. The convention is open to other governments whose nationals fish for tropical tunas in the ETP with the unanimous consent of the present members. Current members include the United States, Panama, Canada, Japan, France, and Nicaragua (Ecuador, Mexico, and Costa Rica have withdrawn from the Commission).

The principal duties of the Commission under the Convention are to 1) study the biology, ecology, and population dynamics of the tunas and related species of the eastern Pacific Ocean with a view toward determining the effect of fishing and natural factors on their abundance; and 2) recommend, when appropriate, conservation measures that will maintain the fish stocks at levels which will afford maximum sustainable catches.

The first conservation measure proposed by the Commission was a quota limiting the annual catch of yellowfin tuna from the ETP for 1962. But the first CYRA yellowfin quota was not implemented until 1966. Since then yellowfin catch quotas have been imposed or recommended annually. (Since 1971 these quotas have been expressed as base numbers plus the possibility of one or two increments to be added at the discretion of the Director of Investigations. The increments are part of an over-fishing experiment designed to estimate empirically the relationship between catch and effort.)

The closure date for unrestricted yellowfin fishing inside the CYRA is established when

$$\begin{aligned} & \text{current catch} + \text{expected catch of yellowfin by vessels at sea} \\ & \quad \text{engaged in unrestricted fishing and by vessels} \\ & \quad \text{expected to depart on unrestricted trips within} \\ & \quad \text{the specified grace period} \\ & = \text{the quota} - \text{that portion of the quota reserved for the} \\ & \quad \text{incidental catch of yellowfin after the closure} \\ & \quad \text{of the CYRA} \\ & \quad + \text{any special CYRA yellowfin allocations granted} \\ & \quad \text{during the year. (There are special allocations} \\ & \quad \text{for "small" vessels, newly-constructed vessels of} \\ & \quad \text{developing nations, and vessels engaged in} \\ & \quad \text{Commission-designated research programs.)} \end{aligned}$$

Further safeguards call for the immediate curtailment of yellowfin fishing if, at any time, the yellowfin catch-per-standard-days-fishing within the CYRA falls below 2.7 mt.

In 1979 the CYRA quota was 159,000 mt with increments of 18,000 mt and 14,000 mt. For 1980 the Commission recommended a CYRA yellowfin quota of 150,000 mt with provisions for incremental increases to 191,000 mt.

II. NATURE AND SIGNIFICANCE OF U.S. AND FOREIGN PARTICIPATION IN THE FISHERY

Virtually all of the U.S. yellowfin catch from the ETP is landed and consumed domestically. In 1979, domestic landings of all tuna species totalled 213,000 mt; of these, 126,000 mt, or 55%, were yellowfin. Of all 1979 domestic yellowfin landings, approximately 120,000 mt were taken from the ETP. This represents 95% of all domestic yellowfin landings and 52% of all domestic tuna landings for 1979. The domestic yellowfin catch from the ETP contributed approximately 20% of the 595,000 mt of tuna (all species) used in the 1979 U.S. cannery supply of fresh and frozen tuna (domestic landings and foreign imports).

During 1979 the U.S. tuna fleet operating in the ETP consisted of 138 purse seiners (81%), 28 baitboats (17%), and 3 jig boats (2%). In terms of U.S. fleet carrying capacity, purse seiners contributed approximately 90,000 mt, baitboats 2,300 mt, and jig boats 27 mt. The domestic ETP yellowfin catch in 1979 generated approximately \$116 million in landings revenue, based upon 1979 U.S. ex-vessel prices.

Besides being the cornerstone of the U.S. tuna fleet operations, the ETP yellowfin fishery contributes significantly to employment in U.S. canneries located in California and Puerto Rico. Tuna canneries in California employed an average of 6,215 people during 1978, while canneries in Puerto Rico employed an average of 6,834 people. While these canneries process other species on occasion (e.g. bonito, black skipjack, anchovies, and mackerel), tuna is the mainstay of cannery operations and without tuna these canneries would probably cease to exist.

Foreign tuna fishing activity in the ETP has shown an upsurge over the last decade. From 1970 to 1979 the foreign portion of the CYRA yellowfin catch increased from 18% to 37%, reaching 43% in 1978. While U.S. fleet carrying capacity in the eastern Pacific has declined by about 8% since 1976, foreign capacity has grown by over 30%. From 1976 through August 1980 the number of foreign purse seiners fishing in the eastern Pacific rose from 94 to 125 (Table 1), representing a 33% decrease in the number of U.S. purse seiners. However, since 1978 the combined carrying capacity of the U.S. and foreign purse seine fleets has remained almost constant.

Most of the growth in foreign purse seine numbers since 1977 can be attributed to vessel flag transfers. Transfers of U.S. purse seiners to foreign flags fishing in the eastern Pacific from 1977 through September 1980 numbered 14, with a total carrying capacity of 12,419 mt (Table 2). In addition, seven new vessels destined for foreign fleets operating in the eastern Pacific were completed during this period, or are currently under construction in U.S. shipyards. All of these new vessels have a 1,092 mt carrying capacity.

Table 1. Number of vessels and fleet carrying capacity (metric tons) for U.S. and foreign purse seine fleets operating in the ETP, 1974 to 1980.

Year	Number of U.S. Purse Seiners in ETP	Capacity of U.S. Purse Seiners in ETP	Number of Foreign Purse Seiners in ETP	Capacity of Foreign Purse Seiners in ETP	Total Fleet Capacity in ETP
1974	135	95,222	77	35,892	138,744
1975	142	107,828	82	39,285	153,909
1976	155	109,934	94	49,425	166,725
1977	142	105,652	104	55,132	166,493
1978	140	100,958	121	63,425	169,810
1979	138	100,835	121	64,542	169,390
1980	135	100,595	125	65,024	169,227

1. Fleet status as of August 1980.

Table 2. U.S. tuna purse seine flag transfers, 1977 to 1980.

Country to Which Transferred	Carrying Capacity (Metric Tons)	Year Built
<u>1977-1978</u>		
Netherlands Antilles	1,000	1972
Netherlands Antilles	1,000	1973
Panama	710	1963
Panama	710	1952
Costa Rica	1,000	1969
Costa Rica	845	1967
Costa Rica	710	1970
Netherlands Antilles	1,000	1973
Netherlands Antilles	1,000	1972
<u>1979</u>		
Cayman Islands (British)	490	1965
<u>1980 (through September)</u>		
Venezuela	1,273	1972
Cayman Islands	1,090	1974
Mexico	591	1967
Mexico	1,000	1971
Total Capacity	12,419	

A major factor influencing the role of U.S. tuna fishing in the ETP is that a CYRA yellowfin conservation program was not adopted for 1980. This situation stemmed primarily from the inability of Mexico, Costa Rica, and the United States to reach agreement on new management and access arrangements for tuna resources in the eastern Pacific. Until an eastern Pacific tuna management regime acceptable to Mexico and Costa Rica can be enacted by the member countries of the IATTC, the U.S. may be forced to concentrate its fishing effort in the areas outside the 200-mile zones of the countries bordering on the ETP. If such becomes the case, the U.S. would lose access to areas from which 65% of its historical catches of ETP yellowfin and skipjack tuna have been taken. Furthermore, since most of the yellowfin tuna caught in the outside areas of the ETP (areas A2 and A3, Figure 1) associate with porpoise, porpoise quotas are likely to be reached earlier in the year, which would severely limit the ability of the U.S. fleet to catch yellowfin in the ETP.

With exclusive access to highly productive fishing areas in the ETP, the fleets of the coastal nations adjacent to the resource can be expected to continue growing. Much of this growth may be through flag transfers of U.S. vessels otherwise denied access to these areas.

III. STATUS OF THE STOCKS

Research on the population dynamics of ETP yellowfin tuna is conducted by the scientific staff of the IATTC. During 1979 the IATTC scientific staff undertook investigations in the following areas: 1) population structure and migration; 2) abundance estimates and their relation to fishing success; 3) size composition and distribution of tunas by time and area; 4) feeding habits; 5) growth studies; 6) tuna/porpoise relationships; and 7) oceanography and tuna ecology.

III.A. Stock Structure

During 1979 the IATTC scientific staff continued its studies on the rates of mixing of individual tuna from different geographic areas of the Pacific. Results of these studies to date are inconclusive. However, tagging experiments indicate that the rate of mixing for yellowfin between the area inside the CYRA and outside the CYRA is low. Therefore, the production model analyses which have been done assume yellowfin tuna in these two areas to be two separate stocks.

III.B. Stock Assessment and Fishery Evaluation

III.B.1. Trends in Catch-per-Unit-Effort

The catch-per-standard-days-fishing (CPSDF) is used by the Commission as an index of relative apparent abundance of yellowfin as well as an index of relative fishing success. Annual CPSDF in Class-3 purse seine units and catch-per-day-fishing (CPDF) in Class-6 purse seine units for unregulated yellowfin fishing in the CYRA during the period 1970 to 1979 is shown in Figure 4. It can be seen that CPSDF was highest in 1970 and started to decline (with the exception of 1972) at a fairly steady rate thereafter. The preliminary data for 1980 show a continuation of the downward trend.

III.B.2. Results of Production Model Analysis

Two production model analyses were employed in 1979 to determine the status of the yellowfin stock inside the CYRA. Both methods used the logistic model but incorporated different time periods and employed different purse seine classes to standardize effort. In both cases, average maximum sustainable yield (AMSY) was estimated to be about 159,000 mt (Figures 5A and B). In each case, the 1976 to 1979 points fall to the right of the peak of the curve, indicating that the effort has apparently exceeded the level necessary to achieve AMSY. If effort is held at the 1976 to 1979 level over the next few years, one of two situations would be likely to occur. First, the catch could decrease, which would indicate that the stock of yellowfin probably changes in response to fishing as predicted by the production model. Second, the catch could remain approximately constant or even increase. If the latter occurs, it could indicate that the model may not be appropriate. This can be determined only by continuation of the Commission's experimental overfishing program.

Tagging experiments have indicated that the rate of mixing of yellowfin between the CYRA and outside area is low, so that to date, yellowfin of the outside area have been considered separately from those of the CYRA. Catch-and-effort data from outside the CYRA (Figure 6) indicate that catch has remained proportional to effort. No production models, however, have been fitted to these data. If the logistic model was applicable, the data would appear to indicate that the fishery is operating on the left-hand or underfishing side of the equilibrium production curve. This suggests that there is no biological reason for imposing limits on the yellowfin catch or the intensity of fishing outside the CYRA.

III.B.3. Results of Yield-per-Recruit Analysis

Estimated relationships among size at entry, fishing effort, and yield-per-recruit are shown in Figures 7A, B and C. Results of the yield-per-recruit analysis suggest that with the given fishing patterns (multiplier = 1.0), increasing size-at-entry would increase yield-per-

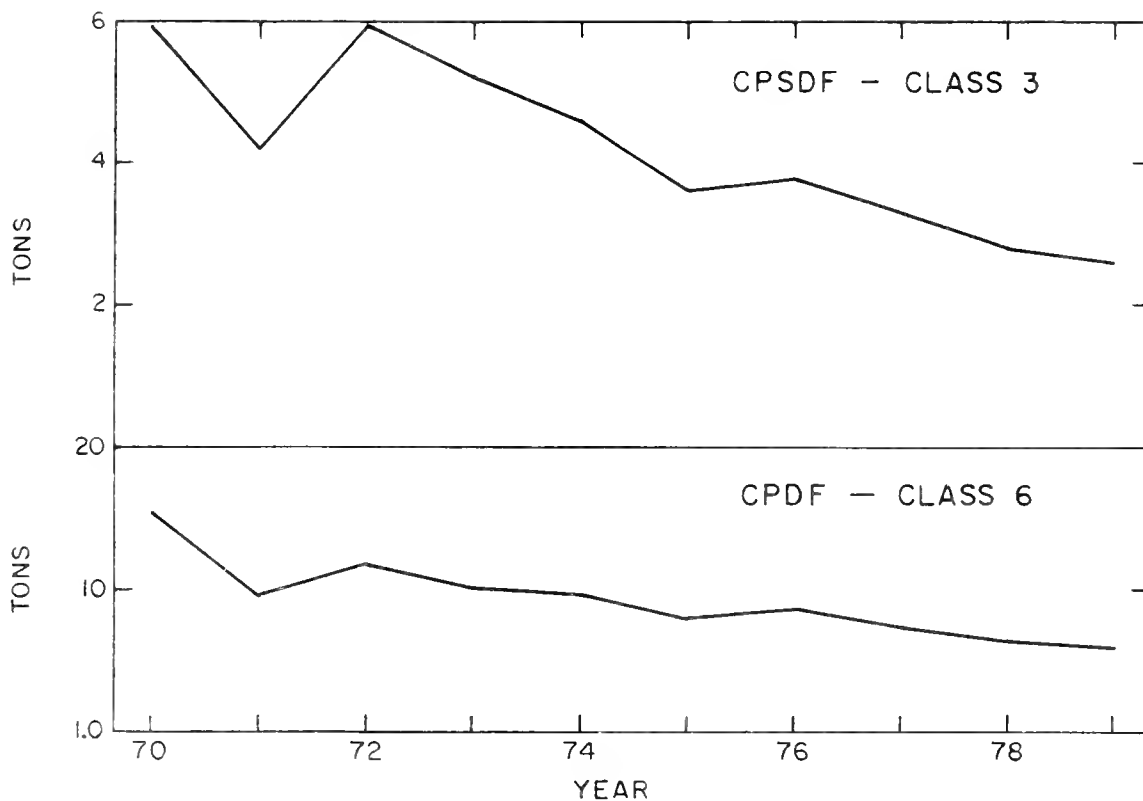

Figure 4. Annual catch-per-standard-days-fishing in Class-3 and catch-per-days-fishing in Class-6 purse seine units for unregulated fishing in the CYRA, 1970 to 1979.

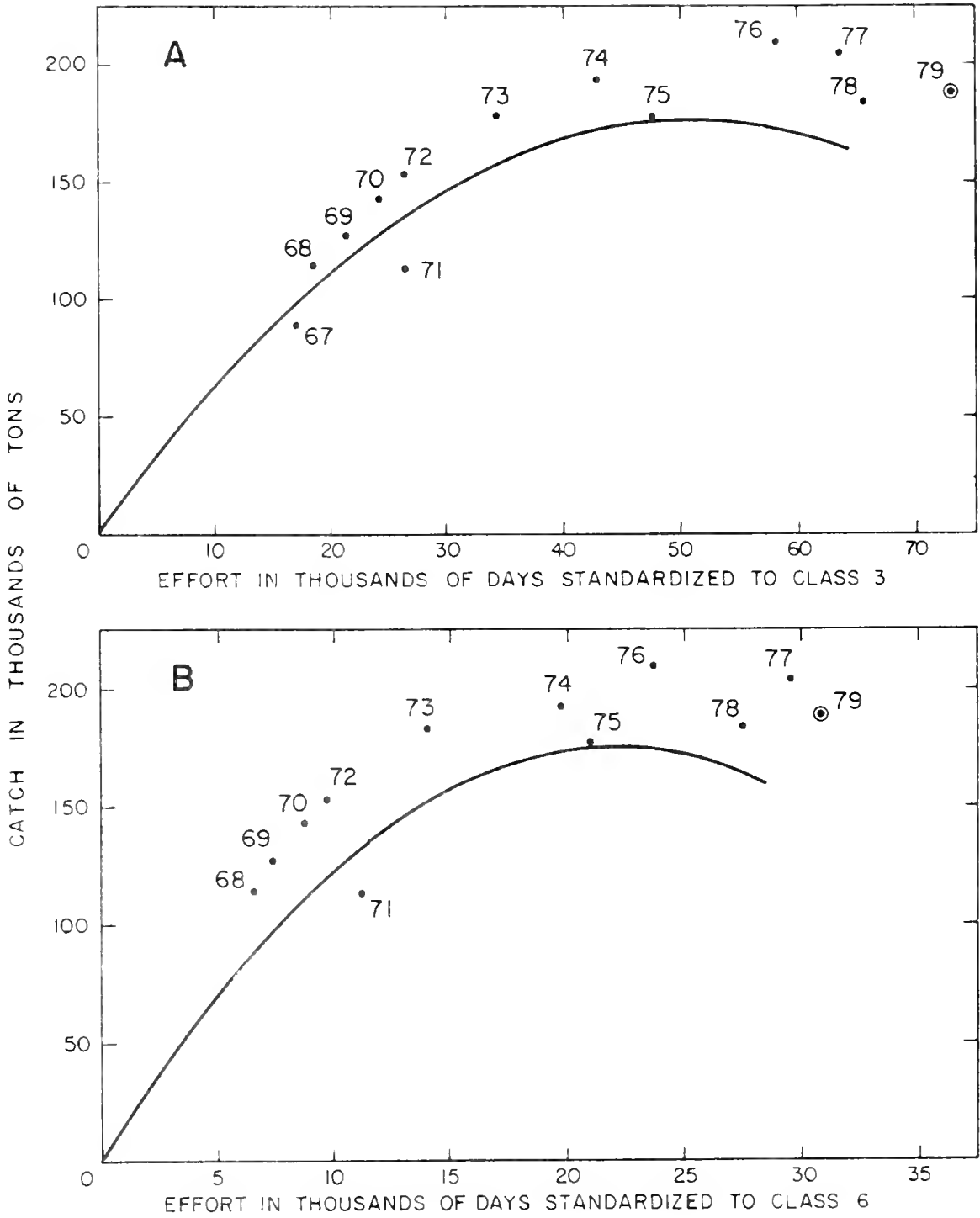

Figure 5. a) Equilibrium catch curve for the yellowfin tuna fishery inside the CYRA, 1967 to 1979. Effort in days fishing is standardized to Class 3 purse seiners.

b) Equilibrium catch curve for the yellowfin tuna fishery inside the CYRA, 1968 to 1979. Effort in days fishing is standardized to Class-6 purse seiners.

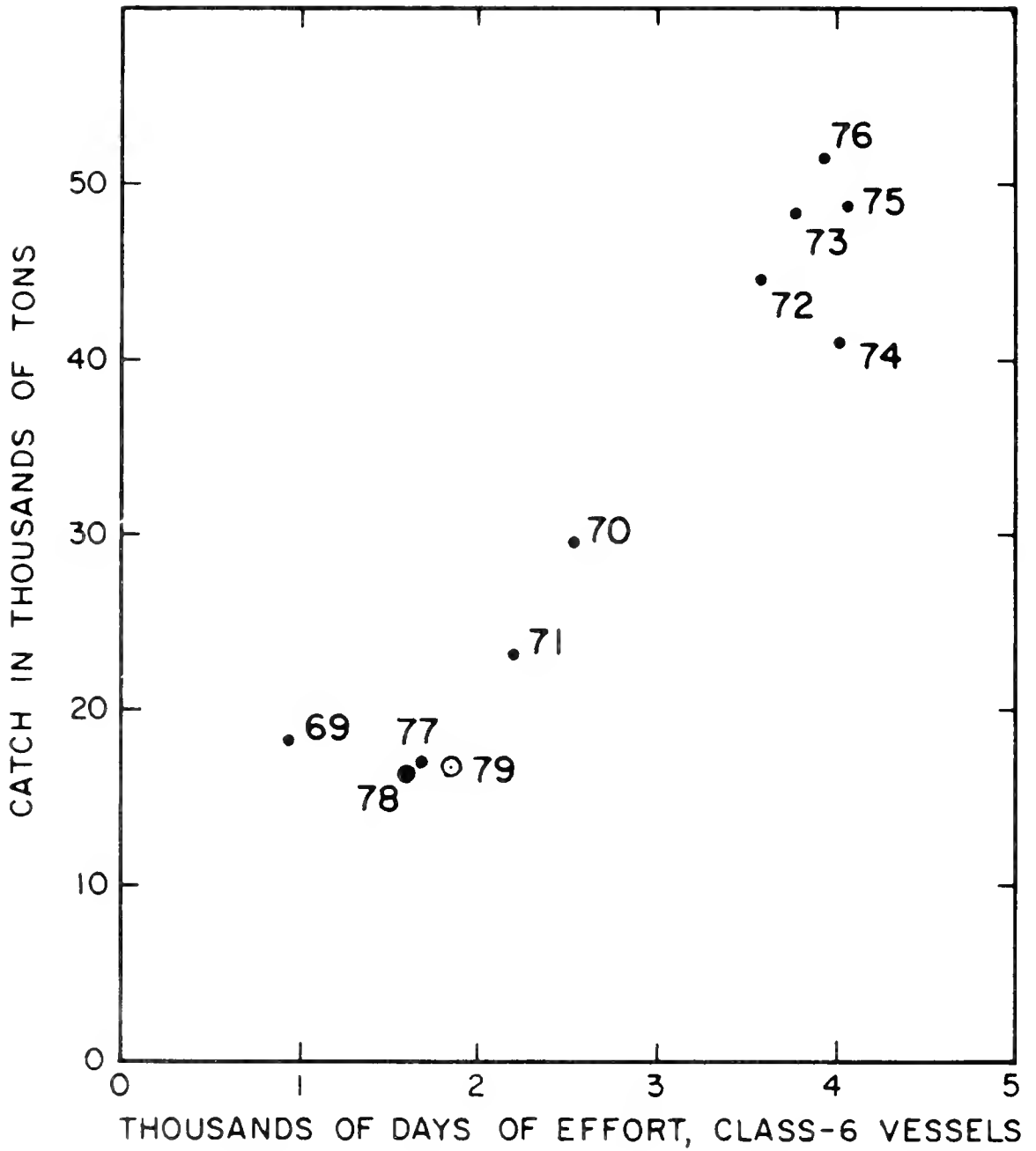

Figure 6. Relationship between catch and effort for yellowfin tuna in the area outside the CYRA, 1969 to 1979.

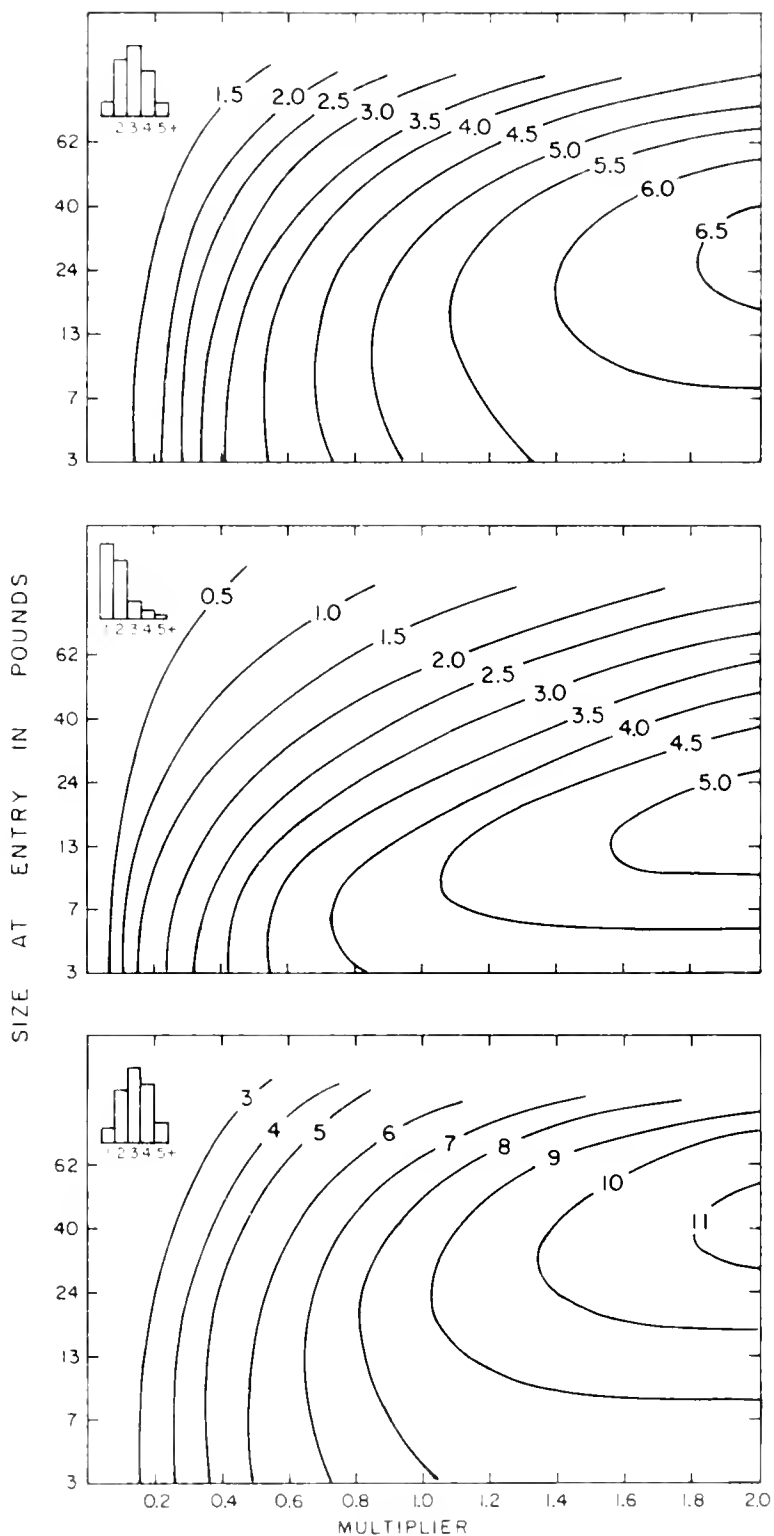

Figure 7. Yield-per-recruit isopleths for yellowfin tuna inside the CYRA; a) based on the age structure of the catch during the period 1968 to 1972 and natural mortality rate $M=0.8$, b) based on the age structure during the period 1973 to 1978 and $M=0.8$, c) based on the age structure during the period 1968 to

recruit. Given a 3-lb size-at-entry, increasing effort would not substantially increase yield-per-recruit in each of the cases presented.

III.B.4. Results of Spawner/Recruitment Analysis

Large catches of 1 year-old yellowfin were taken from the CYRA in 1978 and 1979. This raises questions as to whether these relatively greater catches of young fish were due to increased recruitment, increased vulnerability of small fish resulting from average recruitment, a shift of effort to areas where small fish are more abundant, a shift in the population structure away from large fish, or some combination of these. If the first case is true, large catches could be expected in subsequent years when the fish from the large recruitment become available as medium- and large-sized fish. However, in the second and third cases, the opposite would be true due to a scarcity of medium- and large-sized fish after the small ones had been heavily exploited. In 1979 the fish recruited in 1978 appear to have contributed heavily to the fishery as 2 year-olds, suggesting above-average recruitment in 1978. In general, the data suggest that there has been an increased dependency of the fishery upon 1 year-old fish in recent years.

III.B.5. Results of Other Analyses/Simulations

Cohort analysis was used to estimate the numbers and weights of fish of various cohorts at the time of recruitment and at various intervals thereafter.

During 1968 to 1971 the total CYRA yellowfin biomass averaged about 319,000 mt and was comprised of a large proportion of older fish; this resulted from above-average 1966 and 1967 recruitments which were lightly exploited as juveniles (Figure 8). Below-average recruitment, together with increasing rates of exploitation during 1969 to 1972, led to a decline in the biomass of both young and old fish during 1972 and 1973. The lower biomass of older fish persisted through 1974, while the abundance of smaller fish began to increase due to an extremely large 1974 year-class. The 1974 year-class accounted for most of the increase in biomass of large fish late in 1975, during 1976, and into early 1977. The largest catch of yellowfin in the history of the eastern Pacific fishery was made during 1976. However, poor recruitment in 1976 and 1977, coupled with heavy exploitation of young fish since 1973, has resulted in the biomass of both young and old fish decreasing to the lowest level yet observed in the fishery. Although recruitment in 1978 was high (exceeded only by that of 1974), the 1978 year-class is not expected to contribute significantly to the fishery in 1980 and 1981 because so many individuals were captured as 1 and 2 year-olds. Preliminary estimates of the 1979 recruitment appear to be slightly lower than average.

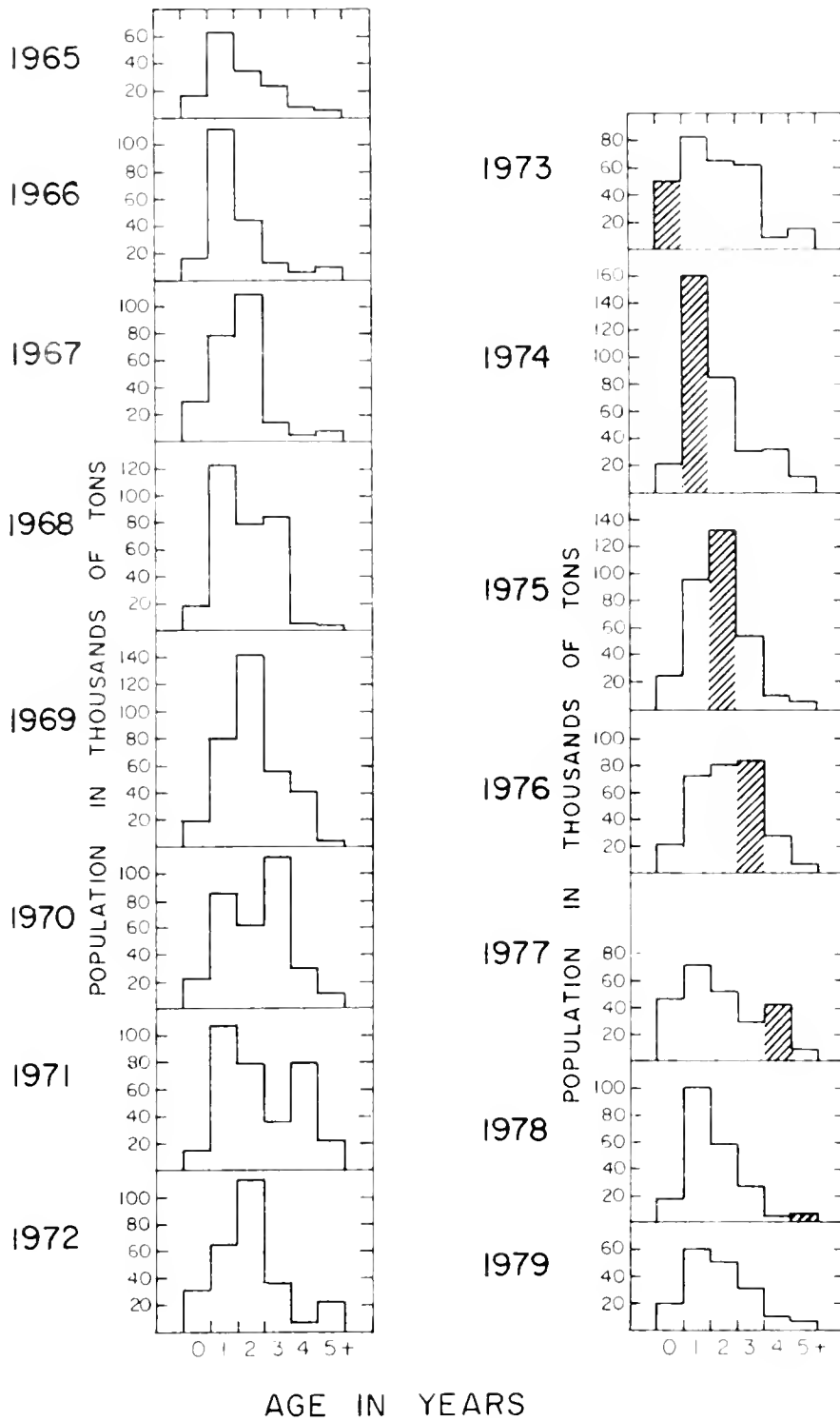

Figure 8. Annual biomass estimates of yellowfin in the CYRA by age groups, 1965 to 1979.

III.C. Current Evaluation of Stocks and the Fishery

Based upon the production model analyses, it does not appear that increasing the effort on yellowfin within the CYRA will result in an increased yield. Depending upon the shape of the right hand side of the production curve, the catch can remain constant as effort increases or it can decline.

If CPSDF indices accurately reflect trends in yellowfin abundance, the population is currently at its lowest known level. It appears then that caution should be exercised in increasing the catch beyond the current best estimate of AMSY (159,000 mt).

In 1978 concern was expressed over the changing size composition of the CYRA yellowfin catch. It was noted that the recruitment of yellowfin is variable and that this variability, coupled with a shift of fishing mortality to the younger age groups, could lead to reduced catches of yellowfin in years of below-average recruitment.

If the number of larger fish in the ETP yellowfin population is to be increased, the fishery should be less dependent upon 1 year-old fish. As pointed out in the 1978 IATTC Annual Report, however, while protecting the young yellowfin would eventually bring substantial benefits to the fishery, this reduction in catch would be difficult to accomplish.

IV. STATUS OF CURRENT RESEARCH NEEDS AND EFFORTS

IV.A. Major Research Problems

The immediate biological problem facing the ETP yellowfin fishery concerns its growing dependence on 1 year-old fish. The increase in 1 year-old catches and concurrent decreases in yield-per-recruit results in a diminished potential yield and dependence of fishing success on recruit class strength. In addition, heavy fishing on a succession of poor recruit classes could reduce the adult population to a level such that recruitment failure may occur. Analyses of management measures designed to reverse this trend, such as time/area/gear closures, could be undertaken to assess not only the biological impact on the resource itself, but also the socio-economic impacts on the resource constituency.

The failure to implement a yellowfin conservation program in the ETP for 1980 strongly suggests that the biological condition of the fishery cannot be managed unless there is some acceptable mechanism for resolving conflicts related to the distribution of resource-related benefits among active and potential participants in the fishery. Evaluation of potential management actions should therefore be made with regard to the diversity in resource strengths, fishery interests, and national priorities of those affected by such actions.

IV.B. Current Research Efforts

There are currently no U.S. research efforts directed specifically toward the conservation and/or exploitation of yellowfin tuna resources in the ETP per se. What research there is concerns itself mainly with tuna/porpoise-related issues.

The IATTC is the organization primarily responsible for conducting research on the yellowfin tuna industry. Its studies on the ETP yellowfin fishery and resource required a scientific and support staff of 50 in 1979. The U.S. contributed \$1,607,200 of the IATTC's \$2,746,339 operating budget.

IV.C. Future Research Needs

1) Effort standardization needs to be investigated in the multispecies U.S. tuna fishery.

2) An ETP tuna fishery economic data base needs to be established.

IV.C.1. Suggested Approach and Methods

1) The Southwest Fisheries Center (SWFC) currently conducts no research on ETP yellowfin tuna, but it might be able to utilize data contained in its tuna/porpoise data base to confirm results of certain IATTC analyses. These data could also be used to investigate effort standardization in the U.S. tuna fishery.

2) An ETP tuna fishery economic data base could be established on an individual fleet basis in order to analyze the economic impacts of proposed management policies. To supplement the economic data, it will be necessary to acquire some extensive information on vessel/fleet operations in the ETP (i.e., days at sea, days fished, species catch compositions, areas exploited, and fishing techniques) from the vessels/fleets for which economic data are obtained. Other considerations which will help complete the economic picture include disposition of catches, costs of processing, inventory-holding and distribution of final products, economic feasibility of plant relocations, consumer demand characteristics, and international trade in ETP tuna and tuna products.

IV.D. Status of SWFC Data Base

The SWFC does not collect data on the ETP yellowfin fishery except those pertaining to the U.S. tuna/porpoise observer program. Eastern tropical Pacific yellowfin tuna effort and biological data are collected and archived by the IATTC.

STATUS REPORT: EASTERN TROPICAL PACIFIC SKIPJACK TUNA

by

Ronald G. Rinaldo

Southwest Fisheries Center
Oceanic Fisheries Resources Division
La Jolla, California

ABSTRACT

The stock structure of skipjack tuna in the Pacific Ocean is poorly understood. In the eastern Pacific fishery for skipjack tuna, there appears to be no significant relationship between effort and apparent abundance. Yield-per-recruit analysis on a partial stock indicates a maximum yield-per-recruit could be obtained at a greater fishing effort than is currently applied. According to the IATTC, the fishery for skipjack tuna in the eastern Pacific does not appear to affect stock abundance, and there is no need to restrict the catch.

I. DESCRIPTION OF THE FISHERY

More skipjack tuna are harvested on a world basis than any other tuna species; most of these are taken from the Pacific Ocean. The estimated annual average catch in the western Pacific Ocean from 1965 to 1972 was 220,000 metric tons (mt); 80,000 mt was the average for the eastern Pacific. Estimates from 1973 to 1978 indicate that catches for the western Pacific (420,000 mt) and the eastern Pacific (108,000 mt) had increased greatly.

The skipjack tuna fishery in the eastern Pacific is an outgrowth of the California albacore fishery. It is a multispecies fishery where yellowfin and skipjack tuna comprise the major species harvested.

I.A. History of the Fishery

The industry originated in California near the turn of the century; the initial target was albacore, which was first successfully canned in 1903. The fishery for yellowfin and skipjack tunas developed when the California albacore fishery could not satisfy the demands of the tuna canners. The high-seas tuna fishery expanded rapidly as abundant yellowfin and skipjack tunas were found in the warmer waters of the eastern Pacific; by 1930 the fishery had expanded south to the Central American coast and outlying islands. In 1979 the fishery extended from about 33° N to 19° S latitude and from the North and South American coast to 150° W. longitude. Substantial fisheries occur in the northeastern Pacific Ocean near Baja California, the Revillagigedo Islands, and Clipperton Island, and in the southeastern Pacific Ocean near Central America, northern South America, Cocos Island-Brito Bank, and the Galapagos Islands.

In the eastern Pacific Ocean, about 80% to 95% of the catch is taken by purse seiners. A few baitboats remain in the fishery, catching most of the remaining 5% to 20%. Only small amounts of skipjack are caught by longliners, as incidental catch.

In 1979 vessels from Bermuda, Canada, Colombia, Congo, Cost Rica, Ecuador, Japan, Korea, Mexico, Netherlands, New Zealand, Nicaragua, Panama, Peru, Senegal, Spain, United States, and Venezuela engaged in the eastern Pacific tuna fishery (Table 1). Ten of the 18 countries made significant catches of skipjack tuna in the Inter-American Tropical Tuna Commission (IATTC) Yellowfin Regulatory Area (CYRA). The vessels of three countries caught over 70% of the skipjack: United States, 53.8%; Ecuador, 13.2%; and Netherlands, 6.9% (Figure 1).

Table 1. Catches of skipjack by flag of vessel in the Inter-American Tropical Tuna Commission's Yellowfin Regulatory Area (CYRA) by vessels of all flags west of the CYRA and east of 150° W, and total catches for the eastern Pacific east of 150° W (in thousands of metric tons). The 1979 data are preliminary.

Year	CYRA						Total	West of CYRA east of 150°W	Total eastern Pac
	U.S.A.	Ecuador	Panama	Mexico	Peru	Others ^a			
1961	51.3	11.6	0.0	1.0	4.4	0.1	68.4	0.0	68.4
1962	55.7	10.2	1.0	1.0	2.7	0.3	70.9	0.0	70.9
1963	73.8	12.6	2.8	1.3	4.4	0.5	95.4	0.0	95.4
1964	41.8	9.3	0.4	1.4	1.5	0.2	54.6	0.0	54.6
1965	58.1	14.9	0.0	1.6	0.9	1.2	76.7	0.0	76.7
1966	44.1	10.5	0.2	1.4	0.1	2.3	58.6	0.0	58.6
1967	93.6	17.3	0.4	3.9	0.2	4.8	120.2	0.0	120.2
1968	50.8	12.9	1.0	2.5	0.0	3.7	70.9	0.0	70.9
1969	34.2	15.6	3.4	1.6	0.0	3.4	58.2	0.9	59.1
1970	33.4	8.8	2.1	3.4	0.6	1.8	50.1	5.9	56.0
1971	76.4	11.9	4.3	4.1	0.2	7.0	103.9	0.9	104.8
1972	21.0	4.5	0.8	2.4	0.2	3.3	32.2	1.1	33.3
1973	26.0	4.4	2.3	2.3	1.9	5.7	42.6	1.3	43.9
1974	46.0	7.8	3.9	4.5	1.2	12.8	76.2	2.5	78.7
1975	64.3	17.0	12.8	6.6	3.2	18.9	122.8	1.9	124.7
1976	86.7	6.2	4.5	7.1	2.8	19.5	126.8	1.0	127.8
1977	48.6	10.0	5.1	3.8	2.6	14.0	84.1	2.6	86.7
1978	97.7	11.8	8.2	4.7	3.1	42.0	167.5	2.8	170.3
1979	69.8	17.4	5.6	4.9	1.0	30.3	129.0	2.8	131.8

a - The catches of vessels that belonged to only one fishing company in one or more years have been grouped to preserve the confidentiality of the records. These include the catches of vessels of Bermuda, Canada, Chile, Colombia, Congo, Costa Rica, France, Korea, Netherlands, New Zealand, Nicaragua, Senegal, Spain, and Venezuela.

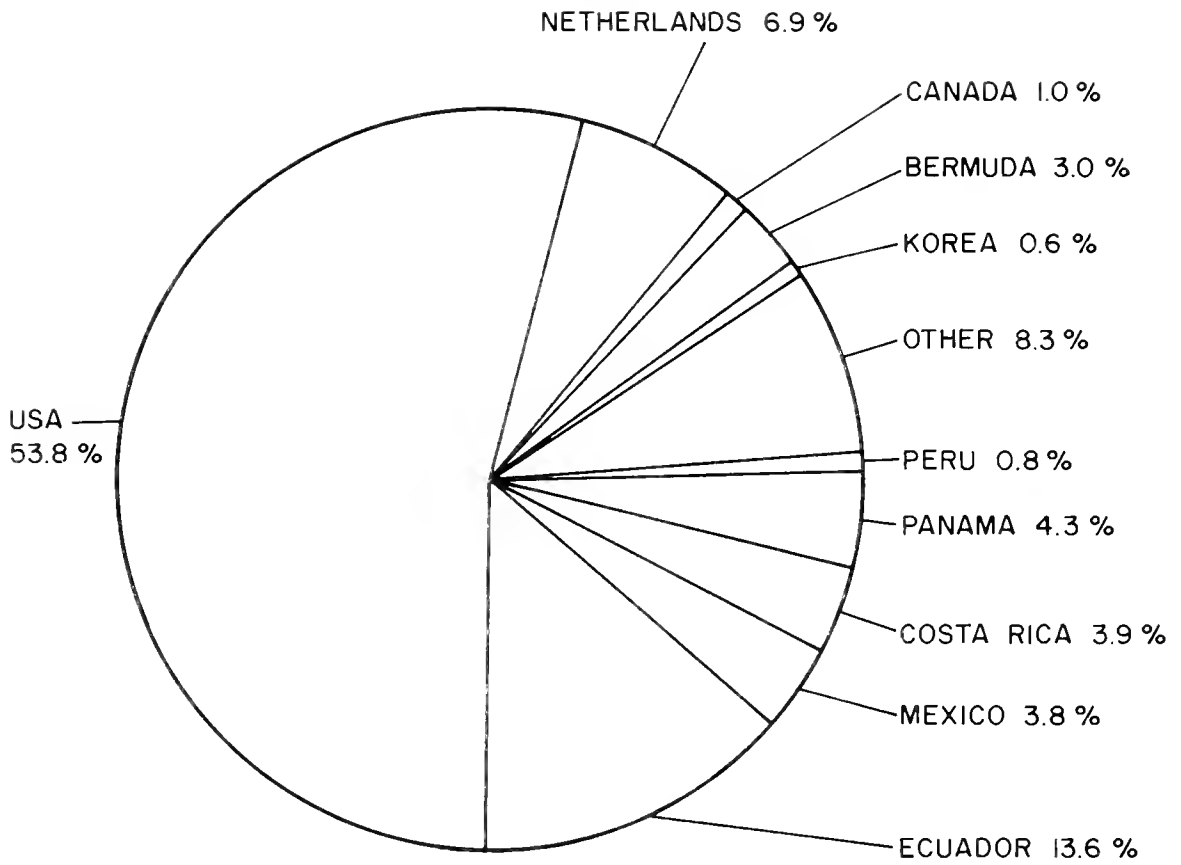

Figure 1. 1979 skipjack tuna catch (129,400 mt), by country, in the CYRA.

I.B. Trends in Catch and Effort

Annual catches of skipjack by the eastern Pacific tuna fleet fluctuate greatly, and there are no obvious trends. During the 1961 to 1979 period, the catches ranged from 33,300 mt in 1972 to 170,300 mt in 1978 (Table 1). The mean annual catch during the 1976 to 1979 period was 129,200 mt: an increase of 76% over the mean catch for the previous 12 years.

The size composition of skipjack tuna samples taken in the IATTC's yellowfin regulatory area during 1967 through 1980 is shown in Figure 2. Differences among years are apparent; the incidence of fish larger than 55 cm was highest in 1971-73 and lowest in 1978-79.

In the eastern Pacific most of the skipjack is caught within 600 nautical miles of land, off the coasts of Central America and northern South America (Figure 3). During the 1960's much of the skipjack was caught in waters off Baja California and Ecuador, and in the Gulf of Guayaquil; in the 1970's the largest catches were usually made offshore between 5° and 15° N latitude and in the Panama Bight. During the past few years, however, the center of abundance in the southern area seems to have shifted to waters off Colombia and Central America. During 1975 to 1979, an average of 73% of the skipjack caught east of 150° W longitude were taken within 200 nautical miles of land. Most of the catch comes from the area south of 15° N latitude (Figure 4).

In general there is a little seasonal variation in the skipjack fisheries in the equatorial areas. The greater the distance from the equator, the more the catches peak in the summer months. In the Panama Bight skipjack catches are low from August to March and peak from April to July. Near Ecuador they are low from January to April, with a major peak from May to July and a minor one in October and November.

The numbers of vessels fishing for tropical tunas in the eastern Pacific since 1961 and their total carrying capacity are given in Table 2. The number of larger purse seiners (> 401 short tons of carrying capacity) increased gradually from 9 in 1961 to 24 in 1967; it then increased rapidly, reaching 158 in 1976, and remained near this level through 1979. The number of baitboats remained fairly constant, between 91 and 116, from 1961 to 1976, but decreased rapidly to 45 by 1979. The total carrying capacity of all gears in the fleet increased from 36,600 mt in 1961 to 169,000 mt in 1979. The 1979 fleet consisted of 97.7% purse seiners, 2.1% baitboats, 0.2% bolicheras (small purse seiners with < 50 short tons of carrying capacity), and less than 0.1% jigboats in terms of capacity; in terms of numbers, 80.7% were purse seiners, 14.0% baitboats, 4.4% bolicheras, and 0.9% jigboats.

In the eastern Pacific the logged effort by purse seiners remained fairly constant between 1961 and 1969, ranging from 14,800 to 19,700 days of fishing, standardized to Class-3 vessels (101-200 short tons of carrying

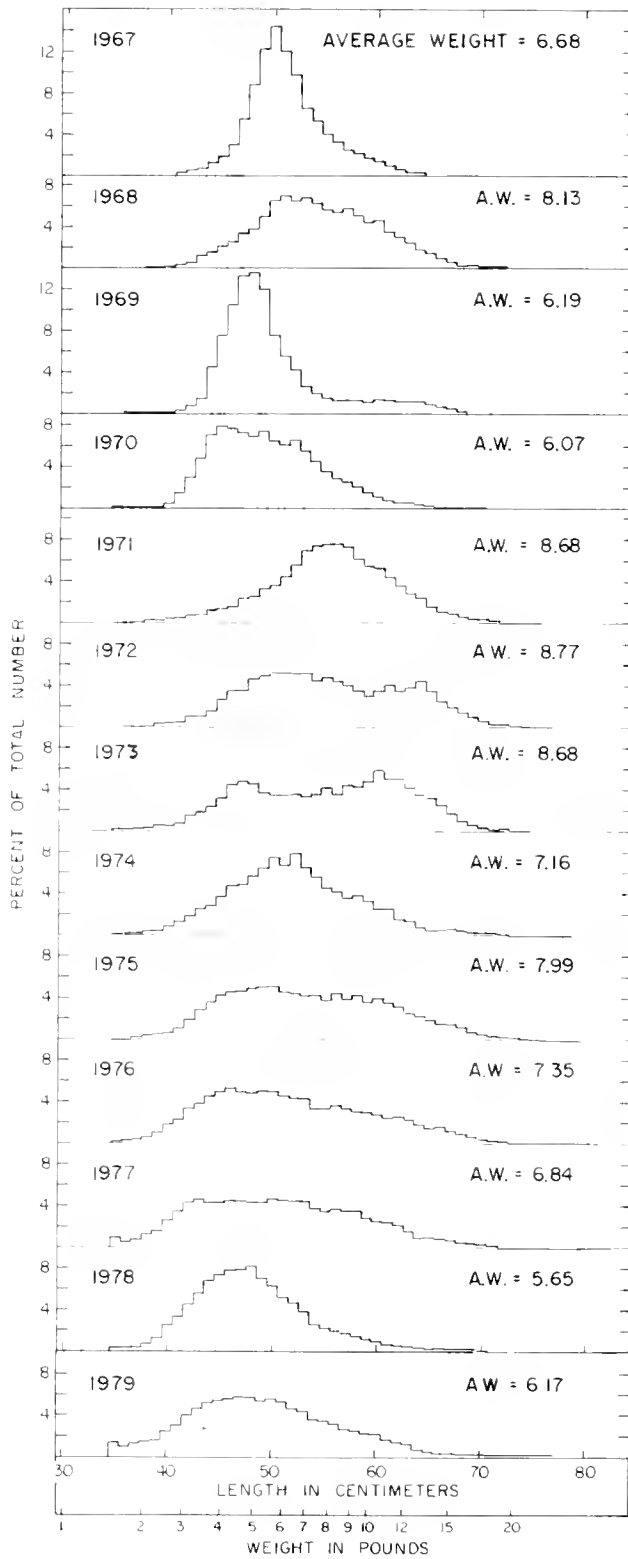

Figure 2. Length frequencies of skipjack caught in the CYRA, 1967 to 1979.

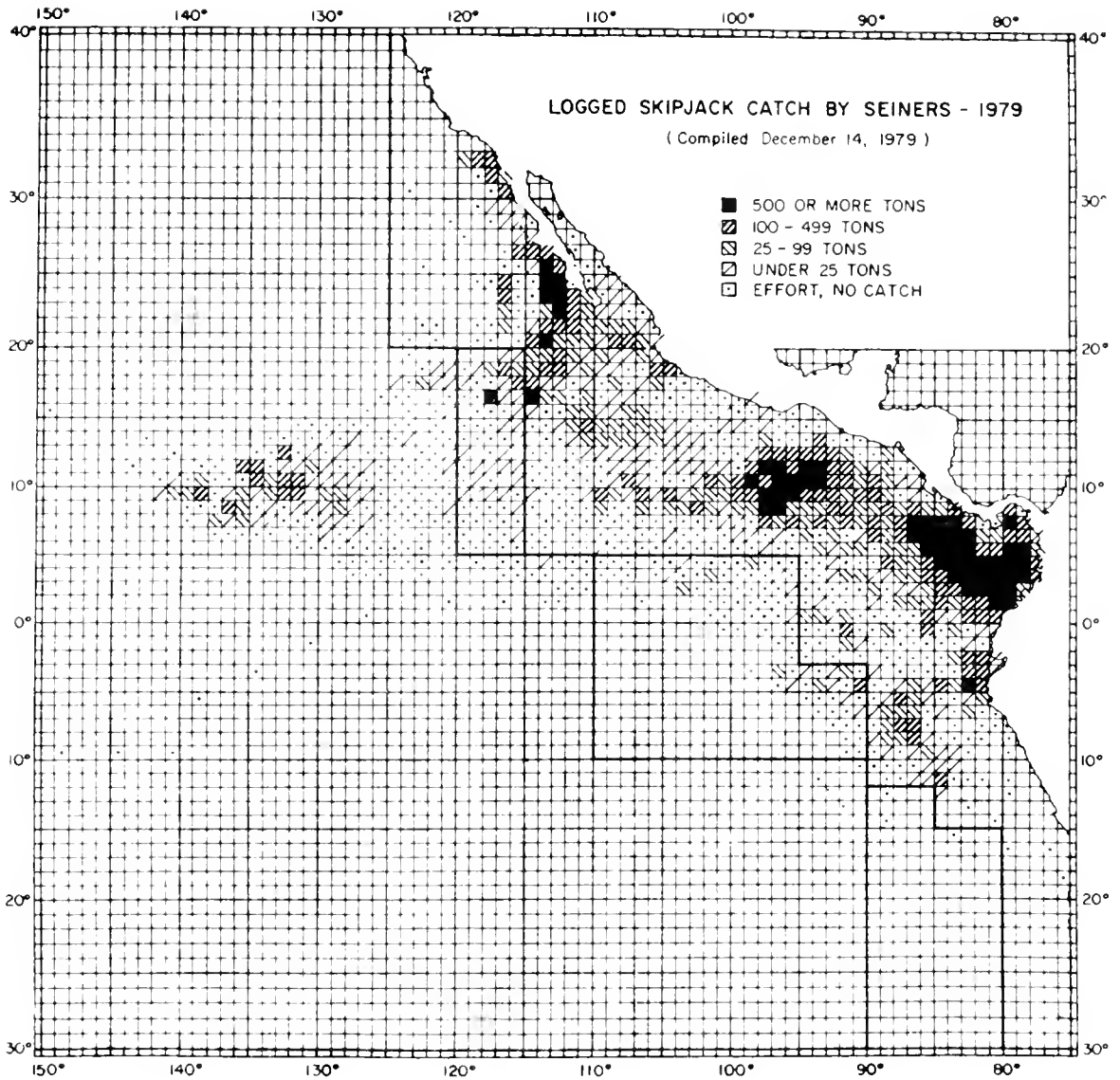

Figure 3. Catches of skipjack in the eastern Pacific Ocean in 1979 by 1° areas for all trips for which usable logbook data were obtained.

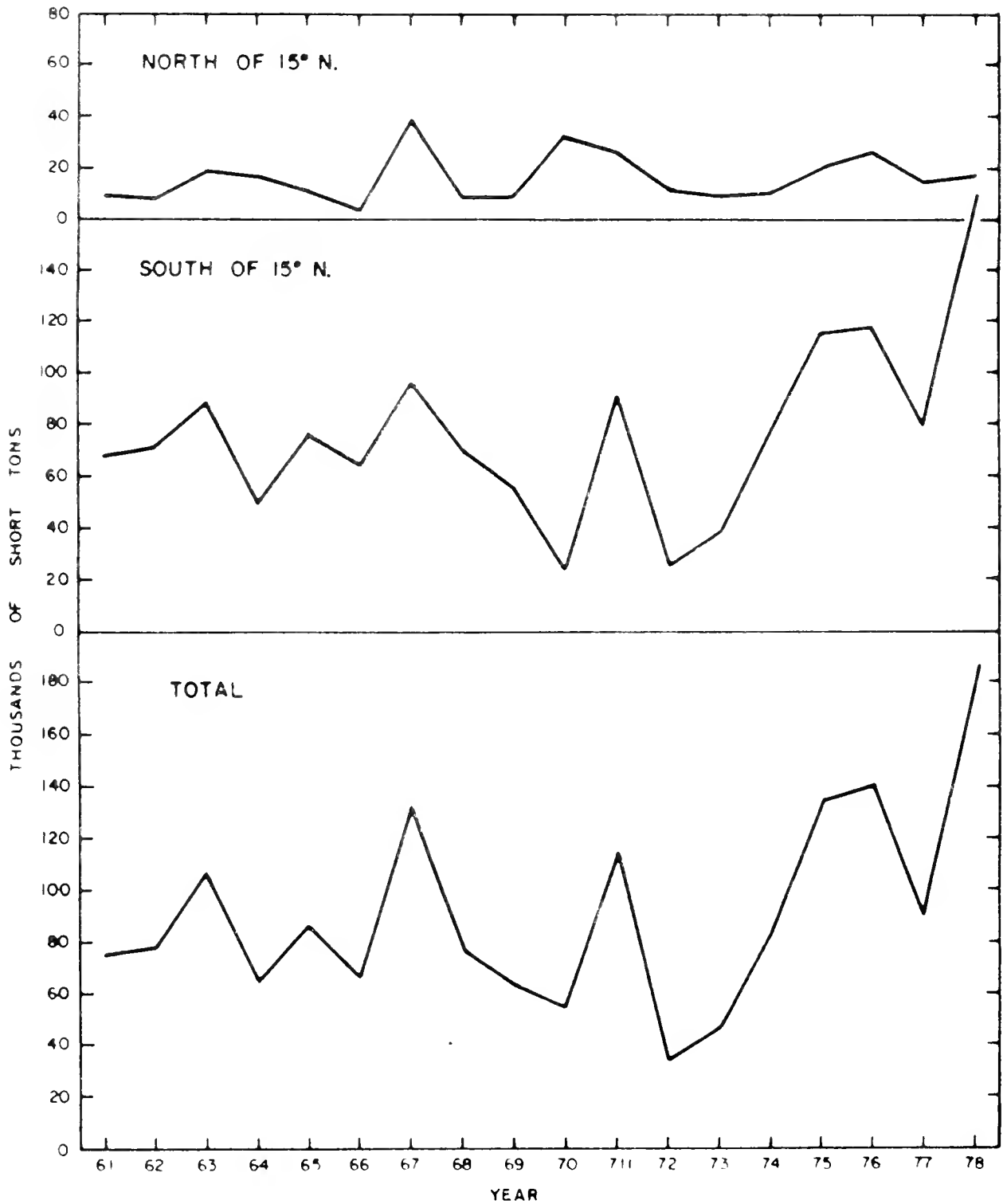

Figure 4. Estimated CYRA catches of skipjack north and south of 15° N, 1961-1978.

TABLE 2. Numbers of vessels by gear fishing for tropical tunas in the eastern Pacific Ocean, and total carrying capacity for 1961 to 1979. Purse seiners are tabulated according to carrying capacity: Classes 1-5, <401 short tons; Class 6, 401 or more short tons.

Year	Purse seiners		Baitboats	Bolicheras	Jug-boats	Total	Capacity	
	Classes 1-5	Class 6					short tons	metric tons
1961	115	9	93	15	0	232	40,399	36,649
1962	117	12	91	27	0	247	41,385	37,544
1963	125	18	113	18	4	278	46,813	42,468
1964	116	20	104	18	0	258	46,216	41,926
1965	124	22	112	17	7	282	48,712	44,191
1966	105	21	115	7	2	250	46,305	42,007
1967	99	24	113	8	0	244	46,488	42,173
1968	102	39	116	7	1	265	58,756	53,303
1969	100	50	105	6	3	264	63,656	57,748
1970	97	65	108	6	9	285	73,822	66,970
1971	91	84	109	6	67	357	95,324	86,477
1972	87	103	108	4	76	378	120,887	109,657
1973	82	119	105	22	29	357	138,287	125,452
1974	82	131	111	4	7	336a	152,581	138,419
1975	78	146	101	4	6	335	169,420	153,695
1976	93	158	100	4	36	392b	184,872	167,713
1977	85	160	78	3	27	354	183,082	166,089
1978	105	156	65	8	33	367	186,791	169,454
1979	102	158	45	14	3	322	187,334	169,947

a - includes one longliner; b - includes one vessel of unknown gear

capacity). The logged effort began increasing in 1970, reaching 41,400 days in 1976 and 41,200 days in 1978, then declined to 39,200 days in 1979. The actual effort is considerably greater than the logged effort. During the past 10 years the actual skipjack effort has been estimated to average 90% greater than the logged effort. No trend is apparent in the logged effort.

I.C. Value of Catch

Ex-vessel values for major fishing countries other than the U.S. in the ETP are unavailable. U.S. ex-vessel prices paid for skipjack tuna in 1979 were approximately \$1,000/short ton for skipjack tuna weighing less than 4 pounds and \$1,100/short ton for skipjack tuna greater than 4 pounds.

Based on the 1979 catch of skipjack tuna in the CYRA of 142,600 short tons, the value of the 1979 skipjack tuna catch in the CYRA was approximately \$149,730,000. Based on the 1979 catch of skipjack tuna from outside the CYRA and the average 1979 U.S. ex-vessel price, the value of the skipjack tuna catch from outside the CYRA (3,000 short tons) was approximately \$3,150,000. The total 1979 eastern Pacific catch of skipjack tuna was worth approximately \$152,880,000.

I.D. Current Management of the Fishery

There are currently no regulations for skipjack in the Pacific Ocean. The State of California had required a minimum weight of 4 pounds (1.8 kg) since 1939, but this was repealed in 1975.

II. NATURE AND SIGNIFICANCE OF U.S. AND FOREIGN PARTICIPATION IN THE FISHERY

The fishery for tropical tunas in the eastern tropical Pacific was started by American fishermen, and the skipjack and yellowfin tuna resources continue to be a U.S. concern. Areas of particular interest include: the catch of the domestic fleet, imported catch, and processing and consumption in the United States.

United States tuna cannery receipts for tunas during 1978 were 581,418 short tons, whole weight. Approximately 35% of the raw cannery product (catch plus imports) was skipjack tuna which originated in the Pacific. In addition, the Pacific skipjack tuna catch comprised 42% of the total 1978 U.S. tuna catch available on the imports from the eastern Pacific. Imports for 1978 were dominated by skipjack tuna (56%) and yellowfin tuna (22%).

In 1979, American flag vessels caught 76,707 mt or 53.8% of the total catch of skipjack tuna in the eastern Pacific. The carrying capacity of

American flag vessels fishing in the eastern Pacific in 1979 totaled 110,919 mt (61% of total carrying capacity of all flag vessels), made up of approximately 98% seiners, 2% baitboats, and < 1% jigboats by capacity. By number, the fleet was composed of 138 purse seiners, 28 baitboats and 3 jigboats.

The U.S. fleet usually fishes the CYRA for yellowfin and skipjack tunas from January to the closure of the CYRA. When the CYRA closes to yellowfin fishing, the majority of the larger purse seiners move either to areas outside the CYRA or to the Atlantic Ocean. Smaller purse seiners, baitboats, and jigboats continue to fish the CYRA for skipjack tuna and species of tuna (bluefin or albacore) other than yellowfin.

The U.S. commitment to the conservation of skipjack and yellowfin tuna stocks in the eastern Pacific is indicated by its membership in the IATTC. The monetary commitment of the U.S to the IATTC was \$1,607,000 in 1979, or approximately 93% of the 1979 IATTC contributions (\$1.7 million) from member countries.

III. STATUS OF STOCKS

III.A. Stock Structure

Skipjack tuna are distributed across the Pacific in tropical and sub-tropical latitudes, usually in waters exceeding 20° C at the surface. They occur commonly from about 40° N to 40° S latitude in the western Pacific, and from about 30° N to 30° S in the eastern Pacific. Their distribution is probably influenced by the temperature of the prevailing currents, which are warm and poleward-flowing in the west, and cold and equator-ward in the east.

The population structure of skipjack in the Pacific Ocean is not well understood. One hypothesis proposes that all skipjack in the Pacific belong to one population that is spawned in the equatorial regions west of 140° W longitude, that the young fish migrate poleward into the fishing areas, and that the older fish return to the equatorial regions to spawn. Another more recent hypothesis suggests that there may be at least two subpopulations of skipjack in the Pacific Ocean: the western Pacific subpopulation, and the central and eastern Pacific subpopulation. Recent tagging studies conducted by the South Pacific Commission have shown extensive migrations of skipjack in the south and equatorial Pacific Ocean. When the analyses of these data are complete, the population structure of this species will probably be more clearly understood.

There appear to be two main groups of skipjack in the eastern Pacific: a northern group off the west coast of Baja California, in the Gulf of California, and around the Revillagigedo Islands; and a southern group from off Central America to off northern Chile. In most years skipjack are excluded from the southern coast of Mexico by a cell of warm

water in that area. There is little interchange of fish between the northern and southern areas, but considerable mixing of fish within the areas. Studies of the distribution of fish larvae, however, have shown that there is virtually no spawning of skipjack in the eastern Pacific (east of 130° W longitude). Skipjack apparently arrive in the eastern Pacific when they are about 1 to 1-1/2 years old and return to the central and central-western Pacific when they are about 2 to 2-1/2 years old. Evidence for the latter is provided by the fact that 25 skipjack tagged in the eastern Pacific have been recaptured near the Hawaiian and Line Islands and one other has been recaptured between the Marshall and Mariana Islands.

III.B. Stock Assessment and Fishery Evaluation

III.B.1. Trends in Catch-per-Unit-Effort

The first measure of apparent abundance for the skipjack fishery of the eastern Pacific was developed in 1956. The catches-per-day of fishing by baitboats of different carrying capacities were compared to obtain standardization factors among vessel size classes, and these were used to standardize the effort to that of a single size class. This method, modified for purse seiners, is still in use today: it is the logged catch divided by the logged effort standardized to Class-3 seiners (vessels of 101-200 short tons of carrying capacity). It is biased in that it includes effort on a combined resource which also includes yellowfin. This index of abundance for the 1960 to 1979 period reveals no apparent trend (Figure 5).

A method of eliminating some of the effort on yellowfin to obtain an index of abundance for skipjack in the eastern Pacific was described in IATTC's 1976 annual report. Twenty-two 5° areas where most of the skipjack have been caught were selected, but only data from area-quarter strata having > 100 standardized days of logged effort and > 200 short tons of logged skipjack caught were used. This eliminated an average of 43% of the effort while retaining 89% of the skipjack catch for purse seiners during the 1961 to 1979 period. The catch-per-unit-effort by purse seiners shows a downward trend in the area south of 5° N latitude, but no clear trends are apparent for the northern areas.

III.B.2. Results of Production Model Analysis

Attempts to fit the production model to eastern Pacific skipjack data have been unsuccessful. Plots of purse seine CPUE and effort in the CYRA, standardized to Class-3 units (vessels of 101 to 200 ton carrying capacity), are shown in Figures 6 and 7. Figure 6 includes all 5° areas of the CYRA, while Figure 7 includes only selected 5° areas where significant amounts of skipjack are caught.

The IATTC has suggested some possible reasons for the model not fitting. Tagging studies and larval surveys indicate the fishery

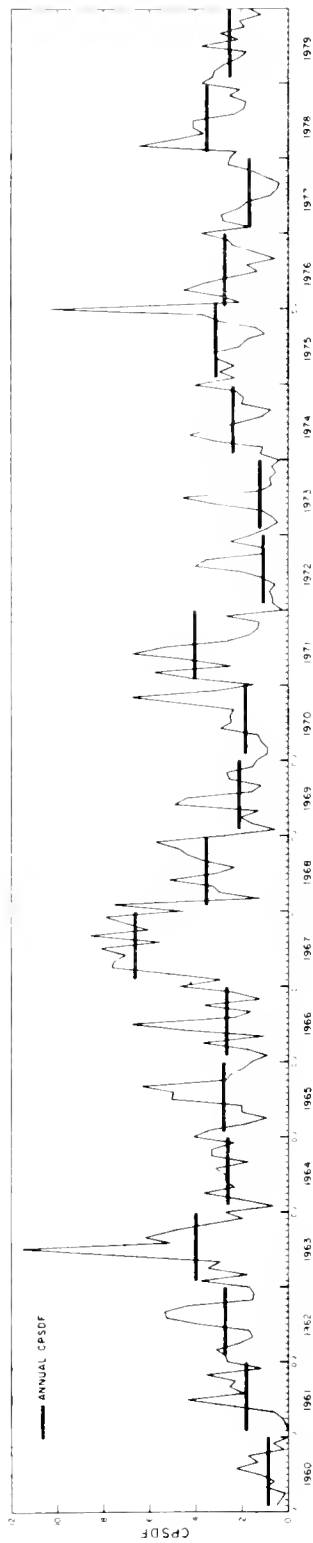

Figure 5. Catch per standard day's fishing for skipjack, in Class-3 purse-seine units, in the CYRA during 1960 to 1979. The values for 1979 are preliminary.

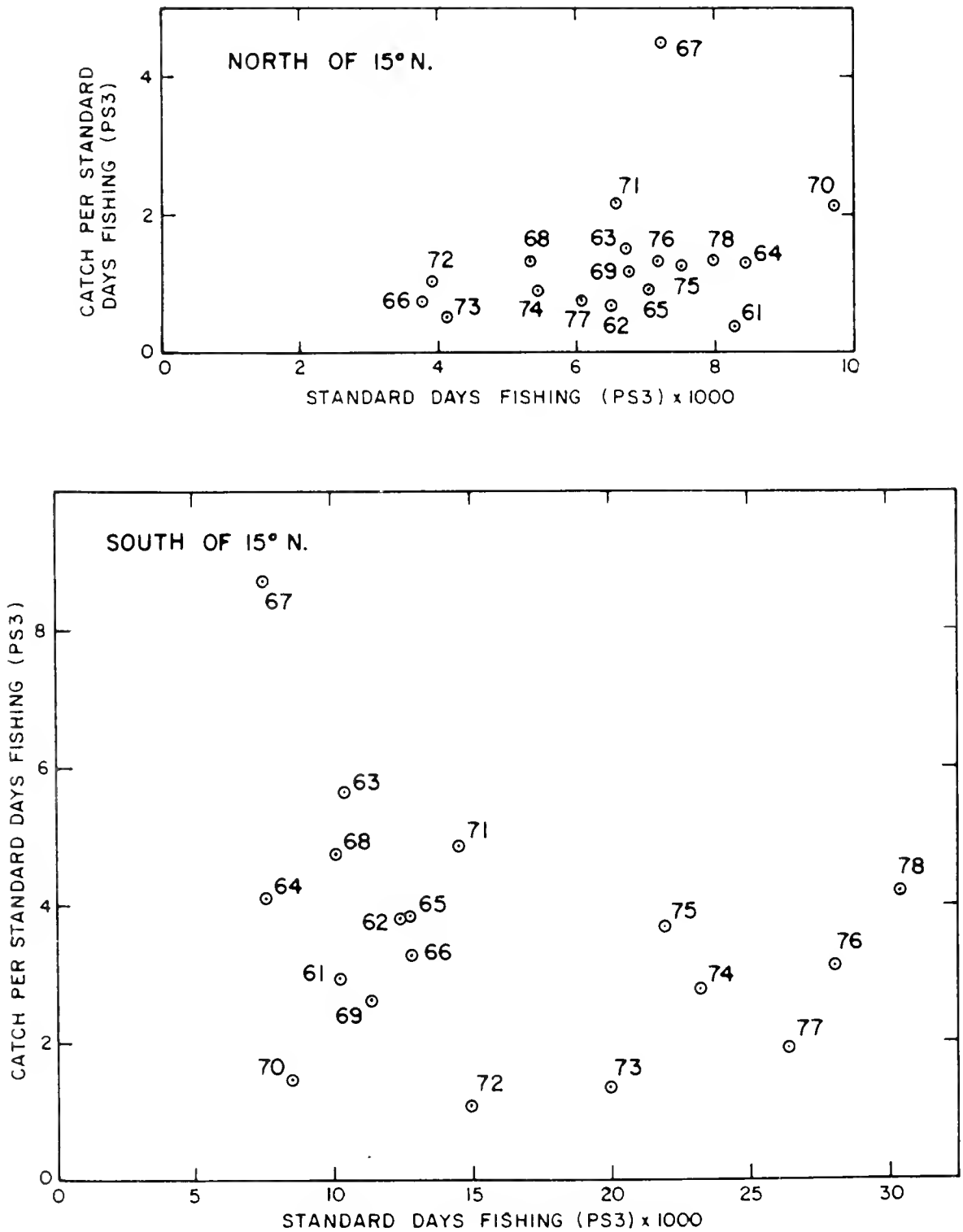

Figure 6. Relationships between CPUE and effort (unregulated and regulated) for skipjack in the CYRA north and south of 15° N, using data for all 5° areas, 1961 to 1978.

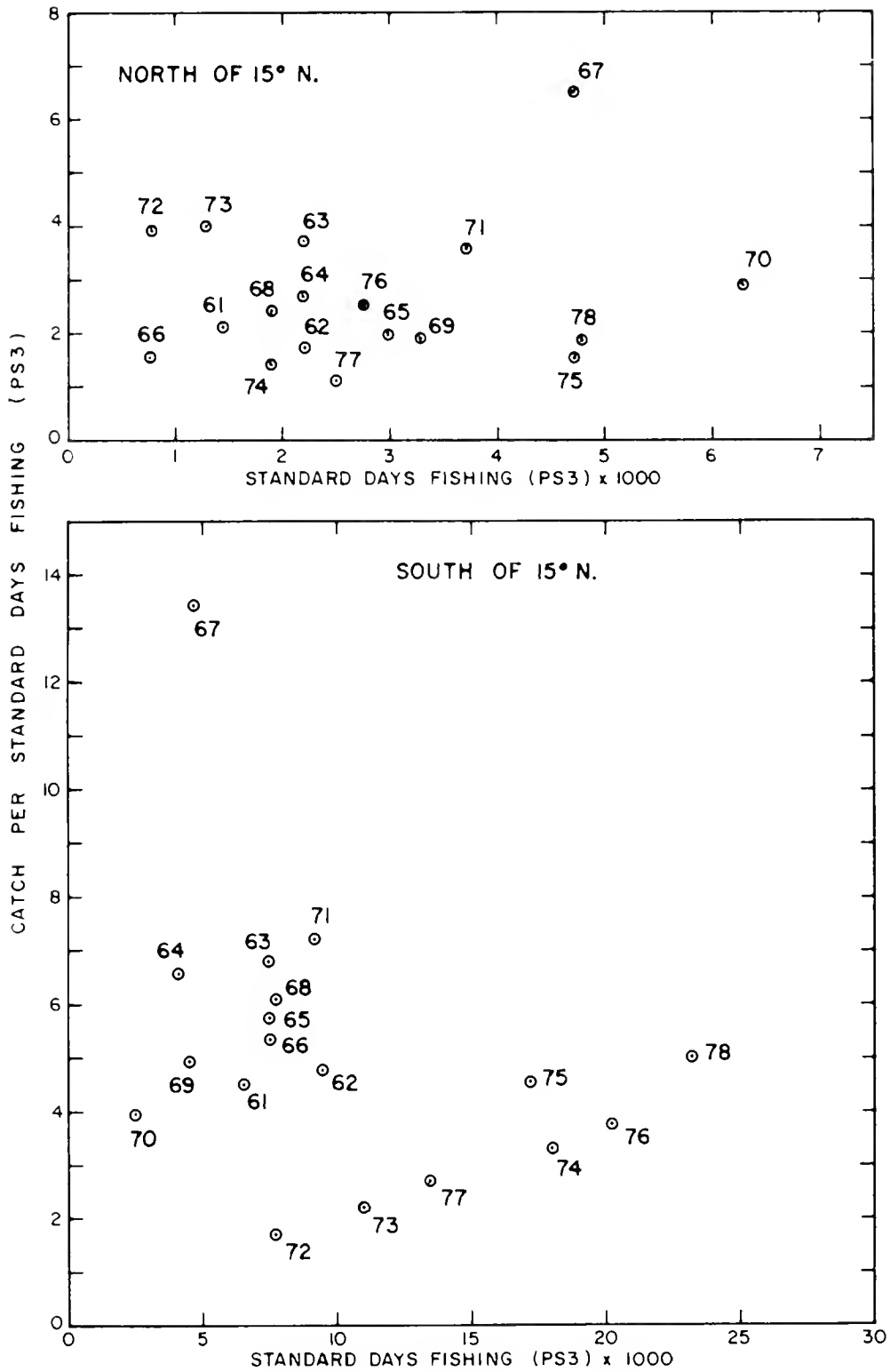

Figure 7. Relationships between CPUE and effort (unregulated and regulated) for skipjack in the CYRA north and south of 15° N, using only data for selected 5° areas, 1961 to 1978.

is not on a unit stock. In addition, environmental studies indicate that perturbations caused by environmental fluctuations may mask changes in apparent abundance caused by fishing effort. The fishing effort has increased in recent years, due to increases in the size of the fleet. This has apparently not depleted the resource because some of the greatest total catches have been made during the last few years. This indicates that there is still no apparent relationship between skipjack tuna stock abundance and fishing effort.

III.B.3. Results of Yield-per-Recruit Analysis

The estimated relationships among size-at-entry, fishing effort, and yield-per-recruit are shown in Figure 8. The top panel is based upon age-specific fishing mortality rates estimated from length-frequency data obtained during 1967 to 1969, the middle panel is based upon rates estimated from data obtained during 1971 to 1973, and the lower panel is based upon rates estimated from data obtained during 1975 to 1977.

Increasing the size-at-entry would not appreciably change the yield-per-recruit at fishing effort levels observed during the years in question (F multiplier = 1.0). The yield-per-recruit remains between 0.75 and 1.00 pounds for the 1975 to 1977 period. At higher fishing mortality levels, an increase in size-at-entry would decrease the yield-per-recruit.

Increasing effort at current size-at-entry would increase the yield-per-recruit to the fishery. An increase in effort which would double the instantaneous fishing mortality would result in an increase in yield-per-recruit of approximately 25%. Increased effort would result in an increased yield-per-recruit even at higher sizes-at-entry for both the 1971 to 1973 and 1975 to 1977 periods.

In general, the yields are highest with a size-at-entry of about 35 cm (about 1.7 pounds) and with fishing effort considerably greater than has so far been the case in the eastern Pacific Ocean. This is because the losses to the total weight of a cohort of fish by natural mortality and emigration exceed the gains to it by growth, even when the fish are only 35 cm long and are presumably growing rapidly.

III.B.4. Results of Spawner/Recruitment Analysis

No spawner/recruitment analyses are available for central and eastern Pacific skipjack tuna.

Possible environmental effects on year-class recruitment of skipjack caught in the eastern Pacific have been investigated by the IATTC in an attempt to explain some of the variation in the catches. Significant correlations have been found between indices of skipjack abundance in the eastern Pacific and sea-surface temperatures in the spawning areas of the central tropical Pacific (180° to 130° W longitude)

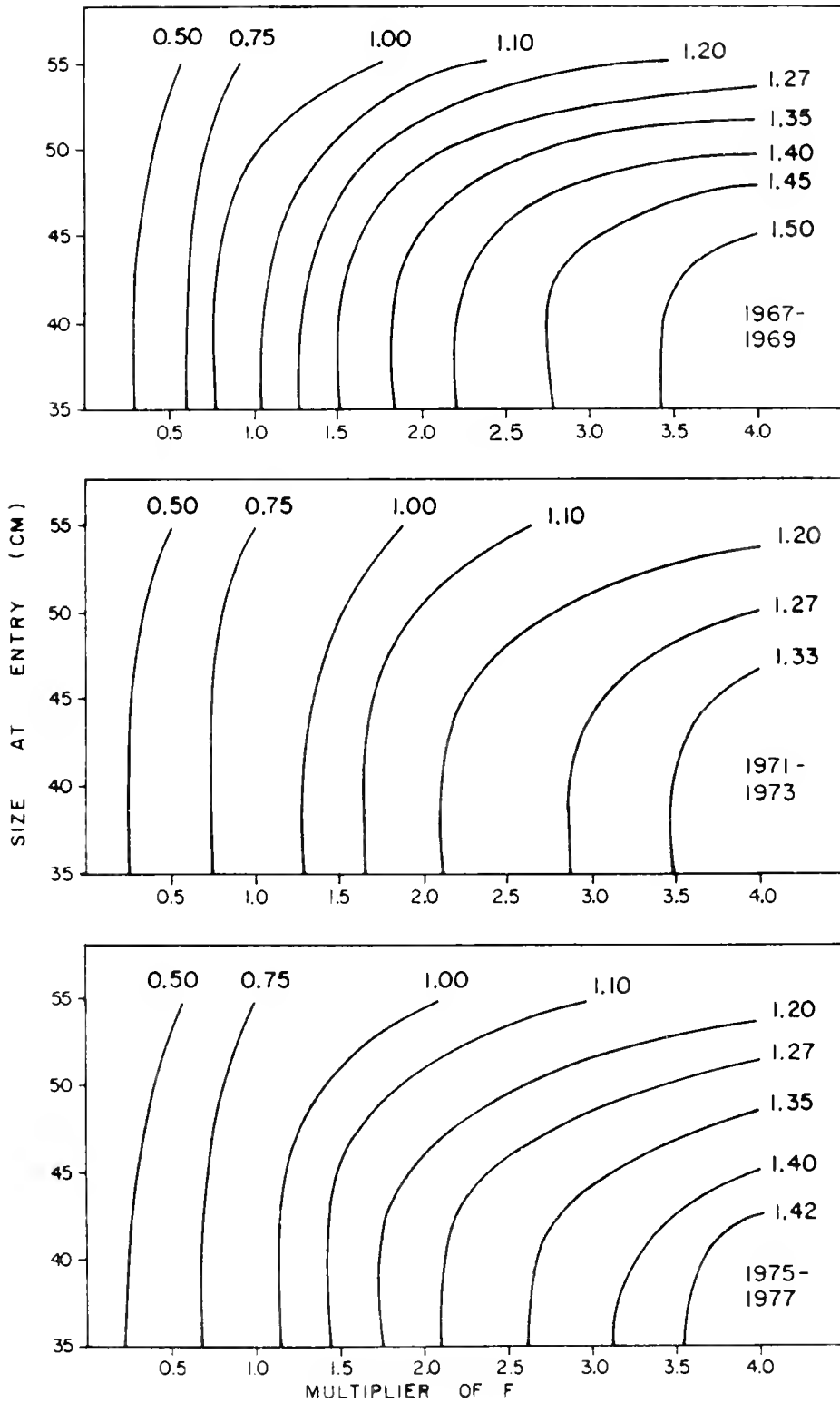

Figure 8. Relationships among size at entry, fishing effort, and yield-per-recruit for skipjack.

approximately 1-1/2 years earlier; related meteorological variables such as barometric pressure differences and wind speeds are also important factors. These investigations indicate that approximately 47% of the variation in the annual catch rate (numbers of fish per standardized day's fishing) of 12- and 24-month old skipjack in the eastern Pacific may be explained by the wind-mixing index in the spawning areas of the central Pacific approximately 1-1/2 years earlier.

III.B.5. Results of Other Analyses/Simulations

Estimates of the general magnitude of the potential yield of skipjack in the Pacific are available. These estimates follow less rigorous techniques and give widely different results. Following the method of Beverton and Holt, Rothschild estimated the potential yield of skipjack from the central Pacific. Using 70,000 mt as an average steady-state yield in the eastern Pacific and assuming a sojourn time of 2 months in the fishing areas of the eastern Pacific, he estimated the potential yield in the central Pacific to be 5 to 17 times greater than the yield in the eastern Pacific, or 350,000 mt to 1,190,000 mt. Assuming a sojourn time of 6 months, he estimated the yield to be 140,000 mt to 420,000 mt. However, Silliman, using a population simulation method, estimated a potential yield of 180,000 to 275,000 mt for the eastern Pacific fishery and the unexploited areas of the central and eastern Pacific.

The Fisheries Agency of Japan has estimated the potential yield for the entire Pacific to be from 800,000 to over 1,000,000 mt. They assumed the skipjack spawning stock was about twice that of other tunas, based on a 1.7 to 1.8 ratio of skipjack larvae to other larvae collected. They then extrapolated the catch of other tunas at that time to obtain estimates of the potential skipjack tuna yield from the entire Pacific Ocean.

III.C. Current Evaluation of Stocks and the Fishery

A relationship between stock abundance and total effort could not be detected, and the potential production of skipjack tuna stocks in the eastern Pacific has not been satisfactorily established. In the eastern Pacific skipjack fishery, the yields per recruit generally are highest with a size-at-entry of 35 cm (about 1.7 pounds) and at fishing effort levels considerably greater than has so far been the case. This is because the losses to the total weight of a cohort of fish by natural mortality and emigration exceed the gains to it by growth. The IATTC indicates that neither the general production models nor the age-structured models examined so far indicate any need for the management of skipjack.

IV. STATUS OF CURRENT RESEARCH NEEDS AND EFFORTS

IV.A. Major Research Problems

Management should be directed toward all parts of a single stock, rather than a part of a stock, a mixture of several stocks, or a mixture of parts of several stocks. Therefore, it is of prime importance to define the stocks or subpopulations of skipjack in the Pacific Ocean.

IV.B. Current Research Efforts

There is no current U.S. research effort on the eastern Pacific skipjack tuna fishery; all research is being conducted by the Inter-American Tropical Tuna Commission. The IATTC has recently increased its tagging of skipjack in the eastern Pacific Ocean and conducted tagging experiments in French Polynesia. The South Pacific Commission has been tagging skipjack in large numbers in the western and central Pacific Ocean in recent years. In addition, collection of blood samples for subpopulation identification is being carried out in the western and central Pacific. In 1979 the IATTC employed approximately 50 people with an operating budget of \$2,746,000.

Various other organizations, particularly the Food and Agriculture Organization of the United Nations, are also striving to obtain better catch and effort data for skipjack in the western and central Pacific. When these studies produce results, it will be possible to better ascertain the status of the Pacific Ocean skipjack tuna subpopulations with regard to fishing.

IV.C. Future Research Needs

The stock structure of skipjack tuna in the Pacific Ocean, particularly the eastern Pacific, is poorly understood. It has been suggested that this is due to the fact that most studies on skipjack tuna have been based on populations occurring in relatively small areas whereas studies on an oceanwide basis are needed.

IV.D. Status of SWFC Data Base

Skipjack tuna catch and related data for the fishery in the CYRA and adjacent areas in the eastern tropical Pacific are in the files of IATTC. Data are generally not available through the SWFC except for those already published by IATTC.

STATUS REPORT: WESTERN PACIFIC SKIPJACK TUNA

by

Howard O. Yoshida

Southwest Fisheries Center
Honolulu, Hawaii

ABSTRACT

The major fisheries for skipjack tuna are located adjacent to continents and islands. In the western Pacific, the Japanese pole-and-line, live-bait fishery is the largest and the oldest established fishery. The stock structure of skipjack tuna in the Pacific is not very well known. Although no production model analyses or other analyses and simulations have been attempted for western Pacific skipjack tuna, all available information suggests that the resource is still underexploited. One of the important research needs for skipjack tuna in the Pacific is the elucidation of the population structure of the resource.

I. DESCRIPTION OF THE FISHERY

I.A. History of the Fishery

Skipjack tuna (Katsuwonus pelamis) are widely distributed in the Pacific Ocean (Figure 1). The major fisheries are located adjacent to continents and islands where oceanographic features such as upwelling concentrate large numbers of fish near the surface. Of the major Pacific fisheries, the Japanese pole-and-line, live-bait fishery in the western Pacific is by far of greatest antiquity. The origin of the Japanese fishery is obscure; however, skipjack tuna fishing is mentioned in the oldest (semilegendary) account of Japanese history. Keen (1965) stated that the Japanese pole-and-line fishery for skipjack tuna dates from at least the early part of the Tokugawa Period (1603-1868).

The Japanese skipjack tuna fishery, which was earlier limited to coastal waters of Japan, has expanded eastward and southward into subtropical and tropical waters. The expansion of the fishery into these waters involved not only pole-and-line vessels but purse seiners as well.

Skipjack tuna fisheries are also well developed or developing in Hawaii and many island areas in the western Pacific. Uchida (1975) reviewed the recent development of skipjack tuna fisheries in the central and western Pacific, including those of French Polynesia, Hawaii, Samoa, Tonga, Australia, Fiji, Tuvalu (Ellice Islands), Indonesia, Korea, New Hebrides, New Caledonia, New Zealand, Papua New Guinea, Philippines, Solomon Islands, and the Trust Territory of the Pacific Islands. Kiribati and Singapore also show landings of skipjack tuna (Food and Agricultural Organization of the United Nations 1979). Japan is the major producer of skipjack in the western Pacific, and also is involved in the fisheries of some of these countries or political entities through joint venture arrangements. Although the FAO yearbooks of fishery statistics show no landings of skipjack tuna in Taiwan, there apparently is a troll fishery of unknown magnitude there.

The U.S. (Hawaii) has a small surface fishery in the western Pacific and American tuna seiners have been making western Pacific exploratory fishing cruises.

I.B. Trends in Catch and Effort

The catch of skipjack tuna in the western Pacific increased from 224,400 to 532,296 metric tons (mt) during 1970-1978 (Figure 2). The catch in the Japanese pole-and-line fishery between 50°N and 30°S latitude and 110°E and 150°W longitude ranged from 119,643 to 245,611 mt, and showed an increasing trend between 1970 and 1977 (Figure 3).

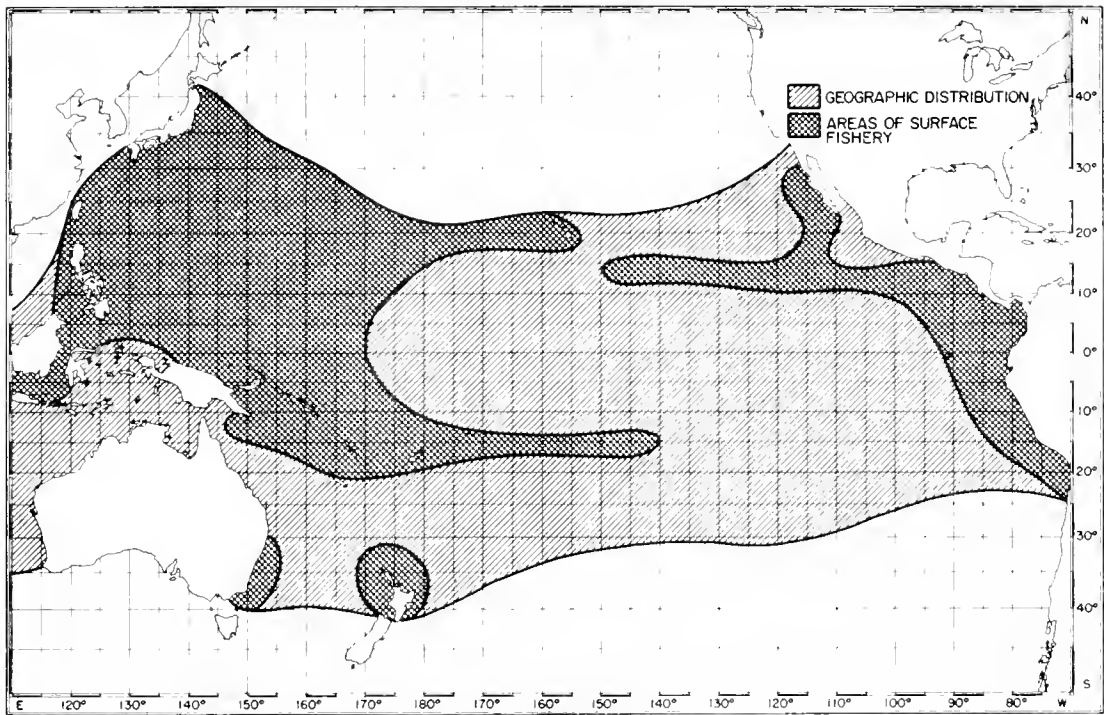

Figure 1.--Skipjack tuna distribution and fisheries in the Pacific Ocean.
(Adapted from Joseph et al. 1979.)

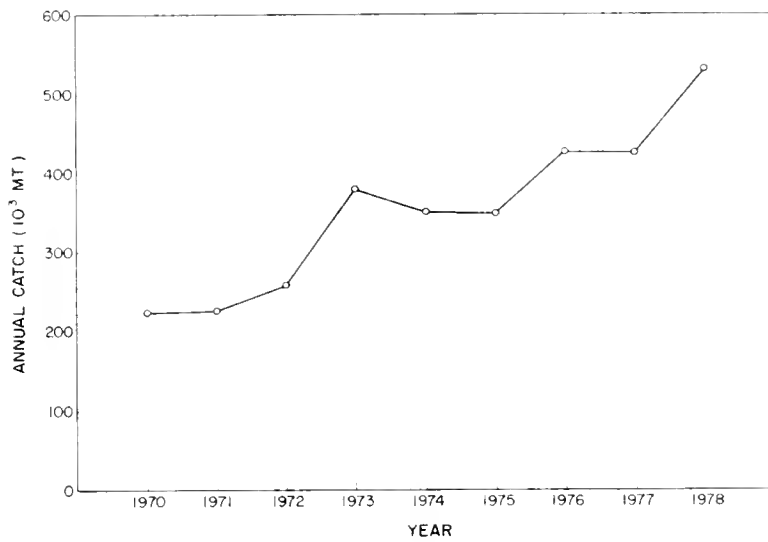

Figure 2.--Annual catch of skipjack tuna in the western Pacific, 1970-78. (Source: FAO 1976, 1977, 1979.)

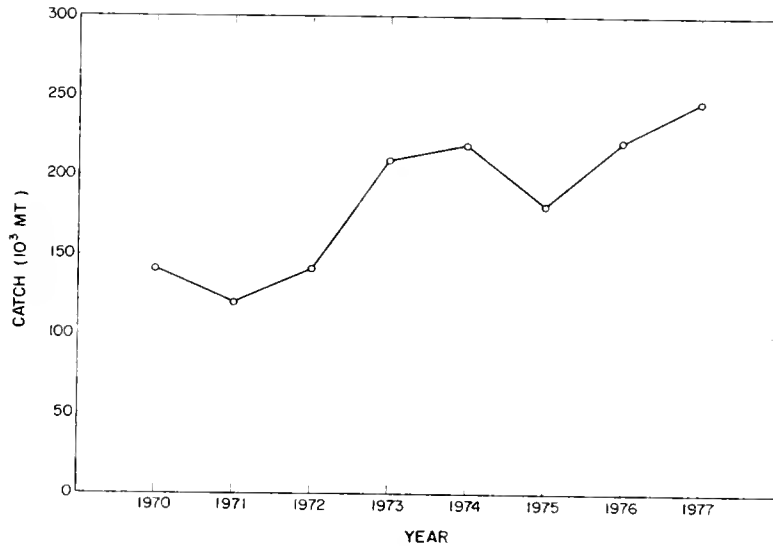

Figure 3.--Skipjack tuna catch in the Japanese pole-and-line fishery in the Pacific between lat. 50°N and 30°S, long. 110°E and 150°W, 1970-77.

Fishing effort in the Japanese pole-and-line fishery between 50°N and 30°S latitude and 110°E and 150°W longitude increased from 37,761 days fished in 1970 to 76,007 days fished in 1977 (Figure 4).

I.C. Value of Catch

From 1969 to 1978, the mean annual ex-vessel price of skipjack tuna at Yaizu, one of the important tuna landing ports in Japan, ranged from \$291 to \$797 per short ton; the ex-vessel value of skipjack tuna in Hawaii during 1968-1977 ranged from \$330 to \$957 per short ton¹ (Figure 5). Except for slight setbacks in 1972 and 1978, the ex-vessel prices at Yaizu have been on a continuous upward trend. Based on the average ex-vessel price of \$797 per short ton at Yaizu, the western Pacific catch of skipjack tuna (532,296) in 1978 was valued at \$467,639,750.

I.D. Current Management of the Fishery

The western Pacific skipjack tuna stock is not currently under management.

II. NATURE AND SIGNIFICANCE OF U.S. AND FOREIGN PARTICIPATION IN THE FISHERY

The U.S. imported 61,046 mt of skipjack tuna for "consumption and general imports" in 1976 from western Pacific countries and island states (U.S. Bureau of the Census 1977). U.S. tuna interests operate freezing and transshipping facilities at Palau and Tahiti and conduct exploratory cruises to the western Pacific in search of new sources of tuna.

¹Hawaii Division of Fish and Game. Commercial fish catch by species, State of Hawaii. (Issued monthly; also annual summaries.)

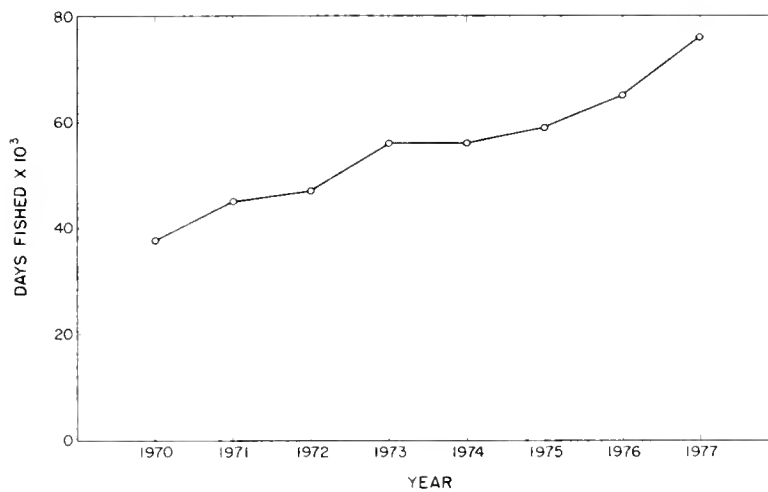

Figure 4.--Fishing effort in the Japanese pole-and-line fishery in the Pacific between lat. 50°N and 30°S and long. 110°E and 150°W, 1970-77.

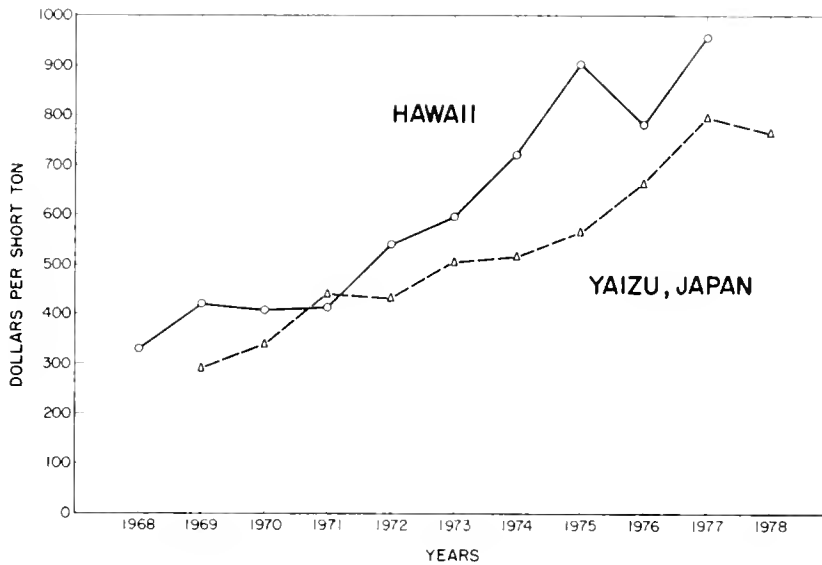

Figure 5.--Ex-vessel value of skipjack tuna landed in Yaizu, Japan, 1969-78, and in Hawaii, 1968-77. (Data from [U.S.] National Marine Fisheries Service 1969-1978 and Hawaii Division of Fish and Game see text footnote 1.)

III. STATUS OF THE STOCKS

III.A. Stock Structure

The stock structure of skipjack tuna in the Pacific is unclear. It has been hypothesized that two subpopulations exist in the Pacific, one in the western Pacific and the other in the eastern and central Pacific (Fujino 1970). However, recent studies² indicate that although the possibility of genetically isolated skipjack tuna populations in the Pacific cannot be ruled out, the available data do not indicate stable geographical boundaries between genetically isolated sub-populations, as advanced by Fujino (1970, 1976). Data presented at the second workshop on skipjack tuna blood genetics sponsored by the Skipjack Survey and Assessment Programme of the South Pacific Commission in September 1980, indicated that "the apparent esterase cline constitutes evidence that Pacific Ocean skipjack do not comprise a panmictic population, in which complete mixing would occur across the extremes of the population range, within a single generation." There apparently is some "resistance" to complete mixing of skipjack tuna across the Pacific but the nature and magnitude of the "resistance" could not be ascertained from the available genetics data.

III.B. Stock Assessment and Fishery Evaluation

III.B.1. Trends in Catch-per-Unit-Effort

An analysis of the Japanese coastal and distant water skipjack tuna fisheries for the period 1957-1973 (Ishida 1975) showed neither an upward nor downward trend in the catch rate (Figure 6). Updated analyses on changes in catch, effort, population index, density index, and efficiency of effort, indicated a possible decreasing trend in the catch-per-unit of effort north of 10°N latitude and in the area north and west of Papua New Guinea. However, density indices in equatorial regions

²Skipjack Survey and Assessment Programme. 1980. Progress review of genetic analysis of skipjack blood samples by the Skipjack Survey and Assessment Programme. Presented at the Twelfth South Pacific Commission Regional Technical Meeting on Fisheries, Noumea, New Caledonia, 17-21 November 1980.

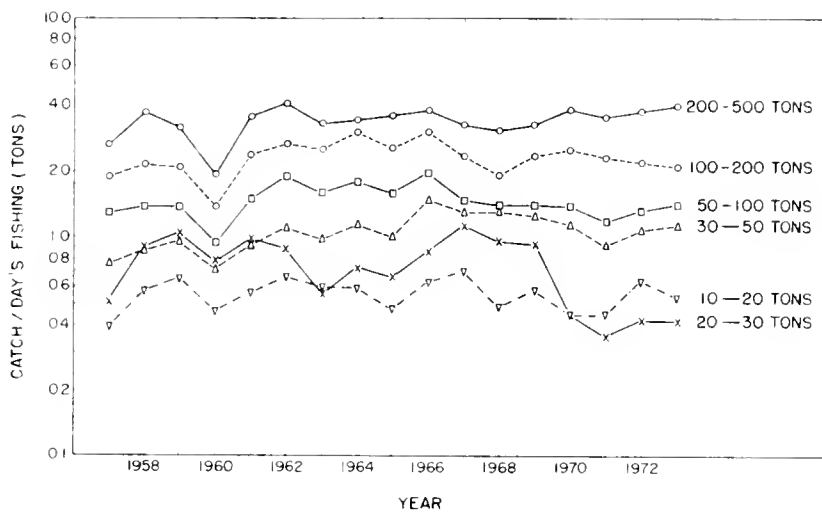

Figure 6.--Catch per day's fishing by vessel size classes in the Japanese skipjack tuna pole-and-line fishery. (From Ishida 1975.)

fluctuated considerably and showed no consistent trends (Kasahara 1978³; Tohoku Regional Fisheries Research Laboratory 1978⁴).

III.B.2 Results of Production Model Analysis

None available.

III.B.3 Results of Yield-per-Recruit Analysis

None available.

III.B.4 Results of Spawner/Recruitment Analysis

None available.

III.B.5 Results of Other Analyses/Simulations

None available.

III.C. Current Evaluation of Stocks and the Fishery

All available evidence suggests that the western Pacific skipjack tuna resources are still underexploited (Kearney 1979).

³Kasahara, K. 1978. Assessment of skipjack stocks in the Japanese baitboat fishery. Tohoku Regional Fisheries Research Laboratory, Shiogama, Japan. Paper submitted to the First Session of the IPFC Working Party of Experts on Central and Western Pacific Skipjack, Manila, Philippines, 1-2 March 1978.

⁴Tohoku Regional Fisheries Research Laboratory. 1978. Atlas of catch and CPUE of skipjack tuna in the Japanese baitboat fishery, 1972-76. Paper submitted to the First Session of the IPFC Working Party of Experts on Central and Western Pacific Skipjack, Manila, Philippines, 1-2 March 1978.

IV. STATUS OF CURRENT RESEARCH NEEDS AND EFFORTS

IV.A. Major Research Problems

Skipjack tuna are widely distributed in the Pacific Ocean and are believed to constitute a large resource. All the evidence available to date indicates that the resource is still underexploited. It has been stated that conservation of the skipjack tuna resource would not be a significant issue in the future development of fisheries in the western equatorial Pacific and that development and management strategies will likely be directed at maximizing yields and optimizing socioeconomic returns (Kearney 1979).

IV.B. Current Research Efforts

The South Pacific Commission (SPC) headquartered at Noumea, New Caledonia, recently initiated a skipjack tuna assessment program in the SPC area of interest. The SPC research effort includes tagging, study of blood genetics, exploratory fishing for tuna and bait, and analyzing basic biological data (length, weight, sex, maturity, and stomach contents).

The Tohoku Regional Fisheries Research Laboratory (presumably the major agency for skipjack tuna research in Japan) prepares an atlas of Japanese skipjack tuna fishing operations in the southern fishing grounds, which includes data on monthly catch rates and length-frequency distributions. Research on skipjack tuna has also been conducted in Taiwan, including studies on age and growth, larvae, sexual maturity and fecundity, and morphometrics.

IV.C. Future Research Needs

Results of recent studies on blood genetics suggest a complex population structure for skipjack tuna in the Pacific Ocean. Although all evidence indicates that the skipjack tuna resource is still underutilized, it is important to determine the population structure of Pacific skipjack tuna clearly.

IV.C.1. Suggested Approach and Methods

The Skipjack Survey and Assessment Programme of the South Pacific Commission recently completed the field work for a skipjack tuna tagging program. The Programme is also conducting skipjack tuna blood genetics studies and other ancillary studies to investigate the stock structure of Pacific skipjack tuna. It is expected that much will be

learned from the results of these studies. However, it is anticipated that there will continue to be gaps in the knowledge of skipjack tuna stock structure and ecology. These approaches and methods should be continued in the study of the population structure of Pacific skipjack tuna.

IV.D. Status of SWFC Data Base

Data from Japanese baitboat operations published in annual statistical digests are included in the data base maintained at the Honolulu Laboratory. Landing statistics from a few of the island states in the western Pacific and data from the Hawaiian pole-and-line fishery, including size data, are also included in the data base.

LITERATURE CITED

- Food and Agriculture Organization of the United Nations.
1976. Catches and landings, 1975. FAO Yearbook Fish. Stat. 40, 417 p.
1977. Catches and landings, 1976. FAO Yearbook Fish. Stat. 42, 323 p.
1979. Catches and landings, 1978. FAO Yearbook Fish. Stat. 46, 372 p.
- Fujino, K.
1970. Immunological and biochemical genetics of tunas. Trans. Am. Fish. Soc. 99:152-178.
1976. Subpopulation identification of skipjack tuna specimens from the southwestern Pacific Ocean. Bull. Japan Soc. Sci. Fish. 42: 1229-1235.
- Ishida, R.
1975. Skipjack tuna fishery and fishing grounds (Katsuo gyogyo to gyojyo). From Reports pertaining to effects of ocean disposal of solid radioactive wastes on living marine resources (Hoshasei kotai haiki butsu no kaiyo shobun ni tomonau kaisan seibutsu to ni kansuru chosa hokoku-sho). Jpn. Fish. Agency, Tokai Reg. Fish. Res. Lab., Tohoku Reg. Fish. Res. Lab., and Far Seas Fish. Res. Lab., p. 88-92. July 1975. (Engl. transl. by T. Otsu, 1975, 1 p., Transl. No. 12; available Southwest Fish. Cent., Natl. Mar. Fish. Serv., NOAA, Honolulu, HI 96812.

Joseph, J., W. Klawe, and P. Murphy.

1979. Tuna and billfish--fish without a country. Inter-Am. Trop. Tuna Comm., La Jolla, Calif. 46 p.

Kearney, R. E.

1979. An overview of recent changes in the fisheries for highly migratory species in the western Pacific Ocean and projections for future developments. South Pac. Bur. Econ. Coop., Suva, Fiji, SPEC(79)17, 96 p.

1980. Skipjack Survey and Assessment Programme. Annual report for the year ending 31 December 1979. South Pac. Comm., Noumea, New Caledonia, 14 p.

Keen, E. A.

1965. Some aspects of the economic geography of the Japanese skipjack tuna fishery. Ph.D. Thesis, Univ. Washington, Seattle, 195 p.

Uchida, R. N.

1975. Recent development in fisheries for skipjack tuna, Katsuwonus pelamis, in the central and western Pacific and the Indian Ocean. In Studies on skipjack in the Pacific, p. 1-57. FAO Fish. Tech. Pap. 144.

U.S. Bureau of the Census.

1977. U.S. imports for consumption and general imports. Report FT 246, annual 1976. U.S. Gov. Print. Off., Wash., D.C., 442 p.

[U.S.] National Marine Fisheries Service.

1968-1978. Foreign fishery information release. Supplement to Market News Report.

STATUS REPORT: WESTERN PACIFIC YELLOWFIN TUNA

by

Howard O. Yoshida

Southwest Fisheries Center
Honolulu, Hawaii

ABSTRACT

Yellowfin tuna are primarily caught by longline gear in the western Pacific. Although the stock structure of yellowfin tuna is not well known, it has been hypothesized that there are two separate stocks in the Pacific, one in the eastern Pacific and the other in the western Pacific, which are separated by a less clearly defined stock in the central Pacific. A stock production model based on longline catches of yellowfin tuna in the entire Pacific indicated that the stock is capable of sustaining the current level of catches. An important research need for yellowfin tuna in the western Pacific is to determine the relation and the extent of mixing of fish that are available to surface gear and longline gear.

I. DESCRIPTION OF THE FISHERY

I.A. History of the Fishery

Yellowfin tuna (Thunnus albacares) in the western Pacific Ocean (west of ca. 150° W longitude) is caught primarily by longline gear; smaller amounts are taken by pole-and-line, purse seine, and other surface-fishing gear. The longline fishery that now extends completely across the Pacific Ocean between approximately 45° N and 45° S latitude is an outgrowth of the Japanese longline fishery, which was generally confined to the western Pacific before World War II. The Japanese longline fishery quickly expanded eastward after the war and reached the American continents in 1964 (Figure 1). Longline vessels from Taiwan joined the fishery in 1962 and those from South Korea, in 1965 (Suzuki et al. 1978). Because the longline fishery extends completely across the Pacific Ocean, for the purpose of this report yellowfin tuna are considered for the entire Pacific Ocean insofar as they relate to the longline fishery.

Japan, Taiwan, and the Philippines have surface fisheries for yellowfin tuna in the western Pacific. Australia, Fiji, Gilbert Islands, Papua New Guinea, New Zealand, and French Polynesia also show landings of yellowfin tuna (Food and Agriculture Organization of the United Nations [FAO] 1977, 1978).

The U.S. (Hawaii) has a small longline fishery and also a surface fishery for yellowfin tuna in the western Pacific.

I.B. Trends in Catch and Effort

The total annual catch of yellowfin tuna (all gear combined) ranged from 28,586 to 193,518 mt from 1952 to 1977 in the western Pacific (Table 1). The catches made in the various Japanese fisheries (which totaled 28,118 to 101,480 mt from 1952 to 1977) contributed the largest amount to the western Pacific annual total (Table 2). The bulk of the Japanese total annual catch is taken by longline vessels over 20 gross tons. Table 2 also shows the catch by gear, for other countries fishing yellowfin tuna in the western Pacific

The total western Pacific catch of yellowfin tuna peaked in the mid-1960's (with a high of 110,458 mt in 1966), declined slowly to 76,121 mt in 1971, then increased rapidly to levels higher than that in the 1960's, reaching 193,518 mt in 1977 (Figure 2). Reported catches from the Philippines since 1974 (Table 2) account for the increase in the total recorded catch of yellowfin tuna in recent years (FAO, in press).

The total (Japan, Korea, Taiwan) fishing effort for yellowfin tuna in the Pacific generally showed an increasing trend from 75 million

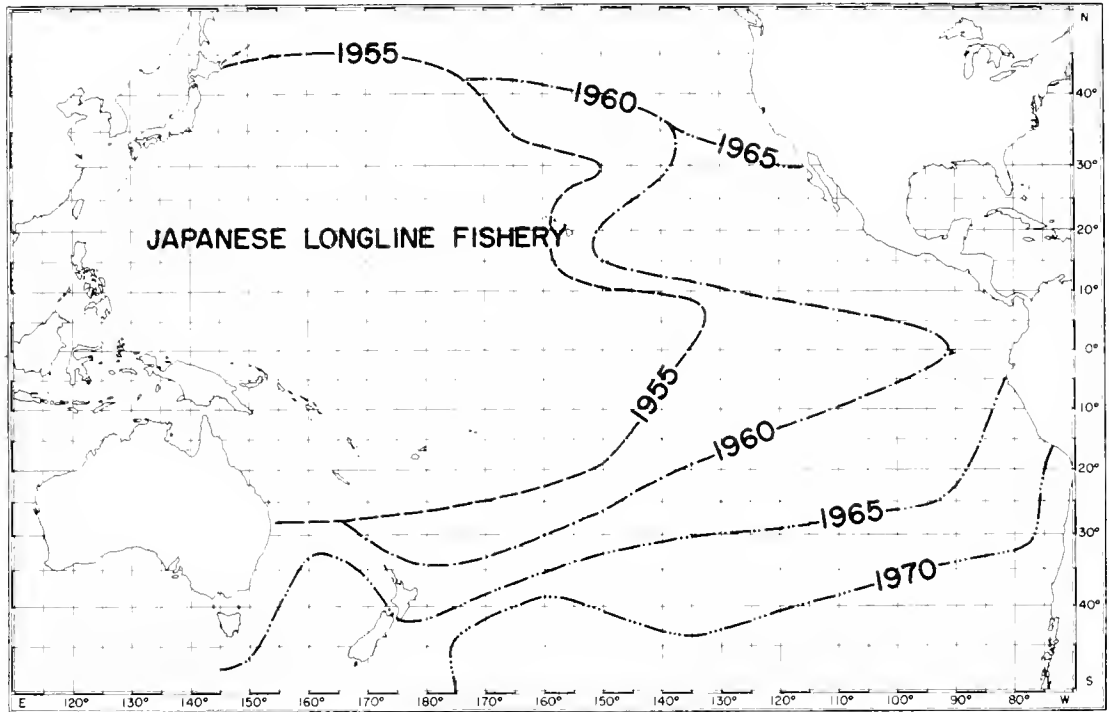

Figure 1.--Expansion of the Japanese longline fishery in the Pacific Ocean.
(From Kume 1972.)

Table 1.--Catch of yellowfin tuna in the western Pacific (all gear) in metric tons. (Data from Honma and Suzuki see text footnote 2.)

Year	Japan	Korea	Taiwan	Philippines	Others	Grand Total
1952	28,586					28,586
1953	40,164					40,164
1954	43,450		1,192			44,642
1955	36,903		2,724			39,627
1956	28,118		2,377			30,495
1957	59,865		2,109			71,974
1958	74,929		1,753			76,682
1959	72,189		1,568			73,757
1960	77,485		1,301			78,786
1961	98,363		2,606			100,969
1962	100,426		5,513			105,939
1963	101,480		5,149			106,629
1964	89,440	500	5,795		300	96,035
1965	82,265	2,000	7,890		100	92,255
1966	96,137	3,000	11,221		100	110,458
1967	68,867	1,900	6,629		100	77,496
1968	73,116	5,300	11,452		100	89,968
1969	73,520	3,500	10,598		100	87,718
1970	71,645	2,000	10,502		100	84,247
1971	56,317	5,300	14,404		100	76,121
1972	75,053	11,800	13,368		100	100,321
1973	77,468	12,000	19,226	14,900	1,620	125,214
1974	81,359	15,104	12,706	51,732	1,511	162,412
1975	72,674	10,366	16,867	52,793	1,823	154,523
1976	94,818	15,613	17,235	44,478	8,852	180,996
1977	93,638	16,580	20,042	59,263	3,995	193,518

Table 2.--Estimated catch (metric tons) of yellowfin tuna by gear type in the Pacific Ocean, 1952-77.
(Adapted from Honma and Suzuki see text footnote 2.)

Year	Japan				Young	Korea		Taiwan			Others ³
	Long-line ¹	Bait boat	Purse seine	Others		Long-line	Long-line	Others	Philippines		
1952	22,477	2,595	--	3,192	--	--	--	--	--	--	--
1953	33,288	5,228	192	1,456	--	--	--	--	--	--	--
1954	34,174	4,268	3,900	853	--	--	--	1,192	--	--	--
1955	28,794	3,983	2,580	1,392	--	--	--	2,724	--	--	--
1956	22,717	4,399	709	293	--	--	--	2,377	--	--	--
1957	60,976	1,669	1,095	916	4,856	--	--	2,109	--	--	--
1958	60,608	2,934	2,983	1,332	6,895	--	--	1,753	--	--	--
1959	55,146	4,119	4,032	1,462	7,103	--	--	1,568	--	--	--
1960	68,438	1,872	1,436	571	4,914	--	--	1,301	--	--	--
1961	84,527	3,259	2,766	820	6,696	--	--	2,606	--	--	--
1962	79,632	4,225	6,705	1,223	8,350	--	--	5,513	--	--	--
1963	88,050	2,071	2,178	552	8,362	--	--	5,149	--	--	--
1964	71,508	4,932	3,647	864	8,339	500	500	5,795	--	--	300
1965	66,809	3,261	3,752	466	7,782	2,000	2,000	7,890	--	--	100
1966	77,469	2,121	5,843	1,663	7,653	3,000	3,000	10,750	471	471	100
1967	47,982	3,073	3,395	3,212	9,018	1,900	1,900	5,981	648	648	100
1968	52,265	2,689	6,886	1,555	8,654	5,300	5,300	10,917	535	535	100
1969	56,110	2,581	4,329	681	7,133	3,500	3,500	10,178	420	420	100
1970	50,940	1,932	5,720	1,453	7,244	2,000	2,000	10,096	406	406	100
1971	40,930	2,382	2,713	435	6,731	5,300	5,300	14,040	364	364	100
1972	53,345	4,029	4,585	1,097	8,194	11,800	11,800	13,037	331	331	100
1973	47,973	8,366	7,455	664	10,425	12,000	12,000	18,785	441	441	1,620
1974	44,316	7,132	12,222	948	14,236	15,104	15,104	12,372	334	334	1,511
1975	45,996	3,249	7,790	986	9,393	10,366	10,366	16,441	426	426	1,823
1976	55,497	7,146	10,655	1,624	11,040	15,613	15,613	15,857	1,378	1,378	8,852
1977	57,300	6,295	10,223	647	11,547	16,580	16,580	19,418	624	624	3,995

¹Vessels over 20 gross tons.

²Vessels under 20 gross tons.

³Includes catches from Australia, Fiji, Gilbert Islands, Papua New Guinea, New Zealand, and French Polynesia.

⁴Provisional estimate.

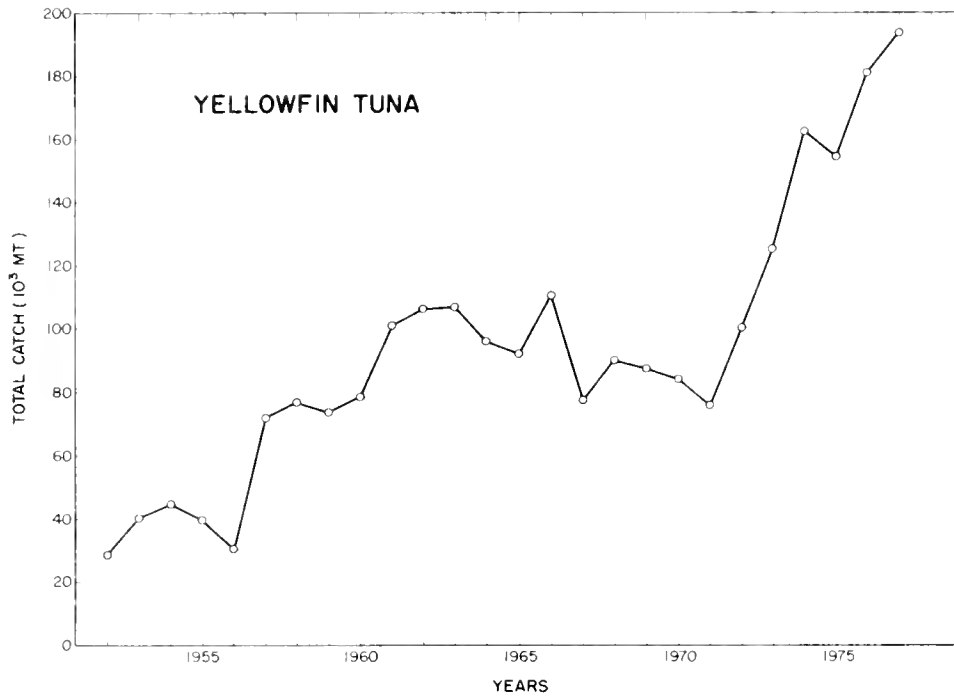

Figure 2.--Yellowfin tuna annual catch trends in the western Pacific Ocean. (Data from Honma and Suzuki see text footnote 2.)

effective hooks in 1953 to 547 million effective hooks in 1977 (Table 3). Most of the longline fishing effort in the early years was expended by Japan, and although Korea and Taiwan have increased their longline effort in recent years, Japanese longliners still account for a large part of the total effort.

I.C. Value of Catch

The mean annual ex-vessel price of yellowfin tuna at Yaizu, Japan, ranged from \$511 to \$1,873 per short ton from 1969 to 1978 ([U.S.] National Marine Fisheries Service, 1969 to 1978; Federation of Japan Tuna Fisheries Cooperative Association and Japan Tuna Fisheries Federation [1976?]); the ex-vessel price ranged from \$985 to \$1,984 per short ton from 1968 to 1977 in Hawaii¹ (Figure 3). Based on the mean ex-vessel price of \$1,815 per short ton in 1978 at Yaizu, Japan, the value of the western Pacific yellowfin tuna catch in 1978 was \$387,166,528.

I.D. Current Management of the Fishery

The western Pacific yellowfin tuna is not currently under management

II. NATURE AND SIGNIFICANCE OF U.S. AND FOREIGN PARTICIPATION IN THE FISHERY

The yellowfin tuna is one of the important species caught in the Hawaiian longline fishery. It is also an important species in the recreational fishery in Hawaii.

Yellowfin tuna are landed at American Samoa, Tahiti, and other island areas where U.S. interests operate canneries or transshipment facilities. American purse seiners have also been making exploratory fishing voyages in the western Pacific.

¹Hawaii Division of Fish and Game. Commercial fish catch by species, State of Hawaii. (Issued monthly; also annual summaries.)

Table 3.--Catch (metric tons) and effective effort ($\times 10^3$ hooks) for yellowfin tuna in the Pacific Ocean, 1951-77. (Adapted from FAO in press.)

Year	Japanese longline fisheries		Total (Japan, Korea, Taiwan) longline fisheries	
	Catch	Effort	Catch	Effort
1952	22,477	74,252	22,799	75,316
1953	33,288	85,475	33,288	85,475
1954	34,174	81,382	35,621	84,828
1955	¹ 28,794	¹ 133,412	¹ 31,672	¹ 146,747
1956	¹ 22,717	¹ 113,524	¹ 25,094	¹ 125,403
1957	60,976	163,402	63,438	170,000
1958	60,608	167,694	62,538	173,034
1959	55,146	164,967	57,041	169,602
1960	68,438	190,837	69,993	195,173
1961	84,527	269,104	87,428	278,339
1962	79,632	322,379	85,436	345,876
1963	88,050	333,814	93,466	354,347
1964	71,508	276,504	77,953	301,425
1965	66,809	281,309	76,894	323,773
1966	77,469	313,521	92,607	374,785
1967	47,982	232,519	58,050	281,308
1968	52,265	239,155	69,549	318,243
1969	56,110	238,602	72,474	308,188
1970	50,940	197,668	67,392	261,508
1971	40,930	222,433	63,396	344,525
1972	53,345	266,719	81,985	409,916
1973	47,973	274,479	81,343	465,402
1974	44,316	287,845	74,297	482,580
1975	45,996	260,001	78,063	441,265
1976	55,497	306,615	94,113	519,965
1977	57,300	311,091	100,924	547,932

¹Provisional estimate.

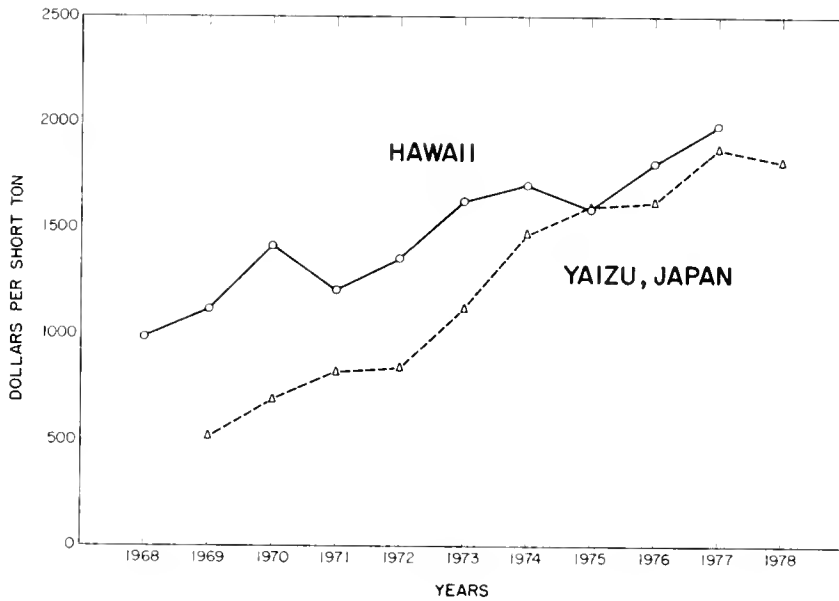

Figure 3.--Mean annual ex-vessel value of yellowfin tuna landed in Yaizu, Japan, 1968-78 and in Hawaii, 1968-77. (Data from [U.S.] National Marine Fisheries Service 1969-1978; Federation of Japan Tuna Fisheries Cooperative Association and Japan Tuna Fisheries Federation [1976?]; Hawaii Division of Fish and Game see text footnote 1.)

III. STATUS OF STOCKS

III.A. Stock Structure

The stock structure of yellowfin tuna in the Pacific Ocean is not perfectly clear but a hypothesis has been advanced that there are two distinct stocks, one in the eastern Pacific and the other in the western Pacific, separated by a less clearly defined stock in the central Pacific (Suzuki et al. 1978).

III.B. Stock Assessment and Fishery Evaluation

III.B.1. Trends in Catch-per-Unit-Effort

In a study to examine the changes in catch-per-unit-effort in the Japanese longline fishery, the Pacific Ocean was divided into nine areas (Figure 4). After the first few years of fishing, the catch-per-unit-effort fell sharply in most areas, then showed a relatively steady and gradual decline as nominal effort increased (Figure 5).

III.B.2. Results of Production Model Analysis

Although a production model analysis was not possible for the combined surface and longline fisheries for yellowfin tuna in the western Pacific, an analysis (Honma and Suzuki²) was possible for the entire Pacific longline fishery, which probably reflects the situation in the western Pacific longline fishery (Figure 6). This analysis suggests that the total effort is at or approaching the level producing MSY (maximum sustainable yield), which is estimated at around 80,000 to 90,000 mt.

III.B.3. Results of Yield-per-Recruit Analysis

None available.

III.B.4. Results of Spawner/Recruitment Analysis

None available.

¹Honma, M., and Z. Suzuki. 1979. Stock assessment of Pacific yellowfin tuna exploited by the tuna longline fishery together with surface and other fisheries in the western and central Pacific. Prepared for the Workshop on the Assessment of Selected Tuna and Billfish Stocks in the Indian and Pacific Oceans, Shimizu, Japan, 13-22 June 1979.

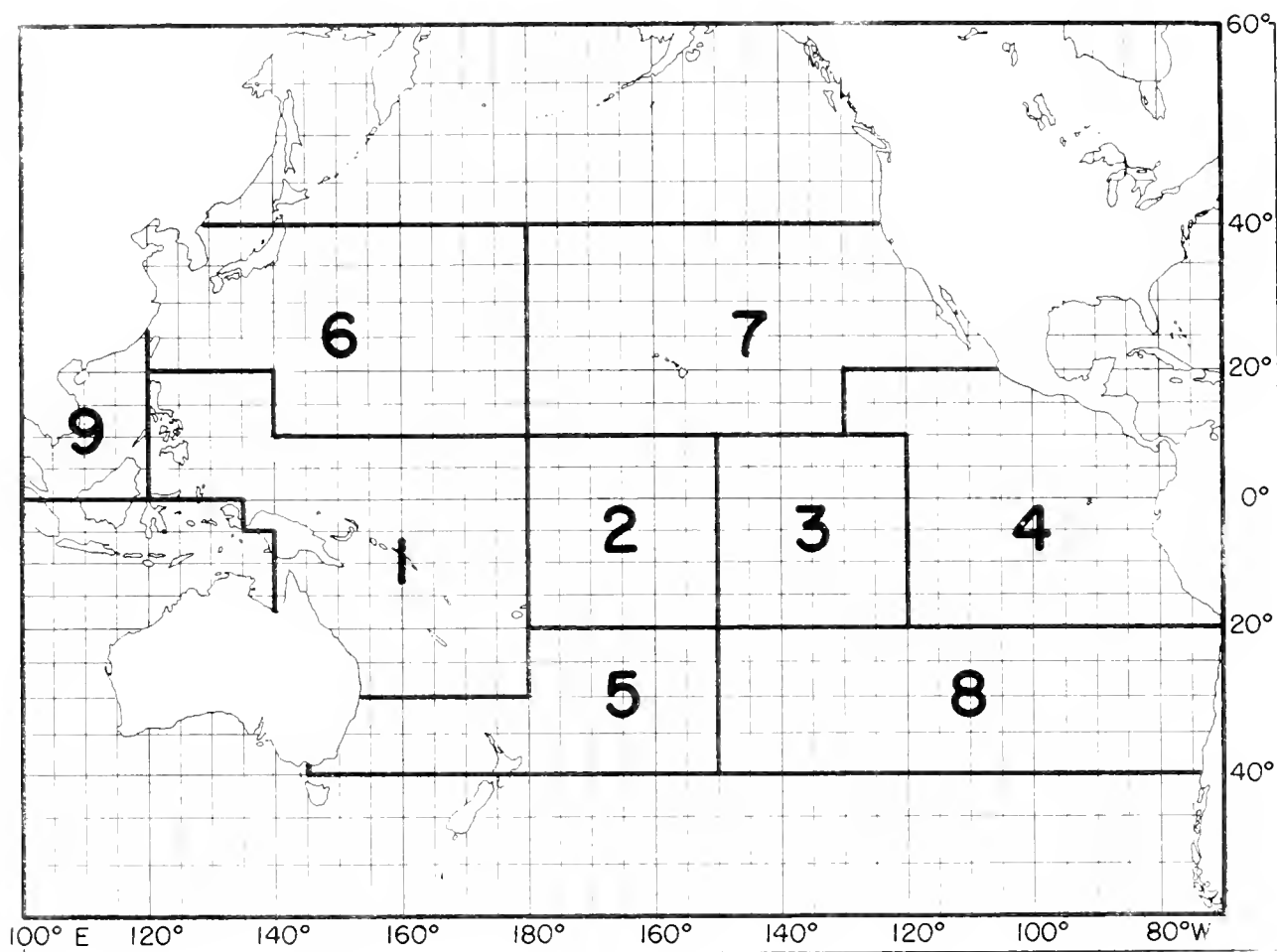

Figure 4.--Subareas in the longline fishery for yellowfin tuna in the Pacific. (From FAO in press.)

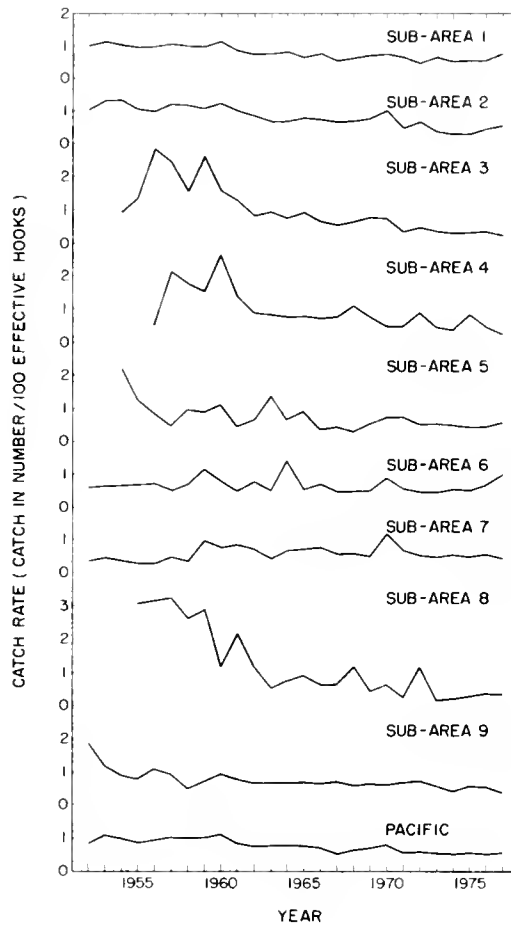

Figure 5.--Catch rate for yellowfin tuna in the Japanese longline fishery by subareas. (Adapted from FAO in press.)

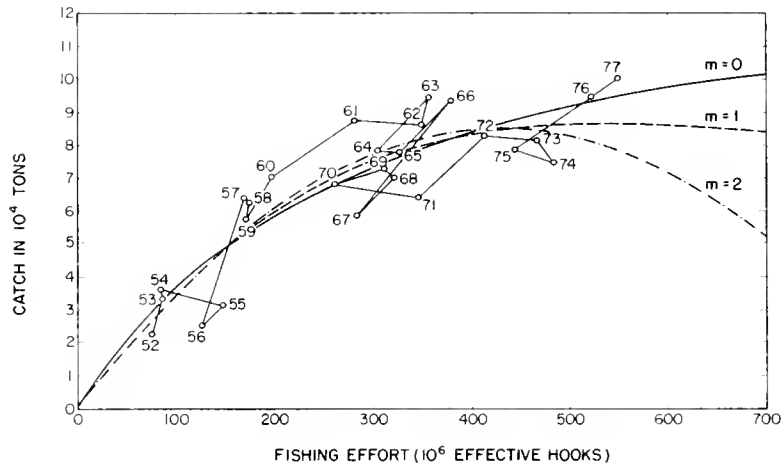

Figure 6.--Catch and effort plots with curves fitted to the model for $m = 0, 1,$ and 2 ($k = 3$), respectively, for yellowfin tuna caught in the Pacific-wide longline fishery, 1952-77. (From FAO in press.)

III.B.5. Results of Other Analyses/Simulations

None available.

III.C. Current Evaluation of Stocks and the Fishery

Although the condition of the western Pacific yellowfin tuna stock(s) is not certain, it appears that the stock is capable of sustaining the current level of fishing, or perhaps more. It was estimated that the MSY for the Pacific longline fishery for yellowfin tuna was around 80,000 to 90,000 mt and that increased longline fishing effort was unlikely to result in a significant increase in sustained catch.

IV. STATUS OF CURRENT RESEARCH NEEDS AND EFFORTS

IV.A. Major Research Problems

The following factors need to be determined:

- 1) Growth parameters of western Pacific yellowfin tuna.
- 2) The relation and the extent of mixing of fish available to surface gear and longline gear.
- 3) Yield-per-recruit estimates: It has been pointed out that the surface fisheries in the Philippines may be making substantial catches of small yellowfin tuna, which is not good from a yield-per-recruit standpoint.

In addition, production model analysis incorporating surface catch and effort data should be undertaken.

IV.B. Current Research Efforts

A background paper on a preliminary assessment of western Pacific yellowfin tuna exploited by the longline fishery (Honma and Suzuki, see footnote 2) was presented at the tuna and billfish stock assessment workshop held at Shimizu, Japan, in June 1979. Since that time there has been no concerted effort to continue these studies.

IV.C. Future Research Needs

Some of the research needs for the western Pacific yellowfin tuna include necessary data for stock assessment purposes:

- 1) The magnitude and size composition of the large Philippine surface catch of yellowfin in recent years should be accurately estimated and historical catches documented.
- 2) The problem of double reporting of catches should be resolved.
- 3) Estimates of misidentified or unidentified yellowfin tuna in the catches are needed.
- 4) Size-composition data are needed from all the fisheries, particularly the surface fisheries.
- 5) Yield/recruit estimates are needed for stock assessment and for production model analyses (which include surface catch and effort data).
- 6) Effects of competition between surface and longline fisheries should be further examined.
- 7) The extent of mixing between fish available to surface and longline gears should be examined.
- 8) Additional estimates of the growth of yellowfin tuna in the western Pacific are needed.

IV.C.1. Suggested Approach and Methods

- 1) Cooperative arrangements should be made with foreign countries for the collection of yellowfin tuna fishery statistics, particularly those from the Philippines.
- 2) The extent of mixing between fish available to surface and longline gears could be assessed by means of tagging experiments.

IV.D. Status of SWFC Data Base

The data on catch, catch-per-effort, and length frequencies needed for assessment studies on yellowfin in the Pacific are either inadequate or are lacking and should therefore be secured. In particular, the large

surface catch of yellowfin in the Philippines in recent years should be documented, and longer historical catch data obtained. Problems on double reporting of catches, and misidentified or unidentified yellowfin tuna catches, must also be corrected.

LITERATURE CITED

Federation of Japan Tuna Fisheries Cooperative Association
and Japan Tuna Fisheries Federation.

[1976?] Katsuo to maguro (skipjack and tunas). Statistics of
Japanese tuna fishery, 1975, 25 p.

Food and Agriculture Organization of the United Nations.

1977. Catches and landings, 1976. FAO Yearbook Fish. Stat. 42,
323 p.

1978. Catches and landings, 1977. FAO Yearbook Fish. Stat. 44,
343 p.

In press. Summary report of the Workshop on the Assessment of
selected Tuna and Billfish Stocks in the Pacific and Indian Oceans,
Shimizu, Japan, 13-22 June 1979.

Kume, S.

1972. Tuna fisheries and their resources in the Pacific Ocean.
Indo-Pac, Fish. Counc. Proc., 15th Sess., Sect. 3: 390-423.

Suzuki, Z., P. K. Tomlinson, and M. Honma.

1978. Population structure of Pacific yellowfin tuna [In Engl. and
Span.] Inter-Am. Trop Tuna Comm. Bull. 17: 277-441.

[U.S.] National Marine Fisheries Service.

1969-1978. Foreign fishery information release. Supplement to
Market News Report.

STATUS REPORT: SOUTH PACIFIC ALBACORE

by

Jerry A. Wetherall

Southwest Fisheries Center
Honolulu, Hawaii

ABSTRACT

The South Pacific albacore stock has been fished since 1952. Most of the catch is taken by longline vessels from Japan, the Republic of Korea, and Taiwan. Longline catch-per-unit-effort declined considerably between 1962 and 1974 as effort and catch increased. However, catch rates increased in recent years so that average annual catch has increased recently in spite of lowered effort. Present average annual catch by longliners is in the neighborhood of the estimated MSY for this fishery, 35,000 mt, and no sustained increase in longline catch can be expected. Potentials for expanding the surface catch of relatively small albacore are unknown.

I. DESCRIPTION OF THE FISHERY

I.A. History of the Fishery

Albacore, Thunnus alalunga, is one of the most important species taken in the South Pacific tuna longline fishery by vessels from Taiwan, the Republic of Korea, and Japan. Small amounts of South Pacific albacore are taken by surface trollers of Chile and New Zealand.

As part of the general eastward expansion of the Japanese longline fishery after World War II, Japanese longliners began fishing in the western South Pacific in 1952, principally for yellowfin tuna. In 1954, a small fleet of Japanese longliners based at American Samoa began fishing for tunas to supply an American tuna cannery in Pago Pago. The Japanese also established a base in 1958 at Espiritu Santo, New Hebrides, and in 1963 at Fiji. A base for foreign longliners has also been established at Tahiti. The geographical boundaries of the fishery in the South Pacific, based on Japanese longline fishing operations from 1952 to 1976, extends from the equator to approximately 45°S latitude between 135°E and 80°W longitude (Figure 1).

I.B. Trends in Catch and Effort

The estimated total annual catch of South Pacific albacore from 1952 to 1978 ranged between 210 and 49,275 mt (metric tons) (Table 1). The catch rose rapidly from 210 mt in 1952 to 39,479 mt in 1962, and has since fluctuated, reaching a low of 24,975 mt in 1963 and a high of 48,691 mt in 1973 (Figure 2). However, longline catch data are often available only in number of fish caught, or may be incomplete in other ways; therefore, the total catch in weight for Japan, Korea, and Taiwan is estimated (Wetherall et al.¹).

The total number of longliners based at Pago Pago increased from 18 in 1954 to 344 in 1973, with Korean and Taiwanese boats gradually replacing Japanese vessels during this period (Table 2). Since 1973 the total number of vessels has declined to the present level of about 200. Total fishing days by Taiwanese vessels reached a peak of 22,028 in 1973, but has declined to less than 10,000 in recent years (Table 3). Comparable values for Korean longliners are 27,111 and 16,000 fishing days,

¹Wetherall, J. A., F. V. Riggs, and M. Y. Y. Yong. 1979. Assessment of the South Pacific albacore stock. SWFC Admin. Rep. H-79-6, Natl. Mar. Fish. Serv., NOAA, Honolulu, Hawaii, 41 p. Prepared for the Workshop on the Assessment of Selected Tunas and Billfish Stocks in the Indian and Pacific Oceans, Shimizu, Japan, 13-22 June 1979.

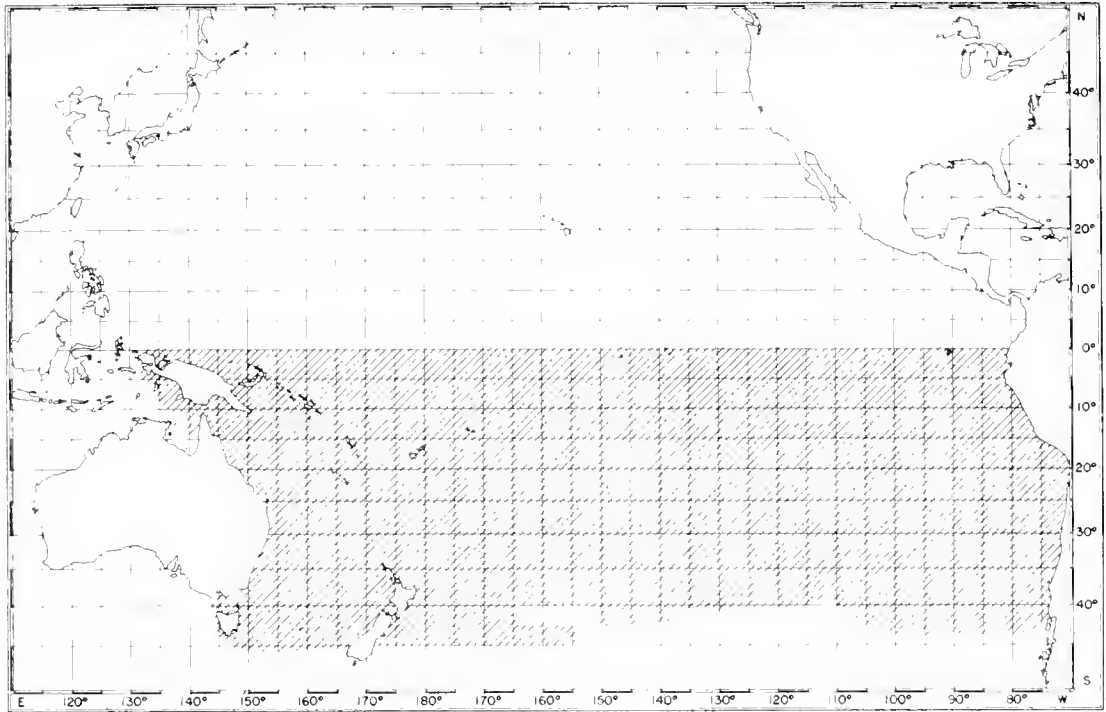

Figure 1.--The geographical boundaries of the South Pacific longline fishery for albacore. (Adapted from Wetherall et al. see text footnote 1.)

Table 1.--Estimated total catches in metric tons of South Pacific albacore, 1952-78. The 1978 estimates are preliminary.

Column	1	2	3	4	5	6	7
Year	Japan	Taiwan	Japan and Taiwan	R	Korea	Other	Total
1952	210	--	210	--	--	--	210
1953	1,091	--	1,091	--	--	--	1,091
1954	10,200	--	10,200	--	--	--	10,200
1955	8,420	--	8,420	--	--	--	8,420
1956	6,220	--	6,220	--	--	--	6,220
1957	9,764	--	9,764	--	--	--	9,764
1958	21,558	--	21,558	--	146	--	21,704
1959	19,344	--	19,344	--	456	--	19,800
1960	23,756	--	23,756	--	610	--	24,366
1961	25,628	--	25,628	--	330	--	25,958
1962	38,880	0	38,880	0.0154	599	--	39,479
1963	33,500	608	34,108	0.0400	1,367	--	35,475
1964	21,435	629	22,064	0.1319	2,911	--	24,975
1965	19,305	1,640	20,945	0.3058	6,405	100	27,450
1966	23,401	6,669	30,070	0.3597	10,817	500	41,387
1967	16,640	14,910	31,550	0.4347	13,717	105	45,371
1968	7,707	14,496	22,203	0.4566	10,138	14	32,355
1969	5,559	9,883	15,442	0.6451	9,963	--	25,405
1970	6,560	12,463	19,023	0.6097	11,599	50	30,672
1971	4,339	21,584	25,923	0.5586	14,482	200	40,605
1972	2,796	23,050	25,846	0.5586	14,439	468	40,753
1973	2,381	28,858	31,239	0.5586	17,452	584	49,275
1974	1,847	19,980	21,827	0.5586	12,194	390	34,911
1975	1,045	15,092	16,137	0.5586	9,015	646	25,798
1976	1,906	19,954	21,860	0.5586	12,212	25	34,097
1977	2,240	21,345	23,585	0.5586	13,176	621	37,381
1978	--	--	--	--	--	1,639	40,500

Comments:

- Column 1 - Japanese longline catch in metric tons, courtesy of S. Ueyanagi, Far Seas Fisheries Research Laboratory.
- Column 2 - Catch by Taiwan's high-seas longliners (>50 GT) based at foreign ports, estimated from published Taiwan catch statistics and average weights of albacore landed at Pago Pago.
- Column 3 - Column 1 plus column 2.
- Column 4 - R is ratio of Korean catch of South Pacific albacore to total catch of this species by Japan and Taiwan, estimated from data in Skillman (1975).
- Column 5 - Column 3 x column 4, except for 1958-61, which are from American Samoa cannery records.
- Column 6 - Includes catch by Chile and New Zealand.

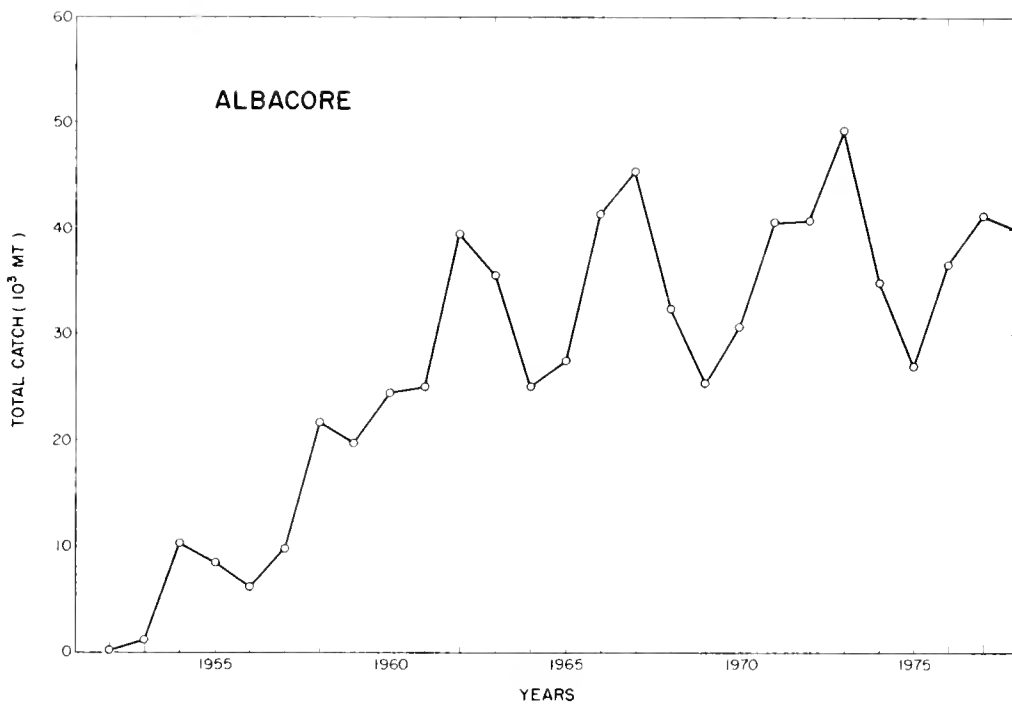

Figure 2.--Total catch of albacore in the South Pacific longline fishery, 1952-78. (Data from Wetherall et al. see text footnote 1.)

Table 2.--Number of longline vessels based at Pago Pago, American Samoa, by nationality, 1954-80.

Year	Number of vessels				Total
	Japan	Taiwan	Korea	Undetermined	
1954	17	--	--	1	18
1955	50	--	--	--	50
1956	56	--	--	--	56
1957	61	--	--	1	62
1958	76	--	2	1	79
1959	64	--	4	1	69
1960	60	--	3	1	64
1961	55	--	2	1	58
1962	79	--	5	1	85
1963	117	--	10	1	128
1964	94	11	16	--	121
1965	101	23	33	--	157
1966	79	76	55	--	210
1967	62	128	69	--	259
1968	39	110	85	--	234
1969	18	71	76	--	165
1970	9	115	81	--	205
1971	4	124	90	--	218
1972	2	135	95	--	232
1973	--	172	172	--	344
1974	--	149	171	--	320
1975	--	77	135	--	212
1976	--	93	119	--	212
1977	--	88	114	--	202
1978	--	85	113	--	198
1979					~200
1980					~200

Table 3.--Estimated number of vessel trips, fishing days per trip, and total fishing days for longliners based at American Samoa, 1954-78.

Year	Japan			Taiwan			Korea		
	Days/ trip	Trips	Days	Days/ trip	Trips	Days	Days/ trip	Trips	Days
1954	--	58	--	--	--	--	--	--	--
1955	--	142	--	--	--	--	--	--	--
1956	--	262	--	--	--	--	--	--	--
1957	17.4	263	4,576	--	--	--	--	--	--
1958	21.1	330	6,963	--	--	--	22.6	7	158
1959	24.4	287	7,003	--	--	--	26.7	14	374
1960	23.3	283	6,594	--	--	--	23.0	44	1,012
1961	21.5	260	5,590	--	--	--	25.0	8	200
1962	22.0	349	7,678	--	--	--	24.9	40	996
1963	24.6	423	10,406	--	--	--	30.9	69	2,132
1964	27.5	277	7,618	23.2	27	626	27.4	69	1,891
1965	30.7	275	8,442	27.6	97	2,677	34.2	165	5,643
1966	32.1	229	7,351	27.5	295	8,112	41.6	246	10,234
1967	35.7	202	7,211	33.0	355	11,715	44.3	241	10,676
1968	39.6	100	3,960	40.3	267	10,760	47.5	214	10,165
1969	38.7	47	1,819	38.9	213	8,286	47.3	289	13,670
1970	37.9	26	985	40.4	326	13,170	46.7	289	13,496
1971	40.2	13	523	45.3	328	14,858	54.5	282	15,369
1972	29.8	4	119	46.8	350	16,128	54.4	349	18,986
1973	--	--	--	52.2	422	22,028	56.6	479	27,111
1974	--	--	--	55.4	327	18,116	47.6	422	20,087
1975	--	--	--	62.5	134	8,375	55.8	262	14,620
1976	--	--	--	59.2	152	8,998	57.6	276	15,898
1977	--	--	--	39.6	231	9,152	47.2	258	12,174
1978	--	--	--	36.3	136	4,932	38.0	292	11,122

respectively. Korean effort is centered in the lower latitudes of the South Pacific and in the equatorial region where a substantial part of the catch is bigeye tuna and yellowfin tuna, whereas the Taiwanese vessels concentrate on albacore grounds further south.

I.C. Value of Catch

Except for a decline in 1975, the mean annual ex-vessel value of albacore landings in the American Samoa longline fishery rose from a low of \$426 per short ton in 1969 to \$1,358 per short ton in 1978 (Figure 3).

I.D. Current Management of the Fishery

II. NATURE AND SIGNIFICANCE OF U.S. AND FOREIGN PARTICIPATION IN THE FISHERY

In 1953, a California seafood company obtained a lease from the Department of the Interior for a small tuna cannery in Pago Pago and began taking deliveries of tuna from Japanese longliners under contract. This marked the beginning of the tuna longline fishery in the South Pacific (Otsu 1966). In 1963 a second U.S. firm began operating a tuna canning plant in American Samoa. American interests are also involved in a joint venture with French companies in operating a tuna transshipping base at Tahiti.

Albacore landed at American Samoa represented an estimated 78% of the catch of this species in the South Pacific in 1970, but normally vessels based at Pago Pago account for only 30 to 60% of the harvest (Figure 4).

III. STATUS OF THE STOCKS

III.A. Stock Structure

South Pacific albacore are considered to be a distinct subpopulation confined to the current systems of the Southern Hemisphere. There is no evidence of intermingling with North Pacific albacore stock(s), and no evidence of multiple subpopulations within the South Pacific.

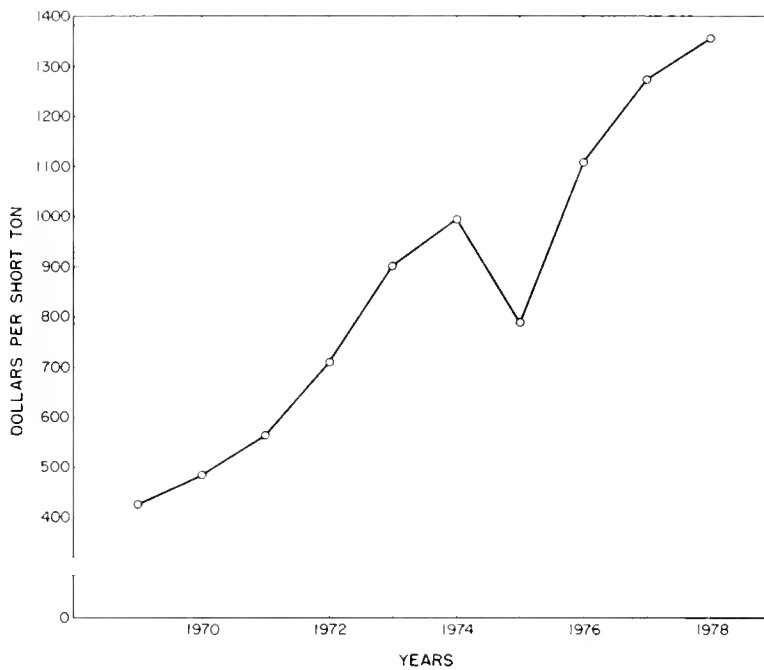

Figure 3.--Ex-vessel value of albacore in the American Samoa longline fishery. (Data from [U.S.] National Marine Fisheries Service 1969-1978.)

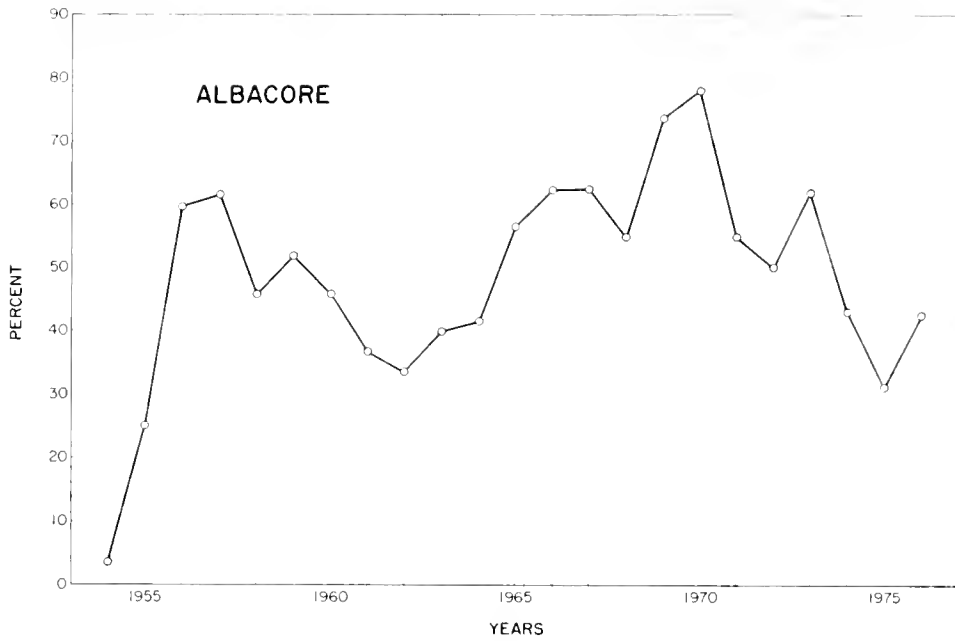

Figure 4.--Fraction of the estimated total South Pacific longline catch of albacore landed at American Samoa, 1954-76. (Data from Wetherall et al. see text footnote 1.)

III.B. Stock Assessment and Fishery Evaluation

III.B.1. Trends in Catch-per-Unit-Effort

Annual indices of abundance based on catch per 1,000 hooks by longliners based at Pago Pago and adjusted for changes in spatial distribution of nominal fishing effort (Wetherall et al. 1979; see footnote 1) show a fairly steady decline in catch-per-unit-effort from the beginning of the index period in 1962 to 1974 (Table 4). Since 1975 the catch-per-unit-effort has steadily increased.

III.B.2. Results of Production Model Analysis

The most recent production model analysis of the South Pacific albacore fishery was based on the abundance index and effective effort statistics displayed in Table 4 (Wetherall et al. 1979; see footnote 1). The Gulland procedure for approximating equilibrium effort was used. The results, shown in Figure 5, suggest that further expansion of the longline fishery would be unproductive. Indeed, it may be possible to reduce effort substantially with little reduction in catch. The MSY (maximum sustainable yield) of the longline fishery was estimated to be about 35,000 mt.

III.B.3. Results of Yield-per-Recruit Analysis

No cohort analyses have been attempted with South Pacific albacore due to the extreme difficulty of separating year-classes in the longline catch. Furthermore, no yield-per-recruit analysis has been done, in the usual sense, but a simulation model linking a yield-per-recruit model with alternative stock-recruitment hypotheses has been explored (see Section III.B.5).

III.B.4. Results of Spawner/Recruitment Analyses

No analysis of the spawner-recruit process has been done, nor are data available which would permit such a study. Wetherall et al. (see footnote 1) estimated the average recruitment of 2 year-old albacore to be 8.4 million fish. Average spawning stock (fish over 5 years old) corresponding to this average recruitment, in the absence of fishing and with growth and natural mortality rates as given by Wetherall et al., is about 130,000 mt (see Section III.B.5).

III.B.5. Results of Other Analyses/Simulations

An age-structured simulation model was constructed by Wetherall et al. to study the response of maximum sustainable yield of the

Table 4.--Index of abundance (kg/100 hooks), and estimated total effective effort (10^6 hooks) for the South Pacific albacore fishery.

Year	Abundance index (kg/100 hooks)	Effective effort (10^6 hooks)
1962	146.00	27
1963	85.76	41
1964	75.39	33
1965	72.02	38
1966	63.66	65
1967	42.56	107
1968	33.76	96
1969	41.03	62
1970	35.42	87
1971	29.90	136
1972	21.45	190
1973	20.19	244
1974	13.86	252
1975	13.64	198
1976	18.00	203
1977	21.71	191

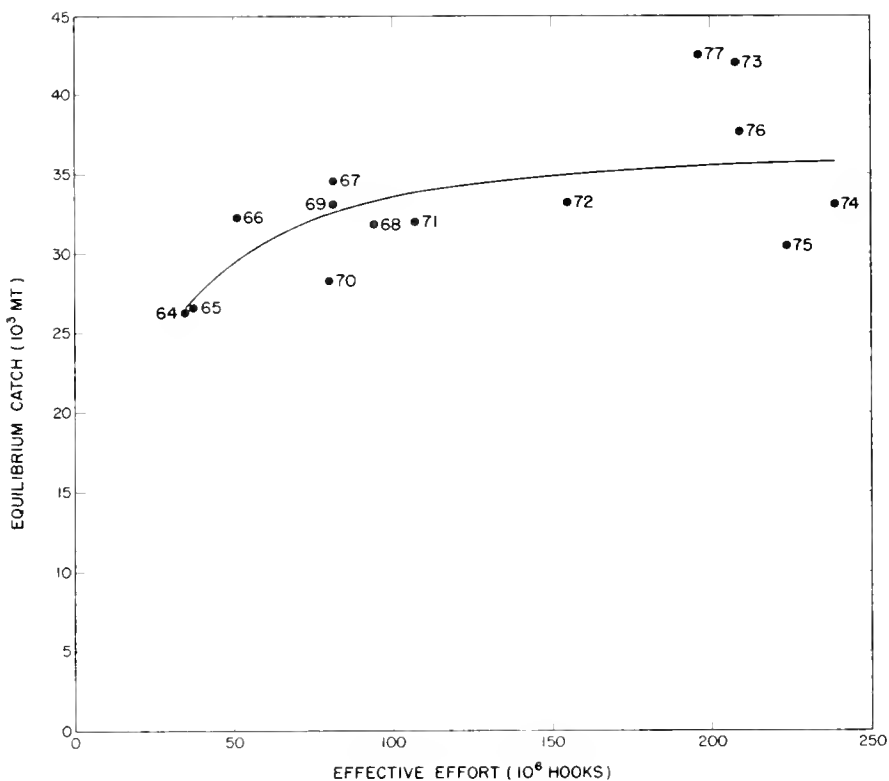

Figure 5.--Projected relationship between equilibrium yield and effective effort for South Pacific albacore, based on production model with 3-yr effort averaging. (From Wetherall et al. see text footnote 1.)

albacore stock to changes in age at-first-capture under a variety of stock recruitment hypotheses. Under constant recruitment, MSY was judged to be about 38,000 mt at an age-of-first-capture of 4 years, but MSY at 3-year or 5-year minimum age limits was only slightly less. Under more conservative stock-recruitment hypotheses, lower MSY's were computed and were achieved at progressively higher ages-at-first-capture. The results of the simulation analysis are considered to be preliminary.

III.C. Current Evaluation of Stocks and the Fishery

The South Pacific albacore stock is considered to be in a healthy condition. Catch-per-unit-effort in the longline fishery has been reduced considerably to perhaps 20% of its initial level, but unless recruitment is strongly dependent on size of spawning stock, such a reduction can be sustained. There is no indication of recruitment failure. Following its peak in 1973 the nominal effort has been reduced. Catch rates have increased; therefore, average annual catch has increased in spite of lower effort. Further reduction in longlining effort should be beneficial.

Expansion of surface fisheries may be feasible. Indeed, Japanese baitboats are known to be considering exploratory albacore fishing expeditions in the region of the subtropical convergence east of New Zealand (Shiohama 1979).

IV. STATUS OF CURRENT RESEARCH NEEDS AND EFFORTS

IV.A. Major Research Problems

Evaluation of potentials for expanding surface fisheries on South Pacific albacore is an important area for research. This would require 1) theoretical studies of stock productivity using age-structured simulation models, 2) possible tagging of 2- and 3-year old albacore available to development of the surface gear, 3) evaluation of recapture rates in the longline fishery, and 4) methodology to predict surface fishery potentials using the wealth of observations on the subsurface longline operations.

IV.B. Current Research Efforts

Current work on South Pacific albacore by the SWFC includes:

- 1) Improving the data base for South Pacific albacore through a general upgrading of the American Samoa catch-per-unit-effort and landings statistics.

2) Development of a fishery monitoring and information system for South Pacific albacore.

3) Evaluation of procedures to estimate surface fishery potentials using the age-structured simulation model and production model analyses based on selected segments of the population. Preliminary work was done in April and May of 1980 and will be continued in FY 1981.

IV.C. Future Research Needs

None proposed at this time.

IV.D. Status of SWFC Data Base

The Far Seas Fisheries Research Laboratory has maintained albacore catch statistics of Japanese longliners fishing in the South Pacific since 1952. The governments of Taiwan and Korea also compile data on their respective flag vessels fishing in the South Pacific. Some of these data, and data from the fishery based at American Samoa, are available on tapes in the files of the Honolulu Laboratory. Data on surface catches are available from FAO and the New Zealand Government.

Logbook systems maintained by Japan, Korea, and Taiwan provide data on catch in number of fish, effort in number of hooks fished, and locality fished for each day of fishing. The government of American Samoa also collects logbook data providing the same kinds of data from vessels based at Pago Pago. Data on the size composition of the catches are collected by the governments of Japan, Taiwan, and American Samoa. In addition, the Honolulu Laboratory maintains files of landings statistics provided by the two canneries in American Samoa.

The quality of logbook data is probably adequate for production model analyses. The quality of the size-composition data is inadequate, since time and location of capture cannot be accurately determined. Owing to changes in unloading procedures at the tuna canneries, sex and weight determinations were discontinued in 1970, but length-frequency data are still being collected in American Samoa.

LITERATURE CITED

- Otsu, T.
1966. The South Pacific long-line fishery for albacore tuna,
1954-64. *Commer. Fish. Rev.* 28(7): 9-12.

Shiohama, T.

1979. Considerations on the pole fishing in the longline filleted skipjack ground of albacore. [In Jpn.] Bull. Jpn. Soc. Fish. Oceanogr. 34: 170-173.

Skillman, R. A.

1975. An assessment of the South Pacific albacore, Thunnus alalunga, fishery, 1953-72. U.S. Natl. Mar. Fish. Serv., Mar. Fish. Rev. 37(3): 9-17.

[U.S.] National Marine Fisheries Service.

1969-1978. Foreign fishery information release. Supplement to Market News Report.

STATUS REPORT: NORTH PACIFIC ALBACORE

by

Earl Weber

Southwest Fisheries Center
Oceanic Fisheries Resources Division
La Jolla, California

ABSTRACT

The North Pacific albacore stock is harvested primarily by the Japanese surface and longline, and North American surface fleets. Catches of these fleets have been in the vicinity of 100,000 mt in recent years, with a record catch of nearly 124,000 mt in 1976. The North American surface fishery, comprised primarily of U.S. troll vessels, landed an annual average catch of approximately 20,000 mt during the period of 1969 through 1978 but landed less than 5,000 mt in 1979. The U.S. imports an additional 80,000 to 90,000 mt of albacore to meet domestic demand and a substantial part of this originates from the North Pacific stock.

Although heavily harvested, the stock is considered healthy. Effort levels in recent years have been below those required to produce maximum average sustainable yields (MASY). Yield-per-recruit (Y/R) analyses indicated a decrease in Y/R following the expansion of the Japanese surface fishery. Slight gains in Y/R are possible through increased effort on larger fish but substantial gains are unlikely with the fishery in its present configuration. Catch rates for all three major fleets have shown gradual decreasing trends.

I. DESCRIPTION OF THE FISHERY

I.A. History of Fishery

Albacore (Thunnus alalunga) is a single species found world-wide in most temperate ocean areas. In the Pacific Ocean, north and south stocks, separated near the equator, are thought to exist.

The North Pacific stock is fished by three major fleets: the Japanese surface fleet, the predominantly Japanese longline fleet, and the North American surface fleet. The Japanese skipjack pole-and-line fleet, which has been operating during the spring months since the 1920's, began expanding its operations offshore along the Kuroshio front in the early 1970's. As a result, it has substantially increased its catches, particularly of two- and three-year-old albacore. The longline fishery, comprised primarily of Japanese vessels with some from Taiwan and Korea, has been operating in the mid- to western north Pacific during the winter months since the early 1950's. The North American surface fleet consists primarily of U.S. vessels with some Canadian vessels. This fleet, mostly jigboats or trollers with some baitboats, has been fishing off the coast of North America since about 1900.

I.B. Trends in Catch and Effort

Yearly catches, by country and gear type, are shown in Table 1 for 1940-1978. Data are missing for some countries prior to 1961, but the remainder of the series is considered to be essentially complete. Catches for the Japanese surface, Japanese longline, and North American surface fleets, and the combined total catches, are shown in Figure 1 for 1961-1978. During 1961-1974, the total catch increased, particularly in the early 1970's, with a record catch of 114,858 mt in 1974. The catch declined to 86,327 mt in 1975 but rose to a new record of almost 124,000 mt in 1976. Total catches have decreased since 1976. The trends in the total catch in the 1970's reflect changes in the Japanese surface fishery, which became the major producer during this period. The Japanese longline fishery catches decreased from 1967 through 1975, and have increased only slightly since then. The North American fishery catches, characterized by periodic increasing and decreasing trends, have been declining since 1972. Preliminary data indicate a 1979 catch of 4,938 mt, one of the poorest years on record.

Table 1. Catches for North Pacific albacore in tons, 1940-1979.

Year	Japan ²			Taiwan		United States ²		Canada	Total ³
	Pole-and-line	Longline	Other Gear	Longline	Inshore	Pole-and-line	Jig		
1940									
1941									2
1942									34
1943									-
1944									13
1945									210
1946									648
1947									17,800
1948									10,950
1949									196
1950									362
1951	16,463								22,516
1952	41,386	26,687	237						22,516
1953	32,921	27,777	132						987
1954	28,069	20,958	38						1,012
1955	24,236	16,277	136						961
1956	42,810	14,341	57						86
1957	49,500	21,053	151						71
1958	22,175	18,452	124						23,843
1959	14,252	15,502	67						15,740
1960	23,156	17,369	76						171
1961	18,636	17,437	268						147
1962	8,729	15,764	191						147
1963	26,420	13,464	218						577
1964	23,858	15,458	319						482
1965	41,491	13,701	121						304
1966	22,830	25,050	585						48
1967	30,481	28,869	520						20,990
1968	16,597	23,961	1,109						20,100
1969	31,912	18,006	1,675						12,054
1970	24,263	15,372	1,069						19,753
1971	52,957	10,915	1,623	26					25,142
1972	60,591	12,622	1,120	16					18,389
1973	69,640	16,000	2,152	16					16,461
1974	73,576	12,952	1,390	16					15,169
1975	52,157	9,931	697	16					17,814
1976	85,336	15,738	2,622	16					17,814
1977	31,934	15,512	1,952	28					20,441
1978 ⁴	59,817	12,888	7,411	37					18,826
1979 ⁵	43,000	-	-	46					21,039

¹ Japanese longline catch for 1961-68 excludes minor amount taken by vessels under 20 gross tons. Longline catch in weight is estimated by multiplying annual number of fish caught by an average weight statistic.
² United States pole-and-line catch excludes minor amount taken by vessels not submitting log books to IATTC; this amount is included in the jig catch.
³ Omitted are unknown but minor catches by longline and pole-and-line vessels of the Republic of Korea and Taiwan.
⁴ 1979 figures are preliminary.
⁵ All gears 1940-1960 added together.
⁶ Estimated minimum based on partial coverage rate.

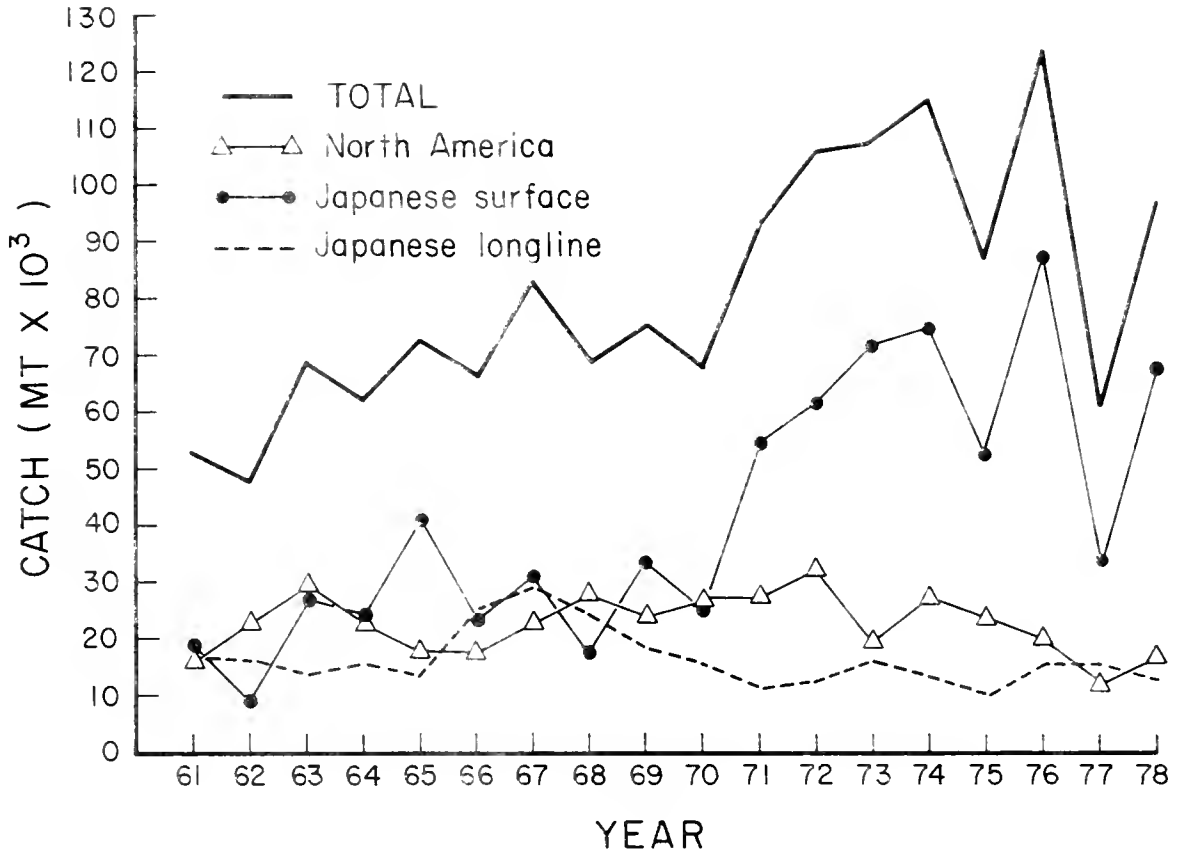

Figure 1. Yearly catches of North Pacific albacore, by weight, by the Japanese surface, Japanese longline, North American surface fishery and the total catches for years 1961 to 1978.

Yearly effort for the Japanese surface, Japanese longline, and U.S. surface fisheries are shown in Figure 2. Units of effort among fisheries cannot be compared because effort has not been successfully standardized; therefore, no attempt is made here to describe trends in total effort.

Effort in the Japanese pole-and-line fishery, currently the major producer, increased substantially in the 1970's. Effective effort in the Japanese longline fishery decreased dramatically from 1967 through 1975, then increased slightly in years 1976 through 1978. Effort in the U.S. fishery was reasonably constant throughout the 1960's but more than tripled between 1970 and 1972. This apparent change may be partially an artifact of changes in the statistical reporting system. Effort from 1973 through 1977 appears to be stable at a level well below that reported for 1972, but above that for the 1960's.

I.C. Value of the Catch

The U.S. fleet landed an annual average of 20,400 mt of albacore between 1969 and 1978. At current ex-vessel prices (\$1800/mt), the average annual catch was worth \$37 million.

I.D. Current Management of the Fishery

There is currently no organization responsible for the management of fisheries for North Pacific albacore.

II. NATURE AND SIGNIFICANCE OF U.S. AND FOREIGN PARTICIPATION IN THE FISHERY

Albacore, which is generally canned in water and marketed as white meat tuna, is a popular product in the U.S. The U.S. surface fishery currently consists of more than 900 vessels; from 1969 to 1978, these vessels landed an annual average of 20,440 mt worth an average of \$37 million (ex-vessel) at current prices. Because demand exceeds supply, 80% of the total U.S. demand is typically imported from as many as 40 countries; an estimated 40% to 45% of the imports originate from the Pacific, historically the most heavily harvested ocean (Figure 3). Although the exact proportions of the Pacific imports that originate in the North Pacific are not known, they may be as high as 75% in some years.

In recent years some U.S. fishermen have begun fishing in the vicinity of Midway Island, where they have experienced high catch rates. Foreign participation has also increased. The Japanese surface fishery became the major producer of North Pacific albacore in the early 1970's,

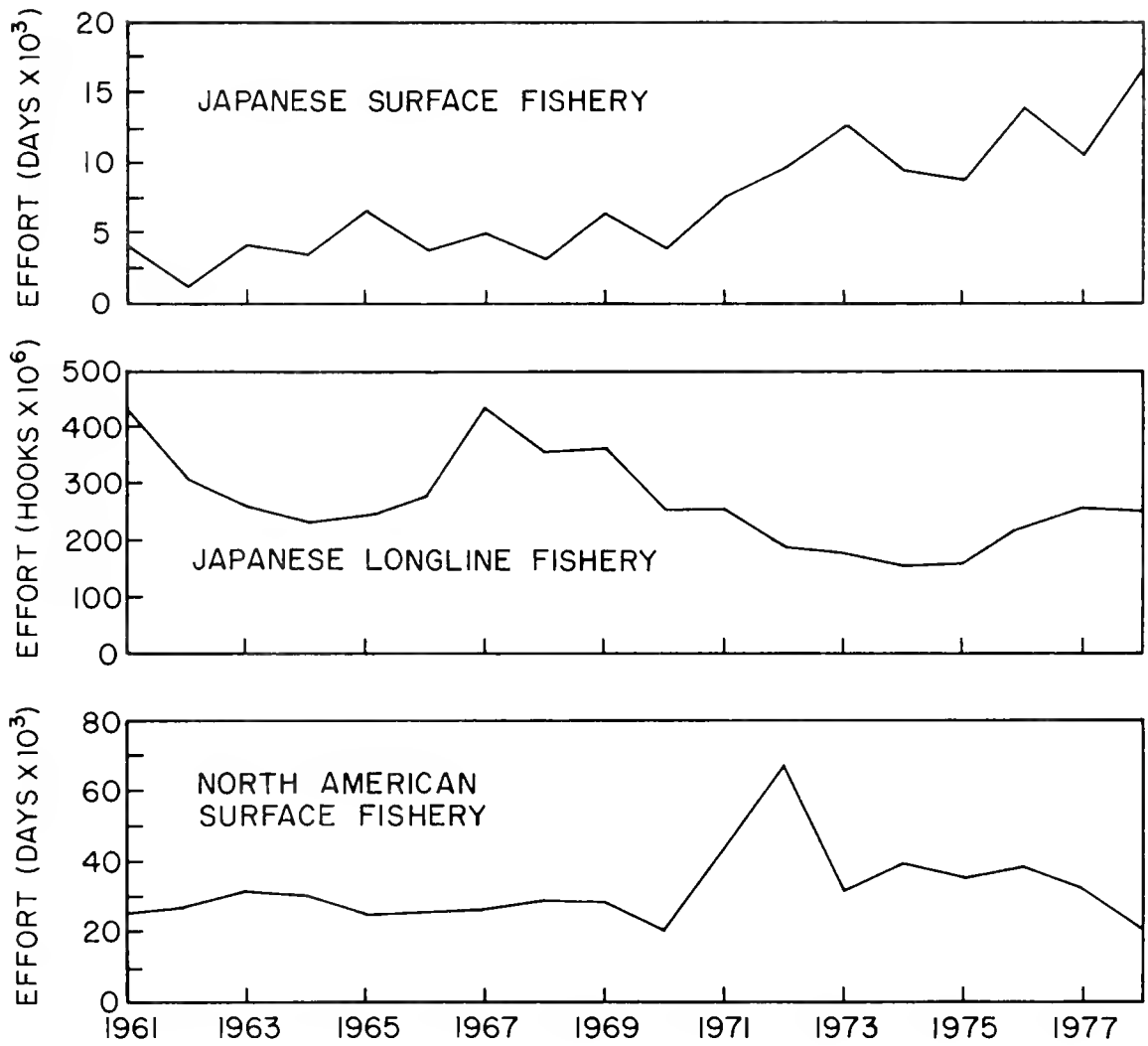

Figure 2. Yearly effort in the Japanese surface, Japanese longline, and North American surface fishery for years 1961 to 1978.

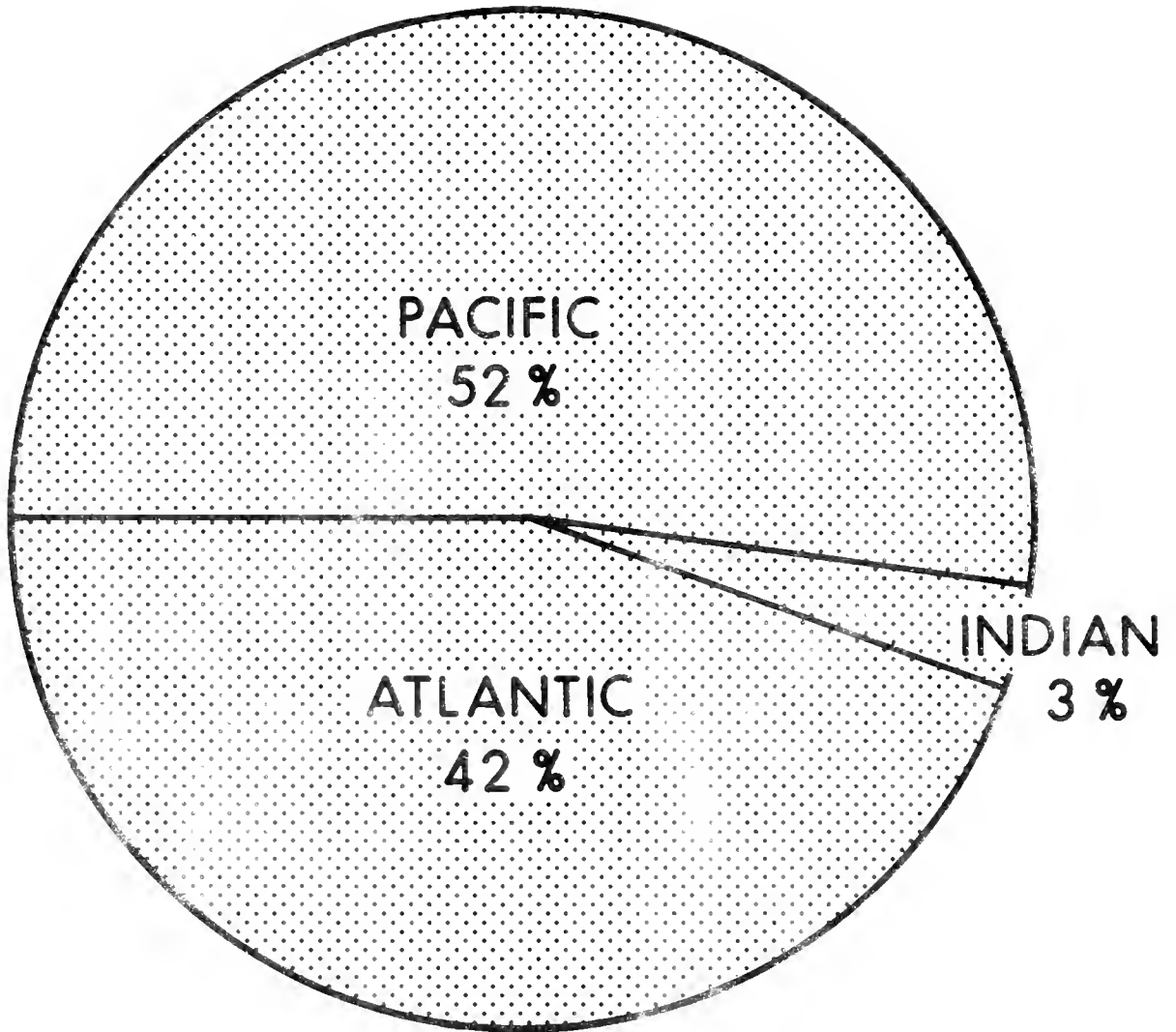

Figure 3. Percentages, by weight, of albacore caught by ocean in 1977.

when it expanded its pole-and-line operations offshore along the Kuroshio front. The developing Japanese coastal gill net fishery has also begun reporting catches of North Pacific albacore, as have the longline fleets of Taiwan and Korea which have recently begun fishing in the North Pacific.

III. STATUS OF THE STOCKS

The status of North Pacific albacore was assessed by participants attending the Fifth North Pacific Albacore Workshop held in June and July 1980.

III.A. Stock Structure

The Pacific albacore population is assumed to be composed of north and south stocks separated near the equator. The complex migratory patterns of juveniles within the north stock have led some scientists to hypothesize that more than one stock exists in the North Pacific, but not enough is currently known about the migration of adults to substantiate this hypothesis; therefore, a single north stock is assumed.

III.B. Stock Assessment and Fishery Evaluation

III.B.1. Trends in Catch-per-Unit-Effort

Because of difficulties associated with standardizing effort among the different gears, an overall index of abundance for the entire fishery is not available. However, catch-per-unit-effort (CPUE) for the Japanese surface, Japanese longline, and U.S. surface fisheries (Figure 4) have all shown decreasing trends in recent years.

III.B.2. Results of Production Model Analysis

Production model analysis is also problematic due to the effort standardization problem. An analysis prepared for the albacore workshop (Figure 5) predicted a maximum sustainable average yield (MSAY) of between 104,000 and 236,000 mt. Although it is impossible to select a "best" value, the midpoint of 170,000 mt may be reasonable.

III.B.3. Results of Yield-per-Recruit Analysis

Yield-per-recruit (Y/R) analyses indicate that the expansion of the Japanese surface fishery in the early 1970's decreased the Y/R for the entire fishery (Figure 6). While the Y/R for the Japanese

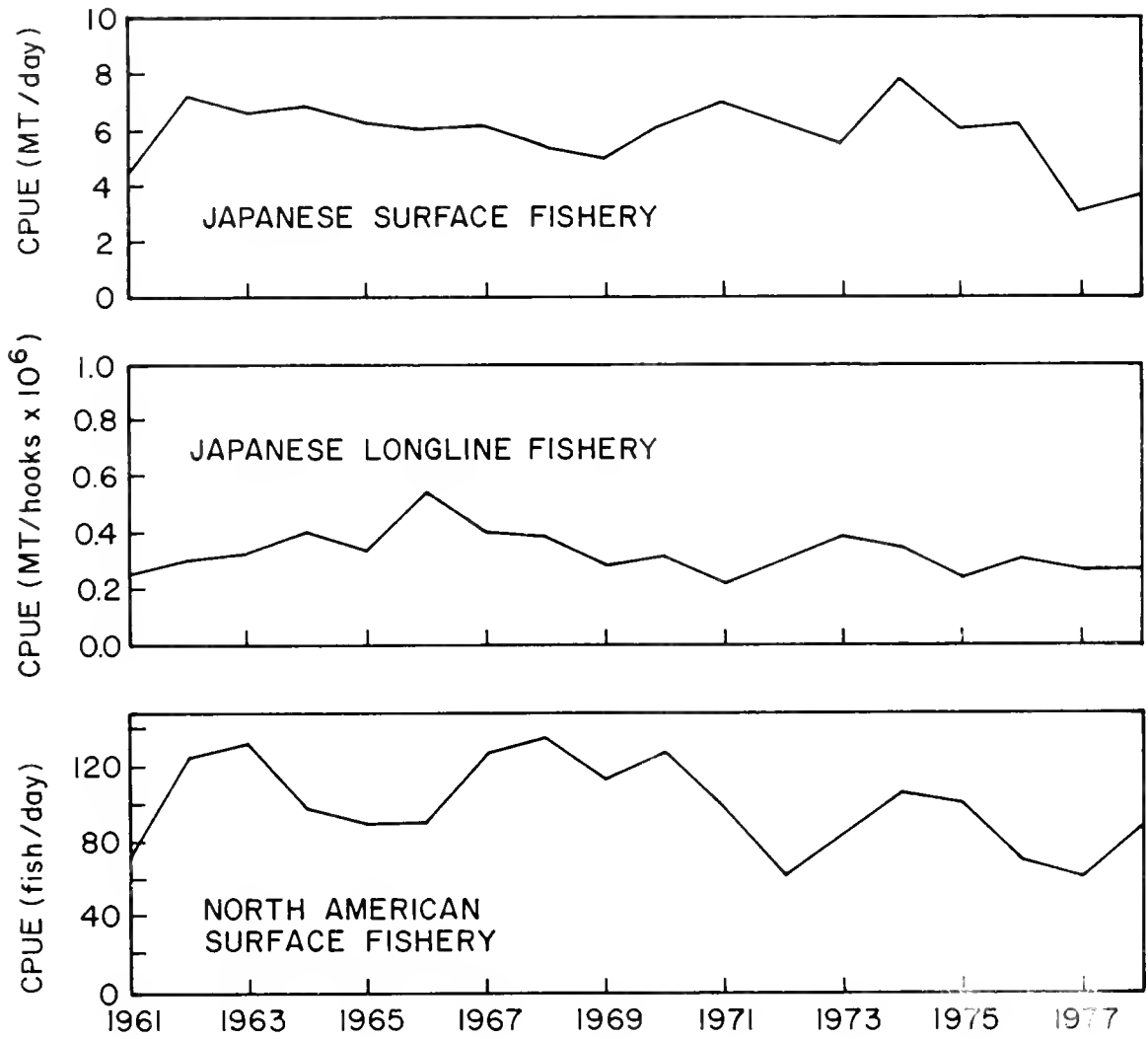

Figure 4. Yearly catch rates of North Pacific albacore in the Japanese surface, Japanese longline and North American surface fishery for years 1961 to 1978.

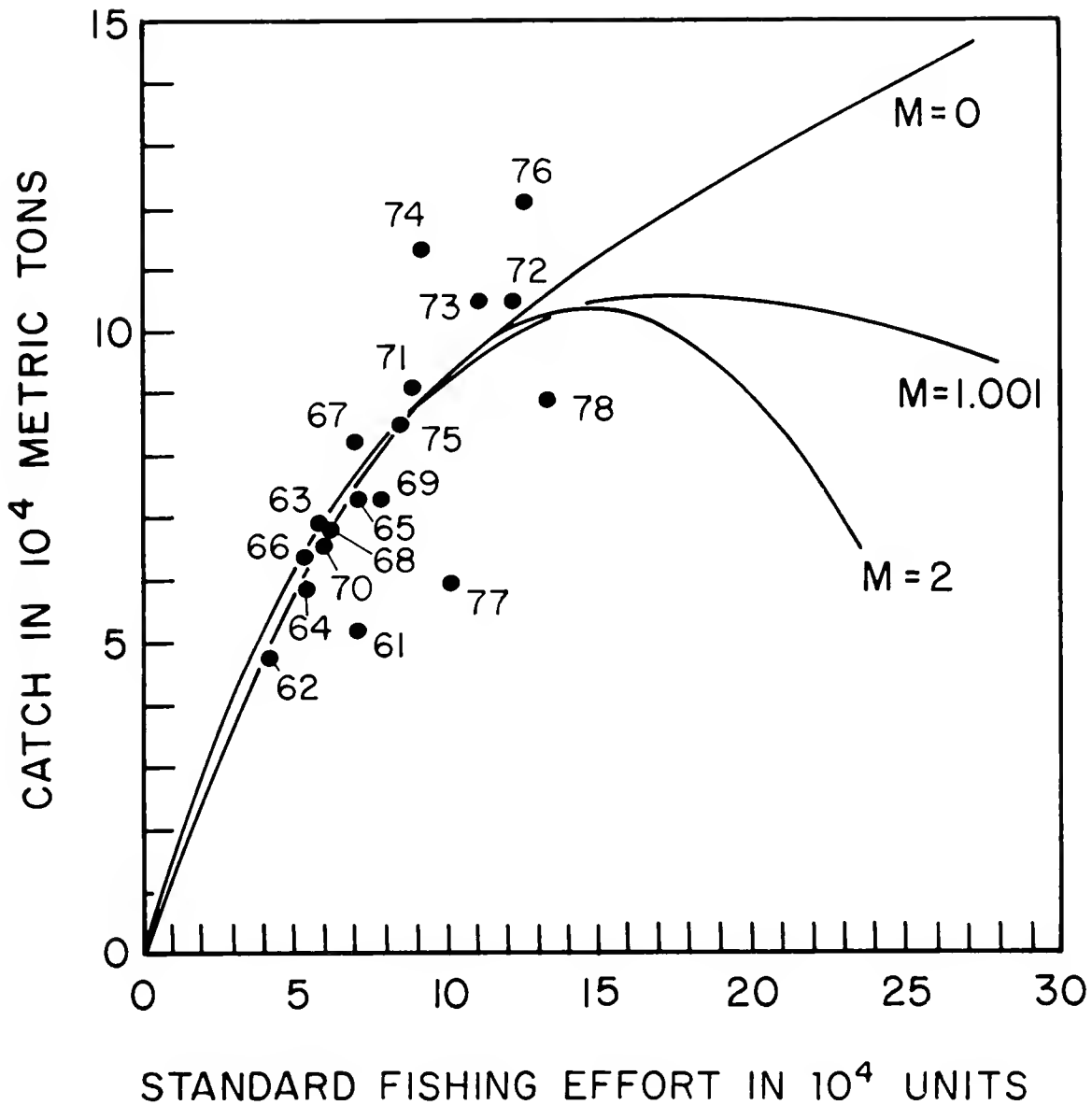

Figure 5. Equilibrium yield curves and observed data for North Pacific albacore, years 1961 to 1978.

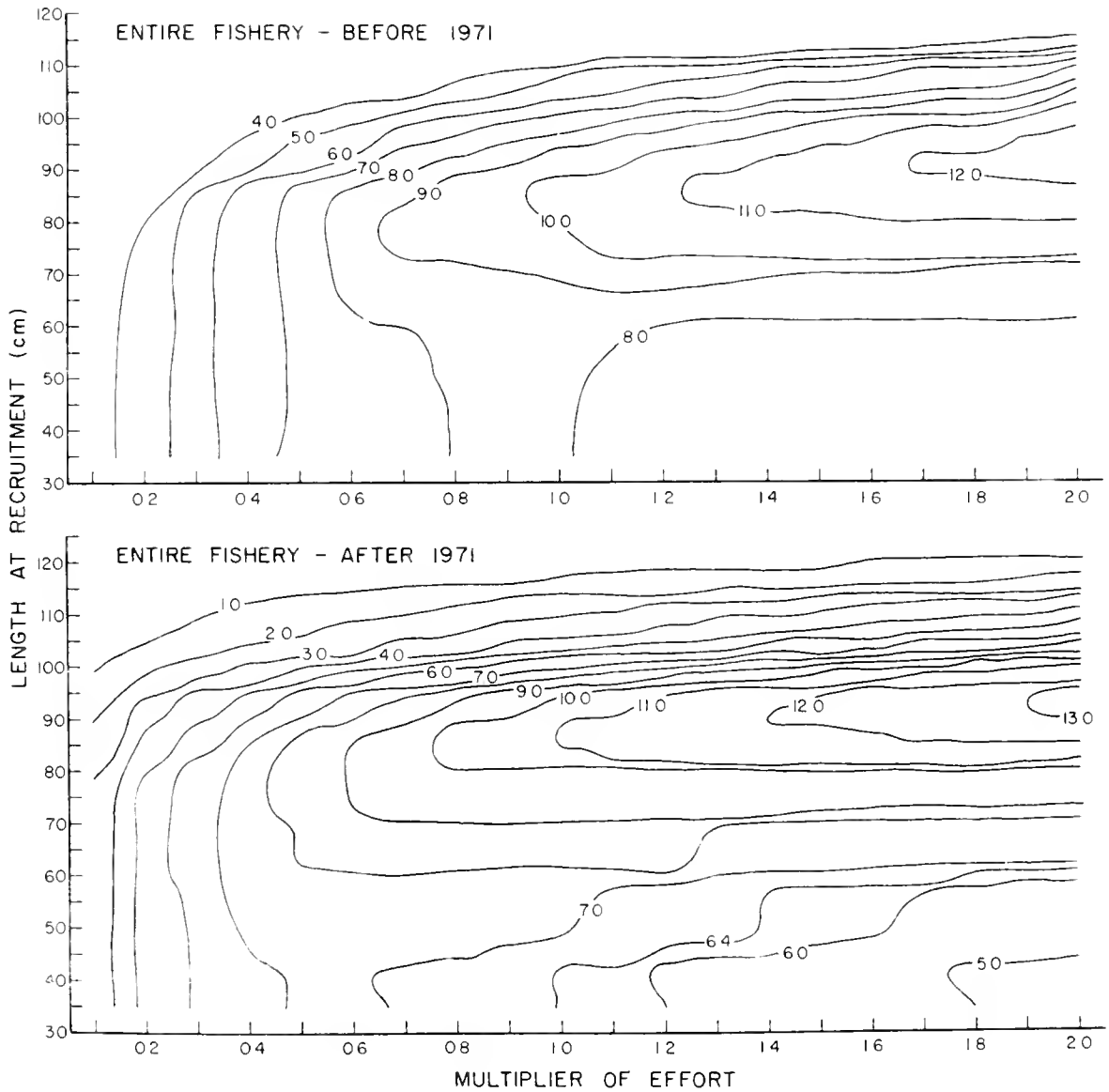

Figure 6. Estimated yield-per-recruit, as functions of age at recruitment and fishing mortality vector multiplier, of North Pacific albacore taken before and after 1971 by all gears combined.

surface fishery increased, the gains were not enough to offset the decreases in Y/R for the longline and North American surface fisheries. The analyses predicted that gains in Y/R were possible through increased effort on larger fish. Y/R isopleths for the Japanese surface, Japanese longline, and North American surface fishery are shown in Figures 7, 8, and 9, respectively.

III.B.4. Results of Spawner/Recruitment Analysis

No satisfactory spawner/recruit relationship has been established. Previous analyses have failed to develop appropriate indices of spawner and recruit abundance.

III.B.5. Results of Other Analyses/Simulations

Additional analyses have shown very poor correlation between indices of abundance among the three major fisheries, even when annual age specific catch rates were used.

III.C. Current Evaluation of Stocks and the Fishery

At present North Pacific albacore are being fished at effort levels below those that permit harvest at MSAY. Modest gains in Y/R are possible through increased effort on older fish, but substantial increases are unlikely given the present patterns of fishing. There is currently no evidence to indicate a depletion of the adult (spawner) stock.

IV. STATUS OF CURRENT RESEARCH NEEDS AND EFFORT

IV.A. Major Research Problems

The most immediate research needs include: 1) Development of non-effort based assessment methods to augment the existing analytical models; 2) validation of currently accepted growth rate of North Pacific albacore, which are determined from daily otolith increments using a newly developed fin ray technique; 3) re-examination of the population dynamics of the stock in the light of recent and future improvements in parameter estimation; 4) investigation of stock structure through differences in bio-chemical information among fish from different areas, through the study of oceanic phenomena that might explain stock separation and through the development of a model to test various stock structure hypotheses; and 5) the identification and quantification of environmental variables for input into an environmental simulation model designed to explain variability in catch levels and catch rates, among and within the major fisheries.

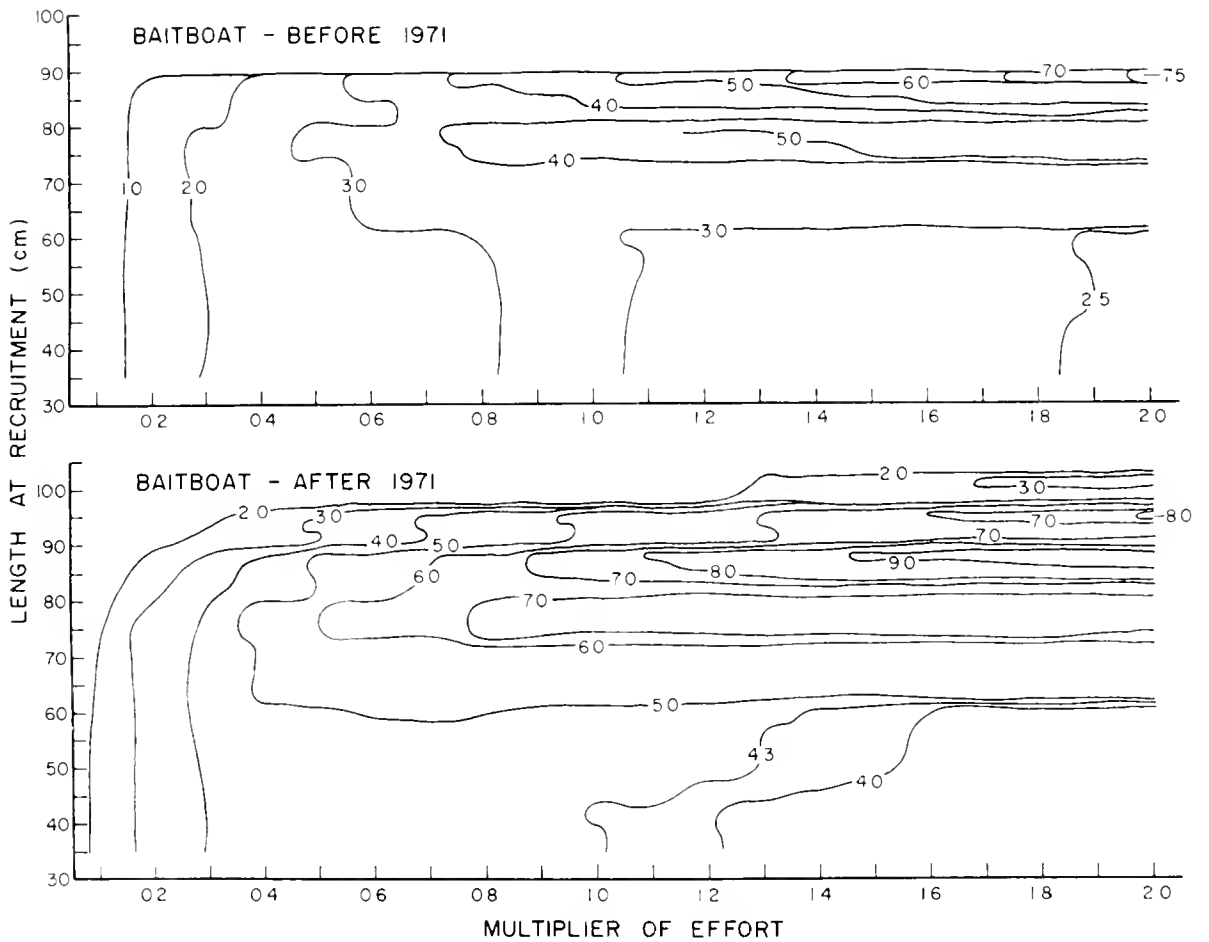

Figure 7. Estimated yield-per-recruit, as functions of age at recruitment and fishing mortality vector multiplier, of North Pacific albacore taken before and after 1971 by the Japanese surface fishery.

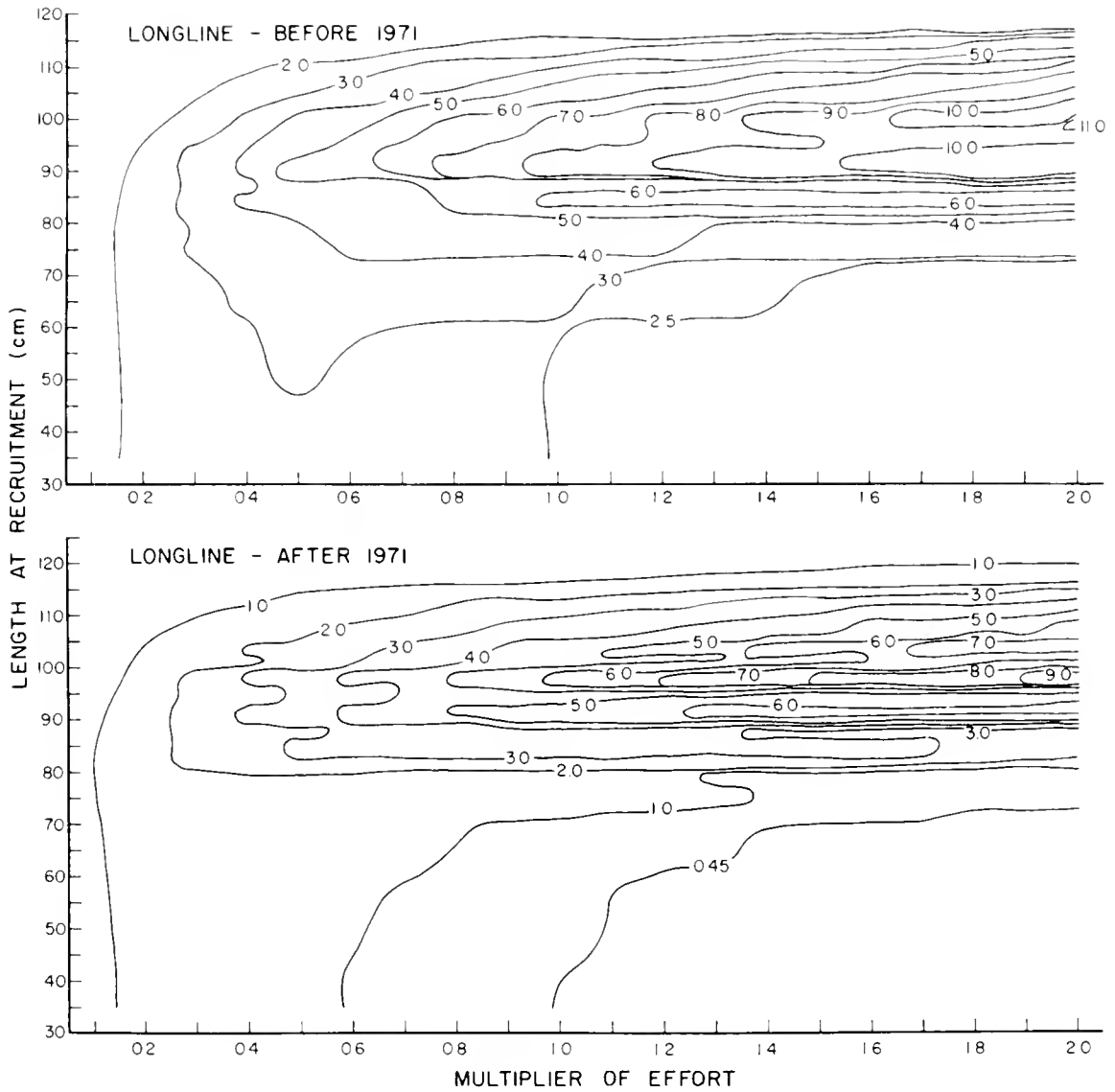

Figure 8. Estimated yield-per-recruit, as functions of age at recruitment and fishing mortality vector multiplier, of North Pacific albacore taken before and after 1971 by the Japanese longline fishery.

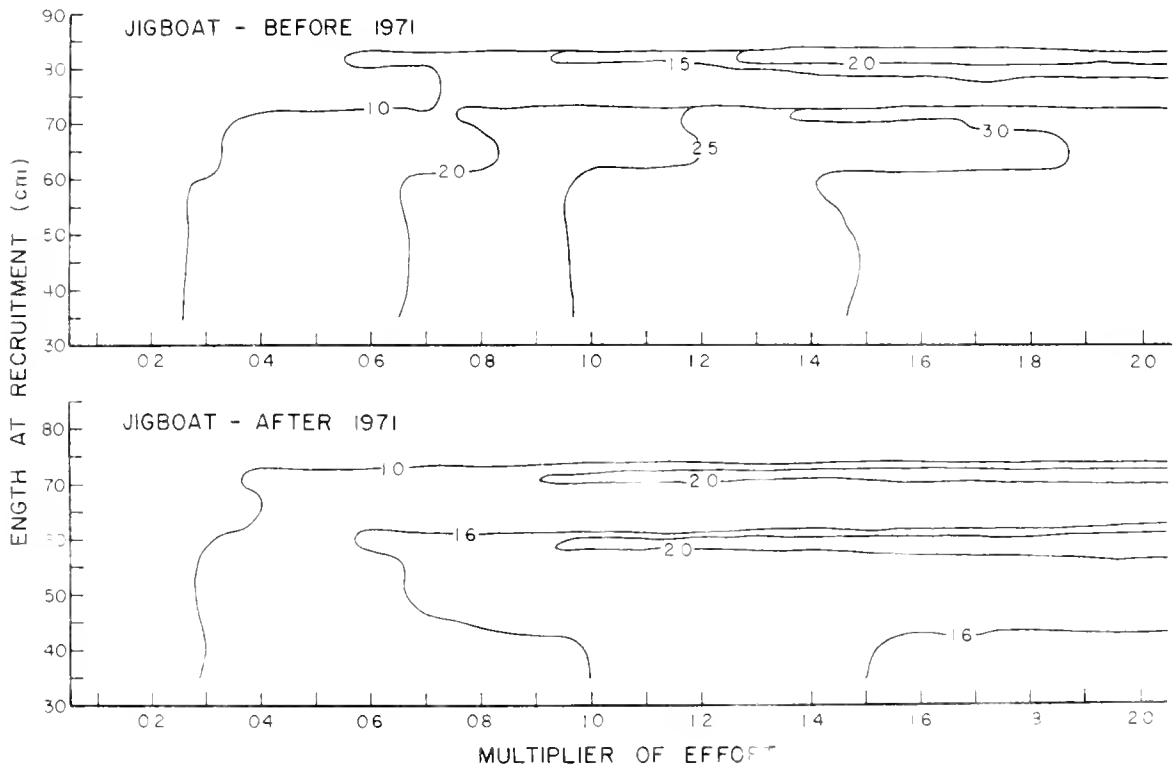

Figure 9. Estimated yield-per-recruit, as functions of age at recruitment and fishing mortality vector multiplier, of North Pacific albacore taken before and after 1971 by the North American surface fishery.

IV.B. Current Research Efforts

IV.B.1. Research Conducted by SWFC

Research efforts in 1980 were directed toward: 1) assessment of the stock using conventional techniques such as cohort, yield-per-recruit, and spawner/recruitment analyses, and 2) development of a fishery/environment simulation model intended to describe mathematically the fish-fishery interaction and test hypotheses on the effects of management actions on the stock. This model is also intended to guide future research. Additional research efforts are being conducted by the Albacore Fisheries Investigation in the Coastal Fisheries Resources Division of the SWFC, La Jolla.

Albacore Oceanography Research --This research is designed to gain understanding of the environmental effects on albacore distribution, availability, migration, vulnerability, and possible abundance. The goal of the research is to develop quantifiable indices of key environmental processes that may be used in fish/fishery/environment models for use in providing advice for eventual international management of the North Pacific albacore resource. Specific studies include 1) the influence of North Pacific Transition Zone frontal structure on albacore migration, distribution, and availability, with studies being conducted using data from research cruises, cooperating fishing vessels through joint studies with AFRF and others, and historical data files; 2) acoustic tracking studies to determine albacore depth distribution and optimal ocean temperature relationships that may affect availability and vulnerability; 3) the influence of coastal upwelling on availability and vulnerability, using fishery data from logbooks and upwelling indices from PEG; 4) satellite-oceanography studies to evaluate the use of ocean measurements made from space to monitor key oceanographic conditions that influence albacore distribution, migration, and availability; and 5) the development of indices of environmental conditions affecting albacore for use in fish/fishery/environment models, using historical data bases and data from research vessels and cooperating fishery vessels.

Albacore Biology Research --The objective of this research is to gain knowledge and understanding of selected areas of albacore biology for use in albacore oceanography research and population assessment studies. Specific research areas include:

- 1) Age and Growth Studies--These are being conducted using albacore tag release and recovery data from the cooperative NMFS/AFRF albacore tagging program, and the otolith daily ring increment method of ageing fish. The latter, which is part of the tagging program, involves a field/laboratory study to evaluate the rate of otolith ring formation in albacore, using injection of tetracycline to "mark" otoliths at time of release of tagged albacore. In addition, a study is being conducted in cooperation with

Canadian fishery scientists, as recommended at the Fourth North Pacific Albacore Workshop (NPAWS), to intercalibrate and evaluate the otolith daily ring increment and fin ray circular methods for ageing albacore.

- 2) Stock Structure Studies--These studies are being conducted to determine if the North Pacific albacore population is composed of more than one substock, as has been indicated by results from the cooperative NMFS/AFRF tagging program. The studies are being conducted using data on tag release and recovery, and size composition. In addition, samples have been collected for biochemical investigation (to be done at Scripps Institution of Oceanography) as recommended at the Fourth North Pacific Albacore Workshop.

Migration Studies--These studies are designed to examine albacore migration on trans-oceanic macroscales and within region meso-scales. They are related to 1) the investigation of stock structure and the distribution of proposed substocks of North Pacific albacore, and 2) albacore oceanography studies which investigate the role of environmental factors and conditions that influence the timing and rate of albacore migrations. These studies are conducted using data on tagging and release, size composition data, fishery-oceanography data gathered from cooperating fishing vessels and research cruises, and results from acoustic tracking experiments.

Environmental Physiology Studies--These studies are designed to gain understanding of albacore physiological/biochemical processes, with an emphasis on thermoregulation and the role that it may play in understanding causal factors operating in fish-ocean relationships. The studies are carried on cooperatively with fishery physiologists and medical research scientists from universities and private research foundations. Experiments are carried on aboard ship with live albacore; in some cases, albacore specimens and samples are collected at sea and analyzed in the laboratory. There have also been attempts to transport live albacore to shoreside facilities and hold them in captivity. Shiptime, limited equipment, and some supplies are provided by NMFS; major equipment and supplies are provided by the individual cooperating scientists.

Foreign scientists from Japan, Canada and Taiwan are also engaged in related research activities. These include such research areas as population dynamics, migration patterns, oceanography, and growth rates.

IV.B.2. Albacore Fishery Advisory Service

The overall goal of the fishery advisory service is to develop a real-time fishery management system whereby fishery information required for proper management can be exchanged between fishery/managers/scientists and the fishing industry. Only the rudiments of such a system are in operation at the La Jolla Laboratory, including: 1) seasonal forecast of the timing and distribution of the fishery issued prior to the start of the season; 2) bi-weekly fish bulletins distributed during fishing season by mail to fishermen, processors, fish buyers, and moorages; 3) daily albacore fishing broadcasts transmitted during the fishing season by radio station WWD, Point Reyes Coast Guard, and four commercial radio stations along the Pacific west coast; 4) contacts with albacore fishing industry and sportfishermen in the form of oral presentations at meetings and workshops, and answering several hundred telephone and mail inquiries for information concerning a broad range of topics about albacore received from fishermen and others in the fishing industry, scientists, students, recreational fishermen, and interested public.

IV.C. Future Research Needs

1) Hypotheses need to be formulated which are concerned with stock structure, migration, mortality, availability, and the role of environment in affecting the abundance of North Pacific albacore. Fishery and environmental indices necessary for hypothesis testing must be identified and quantified for use in a fishery model currently under development. This model will provide a focal point for many of the albacore research projects, serving as a means of analyzing various data fields and testing fishery hypotheses.

2) Studies of age and growth are proposed, which will improve the age-specific fishery data that are the basis of fishery assessment work.

IV.D. Status of SWFC Data Base

North Pacific albacore data are stored on magnetic tape at the Southwest Fisheries Center. These data are adequate for non-effort based assessment work and are, with few exceptions, complete. Needed are historical data from the Korean longline fishery, and data from the Japanese high seas drift gill net squid fishery which is taking incidental catches of small (approximately 20 cm) albacore and discarding them dead. Recently emphasis has been placed on obtaining catch, effort, and size frequency data from individual catcher vessels of the U.S. fleet. These data will provide for more precise parameter estimation.

STATUS REPORT: NORTH PACIFIC BLUEFIN TUNA

by

Doyle A. Hanan

California Department of Fish and Game*

ABSTRACT

Northern Pacific bluefin tuna are fished by surface gear including purse seine, trolling, bait, gill net, trap, and harpoon in the eastern and western Pacific. Bluefin are also caught by longline in the western Pacific and, to a lesser extent, in the central and eastern Pacific and the east Indian Ocean.

The resource appears to be composed of a single stock; the western Pacific catch is composed of juveniles and mature adults while the eastern Pacific catch consists mainly of 1-, 2-, and 3-year old fish. Presence of a second stock off New Zealand is not confirmed by studies.

*At the Southwest Fisheries Center, La Jolla, California, under Cooperative Agreement 81-ABH-0040.

I. DESCRIPTION OF THE FISHERY

I.A. History of the Fishery

A surface sport fishery for bluefin existed in the California Bight as early as 1898, but commercial fishing did not begin until seines were tried about 1914; the first large catch was reported in 1918. Bluefin have historically been fished opportunistically by the San Pedro purse seine fleet in the California Bight. When larger tuna baitboats converted to seining in the late 50's, the effective fishing range was extended to include the area from Cabo San Lucas to Point Conception, and occasionally as far north as British Columbia.

In the western Pacific, traps were first used to catch bluefin; purse seining began about 1950, with the first important catches about 1958. Trolling gear, baitboats, gill nets, and harpoons are used near Japan. A multispecies longline fishery, with smaller boats (less than 50 tons) operating near Japan and larger boats ranging throughout much of the Pacific (Figure 2), also takes bluefin tuna.

A bluefin fishery in the eastern Pacific consists of the local purse seine fleet out of San Pedro, California, and the "high seas" tuna fleet based in San Diego, California. Since 1975, Mexico has entered the fishery with an expanding purse seine fleet out of Ensenada, Mexico.

The western and central Pacific fishery is dominated by Japan; however, Taiwan and Korea are also operating longline fisheries in that area.

I.B. Trends in Catch and Effort

In recent years, North Pacific bluefin contributed about 1% to the world tuna catch. From 1918 to 1958, the North Pacific bluefin catch averaged 5,066 metric tons (mt) per year (Table 1). After the "high seas" baitboats converted to seining in the late 50's, the fishery expanded to the waters off Baja California, and the average yearly catch in the eastern Pacific climbed to 9,076 mt. A running 10-year average of the bluefin catch in the eastern Pacific reveals an overall decline since 1961, underscored by a projected 1980 catch of 3,000 mt (Figure 1). Further emphasizing a decline in the bluefin catch is the eastern Pacific sport catch, which averaged 7,532 fish per year during 1936 to 1957, but declined to 1,835 fish per year during 1958 to 1979 (Table 1).

The commercial fishery in the western Pacific (which began about 1958) has a mean annual catch for 1964 to 1978 of 14,700 mt, with a range from 4.8 to 30 thousand mt (Table 1). It also shows a significant decline to levels comparable to the eastern Pacific catch. A summary of effort data for the western Pacific is not available at this time.

Table 1. Catch and effort data for northern Pacific bluefin. All values x1000.

YEARS	57	58	59	60	61	62	63	64	65	66	67	68	69	70	71	72	73	74	75	76	77	78	79	80	
F.A.O. REPORTED CATCH (MT)	9.2	13.9	6.9	5.4	10.0	14.7	14.2	10.9	7.6	16.3	6.5	6.1	7.3	4.1	9.7	11.3	9.2	5.2	7.4	8.6	5.9	5.3			
JAPAN								19.3	23.2	21.3	19.0	24.2	17.5	15.2	14.8	15.8	4.8	10.3	7.0	5.4	8.5	13.7			
MEXICO																			2.2	2.3	3.0	.8			
TOTAL								30.2	30.8	38.1	25.8	30.7	25.3	19.9	24.5	27.1	14.5	15.4	16.8	16.3	17.8	19.7			
SFPORT: CATCH (#fish)	6.4	.8	1.3	.9	2.3	2.5	.7	.7	.09	2.0	3.2	1.2	1.5	1.8	.7	1.5	5.4	5.6	3.3	2.0	1.8	.5	1.1		
EASTERN PACIFIC	9.2	13.9	6.9	5.4	9.6	14.7	14.2	10.6	7.6	16.8	6.6	6.1	7.2	4.0	8.4	13.4	10.6	5.7	9.6	10.6	5.2	5.9	6.7	3.0	
Commercial: CATCH (MT)	1.3	2.6	2.8	3.2	3.8	5.7	4.9	4.6	4.4	3.9	5.8	3.7	4.7	2.9	5.0	5.2	4.6	4.1	4.4	4.5	3.5	4.6			
EFFORT (DAYS)	7.0	5.3	2.5	1.7	2.5	2.6	2.9	2.3	1.7	4.3	1.1	1.6	1.6	1.4	1.7	2.6	2.3	1.4	2.2	2.4	1.5	1.3			
C.P.U.E. (MT/DAY)																									

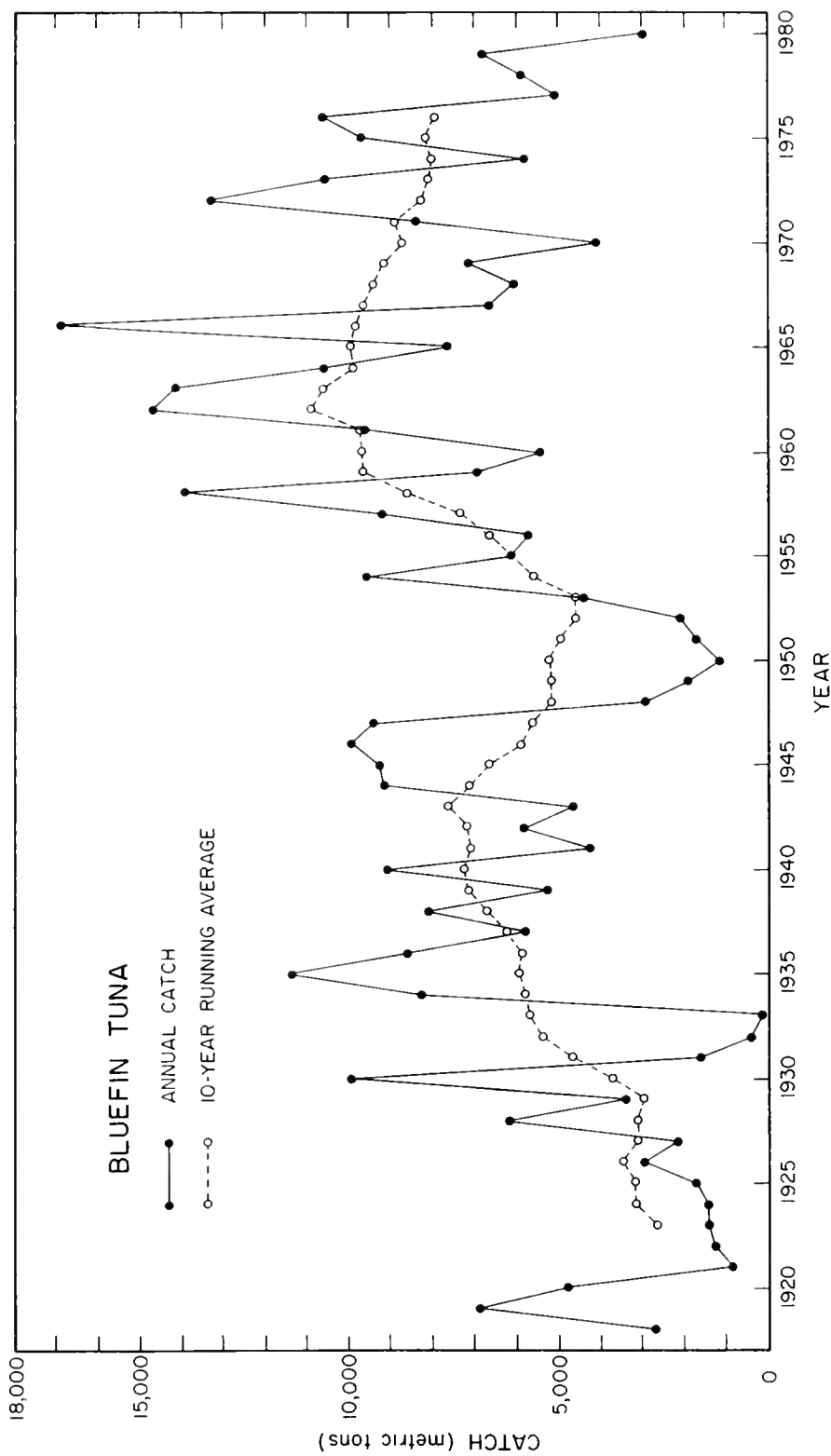

Figure 1. Annual catches of northern Pacific bluefin in the eastern Pacific.

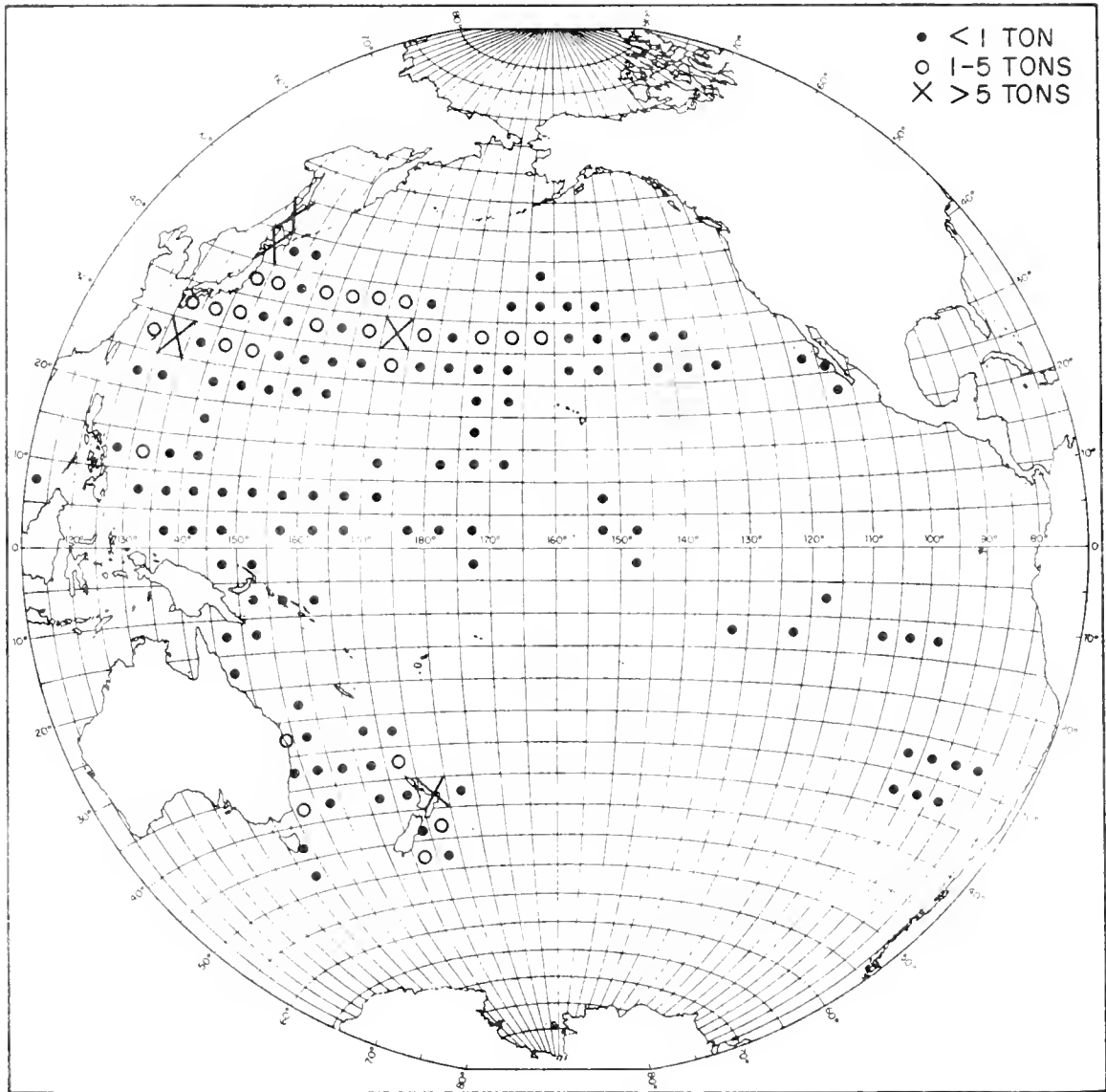

Figure 2. Average annual distribution of northern bluefin caught by Japanese longliners during 1972 to 1976 (after Wm. Bayliff, 1979, Inter-American Tropical Tuna Commission, Annual Report).

I.C. Value of Catch

Ex-vessel prices for bluefin at California canneries have historically been set just below yellowfin prices, but above those for skipjack. In 1979, 6,743 mt at an ex-vessel price of \$1,023/mt were caught in the eastern Pacific, for an ex-vessel value of \$6.9 million. Although the price increased to \$1,298/mt in 1980, only about 3,000 mt have been caught for an ex-vessel value of \$3.9 million. In 1980 about 130 mt of bluefin were delivered to the Los Angeles fresh fish markets at prices near \$2,200/mt, for a value of about \$300,000.

Ex-vessel prices of northern Pacific bluefin at Yaizu, Japan, fluctuated between \$4,400 and \$13,970/mt in 1979. In all, 454 mt were landed for a value of \$2.5 million. During 1980, the price has fluctuated between \$2,310 and \$15,950/mt; through September, 1,179 mt were landed for an ex-vessel value of \$5.1 million.

The total value of combined eastern and western Pacific ex-vessel price data for northern Pacific bluefin for 1980 was about \$9 million.

I.D. Current Management of the Fishery

The only regulation of eastern Pacific bluefin is a 7.5-lb size limit in California, but the limit is superfluous since bluefin of that size are rare in the eastern Pacific. In the western Pacific, there are some regulations on the number of vessels fishing for particular species, but this is not restricted to bluefin.

II. NATURE AND SIGNIFICANCE OF U.S. AND FOREIGN PARTICIPATION IN THE FISHERY

The U.S. commercial fleet currently fishes bluefin incidentally, as most of the tuna effort is directed towards yellowfin and skipjack. Since the ex-vessel price of bluefin is only \$20/short ton less than that for yellowfin, skippers will set on bluefin, if a school of sufficient size is located, or will "top off" the load with bluefin on the return to port.

Since most of the U.S. catch is taken within 200 miles of the shore off Baja California, the negotiations concerning Mexico's 200-mile limit will have significant bearing on future U.S. catch of bluefin. Exclusion of U.S. fishing from current bluefin areas could shift the U.S. fishing effort beyond the Mexican 200-mile limit, or return it to the California Bight.

III. STATUS OF THE STOCKS

III.A. Stock structure

North Pacific bluefin spawn near the surface from April to July in the Philippine Sea. Young fish remain near Japan and are fished by surface gear until their first or second winter, when some migrate to the eastern Pacific to enter the fishery during May to October. Data based on 11 transpacific tag returns show that the fish may remain in the eastern Pacific 1 to 3 years before making the 2-year migration back to the spawning grounds. Longliners probably exploit this returning migration. Northern Pacific bluefin are also reported in the Australia-New Zealand area, but the origin of these fish is unclear (Figure 3).

III.B. Stock Assessment and Fishery Evaluation

III.B.1. Trends in Catch-per-Unit-Effort

This preliminary analysis is based on the summary data for 1957 to 1966 from a recent California Department of Fish and Game/National Marine Fisheries Service study, plus adjusted Inter-American Tropical Tuna Commission (IATTC) figures for 1966 to 1979; both are expanded to represent the eastern Pacific catch (Table 1). Over the complete time series, the catch-per-unit-effort (CPUE) index declines slightly ($b = -0.123$ per year), with a mean value of 2.45 mt per day ($SD = 1.4$). The mean CPUE for the most recent 12 years ($x = 1.8$, $SD = 0.49$) is about half that of the previous 10 years ($x = 3.28$, $SD = 1.72$), while nominal effort during this 22-year series has not significantly increased ($b = 0.07$ per year).

III.B.2. Results of Production Model Analysis

None available.

III.B.3. Results of Yield-per-Recruit Analysis

None available.

III.B.4. Results of Spawner/Recruitment Analysis

None available.



Figure 3. A model for northern bluefin migration in the Pacific Ocean (after Wm. Bayliff, 1979, Inter-American Tropical Tuna Commission, Annual Report).

III.B.5. Results of Other Analyses/Simulations

None available.

III.C. Current Evaluation of Stocks and the Fishery

The decline in bluefin catches in recent years cannot at this time be attributed to a particular cause because none of the necessary analyses have been done.

IV. STATUS OF CURRENT RESEARCH NEEDS AND EFFORTS

IV.A. Major Research Problems

Basic fishery models are needed for this resource, which is not currently being managed. A major problem in developing the models is the trans-Pacific, multi-national nature of the fishery. Better data are particularly needed for the western Pacific, as there is difficulty in separating northern from southern bluefin in the Japanese data.

IV.B. Current Research Efforts

Two research programs are currently underway on bluefin tuna. The Inter-American Tropical Tuna Commission (IATTC) has three biologists at SWFC who are 1) assembling logbook information from IATTC files, 2) writing a synopsis of biological data, 3) tagging bluefin in season, and 4) starting growth studies using tags and scale reading. IATTC also has a biologist doing tagging studies of juvenile bluefin near Japan. In addition, NMFS and CF&G have a joint project at SWFC: one biologist is evaluating existing bluefin data and will attempt to develop any fisheries models that are appropriate.

IV.C. Future Research Needs

1) An attempt should be made to merge western and eastern Pacific fishery data since evidence points to a single stock.

2) Indices of abundance need to be developed and refined for both west and east.

3) Exploitation rates need to be developed.

4) Management models such as yield-per-recruit and surplus production need development.

5) Factors relating to management, such as time-area patterns of occurrence, need evaluation.

IV.C.1. Suggested Approach and Methods

In addition to current work being done at SWFC, the following projects might be considered:

1) Exploitation rates could be developed for the eastern Pacific utilizing information obtained from tagging, cohort analysis, mortality, and emigration analyses yet to be done.

2) Aerial spotter information might be used to develop indices of abundance.

IV.D. Status of SWFC Data Base

The data base, which has been established this year via the NMFS-CF&G project, consists of eastern Pacific tuna logbook data, 1957 to 1970, 1974; length-frequency data, 1923 to 1925, 1951 to 1966; length-weight-age data, 1963 to 1971; length-weight data, 1960 to 1965, 1971 to 1974; monthly California landings, 1926 to 1976; tag return data, 1953 to 1969; and a vessel list, 1957 to 1978.

The data base for the western Pacific is the Japanese longline information, 1962 to 1980; the Japanese baitboat information, 1970 to 1976; and the Taiwanese deep sea longline information, 1967 to 1975.

STATUS REPORT: PACIFIC SWORDFISH

by

James L. Squire, Jr.

Southwest Fisheries Center
Oceanic Fisheries Resources Division
La Jolla, California

ABSTRACT

The stock structure of swordfish populations in the Pacific is not clear. Information and data evaluated at the Billfish Stock Assessment Workshop suggest the population consists of either a single Pacific-wide stock, or northwestern, southwestern, and eastern Pacific stocks. For the 1952-1963 data series, a production model analysis gave a Pacific-wide MSY estimate of 20,000 mt with an effort level of 2.2 million hooks/5° area. The average (1966-1975) catch of 14,000 mt produced by 1.8 million hooks/5° area indicates that the fishery does not appear to be overexploiting the stock, and that the stock is in good condition.

Recent catches (1978) indicate levels of total catch equalling about 18,000 mt, approximately 2,000 mt less than MSY. High demands world-wide may drive the catch figure to the level of current MSY estimates or above within a short period of time.

I. DESCRIPTION OF THE FISHERY

I.A. History of the Fishery

Swordfish (Xiphias gladius) is distributed throughout the tropical and temperate waters of the Pacific, Atlantic, and Indian Oceans. It is more abundant in coastal waters but is also found in continuous patches in tropical and subtropical open ocean areas, as evidenced by longline catch rate data (Figure 1). In the Pacific, swordfish are taken commercially off the western coasts of the United States, Mexico, Ecuador, and Peru; near New Zealand and Australia; off the eastern coasts of Japan and Taiwan; and off the southeast coast of Asia. The limits of commercial distribution are approximately 50°N to 35°S latitude. Swordfish are caught by a variety of gear, including longlines, handlines, harpoons, gill nets, rod-and-reel, and purse seine. However, the majority of swordfish are caught by longline gear designed for capturing tunas. This gear, when properly modified and used specifically for catching swordfish, has the capability of catching large quantities. The longline fleets of Japan, Korea, and Taiwan catch substantial amounts of swordfish in the Pacific (Table 1). U.S. domestic longline vessels take a small amount (c. 4.4 mt/yr) of swordfish near the Hawaiian Islands. Mexico, Costa Rica, Ecuador, and Peru are currently developing longline fisheries through joint ventures with western Pacific countries.

The next most common methods for capturing swordfish include harpoon and drift and set gill nets. The Japanese are increasingly using drift gill nets to catch tunas and swordfish; more than 10% of the Japanese swordfish catch is currently made using this method (Figure 2) and this percentage is increasing.

The Japanese harpoon and drift gill net fishery lands about 3,000 tons of billfish (striped marlin/swordfish) from coastal waters about Sanriku (northeastern Honshu), around Izu Island, and in the east China Sea. Taiwan also has a harpoon fishery for swordfish, and Mexico is developing a drift gill net fishery.

In the waters off the west coast of the United States, there exists a commercial harpoon and drift gill net fishery. The use of drift gill nets for the capture of swordfish and oceanic sharks is a rapidly growing fishery off California: it is estimated that 37% of the swordfish landed in California in 1979 were caught with drift gill nets. A minor rod-and-reel fishery for swordfish also exists here. Southern California has the largest domestic catch of swordfish of any U.S. area in the Pacific; California catches normally range between 2-3% of the total Pacific Ocean catch, but in 1978 it equalled 12% of the total Pacific catch.

Rod-and-reel sport fishing for swordfish in the Pacific is on the increase. Participating countries include the United States (near

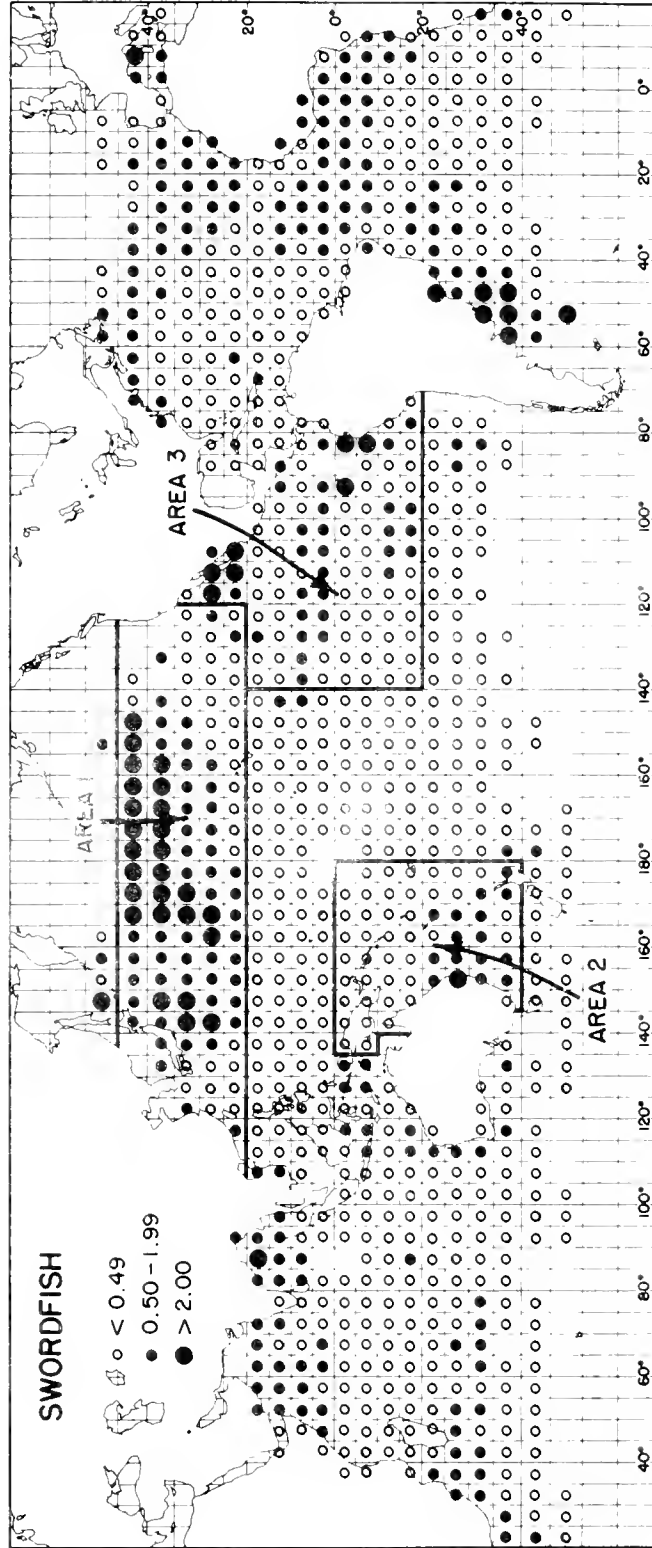

Figure 1. Distribution of swordfish in the Pacific. The circles indicate mean catch rates (number of fish per 1,000 hooks). Also shown are centers of concentration of hypothesized swordfish stocks in the Pacific.

Table 1. Total Pacific swordfish catch (metric tons), 1952 to 1976.

Year	MT
1952	11,339
1953	11,689
1954	13,392
1955	16,485
1956	12,584
1957	16,243
1958	21,341
1959	19,663
1960	23,409
1961	24,286
1962	14,604
1963	14,133
1964	10,112
1965	12,949
1966	14,601
1967	15,649
1968	15,230
1969	18,934
1970	16,727
1971	11,037
1972	11,029
1973	13,791
1974	11,664
1975	16,409
1976	19,309
1977	18,312
1978	18,765

Average (4 year) 1975-1978,
18,198 mt.

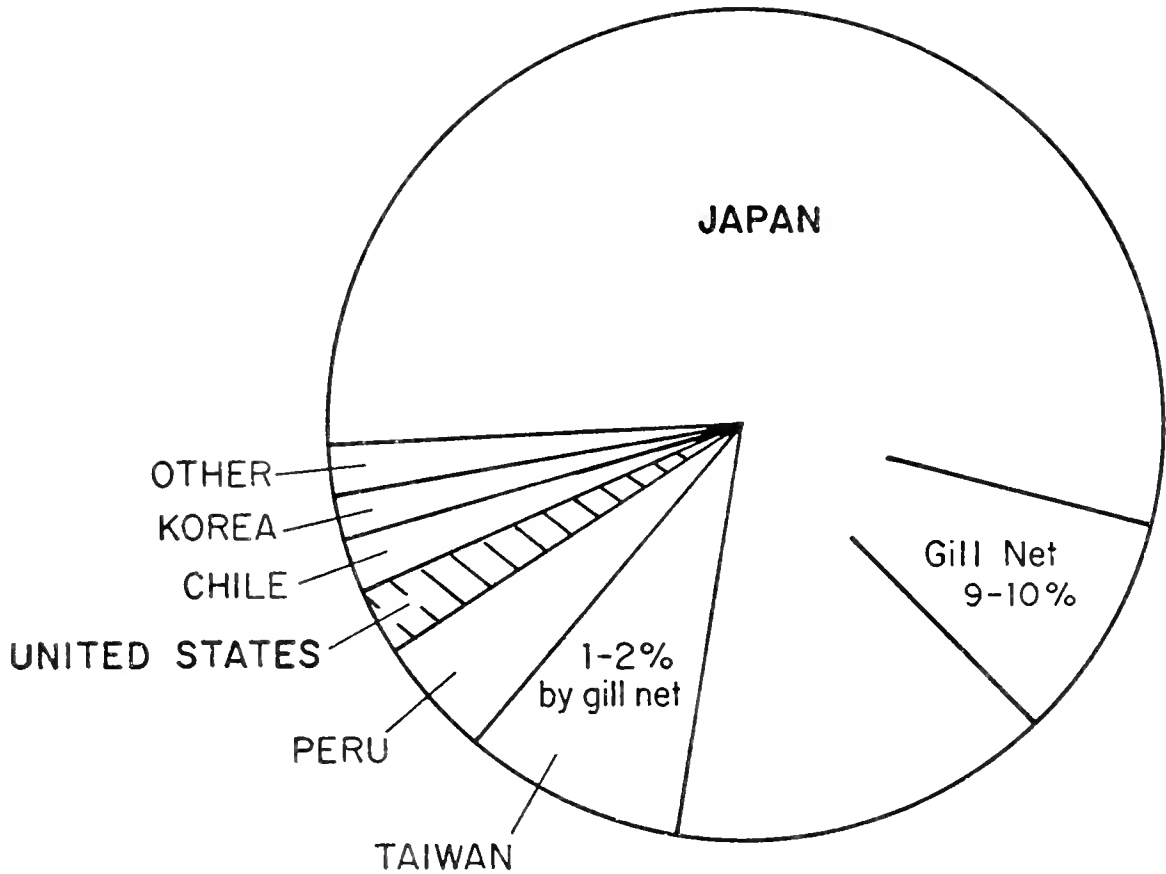

Figure 2. Relative swordfish catch by country for the Pacific Ocean. Current total Pacific catch is about 18,000 mt. U.S. catch averages about 409 mt or 2% of total Pacific catch.

California), Japan, and Mexico, Peru, Ecuador, and Costa Rica. These latter four countries also have coastal handline fisheries for swordfish. In addition, incidental catches are sometimes made with purse seines, and by gill nets which are being fished for other species.

I.B. Trends in Catch and Effort

The total annual catch of swordfish in the Pacific Ocean increased from 11,300 mt in 1952 to a high of 24,300 mt in 1961 (Table 1); since 1961 the catch has fluctuated between 10,000 and 19,000 mt. Catch rates decreased in 1971, the year that the Food and Drug Administration began to enforce guidelines on mercury contamination in fish in the U.S. and Canada. However, even without the U.S. and Canadian market for imported swordfish, the total Pacific catches have increased in recent years, peaking at 19,300 mt in 1976. The FDA limits were relaxed in 1979.

In 1976, Japan produced over 90% of the total Pacific swordfish catch. Taiwan, Korea, Peru, and the U.S. (in that order) produced the remaining 10%. The total Pacific swordfish catch by country is given in Table 2. Annual catch has ranged from 11,000 to 24,300 mt, with current catches averaging about 17,500 mt.

Within the U.S. Fishery Enforcement Zone (waters to 200 nm), a commercial and sport fishery exists for swordfish by U.S., Japanese, and other foreign nationals. Table 3 gives a summary of the estimated swordfish catch, by location, within this zone. The harpoon and drift gill net fishery off California accounts for approximately 95% of the domestic swordfish production in the Pacific. The harpoon fishery substantially increased its catch during the 1970's; Figure 3 shows the California catch (1918-1978) in mt. The largest catch was recorded in 1978 (1,609 mt), equalling 12.4% of the 1971-1976 Pacific-wide annual average. Up to 1979 the harpoon was the major gear type; in 1979, however, it was estimated that 37% of the catch (324 mt) was made with drift gill nets.

The amount of foreign longline effort being targeted upon swordfish is unknown. The known effective fishing effort for Pacific swordfish has fluctuated between 270 million and 550 million hooks (Figures 4 and 5). The level in 1975 was about 300 million hooks. Foreign and domestic drift gill net effort for billfishes and other species appears to be increasing rapidly.

I.C. Value of Catch

In the United States, the ex-vessel price of swordfish on the fresh market ranges from \$1.75 to \$3.50/lb. In the California fishery, the average ex-vessel price in 1980 was about \$2.50/lb. Ex-vessel (dressed) prices of \$2.50-\$3.00/lb. would bring \$5,000-\$6,000 per short ton, or \$5,500-\$6,600/mt. Assuming a price of \$2.00/lb., the catch in 1978 was

Table 2. Swordfish catches (metric tons) by countries for the Pacific Ocean

Year	Japan	Taiwan	Korea	United States	Chile	Peru	Others	Total
1952	11,182			157				11,339
1953	11,604			85				11,689
1954	13,301	77		14				13,392
1955	16,220	185		80				16,485
1956	12,167	254		163				12,584
1957	15,771	250		222				16,243
1958	20,815	247		279				21,341
1959	19,136	262		265				19,663
1960	22,944	273		192				23,409
1961	23,636	432		218				24,286
1962	14,037	544		23				14,604
1963	13,775	300		58				14,133
1964	9,703	300		109				10,112
1965	11,955	300		194	200	300		12,949
1966	13,283	600	41	277	200	200		14,601
1967	13,083	838	47	181	200	1,300		15,649
1968	12,983	974	55	118	200	800	100	15,230
1969	15,612	1,023	89	610	300	1,200	100	18,934
1970	11,301	1,053	115	558	200	2,400	100	15,727
1971	9,182	1,149	115	91	200	200	100	11,037
1972	8,846	1,111	115	157	100	600	100	11,029
1973	9,644	1,269	115	363	400	1,900	100	13,791
1974	9,517	1,157	115	384	218	270	3	11,664
1975	11,274	1,099	115	512	137	158	3	13,376
1976	15,682	1,290	444	53	13	294	3 ¹	17,190
1977	13,867	----	301	289	30	415	3,156 ¹	18,060
1978	----	----	---	1,609	---	----	---	----
1979	----	----	---	229	---	----	---	----

¹Includes Taiwan.

Table 3. Estimated average catch of swordfish by portion of the U.S. Fishery Conservation Zone in metric tons.

Location	Domestic/Foreign
Hawaii (including Midway)	4.4/111.3 MT
West Coast (off California)	225.4/ -
Guam & northern Marianas	2/7.2
American Samoa	-/3.3
Possessions	-/28.1
AVERAGE	230/149.9 MT
TOTAL AVERAGE	380 MT

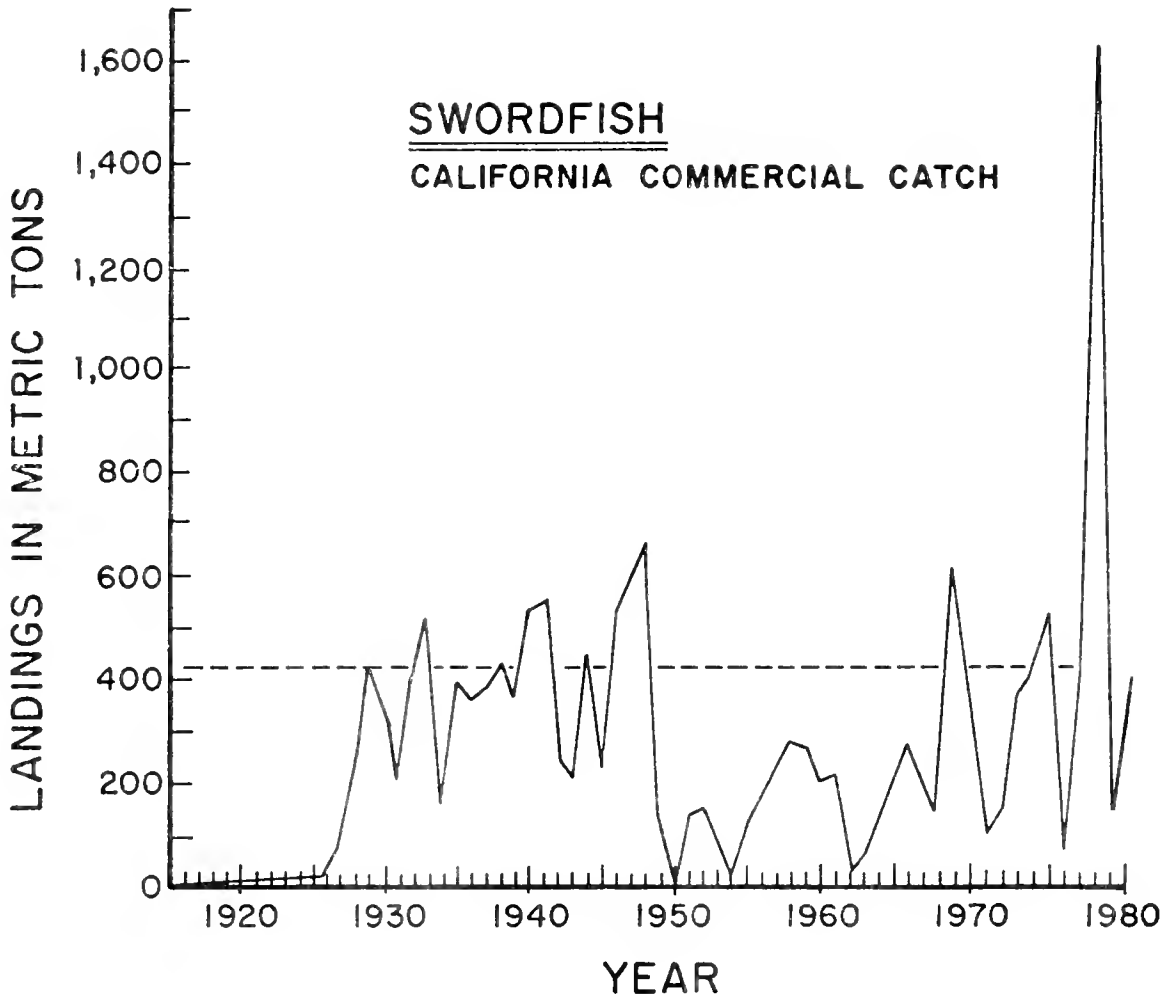

Figure 3. California commercial landings, 1918-1980, in metric tons, adjusted to round weight. Recreational catch average about 29 swordfish per year (2.7 mt).

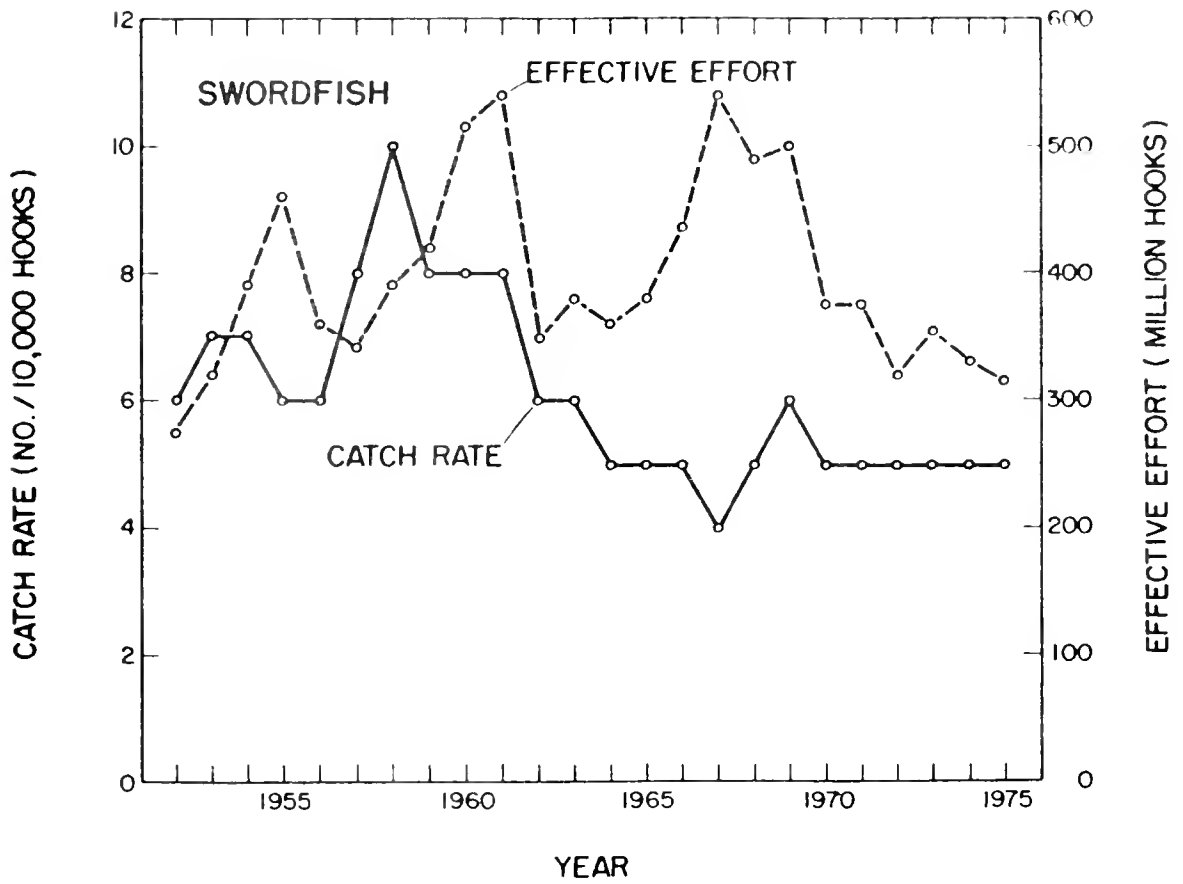

Figure 4. Pacific-wide catch rate and effective fishing effort for swordfish, 1952 to 1975.

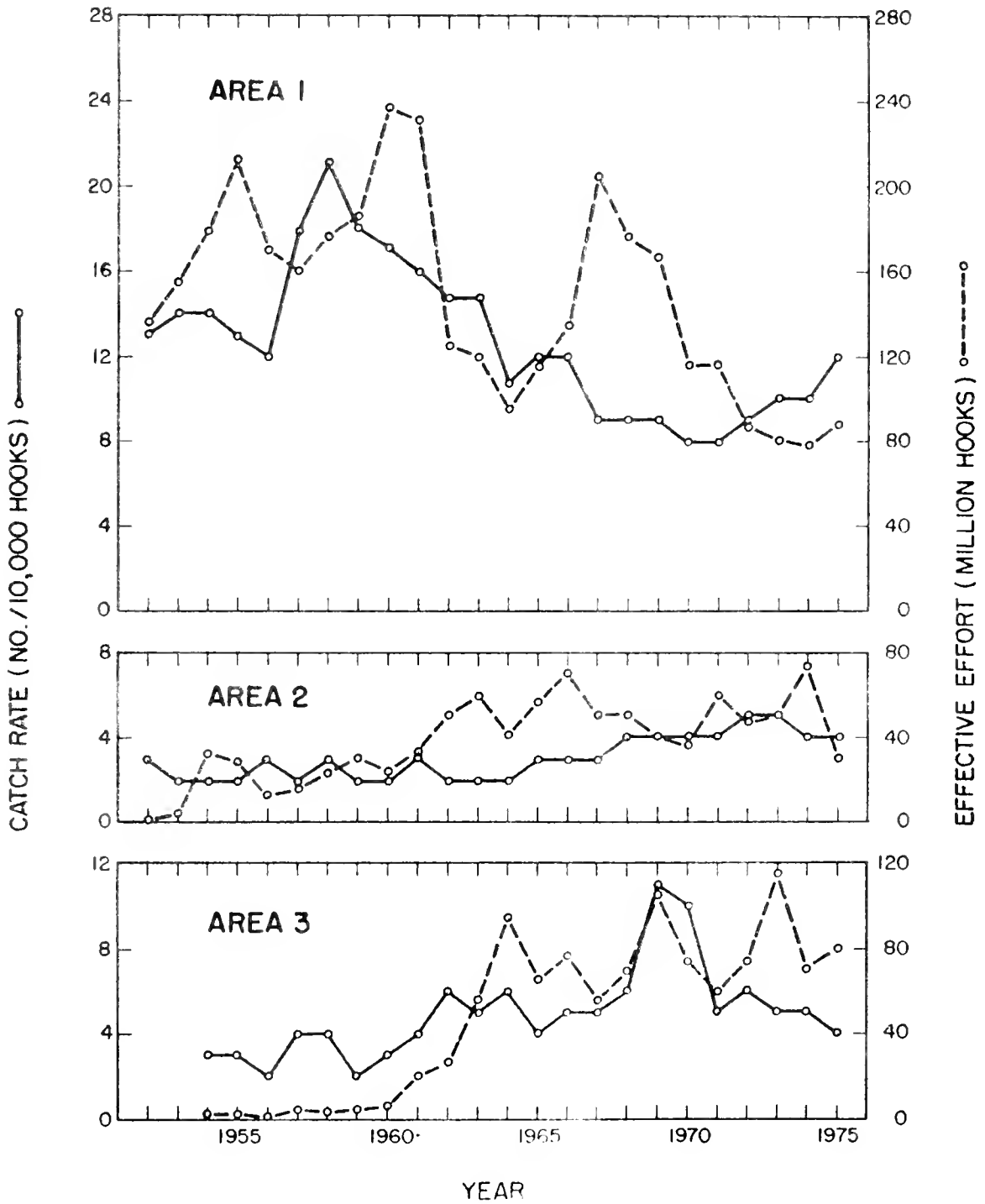

Figure 5. Catch rates and effective fishing effort for swordfish in the Pacific Ocean.

worth \$7.0 million. The value of the Japanese Pacific swordfish catch, based upon an ex-vessel price of \$1.19 (U.S.) in July 1979, was \$2,622/mt, for a total of \$36 million (U.S.).

I.D. Current Management of the Fishery

I.D.1. International Management

Swordfish in the Pacific Ocean are under no international management scheme at present. A preliminary Management Plan for Pacific Billfishes, which sets optimum yields for all the species of billfishes in the U.S. Fishery Conservation Zone around Hawaii, American Samoa, Guam, and California, is now in force.

I.D.2. Domestic Fishery Management

California Regulations

Swordfish fishing in territorial waters, and by California citizens in territorial and international waters, is regulated by the State of California; no other west coast or central Pacific states have restrictions on their fisheries. California has restrictions on commercial and recreational fishing aside from the normal license and permits. Recreational fishing regulations prescribe gear as trolled or cast lures, or bait only, and a daily catch not to exceed two (2) fish per day per angler. Commercial regulations prescribe either the harpoon or gill net only, with no seasonal or catch limits.

Federal Regulations

No federal regulations currently pertain to the taking of swordfish by domestic fishermen off the west coast Fishery Conservation Zone (FCZ) or in other FCZ areas of the Pacific. A Federal Fishery Management Plan (FMP) for billfish and oceanic sharks is being prepared under authorization of the FCMA of 1976 for the central and western Pacific FCZ by the Western Pacific Fishery Management Council, and for the U.S. west coast FCZ by the Pacific Fishery Management Council. These Plans will deal with both foreign and domestic billfish and oceanic shark fisheries within the FCZ and, when authorized, will supersede any State regulation currently in force for the management of swordfish fishing.

II. NATURE AND SIGNIFICANCE OF U.S. AND FOREIGN PARTICIPATION IN THE FISHERY

The public demand for swordfish exceeds the United States supply even in years of high catch. The swordfish fishery supports a substantial small-boat commercial fleet in southern California. In 1979, 1,206

swordfish permits were issued by California Fish and Game to commercial fishing license holders. The number of boats involved in the California fishery is about 400: data from logbooks indicate about half the commercial permit holders will actually fish. To this must be added the commercial fish processing, wholesale, and retail segment of the fishery. The exact amount of its value in employment and income is unknown.

There is considerable interest in fishing off southern California for swordfish by rod-and-reel recreational fishery. However, the major effort is targeted on striped marlin with swordfish as an incidental catch. In Hawaii, where the domestic commercial longline industry is small, the catch of swordfish is also incidental to the catch of tunas and other species of billfish. While some progress in increasing the efficiency of the rod-and-reel angler has taken place, the catch remains very low (average = 29 fish/year).

The California drift gill net fishery is growing, having increased several-fold in 1980, and the number of units now totals about 100. Although the catch of swordfish amounts to only 4-5% of the total catch (by numbers), its value contributes about 50% of the income to the drift gill net unit (Figure 6). Traditionally the drift gill netter targeted throughout the year on sharks (thresher/mako) and caught some swordfish during the summer and fall season, but the drift gill net units currently entering the fishery (a limited entry fishery by C.F.&G.) are targeting on sharks and swordfish. It is expected that the gill net fishery will grow, due to its ability to catch swordfish and thresher shark, and because of its fuel efficiency. Production from the harpoon fishery has the potential to increase if the current restrictions on use of airplanes for searching are removed.

In 1976 the Government of Mexico declared a 200-nm economic zone and began enforcement of this zone in early 1977. Within the economic zone is a high catch rate area for swordfish (off the northwest tip of Baja) and the highest catch rate area in the Pacific for striped marlin (about the tip, and southwest of Baja). Historically, U.S. commercial fishermen have sometimes operated off the northwest coast of Baja California, but U.S. fishermen are currently restricted from fishing in Mexican waters. The Mexican Government is encouraging the commercial exploitation of swordfish and striped marlin through joint ventures with the Japanese and by special licenses granted to U.S. vessels capable of using drift gill nets, harpoons, and longline gear. The Japanese joint venture is for the purpose of catching striped marlin for export to Japan; tuna and shark are also landed in Mexico. As of December 1980, nine of these longliners were operating out of Ensenada. The arrangements with U.S. fishermen fishing in Mexican waters have targeted on catches of swordfish for export to the U.S.

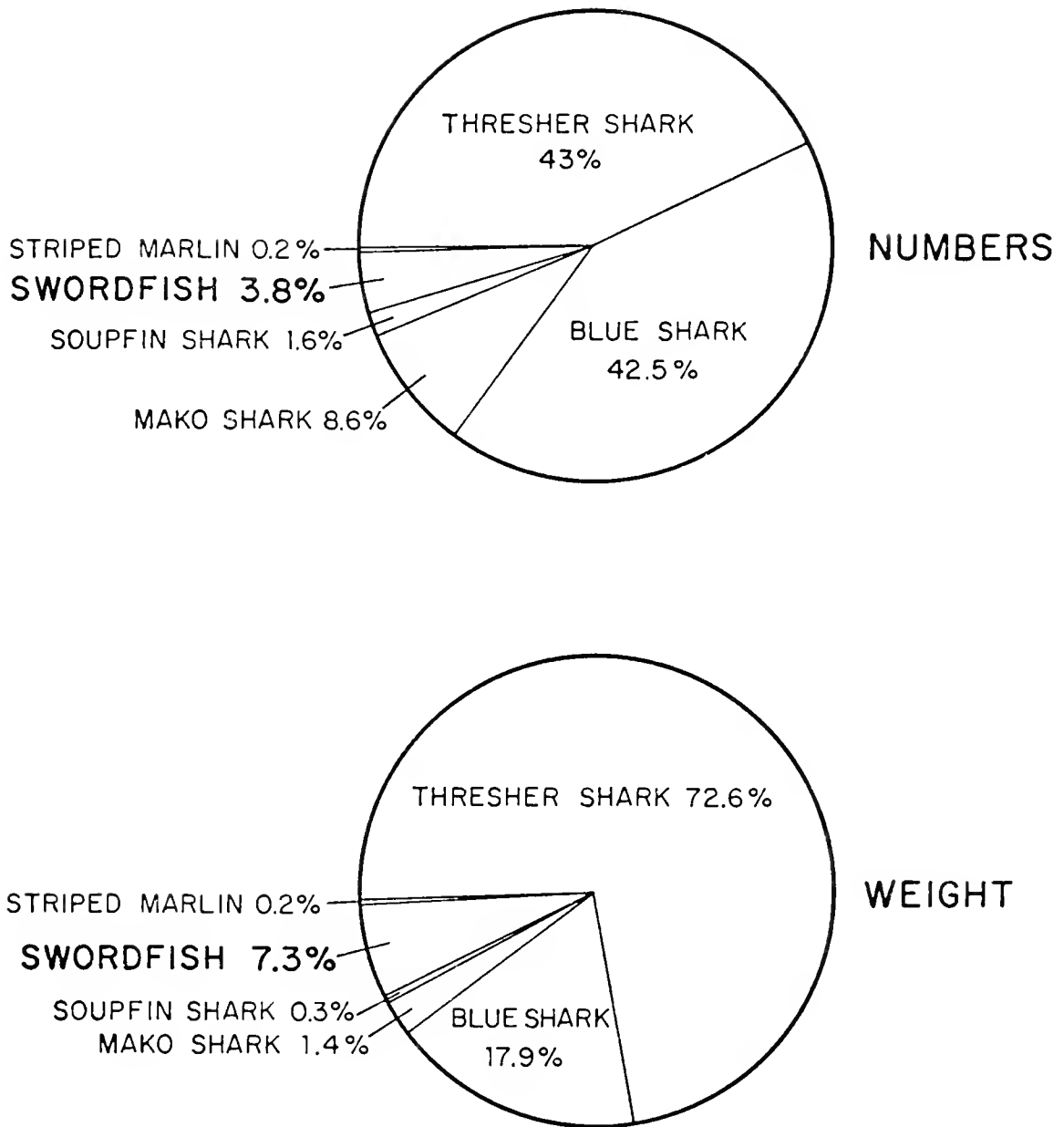

Figure 6. Catch composition of drift gill net boats from fishing logs for 486 nights of gill netting in 1979. Catch equalled 10,590 fish or an estimated 1,128,131 lbs.

III. STATUS OF THE STOCKS

III.A. Stock Structure

The stock structure of the swordfish population of the Pacific Ocean has not been clearly defined. Available data on distribution of larvae and on longline catch rates suggest that the population consists of either 1) a single, Pacific-wide stock, or 2) three separate stocks with centers of concentration in the northwestern (Area 1), southwestern (Area 2), and eastern (Area 3) regions of the Pacific Ocean (Figure 1).

III.B. Stock Assessment and Fishery Evaluation

III.B.1. Trends in Catch-per-Unit-Effort

The trends in swordfish catch rate and effort for the Pacific Ocean are shown in Figures 4, 5, and 7. The longest available time series of catch rates is for the Japanese longline fleet. Total Pacific catch rates for this fleet reached a peak of about 10 fish/10,000 hooks in 1958, then declined to a low of 4 fish/10,000 hooks in 1967; rates have since stabilized at about 5 fish/10,000 hooks.

III.B.2. Results of Production Model Analysis

The condition of the swordfish stocks of the Pacific was evaluated, based on different hypotheses about the stock structure of the population: hypothesis 1 assumed a single Pacific-wide stock, and hypothesis 2, three separate stocks.

Single Pacific-wide Stock--The relation of catch and effective fishing effort (a projection of effort for catches where no effort data are available), assuming a single Pacific-wide stock, is shown in Figure 7. The data points fall into two clusters, separated by a sharp break between 1963 and 1964, which corresponds approximately to the period when the operational methods in the productive northwestern fishing area changed from longline night fishing, which is directed at swordfish, to a day operation which targets on tunas.

The production model does not appear to fit the data well, because the points offer no solution for the 1964-1975 data series and give a maximum sustainable yield (MSY) estimate of 20,000 mt per year with 2.2 million hooks/5° area for the 1952-1963 series. Presumably during the 1952-1963 period the fishery was more efficient in catching swordfish than during the 1964-1975 period. The current (average for 1966-75) catch of about 14,100 mt produced by 1.8 million hooks/5° area) indicates that the fishery does not appear to be overexploiting the stock and that the stock is in good condition.

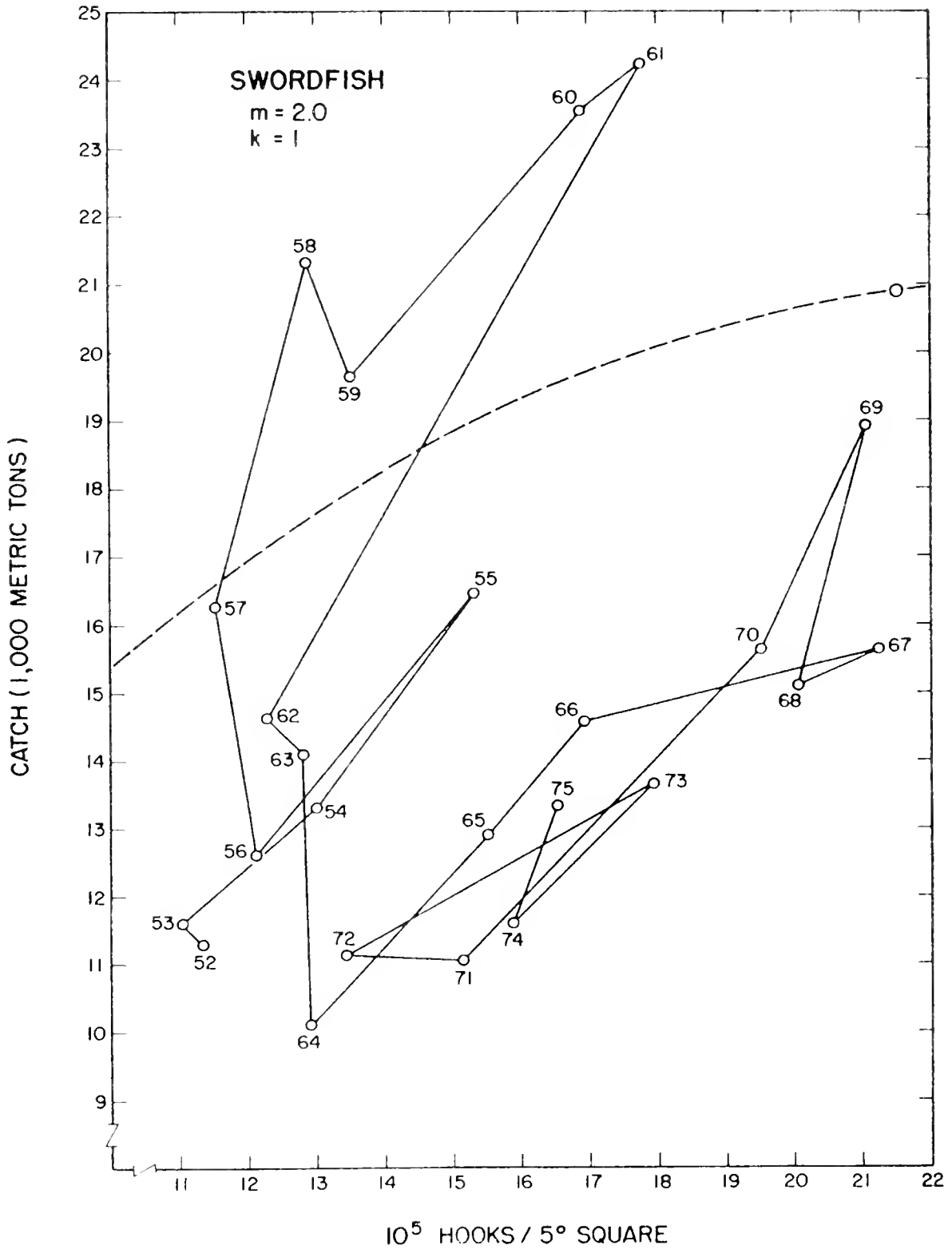

Figure 7. Relationship of catch of swordfish and effective fishing effort. The equilibrium yield curve (Schaefer production model) is shown for data for 1952 to 1963 only.

Three separate stocks--Complete data for production model analysis, assuming three stocks in the Pacific were not available for examination. An appraisal of the condition of the stocks was therefore based on estimates of apparent abundance from Japanese longline data for 1952-1975.

For this paper, an analysis of only the eastern Pacific stock is given.

Longline catches in the eastern Pacific (Area 3 of Figure 1) showed an increasing trend after 1960, following a period of small catches from 1952 to 1960 (Figure 8); the catch rates gradually increased from about 2 fish/10,000 hooks in 1954 to 6 fish/10,000 hooks in 1968 (Figure 5). In 1969 and 1970, the catch rates increased sharply to a record high of about 11 fish/10,000 hooks, before declining to a level of about 6 fish/10,000 hooks in 1971-1975.

III.B.3. Results of Yield-per-Recruit Analysis

None available.

III.B.4. Results of Spawner/Recruitment Analysis

None available.

III.B.5. Results of Other Analyses/Simulations

None available.

III.C. Current Evaluation of Stocks and the Fishery

The swordfish stocks of the Pacific Ocean appear to be healthy and capable of sustaining increased yields with increased effort. However, should the longline fishery resort to night fishing as was the standard method of fishing in some areas prior to the mid-1960's, then the greater efficiency of the gear could result in the catch exceeding the MSY when the current level of fishing effort is increased about 25%.

Available techniques for stock identification are expensive to apply and not entirely reliable in producing clear results. Different stock structure hypotheses should be tested with existing fisheries data to determine their impact on assessments before any major program for stock identification of swordfish is considered. The key to more precise stock assessments for swordfish is more reliable information on stock densities and better estimates of population dynamics parameters.

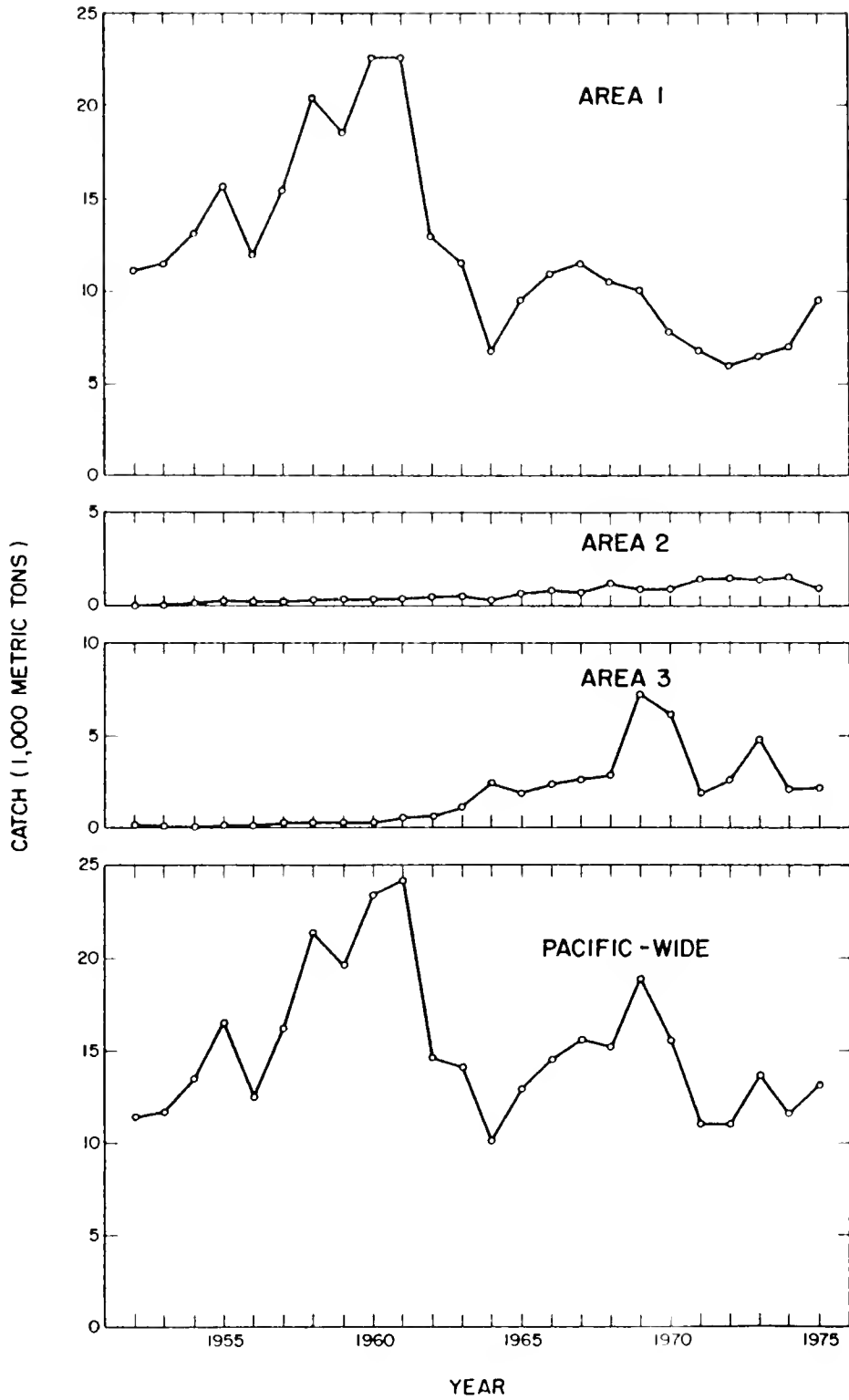

Figure 8. Swordfish catch in the Pacific Ocean, 1952 to 1975.

The California commercial swordfish fishery has socio-economic problems whereby limited techniques of fishing are leading to an inefficient fleet and lower production. The fishery is overcapitalized and the average vessel in the fleet experienced a loss of over \$4,000 per year. This fishery could be managed to increase production substantially. For example, use of aircraft can increase the efficiency of the harpoon fleet by 2.6:1.

IV. STATUS OF CURRENT RESEARCH NEEDS AND EFFORTS

IV.A. Major Research Problems

The major research problems concerning the swordfish in the eastern Pacific Ocean centers on whether the stock is Pacific-wide or composed of the three separate substocks. To better define the stock structure, studies to determine the range and magnitude of migration of swordfish are required. A full range of stock identification techniques should be employed such as genetic studies, time/area catch analysis, and tagging to determine the degree of intermingling. Size and sex data should be collected from all fisheries, and catch-and-effort data from the surface fisheries. Seasonal target areas for the different species also need to be defined relative to production in numbers and the value of the catch in relation to tuna when it is the target species.

IV.B. Current Research Efforts

No major research programs on swordfish are known for the northwestern coast of South America, Central America and Mexico, or at other locations in the Pacific. A small amount of stock assessment work is being conducted in Japan (Far Seas Research Laboratory, Shimizu, Japan) relative to stocks of swordfish in the world oceans. At the present time, only a very limited amount of effort is being given to biological research and stock assessment of swordfish in the U.S.:

- 1) The National Marine Fisheries Service, in cooperation with the Pacific Marine Fisheries Commission and the California Department of Fish and Game, sampled swordfish catches at sea in 1978 and 1979.

- 2) The NMFS is cooperating with the Western Pacific and Pacific (west coast) Fishery Management Councils in the development of the Fishery Management Plan.

- 3) The NMFS sponsored the Cooperative Marine Game Fish Tagging Program, which has encouraged the tagging of swordfish and striped marlin off southern California. Swordfish (and striped marlin) are of particular interest to the Pacific Councils' FMP.

4) The California Department of Fish and Game is analyzing data on the California drift gill net fishery for swordfish.

IV.C. Future Research Needs

Research relative to the needs of management for the total oceanic resource of swordfish is needed for: 1) definition of areas and seasons of spawning in the eastern Pacific, 2) age and growth rates, 3) determination of catch composition, 4) relation of sub-surface and surface distribution to the physical and biological environment, and 5) analysis of CPUE data shifts to determine migratory trends. For the southern California swordfish fishery and resource, the following research is needed for further development of management advice:

*1) Sampling program for both the commercial and recreational billfish fishery.

2) Survey of effective effort and economic significance of the southern California recreational and commercial fleet.

3) Determination of near surface and subsurface abundance and size distribution of swordfish off southern California.

4) Determination of migratory patterns and exploitation rates (southern California fishery) using both long-term and short-term (diel) studies.

IV.D. Status of SWFC Data Base

Swordfish logbook data for 1979 are being placed into the Coast-wide Data System at SWFC through a cooperative program with the California Department of Fish and Game. Swordfish tagging data will also be placed into the system, which will update the 1963-1980 data base.

More detailed basic catch and effort data are needed to make more precise stock assessments. Data presented in closer grid spacing (less than 5° area) would be desirable for determining stock movements within areas of high CPUE.

The U.S. fishing industry supplies good to excellent effort data from the California logbook system for commercial catches; California and Hawaii both supply a fair coverage of catch data for the commercial

*A cooperative effort with the California Department of Fish and Game.

longline and recreational catches. Japan also supplies good to excellent data on both catch and effort in its longline fishery, but the data obtained from Korea and Taiwan range from poor to barely adequate.

STATUS REPORT: PACIFIC STRIPED, BLUE, AND BLACK MARLINS

by

Howard O. Yoshida

Southwest Fisheries Center
Honolulu, Hawaii

ABSTRACT

The blue marlin, striped marlin, and black marlin are primarily caught by longline gear in the Pacific. The available evidence suggests that blue marlin comprise a single equatorially-centered stock in the Pacific. Two hypotheses have been advanced for striped marlin stocks in the Pacific: (1) a single-unit stock and (2) a two-stock structure where a North Pacific stock and a South Pacific stock are separated roughly at the equator, with some intermixing in the eastern Pacific. The available evidence suggests the possibility of a multiple (two or three) stock structure for black marlin in the Pacific: one in the eastern Pacific and two in the western Pacific. The production model analysis, together with the declining catch rate, suggests that the Pacific blue marlin stock is being overfished. On a Pacific-wide basis, the striped marlin stock appears to be in good condition. No production model analysis is available for the Pacific black marlin. A high priority task is to better define the stock structure of marlins in the Pacific.

I. DESCRIPTION OF THE FISHERY

I.A. History of the Fishery

The blue marlin (*Makaira nigricans*), striped marlin (*Tetrapturus audax*), and black marlin (*M. indica*) are widely distributed in the Pacific Ocean (Figures 1-3). The major fisheries for these three species are the longline and harpoon fisheries of Japan, Taiwan, and Korea. The first major exploitation of the marlin resources began with the advent of the high-seas longline operations of Japan following World War II. Although the quest was for large tuna species, the gear caught all large fish, of which the marlins were a significant component. Beginning in the western Pacific, the advancing front of longline operations (Figure 4) reached 130°W longitude by 1944 and the American Continents by 1965. Thereafter the fishery expanded southward (Ueyanagi 1974).

Longline boats of Taiwan and Korea later followed the Japanese in fishing the high seas. The longline fleet of Taiwan, after 40 years of coastal operations, began its high-seas venture in 1954. The longline fleet was composed of 42 boats in 1962, increasing rapidly to 457 boats in 1971 (Huang 1974). The major part of the effort, however, has shifted from the Pacific Ocean to the Indian and Atlantic Oceans since 1968 (Table 1). Historic accounts of longline activities of Korea are sketchy but beginning around 1958, Korean longline vessels joined the longline fishing fleet based at American Samoa (Otsu and Sumida 1968). The longline efforts of Taiwan and Korea in the Pacific have been almost entirely in the South Pacific where almost all of their tuna are sold to two American canneries in American Samoa.

There are other fisheries which catch marlin but these are not far-ranging and their catches are relatively small. A Hawaiian longline fishery, which was started in 1917 (June 1950), reached a peak of 76 boats in 1950 and declined to 18 boats in 1977.¹ The marlin catch in this fishery is primarily striped marlin and secondarily blue marlin. A few black marlin are also caught.

A harpoon fishery for striped marlin has existed in Japan since ancient times (Ueyanagi 1974). The Japanese introduced the harpoon techniques to Taiwan in 1913 (Huang 1974). Sport trolling for marlins in the Pacific had its beginnings in the early years of this century. California, Australia, and New Zealand were centers at that time. In the past 30 years, sport fishing for marlins has experienced a spurt in

¹Fishery management plan for billfish and associated species. Western Pacific Fishery Management Council, Honolulu, Hawaii. September 1980 draft.

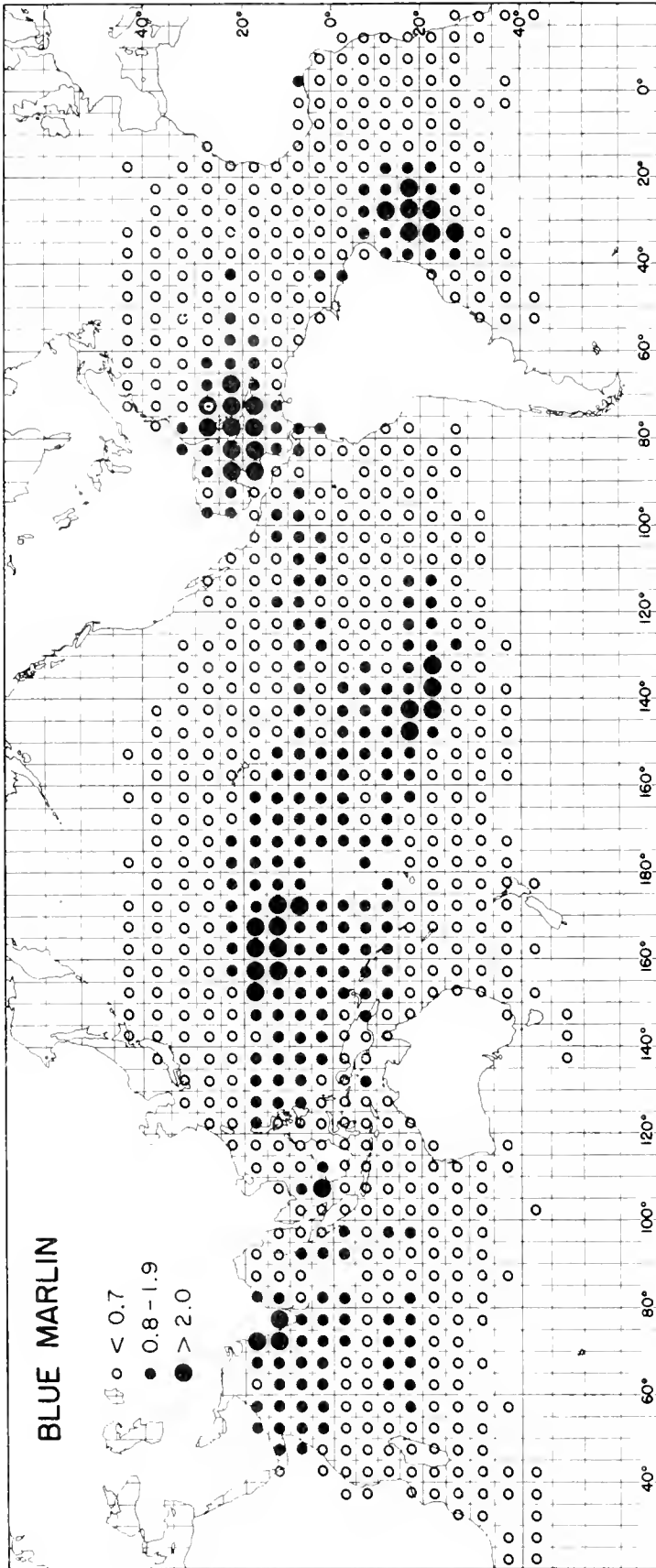

Figure 1.--Distribution of blue marlin in the Pacific Ocean. The circles indicate mean catch rates (number of fish per 1,000 hooks). (From Shomura 1980.)

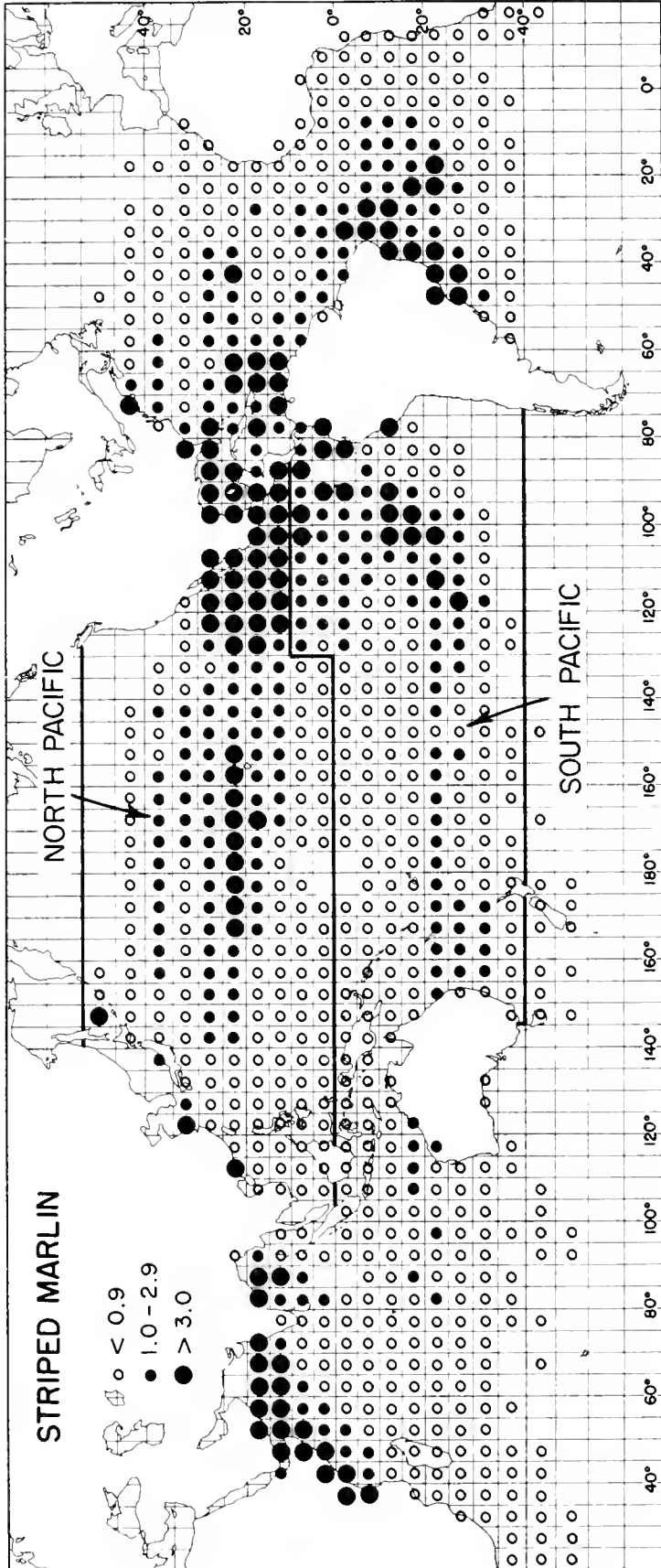

Figure 2.--Distribution of striped marlin in the Pacific Ocean. The circles indicate mean catch rates (number of fish per 1,000 hooks). Also shown are the boundaries of the hypothesized stocks. (From Shomura 1980.)

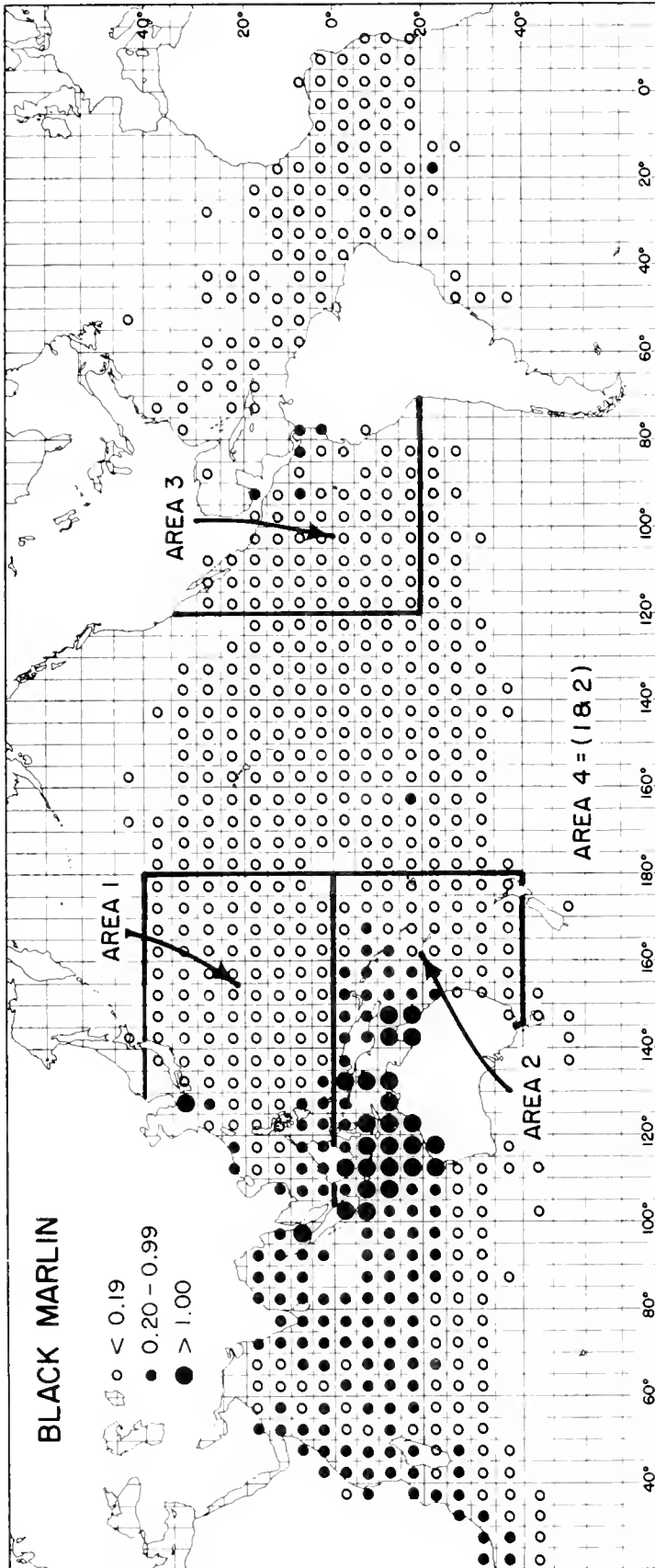

Figure 3.--Distribution of black marlin in the Pacific Ocean. The circles indicate mean catch rates (number of fish per 1,000 hooks). Also shown are the boundaries of suggested black marlin stocks. (From Shomura 1980.)

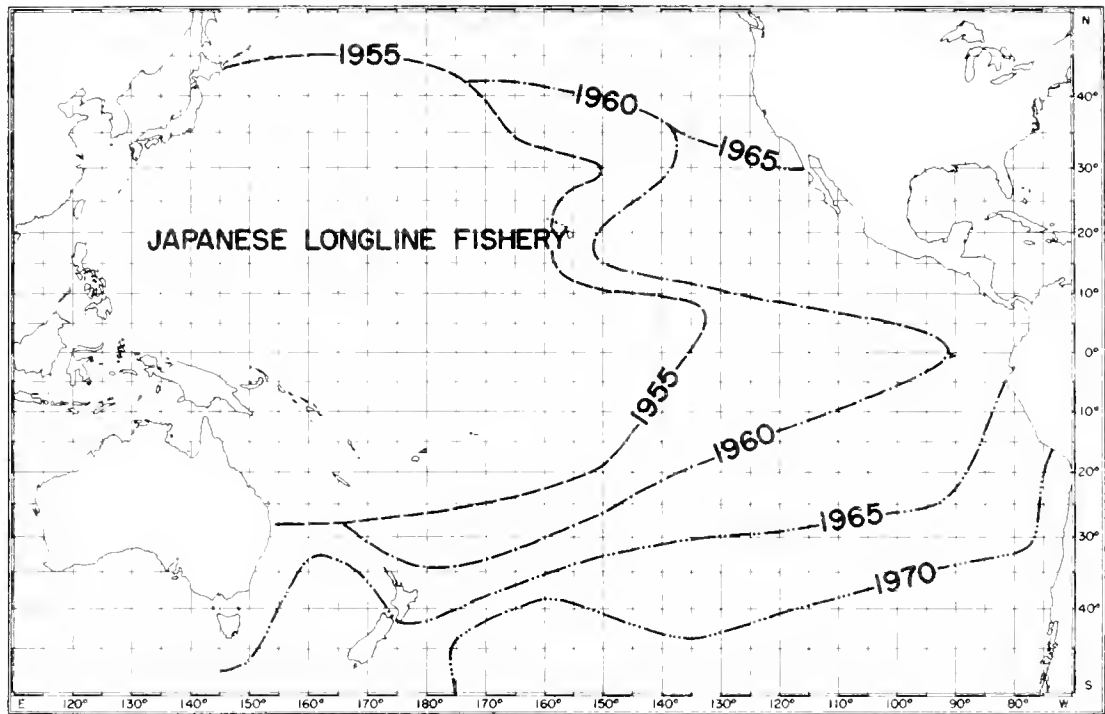

Figure 4.--Expansion of Japanese longline fishing in the Pacific Ocean.
(From Kume 1972.)

Table 1.--Distribution of fishing efforts of Taiwan deep-sea longline fleet, 1967-71. (From Huang 1974.)

Year	Number of vessels	Fishing trips			
		Total	Pacific	Indian	Atlantic
1967	254	570	380	169	21
1968	333	1,007	359	467	181
1969	396	1,158	298	576	284
1970	418	1,258	435	539	284
1971	457	¹ 1,182	495	409	278

¹Estimated.

Table 2.--Total Pacific catch (metric tons) of marlin by species, 1952-76. (Data for 1952-75 from Shomura 1980.)

Year	Striped marlin	Blue marlin	Black marlin
1952	4,994	15,525	1,806
1953	3,789	17,250	3,188
1954	7,256	10,519	5,370
1955	7,075	24,190	5,379
1956	7,724	18,770	6,466
1957	7,150	23,500	6,376
1958	8,999	22,106	4,548
1959	8,986	20,275	3,081
1960	7,362	18,155	2,721
1961	10,084	26,581	3,170
1962	13,685	30,743	4,066
1963	16,944	31,344	3,180
1964	23,480	23,233	2,805
1965	24,017	18,585	4,039
1966	20,967	18,588	3,729
1967	22,050	17,233	2,836
1968	27,143	15,283	3,547
1969	21,706	17,427	2,546
1970	24,221	20,115	2,207
1971	24,264	13,342	2,674
1972	14,541	15,300	3,424
1973	15,407	17,285	3,720
1974	14,669	15,594	3,048
1975	16,279	12,546	2,796
1976	17,032	14,813	3,132

technology as well as popularity. Centers of activity for the various species include Mexico, New Zealand, and California for striped marlin; Hawaii, Tahiti, and Guam for blue marlin; and Australia and Chile for black marlin. In addition, the number of marlin anglers is increasing in Fiji, Papua New Guinea, and Japan. Marlin fishing in the Pacific attracts sport fishermen from all over the world.

I.B. Trends in Catch and Effort

Blue marlin--Catches increased from 15,525 metric tons (mt) in 1952 to a peak of 31,344 mt in 1963 (Figure 5 and Table 2). Since then catches have fluctuated, generally declining to 14,813 mt in 1976. Effective fishing effort increased from 50 million hooks in 1952 to about 269 million hooks in 1963 and fluctuated around 200 million hooks from 1964 to 1975 (Figure 6).

Striped marlin--From 4,994 mt in 1952, catches reached a high of 27,143 mt in 1968 (Figure 7). In 1972 the striped marlin catch dropped abruptly to 14,541 mt and has hovered about 15,000 mt since. Total effective fishing effort (Figure 8) showed an increasing trend from 1952 through 1964. Since then fishing effort has fluctuated between 100 and 200 million hooks.

Black marlin--The catch rose from 1,806 mt in 1952 to a high of 6,466 mt in 1956 (Figure 9). It then fluctuated between 2,207 and 4,066 mt from 1959 to 1976. Effort data were summarized for four Pacific areas: northwestern (Area 1), southwestern (Area 2), eastern (Area 3), and western (Area 4, a combination of Area 1 and 2) (see Figure 3). Effective fishing effort from 1952 to 1975 has been erratic and does not show any discernible trend in Areas 1, 2, and 4 (Figure 10). In the eastern Pacific (Area 3), where the Japanese tuna fishery commenced in 1956, effort has been on a generally increasing trend.

I.C. Value of Catch

The ex-vessel prices of marlin from January 1978 to May 1979 at Yaizu, Japan, show striped marlin to be the most valuable of the three species (Table 3). During that period, striped marlin prices ranged from \$2,316 to \$4,345 a short ton. Blue marlin usually commanded a better price than black marlin, selling for \$1,933 to \$3,165 a short ton. Black marlin prices fluctuated between \$1,638 and \$2,744 a short ton.

I.D. Current Management of the Fishery

The marlins are under no management scheme at present. A Preliminary Management Plan for Pacific Billfishes, which sets optimum

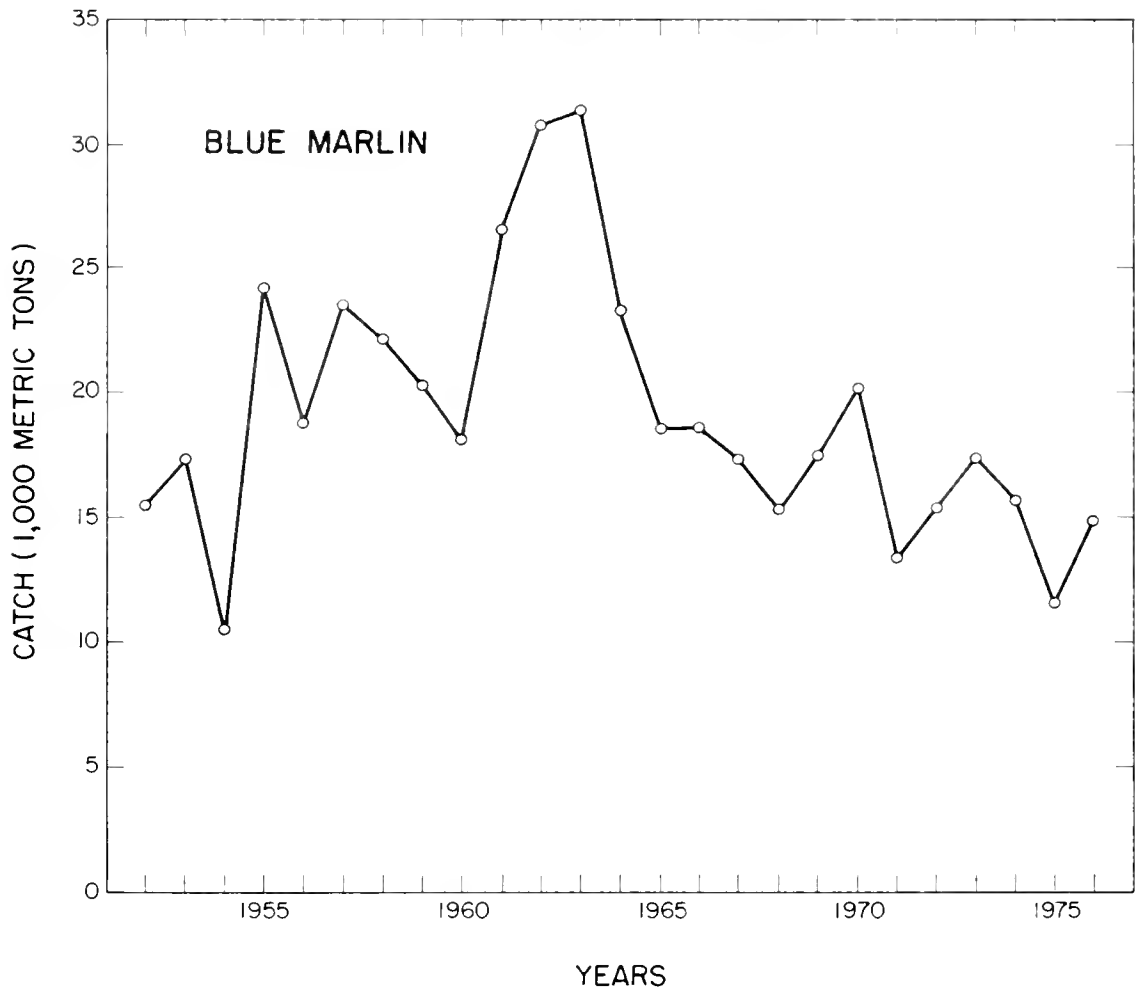

Figure 5.--Pacific catch of blue marlin, 1952-76. (Data from Table 2.)

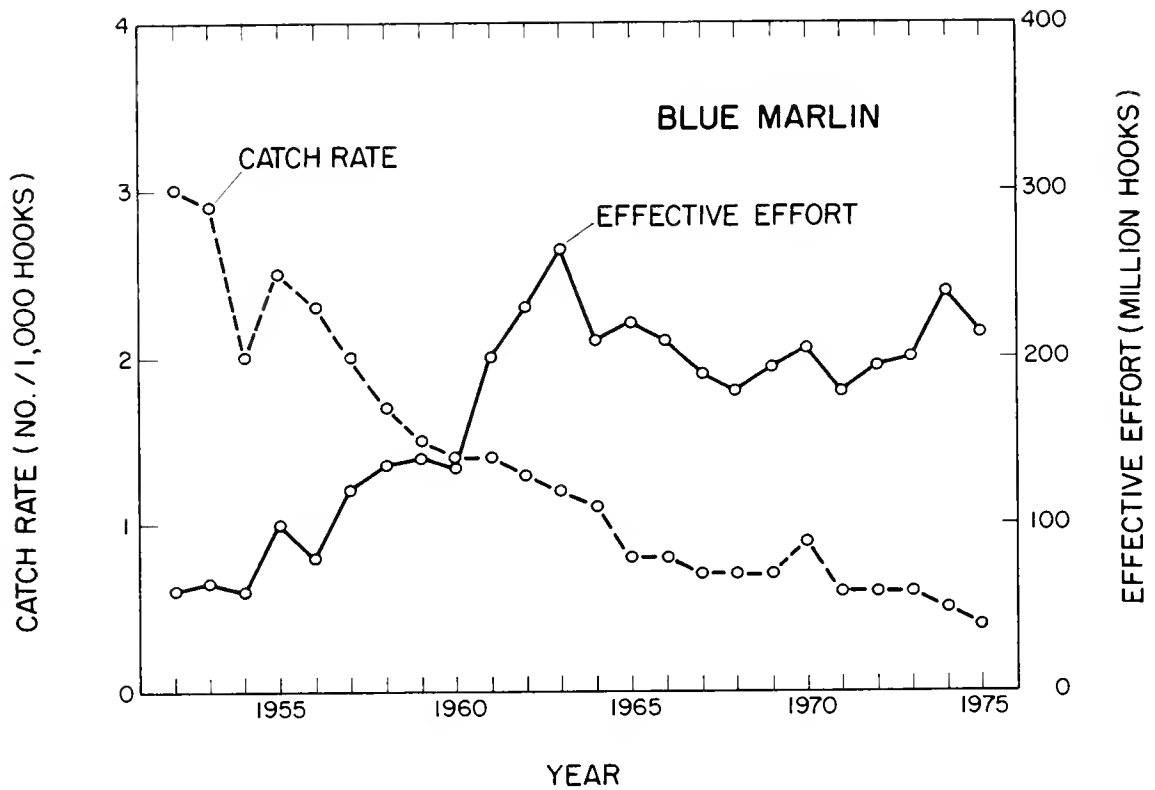

Figure 6.--Catch rate and effective fishing effort for blue marlin in the Pacific Ocean. (From Shomura 1980.)

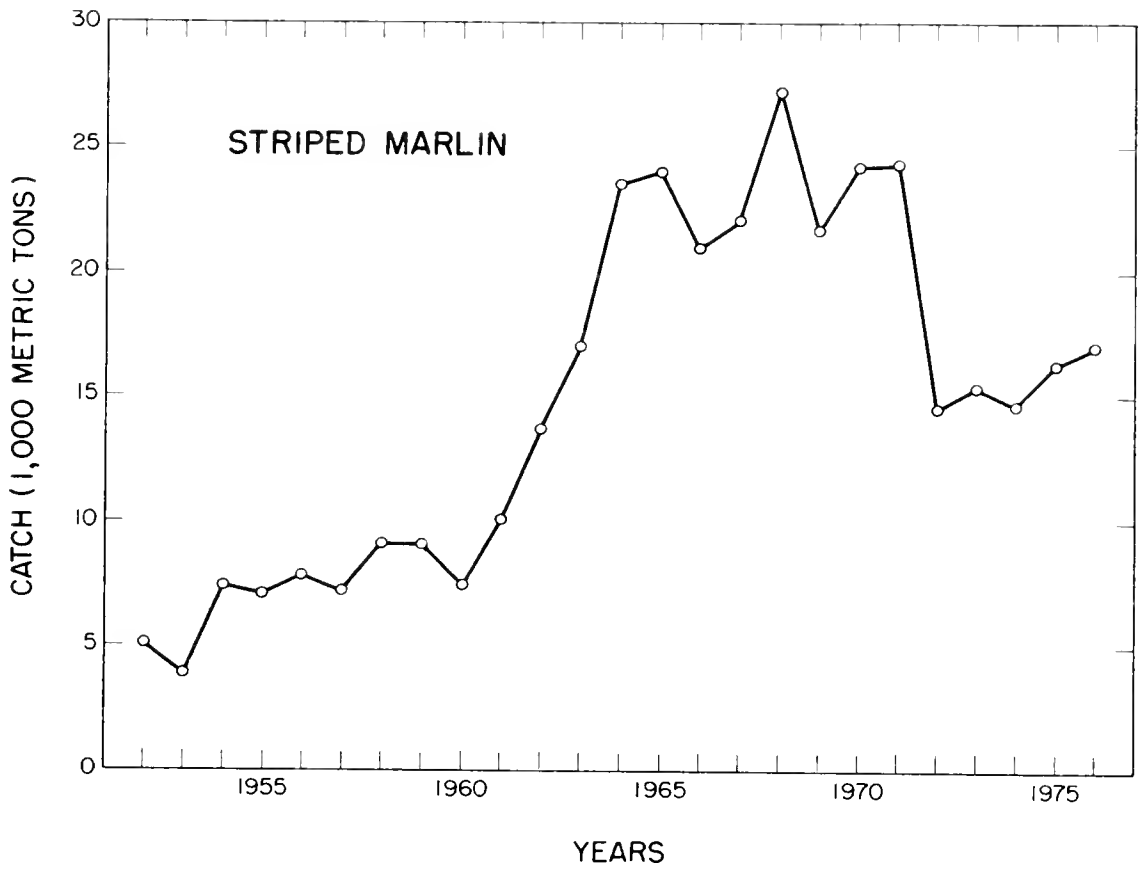

Figure 7.--Pacific catch of striped marlin, 1952-76. (Data from Table 2.)

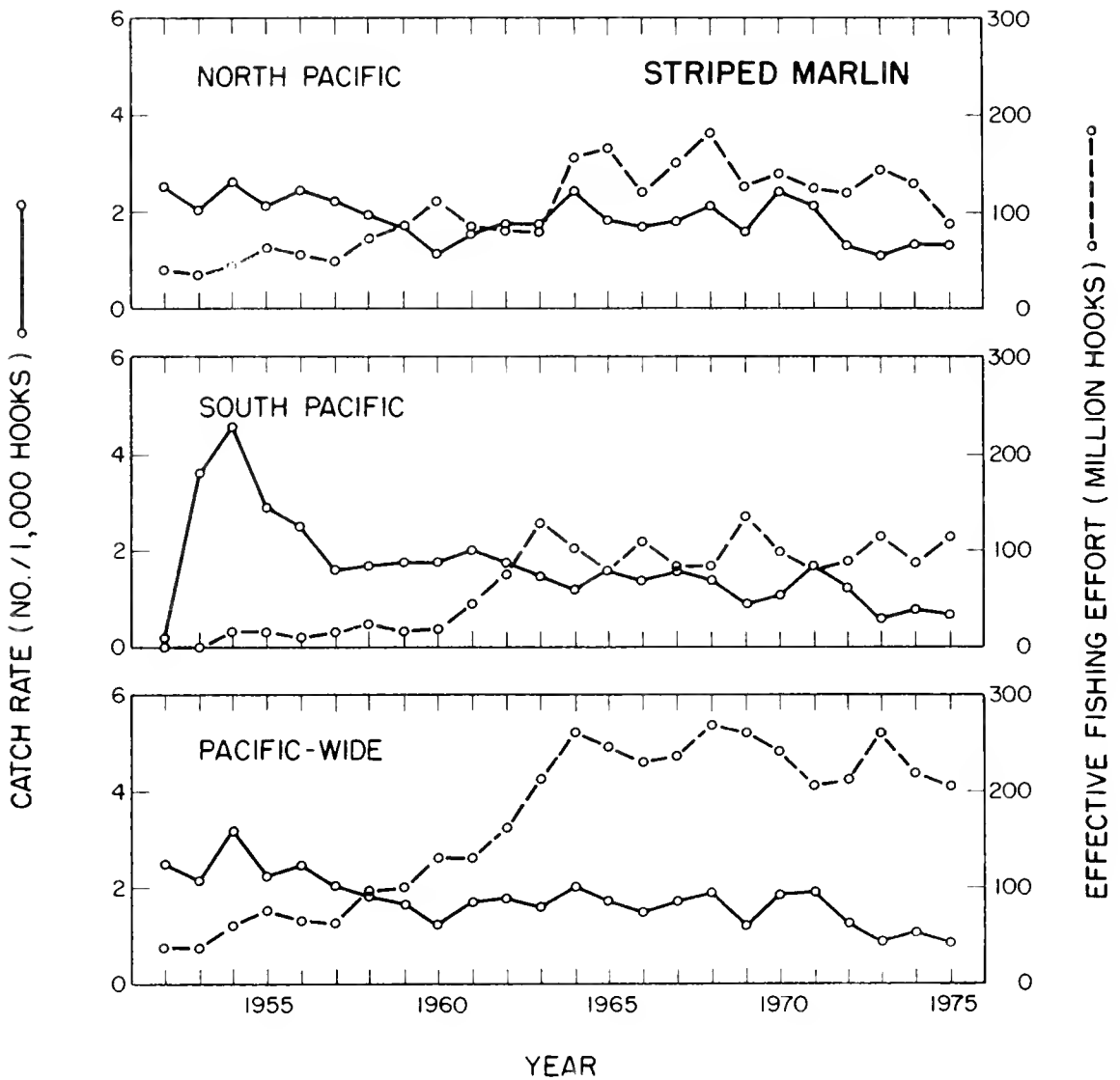

Figure 8.--Catch rates and effective fishing effort for striped marlin in the Pacific Ocean, 1952-75. (From Shomura 1980.)

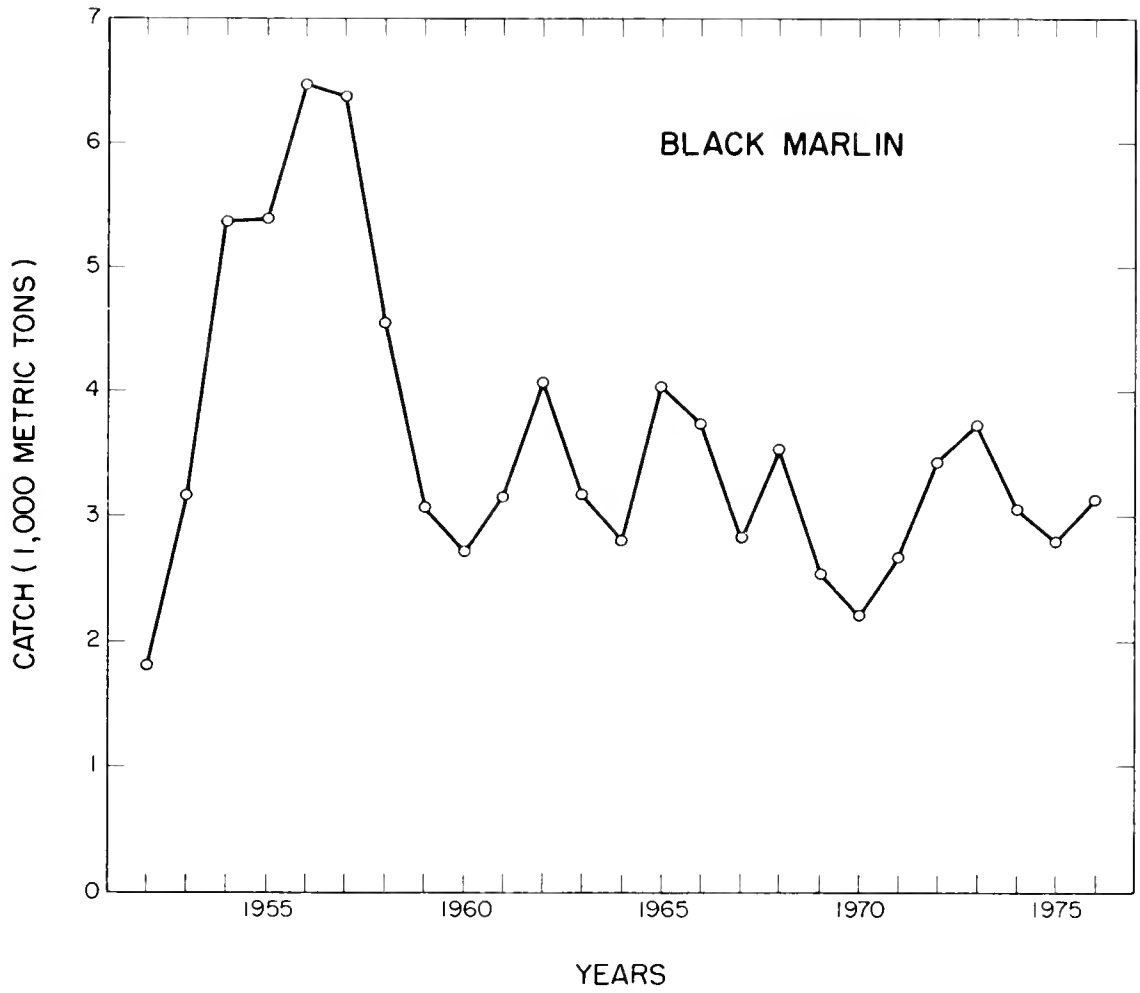

Figure 9.--Pacific catch of black marlin, 1952-76. (Data from Table 2.)

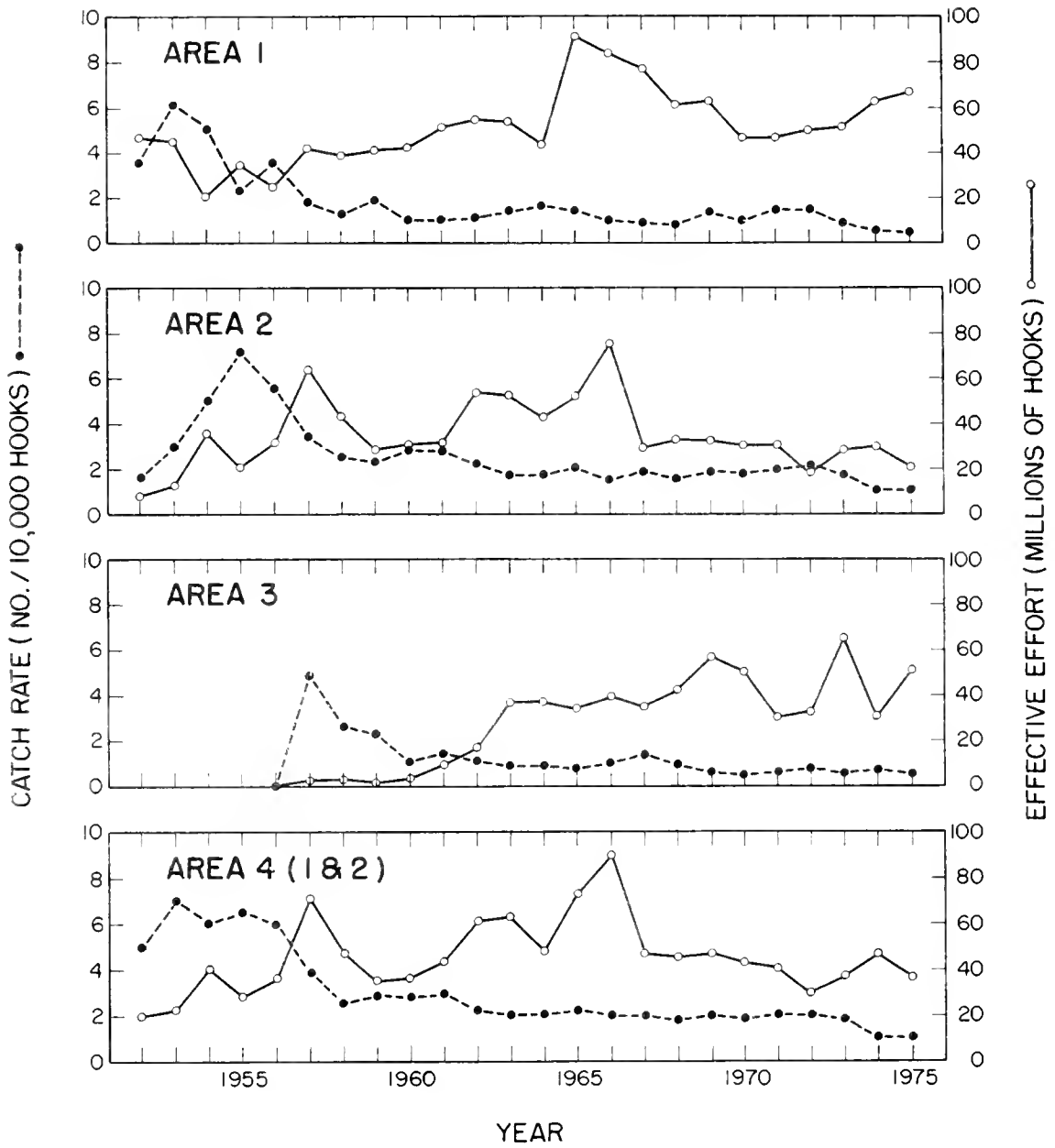

Figure 10.--Catch rates and effective fishing effort for black marlin in the Pacific Ocean, 1952-75. (From Shomura 1980.)

Table 3.--Ex-vessel marlin prices (U.S. dollars per short ton) in Japan, January 1978-May 1979. (From [U.S.] National Marine Fisheries Service 1978-1979.)

	Striped marlin	Blue marlin	Black marlin
1978			
January	3,482	2,009	2,605
February	2,823	2,326	2,070
March	3,452	2,299	2,025
April	2,722	2,515	2,082
May	2,614	2,112	1,929
June	2,462	1,991	2,090
July	4,345	2,122	2,272
August	2,507	2,275	1,638
September	2,903	2,039	1,943
October	2,856	2,412	2,055
November	3,981	3,165	2,202
December	2,698	2,323	1,934
1979			
January	4,141	1,933	2,744
February	4,046	2,027	2,059
March	4,095	2,510	1,871
April	2,316	2,658	1,730
May	2,489	2,626	1,818

yields for all the species of billfishes in the U.S. Fishery Conservation Zone around Hawaii, American Samoa, Guam, and California, is now in force.

II. NATURE AND SIGNIFICANCE OF U.S. AND FOREIGN PARTICIPATION IN THE FISHERY

The marlins are prized game fishes. Although the U.S. interest in marlins is primarily of a recreational nature, the commercial aspects of the marlin fishery are not to be ignored. In 1976 the sale of striped, blue, and black marlins brought about \$332,000 in revenue to the fishermen in Hawaii.¹

III. STATUS OF THE STOCKS

III.A. Stock Structure

Blue marlin--Available evidence seems to indicate that the blue marlin comprise a single equatorially-centered stock in the Pacific. Concentrations of blue marlin occur alternately at locations on both sides of the equator during the respective summer seasons. The large, apparently single area of blue marlin spawning in the western Pacific, which includes areas of high spawning densities in the west and declining densities to the east, has been suggested as evidence for the unit stock assumption. Confirmation of the unit stock of blue marlin stock structure hypothesis is needed.

Striped marlin--Although the stock structure of the striped marlin in the Pacific is not clear, two likely hypotheses have been advanced: 1) a single-unit stock suggested by the continuous, horseshoe pattern of striped marlin distribution in the Pacific, and 2) a two-stock structure, where a North Pacific stock and a South Pacific stock are separated roughly at the equator, with some intermixing in the eastern Pacific (Figure 2).

Black marlin--The stock structure of black marlin in the Pacific is unclear, but their restricted coastal distribution and the occurrence of isolated high catch-rate areas suggest the possibility of more than one stock. It has been suggested that two or three stocks exist: one in the eastern Pacific and two in the western Pacific (Figure 3). The situation is complicated by the strong possibility that black marlin from the Indian Ocean mix with fish from the western Pacific.

III.B. Stock Assessment and Fishery Evaluation

III.B.1. Trends in Catch-per-Unit-Effort

Blue marlin--The catch-per-unit-effort steadily declined from 3.0 fish/1,000 hooks in 1952 to about 0.5 fish/1,000 hooks in 1975 (Figure 6).

Striped marlin--The catch rate for the entire Pacific showed a slow, long-term decline from 1952 to 1975. The catch rate in the North and South Pacific showed long-term declines since the 1950's (Figure 8).

Black marlin--The catch rate in the northwestern Pacific (Area 1) reached a peak in 1954 and declined to its lowest in 1975 (Figure 10). In the southwest (Area 2), the catch rate reached a peak in 1955, declined to less than 4 fish/10,000 hooks in 1957, then fluctuated between 1 and 3 fish/10,000 from 1958 to 1975. The catch rate in the east (Area 3) reached a peak in 1957 and declined thereafter. The western Pacific (Area 4) catch rate reflected the same trends as its constituent areas (Areas 1 and 2).

III.B.2. Results of Production Model Analysis

The following discussion of production model analyses on the stocks of blue marlin, striped marlin, and black marlin is based on the results of the Billfish Stock Assessment Workshop held at the Honolulu Laboratory from 5 to 14 December 1977 (Shomura 1980).

Blue marlin--Based on the assumption that the blue marlin in the Pacific comprises a single oceanwide stock, production model analysis gives a MSY estimate of 22,000 mt, which is associated with an effective fishing effort equal to about 50% of the 1975 total effective effort (Figure 11). This result, combined with the steadily decreasing catch-per-unit-effort in spite of increased fishing effort, indicates the stock is overfished (Shomura 1980).

Striped marlin--Assuming a single, oceanwide stock, the MSY estimate is 24,000 mt at an optimum effective effort of 3.4 million hooks/5° square (Figure 12). Considering the 1964-1975 catches of 14,500 to 27,100 mt at an average effective effort of 1.5 to 2.25 million hooks/5° square, the MSY estimate infers a striped marlin population that is not being overexploited.

Assuming a two-stock population structure, a North Pacific stock and a South Pacific stock, the results of the production model analysis indicate a perplexing picture for the North Pacific stock and a South Pacific stock that is being fished at about optimum level (Figure 12). The catches in the South Pacific for 1973-75, however, were

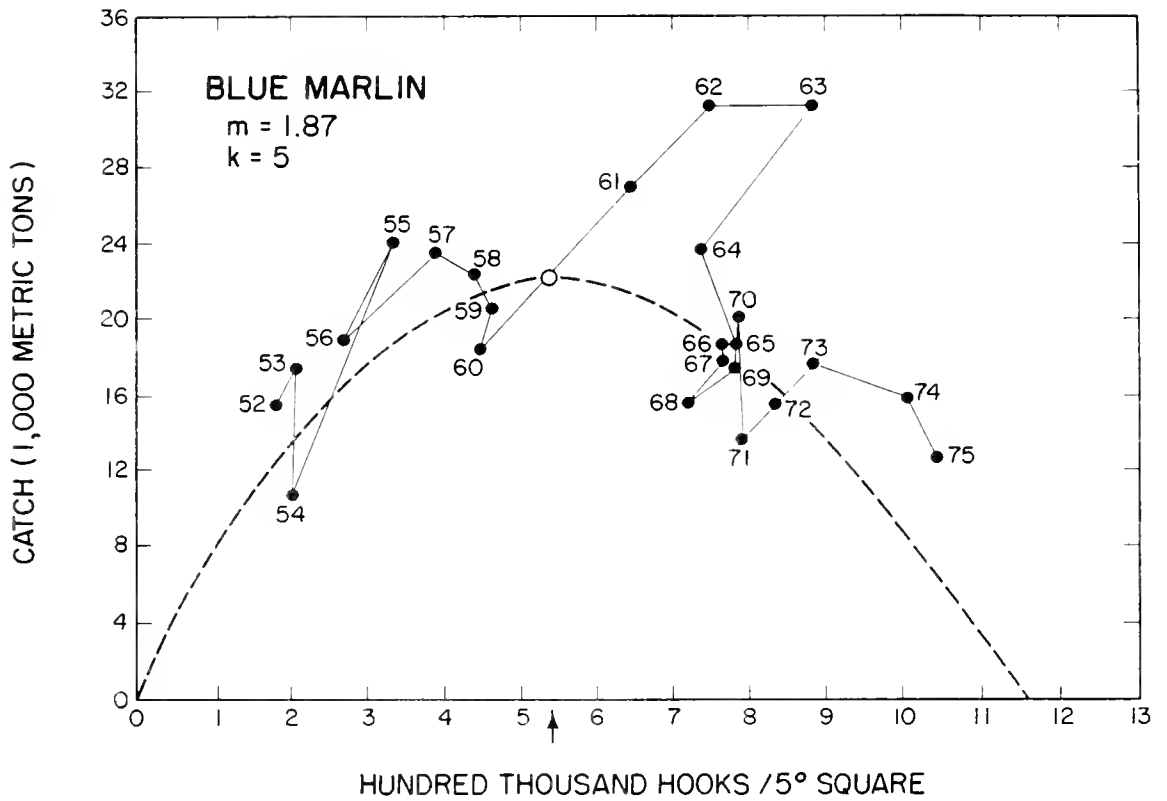

Figure 11.--Relation between catch of blue marlin and effective fishing effort. The equilibrium yield curve is based on the production model. (From Shomura 1980.)

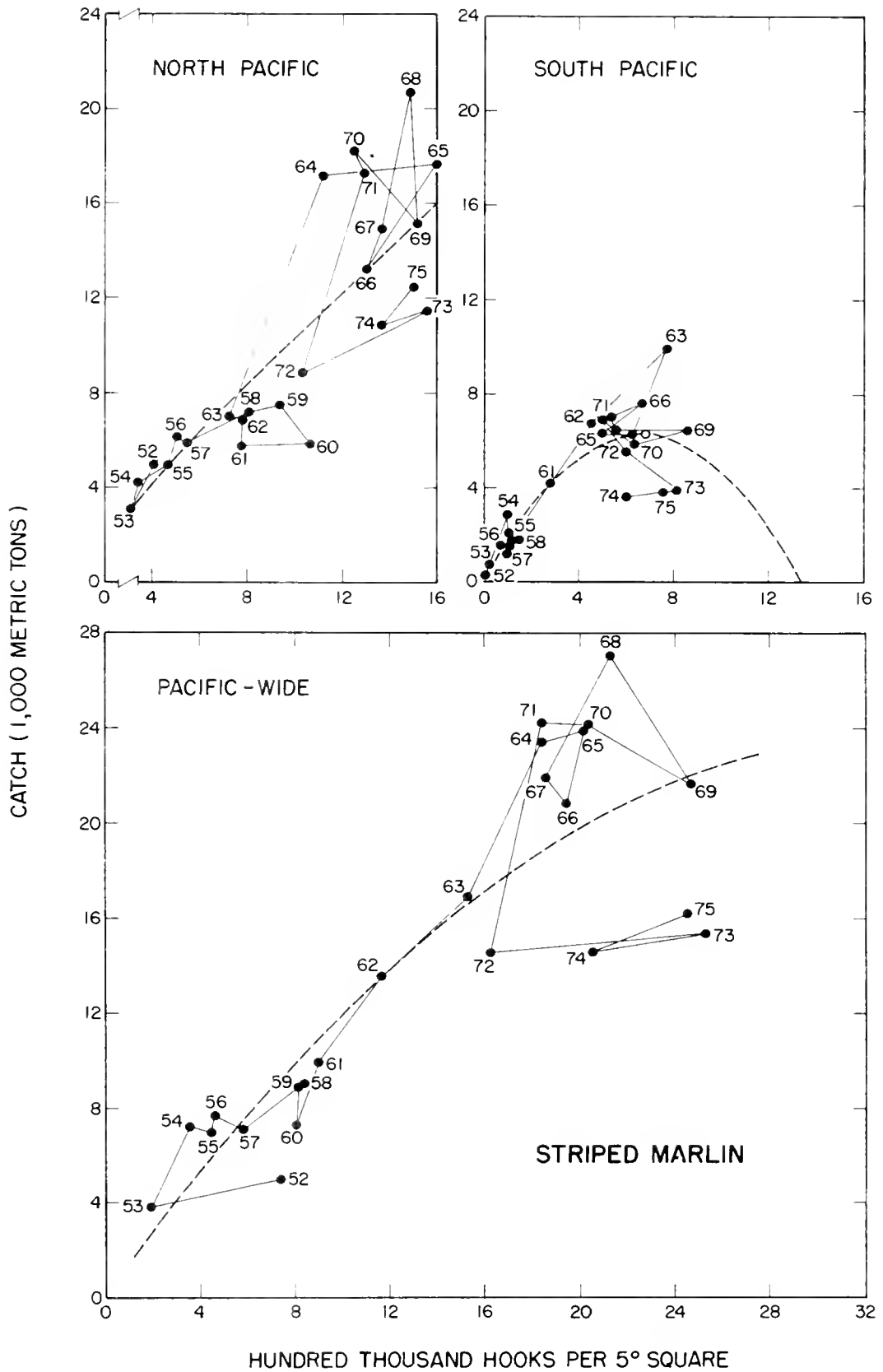

Figure 12.--Production models for hypothesized striped marlin stocks in the Pacific Ocean. (From Shomura 1980.)

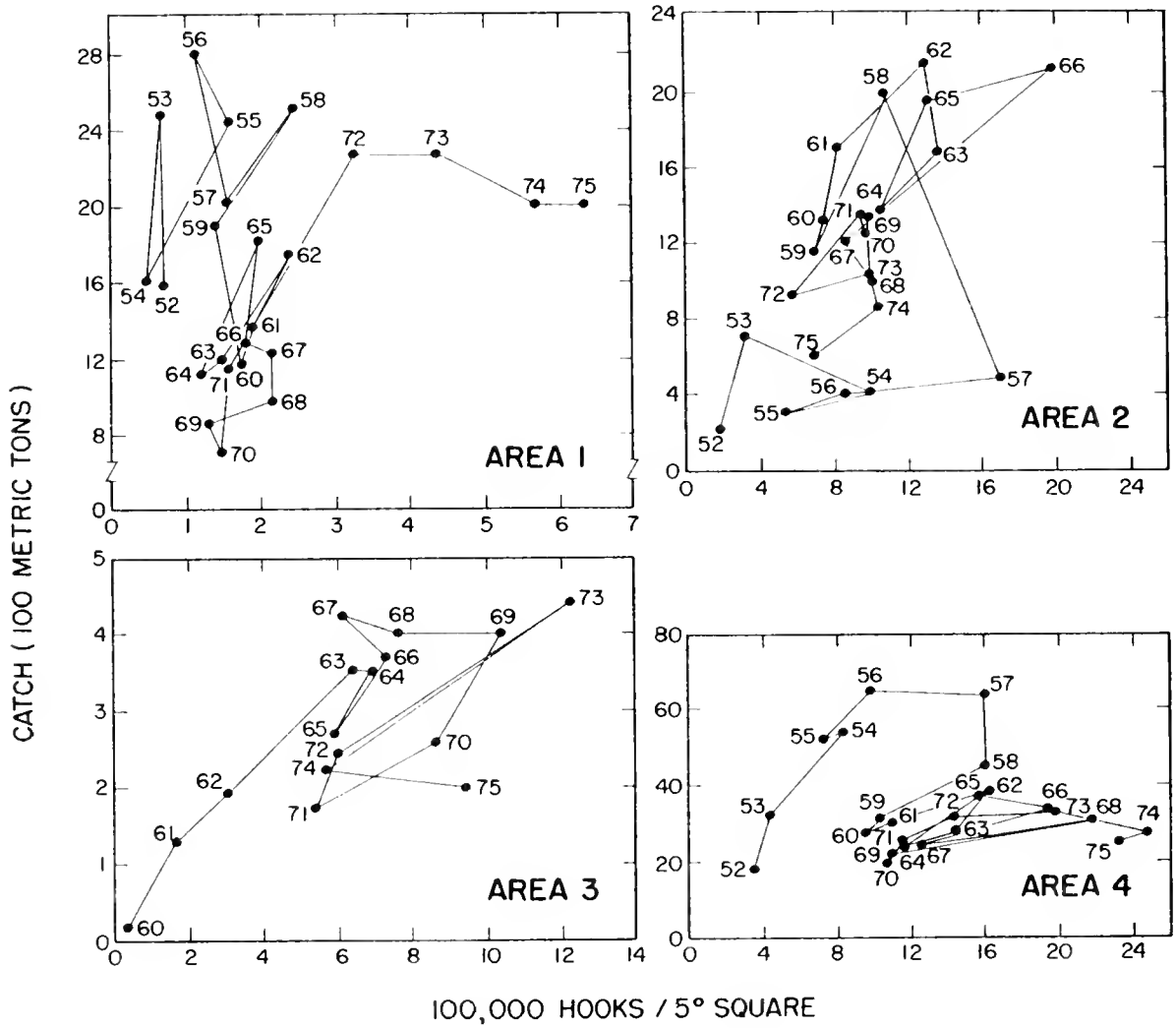

Figure 13.--Relation between catch and effective effort for black marlin in four areas in the Pacific Ocean. (From Shomura 1980.)

far below the equilibrium yield curve. Further research is needed to determine the reason for the low catches before an accurate interpretation of the results can be made. For the North Pacific stock, the MSY estimate was 70,000 mt at an optimum effective effort of 13.2 million hooks/5° square. This effort seems unreasonably high in light of the maximum of 1.5 million hooks/5° square fished through 1975.

Black marlin--Because of uncertainties in the data on total catch and the stock structure of black marlin in the Pacific, no attempt was made to fit production models or to estimate MSY for black marlin in any area of the Pacific. The relation between estimated catch and effort (Figure 13) indicated that a reliable production model analysis will require a better accounting of the catches.

III.B.3. Results of Yield-per-Recruit Analysis

None available.

III.B.4. Results of Spawner/Recruitment Analysis

None available.

III.B.5. Results of Other Analyses/Simulations

None available.

III.C. Current Evaluation of Stocks and the Fishery

Blue marlin--The declining catch-per-unit-effort and the results of the production model analysis suggest that the Pacific blue marlin stock is being overfished.

Striped marlin--On a Pacific-wide basis, the striped marlin stock appears to be in good condition and may be capable of producing increased yields with a modest increase in fishing effort. The outlook for increased yields is better for the North Pacific fishery than for the fishery in the South Pacific, which may be operating at or beyond the level of MSY.

Black marlin--While no attempt was made to fit production models or estimate MSY for black marlin stock(s) in the Pacific, the substantial decline in catch rates during the period from the early 1950's to 1975 suggests that a very large increase in total catch over levels in the early 1970's is probably not sustainable.

IV. STATUS OF CURRENT RESEARCH NEEDS AND EFFORTS

IV.A. Major Research Problems

Population assessments for all three species were based on incomplete catch and effort data. Better assessments are needed, particularly of the black marlin. Yield-per-recruit and cohort analyses would contribute more definitive assessments of the populations. For these analyses, size-at-age relationships need to be confirmed for blue and striped marlins and need to be obtained for black marlin. Also needed are estimates of population parameters, e.g., natural and fishing mortality rates, recruitment rates, etc.

Another problem related to population assessment is the lack of knowledge of the stock structures of these species, although it may be possible to circumvent the need for precise stock identification. The Billfish Stock Assessment Workshop (Shomura 1980) recommended the use of simulation studies to evaluate the sensitivity of stock assessments to various stock structure hypotheses on the striped marlin so that the need for a stock identification program might be determined. Should such studies prove to be effective for striped marlin, they should be considered for the blue marlin and black marlin as well.

IV.B. Current Research Efforts

The first attempts to assess the status of blue marlin, striped marlin, and black marlin stocks were described in background papers submitted to the Billfish Stock Assessment Workshop (Shomura 1980). The need for further research on the billfishes was stressed at the workshop but, aside from routine data collecting efforts, no real effort is being expended to update the stock production analyses or carry out other analyses suggested at the workshop.

IV.C. Future Research Needs

Detailed data on growth, mortality, reproductive rates, and other vital determinants of population dynamics which are required for a complete understanding of the effects of fishing on stock productivity and catch, are not available for Pacific billfishes such as the blue marlin, black marlin and striped marlin. Limited data on size composition and growth rates are available, as well as some statistics on nominal fishing effort and catch. These permit only tentative assessment of the stocks. Effort is therefore needed to upgrade these assessments and to define better the stock structure of the marlin species in the Pacific.

IV.C.1. Suggested Approach and Methods

1) The assessment of the billfish stocks was based on various assumed stock structures and computed measures of effective fishing effort, a statistic which is assumed to be proportional to fishing mortality. These assumptions are difficult to test and verify. Computer simulations to examine the sensitivity of stock assessment conclusions to changes in assumptions should be carried out.

2) While tagging experiments provide some of the necessary information on stock structure, the low catch rates of marlins in commercial and recreational fisheries suggest that other techniques are probably more suitable, e.g., immunogenetic methods.

IV.D. Status of SWFC Data Base

The data base maintained at the Honolulu Laboratory includes billfish catch and effort data from the Japanese and Taiwan longline fisheries in the Pacific. The longline operations of Korea, however, are poorly documented.

All nations with billfish fisheries should be urged to update or establish sampling programs to insure the collection of adequate statistics, including 1) total catch by species, gear, type of fishing operation, and ocean region; 2) total nominal effort by gear, type of fishing operation, and ocean region; 3) catch-per-unit-effort by effort, small area-time strata, gear, and type of fishing operations; and 4) size and sex composition of the catches by species and by small area-time strata.

LITERATURE CITED

Huang, H. C.

1974. Billfish fishery of Taiwan. In R. S., Shomura and F. William (editors), Proceedings of the International Billfish Symposium, Kailua-Kona, Hawaii, 9-12 August 1972, Part 2. Review and Contributed papers, p. 332-335. U.S. Commer., NOAA Tech. Rep. NMFS SSPF-675.

June, F.C.

1950. Preliminary fisheries survey of the Hawaiian-Line Islands area. Part. I. The Hawaiian long-line fishery. Commer. Fish. Rev. 12(1):1-23.

Kume, S.

1972. Tuna fisheries and their resources in the Pacific Ocean. Indo-Pac. Fish. Council. Proc., 15th Sess., Sect. 3:390-423.

Otsu, T., and R. F. Sumida.

1968. Distribution, apparent abundance, and size composition of albacore (Thunnus alalunga) taken in the longline fishery based in American Samoa, 1954-65. U.S. Fish. Wildl. Serv., Fish. Bull. 67:47-69.

Shomura, R.S. (editor).

1980. Summary report of the Billfish Stock Assessment Workshop Pacific resources. NOAA Tech. Memo. NMFS-SWFC-5, 58 p.

Ueyanagi, S.

1974. A review of the world commercial fisheries for billfishes. In R. S. Shomura and F. Williams (editors), Proceedings of the International Billfish Symposium, Kailua-Kona, Hawaii, 9-12 August 1972, Part 2. Review and Contributed Papers, p. 1-11. U.S. Dep. Commer., NOAA Tech. Rep. NMFS SSRF-675.

[U.S.] National Marine Fisheries Service.

1978-1979. Foreign fishery information release. Supplement to Market News Report.

APPENDIX

LIST OF ATTENDEES
SOUTHWEST FISHERIES CENTER
TUNA RESEARCH WORKSHOP
December 15-17, 1980
San Clemente, California

OFFICE OF INTERNATIONAL FISHERIES AFFAIRS

Carmen J. Blondin
Barbara K. Rothschild

SOUTHWEST REGIONAL OFFICE

John Davies

CALIFORNIA DEPARTMENT OF FISH & GAME

Doyle Hanan

SOUTHWEST FISHERIES CENTER

Center Director's Office

Izadore Barrett
John F. Carr
David J. Mackett

Honolulu Laboratory

Roy Mendelssohn
Fletcher V. Riggs
Richard S. Shomura
Robert A. Skillman
Jerry A. Wetherall
Howard O. Yoshida

La Jolla Laboratory

Coastal Fisheries Resources Division

R. Michael Laurs

Oceanic Fisheries Resources Division

Norman W. Bartoo
Atilio L. Coan, Jr.
Richard H. Evans
Samuel F. Herrick
Anthony P. Majors
Wesley W. Parks
Ronald G. Rinaldo
Gary T. Sakagawa
James L. Souire, Jr.
Earl C. Weber

Pacific Environmental Group, Monterey

Richard H. Parrish
Paul H. Sund

