

UC-NRLF



5B 26 107

LIBRARY
OF THE
UNIVERSITY OF CALIFORNIA.

Class



THE STEAM ENGINE INDICATOR

Published by the
McGraw-Hill Book Company
New York

Successors to the Book Departments of the
McGraw Publishing Company Hill Publishing Company

Publishers of Books for

Electrical World	The Engineering and Mining Journal
The Engineering Record	Power and The Engineer
Electric Railway Journal	American Machinist

THE
STEAM ENGINE INDICATOR

BY

F. R. LOW

Editor of POWER and THE ENGINEER

THIRD EDITION, REVISED AND ENLARGED



McGRAW-HILL BOOK COMPANY

239 WEST 39TH STREET, NEW YORK

6 BOUVERIE STREET, LONDON, E.C.

1910

TJ478
L7

Copyright, 1910
BY THE
MCGRAW-HILL BOOK COMPANY

PREFACE

THE steam-engine indicator has become at once the tool of a trade and the instrument of a science. The operating engineer employs it to perfect the adjustment of valves and to measure power, the physicist to investigate thermodynamic transfers and to trace the cycle of the heat engine. It is to steam engineering at once the commercial scale and the chemical balance.

The following contributions to the literature of the instrument and its diagrams have been prepared from time to time by the writer for the columns of *Power*, and are addressed to the practical man who desires to apply the indicator as an instrument of ordinary precision to the problems of steam-engine design and operation.

F. R. LOW.

v

CONTENTS

CHAPTER I

	PAGE
SELECTION AND CARE OF THE INSTRUMENT	1
Degree of accuracy required—Lightness—Freedom from friction—Parallelism—Lost motion—Proportional movement—The spring—Size of drum—Vacuum springs—Scales—Duplicate parts—Leads—Lubrication—Paper.	

CHAPTER II

REDUCING MOTION	11
The pendulum lever—Directions for proportioning and for leading off the cord—Defects of pendulum motions—Lever of fixed length—Lever of variable length—Connection to cross-head—Distortion from improper connection—The pantograph—Adjusting the length of diagram—Setting the pantograph—Locating the pantograph—Reducing wheels—Testing the accuracy of the motion.	

CHAPTER III

APPLICATION	27
Location of instrument—Tapping the cylinder—Cock connections—Side pipes and three-way cocks—Objectionable connections—Attaching the instrument—The cord—Management of the cord—Centering the diagram—Drum tension—Preparing and fixing the lead—Selection of springs—Lubrication—Testing in position—Putting on the card—Care of instrument after use.	

CHAPTER IV

THE DIAGRAM	40
Graphic representation applied to the action of steam in the cylinder—The ideal diagram—Departures therefrom in the actual—Definition of the various lines.	

CHAPTER V

	PAGE
THE ADMISSION LINE	44
Typical admission lines—The proper form—Effect of late admission—Of tardy exhaust closure—Loops due to lateness—Loops due to excessive compression—Points at top of admission line—Effect of excessive lead.	

CHAPTER VI

THE STEAM LINE	47
The loss from boiler pressure—The desirable form—Effect of wire-drawing—Steam-chest diagrams—Locating cause of loss of pressure—Proportioning steam mains and ports—Initial humps in steam lines—Effects of increased piston speed—Throttle-governed engines—Diagrams without any steam line—Modified by the admission.	

CHAPTER VII

THE EXPANSION LINE	53
Relation of volume and pressure in a perfect fluid—Rule for finding the pressure at any point in the stroke—Plotting the expansion curve by several methods—Determining the point of cut-off—Locating the clearance line—What the theoretical expansion line shows—Departures from it in practice—Transparent chart of theoretical expansion lines and its use.	

CHAPTER VIII

THE POINT OF RELEASE	64
The desirable form—The form to be avoided—A frequently necessary compromise—Value of early release with condenser—Effect of terminal pressure—Loop from excessive expansion.	

CHAPTER IX

THE COUNTER-PRESSURE LINE	67
The unbalanced or effective pressure—Effect of pipe and port friction—Proportioning exhaust pipes and ports—Back pressure inappreciable with good design—Uniform back pressure—Effect of tardy release and compression—Humps in compression line—Effect of excessive compression.	

CHAPTER X

THE COMPRESSION LINE	70
The inverse of expansion—Same curve applicable to the ideal case—Locating clearance line from compression curve—Compression in a condensing engine—Effect of counter pressure on compression—Use of compression in taking	

up the momentum of the moving parts—Effect of compression on clearance loss—Amount of compression advisable—Typical compression lines—Loop from excessive compression—Falling off from the ideal curve—Effects of condensation and leakage.

CHAPTER XI

MEASUREMENT OF THE DIAGRAM FOR MEAN EFFECTIVE PRESSURE..... 77

The "mean effective pressure" explained—The ordinate method—Spacing the ordinates—Measuring the ordinates—Use of parallel rules and engineer's scales—Measuring negative loops.

CHAPTER XII

THE PLANIMETER..... 83

The mean height of the diagram is proportional to the mean effective pressure—Reducing the diagram to its mean height from its known area—Use of planimeter for determining area—Description of instrument—Reading the vernier—Best position for use—Tracing the diagram—Treatment of loops—Checking the readings—Measuring the length of the diagram—Rule to find the mean effective pressure—Planimeters with adjustable tracing arms—Reading directly in horse-power—Directions for making and using the hatchet planimeter—The Coffin averaging instrument.

CHAPTER XIII

COMPUTING THE HORSE-POWER..... 96

Force—Work—The foot pound—The horse-power—Simple formula for horse-power—Rules and examples—The horse-power constant—Rule for finding same—Table of horse-power constants—Use of table—Allowing for the piston rod—The power of the individual strokes—Balancing the effort.

CHAPTER XIV

MEAN EFFECTIVE PRESSURE AND POINT OF CUT-OFF BY COMPUTATION..... 113

Relation of hyperbola to containing rectangle—Directions for finding the mean pressure represented by an ideal diagram of a given pressure and ratio of expansion—Allowing for departures from the ideal—Table for computing mean and initial pressures, points of cut-off, ratios of expansion and clearance—Examples—The effect of clearance—The real and apparent ratios of expansion.

CHAPTER XV

STEAM CONSUMPTION FROM THE DIAGRAM..... 119

Volume generated per hour per horse-power—Value of that volume in pounds of steam—Correction of volume for clearance—Rule to find steam con-

sumption from diagram—Example—Table of values of $\frac{13750}{M.E.P.}$ —Volume of new steam indicated by distance between expansion and compression lines—Rule for determining consumption by this line—Computing steam consumption from compound engine diagrams.

CHAPTER XVI

DIAGRAMS FROM COMPOUND ENGINES, CLEARANCE NEGLECTED 134

Use of different scales for the different cylinders—Reducing diagrams to the same scale—Comparison of diagrams in this condition—Reduction of diagram to same scales of volumes—The combined diagrams—Comparison of the combined diagram with the ideal.

CHAPTER XVII

DIAGRAMS FROM COMPOUND ENGINES, CLEARANCE CONSIDERED 139

Locations of the diagrams with reference to the line of zero volume—Relation of the steam line of the low-pressure diagram to the counter-pressure line of the high—Effect of receiver capacity—Effect of change of load—Effect of varying cut-off in low-pressure cylinder.

CHAPTER XVIII

ERRORS IN THE DIAGRAM 145

Error from the use of the pendulum motion—Error with lever of fixed length vibrating 90°—Error with same lever vibrating 35° to 40°—Amount of error allowable—Error from lack of parallelism between cord and guides—Error due to indirect connection of indicator.

CHAPTER XIX

MEASURING THE CLEARANCE 155

Direction for measuring by equal volumes of water—Correction for riser pipe—By calculated volume of water—By weight of water—By time required to fill—Professor Sweet's method of equal weights—Diagram to determine without calculation the proportion of clearance to displacement.



THE STEAM ENGINE INDICATOR

CHAPTER I

SELECTION AND CARE OF THE INSTRUMENT

THERE are at this writing nine or ten different steam engine indicators upon the market. As a guide to its readers in determining which of these is best suited to their purpose, it shall be the province of this work only to specify the requirements of a perfect instrument, point out the possible sources of error in the instrument as made, detail the methods of testing for such faults, and leave the reader to purchase the degree of accuracy necessary for his purpose at the lowest available price.

For certain classes of work, such as the ordinary setting of valves, the measurement of horse-power for purposes of daily record in factory work, etc., extreme accuracy is not essential. A man does not buy a chemist's balance to weigh sugar, nor an expensive chronometer for a kitchen clock. An instrument which is ordinarily correct will answer many purposes to which an indicator may be advantageously applied, and its inherent errors will probably be less than those of manipulation and observation.

For other classes of work, however, the utmost attainable precision must be insisted upon, and the very best instruments made are not good enough. In a 72-inch low-pressure cylinder there will be developed over 100 horse-power per pound of mean effective pressure. The variation of one one-hundredth of an inch in the mean height of a diagram from one end of this cylinder would mean, with a 10-pound spring, a difference of over five horse-power in the result. If this engine were in a vessel, built as others have been with a bonus or forfeit of one hundred dollars per horse-power above or below that called for in the contract, the omney involved in its exact determination would warrant the extreme of expense and pains in securing the utmost attainable precision in the measuring instruments.

In a perfect indicator the pencil should, by its vertical position on the diagram, represent exactly the pressure beneath the indicator piston at any instant; and by its horizontal position, the point which the piston has reached in its stroke at the same instant. This simple condition is impossible of attainment in practice, from the fact that the materials of which indicators are made have mass. As soon as they are put into motion we have momentum to carry both the pencil and the drum away from the point to which they would have been carried by the pressure and reducing-motion alone, and their inertia to prevent their instantaneous response to a change in conditions.

Lightness.—It may, therefore, be concluded that, other things being equal, that instrument will give the best results in which the least weight is moved through the least distance for the production of diagrams of equal size; assuming always that enough material is used to give the necessary strength and rigidity.

Freedom from Friction is a quality that an indicator should possess in the greatest possible degree. Detach the piston and see that the pencil

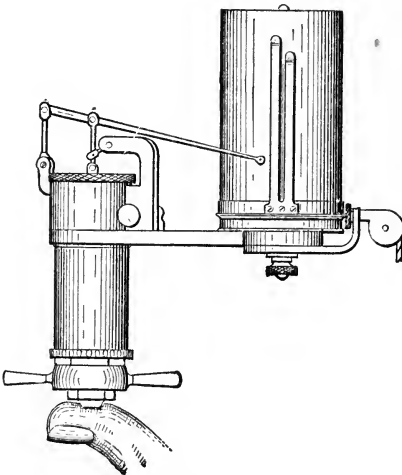

FIG. 1.

levers will drop freely and without any suspicion of a catch from any position within the working range of the instrument. With the piston attached, but without any spring, raise the piston by taking hold of the pencil delicately, and work the pencil lever up and down through the full limit of its motion, feeling carefully for any interruption to its movement. Then raising the pencil nearly to the top of the paper-drum, cover the hole through which steam is admitted to the indicator with the thumb, as in Fig. 1. The pencil should sink slowly through the whole range of its motion, but

should drop instantly from any point upon the removal of the thumb.

Do not get the piston too tight through fear of its leaking. It has a whole boilerful of steam behind it part of the time, and a large volume always, and no noticeable difference in pressure will result from any leakage which can take place unless the leakage is so excessive as to increase the pressure on top of the piston. On condensing engines the vacuum, as indicated by the indicator, may be materially

reduced if the piston is too loose, and it is unpleasant and uncleanly to have too much steam and water leaking and spattering about the instrument. The piston which will sustain the test shown in Fig. 1 will be found tight enough without excessive friction.

Parallelism.—The line in which the point of the pencil moves should be parallel with the axis of the paper-drum, in order both that the pencil may bear upon the paper equally in all portions of its stroke, and that its vertical movement may be at right angles with the horizontal movement of the paper. With the piston attached but with no spring, adjust the stop so that you can just see daylight between the point of the pencil and the paper on the drum. Then raise the pencil slowly through its full range by pushing the piston, and notice if the pencil point keeps the same distance from the paper. If it does not, either the spindle of the barrel is out of line with the indicator cylinder, or the pencil motion is out of line. Still sighting between the pencil and the paper, rotate the barrel by drawing out the cord. If the paper touches the pencil, or moves away from it, the drum is out of shape or improperly centered. Now, allowing the pencil to touch the paper, push the piston upward, drawing a fine vertical line upon the card; then, with the spring attached, rotate the barrel, and draw a fine horizontal line. These lines should be perfectly straight throughout their lengths, and at right angles with each other, a condition which may be tested with the triangles after the card is removed from the paper-drum as shown in Fig. 2.

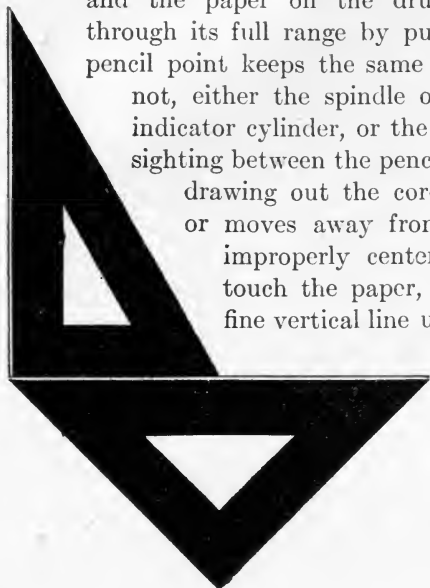

FIG. 2.

If the lines do not comply with these conditions, the natural inference will be that the pencil movement is incorrect, although the horizontal line may be thrown out by any vertical movement of the cylinder upon its spindle.

Lost Motion is usually a matter more of adjustment than of manufacture. Put a stiff spring into the indicator, and carefully feel at the end of the pencil lever for any unrestrained movement. Should such be found, its cause should be searched for in the connection of the piston rod to the piston and pencil motion, through all the joints of the parallel motion, in the fit of the collar which carries the mechanism, and if it cannot be corrected by adjustment without making the instrument too stiff to comply with the friction test above described, the instrument should be rejected.

Proportional Movement.—The movement of the pencil should be proportional to that of the piston. This is an important requirement, but more difficult of test. A screw of perfectly uniform pitch should be arranged to communicate its movement to the indicator piston. With a little ingenuity a micrometer caliper can be adapted to this purpose. Turn the screw up until it has a firm bearing against the piston, then apply the pencil of the indicator to the paper and make a line by moving the drum. Then turn the screw through a number of equal distances, repeating the marking process each time. The piston having been moved through an equal space after each marking, the spaces between the lines upon the paper should be equal. Care must be taken in arrang-

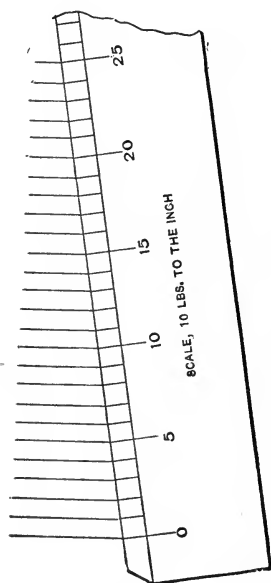

FIG. 3.

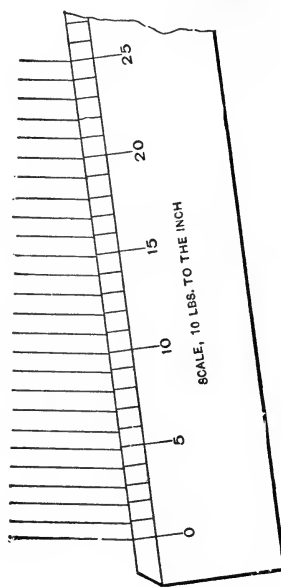

FIG. 4.

ing and manipulating this test. The pencil movement is from four to six times that of the piston, and any failure to move the piston through equal spaces will introduce apparent errors which will be magnified upon the card.

Count the spaces between the lines which you have drawn, then count off the same number of spaces upon an equally divided scale of such magnitude that the aggregate length of the given number of spaces on the scale will not be less than the distance between the outside lines upon the paper. Then lay the scale across the pencil lines, as shown by Fig. 3, in such a way that the number of spaces laid off on the scale will

just reach from the top to the bottom line on the diagram. For example, in the diagram shown in Fig. 3 there are 25 spaces. A "ten to the inch" scale is laid diagonally across with its zero and 25 lines upon the outside lines of the diagram. If the lines of the diagram are equally spaced they will coincide with the divisions of the scale, as in Fig. 3. If the multiplying motion of the indicator is incorrect the spaces of the diagram will be unequal, and their inequality will be apparent by their failure to meet the divisions of the scale, as in Fig. 4.

The Spring is the actual measuring factor of the indicator, and the apparatus required for its testing is too complicated and expensive to be at the command of the average purchaser. The test ought to be made under as nearly as possible the conditions of use,—i.e., under steam pressure, so that all the factors of temperature, etc., will be present. Most of the manufacturers will make such tests of springs for purchasers, and the diagrams of the test may be kept as a record of the degree of accuracy of the instrument at that time. It is well also to have such tests made occasionally after the instrument has been in use, and especially just before and after applying it to work of particular importance. The test consists of applying steam to the indicator piston at pressures increasing by equal amounts, say, for ordinary springs, five pounds. As each five pounds is reached a line is drawn upon the card, a standard gage or, better, a mercury column, being used to indicate the pressures. The pressure is then allowed to fall, and marks are again made as the gage passes the points which were noted in the upward series. If the spring and all the transmitting and recording mechanism were perfect, and the indicator without friction, the spaces for equal changes in pressure would be of equal width, and the lines indicating the same pressures would be coincident, whether drawn when the piston was going up or coming down. This degree of perfection is rarely if ever reached, for even if the spring compresses equal distances for equal increments of pressure throughout its entire range, and its movement is transmitted correctly to the pencil, the friction of the piston, of the pencil movement, and of the pencil on the paper all combine in opposing the motion of the piston in both directions, so that the lines of the upward series are too low and those of the downward series too high by an amount equivalent to the frictional resistance upon the scale of the spring.

A very small amount of pressure at the piston would, however, take care of all this, so that the wide discrepancy often shown between the upward and downward diagrams is more liable to be due to the failure of the operator to catch the pencil at the same point than to the inordinate amount of friction which they indicate.

The above qualities are necessary to an indicator for accuracy. Other points, more in the nature of conveniences than essentials, but which

may be well considered in selecting an instrument, are the comparative simplicity of changing springs, adjustment for height of atmospheric line, changing from right to left hand and *vice versa*, adjusting the drum-spring and leading pulley, attaching the indicator to the cock, etc.

Pencil Holder.—For holding the lead, the end of the pencil lever in some indicators is formed into a light steel quill of a size which will hold the lead firmly when forced through it. In other makes the end of the pencil lever is reinforced and threaded internally, the lead being screwed through it. The preference of the writer is decidedly for the first method. The quill being split lengthwise adapts itself by its elasticity to varying sizes of lead, and may be closed with a pair of pincers if it fails to close upon a lead of small diameter after being used with a larger size. As the point is shortened by resharpening, the lead can be pushed forward, and if it breaks off short it is easily pushed out of the holder with a match or toothpick. The threaded end is adapted to only one size of lead, which, with the short bearing afforded, is apt to get loose and wobble. If it breaks off short, it must be dug out of the threaded portion; and if the threaded method offers any compensating advantages the author has yet to learn of them.

Selection of Springs.—If the use of the instrument is to be confined to one's own plant it is easy to select a spring or set of springs adapted to the pressures and speeds to be encountered. If the instrument is to be used promiscuously, the more springs the operator can own the better will he be equipped to meet the conditions of practice. In selecting a spring, aim to get as large a diagram as possible without undue distortion. If a diagram be taken with a 20 spring an error of measurement of one one-hundredth of an inch would influence the results only one-fifth of a pound. With a 50 spring the same error in measurement would represent a departure of one-half pound. Or since the average useful pressure upon which the power indicated by the diagram depends is proportional to the area of the diagram, consider a diagram taken with a 20 spring having an average height of 2 inches and a length of 4 inches as compared with one taken from the same cylinder with a 40 spring and a length of 2 inches. The area of the first diagram would be 8 inches, of the second 2 inches, and the average useful or "mean effective pressure" of course 40 in both cases.

$$\frac{\text{area} \quad \text{scale}}{8 \times 20} = 40. \qquad \frac{\text{area} \quad \text{scale}}{2 \times 40} = 40.$$

$$\text{length} \qquad \qquad \qquad \text{length}$$

In the large diagram 40 pounds of pressure are represented by 8 inches of area, or 5 pounds to an inch, and an error in measurement of the area

of one one-hundredth of a square inch would involve an error of but five one-hundredths of a pound in the indicated pressure. In the case of the smaller diagram 40 pounds pressure is represented by 2 square inches of area, 20 pounds to the inch, and a deviation of one one-hundredth of a square inch from the truth in measuring this area will involve an error of two-tenths of a pound.

It is therefore advisable to have the area as large as possible *and have it right*.

On the other hand, the allowable movement of both the pencil and the drum is limited by the effects of momentum. At high speeds a light spring and long movement of the drum would result in a diagram so distorted by the effects of momentum and inertia as to introduce errors much more serious than those which are likely to occur from inaccurate measurement of a smaller and more perfect diagram. The speed as well as the pressure will therefore have a bearing upon the spring selected, and will also influence the selection as between the standard size of paper-drum which is used for moderate speeds, and the smaller drums which some of the makers supply for high-speed work. Some manufacturers furnish two sizes of drums, which may be used interchangeably upon the same instrument, adapting it to higher and lower speeds.

In some instruments the position of the atmospheric line is fixed, in others it is adjustable, so that in indicating a non-condensing engine the base line may be lowered and the whole of the allowable movement of the pencil utilized for the height of the diagram. The springs made by American manufacturers are usually scaled decimally, that is, 10, 20, 30, 40, etc., pounds to the inch.

Vacuum Springs.—It is frequently desirable in condensing engines to obtain the lower or condensing portion of the diagram upon a larger scale than that of the spring available with the initial pressure used. With an initial pressure which demands a 60 spring, a realized vacuum of 12 pounds would be represented by a line only one-fifth of an inch below the atmospheric line, Fig. 5, giving a very small area to the condenser portion of the diagram. In order to obtain this area upon a larger scale, giving increased accuracy of measurement, showing more clearly the points of release and compression, etc., springs of low tension are sometimes fitted with bosses or studs, which prevent their closing beyond a certain point, while they are free to extend to any amount.

In Figs. 5 and 6 are shown two diagrams, the first drawn to a 60 scale; and in Fig. 6 the shaded portion of the first diagram is shown expanded to a 10 scale. Notice how much more prominently the points of release and compression are shown, on account of the more rapid vertical movement with the same horizontal movement; and how much

less an error of a few hundredths of a square inch in measuring the area of the condensing portion of the card would affect the result. A spring made especially for this purpose by the American Steam Gauge Co.

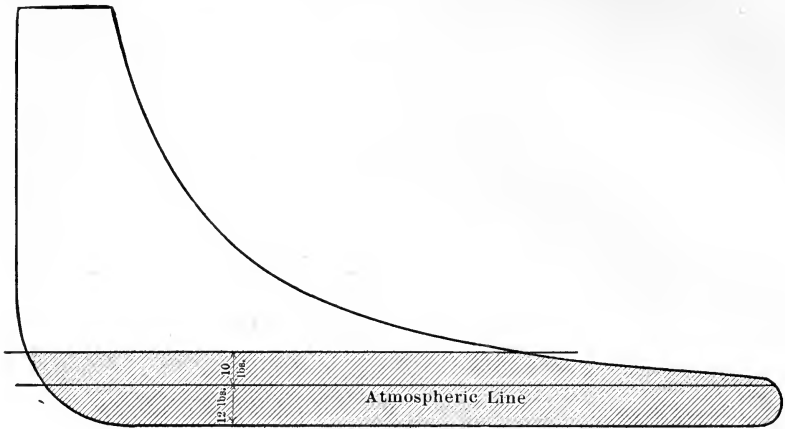

FIG. 5.

is shown in Fig. 7. It is wound so closely that the coils close upon themselves before the pencil movement can attain a dangerous amount of motion. The large number of coils lying in so nearly a horizontal

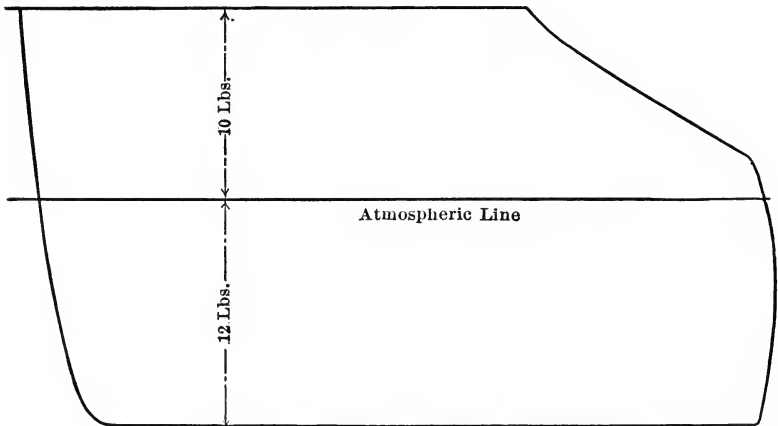

FIG. 6.

direction admits of sufficient elasticity with a good-sized wire, while there is a uniformity of movement throughout the desired range. These springs are scaled for extension only.

Scales.—For a measuring scale, the author uses a 6-inch engineer's rule, triangular in cross-section, as shown in Fig. 8, and graduated upon its six edges to 20ths, 30ths, 40ths, 50ths, 60ths, and 80ths of an inch. This rule not only furnishes the six scales mentioned in one rule, but by estimating half spaces a 50 scale can be used for 100 and the 60 for 120, etc. With the lower scales, where the distances are greater, half pounds can be measured accurately by using the 60 scale for a 30 spring or the 40 for a 20, the 20 for a 10, etc. The 50 scale is also useful for measuring the length of the diagram, each division representing 0.02 of an inch, and the length of 6 inches being more than sufficient for any diagram.

Duplicate Parts.—Much annoyance and loss of time may be saved by carrying in the indicator box duplicates of those parts liable to loss

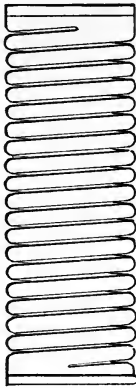

FIG. 7.

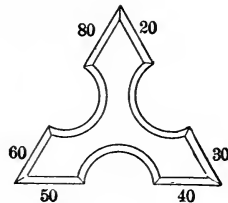

FIG. 8.

or derangement. An additional drum-spring, and two or three of the smaller screws which have to be frequently removed in changing springs, etc., and which are liable to disappear down a crack or somewhere else when most wanted, will allow a test to proceed smoothly, when its interruption would be particularly annoying from the insignificance of its cause.

Leads.—Select a hard lead of good smooth quality and of small diameter, and use but a small piece at a time. At the end of the pencil lever, where the motion is greatest, the weight should be reduced to the smallest possible value. If pointed with a fine file, and rubbed down with an emery stick, such as is used for sharpening draftsmen's pencils, or a fine stone, it will wear longer and be smoother and more satisfactory than if whittled into shape. A little metallic case of such leads already pointed is a very convenient portion of an outfit.

Lubrication.—For lubricating the bearings of the instrument a light machinery oil, one which will not gum or corrode, should be used. A small vial of such oil usually accompanies the instrument, some makers furnishing porpoise oil, such as is used for clocks and watches. The piston, however, is better lubricated with cylinder oil, and the small flat cans which are furnished for bicyclists' use, and which fit readily into the tray of the indicator box, furnish a convenient means of carrying a filtered supply in a form readily available for cleanly use. The manufacturer's filtering should not be accepted. Filter the oil carefully yourself, and see that the can is perfectly clean. A small particle of grit upon the piston of an indicator will not only throw the diagram into the most unaccountable contortions, but may scratch and injure both cylinder and piston to a serious degree.

Paper.—Use hard, tough, smoothly calendered paper of a width sufficient to include the highest allowable pencil travel and about an inch longer than the circumference of the barrel. Such paper can be procured cut to the desired size, of almost any printer. If a blank form is printed upon the back for the recording of data and observations, do not allow the printer to use so much impression as to spoil the smoothness and uniformity of the surface upon which the pencil works. I have seen cards so roughened up by leading points sticking through that it would be a wonder if a diagram could be drawn without the pencil point hitting some of them.

Metallic paper is made by treating ordinary paper with sulphate of zinc. A metallic point will then trace a line upon it and such a hard, sharp point may be used instead of the ordinary lead.

It would seem as though a tubular or trough pen might be made light and fine enough to replace the pencil point. The liquid contact once established, scarcely any pressure would be required to make a record, and the diagram would be clean cut and legible. With the fine point and light pressure necessary with a pencil the diagram is often hard to see, and is quickly obliterated by handling. If inked in by hand there is always a question of the accuracy of the work and a diagram originally drawn with ink would present so many advantages that it is surprising that none of the various makers has applied to the indicator this device, which is used so universally upon other recording apparatus.

CHAPTER II

REDUCING MOTION

IN order to use the indicator, a means must be provided for moving the paper-drum in time with the engine piston. This movement is usually derived from the cross-head, and the appliance used to reduce the movement to that adapted to the paper-barrel is spoken of as the "reducing motion."

The Pendulum Lever.—The most primitive expedient for this purpose is a lever suspended from the ceiling or other suitable support, and

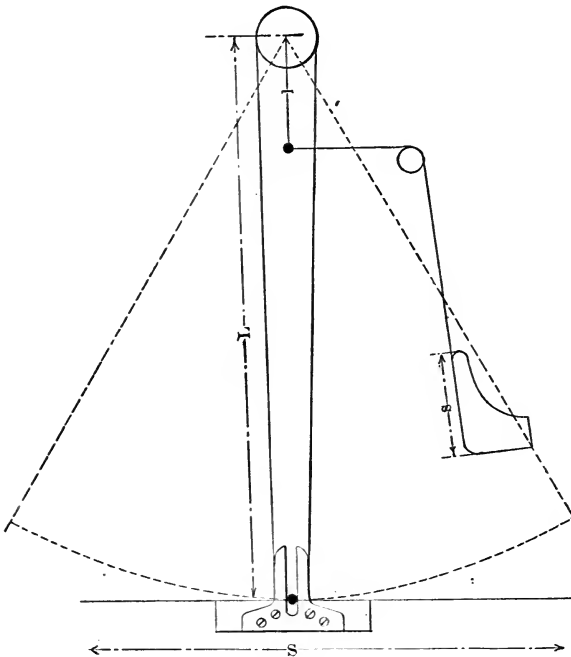

FIG. 9.

connected at its lower end with the cross-head in such a way that it will be swung back and forth as the engine makes its revolutions, as in Fig. 9. The motion of the lever increases from nothing at the point of suspension to approximately the full stroke of the engine at the cross-

head end, the amount of motion being directly proportional to the distance from the point of suspension. A point midway of the lever would have a motion equal to one-half the stroke; one-quarter of the way from the point of suspension, one-quarter stroke, etc. Letting

l = distance between pivot and cord pin,

L = length of lever,

s = desired length of diagram,

S = stroke of engine,

then the diagram will be $\frac{l}{L}$ ths of the stroke, and the cord must be attached at a point $\frac{s}{S}$ ths of the total length of the lever from the point of suspension. For

$$l:L::s:S,$$

that is, as the distance between the pivot and the point to which the cord is attached is to the total length of the lever, so is the motion at that point and the length of the diagram to be derived from that motion, to the stroke of the engine.

$$\frac{l}{L} = \frac{s}{S} \quad \text{and} \quad l = \frac{Ls}{S} \quad \text{and} \quad s = \frac{lS}{L}.$$

To Find the Point of Attachment, or the distance from the point of suspension at which the cord should be attached to produce a given length of diagram:

RULE.—Multiply the total length of the lever by the desired length of diagram, and divide by the stroke of the engine, all in inches.

EXAMPLE.—With a lever 60 inches in length on an engine of 24-inch stroke, how far would you attach the cord from the point of suspension to produce a diagram 4 inches in length?

$$\text{Operation: } \frac{60 \times 4}{24} = 10 \text{ inches.}$$

To Find the Length of Diagram produced by a cord at a given point of attachment:

RULE.—Multiply the distance from the pivot to the point of attachment by the stroke of the engine, and divide by the total length of the lever, all in inches.

EXAMPLE.—What length of diagram would be produced by attaching the cord $4\frac{1}{2}$ inches from the pivot on a lever 20 inches in length attached to a cross-head having a stroke of 12 inches?

$$\text{Operation: } \frac{4.5 \times 12}{20} = 2.7 \text{ inches.}$$

The total length of the lever is measured from the point of suspension to the point of attachment to the cross-head, and is variable in some of the arrangements to be shown. As the variation bears a small pro-

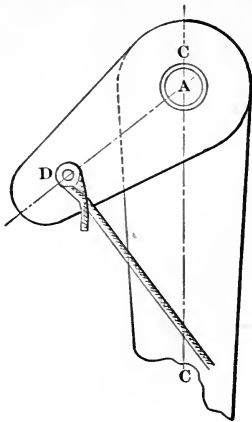

FIG. 10.

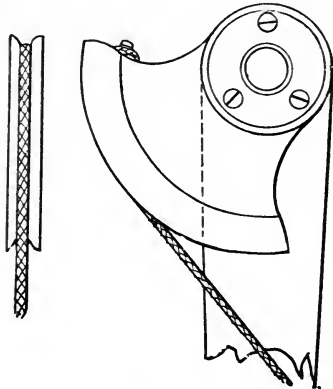

FIG. 11.

portion to the total length, and the length of diagram is usually figured only to keep within the limits of the paper-drum, especial refinement in this particular is unnecessary. In order to get the full motion of

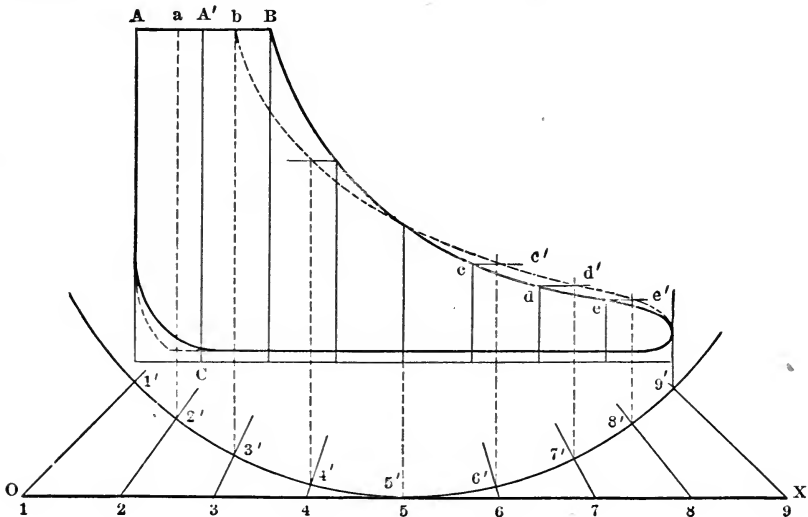

FIG. 12.

the pin, the cord must be led off in the direction of the pin's greatest movement, i.e., at right angles to the lever when the lever is itself at right angles to the guides. It will be readily seen that if the cord were

led off parallel to the lever it would receive very little motion. It is desirable to avoid the use of leading pulleys as in Fig. 9; and Figs. 10 and 11 show two methods of accomplishing this, the latter by putting on a segment of a circle, called a brumbo pulley, having a radius equal to the distance l from the pivot to the point of attachment of the cord, and so placed that the cord may be led straight to the indicator without running on to the corners of the segment at the extremes of the stroke. In Fig. 10 a supplementary lever is added in such a position that when

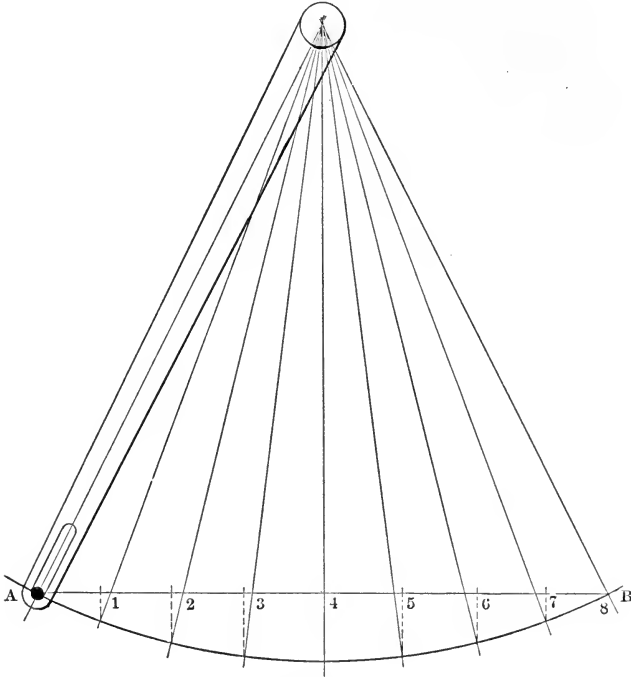

FIG. 13.

the main lever CC is at right angles to the guides the line AD will be at right angles to the cord when the latter is led in the desired direction.

In all motions of this kind there is a radical defect due to the fact that while the cross-head moves in a straight line any point on the lever swings through the arc of a circle. In Fig. 12 let the line ox represent the stroke of an engine. A lever attached to the cross-head and suitably suspended at the other end would take, as the stroke progressed, the positions $1\ 1'$, $2\ 2'$, $3\ 3'$, etc., and a pin attached to the lever at $1'$ would move through the arc shown. Divide the stroke into eight equal parts, as indicated by the numbered divisions, and as the cross-head completes each division of the stroke the position of the pin will be indicated by

the corresponding number upon the arc. The length of the diagram will be the horizontal distance between 1' and 9', but the distribution of motion between these points will not be equal for equal movements of the cross-head. When the cross-head moves from 1 to 2, one-eighth of the stroke, the pin will move from 1' to 2', and the cord will be moved only through a distance Aa instead of through AA' one-eighth of its own length; and for each division of the stroke the proper division of the diagram is indicated by the full lines, and the division that would be derived from the motion of the pin by the dotted lines. Supposing the cut-off to take place at a quarter of the stroke, this point should

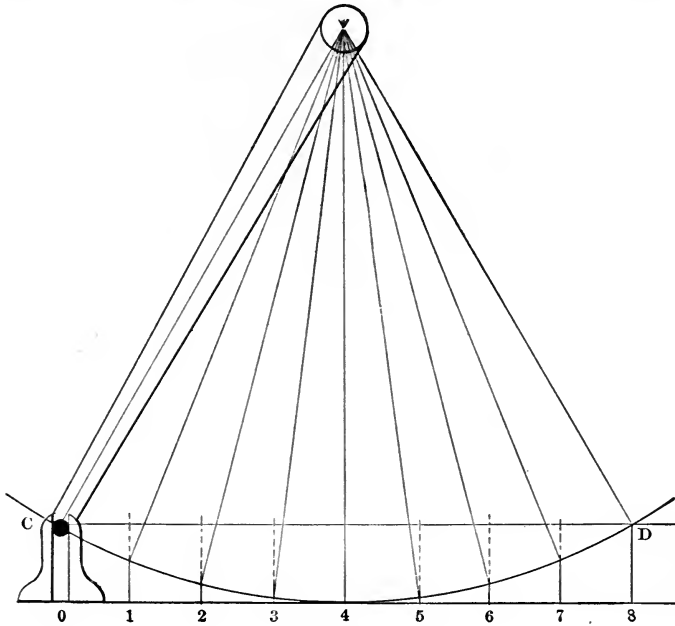

FIG. 14.

be at B , but would appear at b , and the dotted and incorrect instead of the full-line correct diagram would be drawn. The points coincide in the middle of the diagram, and become as much too late at the end as they were too early at the beginning, the points which should be at c , d , and e being at c' , d' , and e' respectively. The distortion shown here is exaggerated on account of the shortness of the lever. It decreases as the length of the lever in proportion to the stroke is increased, and for this reason it is advisable never to use a lever less than one and a half times the length of the stroke. The point of suspension of the lever should be directly over its point of attachment to the cross-head when the latter is in the center of its stroke.

The amount of distortion varies also with the manner of attachment to the cross-head. Fig. 13 represents a slotted lever working over a pin in the cross-head. As each eighth of the stroke is completed the lever will occupy the positions shown by the lines passing from the point of suspension through the corresponding divisions, and the straight motion, as AB , to be derived from any point upon the lever will be unequally divided, as shown by the intersections of the dotted lines. Fig. 14 represents a lever fitted with a pin, which is carried by a slot in the cross-head. As the cross-head and the slot move through successive eighths of the stroke, the pin is carried also through equal divisions, and motion in a line CD , at right angles to the lever in its central position would be equally distributed, as shown by the intersections of the dotted lines referring the positions of the pin for the eight equal divisions of the stroke to the line of motion CD . If it were not for the angular movement of the cord with which this motion is taken off, and which produces an inequality in the transmitted motion, just as a connecting rod does in the travel of the piston for equal movements of the crank, this arrangement would be perfectly accurate. The cord is usually so long, however, that its angular motion is immaterial. This feature cannot be eliminated by using the arc or brumbo pulley, for while the latter disposes of the angular movement of the string, it gives a movement proportional to the angular motion of the lever, which is not equally divided, i.e., the lever does not move through equal arcs of a circle for equal movements of the cross-head. The use of the brumbo in this case would therefore introduce rather than eliminate an error. While this arrangement produces upon paper an almost perfectly proportional reduction of the motion, its effects in practice are not so precise. The long lever is cumbersome, the slotted guide an awkward thing to make and attach to the cross-head, and unless the pin is accurately fitted, the distortion and annoyance due to lost motion will be greater than the inherent error of simpler construction.

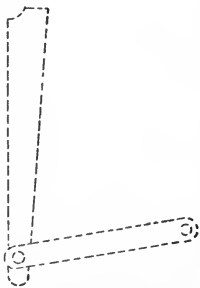

FIG. 15.

Instead of the slot upon the cross-head a short connection rod may be used, as in Fig. 15. In this case the end of the main lever, instead of working up and down in a vertical slot, is swung in the arc of a circle of the radius of the short connecting rod. The departure from the vertical line will be least if the levers are so attached that the vibrating end of the small lever will be as much below the path of the cross-head end when the main lever is in its central position as it is above it when in the extreme positions. This will be understood by referring to Fig. 16, in which the levers are represented by the lines AB and BC ,

the cross-head traveling on the line numbered 0 to 8. When the cross-head is in the middle of its stroke at 4, the ends B of the levers are as much below the line in which the cross-head travels as they are above it in the extreme position shown at B' and b . When the cross-

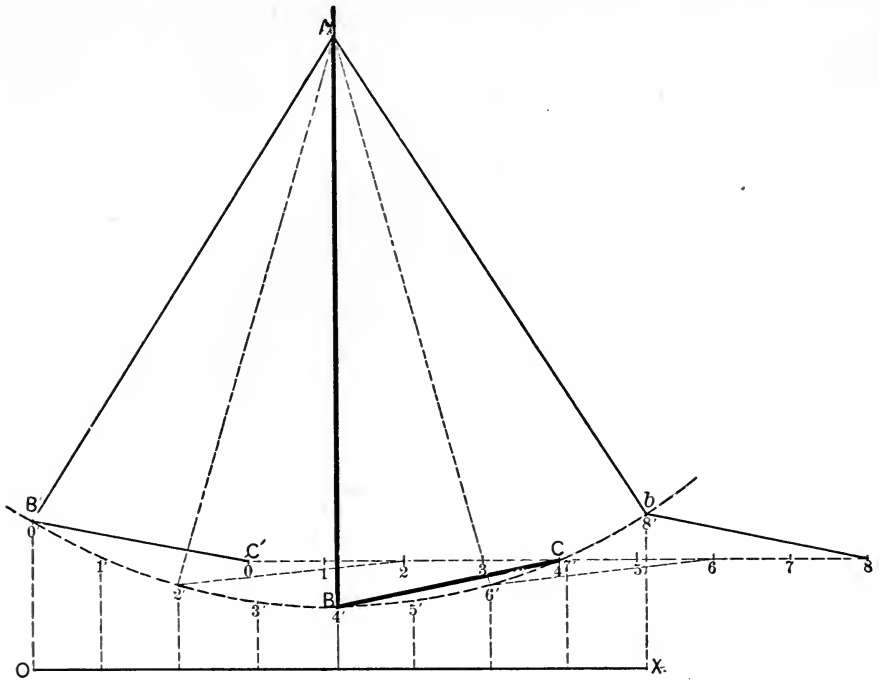

FIG. 16

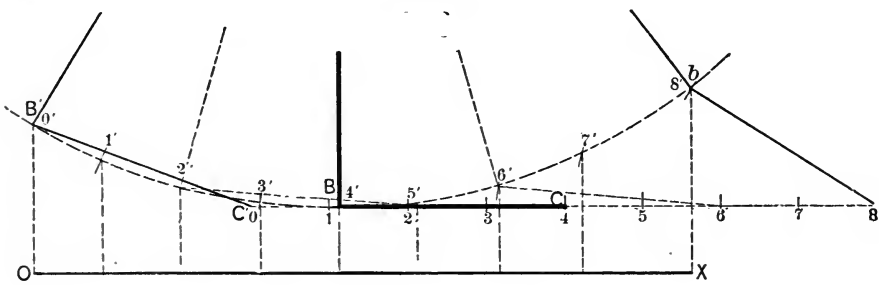

FIG. 17.

head in its movement arrived at the points 1, 2, 3, etc., representing equal subdivisions of its travel, the ends of the levers would be respectively at the figures 1', 2', 3', etc., crossing the line of motion of the cross-head twice during the stroke. Referring these points to the straight line, OX by the dotted lines, it will be seen that the subdivisions very

nearly reproduce the equal subdivisions of the movement of the cross-head from they are derived.

If the levers had been arranged at a right angle when in the center of the stroke, as in Fig. 17, the entire vibration of the levers would take place above the plane in which the cross-head moves. The greater distance to which the end of the small lever is carried from that plane

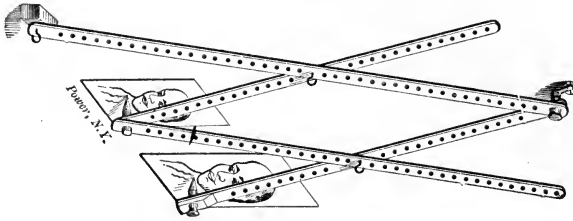

FIG. 18.

would increase the angle between them and introduce a greater distortion, as will be seen from Fig. 17, in which the same process has been carried out as in Fig. 16, the movement derived from any point in the main lever being represented by the subdivisions into which the dotted lines divide the line OX , which as will be seen, are far more irregular than in Fig. 16.

The Pantograph.—Engravers and draftsmen have an instrument called the “pantograph” for reproducing drawings upon a different scale. One of the cheaper forms of the instrument is shown in Fig. 18. A drawing followed with the tracing point is reproduced upon a smaller scale by the pencil point, as shown. If the tracing point draws a circle the pencil draws a smaller circle; if the tracing point draws a straight line the pencil point draws a shorter straight line, and the movement of the pencil point and tracing point are proportional throughout. When the tracing point has drawn one-tenth of its line the pencil has drawn one-tenth of its line and so on to completion. It will readily be seen that if the tracing point of the pantograph be

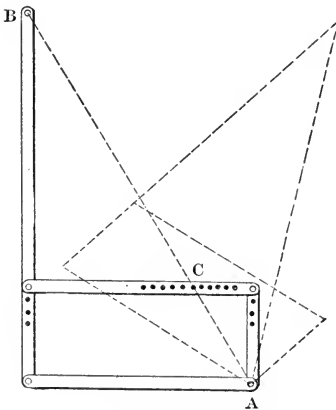

FIG. 19.

attached to an engine cross-head the pencil will accurately reproduce the stroke upon a reduced scale, and substituting a cord pin for the pencil we

have a perfect reproduction of the motion of the cross-head for transmission to the paper-barrel. The two forms in which the pantograph is used for indicator purposes are shown in Figs. 19 and 20. Of both forms it is true that the cord pin *C* must be directly in line with the stationary point *A* and the point of attachment to the cross-head *B*, as indicated by the dotted lines; also that the distance from the point of suspension *A* to the cord pin *C* is to the distance between *A* and *B* as the length of the diagram is to the stroke of the engine, so that the rules given for the lever will apply equally well to the pantograph. The distance *AC* may be varied by moving the strip *C* to one or another of the holes 1, 2, 3, etc., and then moving the cord pin into that hole in the strip which is in the center line of the instrument. The author has pasted into the cover of his indicator box the following table, correct for the pantograph which he uses, which is like Fig. 20.

PANTOGRAPH TABLE

Hole. No.	Proportion Card to Stroke.	Decimal Fraction of Stroke.	Divided by	Longest Stroke.
1	1:16	.0625	16	72''
2	1:12	.0833	12	54''
3	5:48	.1042	9.6	42''
4	1: 8	.1250	8	36''
5	7:48	.1458	6.9	31''
6	1: 6	.1667	6	27''
7	3:16	.1875	5.3	24''
8	5:24	.2083	4.8	22''
9	11:48	.2292	4.4	20''
10	1: 4	.2500	4	18''
11	13:48	.2836	3.7	16''

This shows that when the pin is in the first hole (No. 1) the diagram will be one-sixteenth or 0.0625 of the length of the stroke; in the fifth hole seven forty-eighths, or 0.1458, etc. To find the movement of the cord pin at any hole with an engine of given stroke, multiply the stroke in inches by the decimal fraction opposite the number of hole given; or divide the stroke in inches by the number in the column headed "divided by" opposite the number of the hole given.

To find the proper hole to use with an engine of given stroke to produce a diagram of a required length: Divide the length of the stroke in inches by the desired length of diagram in inches. The number nearest to the quotient in the column headed "divided by" will be opposite the number of the hole which will nearest produce that length. The ratio of the diagram to the stroke may coincide with one of those given in the table. Thus, if it was desired to produce a four-inch diagram

from a thirty-two-inch stroke, the ratio would be $4:32=1:8$, and it is apparent from the columns of proportions given that the pin in the fourth hole will have the required movement. The same result may be arrived at by dividing the length of the diagram in inches by the stroke in inches and selecting the pinhole which is opposite the nearest decimal fraction to that obtained. The last column of the table gives the longest strokes allowable for the various positions of the pin to produce diagrams not exceeding four and a half inches in length, which is about the capacity of the ordinary drum. Additional columns for

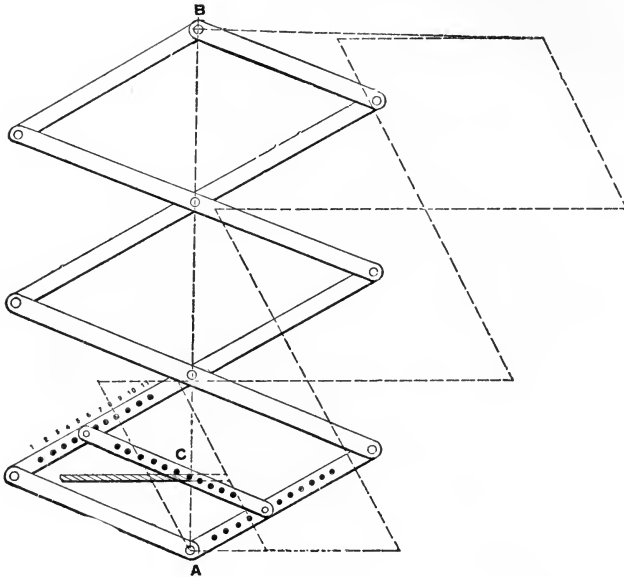

FIG. 20.

other lengths may be made out if desired by multiplying the figures in the column headed "divided by" by the length of diagram desired. Such a column, for instance, might be added for the maximum length of diagram allowable with the smaller drum, although the smaller instruments are usually used upon engines of high rotative speeds, where the pantograph is not adapted as a reducing motion.

In the other form of pantograph, Fig. 19, holes are provided for different positions of the strip *C*, and other holes in *C* for bringing the cord pin in line with *A* and *B*. Other holes are sometimes provided for changing the point of attachment to the cross-head, in which case the cord pin must always be in line with the stationary point *A* and the hole which is used for the cross-head attachment, and the length of the diagram will be to the length of the stroke as *AC* is to *AB*.

In view of this latter fact, if the pantograph is opened until AB equals the stroke of the engine, then AC will be the length of the diagram at once, and with the shorter strokes this fact may be used to advantage in setting the pantograph. Suppose the stroke to be 24 inches. Open the pantograph until a two-foot rule will just extend from center to center of pins A and B , as in Fig. 21, then the distance C to A will be the length of diagram to be expected, and the pin may be so adjusted as to make this distance equal to the length of diagram desired. For greater lengths of stroke this principle may still be used by halving. Take a 72-inch stroke, for instance. One-half of this is three feet. Open the pantograph to three feet, then the distance AC will equal one-half the length of the diagram.

There is no patent upon the pantograph in either of these forms, and anybody who has tools and knows how to use them can make for one

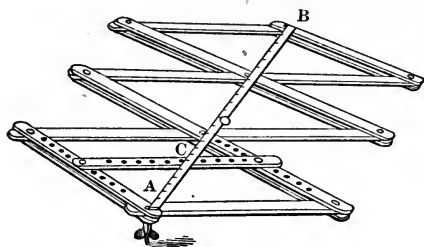

FIG. 21.

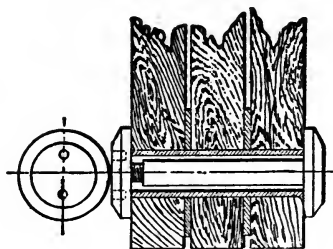

FIG. 22.

himself. The members are usually made of strips of hard wood one and one-eighth by five-sixteenths of an inch, and sixteen inches between the pivoted points. These strips are put together in the manner indicated in the illustration, the single strips running between the double making it stiff and substantial. The levers must work easily, and all lost motion be avoided. The joints must be well made and the pivot holes should be bushed. A good form of joint, designed by Mr. E. K. Conover, is shown in Fig. 22. It allows for taking up lost motion by filing off the bush, and permits the bearing to be taken apart and oiled occasionally. The holes which are used for the different positions of the strip and of the cord pin are usually tapped directly into the wood, but the tops are apt to be forced out or the threads crossed and cut, and a better arrangement would be to insert strips of brass at these places, and drill and tap the holes into them.

So far as the correctness of the reduction goes it makes no difference where the stationary end of the pantograph is placed. We have seen engineers measure with a great deal of care to locate this point accurately in the center of the stroke, knowing probably that this had to be done

for the lever and assuming that the pantograph required similar arrangement. The cord, of course, should be led off in the line of motion of the pin, i.e., parallel to the guides, and, since it is desirable to dispense with the use of leading pulleys, when the pantograph is used horizontally, as in Fig. 23, the post should be placed at such a distance from the guides and at such a height as will bring the cord pin directly in line with the indicators; so that the cord can be led direct as shown in the plan. The point to be looked out for is that the corners *A* and *B* of the pantograph do not come in contact with the guides at the extremes of the stroke. We have seen several good pantographs spoiled in that way, and plead guilty to one wreck ourselves from that cause. Now we try it by having the engine turned over, if this can be done easily, while holding the stationary end of the pantograph, moving it, if it hits, into a position in which it will clear; or if the engine is a large one, by locating the extreme points of the pantograph's travel by measurement, and carrying the cross-head end through the range so determined in as nearly

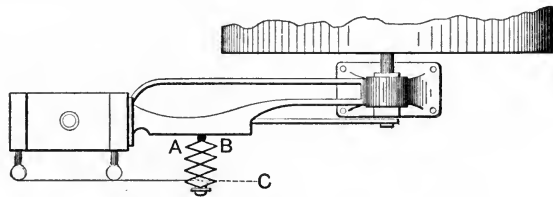

FIG. 23.

as possible the line that it will travel, observing that it clears throughout the stroke. When the pantograph is all attached and running, place your eye at *C* and sight the cord pin. It should move in a straight line to and from your eye. If it has any sidewise motion something is wrong; probably the pin is not in the center line of the instrument. The stationary post will come about in the middle of the guide, with this arrangement, as if moved much to either end it will bring the corner at that end in contact.

Remembering that it makes no difference how the pantograph is set, horizontally, perpendicularly, or obliquely, so long as it will clear, it may be placed in any position to favor leading the cord to the indicators. Fig. 24 shows how it may be used on an engine whose stroke does not exceed the length to which the pantograph may be easily opened. The other form of pantograph may be attached to the floor, as in Fig. 25, in which case a leading pulley is required, but where the stroke of the engine will allow it had better be attached as in Figs. 26 and 27.

Fig. 28, from the catalogue of the Buckeye Engine Co., shows an adaptation of the pantograph for that engine. The cord is attached

to the end of a short bar which slides freely in a bearing in the carrying post. This bar is connected to the lever *CD* by means of a short link *AB*. The lever is connected to a stud attached to the cross-head at *E* by the bar *DE*. The proportions of the parts are such that the points

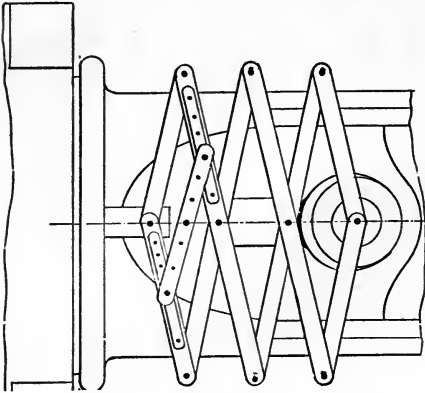

FIG. 24.

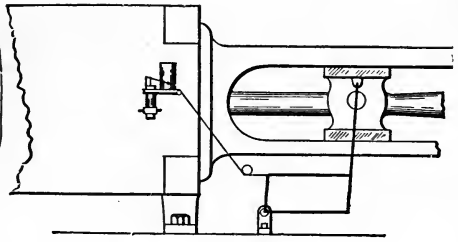

FIG. 25.

CBE are in a straight line at all times, and this being the case the distortions of the movement of the lever due to the vibration of the link *DE* will be corrected by the equal vibration of the short link. This makes a good rig for a permanent fixture, but must be proportioned

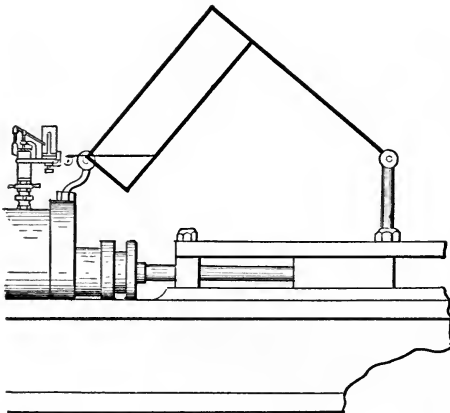

FIG. 26.

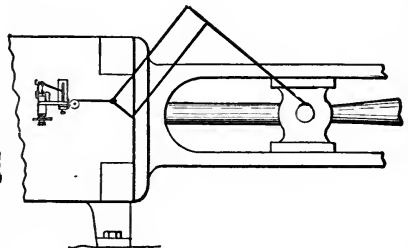

FIG. 27.

for the engine upon which it is used, as it cannot, except within very narrow limits, be adjusted for engines of different sizes. The cord must, of course, be led off in the line of motion of the short bar.

Fig. 29 shows a very good motion for short strokes. The amount of motion given to the bell crank may be varied by changing the inclination of the plane which is attached to the cross-head, and the vertical arm may be of such length as to bring the cord in line with the indicator.

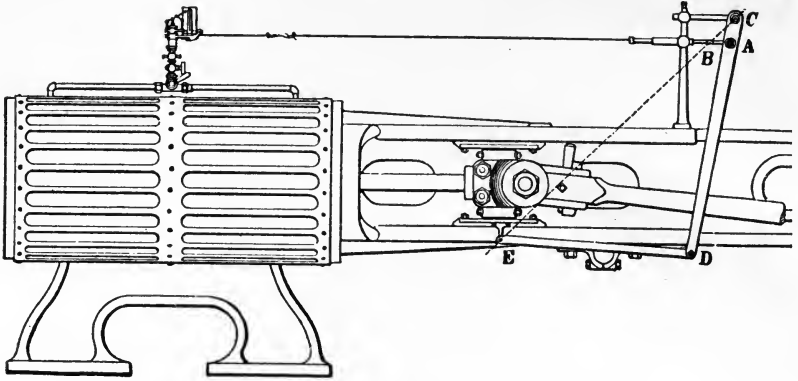

FIG. 28.

The catch *C* holds the foot up off the plane and stops the instrument without unhooking the cord or leaving it flapping as with a detent on the indicator drum.

Fig. 30 shows a method of reducing the motion by means of wheels or sheaves of different diameters.

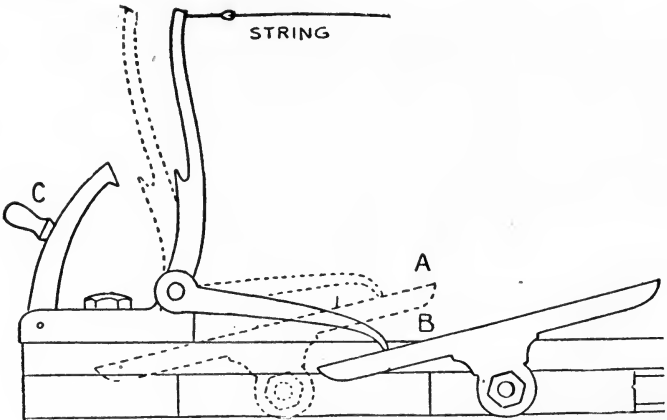

FIG. 29.

A standard upon the cross-head is clamped at *c* to a cord which passes around the pulleys *W* and *w*, the hub *H*, from which motion is taken to the indicator, bearing the same proportion to the wheel *W* that the length of diagram is to bear to the stroke. This arrangement has the

advantage that the wheel *W* is kept in time with the piston by being held from overturning through momentum by the cord. Another cord can be led from *H* to the indicator upon the back end of the cylinder. The trouble with those reducing wheels which are pulled out by the cord and returned by means of a spring has been that having considerable mass they acquired a momentum which carried them after the cross-head had stopped pulling, and distorted the stroke, like a heavy paper-barrel with a weak drum spring on an indicator at high speed. Several

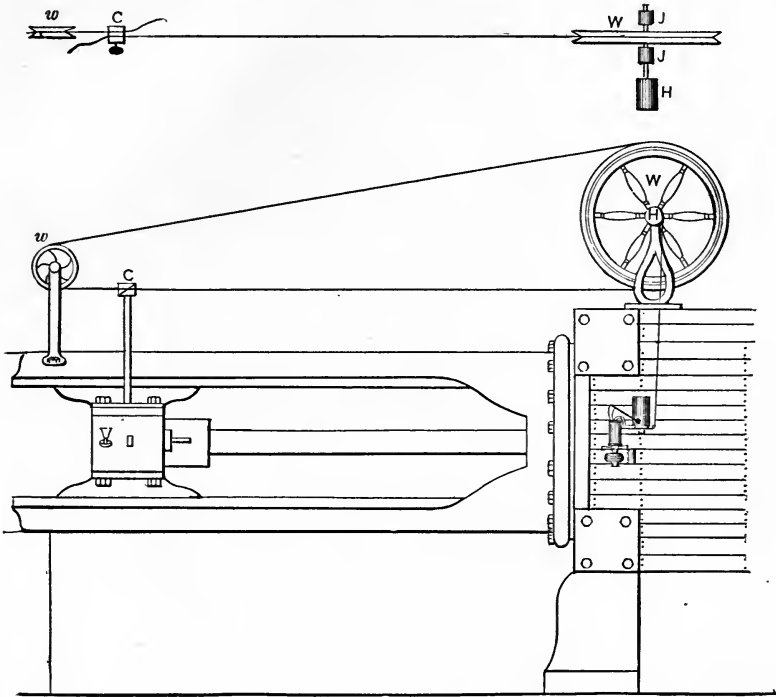

FIG. 30.

forms of reducing wheels are now upon the market, however, in which lightness of material and construction have combined to form a device which is not only handy in application to different sizes and kinds of engines, but reasonably accurate at considerable speeds. Finally, whatever form of motion is used, there are two tests which should be tried. The first of these is shown in Fig. 31, where the stroke of the cross-head is divided into eight equal parts. With the reducing motion attached to the indicator, put the engine on the center, the corner *A* of the cross-head being at zero. In this position make a vertical mark upon the indicator card by raising the pencil lever. Then move the cross-head

successively to 1, 2, 3, etc., at each point making a mark upon the card. If the diagram is found to be equally spaced your motion is correct so far as the reduction is concerned. Now give the engine steam, and while it is turning over slowly apply the pencil, and hold it on during a complete revolution, making an "atmospheric" line. Raise the pencil about

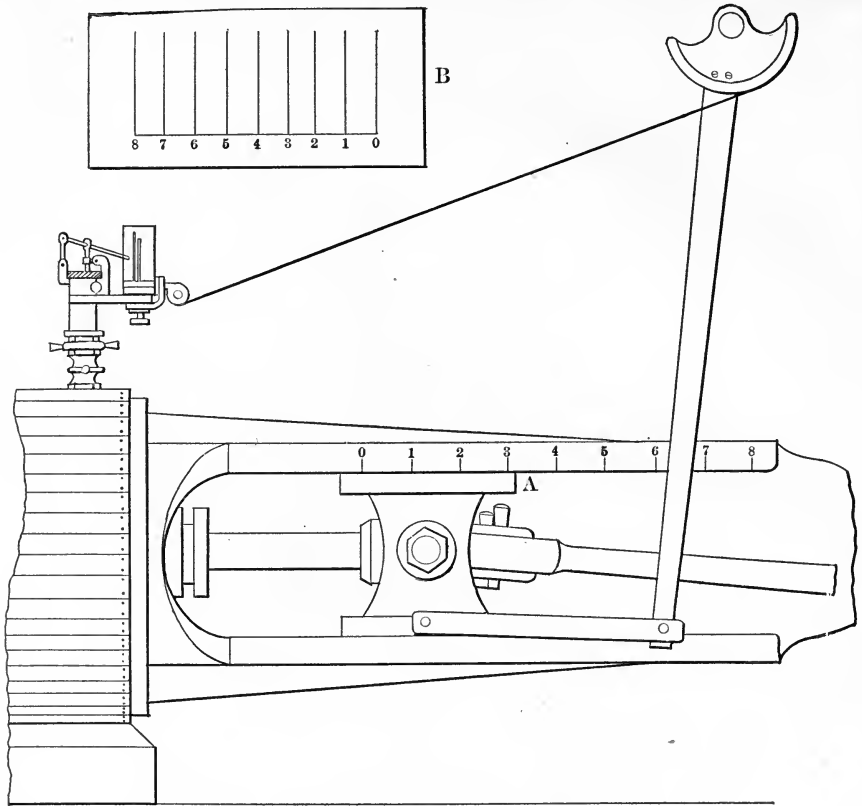

FIG. 31.

a sixteenth of an inch, let the engine get up to speed, and draw another line in the same way. If there is a considerable difference in the length the diagram will be distorted by the momentum of the reducing motion, or of the paper-drum of the indicator itself, or by the stretching of the cord. The most that you can do is to take up all lost motion, use short cord or wire, and adjust the drum spring to get the least possible discrepancy.

CHAPTER III

APPLICATION

HAVING selected an instrument and laid out an appropriate reducing motion, we are prepared to consider the attachment of the indicator to the cylinder and the method of its manipulation.

Most engines of recent build are sent out of the shop with the cylinder drilled and tapped for the application of the indicator, and plugged holes for this purpose will be found in the side or top of the cylinder by removing the lagging. When a cylinder is not tapped, the two points to be considered in locating the point for drilling are, first, to so place the hole that throughout the stroke there shall be a constant uninterrupted communication between the cylinders of the indicator and the engine; and secondly, to so locate the instrument as to lead off from it most conveniently to the reducing motion.

The first object is most readily attained by tapping directly into the heads, and as this is rather a more simple process for the machinist than tapping into the counter-bore, especially when room is limited, it is frequently done. Except in a few instances, however, as in working from the crank end of an upright cylinder, it brings the instrument out of easy reach of the line from the reducing motion, and this line should be kept as short and direct as possible. The most advantageous method of connection will usually be found to be by tapping through the cylinder wall into the counter-bore, as at *A*, Fig. 32. Whether this will be at the side as in Fig. 34, or top as in Fig. 33, of the cylinder will depend upon the location of the steam chest and the direction of the cord. Usually in the larger engines with vertical cross-head the indicators are most conveniently located at the side, while in the small self-contained engines, with horizontal cross-head, the indicator is most accessible on top of the cylinder.

Having determined where the indicator is to be located, drill and tap the cylinder for a half-inch pipe thread, being careful to see that the hole is not covered by the piston, but that it is in free communication with the cylinder at all points of the stroke. When the counter-bore is too close and the clearance small, access may be had by chipping a channel from the tapped hole out into the clearance. Of course every

attention should be paid to cleaning out chips and borings so that the cylinder may not be cut nor the indicator injured.

Into the hole so prepared, screw the indicator cock direct whenever possible. When the cylinder is tapped upon the side, this will bring the instrument horizontal, as in Fig. 34, but the author much prefers this arrangement to the more common one shown in Fig. 35, where a nipple and elbow are used to bring the indicator into a vertical position. The shorter and more direct the connection between the cylinder of the indicator and the engine, the more accurate will be the results, and it must be remembered that all the pipes and connections to be filled

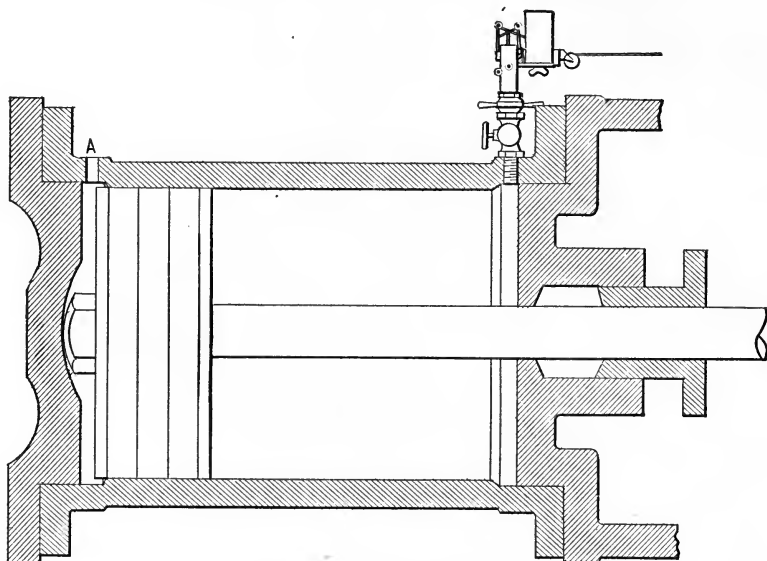

FIG. 32.

with steam represent so much added clearance to the engine, which on a small machine might amount to a considerable percentage.

In all cases where accuracy is important, a pair of instruments should be used, one on each end of the cylinder, and diagrams taken simultaneously. Where only one indicator is available it is more convenient to attach it to a three-way cock connected with both ends of the cylinder, so that it may be thrown into communication, first with one end and then the other, as at Fig. 36. This method cannot be depended upon for accuracy, however, and no important changes or deductions which could be affected by the intermediate connections should be made from the indications of an instrument attached in that way. Its convenience, however, will lead to its continued use in cases where a single instrument is in frequent use upon the same engine; and if proper allowance

is made for the distortions produced by wire drawing and clearance, no harm will result.

A proper precaution is to take a diagram with the indicator attached directly to the cylinder, and then take another through the three-way cock, under as nearly as possible the same conditions, upon the same paper. This will enable you to make an intelligent estimate of the difference due to the different methods of connection. We have seen diagrams taken with the three-way cock which could scarcely be distinguished from those taken with the direct connection, while others have shown distortions which utterly unfitted them as indications of

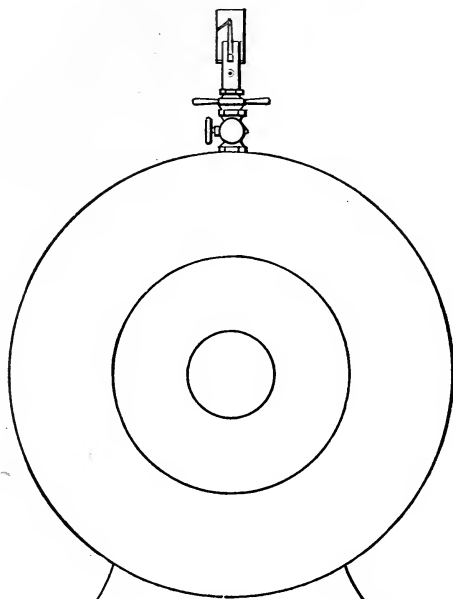

FIG. 33.

the action of steam in the cylinder.* The side pipes, when used, should be ample in size to convey the steam to the indicator without wire-drawing, but not any larger than necessary, on account of the increase in clearance.

The method of connection shown in Fig. 37 is especially to be avoided. Here angle valves are attached to the ends of the cylinder and connected with a side pipe, in the center of which is a T for the insertion of the indicator cock. To connect the indicator with either end of the cylinder, the angle valve at that end is opened, the valve at the other end being closed. It is evident that in order to get any

* See Chapter on Errors in the diagram.

pressure to the indicator the *entire length* of the side pipe must first be filled with steam at each stroke; and for every reason that the ordinary side pipe is bad, this is twice as bad. There is also no know-

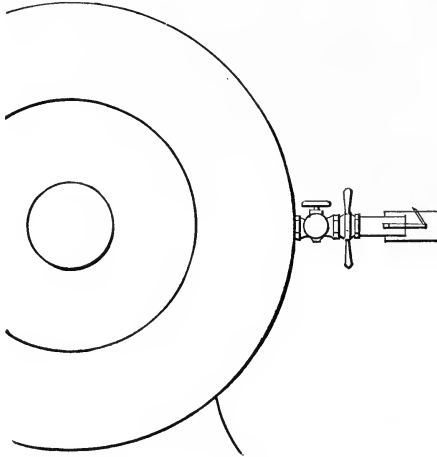

FIG. 34.

ing whether the valve which is supposed to be shut is tight, or whether it is entirely closed every time. Should it remain slightly open, as is frequently the case even when a valve feels tight, some unaccountable

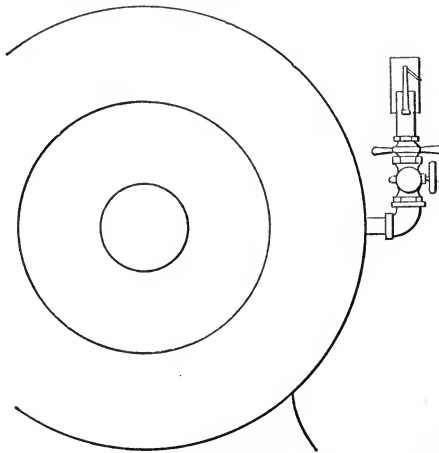

FIG. 35.

effects may appear in the lines of the diagram taken supposedly from the other end alone.

In putting up piping or connections for use with the indicator, use no red lead or other mixture, as it will be carried by the steam to the

indicator cylinder and produce trouble by sticking the piston up. A few drops of oil on the thread is usually all that is required, but should a joint persist in leaking, a string of waste wound in the thread will make it tight.

Particular pains should be taken to remove from all pipes and fittings all dirt, scale, and burr which can become detached and work into the cylinder. A little piece of grit upon the indicator piston can cut some funny freaks upon the paper-barrel, as well as leave its mark upon the walls of the indicator cylinder. When the connections are all up, allow the steam to blow through them freely some time before attaching the instrument, rapping the pipe sharply in the meantime, to remove any scale or dirt which is liable to become detached.

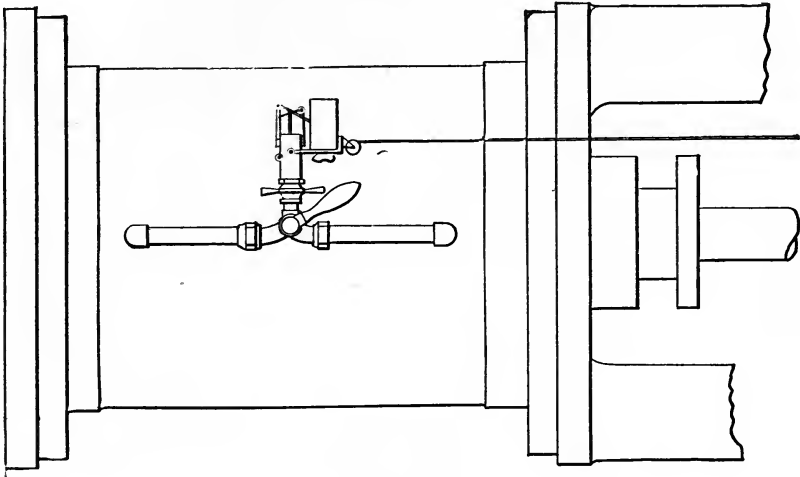

FIG. 36.

The cylinder having been tapped and the reducing motion arranged, we are now ready to apply the indicator to the cylinder; and here is where we begin to appreciate the fallacy of making indicators in pairs right and left, for if one is right for the side of the engine you are upon, the other is certainly wrong. You are bound to want either two right-hand indicators or two left-hand indicators at the same time, and when the makers recognize this and make their instruments so they can be changed from right to left, there will be fewer burnt knuckles and less profanity connected with the use of the indicator. The owner can adapt his instrument to the change by simply filing a slot in the bottom of the barrel opposite the present slot, so that the clips and pencil bar may be brought to that side of the instrument which is away from the cylinder when in use.

Do not undertake to turn the instrument backwards to bring the clips on the outside, but in putting the instrument upon the cock, let the arm which holds the barrel point in the direction which the string is to lead. It is better to take off the working parts of the instrument and leave them in the box while doing this, avoiding the risk of bending the levers and connections in handling, or catching them on the cord while rigging up. Put a little waste in the cylinder meanwhile.

A good idea for one who used his indicators a good deal and in different places would be to have duplicate cylinder caps without holes. The regular cap with the attached pencil motion and piston could then be replaced by the solid cap while rigging up, saving the delicate parts of the instrument from possible harm and keeping the cylinder, upon

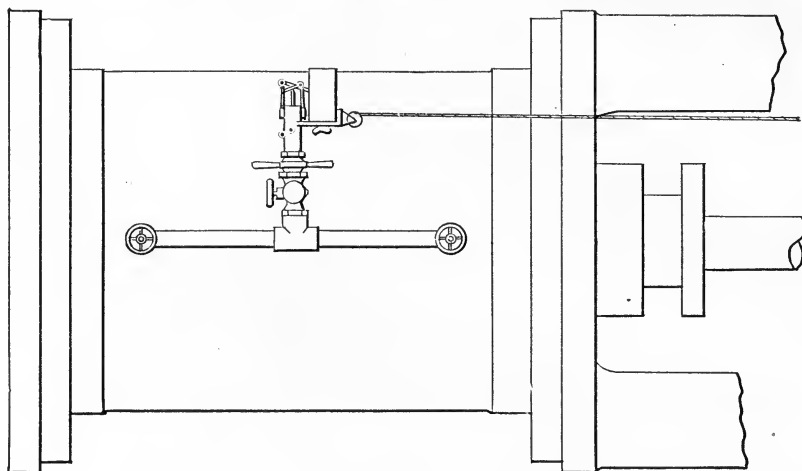

FIG. 37.

the perfection of the inside surface of which so much depends, shut up tightly.

The connection between the paper-barrel and the reducing motion may be made with a flexible cord, as the drum is rotated in one direction by a spring. It has already been explained that in order to secure a distribution of the pressure on the diagram corresponding to the distribution in the cylinder, it is essential that the paper-drum shall correspond in its movement with the movement of the piston. To secure this, even with a correct reducing motion, it is essential that there shall be no stretch in the cord which forms the connection, through the reducing motion and cross-head, with the piston.

If the engine piston has to move an inch before the stretch is taken out of the cord sufficiently to enable it to start the drum, it is evident that the admission end of the diagram produced will not present correctly

the action of the steam with reference to the beginning of the stroke. The distortions produced will be explained in a chapter devoted to the errors to which the diagram is liable. It is enough now to appreciate that no stretch is allowable if accurate work is to be done.

A closely braided cord, prepared especially for indicating purposes, is supplied by dealers in the instruments. It is well to hang a weight upon this cord, and allow it to remain suspended some time before using, to take out any tendency to stretch which may remain in it.

Where the distance from the indicator is considerable, as in the case of a Corliss engine, with the pantograph in the middle of the guides, the author uses, instead of a cord, annealed iron wire of about 22 gage. This wire is subject to occasional breakage, but does not stretch, and a dime will buy enough of it to serve for many applications. It should be straightened and all the kinks taken out by being made fast at one end and wrapped about a round piece of wood, such as a screw-driver handle or hammer handle, as shown in Fig. 38, which is drawn along

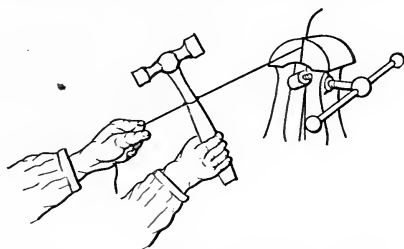

FIG. 38.

for the length desired. Braided picture cord wire of small size is also recommended for this purpose.

Whatever is used to lead to the reducing motion, the closely braided cord referred to will be used to run over pulleys and around the paper-drum. Such a piece, terminating with a small wire hook, will be found attached to the instrument when purchased, the hook being intended to engage in a loop at the end of the cord leading to the reducing motion. If such hook is used, it should be kept as close to the instrument as practicable, as if it is some distance out it is liable to cause the line to vibrate disagreeably, especially when the speed is high. When the distance from the indicator to the reducing motion is short enough to make the use of cord advisable, the author prefers to dispense with the hook altogether, using a cord on the instrument long enough to loop over the pin in the reducing motion, and hooking on and unhooking at that point. This gives a smooth, continuous line, free from loops, knots, and other encumbrances, which will not look only better but run smoother, "stay

put" better (for knots and loops are always giving and stretching more or less), and give more satisfactory results.

There are a number of other advantages which point to the reducing motion as the place for hitching and unhitching, rather than having a hook at the indicator. It is usually easier to attach the cord at this point. When the indicators are unhooked there is no attached cord being whipped about by the motion, and where a pair of instruments are used, the throwing on or off of one loop is made to start or stop the pair. There are circumstances, however, where this is impracticable, and the hook near the indicator must be used. To keep the moving cord out of mischief when not attached to the indicator, it may carry the hook, the loop being made in the indicator cord, and be hooked

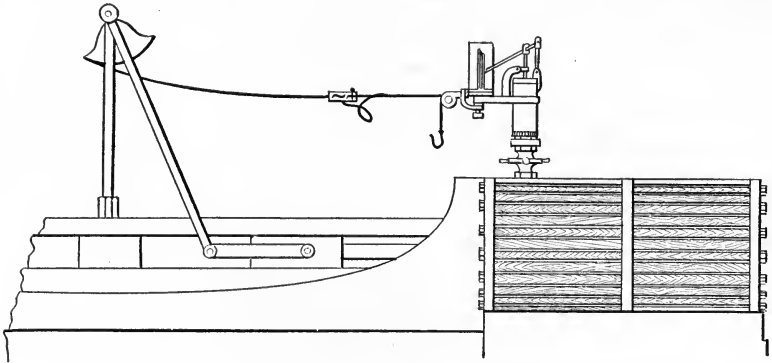

FIG. 39.

into an elastic band attached to or near the indicator when not working the paper-drum. Another method is to attach one end of the cord to the indicator, as in Fig. 39, leaving it long enough not to pull tight with the extreme motion, and looping it near the indicator for hooking on.

In any event, the end of the cord or wire which goes over the reducing-motion pin should be looped, to permit the pin to turn easily within it, and not tied down closely upon the pin as by a slip-knot.

The next step is to adjust the length of the cord so that the diagram may come in the center of the card. With the indicator in position and the engine in motion, loop the cord between your fingers and put it over the pin or hook, drawing it up enough to set the paper-barrel in motion and clear the stop. Now draw the cord carefully up until the barrel touches the stop on the outward stroke, then let it slip back through your fingers until it touches very lightly on the backward stroke. Midway between these two positions is where the point of the loop ought to be. Take back nearly half as much cord as you have let slip

past, tie the loop, and the length should be pretty nearly right. Do not throw the tied loop over the pin, however, nor hook it on, until you have first held it against the pin or hook while the motion is running and made sure it is long enough. If it is hitched on too short, something is bound to give way. If, when you get to taking diagrams, it is found to be desirable to move them a little toward one end or the other of the card, this may be done by knocking the indicator around in the cock enough to take up or let out the required amount of cord. This is better than tying knots in the cord to take it up, as is frequently done.

A device which may be used for adjusting the length of the loop if desired on slow speeds is shown in Fig. 40. It may be made of a small piece of sheet brass, of sufficient thickness to be stiff, in which are drilled four holes about a quarter of an inch apart. Pass the end of the cord up through the first hole, down through the second, up through the fourth, down through the third, and out over the side and under

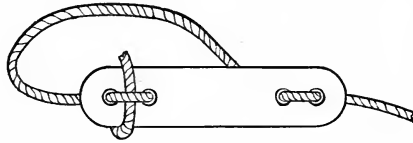

FIG. 40.

the loop, as shown. This link may be slid along upon the cord, lengthening or shortening the loop, but under the strain of the paper-drum spring it will remain where placed.

Be very sure that the passage to the cylinder is free and that the piston does not even partially obstruct it at the end of the stroke. The beginning of the stroke is when the indicator makes its quickest movement; and a choking of the passage will produce apparently unaccountable results. By throwing a ray of light into the hole tapped for the indicator you can satisfy yourself as to the directness of the passage and perhaps get a point as to evening up your clearances besides.

The tension of the drum or barrel spring should now be seen to. When the engine is making its outward stroke this drum is put into motion, and, having mass, acquires momentum, so that when the piston arrives at the end of its stroke and the string stops pulling, the drum continues to move by reason of its momentum until its stored energy is absorbed by the spring. If a high-speed engine be run at a very moderate speed and an atmospheric line be drawn, then with the engine running at governor speed if another line be drawn just above it, there will be found to be a difference in the length of the lines. This produces

a distortion in the diagram, of course, and can be reduced by tightening the barrel spring. For high-speed engines this spring will have to be kept under considerable tension, but on slower moving machines it may be let down, and should in all cases be run only tight enough to keep the barrel well under the control of the cord.

The working parts are now to be arranged and the instrument put together. The pencil lever must be fitted with a lead. Do not use any more lead than is necessary to hold firmly in the quill or stub. Any extra weight is especially to be avoided at this point, where it has so much motion, and if allowed to stick out on the barrel side of the arm it furnishes a lever to work itself loose in the holder or to twist the pencil arm sideways in its bearings. Bring the lead to a fine round point, not sharp enough to catch in and scratch the paper. Then let it stick through as little as possible, leaving a little stock for filing up the point as it wears on the side toward the paper, and break it off short at the other side.

In selecting a spring, be sure to get one stiff enough. If the maximum pressures allowable with the different springs, as given by their several makers, are not exceeded, no harm will result to the springs or to the instrument, but it may be found desirable to use stiffer springs to secure freedom from excessive vibration at high speeds. Attach the spring selected in its position, being careful to screw everything up to its place, put a drop or two of cylinder oil on the piston, open the cock on the indicator and let the steam blow once or twice through the cylinder, then put in the piston and screw the instrument together. If you get the cylinder oil from the can used about the engine room, look at the piston after the oil has spread around on it, and pick off any specks of dust or grit, which will show plainly against the bright brass. If it is a condensing engine, do not open the cock when that end is exhausting, or you may make more work for the air-pump than it can conveniently handle.

When the instrument is together, take hold of the pencil lightly and try the lever for lost motion. If it can be moved without pulling at once on the spring, take the instrument apart and take up the connections. This point should be borne in mind and looked after from time to time as the taking of cards progresses, for the connections are liable to get loose, and introduce some very curious features in the diagrams. The cards should also be watched, to see that the cord connections do not stretch so as to let the pencil bring up against the clips at the end of the diagram.

When the instrument has been put together properly, open the cock and let steam into it, setting the piston and levers in motion, and press your finger lightly on the top of the piston rod, to see if everything is

working smoothly. If the least indication of gritty, scratchy action is felt, shut off the steam at once, take the instrument apart, and find the cause. If it runs smoothly, you are ready to take a diagram.

The paper used with the indicator should be a rather heavy, well-calendered, smooth, tough stock, something that will stand being handled, and over which the pencil will pass without too much friction. It should be cut of such width as to reach nearly to the top of the barrel, and of a length about an inch longer than the circumference of the barrel on which it is to be used. The beginner will consider it necessary to provide himself with printed blanks, containing spaces for all sorts of observations of the engine, boiler, weather, etc.; but inasmuch as few of these

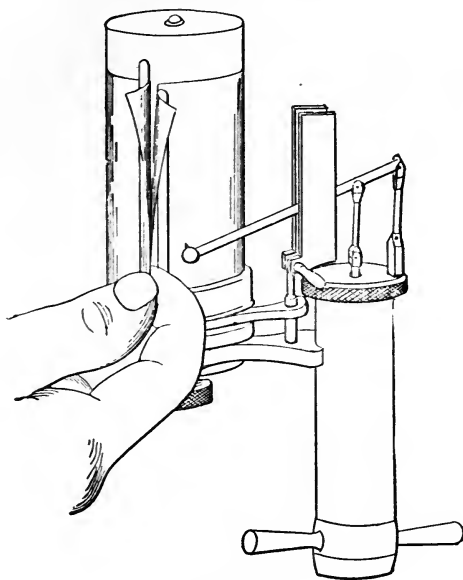

FIG. 41.

observations have to be recorded on each card, and many of them, such as the dimensions of the engine, but once in a test, he will as he progresses get to using slips of plain paper, marking upon the back of each card such particulars as are needed for the purpose for which it is to be used.

The paper is put upon the barrel by placing the lower right-hand corner under the longest clip, bending it around, and allowing the ends to stick out between the clips at the top; then by taking the lower corners as they protrude between the clips between the thumb and forefinger, as shown in Fig. 41 and at the left in 42, the paper may be drawn down over the barrel as smoothly as a glove. An additional

pinch near the top, and a squaring of corners if they need it, will render the operation complete.

Another method is to put the paper under both clips, as at the right in Fig. 42. This prevents the ends from sticking out, and keeps the

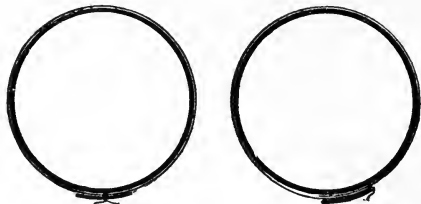

FIG. 42.

paper smooth. It is sometimes drawn through one clip only, as is shown in Fig. 43.

Now turn on the steam and warm up the instrument. On non-condensing engines it is well to turn the cock so that the steam will blow out into the atmosphere until it shows blue and dry. When the water

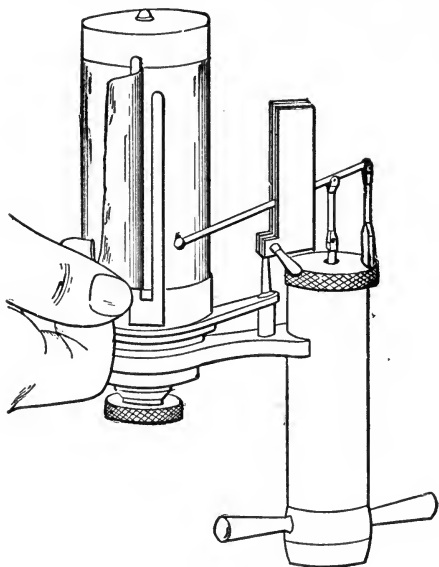

FIG. 43.

has disappeared and the pencil is vibrating smoothly, the paper-drum being in motion, hold the pencil lightly against the paper and allow it to trace the diagram. For ordinary purposes of exhibition, showing the valve action, distribution, etc., one revolution is sufficient to hold the pencil on. To show the governor action, variation of load, etc., the

pencil will have to be held on for a number of revolutions; and when measuring power, the pencil should be allowed to pass from ten to twenty times over, and the average diagram measured. Turn the cock off and bring the pencil again to the paper, tracing the atmospheric line. It is not good practice to trace the atmospheric line first, as the indicator and spring are not then heated and under the same conditions as when the diagram is taken.

When through indicating, remove the spring, piston, etc., from the indicator, and allow the steam to blow through the cylinder once or twice. Unscrew the spring from the piston and cap, dry it thoroughly, and wipe it clean with a greasy cloth. The springs are the vital part of the instrument. Upon their integrity and accuracy the value of all your work depends. Too much pains cannot be taken to have them perfectly accurate when bought, to keep them from deteriorating by rust or otherwise, and to ascertain their condition from time to time. Wipe up and clean the levers, oiling the joints, and you will find the instrument all ready for application next time. When the lighter parts have been attended to, the main body of the indicator will be found to be quite dry, from having had the steam blown through it, and may be cleaned like the rest and put together.

CHAPTER IV

THE DIAGRAM

WE have learned how to correctly set up a motion, apply the indicator, and obtain a diagram. It now remains to consider what this diagram is, and what can be determined from it.

When the mathematician or statistician desires to record the results of a series of observations or experiments in such a manner that they may be at once apparent and easily comprehended, he has recourse to what is known as the graphic method. Suppose, for instance, it

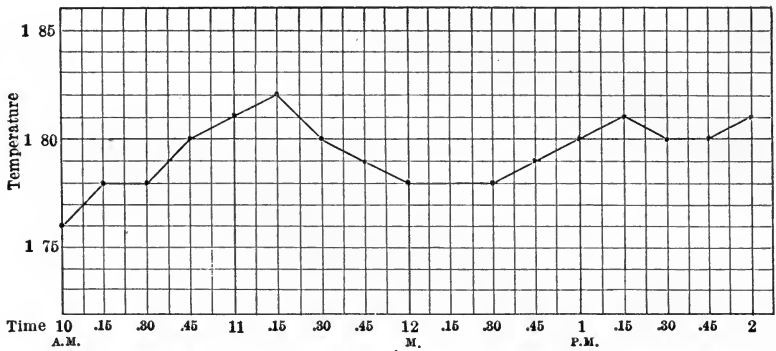

FIG. 44.

was desired to represent in this way the result of a series of observations of the temperature of feed-water during a test. Taking a piece of paper ruled in squares, as represented in Fig. 44, and which is known as ordinate paper, set off the time upon one of the horizontal lines, as shown at the bottom of the figure, allowing two spaces for each fifteen minutes. Allow each of the vertical divisions to represent one degree of temperature, making the lines so figured correspond to 175, 180, and 185°. At 10 o'clock the observation showed 176°, so upon the line representing that time, and at a height representing 176, make a dot. Fifteen minutes later the temperature had gone up to 178°, and upon the line representing 10.15 and at a height representing 178 another dot is made. Continuing in this way to represent the results of each

observation, and connecting the dots by lines, we obtain a diagram showing at a glance how nearly regular the pressure was maintained through the test, to what extent it varied, and at what time variations occurred.

Let us apply this method to the variations of pressure in the cylinder of a steam engine. Suppose we have an engine with a stroke of 32 inches, working with steam of 60 pounds gage pressure and a vacuum of 12 pounds, cutting off at 8 inches, with the exhaust valve opening for release when the piston is 2 inches from the end of the stroke and closing for compression when the return stroke is within 5 inches of completion.

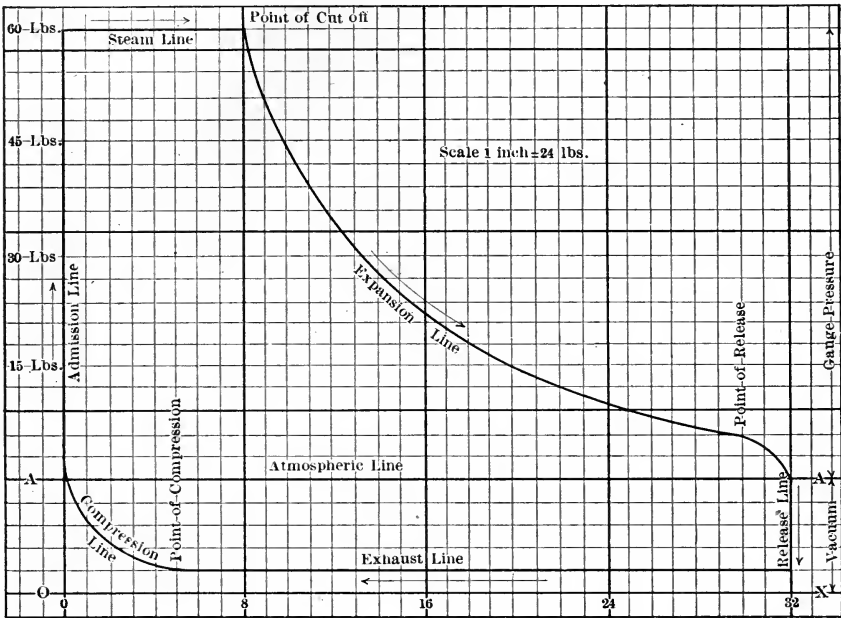

FIG. 45.

Upon a sheet of paper ruled as in Fig. 45 draw the line OX , 32 spaces long, which will represent the 32 inches of the stroke, so that we can represent the successive positions of the piston or volumes by proportional distances from O upon this line. We will also consider each of the spaces in a vertical direction to represent 3 pounds pressure, and starting with OX as the zero line can lay off to this scale the pressures corresponding to the different positions of the pistons, the point O being the zero point of both volumes and pressures.

In the first place since the pressure of the atmosphere is 15 pounds, approximately, above the absolute zero of pressure; we will lay off

the line *AA*, five spaces above the zero line, to represent that pressure; and as gage pressures are reckoned from the pressure of the atmosphere as zero, we will lay off above the atmospheric line 20 spaces to indicate the 60 pounds of steam with which the engine is supplied; and as steam is allowed to enter freely for one-quarter of the stroke, we will draw the "steam line" at this height and 8 of the horizontal spaces in length. At this point the supply is cut off, and the volume of steam inclosed allowed to expand, the pressure decreasing practically in an inverse ratio to the volume; so that when the piston has arrived at the vertical line 16, and the volume has been doubled, the pressure will be halved; at the line 24, where the volume is 3 times that at the point of cut-off, the pressure will be one-third, etc., and we can calculate the pressure for each ordinate, as the vertical lines are called, and lay out the curved expansion line, as will be more fully explained when we come to consider that line particularly. At a point in this line two inches from the end of the stroke the exhaust valve opens, locating the point of release, and the pressure falls away to that of the condenser, 12 pounds below the atmospheric pressure, and 3 pounds above the zero line. Five spaces from the end of the return stroke we locate the point of compression, where the exhaust valve closes, and the steam remaining in the cylinder is compressed, as shown by the compression line, until steam is again admitted and another stroke commenced.

From the diagram thus laid out the actual action of the steam in the cylinder will vary from many causes; and an actual diagram taken from the cylinder with a steam engine indicator in which the vertical distances are determined by the pressure of the steam against a spring of known tension and the horizontal distances by a movement derived from and proportional to that of the piston itself, will enable us, if correctly taken, to determine the actual pressure in the cylinder at each point of the stroke, and to compare these pressures, and the lines which they generate in connection with the changing volumes, with the theoretical diagram constructed as above. We are thus enabled to see how much of the available pressure is realized in the cylinder, with what degree of promptness it is admitted, and how well the pressure is maintained behind the moving piston; to observe how the valve performs its functions, how much of the vacuum is realized in the cylinder, or with what facility the spent steam is gotten rid of. We have also the data for calculating the average unbalanced pressure against the piston, and thus of determining the work performed. In fact, a properly taken diagram, with all data concerning it, is full of interest and instruction, and its study can be profitably carried to great refinement. In succeeding chapters we shall consider the separate lines of the diagram successively, show the correct form and common depart-

ures therefrom, with their causes, and lead up to calculations from the diagram, of the power developed, steam consumption, etc.

RECAPITULATION—MOVEMENT OF THE PISTON AND THE ACTION OF STEAM IN THE CYLINDER.

We give below a tabulated summary of the entire diagram showing the formation of the various lines composing it. Reference will be had to Fig. 45.

Admission Line.—During the formation of this line, steam is admitted into the clearance space, raising the pressure from that of compression to the steam chest pressure.

Steam Line.—The piston is moving ahead and steam is being admitted behind it.

Expansion Line.—At the point of cut-off, the steam port closes and the steam behind the piston expands into a gradually increasing volume and with a gradually falling pressure.

Release Line.—At the point of release the exhaust port opens, releasing the pressure. The steam rushes into the exhaust chamber, the pressure falling rapidly meanwhile.

Exhaust Line.—By the time the piston has started on its return stroke, the pressure has reached its minimum and the piston makes its return stroke, pushing out before it through the exhaust port the steam which has just been used in propelling it through its forward stroke from 0 to 32.

Compression Line.—At the point of compression the exhaust port closes, confining in the cylinder a small quantity of steam at a low pressure. This steam fills the clearance space and the end of the cylinder up to the face of the piston. As the piston completes its return stroke, this confined steam is compressed into a continually decreasing space, its pressure rising meanwhile, until at the lower end of the admission line of the steam port again opens, admitting live steam which runs the pressure up to that of the steam line.

CHAPTER V

THE ADMISSION LINE

THE admission line shows the manner in which steam is admitted to the cylinder. Under normal conditions admission takes place suddenly while the piston is practically standing still at the end of the stroke, resulting in a straight line perpendicular to the atmospheric line, into which the compression line merges, as shown at *A*, Fig. 46.

In order that the admission line may be thus erect, it is necessary that the steam valve shall be open so as to admit the full pressure before the piston commences to move away; and this involves the question of lead, or the amount of opening which the valve has when the engine is on the center, and which, for many reasons, it is desirable to keep as small as possible and yet allow the admission line to be perpendicular. As the steam valve is allowed to become late in opening, and the piston gets into motion before the steam is admitted, the admission line commences to curve inward, as at *B* and *C*, the leaning tendency increasing as the line progresses and the motion of the piston becomes faster. At *D* is shown a peculiar admission line on a diagram taken by the author from a slide-valve engine, the eccentric of which had slipped so as to make the whole valve motion late. The exhaust closure being late as well as the steam opening, the compression was entirely cut out, and the back-pressure line *b* continued straight up the end of the stroke. When the piston commenced its return stroke the steam valve had not opened. The exhaust-valve had by that time closed, the space between the cylinder head and the retreating piston was entirely shut in, and as the piston moved away a vacuum was created, running the pressure down toward *a*, as is shown by the arrow. At *a* the steam was admitted and the admission line ran up, leaving the loop on the heel of the diagram, as shown.

The admission line may lean in, however, from another cause than that of the steam-valves being late, as the author found in procuring the diagram whose admission line is reproduced at *E*. The natural inference from the appearance of the diagram would be that the engine was late all around, but the fact is that the steam-valve has plenty of lead and opens before the return stroke is completed; but the exhaust-valve is so late that it not only does not close for compression, but does

not close until the piston has got well started on the forward stroke, so that the steam is blowing right through into the exhaust and cannot keep the pressure up. As the exhaust closes, however, the pressure is increased, but the piston is moving away so rapidly that the line never becomes erect.

The amount of compression has a great deal to do with the appearance of the admission line. The effect shown at *F* is a very common one, produced by the pressure running up by compression to the point

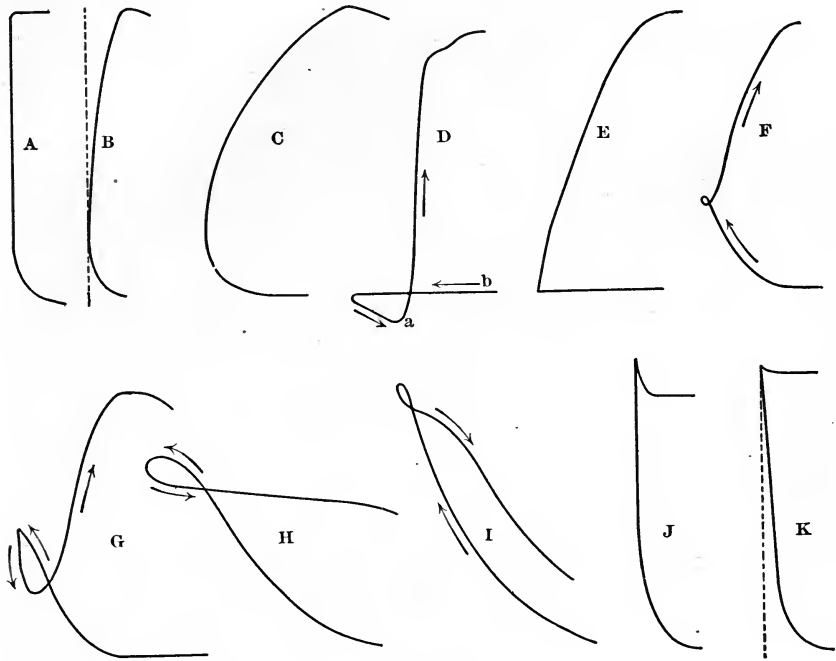

FIG. 46.

and falling away on account of late admission as the piston starts back before the steam-valve opens, forming the loop. A more aggravated case of the same action is shown at *G*, which represents the condition in which an old-fashioned, upright Corliss engine ran for a number of years. This loop assumes all sorts of forms, according to the relations of the compression and admission, and the proportions of the openings and the piston speed; and may even be formed when the steam-valve opens promptly, by excessive compression, as frequently seen on diagrams from the ordinary type of single valve, high-speed engines with shaft governors, where the compression is increased as the load diminishes, resulting in admission lines like those shown at *H* and *I*. In the first

of these the pressure is so low that the compression line extends above it, and when the steam-valve opens, there is an escape of steam from the cylinder and the pressure is lowered to that at which the steam will flow from the chest. The appearance at *I* is produced when the engine is lightly loaded, so that the compression is very considerable.

A sharp point at the top of the admission line is usually an indication of too much lead, and it will be found to result in smoother running if the corner is just given an indication of rounding, as at *A*. The projection is due to the fling of the moving parts carrying the pencil above the point due to the pressure.

Just as a tardy action of the steam-valve results in producing an inward leaning of the admission line, so a too early opening of that valve will result in the production of a line which leans outward, as shown at *K*. This is to be avoided, as it puts an injurious strain on all the working parts of the engine, pushing with all the force of the steam pressure per square inch multiplied by the piston area upon the crank as it is coming up over the center, and crowding the shaft hard into the main bearing to no purpose. It simply sets the steam pressure to work against the desired movement of the engine, and robs the diagram of the effective area between the admission line and the perpendicular dotted line *K*, which indicates the position the admission line should really occupy. Any engine which is in line and properly adjusted in the connections should run at the speed for which it is designed better with enough lead to bring the admission line upright, than it does with more, and if the upright is to be departed from at all, it had better be in the direction of making the valve late than in that of giving the engine steam before it is ready for it.

CHAPTER VI

THE STEAM LINE

FROM the steam line of the indicator diagram may be determined what percentage of the boiler pressure is realized in the cylinder and how well this pressure is maintained up to the point of cut-off. Steam or any other fluid will not flow without a difference of pressure between the vessel from which it flows and that into which it is delivered, and this difference in pressure must be sufficient to overcome the frictional resistance of the connecting pipes and passages. It is absolutely impossible, therefore, to maintain in the cylinder the same pressure that is carried in the boiler, although with short connections, ample passages, and low piston speeds a very large percentage can be realized.

In a really good diagram the steam line will appear about as at *A*, Fig. 47, approaching, in its height above the atmospheric line, the distance indicated by the boiler pressure laid off to the same scale as that of the spring with which the diagram is taken, as shown by the dotted line, and remaining horizontal, or very nearly so, up to the point of cut-off. When the connecting pipe and passages are small for the piston speed and diameter, the linear velocity of the flow becomes so great that a greater difference in pressure is necessary to overcome the increased resistance, and the steam line falls away, as at *B*, sufficiently to keep up the difference necessary for such a rate of flow, as at *a* and *b*, the difference at *a* being sufficient to maintain the lesser velocity at the beginning of the stroke, while the greater difference in pressure at *b* is necessary when the piston has gained the greater speed due to that position in the stroke.

Such a falling away may be due either to faulty design or setting of the ports and valve of the engine itself, in which case the loss of pressure will occur chiefly between the steam chest and the cylinder; or to a long, tortuous, or insufficient connection between the engine and boiler, in which case the loss of pressure would occur between the boiler and the steam chest.* To which of these causes the loss is mainly due, and how much of it is due to each, may be determined by applying the indicator to the steam chest, taking the motion from the cross-head just the same as when the indicator is upon the cylinder. Such a diagram

* See Chapter XIII on Errors of the Diagram.

should be taken by transferring the indicator from the cylinder to the steam chest without disturbing the paper on which the cylinder diagram has been taken, and maintaining the boiler pressure, load and speed constant, in order to best show the relations of the diagrams. A still better way, when plenty of indicators are available, is to have an instrument on both the chest and cylinder, take simultaneous diagrams, to the same scale, and transfer them to one card, by making the atmos-

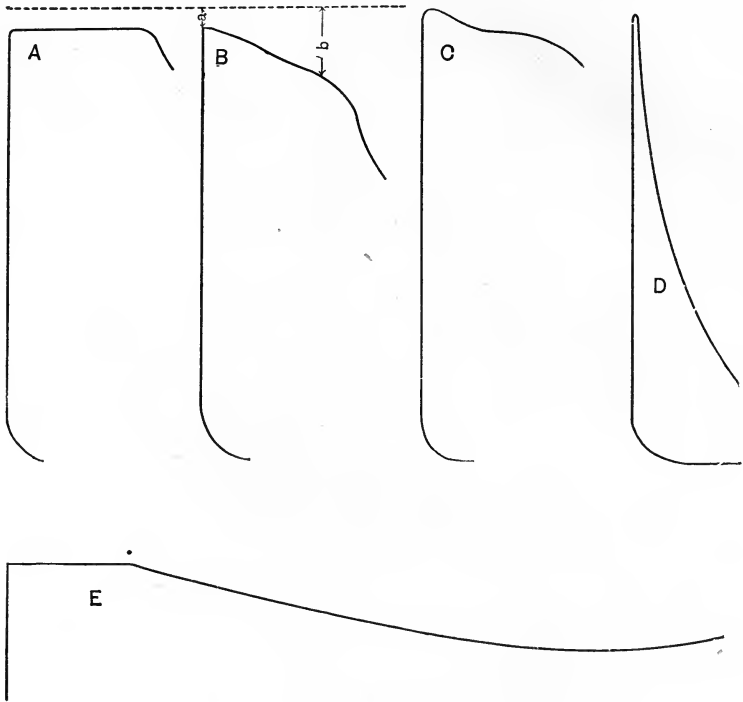

FIG. 47.

pheric lines identical. This may be handily done by cutting the card from the cylinder close to the steam line at the top, and reducing its length so as only to include the diagram. Then extend the atmospheric line to the ends of the card, extend the atmospheric line on the steam chest card, and place the two cards so that the atmospheric lines will coincide as in Fig. 48, one diagram being directly beneath the other. Being made from the same reducing motion, their lengths should be the same.

The diagram shown above the ordinary cylinder diagram in Fig. 48 is a conventional steam chest diagram. At *a* the valve opens to let steam into the cylinder, and the outrush of steam reduces the steam

pressure in the chest until there is the difference between the boiler pressure and the pressure in the chest indicated by the space *bc*, between the line of boiler pressure (which should be drawn in on the diagram at a height measured from the atmospheric line by the same scale with which the diagrams were taken) and the lower line of the chest diagram.

Understand, the vertical distance between the line of boiler pressure and the lower line of the chest diagram represents the loss of pressure between the boiler and the steam chest at that point. The space between the lower line of the steam chest diagram and the steam line of the cylinder diagram at any point in the stroke is a measure of the loss of pressure between the steam chest and the cylinder. The greater the distance from the boiler, the smaller the pipe, and the greater the number of turns, the greater the loss of pressure between the steam chest and the boiler,

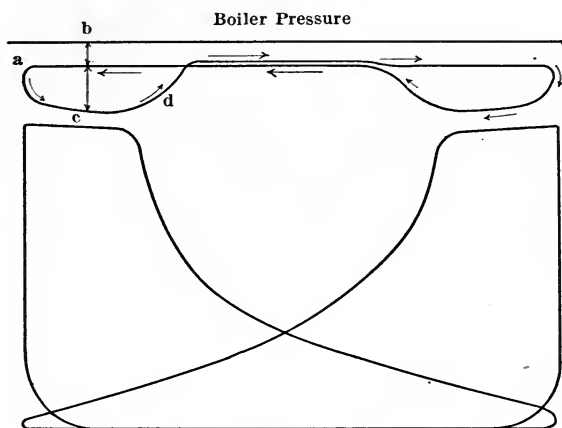

FIG. 48.

and the greater the area of the steam chest diagram. The smaller, longer, and more crooked the ports, the greater the reduction between the steam chest and cylinder and the greater the lost area between the diagrams. Following out the outline of the steam chest diagram, the pressure continues to fall along the line *acd* as the piston moves faster and faster until the cut-off valve closes and the draft of steam from the chest ceases, when the pressure in the chest commences to recover and runs well or quite up to boiler pressure as the flow of steam is stopped. It may even run above the boiler pressure on account of the momentum of the moving column of steam in the connecting pipes. A similar action upon the other end completes the diagram. It will be seen that in this way the cause of any excessive loss of pressure can be located exactly and the relative importance of changes in the engine or piping determined.

The fall of pressure in the steam chest, and thus the shape of the steam line, may be considerably affected by the amount of compression used. Suppose an engine to cut off at quarter stroke and to have 5 per cent clearance. The total displacement up to cut-off is $25 + 5 = 30$ per cent of the whole displacement. This is the volume which must be filled from the boiler, and the clearance is $\frac{5}{30}$ or $\frac{1}{6}$ of it. But even a good engine uses 20 per cent more steam than would be accounted for by filling this volume the given number of times an hour. This steam is condensed upon the containing surfaces which have just been exposed to the exhaust pressure and refrigerated by the evaporation from them of the water which, in a vacuum, evaporates at very low temperatures and even in a non-condensing engine at a temperature below that of the metal. Suppose that another sixth is thus disposed of and you have one-third of the total steam which the engine requires to be furnished from the steam chest before the piston moves off from the center. If the clearance is empty when the admission valve opens, this draft will make a serious reduction in the steam chest pressure and will reduce the height of the steam line. If the clearance has been largely filled by compression the draft will be correspondingly less and the steam line will be higher, especially at its commencement. This is the reason why compression often makes a steam line fall away, not by lowering its final but by raising its initial pressure.

In order to prevent an undue fall of pressure, and wire drawing of the steam, the passages leading to the cylinder should be so proportioned that at no point the linear velocity of flow shall exceed 6000 feet per minute. This can be done by making the passages bear the same proportion to the cross-sectional area of the cylinder that the piston speed does to 6000; i.e., take for the smallest cross-sectional area of the steam pipe or passages such as fraction of the cross-sectional area of the cylinder as is indicated by writing the piston speed in feet per minute as a numerator over 6000 as a denominator.

For a piston speed of 600 feet per minute, for instance, the smallest cross-section of the pipe or port should not have an area less than $\frac{600}{6000}$, or one-tenth of the cross-sectional area of the cylinder.

On engines with large steam chest capacity the appearance at *C*, Fig. 47, is often met, the large volume of steam already at hand sufficing to keep the pressure up at the commencement of the stroke, but when the piston movement becomes more rapid and the draft from the boiler begins in earnest, a greater difference in pressure is required to maintain the flow, and the line drops away, as shown.

If there is any tendency to fall away on the part of the steam line, it will, under equal conditions, manifest itself most decidedly on the

head end of the cylinder, as the piston movement is faster on that end, owing to the angularity of the connecting-rod.

The downward tendency of the steam line increases with its length, for, as the stroke progresses, the velocity of the piston movement becomes greater up to midstroke and the rate of flow accelerated. It is therefore very rarely that we find a long steam line on a cut-off engine, which

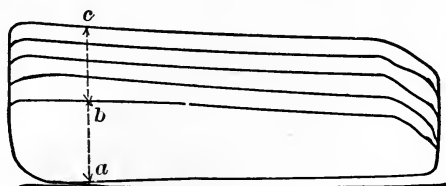

FIG. 49.

does not commence to fall away seriously from the initial pressure, although it may hold up nicely during the earlier portion of the stroke.

A decided example of this action is seen in diagrams from cut-off engines when cut-off does not take place. Such a diagram is shown at *E*, Fig. 47, and it will be seen that although the steam line is well maintained at the commencement of the stroke, the steam follows the

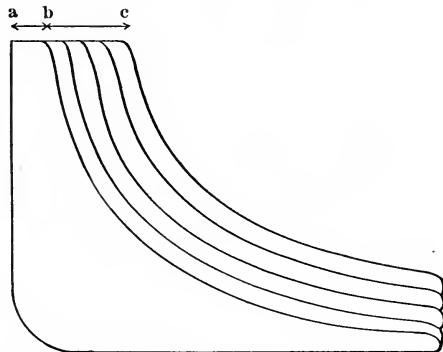

FIG. 50.

piston with more difficulty during the rapid movement in the middle of the cylinder and the pressure falls away, recovering somewhat as the movement grows slower on approaching the other end. The same effect is observable at times upon diagrams from throttle-governed engines; but as the steam lines of such diagrams depend upon the vagaries of a governor situated between the cylinder and the source of steam supply, little interest attaches to their study as denoting the action of the steam.

In throttle-governed engines the area of the diagram, which is the measure of the amount of work performed, is varied in accordance with

the demands of the load by increasing the vertical distance between the steam line and the line of counter pressure, as from *a* to *b* (Fig. 49) for a light load and from *a* to *c* for a heavy load, while in the automatic cut-off engine the same object is effected by varying the length of the steam line by cutting off the steam earlier or later in the stroke, as from *a* to *b* (Fig. 50) for a light load and from *a* to *c* for a heavy load.

Diagrams are sometimes met with which have no steam line, the load being so light that the expansion of the steam in the clearance is sufficient to keep the engine in motion. In this case the expansion line meets the admission line at a point, as at *D*, Fig. 47.

The shape of the steam line is often modified by the admission, and it will be realized from the remarks about the admission line in the last chapter that it is difficult to say when the one leaves off and the other begins, under frequently occurring conditions.

CHAPTER VII

THE EXPANSION LINE

IN all engines in which any pretension is made to economy, steam is used expansively, the supply being cut off at some point in the stroke, determined either automatically by the governor or positively by the valve. By this means the piston is urged not only while there is a direct draft of steam from the boiler, but by the expansive force of the steam in the cylinder after this draft has ceased.

Referring to Fig. 51, let OX represent the stroke of an engine, and OA the pressure of steam in the cylinder at the commencement of the stroke; then, since the energy is the pressure multiplied by the space through which it is exerted, we should have for the energy developed in a cylinder in which the initial pressure is continued to the end of the stroke a value proportional to the area of the rectangle $ABXO$, and the cylinder would require to be completely filled with steam from the boiler at each stroke. If instead

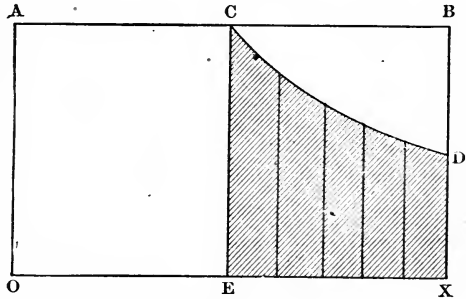

FIG. 51.

of allowing the steam to follow full stroke the supply is cut off at mid-stroke, as indicated at C , there would be behind the piston at this point a half-cylinderful of steam at the initial pressure, which, as the piston moves onward, will be expanded, allowing its pressure to fall along the curved line CD . The energy generated will now be proportional to the area $ACDXO$, less by the area BCD than it was before; but the amount of steam called for from the boiler has been only one-half as much as when the engine followed full stroke, and the energy represented by the shaded area $CDXE$ has been gained at no expense for extra steam.

Steam in expanding in an engine cylinder under the conditions of ordinary practice varies in pressure so nearly in an inverse ratio to its volume that we can use this law in laying out the approximate path that the curve CD , Fig. 51, will take.

Supposing an engine with a 48-inch stroke to cut off at 8 inches or

one-sixth of the stroke, with steam of an absolute pressure of 90 pounds (about 75 pounds by the gage). Representing the stroke of this engine by the base line of the diagram Fig. 52, we should have, when the piston had completed the eighth inch of its stroke, one-sixth of the cylinder full of steam at 90 pounds pressure, represented by the area *OABS*. The supply is now cut off, and when the piston has arrived at the 16-inch point the steam will have expanded to double its volume at cut-off, and its pressure will be reduced to one-half or 45 pounds, represented by the height of the point *C*. When the piston had proceeded another 8 inches, or to the 24-inch mark, its volume would have been trebled and the initial pressure divided by three, giving

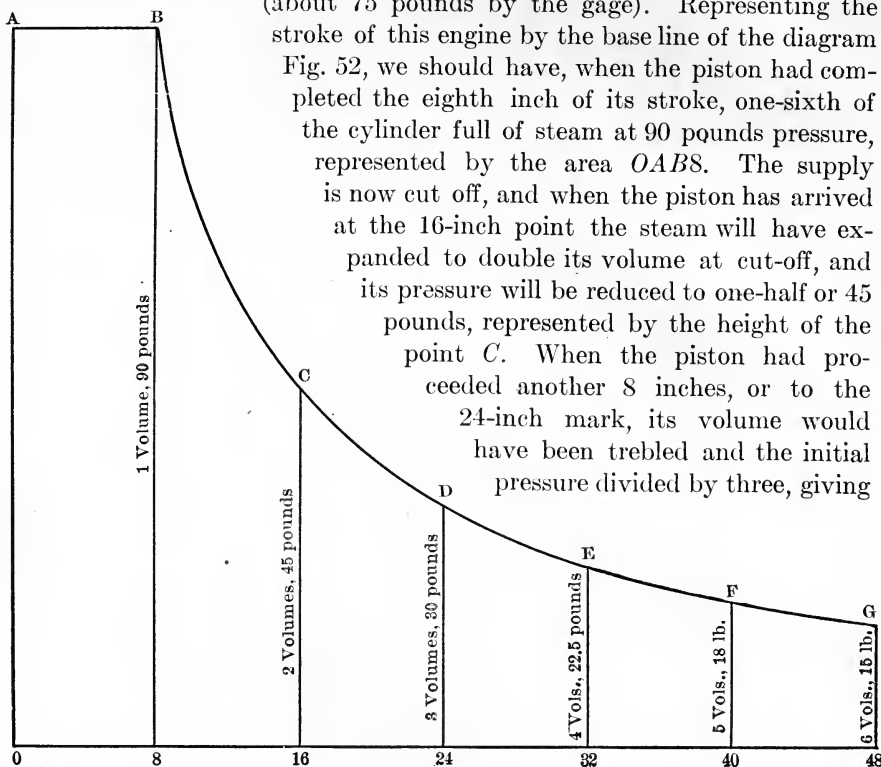

FIG. 52.

a pressure at this point of 30 pounds, represented by the length of the line *24D*, which is one-third of the line *SB*, representing the pressure of the initial volume.

In the same way we would find one-fourth the pressure when the steam had been expanded to four times the initial volume at *E*, one-fifth the pressure when the volume had attained five times the original at *F*, and one-sixth the pressure at *G*, where the volume is six times what it was at the point of cut-off. In this way the pressures at various points in the stroke may be calculated and set off upon ordinates representing by their position upon the horizontal line the corresponding point in the stroke, and a curve drawn through these points will be the theoretical expansion curve.

As a simple rule for finding the pressure at any point in the stroke:

Multiply the absolute pressure at the point of cut-off by the fraction made by writing the number of inches of the stroke completed at cut-off as a numerator over the number of inches completed at the given point as a denominator.

For example, to determine the pressures at *C*, *D*, *E*, *F*, *G* in the above described diagram we have:

$$\begin{array}{l} \text{At } C \text{ the pressure} = \frac{8}{16} \times 90 = 45 \text{ pounds} \\ \text{" } D \text{ " " " } = \frac{8}{24} \times 90 = 30 \text{ " "} \\ \text{" } E \text{ " " " } = \frac{8}{32} \times 90 = 22.5 \text{ " "} \\ \text{" } F \text{ " " " } = \frac{8}{40} \times 90 = 18 \text{ " "} \\ \text{" } G \text{ " " " } = \frac{8}{48} \times 90 = 15 \text{ " "} \end{array}$$

Notice also that *the product of the volume and pressure is constant*. At *B* we have one volume and 90 pounds and

	Volume.		Pressure.		Product.
At <i>B</i>	1	×	90	=	90
" <i>C</i>	2	×	45	=	90
" <i>D</i>	3	×	30	=	90
" <i>E</i>	4	×	22.5	=	90
" <i>F</i>	5	×	18	=	90
" <i>G</i>	6	×	15	=	90

The pressure for any volume may be found therefore by dividing the initial pressure by the given volume in terms of the first volume.

This is a case of inverted proportion and may be readily solved by the slide rule by inverting the slide and setting the index to the initial pressure. In Fig. 53 the index of the inverted slide is set at 120 on the lower scale. Under the 2 of what is now the top of the slide read 60 on the bottom scale for two volumes under the 3, 40 for three volumes, etc. There is a special rule called the Duplex made with an inverted scale, shown in Fig. 54, so that the two scales in use are contiguous and the number right side up.

In applying this curve to an indicator diagram, the fact must be taken into account that besides the volume of steam represented by the piston displacement up to the point of cut-off there is the steam in the clearance spaces, which will share in the expansion, and the initial volume must be made to include this steam. We will apply the curve to the diagram in Fig. 55 by one of the simplest methods. This diagram is 4 inches in length, and we will assume a clearance of $2\frac{1}{2}$ per cent. Two and a half per cent of 4 inches is one-tenth of an inch, by the addition of which we will increase the length of the diagram at the admission end by drawing in the clearance line *AO* one-tenth of an inch from the extreme end of the diagram. Draw the line of absolute pressure 14.7 pounds below the atmospheric line. With ordinarily high scales 15 pounds is sufficiently accurate. Now at the point of cut-off *C* there will be in the cylinder a volume of steam proportional to the area *ACIO* of a pressure proportional to the line *1C*. At right angles to the line of absolute zero, *OX*, erect perpendiculars at points where it is desired to locate the curve. As the curve changes more rapidly

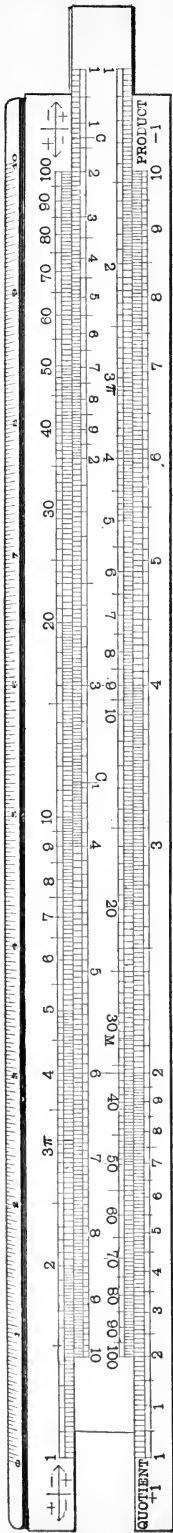

FIG. 53.



FIG. 54.

just after cut-off, it is advisable to put in these perpendiculars more closely in the earlier portion of the stroke, as shown, and this is especially true of diagrams with large ratios of expansion, i.e., early points of cut-off. Now take in the dividers the width of the space representing the initial volume, i.e., the length of the line AC or $O1$, and from the base of the first ordinate a measure off an equal distance $aa' = AC$, upon the zero line. A line connecting the point of cut-off C with a' will cross the vertical ordinate a at the point through which the curve must pass. From the base of the second ordinate b set off the same distance $bb' = AC$, and a line joining the point of cut-off and b' will cut the ordinate b at the point through which the curve should pass at that point of the stroke. Proceeding in this manner with c and c' , d and d' ,

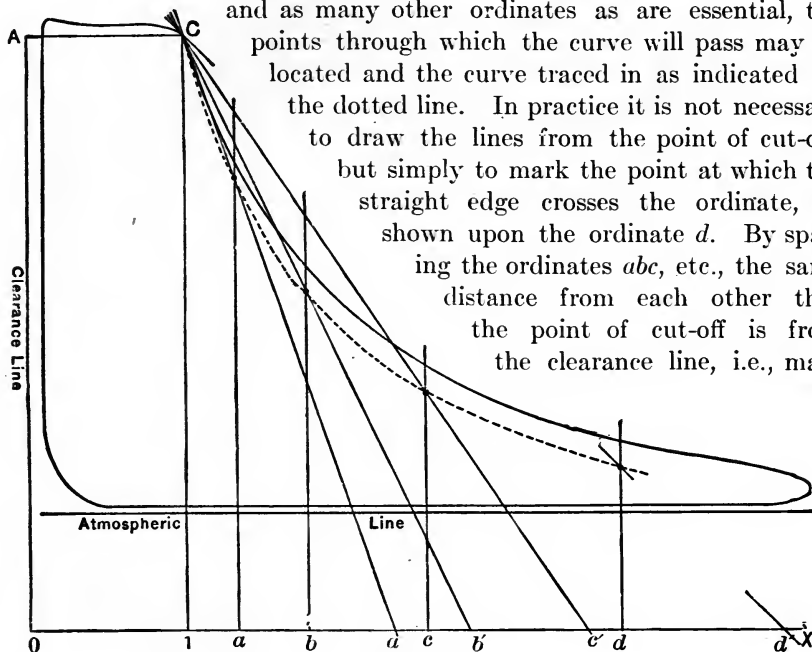

FIG. 55.

and as many other ordinates as are essential, the points through which the curve will pass may be located and the curve traced in as indicated by the dotted line. In practice it is not necessary to draw the lines from the point of cut-off, but simply to mark the point at which the straight edge crosses the ordinate, as shown upon the ordinate d . By spacing the ordinates abc , etc., the same distance from each other that the point of cut-off is from the clearance line, i.e., making the distance between the ordinates equal to AC or $O1$, the base of one line may be used as the point from which to rule to the point of cut-off to locate the curve on the preceding ordinate, but this method does not, with ordinary diagrams, give a sufficient number of ordinates to locate the curve accurately in the earlier portion of the stroke.

Another method frequently used for laying out the theoretical curve is shown in Fig. 56. Allow OX , as in the previous examples, to represent the line of absolute zero, the line AC , by its distance from the zero line, the initial pressure, and by its length the volume of steam up to the

point of cut-off, including that in the clearance, determined as previously shown. Erect any number of perpendicular ordinates, as 1, 2, 3, 4, 5, 6, 7, 8, at points where it is desired to locate the position of the curve. Continue the line AC for the full length of the diagram AD . The point through which the curve would pass on any ordinate, as 6, for example, is found by connecting its top E , as determined by the line AD , with the point O . The line EO will cross the line $1C$ at the point e , which indicates the height at which the curve would pass on the line $6E$, and may be transferred to that line by drawing the horizontal ee' . In the same way the point f' is located upon the ordinate $5F$, and at as many other positions as are necessary to determine the course of the curve with the necessary accuracy.

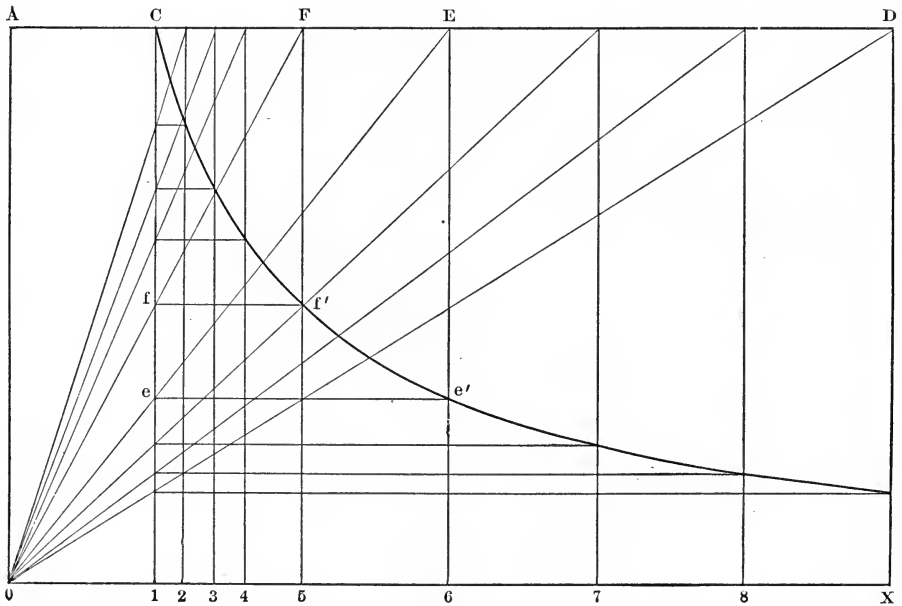

FIG. 56.

The curve which we have been describing, and which corresponds with a constant product for pressures and volumes, is a rectangular hyperbola; rectangular because the asymptotes, as the lines OA and OX are called, are at right angles. Let the rectangle $OAB1$, Fig. 57, represent by its height the pressure and by its width the volume of an amount of steam. The area of a rectangle representing this amount of steam at any other volume (the pressure changing accordingly) will be the same as the area of $OAB1$, for the area is the product of height and width, which represent respectively the pressure and volume, and with hyperbolic expansion the product of the pressure and volume is

constant, as shown on page 55. With the volume doubled, therefore, the rectangle representing the new condition would be $OCD2$, one-half the height and twice the width; and at 4 volumes the rectangle becomes a square, the lines representing the pressure and volume being of equal length. After this point the lines representing volumes become longer than those representing pressure, but we shall have simply a repetition of the rectangles for the earlier volumes with their length horizontal instead of vertical. The rectangle $OGH8$, representing 8 volumes and 2 units of pressure, is the same as the rectangle $OCD2$, representing 2 volumes and 8 units of pressure. Thus it will be seen that the curve is the same on both sides of the diagonal OF , which is called the axis, and that the portion of the curve which lies between F and J is precisely similar to that which lies between B and F .

It is a property of this curve that a line drawn across so as to intersect it in two places, as KL , mN , WP , will cut the curve at equal distances from the asymptotes at both ends.

It is easily seen that the point D on the curve is the same distance from K that H is from L . As the top of the line is carried downward from D as to W , the distance is decreased as to WD , but the curvature is such as to make the distance QP upon the other end precisely equal. So also the increased length in the position mD is met by a similar increase in the distance RN at the other end of the line.

This is true whatever point is chosen upon the curve or whatever inclination is given to the line, so

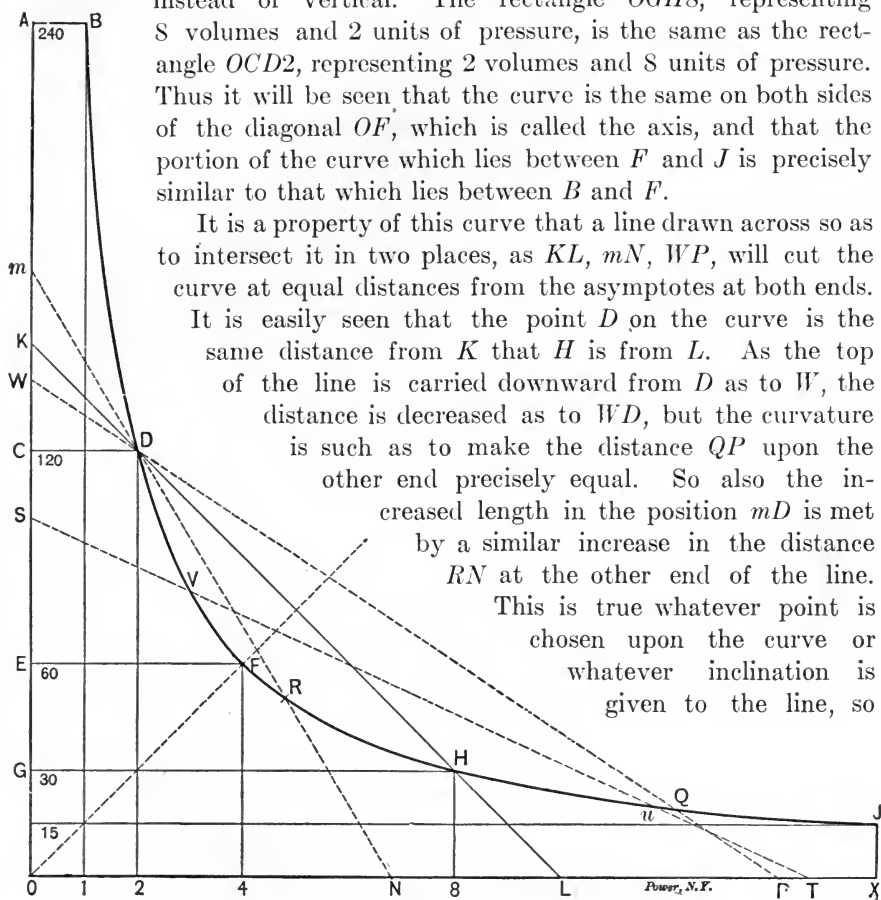

FIG. 57.

long as it cuts the curve in two places and both asymptotes. For instance, on the line ST placed at random, the distances SV and Tu are equal.

This property is made use of in several constructions used upon indicator diagrams, one of which is laying out the curve as shown in Fig. 58. Through any point upon the expansion line, as C , draw straight lines to the line bounding the clearance in one direction and to the line

of absolute vacuum in the other. Upon the line $1\ 1'$ set off a distance from $1'$, equal to $1C$. Upon the line $2\ 2'$, set off a distance from $2'$ equal to $2C$, and continue the process upon the other lines as shown. The theoretical curve passes through the points just found. In practice it is unnecessary to draw lines, distances being laid off by means of the dividers against the edge of the ruler. This principle is also used to determine at what point cut-off should occur, assuming initial pressure to be uniformly maintained, in order that the expansion line may pass through point A . Drop a perpendicular line from A ,

Fig. 59, to the line of zero pressure, and connect the point B of its intersection with the point P upon the line of zero volumes, indicating by its height the given pressure. A line pb , parallel to PB and passing through the given point A , will cut the line PC at the required point at which expansion should commence in order that the curve may pass through A . For under these conditions the triangle PpC is the same as the triangle ABb , and upon the line bp the points A and C are equidistant from the asymptotes. The point of cut-off for any other initial pressure may be determined in the same way by varying the position of the point P , as indicated by the dotted lines.

Another construction sometimes used upon the expansion line of an indicator diagram is

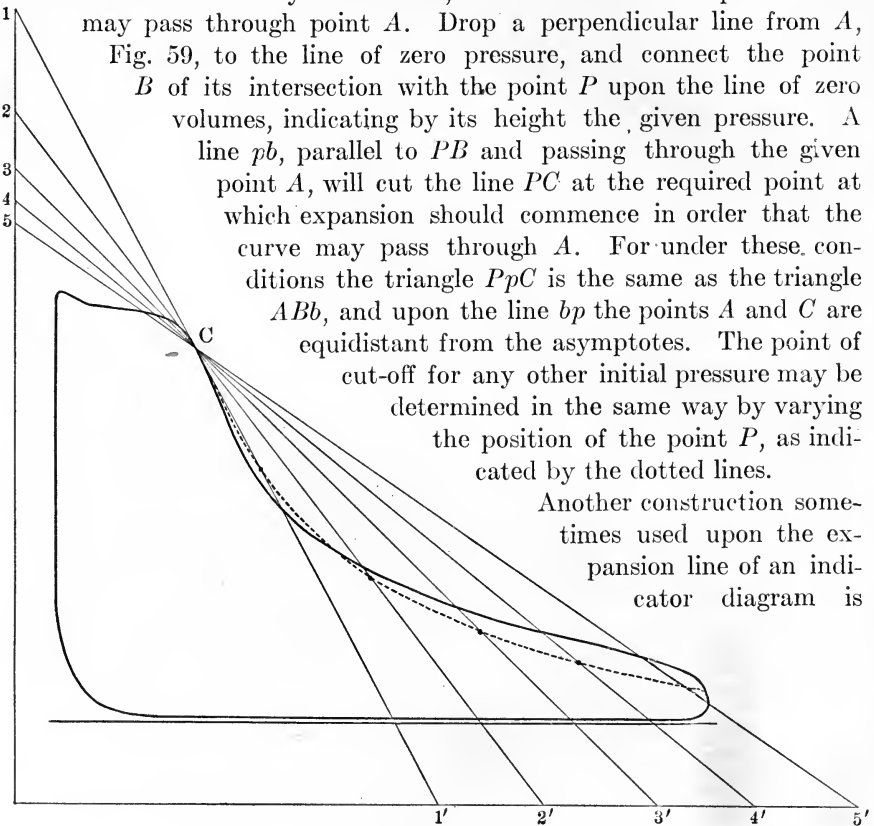

FIG. 58.

shown in Fig. 60. This is for the purpose of finding the position of the line OA , bounding the clearance space. From any two points, as BC , upon the established portion of the curve draw lines as BD and CE , parallel to the atmospheric line, also the perpendicular lines BE and CD , forming a rectangle. At a distance below the atmospheric line corresponding to 14.7 pounds on the scale of the diagram draw the line of absolute zero of pressure OX . The diagonal DE of the rectangle $BDCE$ will, if continued, cut the line of

zero pressure at the point O of zero volume, from which point the perpendicular line OA , the position of which we are seeking, may be erected.

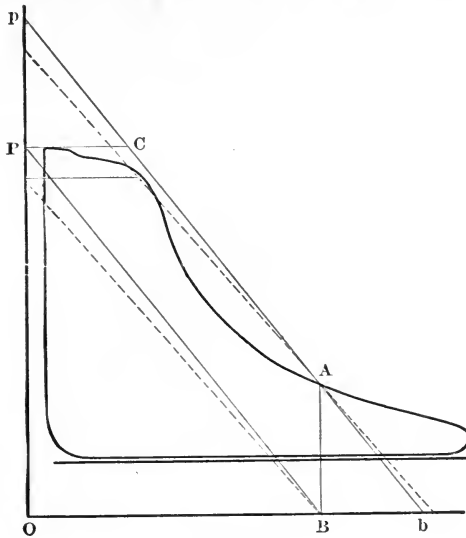

FIG. 59.

The theoretical curve is of value in showing what, under given conditions of pressure and expansion, a diagram may be expected to be, and serving as a basis of comparison for the actual diagram. It is not precise, however, and too much stress should not be placed upon its indications unless very marked.

The law that the product of the volume and pressure remains constant is true only of a perfect gas, and of this only when its temperature remains constant. The temperature of steam falls as it is expanded and

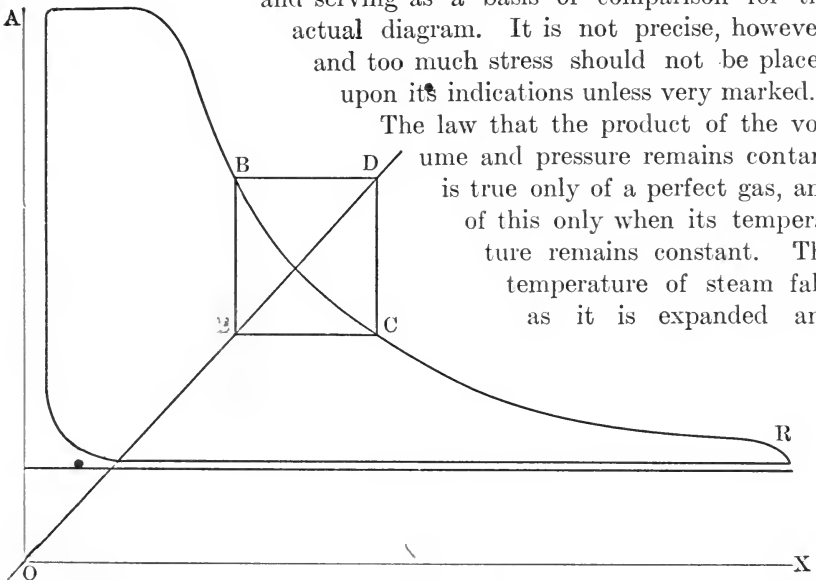

FIG. 60.

the volume would be expected to contract by such cooling so as to bring the expansion curve below that drawn upon the $pv = \text{constant}$ assumption. And it would so fall if a constant quantity of steam were being dealt with. But steam is being generated in the cylinder throughout the expansion. As explained above considerable of the steam

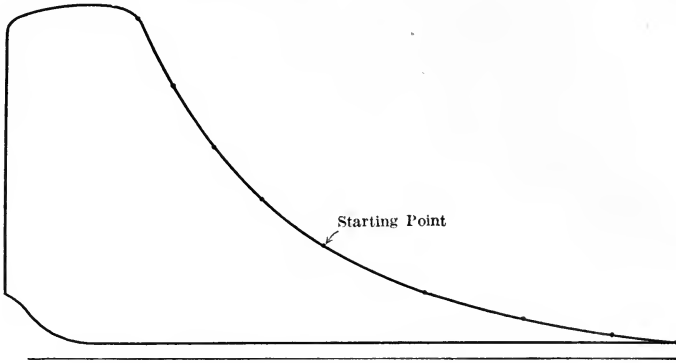

FIG. 61.

admitted to the cylinder is condensed and is present as hot water. When the pressure has fallen by expansion so that the water is above the boiling-point at the new pressure the water commences to pass into steam, taking from the cylinder surfaces and the other water the latent heat needed for its evaporation, and the additional steam thus made is, with ordinary

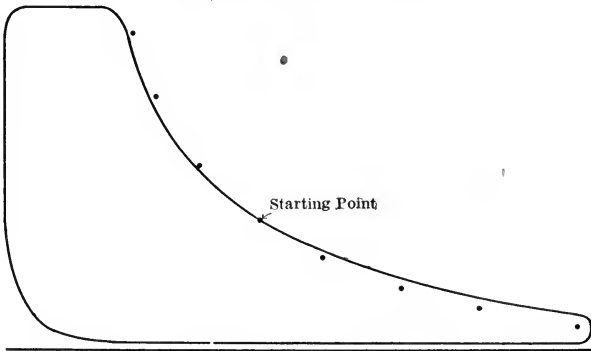

FIG. 62.

unjacketed engines and steam which is not superheated, just about enough to keep the expansion line up to that laid out according to this law. Any serious departure from the curve thus laid out indicates something which should be looked after. The line drawn by the indicator is likely to run below the plotted curve at the commencement and above it at

the end, as re-evaporation becomes more vigorous. The curve and law are also of use in designing, and in computing probable mean effective pressures, as will be shown later. If the actual curve runs much above the theoretical, it is an indication that steam is leaking into the cylinder during expansion. If it runs much below, a leaky exhaust valve is probable, but the indication should be regarded only as an intimation and be followed out by an investigation of the engine itself. The actual line may follow the plotted curve better with a leaky than with a tight engine. As an instance of this may be shown two diagrams taken by F. Ruel Baldwin, from an engine the exhaust valves of which leaked very badly. The first of these, Fig. 61, was taken while the valves were in their leaky condition, but the expansion curve fits the line of the diagram very nicely. Fig. 62 was taken after the valve had been made tight, but there is a considerable difference between the theoretical and the actual lines.

The accompanying transparent chart will be found convenient in comparing the expansion lines of actual diagrams with the theoretical curve. Draw upon the diagram the line of absolute zero 14.7 pounds (or whatever the barometric pressure may have been at the time it was taken) below the atmospheric line, and the clearance line locating its position by calculation, as in Fig. 55, if the percentage of clearance is known, or by construction, as in Fig. 60. Place the diagram beneath the transparent chart with the zero line under OX and the clearance line under OA and the theoretical curve may be studied directly or transferred to the diagram by pricking through the chart.



CHAPTER VIII

THE POINT OF RELEASE

WHEN it is possible of attainment we like to see the release end of a diagram given the appearance shown at *A* in Fig. 63, the release occurring early enough to allow the pressure to fall nearly or quite to the line of counter pressure by the time the end of the stroke is reached. If the release is delayed until the end of the stroke the appearance will be more like that indicated at *B*. If the pressure could be carried to the end of the stroke and immediately reduced to the line of counter pressure, as indicated by the outside edge of the black space, it would be advisable to retain the full area; but since some area must be lost here in expelling the exhaust, it is better that it should be above the diagram, as at *A* than below as at *B*. When the piston is approaching the end of its stroke, it has come to be a question of stopping it and sending it in the other direction. To do this smoothly compression is applied on the other side of the piston, and obviously there is no object in keeping up the forward pressure, as at *B*, unless we can add to the effective area of the diagram (which represents the useful work done by the steam) by doing so. It is therefore better to let the pressure fall off, as at *A*, assisting, instead of opposing, the compression in bringing the moving parts quietly to rest, and by this early release removing the back pressure represented by the black portion at *B*, so that the piston encounters less resistance in starting upon its backward stroke when it is an object to get it into motion. In this way nothing is sacrificed in the area of the diagram, and a better distribution of the pressures with reference to the practical work of the engine is obtained. The difficulty of attaining the result on most engines is that where the lap is removed from a valve to cause it to open early and give an early release, this very lack of lap retards the closure and does not give sufficient compression. On the Corliss valve this may be corrected by setting the eccentric ahead, making both release and compression earlier, but disadvantages attend upon too great an angular advance of the eccentric, in the way of shortening the range of cut-off, and the advantages of the valve motion in quick movement at admission, so that it is often necessary to divide the difference and compromise upon

a point like that shown at *C*. The benefit of an early release is very apparent when a condenser is used, for with an early release and a prompt realization of the vacuum, as at *D*, the largest possible percentage of the load is thrown upon the condenser; while a tardy release and a dragging action of the steam in leaving the cylinder results in the loss of a large area in the vacuum portion of the diagram as shown, by the shaded portion of *E*, calling for a later cut-off and more steam.

The shape of this end of the diagram depends largely upon the amount of expansion and consequent terminal pressure. If the steam

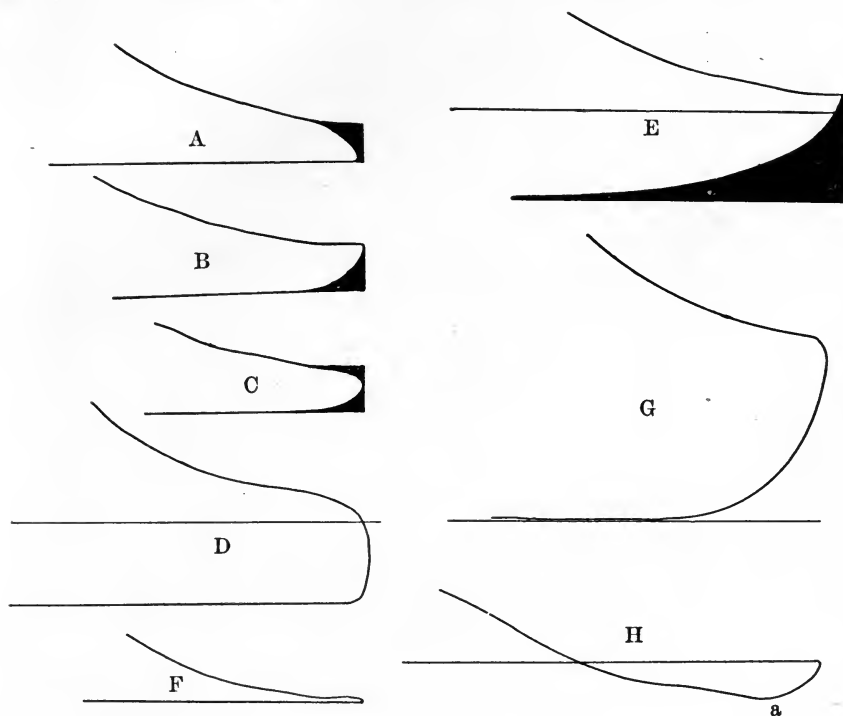

FIG. 63

is expanded to the line of counter pressure the diagram will terminate in a sharp point as at *F*, and at the end of the stroke the cylinder will be full of steam of the same pressure as that existing in the exhaust pipe. When the exhaust valves are opened there is, therefore, no flow, either out of or into the cylinder, except such as is caused by the movement of the piston. When the cut-off is late more steam is admitted, and has to be expelled, and we get an appearance more like *G*; and between this and the point shown at *F* there may be any variety of shapes, according to the terminal pressure and setting of the valves.

When the steam is cut off so early that the expansion extends below atmospheric pressure, or the pressure against which the engine is exhausting, we get an appearance like that shown at *H*. Here at the moment of release the pressure in the exhaust pipe is greater than that in the cylinder, and when the valve is opened at *a* there is an inrush of the previously exhausted steam, raising the pressure to the counter-pressure line. This condition is apt to cause a disagreeable slamming of the exhaust valve, which is lifted from its seat when the pressure in the cylinder becomes less than that beneath the valve, and is slammed closed again when steam is admitted. It may be stopped by throttling the initial pressure so that the lessened expansion does not cause a loop.

During the formation of this loop the pressure urging the piston forward has been less than that against which the piston moves, the forward motion continuing only by reason of the momentum of the fly-wheel and moving parts, so that the area of the loop represents just so much work exerted against the piston, and must be subtracted from the other area of the diagram to get at the effective work. This point will be considered in detail when we come to working up the diagram for power.

CHAPTER IX

THE COUNTER-PRESSURE LINE

THE tendency of a piston to move depends upon the difference in pressure upon its two sides. If there were 30 pounds pressure in both ends of the cylinder at once the piston would not move any more than though there were no pressure at all. If there were 30 pounds pressure on one side and 15 pounds on the other, the force with which the piston would tend to move would be the same as though there were 15 pounds on one side and nothing on the other. In other words, the "effective" pressure is the unbalanced pressure, or the difference in pressure between the two sides.

The pressure upon the piston during the forward stroke is represented by the steam and expansion lines, the pressure in the same end of the cylinder during the backward stroke is represented by the exhaust-, counter-pressure, or back-pressure line, as it is variously called. Obviously an engine will be doing the greatest amount of work when the pressure urging the piston forward is greatest and the retarding effect of the back pressure is least. Steam will not flow, however, from one place to another without a sufficient difference in pressure to overcome the resistance to movement through the connecting pipes and passages. If at the end of the stroke the steam has been expanded to atmospheric pressure in a non-condensing engine, there will be no immediate outrush of steam from the cylinder when the exhaust valve opens, because there is no greater pressure in the cylinder than that of the atmosphere into which the steam must flow. The steam must therefore be pushed out by the piston, and the resistance to its movement will depend upon the velocity with which it flows and the length and directness of the exhaust pipe. The size of the exhaust pipe and passages is involved in the velocity of flow. If the exhaust pipe were as large as the cylinder and directly open to it the rate of flow in linear feet per minute would be the same as the piston speed. If the area of the pipe or the passage leading thereto were one-half the cross-sectional area of the cylinder the rate of flow would be twice the piston speed, because to get through a passage of one-half the area in the same time the steam must travel twice as fast. As the resistance to flow increases with the velocity, it

is found desirable to limit the rate of flow in the exhaust passages to 6000 linear feet per minute, which, for a piston speed of 600 feet per minute, requires for the exhaust passages a cross-sectional area of one-tenth that of the cylinder. For other piston speeds the proper area of the exhaust passages may be found by multiplying the cross-sectional area of the cylinder by the piston speed in feet per minute and dividing by 6000.

The compression of the steam by the piston pushing it out of the cylinder against the resistance to flow through the pipes and passages, will show on the indicator diagram in raising the line of counter-pressure above the atmospheric line in a non-condensing engine. In a well-

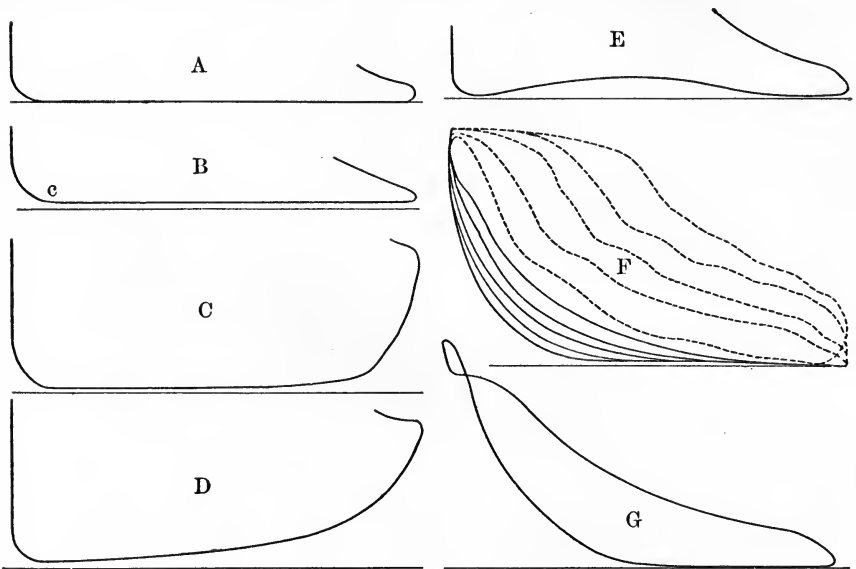

FIG. 64.

proportioned engine at moderate piston speeds and exhausting through a short and ample exhaust pipe this moving pressure will not be noticeable with an ordinary spring, and the line of counter-pressure will merge into the atmospheric line, as at A, Fig. 64. Under less advantageous circumstances, however, the back-pressure line will be elevated above the atmospheric line, as at B, and the distance between them will be a measure of the force required to overcome the resistance to the outflow of the exhaust.

The beginning of the back-pressure line depends, as may be seen from the last chapter, very much upon the point of release and the terminal pressure. When at the end of the stroke the cylinder is full of steam of a high pressure, we have a rapid outflow of steam as soon

as the valve is opened for release, but even with the greater impelling pressure a sufficient velocity is not generated to discharge this greater volume of steam (which expands when the pressure is reduced) before the piston gets some distance on its way back, making the beginning of the back-pressure line like *C*; and sometimes the back pressure does not reach its lowest point until the backward stroke is practically completed, as at *D*.

Sometimes we find a diagram where the back-pressure line starts in well enough, but makes a gradual rise toward the center of the diagram, falling again as the stroke is completed, as at *E*. This may be caused by too great velocity in the middle of the stroke, either from contracted ports or too much inside lap on a slide valve narrowing up the exhaust passage as the center of the stroke is reached, and where the piston, and consequently the steam, has the greatest velocity. The same effect may be produced upon a Corliss engine. It is also found where a pair of cylinders working on cranks set at 90 degrees exhaust into the same pipe, the release of one cylinder occurring practically in the middle of the stroke of the other and the efflux of steam into the pipe causing a rise of pressure.

The end of the back-pressure line depends for its shape upon the amount of compression. At *c* in diagram *B*, Fig. 64, for instance, the exhaust-valve closes and the steam remaining in the cylinder is compressed, the pressure rising upon the curve shown. With no compression the back-pressure line would continue straight to the end of the diagram, and with a prompt admission we should have a square corner at the end. When the compression commences earlier in the stroke the compression curve runs proportionally higher, as is well shown at *F*, taken from an engine where the compression varies with the load, and showing the effect upon the counter-pressure line of closing the exhaust valve at different points in the stroke. It is even possible to carry the pressure, by compression above that in the steam chest, so that when the valve opens for the admission of steam, the pressure in the cylinder being greater than that in the steam chest, there is a drop instead of a rise to the line of realized pressure, as shown at *Q*.

CHAPTER X

THE COMPRESSION LINE

COMPRESSION is the inverse or opposite of expansion. In making the expansion line the volume of steam admitted up to the point of cut-off is increased in volume, the pressure falling in an inverse ratio, and we remember that the product of the volume and pressure was constant. In compression the volume of steam inclosed when the exhaust-valve closes is diminished in volume with a consequent increase in pressure, and in this case too the product of the volume and pressure is constant. If we compress the steam into half the space which it occupies when the exhaust-valve closes we shall double its absolute pressure; into one-third the space, treble its pressure, etc. The clearance space, being in most cases a large proportion of the volume inclosed, becomes of increased importance.

In Fig. 65 suppose the exhaust-valve to close at O and the clearance to be bounded by the line OA . There is then shut into the cylinder when the exhaust closes a volume of steam proportional to the line OS and of an absolute pressure equal to SC . When the piston has advanced to 4 this volume will be one-half of OS and the pressure will be twice SC ; so at 6 the volume will be $\frac{2}{3}$ of that at C and the pressure $\frac{3}{2}$; at 1 the volume will be $\frac{1}{3}$ and the pressure 3 times that at C . The pressure at the various points can be calculated and measured upon the ordinates by scale, or the line can be laid out graphically for the compression line by any of the methods shown for the expansion line by using C in the same manner that the point of cut-off was used in laying out the expansion line, and spacing off vertically upon the line OA , or on an extension of SC instead of upon OS , as for the expansion line. In Fig. 65 the curve is laid out by the method described in Fig. 55, page 57. It is rarely that it is of service to apply the curve to the compression of an actual diagram unless it is from a single-valve automatic engine, where under light loads the compression line becomes nearly as large and important as the expansion. It will be remembered that in Fig. 60, page 61, it was shown that if a rectangle was constructed upon the expansion line, with sides parallel and perpendicular to the atmospheric line, its diagonal prolonged would cut the zero line OX at the

intersection of the line *OA* bounding the clearance. This is equally true of the compression line, and it will be seen in Fig. 65 that the diagonal *OD* of the rectangle *abcd* cuts *OS* at the intersection of the clearance line *OA*. In Fig. 65 the admission valve commences to open at about *e*, and as the piston comes to a standstill merges the compression into the admission line. The dotted line shows where the pressure would go if the piston advanced further into the clearance.

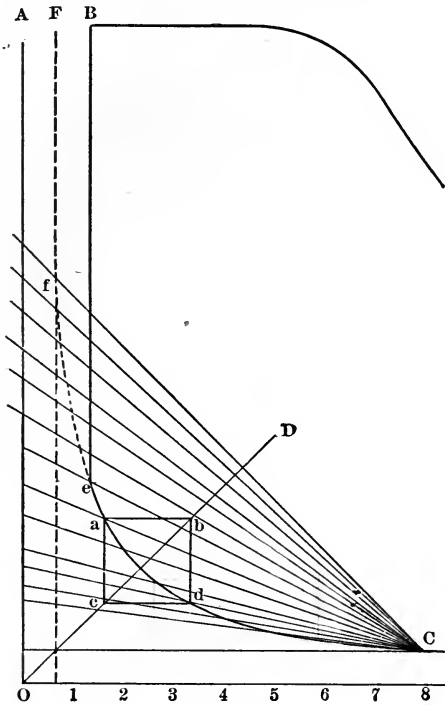

FIG. 65.

It is difficult for some engineers to understand how there can be compression in a condensing engine. There is, they reason, a vacuum in the cylinder when the exhaust valve closes, and nothing to compress. This would be true if the vacuum were complete, but the "vacuum" of practice is simply an absolute pressure less than that of the atmosphere. The less the absolute pressure the more complete the vacuum. The pressure of the atmosphere is equal to about 15 pounds or 30 inches of mercury. When we have a vacuum of 26 inches we have still in the condenser an absolute pressure of $30 - 26 = 4$ inches of mercury, or two pounds available for compression.

The amount of pressure or the effective compression obtained by closing the exhaust-valve does depend, however, upon the tension or

pressure of the vapor inclosed in the cylinder when the exhaust-valve closes. Referring to Fig. 66, suppose we have an engine where the clearance space OA is one-quarter of the total volume, OC between the piston, cylinder head, and valves after the exhaust-valve closes. If the counter-pressure line of the diagram was only 3 pounds above the line of absolute zero, corresponding to a vacuum of 24 inches, there would be three pounds less than the atmospheric pressure at the end of the stroke, as shown at a . If there were only 12 inches of vacuum or 9 pounds absolute to start the compression with we should get up to 21 pounds, as at b . With a non-condensing engine and no back pressure (above the atmosphere) we should get 45 pounds by compression, as at c , while with 6 gage pounds back pressure we should

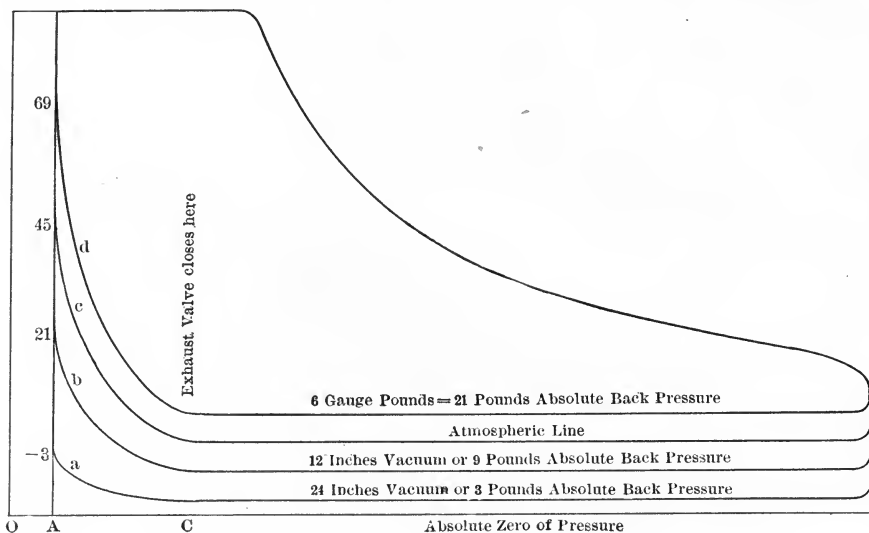

FIG. 66.

get up to 69 pounds above the atmosphere with the same valve setting and point of exhaust closure that gave 3 pounds less than atmospheric pressure with the low counter-pressure line.

The smaller the clearance, too, the greater the pressure realized by compression, with the same point of exhaust closure, on account of the small final volume possible. In Fig. 65, with the clearance AB , a pressure equal to e was realized. If we had half the clearance, i.e., if the piston could have advanced to F , we should have realized a pressure equal to f . In engines with a variable compression it is necessary to have a considerable proportion of clearance or the pressure would be excessive with the early exhaust closure usual with light loads. As it

is, the pressure generated by compression frequently exceeds the initial pressure (see diagram *G*, Fig. 64, page 68).

The object of compression is initially to furnish a cushion or gradually increasing resistance, to bring the moving parts to rest and change the direction of the push upon them without the shock which would follow upon the sudden opening of the steam-valve. In Fig. 67 the piston is moving to the right, or toward the shaft, and the engine is about in the position shown in the small sketch between the diagrams. Every joint between the piston and the main crank pin is in compression, and the main shaft is pushed hard against the outer face of the bearing. When the crank reaches the center, and the pressure acts on the other side of the piston, the connecting rod will pull instead of push, every joint will be extended, and the main shaft pulled against the back of the bearing. If this change in pressure is effected suddenly every particle of lost motion in every joint and bearing will be taken up with a

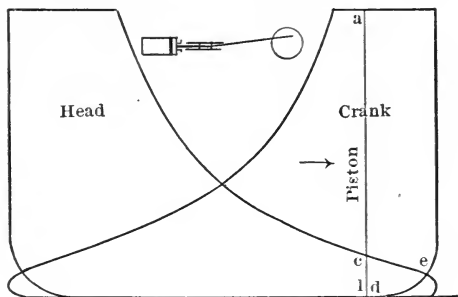

FIG. 67.

thump, and it is only by changing the pressure gradually from one side to the other that we can make it run smoothly. When the piston is at the point in the stroke indicated at *al*, there is behind it the pressure *lc*, and no pressure but that of the atmosphere in front of it. As it moves along, the pressure behind it decreases while at *d* the pressure in front of it begins to increase, and at *e* the pressures on both sides are equal. After this the pressure in front exceeds that behind the piston, but the change is gradual, the direction of thrust is changed under a slight difference of pressure, and when the steam is admitted the bearings and journals are already firmly pressed against the surfaces upon which they are to bear. In addition to the steam pressure moving the piston forward there is the momentum of the moving parts to be reckoned with.

Aside from its cushioning effect compression has another advantage in reducing the loss from clearance. Take an exaggerated instance. Suppose an engine with a clearance equal to 100 per cent, i.e., that the

volume of steam required to fill the space behind the piston, including ports, etc., when the engine is on the center, is equal to the volume generated by the piston's movement, i.e., the piston area multiplied by the length of the stroke. It is understood that the indicated power is in proportion to the inclosed area of the diagram. Before the piston can move, the clearance must be filled with steam, and supposing the engine to work without expansion, it would take two cylinderfuls of steam to do the work of one stroke, one to fill the clearance, and one to supply the space behind the moving piston. In Fig. 68, then, there would be required a volume of steam proportional to the rectangle $ABCD$ to do an amount of work proportional to the rectangle $EFCD$. Now suppose the exhaust-valve to close at c so as to fill the clearance by compression with steam at the initial pressure, the area of the diagram has been reduced by the amount below the dotted line, but

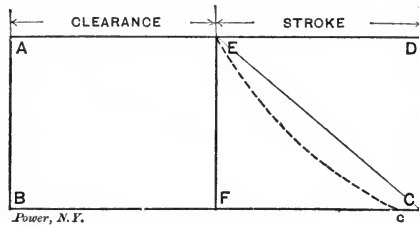

FIG. 68.

we have still considerably *more than half* of it left, and as the clearance is already full, have used *only half* the volume of steam.

Where there is no expansion the steam required to fill the clearance space is a dead waste. With a cut-off engine it gets a chance to expand with the other steam and does some good, but still there is, theoretically, at least, a saving by compression and for the abstract case unmodified by such practical consideration as cylinder condensation, etc., the greatest area of diagram will be produced by a given volume of steam when the ratio of compression equals the ratio of expansion, i.e., when the clearance bears the same relation to the volume at the commencement of compression that the volume at cut-off does to the volume at the end of the stroke.*

It remains only to consider some of the forms obtained in practice. When the engine is of a type in which the compression is constant, the best results will generally be attained under normal loads by having the compression round up nicely into the admission line, as at a , Fig. 69, meeting the perpendicular line at about one-third of its height. This

* See Compression as a Factor in Steam Engine Economy, Proc. A.S.M.E. Vol. XIV, 189.

will require a different setting of the exhaust-valve for different heights of the counter-pressure line, as explained on page 72, and can be determined only by the indicator. If no indicator is used, put on only enough compression to make the engine run smoothly. At *b* is shown excessive compression, the pressure running up above that in the steam chest, so that when the valve opens for admission, steam flows from the cylinder to the chest and the pressure falls. A form of compression line often met which is shown at *c*, where the pressure instead of continuing upward along the dotted curve falls away as shown. When this occurs the cause for the reduction of pressure will usually be found in a leak. As the piston approaches the end of its stroke its movement becomes very slow, the volume of steam involved is small and growing smaller, and if there

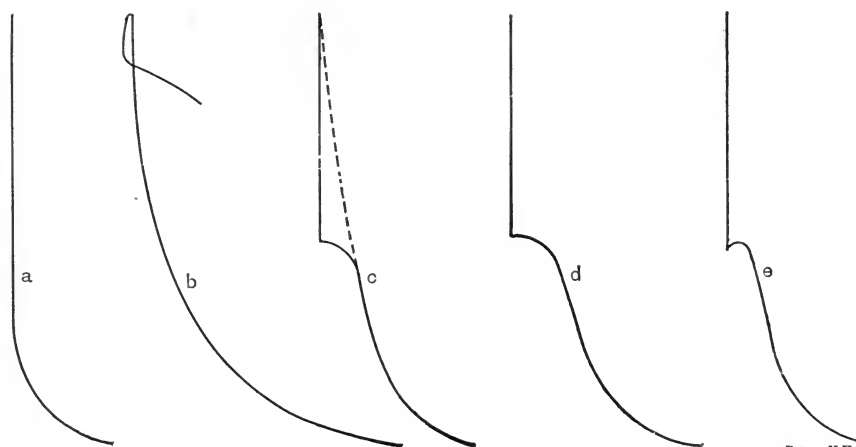

FIG. 69.

Fosser, N. F.

is even a slight leak in the exhaust-valve, drip-valve, or piston there will come a time when the volume of steam discharged through the leak will equal the volume generated by the movement of the piston in the same time. To state it more simply, at all times the pressure will be lower than if there were no leakage, and there will come a time when the escape through the leak with the increasing pressure will pull the pressure down as fast as the movement of the piston increases it, and the line will become horizontal as at *d*, or it may even fall away as at *e*. As soon as the pressure, from compression, behind the piston becomes greater than that in front of it a leak in the piston becomes effective to reduce the compression pressure. Such a diagram as Fig. 70, which was sent to the author for explanation as to the formation at *A*, might be caused by a badly leaky piston. It will be seen that the compression rises after the valve closes much more abruptly than it should

have done at that distance from the end of the stroke. This would be accounted for by leakage from the other side, where the pressure is still high, into the confined space in front of the piston. As the pressure behind the piston decreases, this action falls off, allowing the line to lean, and after the release occurs on the other end the leak is reversed, from the compression space into the other end, now opening to the exhaust, allowing the pressure to fall off as shown. It is probable, as the exhaust closure is early and the release late on this diagram, that a diagram from the other end of the cylinder would show opposite conditions, early release and little compression, which would locate the turn in the curve about where it occurs in the diagram. As a general rule, when

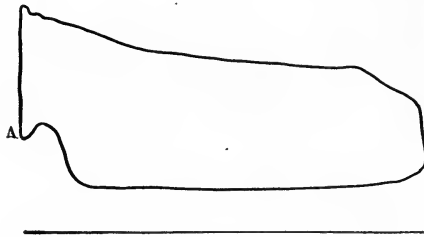

FIG. 70.

you see a compression line falling off badly, look out for leaks. It is a better indication than a failure of the expansion line to follow the theoretical.

It is a matter for consideration, however, if condensation does not play an important part in the formation of such departures from the regular curve. The surfaces of the cylinder head, piston, and ports have just been exposed to the temperature of the exhaust, and as the piston nears the end of its stroke they bear a large proportion to the small volume of steam inclosed. Enough steam must be condensed upon those surfaces to bring them up to the temperature corresponding to the pressure before the steam can remain as steam in contact with them, and this condensation might account for the falling off in pressure necessary to produce these deviations from the true curve.

CHAPTER XI

MEASUREMENT OF THE DIAGRAM FOR MEAN EFFECTIVE PRESSURE

ONE of the principal uses of the indicator diagram is to determine the horse-power which the engine is developing. One of the important factors in this problem is the pressure urging the piston forward, and this can be found with any accuracy only from the indicator diagram. The

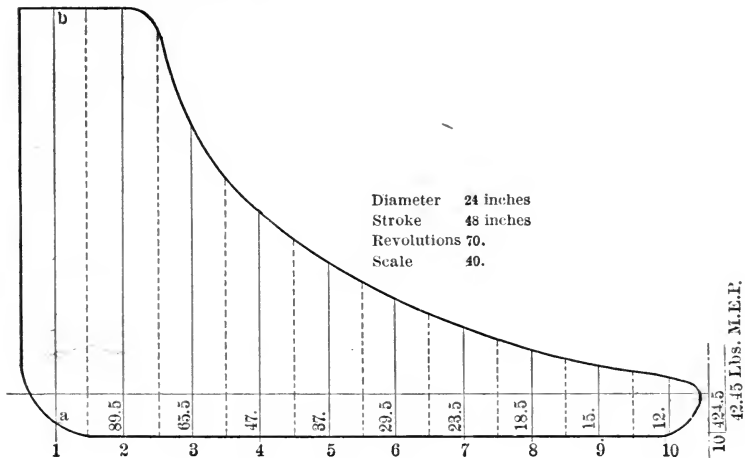

FIG. 71.

pressure varies through the stroke, and is opposed by a varying amount of back pressure, so that the average unbalanced, or, as it is commonly called, the "mean effective pressure," must be determined. The most elementary way of doing this is by measuring the pressure upon the diagram at a number of equidistant points and taking the average. To do this, divide the diagram into a number of equal parts lengthwise, (ten for ordinary work) as shown in Fig. 71 by the dotted lines and, with a scale corresponding to the spring with which the diagram was taken, measure the pressure in the center of each of these divisions; that is, upon the full lines or ordinates. Notice that this pressure must be measured between the lines of the diagram, as from *a* to *b*, whether

the engine is condensing or non-condensing, and not from the atmospheric or any other line.

Performing this operation on the diagram shown in Fig. 71 we find, with a 40-pound scale, 87 pounds on the line or "ordinate" 1; 89.5 pounds on 2; 65.5 on 3; 47 on 4; 37 on 5; 29.5 on 6; 23.5 on 7; 18.5 on 8; 15 on 9; and 12 on 10. Adding these values we have 424.5 for

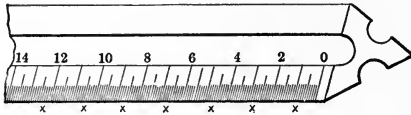

FIG. 72.

the sum, and dividing by 10, the number of measurements, find the average or mean effective pressure to be 42.45 pounds.

Several expedients may be resorted to for shortening the labor of dividing the diagram and locating the ordinates. The simplest of these is to have a rule, a little longer than the ordinary length of your diagrams, divided as shown in Fig. 73 just as you want your diagram to be divided,

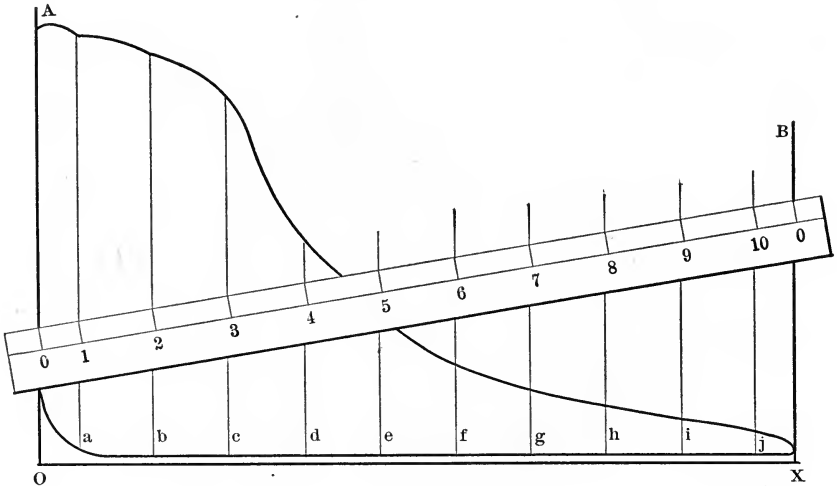

FIG. 73.

with nine spaces of equal length in the middle, the two end spaces, 0 to 1 and 10 to 0, being one-half the width of the others. Four inches between the zero marks is a good length for diagrams from $3\frac{1}{2}$ to 4 inches in length, and one each of $3\frac{1}{2}$ and $4\frac{1}{2}$ inches, with a short one for the diagrams from small cylinders, will cover all ordinary cases.

Draw the lines *OA* and *XB* at the extreme ends of the diagram and perpendicular to the atmospheric line. Place the rule between them,

as shown in Fig. 73, at such an inclination that both zeros come upon the perpendiculars. Then with a needlepoint prick the card opposite each division of the rule, and draw the ordinates perpendicular to the

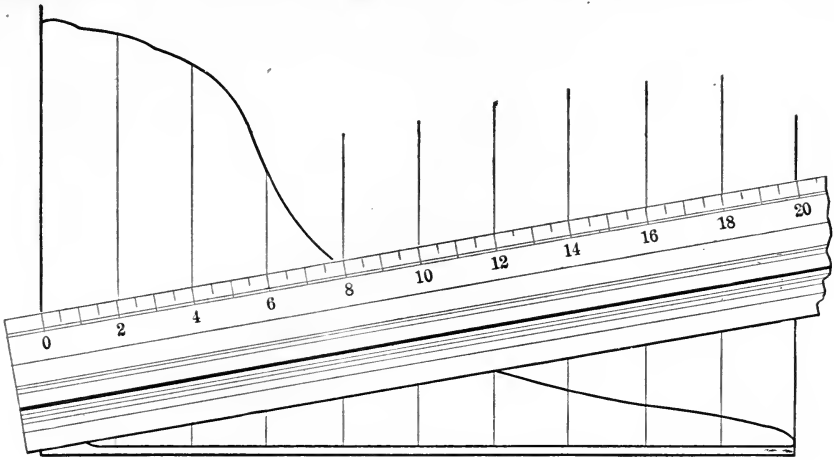

FIG. 74.

atmospheric line and through these points. An engineer's scale, such as that referred to on page 9 and shown in Figs. 8 and 72, may be used to advantage in this work. If the diagram is just 4 inches long

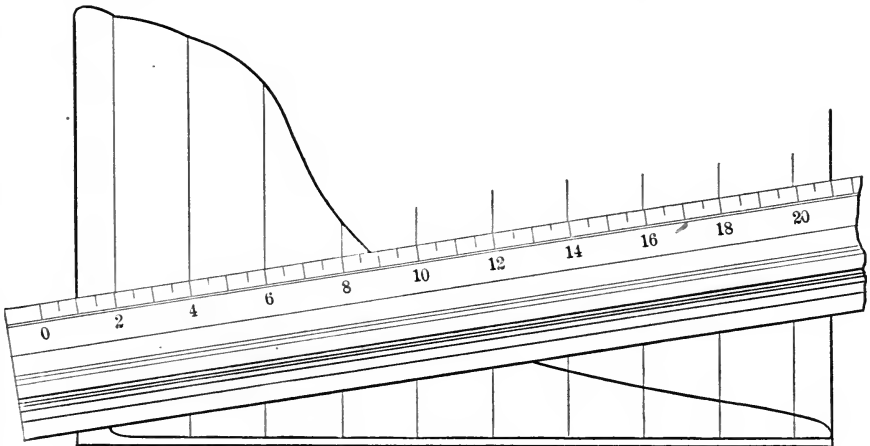

FIG. 75.

the 20-pound divisions of the 50 scale will just divide it into ten equal parts. If it is less than four inches incline the scale as in Fig. 74, so that the zero is upon one line and the 20 on the other. The figured divisions will divide the space into ten equal parts. In order to get a

half space on each end (that is, to locate the ordinates in the center of the equal tenths), slide the scale to the position shown in Fig. 75 so that the 1 mark is on one line and the 21 mark on the other. Make a needle hole or pencil mark at the edge of the scale against each numbered division and erect the ordinates square with the atmospheric line and passing through the points indicated. The 50 scale works very well down to diagrams $3\frac{1}{2}$ inches in length, which are exactly divided into tenths by the numbered divisions of the 60 scale; and for this length and below, the 60 scale will preferably be used, as the inclination of the 40 scale becomes too great. For diagrams between 4 and 5 inches the 40 scale is used in the same way. No calculation is required. If the diagram is, on trial, too long for the 50 scale, use the 40; if you have to use the

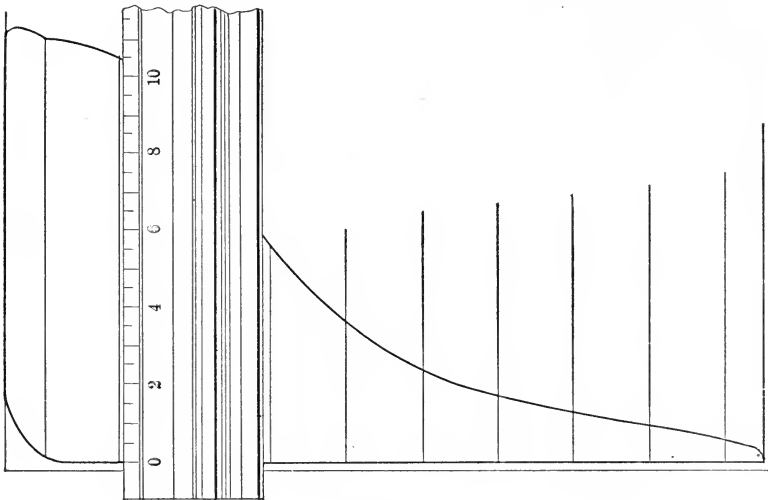

FIG. 76.

50 scale at too much of an angle, use the 60. A little use will make the process perfectly natural.

The principal advantage of such a scale, however, especially the 12- or 14-inch scale, is in measuring the length of the ordinates. Usually the pressure on each ordinate is measured with the minute divisions of the common scale, the ten observations added, and the sum divided by ten to get the average. Now we can divide by ten to start with by dividing the value of the scale and at the same time get the advantage of the coarser reading. With a 40 spring, instead of calling 1 inch 40 pounds, suppose we call it 4 pounds. Then we can measure the ordinate, add the results, and have the mean effective pressure at once. The pound, instead of being $\frac{1}{40}$ of an inch will be $\frac{1}{4}$. The finest divisions of the scale will represent tenths of pounds instead of full pounds, so

that they can be read much more accurately, and the numbers on the scale will correspond with the pound marks. Thus in Fig. 76 we have on the ordinate to which the scale is applied, 10.5 pounds pressure. This

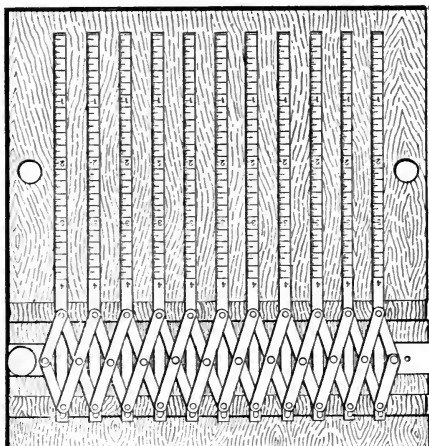

FIG. 77.

is, of course, only one-tenth of the pressure which that particular ordinate represents, but we shall give the pressure ten records, so that the aggregate will be the same as though we measured each on the given scale and then divided the aggregate by ten.

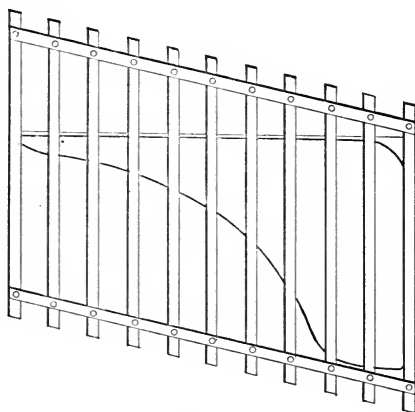

FIG. 78.

There are also procurable from the instrument makers parallel rules, as shown in Figs. 77 and 78, whose method of application is too obvious to require description.

Instead of measuring each ordinate with the scale corresponding to the spring with which the diagram was taken, some engineers prefer to lay off the lengths of the ordinates continuously on the edge of a strip of paper, then to either measure the whole length with a long scale of the proper unit, or with a scale of common inches, and multiply the length by the scale of the spring.

In the measuring of the mean effective pressure by ordinates there remains to be explained the treatment of diagrams having negative or back-pressure areas. For example, in Fig. 79, after the point *a* is

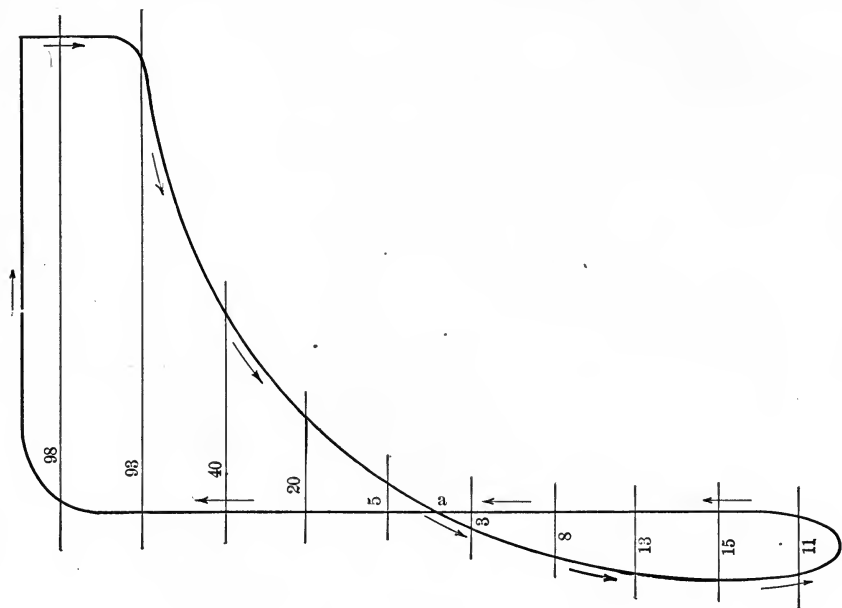

FIG. 79.

passed, the forward pressure in the cylinder is less than the back pressure during the return stroke. The piston is actually hanging back upon the engine, and the loop not only represents no addition to the useful mean effective pressure, but a force acting against the motion of the engine equivalent to so much back pressure. The average pressure of the loop portion of the diagram must therefore be subtracted from that of the other portion. Erecting the ordinates as before directed, and measuring with a 40 scale, we have $98 + 93 + 40 + 20 + 5 = 256$ as the sum of the measurements in the main portion of the diagram, and $3 + 8 + 13 + 15 + 11 = 50$ as the sum of the measurements in the loop. Taking the difference and dividing by 10 to get the average, we have

$$\frac{256 - 50}{10} = 20.6 \text{ lbs. M.E.P.}$$

CHAPTER XII

THE PLANIMETER

THE area of a rectangle, as *A, B, C, D*, Fig. 80, is found by multiplying its height by its length. If the figure shown were 2 inches high and 4 inches long it would obviously contain $2 \times 4 = 8$ square inches of area. If on the other hand it were known that its area was 8 square inches and its length 4 we could easily tell that it was $8 \div 4 = 2$ inches high. If we wanted to know how high it would be if it were any other length to contain the same area, we would simply divide the area by the new length. If the rectangle in Fig. 80 were lengthened to 8 inches

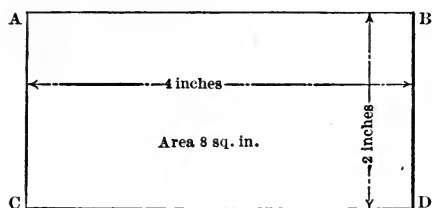

FIG. 80.

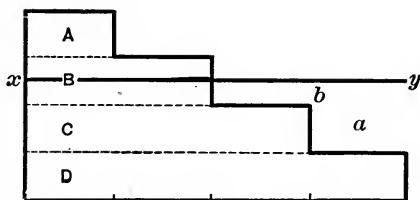

FIG. 81.

it could, to contain the same area, be only $8 \div 8 = 1$ inch high, or if lengthened to 6 inches $8 \div 6 = 1\frac{1}{3}$ inches.

Suppose now we have a figure like Fig. 81, and wish to know its average height. We could divide it into a number of rectangles, as shown by the dotted lines, and find the height which each rectangle would be if extended to the full length of the diagram. Supposing the diagram to be 4 inches long, the area *A* would be one-half an inch high and an inch long, containing therefore one-half a square inch of area. If this were extended to 4 inches its height would be reduced to $\frac{1}{2} \div 4 = \frac{1}{8}$ of an inch. The area *B* is $2 \times \frac{1}{2} = 1$ square inch, and would be $1 \div 4 = \frac{1}{4}$ of an inch high if 4 inches long. Similarly *C*, containing $1\frac{1}{2}$ square inches, would be $1\frac{1}{2} \div 4 = \frac{3}{8}$ of an inch high, and *D*, already 4 inches long, is one-half an inch high. So for the total average height we should have $\frac{1}{8} + \frac{1}{4} + \frac{3}{8} + \frac{1}{2} = 1\frac{1}{4}$ inches, bringing the average height at the line *xy*. That this is right is evident at a glance, for the area *A* will just fill the space *a*, and that part of *B* which is above the line *xy* will just fill the

space b below it. But if we know in the first place the area of the whole figure we can get at the average height at once by dividing that area by the length, for obviously the whole is equal to the sum of all its parts, and we shall get the same result by dividing the whole area by 4 as by dividing each of its parts by 4 and adding the quotients. Thus the whole area of Fig. 81 is $\frac{1}{2} + 1 + 1\frac{1}{2} + 2 = 5$ square inches, and $5 \div 4 = 1\frac{1}{4}$, the same as the sum of the several divisions.

In an indicator diagram the height is proportional to the pressure, and to find the average pressure we must find the average height. We have an irregular figure which we wish to reduce to a rectangle of the same area and to know the height of the rectangle. Imagine the diagram stepped off into the boundaries of rectangles, as in Fig. 82, and it will

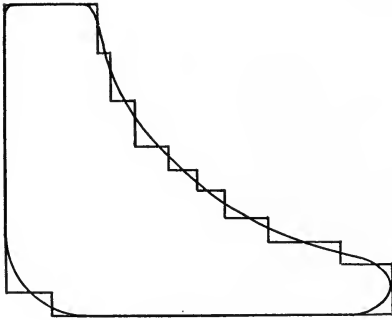

FIG. 82.

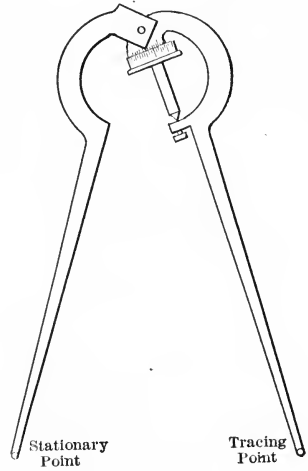

FIG. 83.

be clear, in view of what has been said about Fig. 81, that dividing its area by its length will give its average height; and inasmuch as this is true however fine the divisions or steps, we may imagine them to be so fine as to be included in the width of the line which bounds the diagram, and arrive at the fact that the area of an indicator diagram, or any other plane figure for that matter, divided by its length equals its average height.

Fortunately a means is at hand for easily and accurately measuring the area of such diagrams. The planimeter, the instrument used for this purpose, is made in a variety of forms, and is sold at prices ranging from five to thirty-five dollars. The Amsler was the first upon the market, and as a typical example is shown in Fig. 83. It consists of two arms pivoted at the top, upon one of which is carried a roller free

to revolve upon an axis parallel to the arm itself. The roller is divided circumferentially into ten equal parts, each of which represents a square inch of area, and each of these parts is further divided into equal parts representing each one-tenth of a square inch, as shown in Fig. 84. Close to the edge of the roller is a stationary plate having the same curvature and containing a vernier made by dividing a space nine-tenths as long as one of the large divisions of the roller into ten equal parts.

In Fig. 85 let the space between *A* and *B* represent one of the larger divisions of the wheel, and the space between *C* and *D* the vernier. In reading the instrument take the number on the wheel which has passed the zero mark of the vernier when the wheel is turning to the left as indicated by the arrow, as the number of whole square inches, in this case 6. The tenths of a square inch are indicated by the number of spaces, such as *a*, which have passed the zero mark, in this case 1; so that the reading of the scale as laid down in Fig. 85 is 6.1 square inches.

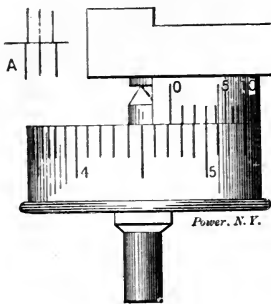

FIG. 84.

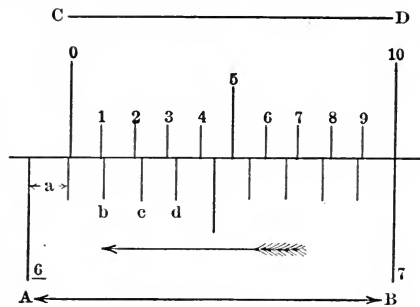

FIG. 85.

Since the vernier *CD* is nine-tenths as long as *AB* each division of the vernier must be nine-tenths of each division of the scale. From *O* to 1 on the vernier is nine-tenths of the space beneath it on the wheel, then the space between the line *b* on the wheel and the line 1 on the vernier is just one-tenth of one of the spaces such as *a* upon the roller, the space between the lines 2 and *c* is just two-tenths, between 3 and *d* three-tenths, etc. If, then, the wheel rolls in the direction of the arrow one-tenth of one of the spaces *a*, corresponding to an area of one one-hundredth of a square inch, the lines 1 and *b* will coincide, for two one-hundredths 2 and *c* would coincide, so that we get the hundredths of a square inch by writing that number on the vernier which is opposite any line on the wheel. For instance, in reading the instrument as it stands in Fig. 84 write, first, the number on the wheel to the left of the zero mark, in this case 4; then the number of whole spaces between that number and the zero mark, in this case 7; and last the number on the vernier which is in line with a mark on the wheel, in this case 3.

The whole reading therefore is 4.73 square inches, the decimal point being placed after the 4, the 7 and 3 being tenths and hundredths as before explained. It will be noticed that only the zero, 5, and 10, are

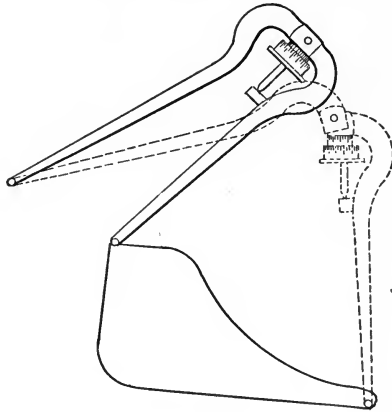

FIG. 86.

numbered on the vernier in Fig. 84, and this is the case in the actual instrument, the intermediate marks being easily known by their position.

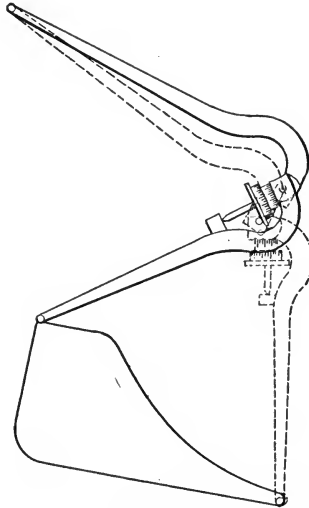

FIG. 87.

The eye soon becomes accustomed to quickly determining the mark upon the vernier which coincides with one upon the wheel, the marks at either side of it being just within the marks upon the wheel, giving the arrangement shown at *A* in Fig. 84.

The planimeter should be used upon a smooth but not slippery surface, such as that of heavy drawing paper or Bristol board. Place a sheet of this large enough to include the planimeter and the diagram upon the drawing board, and fasten it with thumb tacks. Set the stationary point of the planimeter into the paper in such a position that the tracing point can be carried around the outline of the diagram without bringing the wheel into contact with the edge of the paper. The instrument can be worked to the best advantage when it is neither allowed to close up too closely, as in Fig. 86, nor to extend too widely, as in Fig. 87. A better position for the stationary point than either of these is shown in Fig. 88, the motion of the roller being easiest when the arms are near a right-angular position. When the areas to be measured are large, or when there is considerable space between the top of the diagram and the top edge of the card, contact of the roller with the edge of the

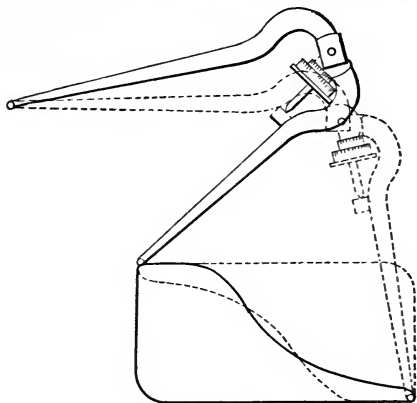

FIG. 88.

card may be avoided by inverting the diagram, as indicated by the dotted diagram in Fig. 88, using the planimeter always in the same direction, that in which the hands of a watch run; for obviously the area of the diagram remains the same in whatever position the card is placed.

Place the tracing point on any convenient point in the line of the diagram and, by pressing upon it, make an incision, to mark the point of starting. Take the reading of the instrument as it stands, then with the tracing point follow the line of the diagram in the direction in which the hands of a watch move, as indicated by the arrows in Figs. 89 and 90. Follow the line as made by the pencil, not necessarily in direction (for on a right-handed diagram, as in Fig. 89, you will have to trace in the opposite direction from that of the pencil which made it, in order to carry the tracing point in the direction of the hands of a watch), but

in course. For instance, in Fig. 79, do not leave the expansion line at *a* and run out on the back-pressure line, but follow the diagram naturally all the way around, as the arrows indicate, and as it was drawn by the pencil; and in Figs. 89 and 90 do the same, although in this case you will trace the diagram backward from the direction in which the pencil went over it. If the pointer traces in the opposite direction to the hands of a watch the wheel will take out the area instead of adding it. In Fig. 79 we saw that the area of the loop was negative, and that it needed to be subtracted from the other part of the diagram to get the mean effective pressure. It will be seen that by following the lines of the diagram as directed the tracing point of the planimeter will pass around the negative portions of the diagram in a direction contrary to the hands of a watch, and that therefore these areas will be automatically subtracted. In this connection, be careful when starting to trace a diagram with loops, to move the tracing point in a direction that will

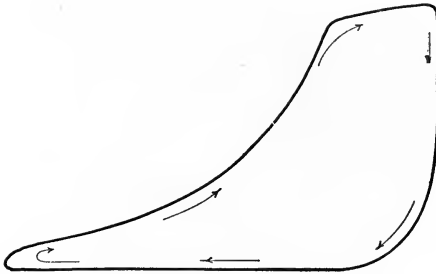

FIG. 89.

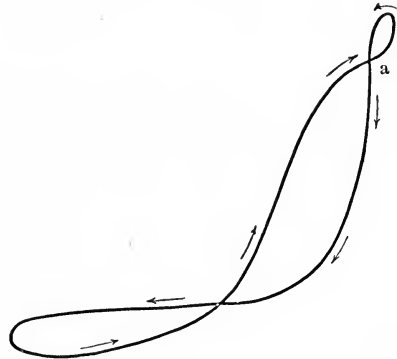

FIG. 90.

carry it with the hands of a watch over the main portion of the diagram. If Fig. 90, for instance, were started at the point *a* or anywhere within one of the loops the first movement of the tracing point would have to be in the opposite direction from that of the hands of a watch.

Having traced around the diagram and brought the pointer around and into the hole from which it started, take the reading in the new position, subtract from the reading in the starting position, and the difference will be the area of the figure traced. If the roller were placed at zero to start with, the reading would give the area at once but it is easier to take the instrument as it stands and subtract the initial reading. Suppose we start with the wheel at 1.42, and after tracing the diagram find the reading to be 4.69, then the area will be $4.69 - 1.42 = 3.27$ square inches. Now to prove the work, trace the diagram again, write the result above the former reading, again take

the difference, and if the work has been accurate the last reading should be 7.96. If we run around still again the reading would be 1.23. This value would really be 11.23, as we started from 7.96 and added 3.27 inches, but as the capacity of the wheel is limited to 10 inches, we have to understand the addition in the tens column and simply borrow one when we subtract the 7.96. The readings are as follows:

$$\begin{array}{r} 11.23 \\ 7.96 = 3.27 \\ 4.69 = 3.27 \\ 1.42 = 3.27 \end{array}$$

The three readings agreeing, we may feel certain that our work has been correctly done and that the area of the diagram is 3.27 square inches. By dividing this area by the extreme length the average height is found.

To measure the length of the diagram, draw lines as ab , cd , Fig. 91, perpendicular to the atmospheric line and touching the extreme end of the diagram. No matter what the shape of the diagram may be, no portion of its line must extend outside of these perpendiculars, which

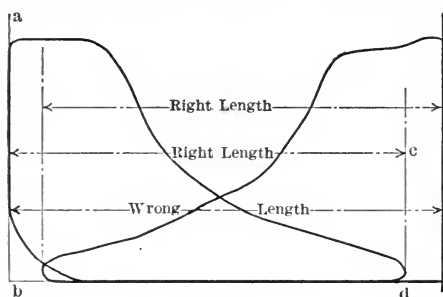

FIG. 91

must, however, touch the diagram at both ends. When two diagrams are taken on one card, however, remember that you want the length of *each* diagram, not the extreme length between both, as shown in Fig. 91. Now measure the horizontal distance between these vertical lines. This is very handily done with the 50 scale of the 6-inch triangular scale, each 50th being equivalent to 0.02, so that the length may be expressed directly in decimals.

Divide the area as found by the planimeter by the length, and multiply the quotient by the scale of the spring with which the diagram was taken. The product will be the mean effective pressure.

In a planimeter the length of the tracing arm multiplied by the movement of the wheel equals the area traced. If in Fig. 92 the length of the tracing arm (the distance between the tracing point and the hinge)

is 4 inches, the circumference of the roller must be 2.5 inches in order that one revolution may equal 10 square inches. Inversely the wheel movement equals the area divided by the length of the tracing arm. If with the wheel having a circumference of 2.5 inches we used a tracing arm 5 inches long instead of 4 inches, in tracing an area of 10 square inches the wheel would not turn a full revolution. Its circumferential movement would have to be only 2 inches in order that that movement multiplied by the length of the arm might still be equal to the area, 10. The movement of the wheel, and thus the reading, is inversely proportional to the length of the arm. If the length of the arm is doubled the reading will be halved. If the arm is one-third as long the reading will be three times as large, etc. It has been explained that to get the mean effective pressure the area must be divided by the length of the diagram. If the diagram were twice as long, with a given area the mean effective pressure would be half as much. In other words the mean effective pressure varies inversely as the length of the diagram. Since the reading varies inversely as the length of the arm, and the mean effective pressure varies inversely

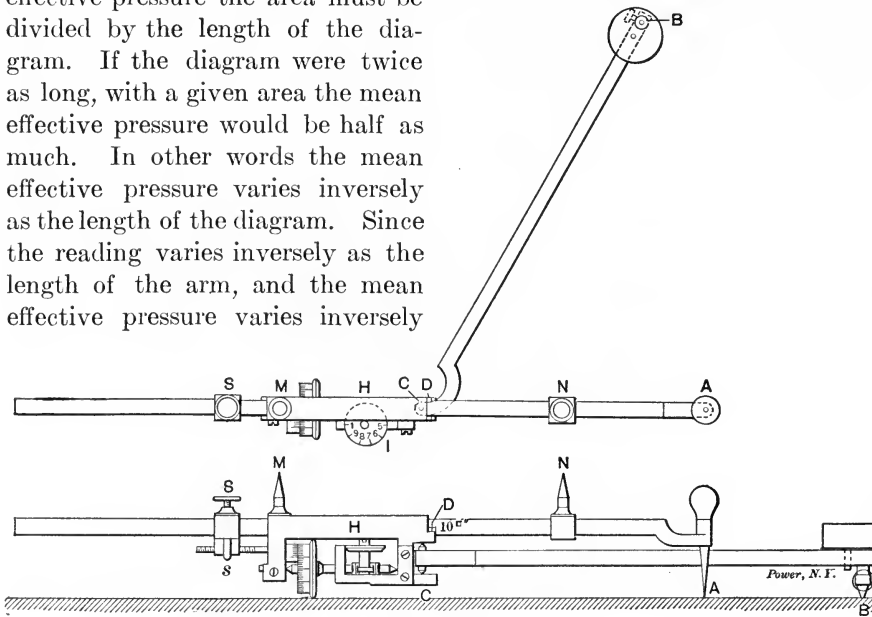

Fig. 92.

as the length of the diagram, we can, by making the length of the arm equal to the length of the diagram, make the reading proportional to the mean effective pressure. Suppose an instrument with an arm of 4 inches and a wheel having a circumference of 2.5 inches. One revolution of the wheel will mean 10 square inches. Suppose it is applied to a diagram 3 inches long and registers 3.75 square inches area. If the diagram was taken with a 40 spring the mean effective pressure would be

$$\frac{\text{Area} \times \text{scale}}{\text{Length}} = \frac{3.75 \times 40}{3} = 50 \text{ lbs.}$$

Suppose now we adjust the length of the arm so that it equals the length of the diagram, 3 inches, the reading will then be $\frac{4}{3}$ of what it was before or $\frac{4 \times 3.75}{3} = 5.00$ and by shifting the decimal point we have at once 50 pounds. Changing the length of the arm performed me-

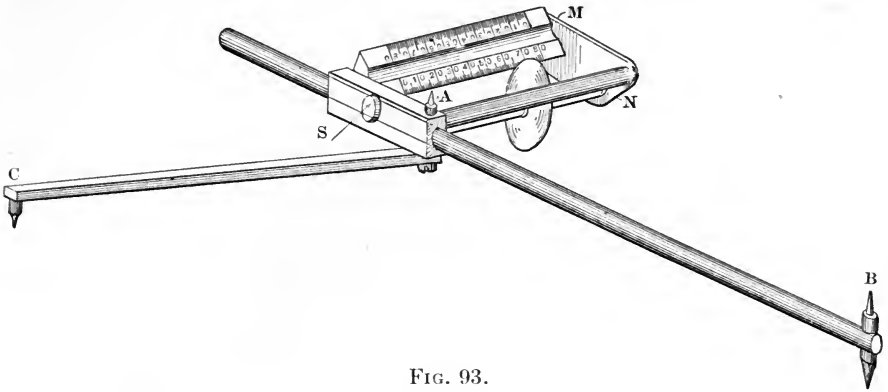

FIG. 93.

chanically the division before required. For a 40 scale, therefore, this instrument will give us at once on the wheel the mean effective pressure and for other scales the pressure can be taken proportionally; one-half for a 20 scale, three-fourths for a 30, five-fourths for a 50, etc. An Ams-

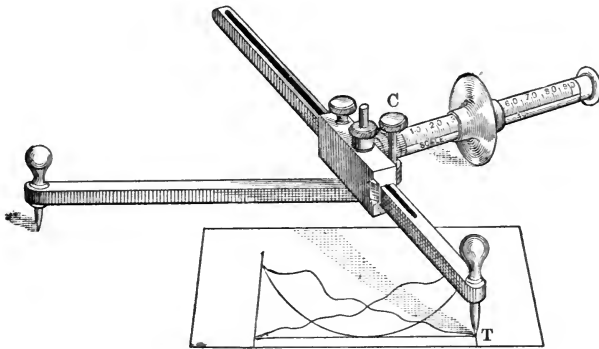

FIG. 94.

ler planimeter with an adjustable tracing arm is shown in Fig. 92. The length of the diagram is taken between the two points *M* and *N*, which are always the same distance apart as the tracing point *A* and the joint *C* upon which it hinges.

In another type of planimeter the reading is indicated by the sidewise movement of the wheel read against a contiguous scale as in

Fig. 93, or upon the shaft upon which it slides as in Fig. 94. As these scales are changeable and the arms adjustable, the mean effective pressure can be read direct for any scale or length of diagram. The instrument shown in Fig. 92 can be set to read directly in horse-power by making the length of the arm equal to

$$\frac{\text{Length of diagram} \times 40 \times 33000}{\text{Scale} \times \text{revs. per min.} \times \text{area} \times \text{stroke}}$$

in which the stroke should be taken in feet. Instruments like those shown in Figs. 93 and 94, in which a scale corresponding to that of the diagram can be used to measure the wheel movement, can be set to read directly in horse-power by making the length of the tracing arm equal to

$$\frac{\text{Length of diagram} \times 33000}{\text{Revs. per min.} \times \text{area} \times \text{stroke}}$$

If this gives an impracticable length of arm the required length can be multiplied or divided by a number which will make it practicable and

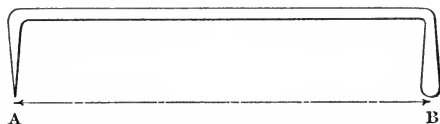

FIG. 95.

the reading multiplied or divided by the same number. If, for instance, the formula called for an arm of 1.5 inches it would be better to have the arm 3 inches and multiply the reading by 2.

A home-made planimeter with which it is possible to do quite accurate work may be made by bending a piece of wire as in Fig. 95, flattening and sharpening into a knife edge the end at *B* and pointing the end at *A*. The distance *AB* should be 10 inches.

Locate roughly, by judgment, the geometrical center of the figure, its center of gravity, so to speak; the point upon which it would balance if cut out of cardboard as in Fig. 96. In the indicator diagram, Fig. 97, this point would be at about *A*. Draw the line *AB*, connecting the center with any point upon the circumference, set the planimeter arm roughly at right angles with *AB*, and press the knife edge lightly into the paper to mark the point of starting as at *X*. Carry the tracing point out over *AB'* and around the diagram in the direction that a clock runs as indicated by the solid arrows and back over *AB*, making another depression as at *Z* to mark the position of the knife edge when the tracing point is again at the center *A*. Then being careful to move neither

the tracing point nor the knife edge, revolve the diagram 180°, using the tracing point as a center, bringing it into the dotted position of Fig. 97. Having secured the diagram in this position trace it again in the opposite direction from that followed by the hands of a watch as shown by the dotted arrows, and make still another depression to mark the position of the knife edge when the tracing point returns to the center. This will probably be somewhere near *X*, as at *Y*. We have now three marks: *X*, that at which the knife edge started; *Z*, that to which it departed; and *Y*, that to which it returned when the diagram was retraced.

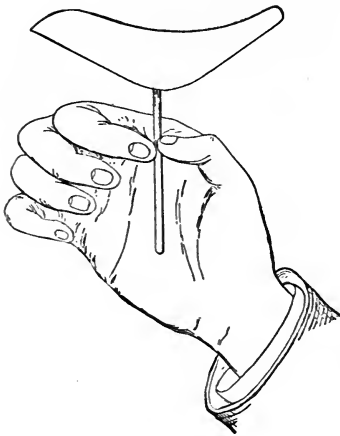

FIG. 96.

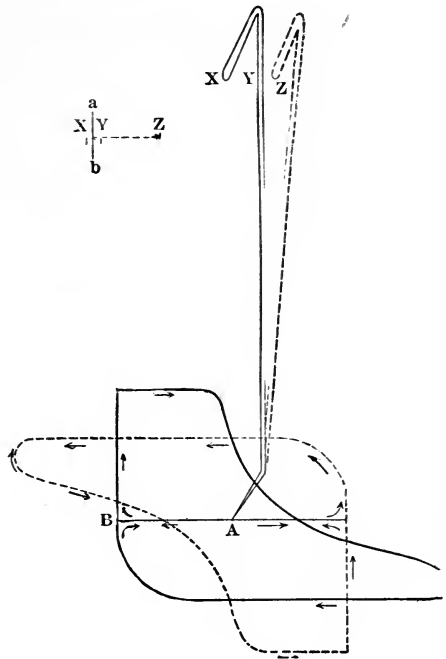

FIG. 97.

For plainness I have reproduced them at the left. Make a mark as "*ab*" half way between *XY*, then the distance between this mark and *Z*, i.e., the length of the dotted line, multiplied by the length of the planimeter arm *AB*, Fig. 95, will be the area in square inches approximately, and the approximation will be very close when the arm is of considerable length compared with the area to be measured. By making the planimeter arm 10 inches in length the multiplication may be done by shifting the decimal point, or as each inch of length will indicate 10 square inches the area may be measured directly by taking the distance *ZX* with a scale of 10 to the inch, each tenth representing 10 square

inches, or a scale of 100 to the inch, each unit of which would represent one-tenth of a square inch.

The function of the other arm of the planimeter, one end of which is stationary, is simply to guide the hinged end in a definite path. This end, otherwise hinged, may be guided by a straight groove as in Fig. 99.

In Fig. 98, start with the tracing point at *A* and the wheel at zero and trace the rectangle *ABCD*. The wheel motion gained in moving from *A* to *B* is neutralized by the movement from *C* to *D*. The line *BC* is in the neutral axis, so the wheel gets no movement while the tracer passes over it. When the point arrives at *D*, therefore, the wheel will have returned to zero, and the full area of the rectangle will be recorded while the tracing point passes down the line *DA*. For a rectangle, there-

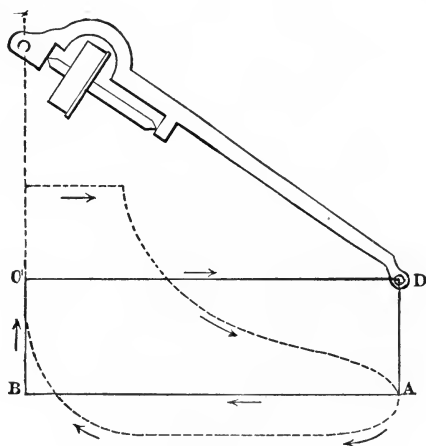

FIG. 98.

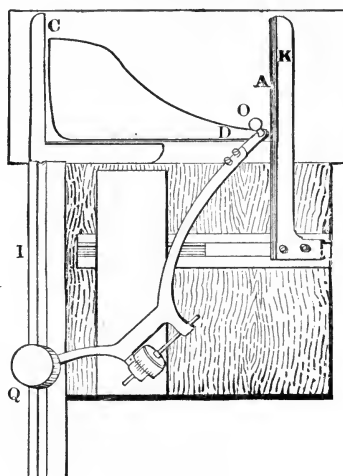

FIG. 99.

fore, with its left-hand edge in the neutral line of the instrument, all that is necessary to find the area is to start at the upper right-hand corner with the wheel at zero and carry the tracing point down the right-hand edge, as *DA* in Fig. 98. Conversely, if we have a given area recorded on the wheel, we can find the height of a rectangle of equal area for a given length by running the tracing point up the line marking its right-hand edge (the left being in the neutral line), until the wheel returns to zero. Suppose, for instance, we start at *A*, Fig. 98, with the planimeter wheel at zero and trace the outline of the indicator diagram. When the tracing point gets around to *A* again the area of the diagram will be recorded on the wheel. Now, suppose we run the tracing point up the line *AD* until the wheel comes back to zero, the line *AD* will be the average height of the indicator diagram, that is the height of a rectangle

of equal area, and by measuring the length of AD with the scale corresponding to the spring with which the diagram was taken, we find the mean effective pressure of the diagram at once without calculation.

This principle is made use of in the Coffin averaging instrument, a form of planimeter especially adapted to measuring the mean effective pressure represented by indicator diagrams and shown in Fig. 99. The indicator card is placed under the clips A and C , with the atmospheric line parallel with the horizontal leg of the stationary clip C , and the left-hand edge of the diagram against the inside vertical edge of that clip. The inside edge of the movable clip A is then placed against the right-hand extremity of the diagram, so that the length of the diagram is just included between the two clips. The tracing point of the planimeter is then placed upon any portion of the diagram which is against the right-hand clip, the wheel set to zero and the point gently pressed into the paper to mark the starting point. The tracing point is then carried around the diagram in the direction of the hands of a watch, and when it returns to the point from which it started the area of the diagram will be recorded upon the wheel. No attention need be paid to this reading. Simply carry the point upward against the edge of the clip A until the wheel returns to zero, at which point press the tracer again into the paper. The distance between the starting point and the point thus made will be the average height of the diagram and measured with the scale of the spring with which the diagram was taken will give at once the mean effective pressure. It is not necessary even to set the wheel at zero in starting. You can record the reading, whatever it may be, after the tracer has been set at the starting point, trace the diagram and then run the tracing point upward beside the clip until the wheel returns to the reading with which you started. The whole apparatus is mounted on a rosewood board with an inset tablet of suitable surface for the planimeter wheel to run upon. A weight Q is placed upon the end opposite the tracing point to hold it in the guiding groove.

CHAPTER XIII

COMPUTING THE HORSE POWER

FORCE is that which tends to produce motion or change of motion in matter. The pressure of steam or of water under a head, the pull of a weight, the pull or push of a muscle, are all familiar examples of force.

When force is exerted through space, *Work* is done. The full steam pressure may stand upon the engine piston for hours, but no work will be done unless the piston moves. A suspended weight does no work except while it is being lowered, and it is only in its ability to be lowered, i.e., in its elevated position, that its capacity for doing work exists.

The *Foot-Pound* is the unit of work or energy. It is the equivalent of 1 pound of force exerted through 1 foot of space. To lift 100 pounds 1 foot would require 100 foot-pounds of energy, as it would also to lift 1 pound 100 feet. If a horse has to pull 50 pounds to draw a wagon, and draws it 100 feet, he will develop 5000 foot-pounds. Notice that this has no reference to the weight of the wagon, simply to the force required to drag it.

A *Horse-Power* is the unit of the rate of development, or of consumption of energy or of work. It is 550 foot-pounds per second, 33,000 foot-pounds per minute, or 1,980,000 foot-pounds per hour.

The indicator gives us a means of determining the average force pushing the piston (the mean effective pressure per square inch multiplied by the number of square inches in the piston), and this multiplied by the number of feet through which the piston moves in a minute and divided by 33,000 will give the horse-power which the engine is developing.

The simplest formula for horse-power is, therefore,

$$\text{H.P.} = \frac{\text{Area} \times \text{M.E.P.} \times \text{piston speed}}{33000}$$

The area of the piston is found by multiplying the square of the diameter of the cylinder by 0.7854. Table I at the end of the volume renders this calculation unnecessary.

The mean effective pressure (M.E.P.) is found by measurement from the diagram, as explained in the previous chapter.

PISTON SPEED

The piston speed in this sense is the number of feet through which the pressure acts upon the piston per minute. In a double-acting engine, (that is, an engine which takes steam at each stroke, or twice a revolution) this is the revolutions per minute $\times 2 \times$ the length of the stroke in feet. If the engine is single-acting, but takes steam every revolution, the piston speed is the product of the revolutions per minute and the stroke in feet. Gas engines of the 4-cycle type make a working stroke once in two revolutions, and their piston speed when this is done is the stroke in feet times one-half the revolutions per minute; but when the governing is accomplished by the hit and miss method, their piston speed can be determined only by counting the explosions, the piston speed being the stroke in feet multiplied by the number of explosions per minute.

Notice that "piston speed" as used in this formula is not the actual speed of the piston, which is continually changing from nothing at the centers to the maximum near the middle of the stroke, nor the number of feet passed through by the piston per minute, but the number of feet *through which the pressure acts per minute*. Notice too that it is *per minute*. If it were per second the divisor would have to be 550 instead of 33,000; and if per hour the divisor would be 1,980,000.

The double-acting cylinder being the usual case, and the data usually given being the stroke in inches and the revolutions per minute, Table II, has been prepared for these conditions. In a single-acting steam engine, taking steam only once per revolution, or at every second stroke, the "piston speed" of the formula on page 96 would be the product of the stroke in inches and the revolutions per minute divided by 12, or one-half the value given by the table for a double-acting engine. For a gas engine this "piston speed" would be the stroke in inches multiplied by the number of explosions per minute and divided by 12.

USE OF THE TABLE

When the given number of revolutions can be found at the head of the column the piston speed will be found in the column under it opposite the stroke in inches.

EXAMPLE.—What is the piston speed of an engine having a stroke of 38 inches when running at 70 revolutions per minute?

Follow the horizontal line opposite 38 to the column under 70 and find 443.33 feet per minute, the value sought.

If the number of revolutions is even hundreds instead of tens, as given in the table, the values of the table should be multiplied by 10,

which may be done by adding a cipher when the tabular value is a whole number, or by moving the decimal point one point to the right, if it contains a fraction.

EXAMPLE.—What is the piston speed of an engine having a stroke of 8 inches when running at 300 revolutions per minute?

Opposite 8 and under 30 find 40, to which add a cipher, giving 400 feet per minute.

Or take the same engine running 400 revolutions. Opposite 8 under 40 find 53.33, which multiplied by 10 by moving the decimal point one place to the right, gives 533.3, the value sought.

If the number of revolutions given is a unit the tabular value must be divided by 10 by cutting off a cipher or pointing off one space if it is a whole number, or by moving the decimal point one place to the left if there is a fraction. Thus the piston speed of an engine with a stroke of 138 inches would be, when running at 9 revolutions, 207 feet, found by dropping the final cipher from the value given for 90 feet. The piston speed of an engine with a stroke of 136 inches at 8 revolutions would be 181.333 feet, found by moving the decimal one point to the left in the tabular value for 80 feet.

When the given number of revolutions contains more than one figure the values for the units, tens, hundreds, etc., must be found separately and added together.

EXAMPLE.—What is the piston speed of an engine having a stroke of 72 inches when running at 46 revolutions per minute?

First look up the value for 40, then the value for 6 as directed above. Their sum will be the value for 46; thus:

$$\begin{array}{r} \text{Value for 40} = 480 \\ \text{“} \quad 6 = 72 \\ \hline \text{“} \quad 46 = 552 \end{array}$$

EXAMPLE.—What is the piston speed of an engine having a stroke of 68 inches running at 54 revolutions per minute?

$$\begin{array}{r} \text{Value for 50} = 566.667 \\ \text{“} \quad 4 = 45.333 \\ \hline 612.000 \text{ ft. per min.} \end{array}$$

The only two fractions occurring in the table are $\frac{1}{3}$ and $\frac{2}{3} = 33333 +$ and $66666 +$. They can be carried out to any degree of accuracy desired by adding additional 3's and 6's, making the last 6 a 7. This was done in the above value for 50.

EXAMPLE.—What is the piston speed of an engine having a stroke of 62 inches when running at 126 revolutions per minute?

Value for 100	=	1033.33
“ 20	=	206.67
“ 6	=	62.00
<hr/>		
“ 126	=	1302.00 ft. per min.

If the number of revolutions has a fraction, simply reduce it to a decimal and continue as above, shifting the decimal point in the tabular value one point to the left for each place the decimal figure is to the right.

EXAMPLE.—What is the piston speed of an engine having a stroke of 72 inches at $63\frac{1}{4}$ revolutions per minute?

$$63\frac{1}{4} = 63.25.$$

Value for 60.	=	720.
“ 3.	=	36.
“ .2	=	2.4
“ .05	=	0.6
<hr/>		
63.25	=	759.0 ft. per min.

A simple and easily remembered formula for horse-power is:

$$\text{H.P.} = \frac{PANS}{33000}.$$

Where P = mean effective pressure,

A = area of piston in square inches,

N = number of working *strokes* per minute,

S = length of stroke in feet.

RULE.—Multiply together the mean effective pressure, the area of the piston in square inches, the number of working strokes per minute, and the length of the stroke in feet and divide by 33,000. The quotient will be the horse-power.

EXAMPLE.—What is the horse-power developed by a 24×48 inch engine running at 70 revolutions per minute with 42 pounds M.E.P.?

The pressure	$P = 42$	lbs.	given
“ area	$A = 452.39$	sq.in.	$24^2 \times .7854$
“ number	$N = 140$	stroke per min.	70×2
“ stroke	$S = 4$	feet	$48 \text{ ins.} \div 12$

$$\frac{PANS}{33000} = \frac{42 \times 452.39 \times 140 \times 4}{33000} = 322.43.$$

THE HORSE-POWER CONSTANT

In figuring a number of diagrams from one engine running at a constant speed it is most convenient to compute first the horse-power developed per pound of mean effective pressure, and multiply this "horse-power constant" by the mean effective pressure of each diagram to find the horse-power represented by that diagram. This can be done by considering the M.E.P. in formula 1 as unity, in which case, as it is a multiplier, it may be left out, and we get

$$\frac{\text{Area} \times \text{piston speed}}{33000} \quad \text{or} \quad \frac{ANS}{33000} = \text{H.P. per pound of M.E.P.,}$$

and this H.P. constant multiplied by M.E.P. = H.P.

TO FIND THE HORSE-POWER CONSTANT OR HORSE-POWER PER POUND OF MEAN EFFECTIVE PRESSURE,

RULE.—Multiply the piston area in square inches by the piston speed in feet per minute and divide by 33,000, or

Multiply together the piston area in square inches, the number of working strokes per minute, and the stroke in feet, and divide the product by 33,000.

EXAMPLE.—What is the horse-power constant of the above engine?

$$\frac{ANS}{33000} = \frac{452.39 \times 140 \times 4}{33000} = 7.6769.$$

This multiplied by the mean effective pressure will give the horse-power thus

$$7.6769 \times 42 = 322.4298$$

as before.

Table III gives these constants, i.e., the horse-power per pound of mean effective pressure, directly when the piston-speed is in even hundreds of a single figure. The values for thousands, tens, units, or fractional quantities can be found by changing the decimal point as explained in connection with the previous table.

EXAMPLE.—What horse-power is being developed by a $4\frac{3}{4} \times 8$ -inch engine running at 300 revolutions per minute with 40 pounds mean effective pressure?

From Table II we see that the piston speed is 400 feet per minute.

From Table III we see that an engine $4\frac{3}{4}$ inches in diameter will develop 0.2149 horse-power per pound of mean effective pressure at this piston-speed. Then,

$$\text{H.P.} = 40 \times 0.2149 = 8.596.$$

TABLE II

PISTON SPEED IN FEET PER MINUTE

$$(2 \times \text{stroke} \times \text{revolutions}) \div 12 = (\text{stroke} \times \text{revolutions}) \div 6.$$

Stroke in Inches.	REVOLUTIONS PER MINUTE.								
	10	20	30	40	50	60	70	80	90
1	1.67	3.33	5	6.67	8.33	10	11.67	13.33	15
2	3.33	6.67	10	13.33	16.67	20	23.33	26.67	30
3	5	10	15	20	25	30	35	40	45
4	6.67	13.33	20	26.67	33.33	40	46.67	53.33	60
5	8.33	16.67	25	33.33	41.67	50	58.33	66.67	75
6	10	20.00	30	40	50	60	70	80	90
7	11.67	23.33	35	46.67	58.33	70	81.67	93.33	105
8	13.33	26.67	40	53.33	66.67	80	93.33	106.67	120
9	15	30	45	60	75	90	105	120	135
10	16.67	33.33	50	66.67	83.33	100	116.67	133.33	150
11	18.33	36.67	55	73.33	91.67	110	128.33	146.67	165
12	20	40	60	80	100	120	140	160	180
13	21.67	43.33	65	86.67	108.33	130	151.67	173.33	195
14	23.33	46.67	70	93.33	116.67	140	163.33	186.67	210
15	25	50	75	100	125	150	175	200	225
16	26.67	53.33	80	106.67	133.33	160	186.67	213.33	240
17	28.33	56.67	85	113.33	141.67	170	198.33	226.67	255
18	30	60	90	120	150	180	210	240	270
19	31.67	63.33	95	126.67	158.33	190	221.67	253.33	285
20	33.33	66.67	100	133.33	166.67	200	233.33	266.67	300
22	36.67	73.33	110	146.67	183.33	220	256.67	293.33	330
24	40	80	120	160	200	240	280	320	360
26	43.33	86.67	130	173.33	216.67	260	303.33	346.67	390
28	46.67	93.33	140	186.67	233.33	280	326.67	373.33	420
30	50	100	150	200	250	300	350	400	450
32	53.33	106.67	160	213.33	266.67	320	373.33	426.67	480
34	56.67	113.33	170	226.67	283.33	340	396.67	453.33	510
36	60	120	180	240	300	360	420	480	540
38	63.33	126.67	190	253.33	316.67	380	443.33	506.67	570
40	66.67	133.33	200	266.67	333.33	400	466.67	533.33	600
42	70	140	210	280	350	420	490	560	630
44	73.33	146.67	220	293.33	366.67	440	513.33	586.67	660
46	76.67	153.33	230	306.67	383.33	460	536.67	613.33	690
48	80	160	240	320	400	480	560	640	720
50	83.33	166.67	250	333.33	416.67	500	583.33	666.67	750
52	86.67	173.33	260	346.67	433.33	520	606.67	693.33	780
54	90	180	270	360	450	540	630	720	810
56	93.33	186.67	280	373.33	466.67	560	653.33	746.67	840
58	96.67	193.33	290	386.67	483.33	580	676.67	773.33	870
60	100	200	300	400	500	600	700	800.00	900

TABLE II—Continued

PISTON SPEED IN FEET PER MINUTE

 $(2 \times \text{stroke} \times \text{revolutions}) \div 12 = (\text{stroke} \times \text{revolutions}) \div 6$.

Stroke in Inches.	REVOLUTIONS PER MINUTE.								
	10	20	30	40	50	60	70	80	90
62	103.33	206.67	310	413.33	516.67	620	723.33	826.67	930
64	106.67	213.33	320	426.67	533.33	640	746.67	853.33	960
66	110	220	330	440	550	660	770	880	990
68	113.33	226.67	340	453.33	566.67	680	793.33	906.67	1020
70	116.67	233.33	350	466.67	583.37	700	816.67	933.33	1050
72	120	240	360	480	600	720	840	960	1080
74	123.33	246.67	370	493.33	616.67	740	863.33	986.67	1110
76	126.67	253.33	380	506.67	633.33	760	886.67	1013.33	1140
78	130	260	390	520	650	780	910	1040	1170
80	133.33	266.67	400	533.33	666.67	800	933.33	1066.67	1200
82	136.67	273.33	410	546.67	683.33	820	956.67	1093.33	1230
84	140	280	420	560	700	840	980	1120	1260
86	143.33	286.67	430	573.33	716.67	860	1003.33	1146.67	1290
88	146.67	293.33	440	586.67	733.33	880	1026.67	1173.33	1320
90	150	300	450	600	750	900	1050	1200	1350
92	153.33	306.67	460	613.33	766.67	920	1073.33	1226.67	1380
94	156.67	313.33	470	626.67	783.33	940	1096.67	1253.33	1410
96	160	320	480	640	800	960	1120	1280	1440
98	163.33	326.67	490	653.33	816.67	980	1143.33	1306.67	1470
100	166.67	333.33	500	666.67	833.33	1000	1166.67	1333.33	1500
102	170	340	510	680	850	1020	1190	1360	1530
104	173.33	346.67	520	693.33	866.67	1040	1213.33	1386.67	1560
106	176.67	353.33	530	706.67	883.33	1060	1236.67	1413.33	1590
108	180	360	540	720	900	1080	1260	1440	1620
110	183.33	366.67	550	733.33	916.67	1100	1283.33	1466.67	1650
112	186.67	373.33	560	746.67	933.33	1120	1306.67	1493.33	1680
114	190	380	570	760	950	1140	1330	1520	1710
116	193.33	386.67	580	773.33	966.67	1160	1353.33	1546.67	1740
118	196.67	393.33	590	786.67	983.33	1180	1376.67	1573.33	1770
120	200	400	600	800	1000	1200	1400	1600	1800
122	203.33	406.67	610	813.33	1016.67	1220	1423.33	1626.67	1830
124	206.67	413.33	620	826.67	1033.33	1240	1446.67	1653.33	1860
126	210	420	630	840	1050	1260	1470	1680	1890
128	213.33	426.67	640	853.33	1066.67	1280	1493.33	1706.67	1920
130	216.67	433.33	650	866.67	1083.33	1300	1516.67	1733.33	1950
132	220	440	660	880	1100	1320	1540	1760	1980
134	223.33	446.67	670	893.33	1116.67	1340	1563.33	1786.67	2010
136	226.67	453.33	680	906.67	1133.33	1360	1586.67	1813.33	2040
138	230	460	690	920	1150	1380	1610	1840	2070
140	233.33	466.67	700	933.33	1166.67	1400	1633.33	1866.67	2100

What horse-power would be developed by an engine 24 inches in diameter running at 523 feet of piston-speed per minute at 34 pounds M.E.P.?

Use Table III for the tens and units, just as before. In the line opposite 24 find the

value of 500	=	6.8544
“ 20	=	0.27417
“ 3	=	0.041126

“ 523	=	7.169696

horse-power per pound of mean effective pressure. Then

$$\text{H.P.} = 7.1697 \times 34 = 243.77.$$

When the piston-speed contains a fraction, its value can be found by shifting the decimal point, as in the previous table, to the left.

EXAMPLE.—What horse-power would be developed by a 30-inch engine running at 617.23 feet of piston-speed with a mean effective pressure of 47.5 pounds?

Opposite 30 find the

value of 600	=	12.852
“ of 10	=	.2142
“ of 7	=	.14994
“ of .2	=	.004284
“ of .03	=	.0006426

“ 617.23	=	13.2210666

horse-power per pound of mean effective pressure. Then

$$\text{H.P.} = 47.5 \times 13.22 = 627.95.$$

In the above examples the mean effective pressure given is assumed to be the average of both ends, and the horse-power as calculated is that of the whole engine. If it is desired to know the horse-power of each end, they must be calculated separately, each with its own mean effective pressure, and the constant taken at *one-half the piston speed*, or with the constant taken at the full piston-speed and one-half the mean effective pressure.

EXAMPLE.—An engine 48×84 inches, running at 36.5 revolutions per minute, has a mean effective pressure in the head end of 42.7 pounds, and in the crank end of 41.3 pounds, what is the horse-power of each end, and of the whole engine?

The "horse-power constant," or the horse-power per pound of mean effective pressure for each end, will be one-half that given by the table for both ends, or that given by the table for an engine of the given diameter at one-half the piston-speed. From the piston-speed table we find that the piston-speed at 36.5 revolutions of the double-acting engine is 511 feet per minute. The piston speed of each would be one-half of this, or

$$511 \div 2 = 255.5 \text{ ft. per min.}$$

From the Table III we find that the horse-power per pound of mean effective pressure for a 48-inch engine at this speed is

value for 200	= 10.9673
“ 50	= 2.74182
“ 5	= .274182
“ 0.5	= .0274182

“ 255.5	= 14.0107202
H.P. Head end	= $14.01 \times 42.7 = 598.227$
H.P. Crank end	= $14.01 \times 41.3 = 578.613$

H.P. Both ends =	1176.84

ALLOWING FOR THE ROD

When a portion of the area of the piston is cut off by a rod, as is usually the case in the crank end, and as occurs in the head end of a cylinder tandem to one behind it, or with a tail rod, it is essential to accuracy that an allowance be made for such loss of area. In the usual case, that of a cylinder having a rod only in the crank end, the allowance may be made by subtracting from the horse-power computed as in the first example, the horse-power which would be developed by a *single-acting* engine having a diameter equal to that of the piston rod, and with the mean effective pressure acting in the *crank* end.

EXAMPLE.—What horse-power would be developed by a 24-inch engine with a $4\frac{3}{8}$ piston-rod running at 620 feet piston speed with 46.5 pounds mean effective pressure in the head end and 47.2 in the crank end?

From the table the constant for this engine would be

value for 600	= 8.2253
“ 20	= .27417

“ 620	= 8.49947 horse-power

per pound of average mean effective pressure.

The average mean effective pressure would be

$$\frac{46.5 + 47.2}{2} = 46.85 \text{ pounds.}$$

The horse-power uncorrected for the rod would therefore be

$$8.49947 \times 46.85 = 398.2001695 \text{ H.P.}$$

The horse-power lost by the presence of the rod is that which would be developed by an engine $4\frac{3}{8}$ inches diameter at 310 feet of piston speed and at 47.2 pounds mean effective pressure.

From the table we find the constant for such an engine to be

for 300 feet	0.1367
“ 10 “	0.00456
“ 310 “	0.14126

horse-power per pound of mean effective pressure.

The mean effective pressure which would have acted upon this area is 47.2 pounds.

The horse-power to be deducted, therefore, is

$$0.14126 \times 47.2 = 6.667472 \text{ H.P.}$$

Deducting this from the uncorrected horse-power we have

$$\begin{array}{r} 398.2001695 \\ 6.667472 \\ \hline 391.5326975 \end{array}$$

as the horse-power corrected for the rod.

A more convenient way when a large number of diagrams are to be figured up from the same engine, as in making out daily reports or computing the results of a long test, is to correct the constant for the engine by subtracting from it the constant of the rod at half the piston speed and multiplying this corrected constant by the average mean effective pressure. Performing the above example in this way,

$$\begin{array}{r} \text{constant for cylinder } 8.49947 \\ \text{“ “ rod } .14126 \\ \hline \text{corrected constant } 8.35821 \end{array}$$

which multiplied by the average M.E.P. gives

$$\begin{aligned} 835821 \times 46.85 &= 391.5821385 \text{ H.P.} \\ \text{by other method} & 391.5326975 \text{ H.P.} \end{aligned}$$

$$\begin{array}{r} \text{difference} \qquad \qquad \qquad .049441 \end{array}$$

If the mean effective pressure were the same in both ends this method would be perfectly accurate. The inaccuracy which it involves, and which is the cause of the above difference, is due to multiplying the rod constant by the average M.E.P., instead of that in the crank end.

$$\begin{array}{r} \text{M.E.P. in crank end} \quad 47.2 \\ \text{average M.E.P.} \quad 46.85 \\ \text{difference} \quad 0.35 \end{array}$$

$$0.14125 \times 0.35 = 0.049441$$

The error thus is seen to be the product of the rod constant and the difference between the average and the actual M.E.P. in the crank end, neither of which factors are large enough in the ordinary case to make the error of any considerable magnitude.

THROUGH RODS AND TAIL RODS

When the rod is in both ends of the cylinder, as in the cylinder nearest the guides in a tandem compound, or in a cylinder with a tail rod, and the rod is the same diameter in both ends, it is necessary only to subtract the constant for an engine of a diameter equal to that of the rod at the *full piston speed* from the constant for the diameter of the cylinder and multiply by the *average* mean effective pressure.

When there is a rod in each end, but of different size, each rod should be allowed for separately by multiplying its constant at *half piston speed* by the mean effective pressure acting in its own end of the cylinder, and subtracting the products successively from the horse-power found by multiplying the cylinder constant at full speed by the average mean effective pressure.

In strictness, in order to find the power which is being developed by one end of the cylinder, a diagram made of the line showing the forward pressure in the end which is being computed, and the back pressure- or counter-pressure line of the diagram from the other end should be used. The counter-pressure line diagram from the head end does not show the back pressure against the piston when the head end was doing work, but while the piston is being forced backward by the steam

TABLE III

HORSE-POWER PER POUND OF MEAN EFFECTIVE PRESSURE
(Area × piston speed) ÷ 33,000.

Diameter of Cylinder or Rod. Inches.	PISTON SPEED IN FEET PER MINUTE.								
	100	200	300	400	500	600	700	800	900
$\frac{3}{4}$.00134	.0027	.0040	.0054	.0067	.0080	.0094	.0107	.0120
$\frac{7}{16}$.00157	.0031	.0047	.0063	.0079	.0094	.0110	.0126	.0141
$\frac{1}{2}$.00182	.0036	.0055	.0073	.0091	.0109	.0128	.0146	.0164
$\frac{11}{16}$.00209	.0042	.0063	.0084	.0105	.0126	.0146	.0167	.0188
1	.00238	.0048	.0071	.0095	.0119	.0143	.0167	.0190	.0214
$1\frac{1}{16}$.00269	.0054	.0081	.0107	.0134	.0161	.0188	.0215	.0242
$1\frac{1}{8}$.00288	.0058	.0086	.0115	.0144	.0173	.0202	.0230	.0259
$1\frac{3}{8}$.00301	.0060	.0090	.0120	.0151	.0181	.0211	.0241	.0271
$1\frac{1}{2}$.00336	.0067	.0101	.0134	.0168	.0201	.0235	.0268	.0302
$1\frac{5}{8}$.00343	.0069	.0103	.0137	.0172	.0206	.0240	.0274	.0309
$1\frac{3}{4}$.00372	.0074	.0112	.0149	.0186	.0223	.0260	.0298	.0335
$1\frac{7}{8}$.00402	.0080	.0121	.0161	.0201	.0241	.0281	.0322	.0362
$1\frac{9}{8}$.00410	.0082	.0123	.0164	.0205	.0246	.0287	.0328	.0369
$1\frac{5}{4}$.00450	.0090	.0135	.0180	.0225	.0270	.0315	.0360	.0405
$1\frac{11}{8}$.00466	.0093	.0140	.0186	.0233	.0280	.0326	.0373	.0419
$1\frac{1}{2}$.00492	.0098	.0148	.0197	.0246	.0295	.0344	.0393	.0443
$1\frac{3}{4}$.00535	.0107	.0161	.0214	.0268	.0321	.0375	.0428	.0482
$1\frac{5}{4}$.00581	.0116	.0174	.0232	.0291	.0349	.0407	.0465	.0523
$1\frac{7}{8}$.00609	.0122	.0183	.0244	.0305	.0365	.0426	.0487	.0548
$1\frac{9}{8}$.00628	.0126	.0189	.0251	.0314	.0377	.0440	.0503	.0566
$1\frac{11}{8}$.00678	.0136	.0203	.0271	.0339	.0407	.0474	.0542	.0610
$1\frac{5}{4}$.00688	.0138	.0206	.0275	.0344	.0413	.0482	.0550	.0619
$1\frac{3}{2}$.00729	.0146	.0219	.0292	.0364	.0437	.0510	.0583	.0656
$1\frac{7}{4}$.00771	.0154	.0231	.0308	.0386	.0463	.0540	.0617	.0694
$1\frac{9}{4}$.00782	.0156	.0235	.0313	.0391	.0469	.0548	.0626	.0704
$1\frac{11}{4}$.00837	.0167	.0251	.0335	.0418	.0502	.0586	.0669	.0753
$1\frac{5}{2}$.00859	.0172	.0258	.0344	.0430	.0515	.0601	.0687	.0773
$1\frac{11}{2}$.00893	.0179	.0268	.0357	.0447	.0536	.0625	.0715	.0804
2	.00952	.0190	.0286	.0381	.0476	.0571	.0666	.0762	.0857
$2\frac{1}{16}$.01012	.0202	.0304	.0405	.0506	.0607	.0709	.0810	.0911
$2\frac{1}{8}$.01050	.0210	.0315	.0420	.0525	.0630	.0735	.0840	.0945
$2\frac{1}{4}$.01074	.0215	.0322	.0430	.0537	.0645	.0752	.0860	.0967
$2\frac{3}{8}$.01139	.0228	.0342	.0456	.0569	.0683	.0797	.0911	.1025
$2\frac{1}{2}$.01152	.0230	.0346	.0461	.0576	.0691	.0806	.0921	.1036
$2\frac{5}{8}$.01205	.0241	.0361	.0482	.0602	.0723	.0843	.0964	.1084
$2\frac{3}{4}$.01259	.0252	.0378	.0504	.0630	.0755	.0881	.1007	.1133
$2\frac{7}{8}$.01273	.0255	.0382	.0509	.0636	.0764	.0891	.1018	.1145
$2\frac{9}{8}$.01342	.0268	.0403	.0537	.0671	.0805	.0940	.1074	.1208
$2\frac{11}{8}$.01371	.0274	.0411	.0548	.0686	.0823	.0960	.1097	.1234
$2\frac{5}{4}$.01414	.0283	.0424	.0566	.0707	.0848	.0990	.1131	.1273
$2\frac{3}{2}$.01487	.0297	.0446	.0595	.0744	.0892	.1041	.1190	.1339
$2\frac{7}{4}$.01563	.0313	.0469	.0625	.0781	.0938	.1094	.1250	.1407
$2\frac{9}{4}$.01609	.0322	.0483	.0644	.0805	.0965	.1126	.1287	.1448
$2\frac{11}{4}$.01640	.0328	.0492	.0656	.0820	.0984	.1148	.1312	.1476
$2\frac{13}{4}$.01719	.0344	.0516	.0688	.0860	.1031	.1203	.1375	.1547
$2\frac{3}{2}$.01735	.0347	.0521	.0694	.0868	.1041	.1215	.1388	.1562
$2\frac{5}{2}$.01800	.0360	.0540	.0720	.0900	.1080	.1260	.1440	.1620
$2\frac{7}{2}$.01866	.0373	.0560	.0746	.0933	.1120	.1306	.1493	.1679
$2\frac{9}{2}$.01883	.0377	.0565	.0753	.0941	.1130	.1318	.1506	.1694
$2\frac{11}{2}$.01967	.0394	.0590	.0787	.0984	.1180	.1377	.1574	.1770
$2\frac{13}{2}$.02002	.0400	.0601	.0801	.1001	.1201	.1401	.1602	.1802
$2\frac{15}{2}$.02054	.0411	.0616	.0821	.1027	.1232	.1438	.1643	.1848

TABLE III—Continued

HORSE-POWER PER POUND OF MEAN EFFECTIVE PRESSURE
(Area × piston speed) ÷ 33,000.

Diameter of Cylinder or Rod, Inches.	PISTON SPEED IN FEET PER MINUTE.								
	100	200	300	400	500	600	700	800	900
3	.02142	.0428	.0643	.0857	.1071	.1285	.1499	.1714	.1928
3 $\frac{1}{10}$.02287	.0457	.0686	.0915	.1144	.1372	.1601	.1830	.2058
3 $\frac{1}{8}$.02324	.0465	.0697	.0930	.1162	.1395	.1627	.1859	.2092
3 $\frac{1}{5}$.02437	.0487	.0731	.0975	.1219	.1462	.1706	.1950	.2193
3 $\frac{3}{10}$.02514	.0503	.0754	.1006	.1257	.1508	.1760	.2011	.2262
3 $\frac{3}{8}$.02592	.0518	.0778	.1037	.1296	.1555	.1814	.2074	.2333
3 $\frac{2}{5}$.02711	.0542	.0813	.1084	.1355	.1627	.1898	.2169	.2440
3 $\frac{1}{4}$.02751	.0550	.0825	.1100	.1376	.1651	.1926	.2201	.2476
3 $\frac{1}{2}$.02915	.0583	.0875	.1166	.1458	.1749	.2041	.2332	.2624
3 $\frac{3}{8}$.03085	.0617	.0926	.1234	.1543	.1851	.2160	.2468	.2777
3 $\frac{5}{8}$.03128	.0626	.0938	.1251	.1564	.1877	.2189	.2502	.2815
3 $\frac{7}{10}$.03258	.0652	.0977	.1303	.1629	.1950	.2281	.2606	.2932
3 $\frac{3}{4}$.03347	.0669	.1004	.1339	.1673	.2008	.2343	.2678	.3012
3 $\frac{7}{8}$.03437	.0687	.1031	.1375	.1719	.2062	.2406	.2750	.3093
3 $\frac{4}{5}$.03574	.0715	.1072	.1429	.1787	.2144	.2502	.2859	.3216
3 $\frac{9}{10}$.03620	.0724	.1086	.1448	.1810	.2172	.2534	.2896	.3258
4	.03808	.0762	.1142	.1523	.1904	.2285	.2666	.3046	.3427
4 $\frac{1}{10}$.04001	.0800	.1200	.1600	.2001	.2401	.2801	.3201	.3601
4 $\frac{1}{8}$.04050	.0810	.1215	.1620	.2025	.2430	.2835	.3240	.3645
4 $\frac{1}{5}$.04198	.0840	.1259	.1679	.2099	.2519	.2939	.3358	.3778
4 $\frac{1}{4}$.04300	.0860	.1290	.1720	.2149	.2579	.3009	.3439	.3869
4 $\frac{3}{10}$.04401	.0880	.1320	.1760	.2201	.2641	.3081	.3521	.3961
4 $\frac{1}{2}$.04555	.0911	.1367	.1822	.2278	.2733	.3189	.3644	.4100
4 $\frac{3}{8}$.04608	.0922	.1382	.1843	.2304	.2765	.3226	.3686	.4147
4 $\frac{5}{8}$.04819	.0964	.1446	.1928	.2410	.2892	.3374	.3856	.4337
4 $\frac{3}{5}$.05036	.1007	.1511	.2014	.2518	.3022	.3525	.4029	.4532
4 $\frac{7}{10}$.05091	.1018	.1527	.2036	.2545	.3055	.3564	.4073	.4582
4 $\frac{4}{5}$.05257	.1051	.1577	.2103	.2629	.3154	.3680	.4206	.4731
4 $\frac{9}{10}$.05370	.1074	.1612	.2149	.2686	.3223	.3760	.4298	.4835
4 $\frac{1}{2}$.05484	.1097	.1645	.2194	.2742	.3290	.3839	.4387	.4936
4 $\frac{7}{8}$.05656	.1131	.1697	.2262	.2828	.3394	.3950	.4525	.5090
4 $\frac{9}{8}$.05714	.1143	.1714	.2286	.2857	.3428	.4000	.4571	.5143
5	.05950	.1190	.1785	.2380	.2975	.3570	.4165	.4760	.5355
5 $\frac{1}{10}$.06251	.1250	.1875	.2500	.3126	.3751	.4376	.5001	.5626
5 $\frac{1}{8}$.06560	.1312	.1968	.2624	.3280	.3936	.4592	.5248	.5904
5 $\frac{3}{8}$.06876	.1375	.2063	.2750	.3438	.4126	.4813	.5501	.6188
5 $\frac{1}{2}$.07200	.1440	.2160	.2880	.3600	.4320	.5040	.5760	.6479
5 $\frac{3}{5}$.07530	.1506	.2259	.3012	.3765	.4518	.5271	.6024	.6777
5 $\frac{4}{5}$.07869	.1574	.2361	.3148	.3934	.4721	.5508	.6295	.7082
5 $\frac{9}{10}$.08215	.1643	.2465	.3286	.4108	.4929	.5751	.6572	.7394
6	.08569	.1714	.2570	.3427	.4284	.5141	.5998	.6854	.7711
6 $\frac{1}{4}$.09297	.1859	.2789	.3719	.4648	.5578	.6508	.7438	.8367
6 $\frac{3}{8}$.10055	.2011	.3017	.4022	.5028	.6033	.7039	.8044	.9050
6 $\frac{1}{2}$.10844	.2169	.3253	.4338	.5422	.6506	.7591	.8675	.9760
7	.11662	.2332	.3499	.4665	.5831	.6997	.8163	.9330	1.0496
7 $\frac{1}{10}$.12510	.2502	.3753	.5004	.6255	.7506	.8757	1.0008	1.1259
7 $\frac{1}{8}$.13388	.2678	.4016	.5355	.6694	.8033	.9371	1.0710	1.2049
7 $\frac{3}{8}$.14295	.2859	.4288	.5718	.7147	.8577	1.0006	1.1436	1.2865
8	.15232	.3046	.4570	.6093	.7616	.9139	1.0662	1.2185	1.3709
8 $\frac{1}{4}$.16199	.3240	.4860	.6480	.8099	.9719	1.1339	1.2959	1.4579
8 $\frac{3}{4}$.17195	.3439	.5159	.6878	.8598	1.0317	1.2037	1.3756	1.5476
8 $\frac{3}{4}$.18222	.3644	.5467	.7289	.9111	1.0933	1.2755	1.4577	1.6400

TABLE III—Continued

HORSE-POWER PER POUND OF MEAN EFFECTIVE PRESSURE
(Area \times piston speed) \div 33,000.

Diameter of Cylinder, or Rod, Inches.	PISTON SPEED IN FEET PER MINUTE.								
	100	200	300	400	500	600	700	800	900
9	.19278	.3856	.5783	.7711	.9639	1.1567	1.3495	1.5422	1.7350
9½	.20364	.4073	.6109	.8146	1.0182	1.2218	1.4255	1.6201	1.8328
9¾	.21479	.4296	.6444	.8592	1.0740	1.2888	1.5036	1.7184	1.9331
10	.22625	.4525	.6788	.9050	1.1313	1.3575	1.5837	1.8100	2.0362
10½	.23800	.4760	.7140	.9520	1.1900	1.4280	1.6660	1.9040	2.1420
10¾	.25005	.5001	.7502	1.0002	1.2503	1.5003	1.7504	2.0004	2.2505
11	.26239	.5248	.7872	1.0496	1.3120	1.5744	1.8368	2.0992	2.3615
11½	.27504	.5501	.8251	1.1002	1.3752	1.6502	1.9253	2.2003	2.4754
11¾	.28798	.5759	.8639	1.1519	1.4399	1.7279	2.0159	2.3038	2.5918
12	.30122	.6024	.9037	1.2049	1.5061	1.8073	2.1085	2.4098	2.7110
12½	.31476	.6295	.9443	1.2590	1.5738	1.8855	2.2033	2.5181	2.8328
12¾	.32858	.6572	.9857	1.3143	1.6429	1.9715	2.3001	2.6286	2.9572
13	.34273	.6855	1.0282	1.3709	1.7136	2.0564	2.3991	2.7418	3.0845
13½	.37188	.7438	1.1156	1.4875	1.8594	2.2313	2.6032	2.9750	3.3469
13¾	.40221	.8044	1.2066	1.6088	2.0111	2.4133	2.8155	3.2177	3.6199
14	.43376	.8675	1.3013	1.7350	2.1688	2.6026	3.0363	3.4701	3.9038
14½	.46648	.9330	1.3995	1.8659	2.3324	2.7989	3.2654	3.7319	4.1984
14¾	.50039	1.0008	1.5012	2.0016	2.5020	3.0023	3.5027	4.0031	4.5035
15	.53548	1.0710	1.6065	2.1419	2.6774	3.2129	3.7484	4.2839	4.8194
15½	.60927	1.2185	1.8278	2.4371	3.0464	3.6556	4.2649	4.8742	5.4835
16	.68782	1.3756	2.0635	2.7513	3.4391	4.1269	4.8147	5.5025	6.1904
17	.77112	1.5422	2.3134	3.0845	3.8556	4.6267	5.3978	6.1690	6.9401
18	.85918	1.7184	2.5775	3.4367	4.2959	5.1551	6.0143	6.8735	7.7326
19	.95200	1.9040	2.8560	3.8080	4.7600	5.7120	6.6640	7.6160	8.5680
20	1.04957	2.0991	3.1487	4.1983	5.2479	6.2975	7.3470	8.3966	9.4462
21	1.15191	2.3038	3.4557	4.6076	5.7595	6.9115	8.0634	9.2153	10.3672
22	1.25903	2.5181	3.7771	5.0361	6.2952	7.5542	8.8132	10.0722	11.3313
23	1.37087	2.7417	4.1126	5.4835	6.8544	8.2253	9.5962	10.9670	12.3379
24	1.48748	2.9750	4.4625	5.9499	7.4374	8.9249	10.4124	11.8999	13.3874
25	1.60887	3.2177	4.8266	6.4355	8.0444	9.6533	11.2622	12.8710	14.4799
26	1.73503	3.4701	5.2051	6.9401	8.6752	10.4102	12.1452	13.8802	15.6153
27	1.86591	3.7318	5.5977	7.4636	9.3295	11.1955	13.0614	14.9273	16.7932
28	2.00157	4.0031	6.0047	8.0063	10.0079	12.0095	14.0110	16.0126	18.0142
29	2.15988	4.3198	6.4796	8.6395	10.7994	12.9593	15.1192	17.2790	19.4389
30	2.28718	4.5744	6.8615	9.1487	11.4359	13.7231	16.0103	18.2975	20.5846
31	2.43712	4.8742	7.3114	9.7485	12.1856	14.6227	17.0598	19.4970	21.9341
32	2.59182	5.1836	7.7755	10.3673	12.9591	15.5509	18.1427	20.7345	23.3264
33	2.75127	5.5025	8.2538	11.0051	13.7564	16.5076	19.2589	22.0102	24.7615
34	2.91548	5.8310	8.7465	11.6619	14.5774	17.4929	20.4084	23.3239	26.2394
35	3.08455	6.1691	9.2535	12.3379	15.4224	18.5069	21.5914	24.6759	27.7604
36	3.25818	6.5164	9.7746	13.0328	16.2911	19.5493	22.8075	26.0657	29.3239
37	3.43667	6.8733	10.3101	13.7468	17.1835	20.6202	24.0569	27.4936	30.9303
38	3.62000	7.2400	10.8600	14.4800	18.1000	21.7200	25.3400	28.9600	32.5800
39	3.80788	7.6158	11.4236	15.2315	19.0394	22.8473	26.6552	30.4630	34.2709
40	4.00091	8.0018	12.0027	16.0036	20.0046	24.0055	28.0064	32.0073	36.0082
41	4.19818	8.3964	12.5945	16.7927	20.9909	25.1991	29.3873	33.5854	37.7836
42	4.40061	8.8012	13.2018	17.6024	22.0030	26.4036	30.8042	35.2048	39.6055
43	4.60758	9.2152	13.8227	18.4303	23.0379	27.6455	32.2531	36.8606	41.4682
44	4.81939	9.6388	14.4582	19.2776	24.0970	28.9163	33.7357	38.5551	43.3745
45	5.03606	10.0721	15.1082	20.1442	25.1803	30.2164	35.2524	40.2885	45.3245
46	5.25727	10.5145	15.7718	21.0291	26.2863	31.5436	36.8008	42.0582	47.3154
47	5.48364	10.9673	16.4509	21.9346	27.4182	32.9018	38.3815	43.8691	49.3528

TABLE III—Continued

HORSE-POWER PER POUND OF MEAN EFFECTIVE PRESSURE
(Area \times piston speed \div 33,000.)

Diam. Cyl. or Rod, Ins.	PISTON SPEED IN FEET PER MINUTE.								
	100	200	300	400	500	600	700	800	900
49	5.71424	11.4285	17.1427	22.8570	28.5712	34.2854	39.9997	45.7139	51.4282
50	5.95000	11.9000	17.8500	23.8000	29.7500	35.7000	41.6500	47.6000	53.5500
51	6.19030	12.3806	18.5709	24.7612	30.9515	37.1418	43.3321	49.5224	55.7127
52	6.43545	12.8709	19.3604	25.7418	32.1773	38.6127	45.0482	51.4836	57.9191
53	6.68535	13.3707	20.0561	26.7414	33.4268	40.1121	46.7975	53.4828	60.1682
54	6.94000	13.8800	20.8200	27.7600	34.7000	41.6400	48.5800	55.5200	62.4600
55	7.19939	14.3988	21.5982	28.7976	35.9970	43.1963	50.3957	57.5951	64.7945
56	7.46364	14.9273	22.3910	29.8547	37.3183	44.7820	52.2457	59.7093	67.1730
57	7.73273	15.4655	23.1982	30.9309	38.6637	46.3964	54.1291	61.8618	69.5946
58	8.00636	16.0127	24.0191	32.0254	40.0318	48.0382	56.0445	64.0509	72.0572
59	8.28485	16.5697	24.8546	33.1394	41.4243	49.7091	57.9940	66.2788	74.5637
60	8.56788	17.1358	25.7036	34.2715	42.8394	51.4073	59.9752	68.5430	77.1199
61	8.85606	17.7121	26.5682	35.4243	44.2803	53.1364	61.9924	70.8485	79.7045
62	9.14879	18.2976	27.4464	36.5952	45.7440	54.8927	64.0415	73.1903	82.3391
63	9.48364	18.9673	28.4509	37.9346	47.4182	56.9018	66.3555	75.8691	85.3528
64	9.74848	19.4970	29.2454	38.9939	48.7424	58.4909	68.2394	77.9878	87.7363
65	10.05545	20.1109	30.1664	40.2218	50.2773	60.3327	70.3882	80.4436	90.4991
66	10.36727	20.7345	31.1017	41.4690	51.8362	62.2035	72.5707	82.9379	93.3052
67	10.68394	21.3679	32.0518	42.7358	53.4197	64.1036	74.7876	85.4715	96.1545
68	11.00515	22.0103	33.0155	44.0206	55.0258	66.0309	77.0361	88.0412	99.0464
69	11.33121	22.6624	33.9936	45.3248	56.6561	67.9873	79.3185	90.6497	101.9809
70	11.66212	23.3242	34.9864	46.6485	58.3106	69.9727	81.6348	93.2970	104.9591
71	11.99758	23.9952	35.9927	47.9903	59.9879	71.9855	83.9831	95.9806	107.9782
72	12.33788	24.6758	37.0136	49.3515	61.6894	74.0273	86.3651	98.7030	111.0409
73	12.68303	25.3661	38.0491	50.7321	63.4152	76.0982	88.7812	101.4642	114.1473
74	13.03273	26.0655	39.0982	52.1309	65.1637	78.1964	91.2291	104.2618	117.2946
75	13.38758	26.7752	40.1627	53.5503	66.9379	80.3255	93.7131	107.1006	120.4882
76	13.74697	27.4939	41.2409	54.9879	68.7349	82.4818	96.2288	109.9758	123.7227
77	14.11091	28.2218	42.3327	56.4436	70.5546	84.6655	98.7764	112.8873	126.9982
78	14.48000	28.9600	43.4400	57.9200	72.4000	86.8800	101.3600	115.8400	130.3200
79	14.85364	29.7073	44.5609	59.4146	74.2682	89.1218	103.9755	118.8291	133.6828
80	15.23182	30.4636	45.6955	60.9273	76.1591	91.3909	106.6227	121.8546	137.0864
81	15.61515	31.2303	46.8455	62.4606	78.0758	93.6909	109.3061	124.9212	140.5364
82	16.00303	32.0061	48.0091	64.0121	80.0152	96.0182	112.0212	128.0242	144.0273
83	16.39576	32.7915	49.1873	65.5830	81.9788	98.3746	114.7703	131.1661	147.5618
84	16.79333	33.5867	50.3800	67.1733	83.9667	100.7600	117.5533	134.3466	151.1400
85	17.19545	34.3909	51.5864	68.7818	85.9773	103.1727	120.3682	137.5636	154.7591
86	17.60242	35.2048	52.8073	70.4097	88.0121	105.6145	123.2170	140.8194	158.4218
87	18.01424	36.0285	54.0427	72.0570	90.0712	108.0854	126.0997	144.1139	162.1282
88	18.43061	36.8612	55.2918	73.7224	92.1531	110.5837	129.0143	147.4449	165.8755
89	18.85182	37.7036	56.5555	75.4073	94.2591	113.1109	131.9627	150.8146	169.6664
90	19.27788	38.5558	57.8336	77.1115	96.3894	115.6673	134.9452	154.2230	173.5009
91	19.70879	39.4176	59.1264	78.8352	98.5440	118.2527	137.9615	157.6703	177.3791
92	20.14424	40.2885	60.4328	80.5771	100.7214	120.8656	141.0099	161.1542	181.2985
93	20.58455	41.1691	61.7537	82.3382	102.9228	123.5073	144.0919	164.6764	185.2610
94	21.02970	42.0594	63.0891	84.1188	105.1485	126.1782	147.2079	168.2376	189.2673
95	21.47940	42.9588	64.4382	85.9176	107.3970	128.8764	150.3558	171.8352	193.3146
96	21.93394	43.8679	65.8018	87.7358	109.6697	131.6036	153.5376	175.4715	197.4055
97	22.39333	44.7867	67.1801	89.5735	111.9668	134.3642	156.7535	179.1469	201.5403
98	22.85758	45.7152	68.5727	91.4303	114.2879	137.1455	160.0031	182.8606	205.7182
99	23.32626	46.6525	69.9788	93.3050	116.6313	139.9576	163.2838	186.6101	209.9363
100	23.80000	47.6000	71.4000	95.2000	119.0000	142.8000	166.6000	190.4000	214.2000

in the crank-end. The effective pressure at any time in the forward stroke is the pressure in the head-end at that instant minus the pressure in the crank-end, and to get the proper mean effective pressure during the forward stroke we should take the mean pressure on the head-end less the mean back pressure on the crank-end. This would make no difference in the computed power of the engine as a whole, for what was lost on one end would be gained by the other, but it would, if the back-pressure lines were different, affect the amounts of power indicated at the different ends, and comes into the question of balancing the load equally. In New England factories it is common to run an engine one-half condensing, that is, to have a separate exhaust pipe for each end, one running to the condenser and the other end exhausting, perhaps

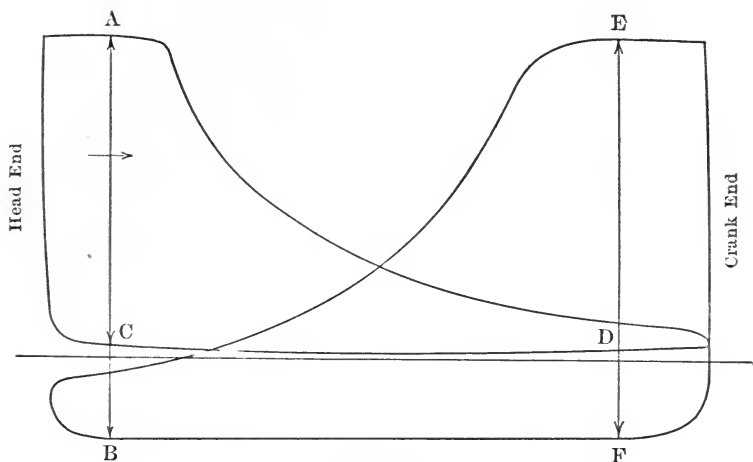

FIG. 100.

under a back pressure for heating, etc. The diagrams from such an engine would be like Fig. 100. Obviously the load would not be equally divided between the two ends of the cylinder when the areas of the diagrams were equal. When the piston is on the line AB and moving in the direction of the arrow there is a pressure urging it forward proportional to the height of A and the back pressure is proportional only to the height of B , so that the effective pressure is AB , although if we take the back-pressure line of the head-end diagram it will appear to be only AC . The diagram from the crank-end would appear, taken by itself, to have an effective pressure proportional to EF when the piston was at that point in the stroke, but since the piston is moving against a back pressure proportional to the height of D the effective pressure at that point is DE . The effort of both ends upon the crank pin cannot be balanced by making the area of the crank-end diagram equal to that of the head-end.

The work actually done upon the crank when the piston is moving forward is found by combining the back-pressure line of the crank-end

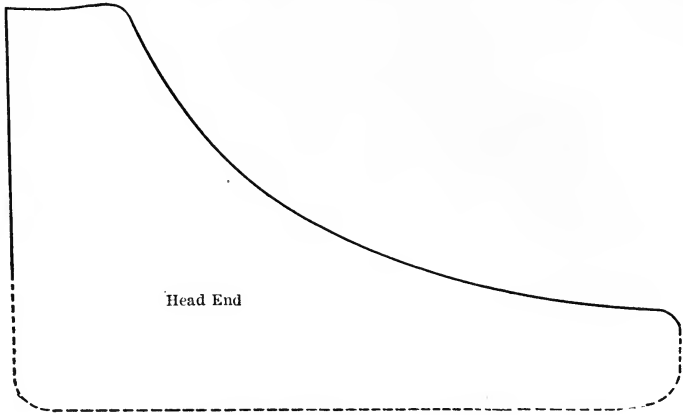

FIG. 101.

diagram with the forward-pressure line of the head-end diagram as in Fig. 101, and vice versa for the backward strokes as in Fig. 102. The

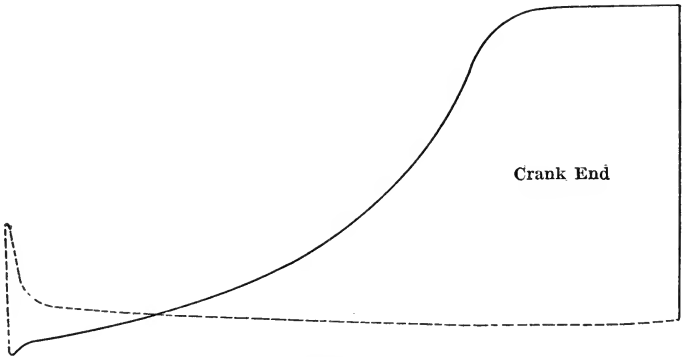

FIG. 102.

work will be equalized between the two ends when the area of these reconstructed diagrams are equal, proper allowance being made for the piston rod.

CHAPTER XIV

MEAN EFFECTIVE PRESSURE AND POINT OF CUT-OFF BY COMPUTATION

THE mean effective pressure of steam working between given limits of pressure and with a given ratio of expansion may be calculated upon the assumption that the product of its volume and pressure remains constant (see chapter on expansion), and such calculation is of use in designing, selecting or estimating the horse-power of an engine.

In Fig. 103 let vertical distances represent pressures, and horizontal distances volume, as in the ordinary indicator diagram. Let OX be the

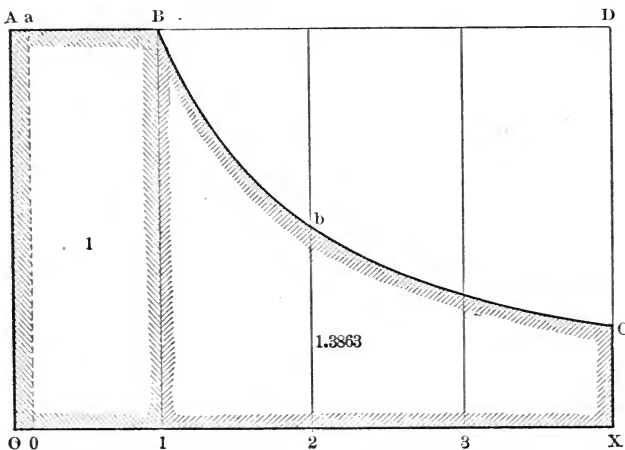

FIG. 103.

line of absolute zero of pressure and OA the zero of volume. If we start with the volume AB of steam of a pressure OA and expand it in the usual unjacketed cylinder through the usual range, the expansion line will follow more or less closely the curve BC , which passes through points so located that the product of the pressure and volume is constant. For instance, if the volume is doubled, the pressure will be halved, and the line will pass through b , which is twice as far from the line of zero volume, but only one-half as far above the line of zero pressure as the point B .

Suppose AB to be the steam line, and BC the expansion line of a diagram from a steam engine cylinder. The average height of the diagram would be the average forward pressure during the stroke on the scale to which it is drawn. Since the area is the average height multiplied by the length, the area divided by the length is the average height which represents the average pressure.

It is easy to see that with the expansion curve following the definite law the area $BCX1$ will be a definite proportion of the area $AB1O$ for any particular ratio of expansion. For four expansions, for example, i.e., when the final volume is four times the initial volume, which is what is meant by a "ratio of expansion" of four, the area under the expansion line is 1.3863 times that under the steam line to whatever scale the diagram is drawn. Table IV at the end of the volume gives the proportion between these two areas for other ratios of expansion under the title of "Hyperbolic Logarithms."

If we make OA equal one pound pressure and $O1$ one unit of volume, then the area $AB1O$ will be $1 \times 1 = 1$, and the area $BCX1$ will be 1.3863 (for four expansions). The total area then in these units will be 2.3863, and the length in the same units 4, so that the average height on the scale selected for the expression of one pound would be 2.3863 divided by 4, and this would be the average or mean forward pressure.

TO FIND THE MEAN FORWARD PRESSURE PER POUND OF INITIAL

RULE.—Divide 1 plus the hyperbolic logarithm of the ratio of the expansion by that ratio; the quotient will be the mean forward pressure per pound of initial.

The logarithms will be found in Table IV at the end of the volume.

The column headed 0% in Table V was calculated in this way, and gives the mean forward pressure per pound of absolute initial pressure, expanded in a cylinder without clearance. When the piston does not pass through the full length of the cylinder, or more properly does not displace the full volume of the expanding steam, we would have the volume AB expanding into the volume OX , while the piston moves only through the distance oX and is displaced only through the volume aB by the entering steam. In order to take care of the clearance, the formula becomes that printed above the table, and with this formula the remaining columns of the table are calculated. By its use the mean forward pressure of the ideal diagram may be easily calculated for any initial pressure, ratio of expansion and clearance.

EXAMPLE.—What would be the mean effective pressure in an engine having 3 per cent clearance, with an initial pressure of 90 pounds gage,

TABLE V

MEAN PRESSURE PER POUND OF INITIAL, WITH DIFFERENT CLEARANCES AND POINTS OF CUT-OFF

$$P_M = 1 + \log_E R(f+c) - c.$$

Fraction of Stroke Complete at Cut-off.	PERCENTAGE OF CLEARANCE												
	0%	1%	1.5%	2%	2.5%	3%	3.5%	4%	4.5%	5%	5.5%	6%	
1/10	.1	.3303	.3439	.3505	.3568	.3630	.3690	.3750	.3808	.3864	.3919	.3974	.4027
	1/9	.111	.3549	.3677	.3738	.3798	.3856	.3913	.3968	.4022	.4075	.4129	.4178
1/8	.125	.3849	.3966	.4023	.4078	.4132	.4187	.4237	.4287	.4338	.4386	.4433	.4480
	1/7	.143	.4213	.4320	.4370	.4420	.4471	.4518	.4565	.4612	.4655	.4699	.4743
1/6	.15	.4346	.4447	.4497	.4546	.4794	.4639	.4684	.4729	.4774	.4816	.4860	.4901
	1/5	.167	.4662	.4757	.4802	.4844	.4890	.4933	.4973	.5014	.5056	.5096	.5134
3/16	.188	.5013	.5097	.5138	.5181	.5217	.5259	.5295	.5332	.5367	.5405	.5440	.5474
	1/5	.20	.5219	.5298	.5336	.5376	.5414	.5449	.5482	.5517	.5556	.5588	.5623
1/4		.21	.5376	.5453	.5489	.5523	.5560	.5595	.5628	.5664	.5698	.5730	.5760
	1/4	.22	.5533	.5602	.5639	.5673	.5704	.5740	.5773	.5804	.5834	.5868	.5900
1/4		.23	.5681	.5750	.5781	.5815	.5848	.5878	.5913	.5940	.5971	.6001	.6029
	1/4	.24	.5827	.5891	.5922	.5952	.5986	.6012	.6042	.6071	.6106	.6131	.6162
1/4		.25	.5966	.6025	.6059	.6090	.6120	.6148	.6174	.6207	.6229	.6258	.6286
	1/4	.26	.6105	.6162	.6190	.6218	.6251	.6274	.6304	.6332	.6359	.6385	.6408
1/4		.27	.6232	.6294	.6319	.6350	.6370	.6398	.6424	.6448	.6480	.6501	.6531
	1/4	.28	.6363	.6416	.6445	.6471	.6496	.6520	.6551	.6572	.6600	.6618	.6644
1/4		.29	.6491	.6545	.6569	.6592	.6613	.6642	.6660	.6686	.6712	.6736	.6759
	3/10	.30	.6609	.6663	.6684	.6712	.6729	.6755	.6779	.6803	.6825	.6845	.6864
3/16		.313	.6760	.6805	.6830	.6855	.6878	.6899	.6919	.6938	.6956	.6985	.7000
	1/3	.32	.6851	.6891	.6914	.6935	.6956	.6974	.7004	.7021	.7035	.7062	.7074
1/3		.333	.6988	.7029	.7047	.7076	.7092	.7106	.7132	.7144	.7168	.7190	.7212
	1/3	.34	.7067	.7115	.7130	.7145	.7171	.7183	.7207	.7230	.7238	.7259	.7279
1/3		.35	.7178	.7220	.7232	.7256	.7266	.7288	.7310	.7330	.7350	.7368	.7370
	1/3	.36	.7281	.7316	.7338	.7346	.7367	.7386	.7405	.7422	.7439	.7454	.7468
3/8		.375	.7433	.7458	.7476	.7494	.7510	.7525	.7539	.7569	.7582	.7593	.7603
	3/8	.38	.7475	.7512	.7528	.7544	.7559	.7573	.7586	.7615	.7626	.7636	.7662
3/8		.39	.7566	.7613	.7627	.7640	.7653	.7664	.7691	.7700	.7708	.7734	.7740
	2/5	.40	.7665	.7691	.7719	.7729	.7738	.7765	.7772	.7778	.7802	.7806	.7829
7/16		.438	.8000	.8024	.8030	.8044	.8063	.8068	.8079	.8096	.8104	.8115	.8127
	1/2	.45	.8089	.8127	.8130	.8141	.8158	.8165	.8176	.8187	.8199	.8210	.8221
1/2		.50	.8466	.8484	.8492	.8503	.8513	.8522	.8530	.8539	.8548	.8556	.8565
	1/2	.55	.8733	.8792	.8810	.8817	.8824	.8831	.8838	.8844	.8851	.8858	.8864
9/16		.563	.8868	.8875	.8882	.8888	.8895	.8901	.8908	.8914	.8920	.8926	.8932
	3/5	.60	.9064	.9076	.9081	.9087	.9092	.9097	.9102	.9107	.9112	.9117	.9122
5/8		.625	.9188	.9194	.9201	.9206	.9210	.9215	.9220	.9224	.9228	.9233	.9237
	5/8	.65	.9300	.9308	.9312	.9316	.9320	.9323	.9327	.9331	.9335	.9338	.9342
2/3		.667	.9371	.9378	.9382	.9385	.9389	.9392	.9396	.9399	.9402	.9405	.9408
	11/16	.688	.9451	.9457	.9460	.9463	.9466	.9469	.9472	.9475	.9478	.9480	.9483
7/10		.70	.9497	.9502	.9505	.9508	.9511	.9513	.9516	.9518	.9521	.9524	.9526
	3/4	.75	.9657	.9661	.9663	.9665	.9667	.9668	.9670	.9672	.9674	.9675	.9677

TABLE V—Continued

MEAN PRESSURE PER POUND OF INITIAL, WITH DIFFERENT CLEARANCES AND POINTS OF CUT-OFF

$$P_M = 1 + \log_E R(f+c) - c.$$

PERCENTAGE OF CLEARANCE												Fraction of Stroke Complete at Cut-off.	
6.5%	7%	7.5%	8%	8.5%	9%	9-5%	10%	10.5%	11%	11.5%	12%		
.4076	.4126	.4176	.4225	.4271	.4320	.4366	.4409	.4453	.4498	.4540	.4580	$\frac{1}{10}$.1
.4278	.4326	.4373	.4417	.4462	.4507	.4549	.4593	.4633	.4676	.4715	.4757	$\frac{1}{9}$.11
.4527	.4571	.4615	.4657	.4700	.4740	.4782	.4821	.4858	.4897	.4938	.4973	$\frac{1}{8}$.12
.4827	.4871	.4908	.4951	.4987	.5026	.5062	.5101	.5138	.5173	.5205	.5242	$\frac{1}{7}$.14
.4939	.4978	.5020	.5059	.5096	.5131	.5169	.5204	.5237	.5274	.5309	.5344		.15
.5210	.5245	.5283	.5318	.5352	.5389	.5417	.5457	.5488	.5517	.5551	.5583	$\frac{1}{6}$.16
.5511	.5546	.5579	.5610	.5639	.5673	.5705	.5736	.5764	.5791	.5825	.5848	$\frac{3}{16}$.18
.5687	.5716	.5750	.5782	.5812	.5841	.5868	.5901	.5924	.5954	.5982	.6009	$\frac{1}{5}$.20
.5821	.5853	.5882	.5910	.5944	.5968	.5998	.6028	.6055	.6081	.6106	.6129		.21
.5959	.5986	.6011	.6043	.6073	.6101	.6128	.6154	.6177	.6199	.6230	.6249		.22
.6087	.6118	.6138	.6166	.6192	.6225	.6248	.6270	.6300	.6318	.6345	.6371		.23
.6212	.6239	.6264	.6297	.6319	.6340	.6369	.6397	.6413	.6438	.6462	.6485		.24
.6336	.6359	.6390	.6410	.6438	.6465	.6480	.6505	.6528	.6550	.6570	.6602	$\frac{1}{4}$.25
.6460	.6479	.6507	.6533	.6548	.6571	.6594	.6626	.6646	.6665	.6682	.6711		.26
.6576	.6601	.6626	.6649	.6670	.6691	.6710	.6728	.6757	.6772	.6799	.6812		.27
.6692	.6714	.6735	.6755	.6773	.6803	.6818	.6833	.6859	.6885	.6895	.6918		.28
.6800	.6819	.6849	.6865	.6880	.6906	.6919	.6943	.6967	.6990	.6997	.7018		.29
.6911	.6927	.6954	.6966	.6991	.7002	.7024	.7046	.7067	.7087	.7107	.7125	$\frac{3}{10}$.30
.7039	.7063	.7073	.7096	.7117	.7138	.7157	.7176	.7194	.7211	.7226	.7241	$\frac{5}{16}$.31
.7123	.7131	.7158	.7173	.7193	.7211	.7229	.7245	.7261	.7275	.7289	.7319		.32
.7239	.7257	.7275	.7292	.7308	.7323	.7353	.7366	.7378	.7389	.7417	.7426	$\frac{1}{3}$.33
.7316	.7333	.7349	.7364	.7378	.7391	.7421	.7432	.7442	.7469	.7477	.7484		.34
.7417	.7432	.7445	.7457	.7468	.7496	.7506	.7514	.7540	.7546	.7571	.7575		.35
.7511	.7523	.7533	.7543	.7569	.7577	.7602	.7608	.7632	.7636	.7658	.7660		.36
.7639	.7646	.7671	.7676	.7700	.7711	.7725	.7739	.7752	.7766	.7779	.7792	$\frac{3}{8}$.37
.7677	.7702	.7707	.7730	.7733	.7755	.7767	.7781	.7794	.7807	.7820	.7832		.38
.7768	.7791	.7793	.7815	.7824	.7837	.7850	.7862	.7875	.7888	.7900	.7912		.39
.7853	.7874	.7880	.7892	.7905	.7918	.7930	.7942	.7954	.7966	.7978	.7990	$\frac{2}{5}$.40
.8149	.8161	.8172	.8182	.8193	.8204	.8214	.8224	.8235	.8244	.8254	.8264	$\frac{7}{16}$.43
.8242	.8252	.8263	.8273	.8283	.8293	.8303	.8312	.8322	.8331	.8341	.8350		.45
.8582	.8590	.8598	.8606	.8614	.8622	.8629	.8637	.8644	.8652	.8659	.8667	$\frac{1}{2}$.50
.8877	.8883	.8890	.8896	.8902	.8908	.8914	.8920	.8925	.8931	.8937	.8942		.55
.8944	.8950	.8956	.8962	.8968	.8973	.8979	.8984	.8989	.8995	.9000	.9005	$\frac{9}{16}$.56
.9132	.9136	.9141	.9146	.9150	.9155	.9159	.9164	.9168	.9173	.9177	.9181	$\frac{3}{5}$.60
.9245	.9249	.9253	.9257	.9261	.9265	.9269	.9272	.9276	.9280	.9284	.9288	$\frac{5}{8}$.62
.9349	.9352	.9356	.9359	.9363	.9366	.9369	.9373	.9376	.9379	.9382	.9385		.65
.9415	.9418	.9421	.9424	.9427	.9430	.9433	.9436	.9438	.9442	.9444	.9447	$\frac{2}{3}$.66
.9489	.9491	.9494	.9497	.9499	.9502	.9505	.9507	.9509	.9512	.9514	.9517	$\frac{11}{16}$.68
.9531	.9533	.9536	.9538	.9541	.9543	.9546	.9548	.9550	.9552	.9554	.9557	$\frac{7}{10}$.70
.9680	.9682	.9684	.9685	.9687	.9688	.9690	.9691	.9693	.9695	.9696	.9698	$\frac{3}{4}$.75

cutting off at one-quarter stroke, and exhausting at atmospheric pressure?

By the table, the mean pressure per pound of absolute initial for 3 per cent clearance and one-quarter cut-off is 0.6148 of the initial pressure. The absolute initial is $90 + 14.7 = 104.7$ lbs. The

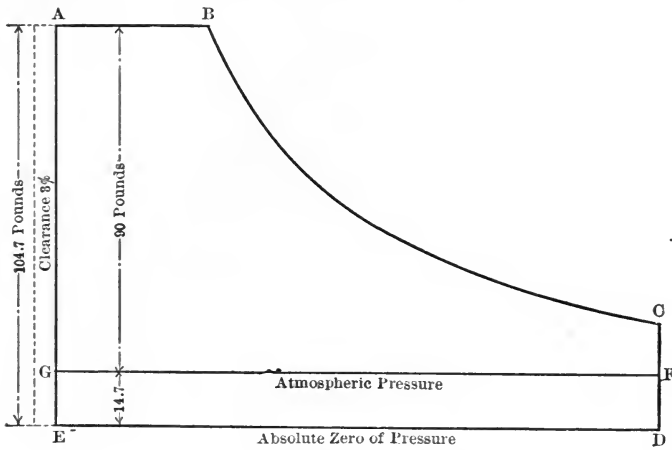

FIG. 104.

mean pressure of the ideal diagram is therefore $104.7 \times 0.6148 = 64.37$ pounds. This is the mean effective pressure represented by the diagram *ABCDE* in Fig. 104. Since there is 14.7 pounds back pressure above absolute zero, this must be subtracted, giving $64.37 - 14.7 = 49.67$ as the mean effective pressure represented by the area *ABCFG*. If

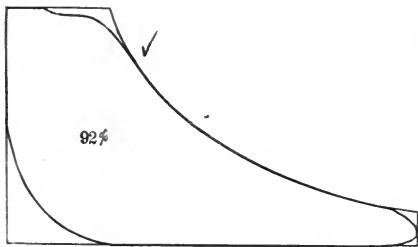

FIG. 105.

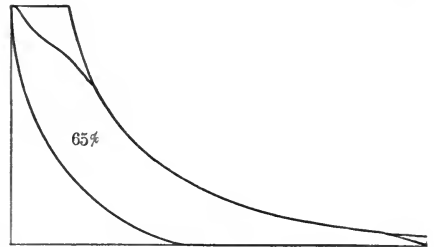

FIG. 106.

the engine were condensing we would subtract the absolute back pressure corresponding with the vacuum, roughly one pound for each two inches of vacuum short of 30 inches, i.e., one pound for 28 inches, two pounds for 26 inches, three pounds for 24 inches, etc.

More accurate values may be found in a table of the Physical Properties of Steam.

But no engine makes a diagram like $ABCFG$; the steam line is apt to fall away, the points of cut-off and release to be rounded, the line of counter-pressure to hang up in places, and the compression takes out considerable area. The actual mean effective pressure will be to the mean effective calculated above as the actual diagram which the engine would make is to the ideal area. This relationship is indicated for three typical cases in Figs. 105, 106, and 107 by diagrams which give the percentages which the realized area bears to the ideal. If in the above example we may expect the engine to realize about 90 per cent of the

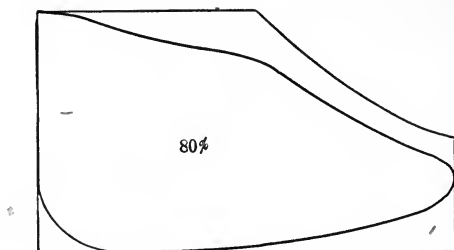

FIG. 107.

ideal area, we may say the probable M.E.P. equals about $49.67 \times 0.9 = 44.7$ lbs.

TO FIND THE MEAN EFFECTIVE PRESSURE FROM THE TABLE

RULE.—Multiply the tabular value opposite the given point of cut-off and in the column of the given clearance by the absolute initial pressure; subtract the absolute back pressure and multiply by the proportion of the ideal area probably realized.

The initial pressure means the pressure which gets into the cylinder, and may be very different from the boiler pressure, especially with a throttling governor.

CHAPTER XV

STEAM CONSUMPTION FROM THE DIAGRAM

KNOWING the cubic capacity of the cylinder and the number of times it is filled and emptied per hour, we could, if the entire contents of the cylinder remained as steam all the time, compute the cubic feet of steam passing through the engine in that time. Knowing from the diagram the pressure of this steam we can find in a steam table the weight per cubic foot, and thus the weight of steam passed per hour. The diagram also gives us a measure of the horse-power, dividing by which we get the number of pounds of steam accounted for by the diagram per hourly horse-power. This will be always less than the actual amount of steam supplied to the engine, because a considerable proportion of such steam is condensed on its entrance to the cylinder, and is not re-evaporated until after the valve opens for exhaust, so that it does not show as steam upon the diagram at all. The computation is of use, however, for purposes of comparison, and as a measure of the minimum amount of steam which the diagram would allow per horse-power, and should be understood by one who desires to attain proficiency with the indicator.

- Let A = area of piston in square inches,
 S = length of stroke in feet,
 N = number of strokes per minute,
 P = mean effective pressure, indicated by diagram.
 V = volume generated by the piston per hour.

$$V = \frac{A}{144} \times S \times 60N, \dots \dots \dots (1)$$

the area in square inches divided by 144 to reduce to square feet, multiplied by the length of the stroke, gives the cubic feet per stroke, and by 60 times the number of strokes per minute gives the number of cubic feet passed through by the piston per hour.

$$\text{The horse-power is } \frac{PANS}{33000} \dots \dots \dots (2)$$

Dividing equation (1) by equation (2) we get the number of cubic feet passed through by the piston in an hour for each horse-power. As the

area, length of stroke, and number of strokes per minute are used in calculating both the volume and the horse-power they cancel each other in the division, and the formula becomes

$$\frac{\frac{A}{144} S 60 N}{\frac{P A N S}{33000}} = \frac{A S 60 N 33000}{144 P A N S} = \frac{13750}{P},$$

or in plain language, 13,750 divided by the mean effective pressure will give the cubic feet of piston displacement per hour for each horse-power generated by any engine, whatever its size or speed. Substituting for P the common abbreviation of the mean effective pressure we have

$$\frac{13700}{\text{M.E.P.}} = \text{volume generated per hour per horse-power. . . . (3)}$$

If the engine had no clearance nor compression and the release did not occur until the end of the stroke, we could measure the pressure of

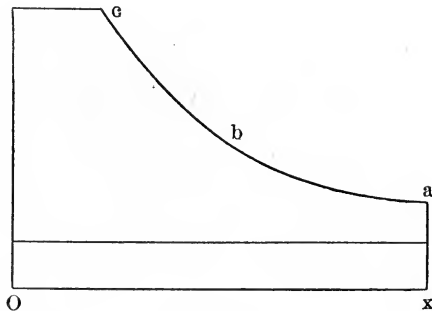

FIG. 108.

the steam at the point a , Fig. 108, find in a steam table the weight of steam of that pressure per cubic foot, multiply the volume per horse-power by that weight, and find the weight per horse-power per hour. As the quantities in the steam tables are usually given in pounds absolute it is better to measure from the zero line ox , or to add 14.7 pounds to the measurement from the atmospheric line. Or we could equally well measure the pressure at any other point after the cut-off valve closes and take such proportion of the volume given by formula 3, based on the whole stroke, as the portion of the stroke completed by the piston up to the point chosen bears to the full stroke. If we measure the volume at a we have had so many complete cylinderfuls of steam at that pressure, and formula (3) will give the volume per horse-power. If we measur

the volume at half-stroke b we have had only one-half the volume at this higher pressure, and formula must be multiplied by 0.5 to give the number of cubic feet per horse-power per hour of this higher pressure steam. Likewise if we measure the pressure at one-quarter stroke c we shall have had but one-quarter of the volume, and must multiply the formula by 0.25, and so for any other fraction of the stroke. If the amount of steam in the cylinder were constant throughout the expansion the weight per horse-power per hour would be the same whether we measured it at cut-off or at release, or at any point between, but condensation and re-evaporation are going on, so that there is more steam in the cylinder later in the stroke than immediately after the cut-off, and there will usually be found to be a greater amount of steam accounted for per horse-power per hour the nearer the measurements are made to the point of release. Call the fraction of the stroke completed at the point chosen F , and the weight of steam per cubic foot at that pressure w_f , then under the simple conditions assumed

$$\frac{13750}{\text{M.E.P.}} F w_f = \text{lbs. steam per H.P.H.} \dots \dots (4)$$

when the pressure is measured at the end of the stroke, as at a , F becomes unity or one, and the formula becomes

$$\frac{13750w}{\text{M.E.P.}} = \text{lbs. steam per H.P.H.} \dots \dots (5)$$

We have yet to determine the amount of steam required to fill the clearance, and the amount left in the cylinder when the exhaust valve closes. As we cannot exhaust into a perfect vacuum there will always be some such steam, even when there is no compression. Suppose the engine to have five per cent clearance, then when the piston was at a instead of having the volume swept through by the piston behind it we should have 1.05 times that volume. When the piston was at half-stroke we should have instead of 0.5 of the piston displacement 0.55 of that volume, and generally for any fraction F of the stroke completed at the point chosen for measurement we should have $F+c$ of the piston displacement behind it, c being the clearance in fractions of the stroke, and the steam per horse-power per hour becomes

$$\frac{13750}{\text{M.E.P.}} (F+c) w_f \dots \dots (6)$$

Suppose in Fig. 109 the exhaust valve to close at e when the return stroke is 0.8 completed. The volume of steam shut in would be the area

of the piston in square feet multiplied by the fraction of stroke uncompleted plus the five one-hundredths of the stroke, included in the clearance, that is, $0.2 + 0.05 = 0.25$; or generally, calling the portion of the stroke uncompleted at the compression x , the volume inclosed would be, per hour,

$$\frac{A}{144} s(x+c) 60N, \dots \dots \dots (7)$$

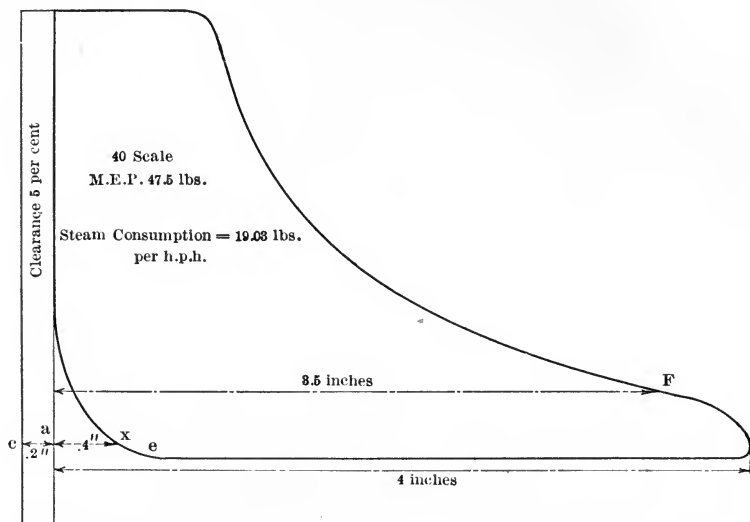

FIG. 109.

and this divided by the horse-power $\frac{P.A.N.S}{33000}$ to give the volume saved per horse-power, and multiplied by the weight w_x of steam per cubic foot at the pressure obtained at the point x would be

$$\frac{13750}{M.E.P.} (x+c)w_x. \dots \dots \dots (8)$$

Subtracting this from formula (6) we have

$$Q = \frac{13750}{M.E.P.} [(F+c)w_f - (x+c)w_x]. \dots \dots \dots (9)$$

- Where c = clearance in fractions of the stroke;
- F = fraction of stroke completed at point chosen on expansion line;
- x = fraction of stroke uncompleted at point chosen on compression line.
- w_f = wt. per cu.ft. of steam at pressure measured at F ;
- w_x = wt. per cu.ft. of steam at pressure measured at x ;
- Q = steam accounted for per H.P. per hour.

RULE.—To the fraction of the forward stroke completed at the point chosen add the clearance, also in fractions of the stroke, and multiply the sum by the weight per cubic foot of steam of the pressure measured at this point. (Product 1.)

To the fraction of the return stroke uncompleted at the point chosen on the compression line add the clearance, expressed as before, and multiply the sum by the weight per cubic foot of steam of the pressure measured at this point. (Product 2.)

Multiply the difference between products 1 and 2 by the quotient of 13,750 divided by the M.E.P.; the final product will be the number of pounds of steam per hour per horse-power accounted for by the diagram.

As an assistance in working with the above rule or formula Table VI gives the value of 13,750 divided by mean effective pressures of from 10 to 100 pounds. The first column under zero gives the quotients for even pounds, the succeeding columns for additional tenths of pounds.

Thus the quotient of $\frac{13750}{35.6}$ would be found in the horizontal line with 35 and in the column under 6 to be 386.23.

EXAMPLE.—The diagram shown in Fig. 109 shows with a 40 scale a M.E.P. of 47.5 pounds; clearance 5 per cent. How much steam is accounted for per horse-power per hour?

Let us select the points F and x from which to make our measurements. The whole length of the diagram is 4 inches, the length to the point F , 3.5 inches. The fraction F of the stroke completed at this point is therefore $\frac{3.5}{4} = 0.875$. The distance xa equals 0.4 of an inch,

and the fraction of the return stroke uncompleted at the point x is $\frac{0.4}{4} = 0.1$.

The pressure (absolute) at F is 32 pounds, at x 19 pounds. The weight of steam per cubic foot at 32 pounds is 0.0789, at 19 pounds 0.0483.

$$\begin{aligned} \text{then} \quad c &= 0.05 \\ F &= 0.875 \\ x &= 0.1 \\ w_f &= 0.0789 \\ w_x &= 0.0483 \\ \text{and M.E.P.} &= 47.5 \end{aligned}$$

The steam accounted for per horse-power per hour is

$$\frac{13750}{47.5} \times [(0.875 + 0.05)0.0789 - (0.1 + 0.05)0.0483].$$

From the table we find the value of $\frac{13750}{47.5}$ to be 289.47, and we have $289.47 \times [(0.925 \times 0.0789) - (0.15 \times 0.0483)] = 19.03$ pounds of steam per hour for each horse-power.

It is not necessary that the point X , at which the pressure of the steam saved by compression is measured, shall be at the commencement of compression. It may be located at any point upon that line or upon

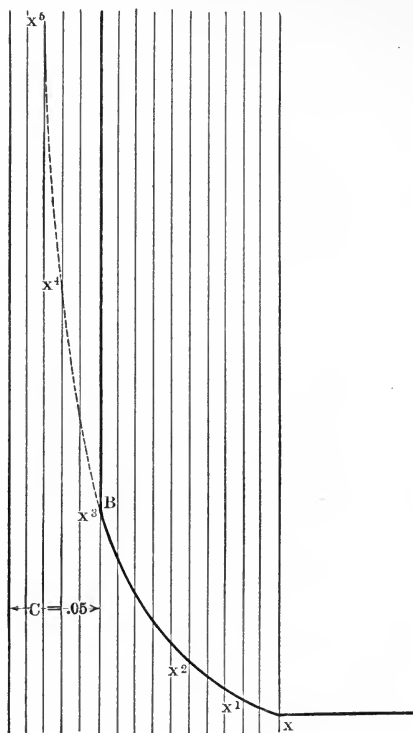

FIG. 110.

the dotted continuation of that line into the clearance space. In Fig. 110, representing the compression corner of a diagram on a large scale let the vertical divisions represent hundredths of the stroke, the clearance C being five per cent or five hundredths, and the exhaust valve closing at X when ten one-hundredths of the stroke are uncompleted. When the exhaust valve closes we have a volume of steam inclosed equal to $C + X = 0.05 + 0.10 = 0.15$ of the displacement at the pressure X , or if we measure at X^1 , when 0.08 of the stroke remain to be completed, we shall have $0.05 + 0.08 = 0.13$ at the pressure X^1 , or 0.10 at the pressure X^2 , or 0.05 at the pressure X^3 , 0.03 at X^4 , etc., so that so long as we measure

TABLE VI

VALUES OF $\frac{13750}{\text{M.E.P.}}$ FOR COMPUTING STEAM CONSUMPTION

	0	1	2	3	4	5	6	7	8	9
10	1375.00	1361.39	1348.04	1334.95	1322.15	1309.52	1297.17	1285.04	1273.14	1261.46
11	1250.00	1238.74	1227.68	1216.81	1206.13	1195.65	1185.34	1175.19	1165.25	1155.46
12	1145.83	1136.36	1127.05	1117.88	1108.87	1100.00	1091.11	1082.67	1074.21	1062.01
13	1057.69	1049.62	1041.66	1033.83	1026.12	1018.51	1011.03	1003.64	996.38	989.21
14	982.14	975.18	968.31	961.54	954.86	948.29	941.78	935.37	929.00	922.82
15	916.67	910.60	904.61	898.69	893.05	887.09	881.41	875.79	870.25	864.77
16	871.87	854.04	848.76	843.55	838.41	833.33	828.31	823.35	818.45	813.61
17	808.82	804.09	799.42	794.79	790.23	785.71	781.25	776.84	772.47	768.15
18	763.89	759.67	755.49	751.36	747.28	743.24	739.24	735.29	731.38	727.51
19	723.68	719.89	716.15	712.43	708.76	705.13	701.53	697.99	694.44	690.95
20	687.50	683.08	680.69	677.34	674.02	670.73	667.47	664.25	661.06	657.84
21	654.76	651.66	648.58	645.54	642.52	639.53	636.57	633.64	630.73	627.85
22	625.00	622.17	619.37	616.59	613.94	611.11	608.41	605.72	603.07	600.43
23	597.83	595.24	592.67	590.12	587.61	585.11	582.62	580.16	577.73	575.31
24	572.92	570.54	568.18	565.84	563.52	561.22	558.94	556.67	554.43	552.21
25	550.00	547.81	545.64	543.47	541.33	539.21	537.11	535.02	532.94	530.88
26	528.85	526.82	524.81	522.81	520.83	518.87	516.91	514.98	513.06	511.15
27	509.26	507.38	505.51	503.66	501.82	500.00	498.11	496.39	494.60	493.19
28	491.07	489.32	487.55	485.86	484.15	482.45	480.76	479.09	477.43	476.12
29	474.14	472.51	470.89	469.28	467.68	466.10	464.53	462.89	461.40	459.86
30	458.33	456.81	455.30	453.79	452.30	450.82	449.34	447.88	446.42	444.98
31	443.55	442.12	441.99	439.30	437.83	436.51	435.12	433.75	432.39	431.35
32	429.69	428.35	427.01	425.69	424.38	423.07	421.77	420.49	419.21	417.93
33	416.67	415.41	413.85	412.91	411.67	410.44	409.22	408.01	406.80	405.60
34	404.41	403.22	402.05	400.87	399.71	398.55	397.39	396.25	395.11	393.98
35	392.84	391.73	390.63	389.51	388.41	387.32	386.23	385.15	384.08	383.01
36	381.94	380.89	379.83	378.78	377.75	376.71	375.68	374.66	373.64	372.62
37	371.62	370.62	369.62	368.63	367.65	366.66	365.69	364.72	363.75	362.79
38	361.84	360.89	359.94	358.99	358.07	357.40	356.22	355.29	354.38	353.47
39	352.56	351.64	350.77	349.87	348.98	348.10	347.22	346.34	345.47	344.11
40	343.75	342.89	342.32	341.19	340.34	339.51	338.67	337.83	337.01	336.18
41	335.36	334.55	333.74	332.92	332.12	331.32	330.52	329.71	328.94	328.16
42	327.38	326.36	325.83	325.06	324.26	323.50	322.77	322.01	321.35	320.51
43	319.77	319.02	318.29	317.55	316.82	316.09	315.36	314.64	313.92	313.21
44	312.50	311.79	311.09	310.38	309.68	308.98	308.29	300.61	306.92	306.23
45	305.55	304.88	304.20	303.55	302.86	302.19	301.53	300.87	300.22	299.34
46	298.91	298.26	297.62	296.97	296.33	295.48	295.06	294.43	293.80	292.96
47	292.55	291.93	291.31	290.61	290.08	289.47	288.86	288.26	287.65	287.05
48	286.46	285.86	285.26	284.66	284.09	283.50	282.92	282.34	281.76	281.18
49	280.61	280.04	279.47	278.99	278.34	277.77	277.21	276.66	276.10	275.55
50	275.00	274.45	273.90	273.35	272.82	272.27	271.73	271.20	270.67	270.13
51	269.61	269.08	268.55	268.03	267.51	266.99	266.47	265.95	265.44	264.93
52	264.43	263.91	263.41	262.91	262.40	261.90	261.40	260.91	260.41	259.83
53	259.43	258.94	258.45	257.97	257.49	257.00	256.53	256.05	255.57	255.10
54	254.63	254.16	253.69	253.22	252.75	252.29	251.83	251.37	250.91	250.47
55	250.00	249.54	249.09	248.64	248.19	247.74	247.30	246.86	246.41	245.97

TABLE VI—Continued

VALUES OF $\frac{13750}{\text{M.E.P.}}$ FOR COMPUTING STEAM CONSUMPTION

	0	1	2	3	4	5	6	7	8	9
56	244.64	245.10	244.66	244.22	243.79	243.36	242.93	242.50	242.07	241.65
57	241.23	240.80	240.38	239.26	237.80	239.13	238.71	238.30	237.88	237.47
58	233.62	236.66	236.25	235.84	235.44	235.04	234.64	234.22	233.84	233.44
59	237.07	232.64	232.26	231.87	231.84	231.09	230.71	230.31	229.93	229.54
60	229.17	228.79	228.41	228.03	227.65	227.27	226.89	226.52	226.15	225.78
61	225.41	225.04	224.67	224.30	223.92	223.57	223.21	222.85	222.49	222.13
62	221.71	221.42	221.06	220.67	220.35	220.00	219.61	219.29	218.93	218.60
63	218.25	217.91	217.56	217.21	216.87	216.53	216.19	215.06	215.51	215.18
64	214.84	214.50	214.17	213.99	213.50	213.17	212.69	212.51	212.19	211.86
65	211.54	211.21	210.88	210.56	210.44	209.92	209.60	209.28	208.96	208.64
66	208.31	208.01	207.70	207.39	207.08	206.70	206.45	206.14	205.83	205.53
67	205.22	204.91	204.61	204.31	204.00	203.70	203.40	203.10	202.80	202.50
68	202.20	201.91	201.61	201.32	201.04	200.73	200.43	200.14	199.85	199.56
69	199.27	198.98	198.69	198.41	198.12	197.84	196.12	197.56	196.99	196.70
70	196.43	196.14	195.86	195.59	195.31	195.03	194.75	194.34	194.21	193.93
71	193.66	193.39	193.12	192.84	192.57	192.31	192.03	191.77	191.50	191.23
72	190.97	190.71	190.44	190.17	189.91	189.65	189.39	189.13	188.87	187.24
73	188.36	188.10	187.84	187.58	187.33	187.07	186.82	186.56	186.31	186.06
74	185.80	185.56	185.30	185.06	184.81	184.56	184.31	184.07	183.82	183.57
75	183.34	183.09	182.84	182.60	182.36	182.11	181.87	181.63	181.39	181.16
76	180.92	180.68	180.45	180.21	179.97	179.73	179.50	179.27	179.03	178.80
77	178.57	178.34	178.11	177.87	177.65	177.42	177.19	177.09	176.73	176.51
78	176.28	176.05	175.83	175.61	175.38	175.16	174.81	174.71	174.49	174.27
79	174.05	173.83	173.61	173.39	173.17	172.95	172.73	172.52	172.18	172.09
80	171.87	171.66	171.45	171.23	171.02	170.81	170.59	170.38	170.17	169.96
81	169.75	169.54	169.33	169.12	168.91	168.71	168.50	168.29	168.09	167.88
82	167.68	167.47	167.27	167.07	166.86	166.67	166.46	166.26	166.06	165.86
83	165.66	165.46	165.26	165.06	164.86	164.67	164.47	164.27	164.09	163.88
84	163.69	163.49	163.30	163.11	162.92	162.72	162.52	162.22	162.14	161.96
85	161.76	161.57	161.38	161.19	161.01	160.82	160.63	160.44	160.25	160.07
86	159.88	159.70	159.51	159.33	159.14	158.73	158.77	158.59	158.41	158.23
87	158.04	157.86	157.68	157.50	157.32	157.14	156.96	156.78	156.61	156.44
88	156.25	156.07	155.89	155.71	155.54	155.36	155.19	154.01	154.84	154.66
89	154.49	154.32	154.14	153.97	153.80	153.63	153.46	153.29	153.12	152.94
90	153.78	152.61	152.44	152.27	152.10	151.93	151.76	151.60	151.54	151.20
91	151.09	150.93	150.77	150.60	150.43	150.27	150.11	149.94	149.77	149.61
92	149.45	149.29	149.13	148.97	148.81	148.64	148.48	148.32	148.16	148.00
93	147.85	147.58	147.53	147.25	147.21	147.05	146.90	146.73	146.59	146.43
94	146.27	146.12	145.96	145.81	145.65	145.50	145.34	145.19	145.04	144.88
95	144.73	144.58	144.48	144.28	144.13	143.98	143.82	143.67	143.52	143.37
96	143.23	143.08	142.93	142.67	142.63	142.48	142.34	142.19	142.04	141.90
97	141.75	141.61	141.46	141.31	141.17	141.02	140.88	140.73	140.59	140.44
98	140.31	140.17	140.02	139.87	139.73	139.59	139.46	139.31	139.17	139.03
99	138.88	138.74	138.61	138.46	138.33	138.19	138.05	137.91	137.77	137.63
100	137.50	137.36	137.22	137.09	136.95	136.81	136.68	136.54	136.41	136.27

the pressures and volumes accordingly X may be located anywhere on the compression curve, or even on the dotted extension of that line inside the clearance space. The compression after the piston has reached the end of its stroke will go on by the admission of the higher pressure steam. Suppose in Fig. 111 the exhaust valve closes at E , shutting in a volume proportional to the line OE , of exhaust steam. When the piston reaches the end of its stroke on the line $A a$ the clearance will be full of steam raised by compression to the pressure B . The admission valve being now opened, live steam rushes in and raises the pressure to that of the steam line AC , by which process the steam saved by compression and which occupied the whole clearance at a pressure B before admission

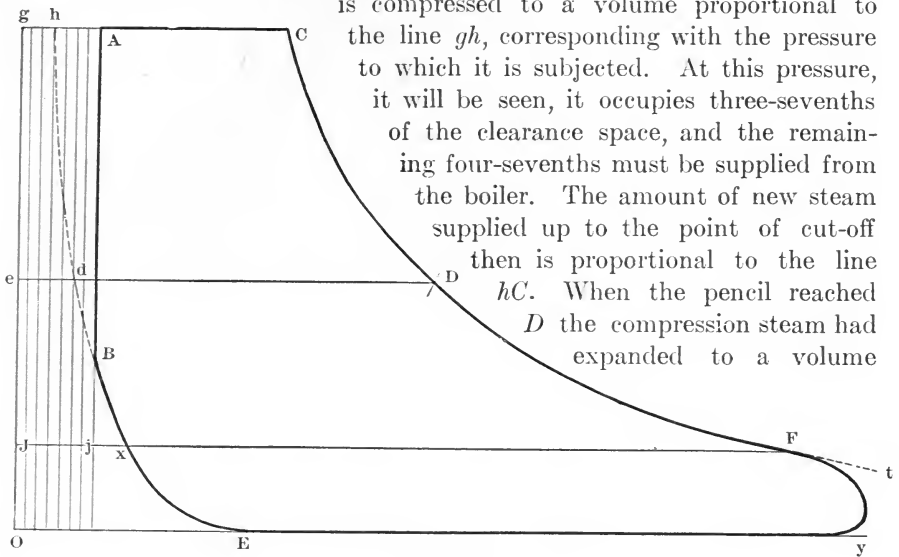

FIG. 111.

is compressed to a volume proportional to the line gh , corresponding with the pressure to which it is subjected. At this pressure, it will be seen, it occupies three-sevenths of the clearance space, and the remaining four-sevenths must be supplied from the boiler. The amount of new steam supplied up to the point of cut-off then is proportional to the line hC . When the pencil reached D the compression steam had expanded to a volume proportional to ed , corresponding with that pressure, and the new steam involved in the stroke is proportional to the line Dd , and this is true of any line drawn horizontally across the diagram between the expansion and compression line, or the continuation of the latter into the clearance. This fact, when the compression is such that a horizontal line from the point which we wish to use on the expansion line will cut the compression line, as Fx , gives a simple process for finding the steam accounted for by the indicator corrected both for clearance and compression. It will be remembered that the formula when the whole volume of the displacement was involved and the pressure taken at the end of the stroke t was by formula (5),

$$\frac{13750w}{\text{M.E.P.}}$$

where w was the weight per cubic foot of steam at the terminal pressure. If instead of measuring the pressure at the terminus of the stroke t , we take any other time point, as F or D , the volume involved will be to the whole displacement volume as x^F or dD is to the length of the diagram ay . If as before F = the fraction of the stroke completed at the point chosen for measurement, as F , Fig. 111, and X = the portion of the return stroke uncompleted at the point chosen on the compression line, then $F - X$ (i.e., $j^F - j^X$, Fig. 111) will be the fraction of the whole length of the diagram occupied by the line XF , included between the expansion and compression lines. Substituting for w in formula (5) w_f = the weight per cubic foot at the pressure measured at point F , and multiplying by the fraction $F - X$, we get the steam accounted for per horse-power and per hour, reducing the complete formula to

$$\frac{13750}{\text{M.E.P.}} (F - X) w_f.$$

RULE.—*From the fraction of the stroke completed at the point chosen on the expansion line subtract the fraction of the stroke uncompleted at the point on the compression line which is in the same horizontal line. Multiply the difference by the weight per cubic foot of steam at the pressure measured at the points chosen and by the quotient of 13,750 divided by the mean effective pressure. The final product will be the weight of steam accounted for per horse-power per hour.*

When the terminal pressure is so high or the compression is so small that a horizontal line would cut the admission rather than the compression line, the point X will be independently located and formula (9) used rather than to construct the extension of the compression line into the clearance, though the simple method just described would still be used on speculative or theoretical work. If the horizontal line intersects the junction of the compression and admission lines as at B , the portion X of the stroke uncompleted at this point becomes zero. If the horizontal line crosses the admission line, as at Dd , X becomes minus, and the distance from the admission line Aa to the point d where the horizontal crosses the compression line must be added to F . The value $F - X$, however, would in this case be more easily arrived at and may be found in any case by dividing the length of the horizontal line, as dD , included between the expansion lines, by the length of the diagram ay .

RULE.—*Draw a line across the diagram parallel with the atmospheric line. Divide the length of that portion of this line included between the expansion and compression lines by the extreme length of the diagram, and multiply the quotient by the weight per cubic foot of steam at the pressure indicated by the height of the horizontal line. Multiply this product by the quotient*

of 13,750 divided by the mean effective pressure, and the result will be the pounds of steam accounted for per horse-power per hour.

This rule is identical with the other, the proportion of the line of quantities to the length of the diagram being arrived at differently. It can be deduced from the formula algebraically as follows: When the points F and X are at the same height $w_x = w_f$, and the formula becomes

$$\frac{13750}{\text{M.E.P.}}[(F+C)w_f - (X+C)w_f] = \frac{13750}{\text{M.E.P.}}(F-X)w_f.$$

STEAM ACCOUNTED FOR BY MULTIPLE-CYLINDER DIAGRAMS.

We have seen that the amount of steam in the cylinder is different at different points in the stroke, increasing by re-evaporation as the stroke progresses. The same thing holds true in a multiple-cylinder engine. A portion of steam is measured off by the cut-off valve of the high-pressure cylinder. This portion in passing through the series of cylinders develops a determined amount of power. If the quantity of steam remained constant the quantity per horse-power hour would be the same whether measured immediately on the closure of the high-pressure cut-off valve or just before its final release in the low-pressure cylinder. But its quantity is constantly changing and more steam will be found to be accounted for per horse-power hour at the terminal end of the low-pressure than at any other point, under ordinary conditions. The steam accounted for may be computed at any point between cut-off and release on a diagram from any cylinder by the same rules and formulas used for simple engines, but in order that the area, stroke and number of revolutions may cancel, as shown, that M.E.P. must be used which would be equivalent in effect in the cylinder with which we are working to the aggregate of the several mean effectives in their respective cylinders.

The effect of a given mean effective pressure is proportionate to the displacement per unit of time of the cylinder in which it works. A given mean effective pressure will produce twice the power in a cylinder having twice the area, with the same piston speed. So if it is wished to find how much M.E.P. would be necessary to develop an amount of power in the low-pressure cylinder equivalent to that developed by a given M.E.P. in the high, the M.E.P. must be divided by the ratio of the displacements between the high- and low-pressure cylinders. To find this ratio multiply the square of the diameter, the stroke, and the revolutions per minute of each cylinder together, and divide the product from the larger cylinder by that from the smaller. As in ordinary multi-

cylinder engines all the cylinders have the same length of stroke and the same number of revolutions per minute, these factors cancel, and the operation is reduced to dividing the square of the diameter of the larger cylinder by the square of the diameter of the smaller, or dividing the larger by the smaller diameter and squaring the quotient.

RULE.—To refer the mean effective pressure of one cylinder to another multiply the given M.E.P. by the ratio between the cylinder displacements if the cylinder to which it is to be referred is smaller, or divide if it is the larger.

EXAMPLE.—In a compound engine having cylinders 12 and 24 inches in diameter, running at the same piston speed, the diagrams show 38 pounds of M.E.P. in the high-pressure and 9.18 pounds in the low. Refer the mean effective pressure to the low-pressure cylinder.

The ratio between the cylinders is

$$(24 \div 12)^2 = 4.$$

Then 38 pounds in the high-pressure cylinder would be equaled by 38 \div 4 = 9.5 pounds in the low pressure. Add this to the 9.18 pounds shown by the low-pressure diagram and we have 9.5 + 9.18 = 18.68 pounds of mean effective pressure which would be required to do in the low-pressure cylinder alone the work of 38 in the high and 9.18 in the low. In working out the steam accounted for per horse-power per hour from the low-pressure diagram therefore the M.E.P. used would be 18.68 pounds.

When working from the high-pressure diagram the M.E.P. of the low-pressure diagram must be referred to the smaller cylinder. On account of the smaller displacement, it would require four times as much pressure (4 is the ratio between the cylinder displacements) to do the work in the high-pressure cylinder as in the low, so that to do the work of 9.18 pounds M.E.P. in the low-pressure cylinder would require 4 \times 9.18 = 36.72 in the high. Add to this the 38 pounds indicated by the high-pressure diagram and find 36.72 + 38 = 74.72 pounds as the M.E.P. to be used in the formula when the steam accounted for is computed from the high-pressure diagram. With a triple- or quadruple-expansion engine proceed the same way.

With this aggregate M.E.P. proceed as though the diagram were from a single-cylinder engine. When the mean effective is referred to the high-pressure cylinder it is liable to become much larger than actually obtained, and to exceed the limit of the values given in Table V. We therefore publish Table VII, taken from the Ashcroft book of instructions for the Tabor indicator (a continuation of that table), giving the values of $\frac{13750}{\text{M.E.P.}}$ for mean effective pressures from 100 to 250 pounds.

If instead of making a table of $\frac{13750}{\text{M.E.P.}}$ for various mean effective pressures we make one of $13,750w$ for various values of w , we avoid using a table to find the weight per cubic foot of steam. Such a table, computed by J. W. Thompson, M.E., is printed on page 132. Finding in this table the value for the pressure at the point chosen for measurement, divide it by the M.E.P. and multiply the quotient by $F-X$, or by the ratio of the horizontal line across the diagram to the total length of the diagram. When points on the expansion and compression lines are at different heights the other process will be more convenient.

TABLE VII
VALUE OF $\frac{13750}{\text{M.E.P.}}$

M.E.P. Lbs.	$\frac{13750}{\text{M.E.P.}}$	M.E.P. Lbs.	$\frac{13750}{\text{M.E.P.}}$	M.E.P. Lbs.	$\frac{13750}{\text{M.E.P.}}$	M.E.P. Lbs.	$\frac{13750}{\text{M.E.P.}}$	M.E.P. Lbs.	$\frac{13750}{\text{M.E.P.}}$
101	136.1	131	104.9	161	85.4	191	71.9	221	62.2
102	134.8	132	104.1	162	84.8	192	71.6	222	61.9
103	133.4	133	103.3	163	84.3	193	71.2	223	61.6
104	132.2	134	102.6	164	83.8	194	70.8	224	61.3
105	130.9	135	101.8	165	83.3	195	70.5	225	61.1
106	129.7	136	101.1	166	82.8	196	70.1	226	60.8
107	128.5	137	100.3	167	82.3	197	69.7	227	60.5
108	127.3	138	99.6	168	81.8	198	69.4	228	60.3
109	126.1	139	98.9	169	81.3	199	69.0	229	60.0
110	125.0	140	98.2	170	80.8	200	68.7	230	59.7
111	123.8	141	97.5	171	80.4	201	68.4	231	59.5
112	122.7	142	96.8	172	79.9	202	68.0	232	59.2
113	122.6	143	96.1	173	79.4	203	67.7	233	59.0
114	120.6	144	95.4	174	79.0	204	67.4	234	58.7
115	119.5	145	94.8	175	78.5	205	67.0	235	58.5
116	118.5	146	94.1	176	78.1	206	66.7	236	58.2
117	117.5	147	93.5	177	77.6	207	66.4	237	58.0
118	116.5	148	92.9	178	77.2	208	66.1	238	57.7
119	115.5	149	92.2	179	76.8	209	65.7	239	57.5
120	114.5	150	91.6	180	76.3	210	65.4	240	57.2
121	113.6	151	91.0	181	75.9	211	65.1	241	57.0
122	112.7	152	90.4	182	75.5	212	64.8	242	56.8
123	111.7	153	89.8	183	75.1	213	64.5	243	56.5
124	110.8	154	89.2	184	74.7	214	64.2	244	56.3
125	110.0	155	88.7	185	74.3	215	63.9	245	56.1
126	109.1	156	88.1	186	73.9	216	63.6	246	55.8
127	108.2	157	87.5	187	73.5	217	63.3	247	55.6
128	107.4	158	87.0	188	73.1	218	63.0	248	55.4
129	106.5	159	86.4	189	72.7	219	62.7	249	55.2
130	105.7	160	85.9	190	72.3	220	62.5	250	55.0

TABLE VIII
VALUES OF 13,750w

T.P.	0	1	2	3	4	5	6	7	8	9
3	117.300	121.015	124.717	128.406	132.083	135.748	139.399	143.075	146.665	150.279
4	153.880	157.514	161.137	164.750	168.353	171.945	175.527	179.098	182.659	186.210
5	189.750	193.336	196.914	200.483	204.044	207.598	211.142	214.679	218.208	221.728
6	225.240	228.799	232.351	235.897	239.437	242.970	246.497	250.017	253.531	257.039
7	260.540	264.956	267.566	271.071	274.570	278.063	281.550	285.031	288.506	291.976
8	295.440	298.922	302.400	305.872	309.338	312.800	316.256	319.708	323.154	326.594
9	330.030	333.488	336.941	340.389	343.833	347.273	350.707	354.137	357.563	360.984
10	364.400	367.842	371.280	374.714	378.144	381.570	384.992	388.410	391.824	395.234
11	398.640	402.064	405.485	408.902	412.315	415.725	419.131	422.534	425.933	429.328
12	432.720	436.120	439.517	442.911	446.301	449.688	453.071	456.451	459.828	463.200
13	466.570	469.950	473.326	476.699	480.068	483.435	486.798	490.159	493.516	496.869
14	500.220	503.596	506.968	510.338	513.706	517.070	520.432	523.790	527.146	530.500
15	533.850	537.213	540.573	543.930	547.285	550.638	553.987	557.334	560.679	564.011
16	567.360	570.713	574.063	577.411	580.757	584.100	587.441	590.780	594.115	597.449
17	600.780	604.109	607.435	610.759	614.081	617.400	620.717	624.031	627.343	630.653
18	633.960	637.265	640.567	643.867	647.165	650.460	653.753	657.043	660.331	663.617
19	666.900	670.200	673.498	676.793	680.086	683.378	686.666	689.953	693.238	696.520
20	699.800	703.098	706.394	709.688	712.980	716.279	719.558	722.844	726.128	729.410
21	732.690	735.968	739.244	742.518	745.790	749.060	752.328	755.594	758.858	762.120
22	765.380	768.660	771.938	775.215	778.490	781.763	785.034	788.303	791.570	794.836
23	798.100	801.362	804.622	807.881	811.138	814.393	817.646	820.897	824.146	827.334
24	830.640	833.908	837.175	840.440	843.703	846.965	850.225	853.484	856.741	859.996
25	863.200	866.502	869.753	873.002	876.249	879.495	882.739	885.982	889.223	892.462
26	895.750	898.936	902.171	905.404	908.635	911.865	915.093	918.320	921.545	924.768
27	927.990	931.210	934.429	937.646	940.831	944.075	947.287	950.498	953.707	956.914
28	960.120	963.352	966.583	969.813	973.041	976.268	979.493	982.717	985.939	989.160
29	992.380	995.598	998.815	1002.031	1005.245	1008.458	1011.669	1014.879	1018.087	1021.294
30	1024.500	1027.704	1030.907	1034.109	1037.309	1040.508	1043.705	1046.901	1050.095	1053.288
31	1056.840	1059.670	1062.859	1066.047	1069.233	1072.418	1075.601	1078.783	1081.963	1085.142

TABLE VIII—Continued
VALUES OF 13,750w

T.P.	0	1	2	3	4	5	6	7	8	9
32	1088.320	1091.528	1094.736	1097.942	1101.146	1104.350	1107.552	1110.754	1113.954	1117.152
33	1120.250	1123.546	1126.742	1129.936	1133.128	1136.420	1139.510	1142.700	1145.888	1149.074
34	1152.260	1155.444	1158.628	1161.810	1164.990	1168.170	1171.348	1174.526	1177.702	1180.876
35	1184.050	1187.222	1190.394	1193.564	1196.732	1199.900	1203.066	1206.232	1209.396	1212.558
36	1215.720	1218.917	1222.112	1225.307	1228.500	1231.693	1234.884	1238.075	1241.264	1244.453
37	1247.640	1250.827	1254.012	1257.197	1260.380	1263.563	1266.744	1269.925	1273.104	1276.283
38	1279.460	1282.637	1285.812	1288.987	1292.160	1295.333	1298.504	1301.675	1304.844	1308.013
39	1311.180	1314.347	1317.512	1320.677	1323.840	1327.003	1330.164	1333.325	1336.484	1339.643
40	1342.800	1345.957	1349.112	1352.267	1355.420	1358.573	1361.724	1364.875	1368.024	1371.173
41	1374.320	1377.467	1380.612	1383.757	1386.900	1390.043	1393.184	1396.325	1399.464	1402.603
42	1405.740	1408.877	1412.012	1415.147	1418.280	1421.413	1424.544	1427.675	1430.804	1433.933
43	1437.060	1440.230	1443.398	1446.566	1449.734	1452.900	1456.066	1459.230	1462.394	1465.558
44	1468.720	1471.882	1475.042	1478.202	1481.362	1484.520	1487.678	1490.834	1493.990	1497.146
45	1500.300	1503.454	1506.606	1509.758	1512.910	1516.060	1519.210	1522.359	1525.506	1528.654
46	1531.800	1534.946	1538.090	1541.234	1544.378	1547.520	1550.662	1553.802	1556.942	1560.082
47	1563.220	1566.358	1569.494	1572.630	1575.766	1578.900	1582.034	1585.166	1588.298	1591.430
48	1594.560	1597.690	1600.818	1603.946	1607.074	1610.200	1613.326	1616.450	1619.574	1622.698
49	1625.820	1628.942	1632.062	1635.182	1638.302	1641.420	1644.538	1647.654	1650.770	1653.886
50	1657.000	1660.114	1663.266	1666.338	1669.450	1672.560	1675.670	1678.778	1681.886	1684.994
51	1688.100	1691.206	1694.310	1697.414	1700.518	1703.620	1706.722	1709.822	1712.922	1716.022
52	1719.120	1722.218	1725.314	1728.410	1731.506	1734.600	1737.694	1740.786	1743.878	1746.970
53	1750.060	1753.150	1756.238	1759.327	1762.414	1765.500	1768.586	1771.670	1774.754	1777.838
54	1780.920	1784.002	1787.082	1790.162	1793.242	1796.320	1799.398	1802.474	1805.550	1808.626
55	1811.700	1814.829	1817.957	1821.084	1824.211	1827.338	1830.463	1833.588	1836.713	1839.837
56	1842.960	1846.083	1849.205	1852.326	1855.447	1858.568	1861.687	1864.806	1867.925	1871.043
57	1874.160	1877.277	1880.393	1883.508	1886.623	1889.738	1892.851	1895.964	1899.077	1902.189
58	1905.300	1908.411	1911.521	1914.630	1917.739	1920.848	1923.955	1927.062	1930.169	1933.275
59	1936.380	1939.485	1942.589	1945.692	1948.795	1951.898	1954.999	1958.100	1961.201	1964.301
60	1967.400	1970.499	1973.597	1976.694	1979.791	1982.888	1985.983	1989.078	1992.173	1995.267

CHAPTER XVI

DIAGRAMS FROM COMPOUND ENGINES, CLEARANCE NEGLECTED

So far as taking the diagrams from a compound engine, figuring the horse-power, the water accounted for, etc., the directions already given will suffice. The diagram will be taken just as though the cylinder operated upon were the only one concerned, the selection of the spring being governed by the range of pressures in that cylinder and convenience in reducing the diagrams to a common scale, as will be explained. The indicated horse-power is found by computing the horse-power of each cylinder in the ordinary manner from its own diagrams and adding the indicated horse-power of the several cylinders for the total power of the engine. The steam accounted for per horse-power per hour is obtained by referring the mean effective pressures of the several cylinders to the cylinder in which the pressure used for the computation is measured, as explained in the chapter on steam consumption from the diagram. Each diagram is a representation of the distribution and use of steam in the conditions of its own cylinder, and may be studied in connection with a theoretical diagram for these conditions, just as a diagram from a single cylinder engine would.

In order to study the action of the steam in the engine as a whole, however, and to compare it with an ideal expansion of steam through the range adopted, the diagrams must be studied in their relation to one another, and this involves their reconstruction in several particulars. In the first place, to be comparable, the diagrams must be upon the same scale. For the high pressures used in the initial cylinder of compound engines a stiff spring must be used. In order to get a large diagram on the low-pressure cylinder a spring of lower scale is used. When we wish to compare the resulting diagrams we must reduce them to the same scale, and as we can work more accurately upon a large than a small scale, it is preferable to increase the height of the high-pressure diagram to that which it would have been if taken with the same spring as the other.

Suppose we have a compound engine with the low-pressure cylinder twice the diameter of the high, cutting off at a quarter stroke in both cylinders, with a boiler pressure of 160 pounds absolute and 26 inches

of vacuum, the stroke of both cylinders being equal; and that from this engine we had got the diagrams, Fig. 112, with an 80 scale, and Fig. 113, with a 20 scale. Neglecting for the present the influence of clearance, let us combine them so as to show the continuous action of the steam in the whole engine.

If the high-pressure diagram had been taken with a 20 instead of an 80 spring every point upon it would have been $\frac{80}{20} = 4$ times as high above the atmospheric line as the diagram shows it. The first step, therefore, is to redraw this diagram four times its present height. Divide the diagram into a convenient number of equal parts and erect

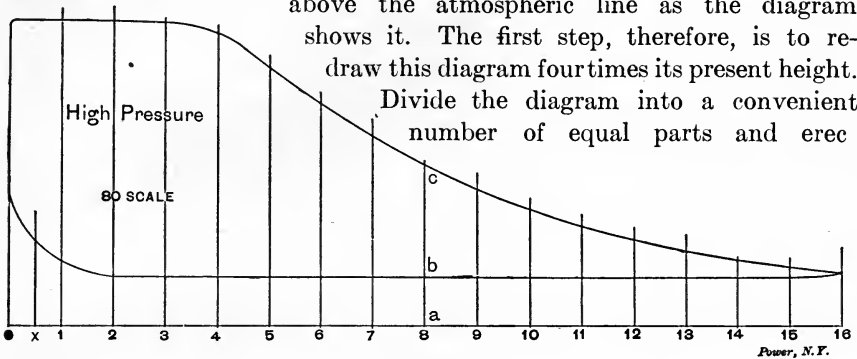

FIG. 112.

ordinates upon the divisions. In Fig. 112 sixteen spaces have been used, as they are easily obtained by successive halvings; or the spacing may be done by using the scale diagonally across the diagram, as in Fig. 74. Measure the distances from the atmospheric line to the forward- and backward-pressure lines of the diagram on each ordinate, and transfer these distances, multiplied by four, to the corresponding ordinate upon the larger diagram.

On ordinate 8, for example, the distances *AB* and *AC* in Fig. 114 are four times the distances *ab* and *ac* on the cor-

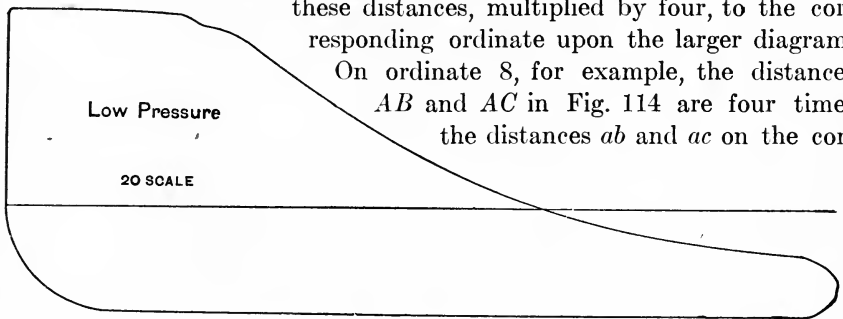

FIG. 113.

responding ordinate in Fig. 112. A pair of proportional dividers will be found convenient for this work. Drawing a line through the points thus indicated, we obtain the diagram shown in Fig. 114. Where sudden changes of pressure occur, so that it would be difficult to draw the line correctly between points so far apart, additional ordinates may be put

in, as at x , Fig. 112, putting an ordinate in the same position on the reconstructed diagram.

We can now consider the diagrams somewhat in their relation one to another by placing them together, as shown in Fig. 114, where to the low-pressure diagram is just as it was drawn by the indicator. The steam is expanded to about 40 pounds, exhausts into the receiver, and the space between the back-pressure line of the high-pressure diagram and the steam line of the low-pressure shows the loss in going through the ports and receiver between the two cylinders.

But even now we are not able to compare the diagrams with a theoretical diagram showing the expansion of the steam from the initial pressure to the terminal in the low-pressure cylinder. To do this they must be reduced to the same scale of volumes.

If the area of the high-pressure piston was one square foot, then every foot of movement of that piston would expand the steam behind it one cubic foot.

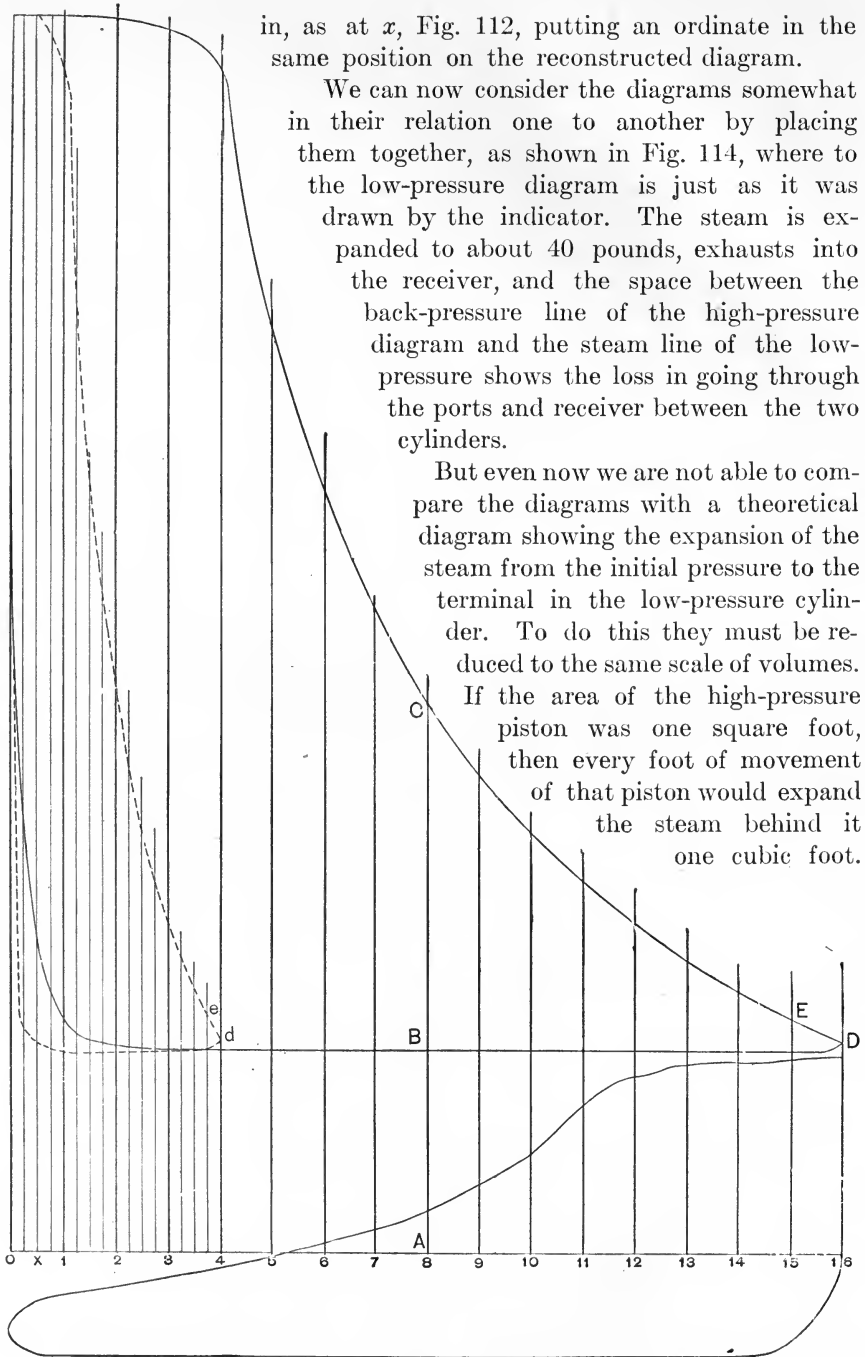

FIG. 114.

If the low-pressure piston has twice the diameter of the high it would have four times the area, and each foot of movement of the low-pressure piston would add four cubic feet to the volume of the steam. One foot of movement of the low-pressure piston is equal, then, to four feet of the high; and since the movement of the piston is represented by the length of the diagram, the high-pressure diagram, to be comparable to the low, should be only one-fourth the length of the low-pressure diagram.

This calculation has been made on the assumption that the larger cylinder had twice the diameter of the smaller and that the strokes were equal. In general the diagrams should be to each other in length as the volumes of their respective cylinders. The volume of the cylinder (clearance neglected) is the cross-sectional area multiplied by the length of the stroke; the area is the square of the diameter multiplied by 0.7854. Then letting

- d = diameter high-pressure cylinder;
- D = " low-pressure cylinder;
- l = length stroke high-pressure cylinder;
- L = " " low-pressure cylinder;

the ratio of the lengths of the diagrams would be

$$\frac{d^2 \times 0.7854 \times l}{D^2 \times 0.7854 \times L}$$

The decimals cancel, and as the stroke is ordinarily the same in both cylinders the lengths usually cancel also, so that usually the ratio of the diagram length is

$$\frac{d^2}{D^2}$$

In our case we found this ratio to be $\frac{1}{4}$, that is, the high-pressure diagram must be $\frac{1}{4}$ as long as the low.

Lay off on the admission end of the enlarged diagram, Fig. 114, a length

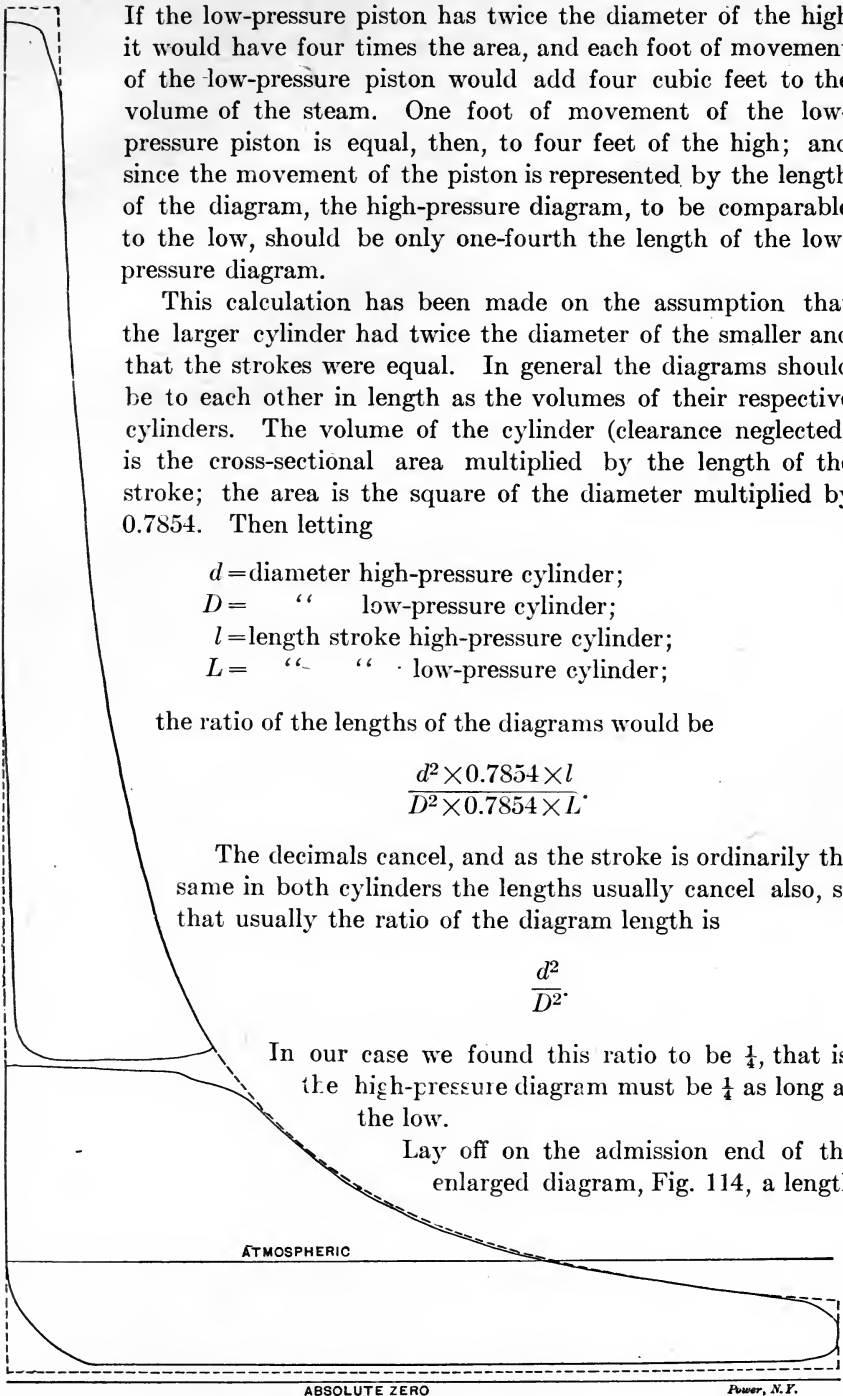

Fig. 115.

equal to $\frac{1}{4}$ the length of the low-pressure diagram, divide it into as many spaces as the original diagram was at first divided, 16 in this case, and erect ordinates as shown. Then transfer the pressure on the ordinates of the large diagram to the corresponding ordinates of what will be the shortened diagram. For instance, we made a dot d on the last ordinate of the shortened diagram at the same height as the point D , where the line touches the last ordinate of the large diagram; another at e on the second ordinate; counting from the right, at the same height as E on the corresponding ordinate of the large diagram; and so on for both the forward and back pressure lines upon all the sixteen ordinates. Connecting these points we get the diagram shown by the dotted line, as though it had been taken with a 20 spring and only one quarter the movement to the paper barrel that the low-pressure diagram had. If this diagram is placed above the low-pressure diagram, as in Fig. 115, we have a representation of the continuous action of the steam and can draw about it the theoretical diagram, as shown by the dotted line, showing how much of the inclosed area is covered by the diagram from the engine, and how nearly perfect the utilization of the steam has been.

CHAPTER XVII

DIAGRAMS FROM COMPOUND ENGINES, CLEARANCE CONSIDERED

In the last chapter was described the combination of diagrams from the various cylinders of a compound engine so as to be comparable with an equivalent action of the steam in a single cylinder.

Clearance was neglected for the sake of simplicity, but it now becomes necessary to proceed to the consideration of the effect of clearance in such a combination. Its treatment is shown in Fig. 116 for a two-cylinder engine in which the diameters of the cylinders are as 2 to 1, making the volumes for equal strokes as 4 to 1. In the low-pressure cylinder the clearance is $\frac{1}{12}$, or $8\frac{1}{2}$ per cent of the displacement.

Draw the line of zero pressure, perfect vacuum OX , Fig. 116, and at a distance ab ($=\frac{1}{12}$ the length of the low-pressure diagram) from the admission line erect the line OA of zero volume. Then set the reconstructed high-pressure diagram at such a distance from the line OA that the clearance space cd shall be the proper percentage of the length de of that diagram. In other words, add the clearance line in the usual manner to the reconstructed diagrams, and in combining make the clearance lines coincide.

Let us consider a little further the action of steam in compound engines, using for the purpose conventional or theoretical diagrams drawn upon

the same scales for both cylinders. Let us take first the engine with no receiver but with the high-pressure

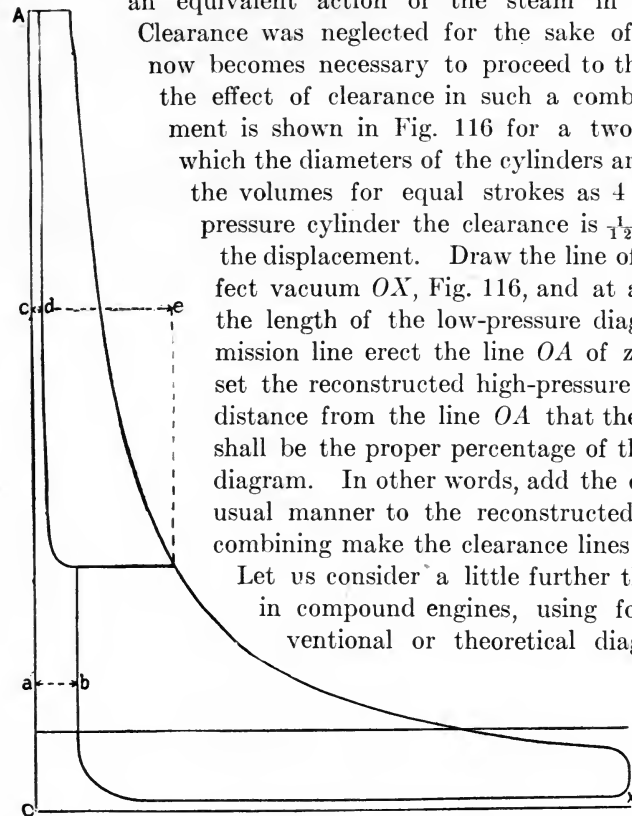

FIG. 116.

exhausting directly into the low, and the pistons moving together, as in a tandem, or with equal opposite movements, as with a cross-compound the cranks of which are opposite. Suppose the cut-off to take place in the

high-pressure cylinder at one-quarter stroke, *C*, Fig. 117, in which case the steam would be expanded to the terminal pressure *T*, say 30 pounds. Now suppose a valve as at *A*, Fig. 118, between the two cylinders, to open, and the pistons to commence to move toward the left. As the area of the low-pressure cylinder is four times as great as that of the high, every inch of movement will add four times the volume in the low-pressure cylinder that is taken up by the forward movement of the high-pressure piston. When, for instance, the pistons have made one-quarter of their

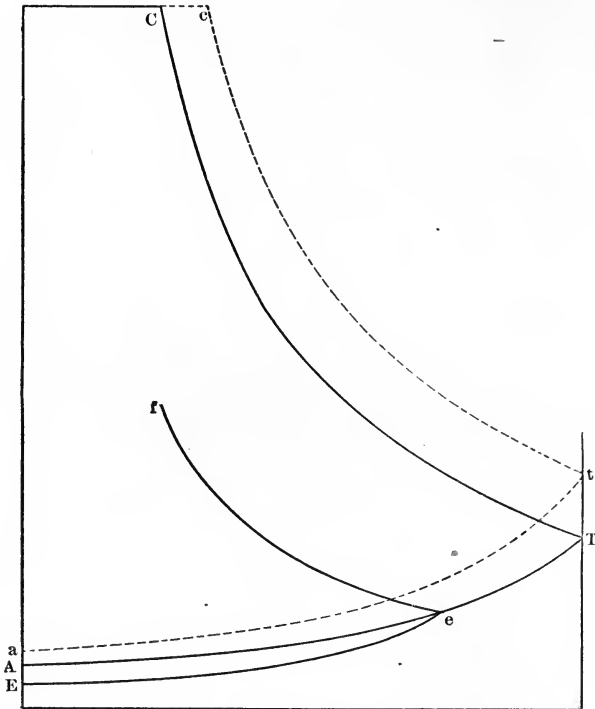

FIG. 117.

stroke, and are in the position shown, the steam will still have three-quarters as much room to occupy in the high-pressure cylinder as it had before the return stroke was commenced, and in addition it will have one-quarter of the low-pressure cylinder. As the low-pressure has four times the volume of the high, the steam will have in one-quarter of the low-pressure as much room as it had in the high-pressure cylinder at the end of the forward stroke, besides the three-quarters of its original volume, still left in the high-pressure cylinder. Its volume has, therefore, at the point under consideration, been expanded to $1\frac{3}{4}$ that at the

termination of the forward stroke, and knowing that the pressure is inversely as the volume (see Chapter on Expansion Line), we divide the terminal pressure 30, by $1\frac{3}{4}$, and find a little over 17 pounds as the pressure at the point *e*, Fig. 117. Locating the pressure at the other points in the same manner, we find that the back pressure on the high-pressure piston, which in this case would also be the forward-pressure on the low-

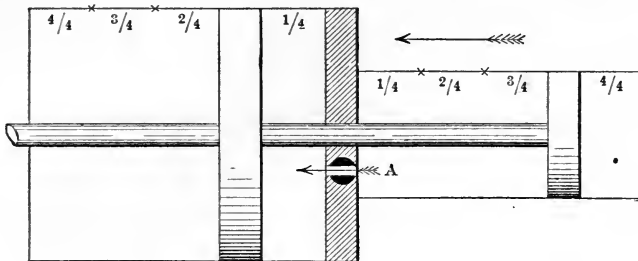

FIG. 118.

pressure, would follow the line *TA*, Fig. 120, with an uninterrupted passage of the steam between the cylinders throughout the stroke.

If the point of cut-off in the high-pressure cylinder were to change, it would change the terminal pressure *T* in that cylinder, and correspondingly increase or diminish the initial pressure in the low. Instead of cutting off at *C*, Fig. 117, one-quarter of the stroke, the steam were cut

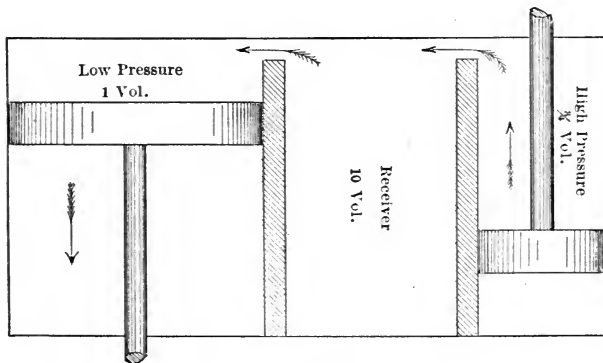

FIG. 119.

off at *c*, one-third of the stroke, the terminal pressure would be *t* instead of *T*, and the back-pressure line of the high-pressure diagram, which is at the same time the steam line of the low-pressure diagram, would be *ta*. If, on the other hand, the cut-off is earlier in the high-pressure, the initial for the low-pressure will be lowered and less work will be done in that cylinder.

Now suppose that instead of remaining open, the valve *A*, Fig. 118, between the cylinders, closed at quarter stroke, giving a one-quarter cut-off in the low-pressure cylinder as well as in the high. This would carry the expansion line of the low-pressure along the line *eE*, but it would shut up the exhaust of the high-pressure cylinder, and compression would commence at *e*, running the back-pressure line rapidly up in the direction *ef*.

Now suppose that instead of exhausting directly into the low-pressure

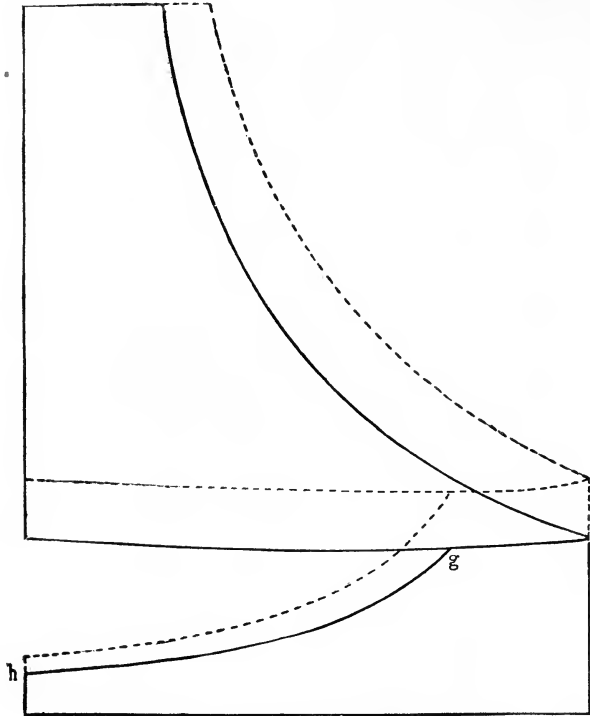

FIG. 120.

cylinder the high-pressure exhausts into a receiver or reservoir, from which the low-pressure takes its supply, as in Fig. 119.

This receiver can be so large in proportion to the cylinders that the fluctuations in the quantity of steam taken from and delivered to it during the stroke will affect the pressure but little. Understand that the low-pressure cylinder must take out of the receiver as much steam as the high-pressure delivers to it. It is obvious that it cannot continuously take out more and if it does not take out as much the steam would accumulate in the receiver and raise the pressure until the volume

taken by the low-pressure contained as much steam as the high-pressure was delivering. Suppose the capacity of the receiver to be ten times that of the high-pressure cylinder. At the beginning of the stroke there will be one volume in the high-pressure cylinder and ten volumes in the receiver of steam at the terminal pressure $T=30$ pounds, 11 volumes in all. At quarter stroke, Fig. 118, there will be three-quarters of a volume in the high-pressure, ten volumes in the receiver, and one volume in the low, one-quarter of the low-pressure cylinder being equal to the whole

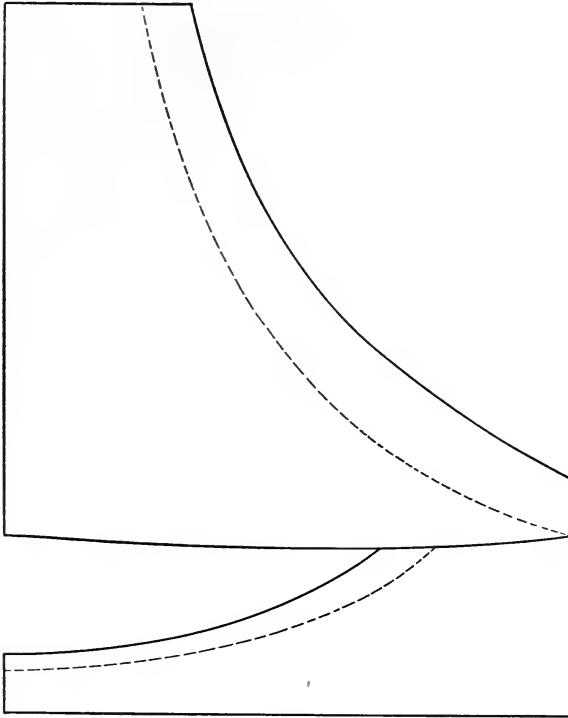

FIG. 121.

volume of the high, $11\frac{3}{4}$ volumes in all. The pressure will have fallen then to only $\frac{11}{11.75}$ of the original 30, or to a little over 28 pounds, as at g , Fig. 120, instead of to 17, as at e , Fig. 117. Suppose now the valve A , Fig. 118, to close, i.e., cut-off to occur on the low-pressure cylinder. The expansion in that cylinder would follow the line gh , Fig. 120, while the high-pressure cylinder would continue to exhaust into the receiver, and at the end of the stroke would have taken back that excess of three-quarters of a volume which it had when cut-off occurred on the low-

pressure, and brought the pressure back from 28 to 30 pounds, the counter-pressure following the line *gi*.

Suppose a heavier load to come on the engine, changing the point of cut-off from one-quarter to one-third stroke. First let us consider the effect with a fixed cut-off on the low-pressure cylinder, which we will allow to remain at one-quarter stroke. The result is shown by the dotted diagram in Fig. 120. The greater portion of the increase of load is taken by the low-pressure cylinder, on which the cut-off has not changed, the area gained by the later cut-off in the high-pressure cylinder being largely offset by the loss of area due to the increase of back pressure through the higher terminal. Notice also that with the low-pressure cut-off set at one-quarter, the volume which the low-pressure cylinder takes out of the receiver each stroke just equals the volume delivered to it by the high-pressure, so that whatever the terminal pressure, the high-pressure diagram will end in a point.

Suppose now there had been an automatic cut-off on both cylinders, and that the low-pressure cut-off changed to one-third stroke too. The low-pressure cylinder has four times the volume of the high. One-third of the low would have $\frac{1}{3} \times 4 = 1\frac{1}{3}$ times the volume of the high, so that for every cubic foot of steam that the high-pressure cylinder delivers to the receiver the low-pressure cylinder takes out $1\frac{1}{3}$ cubic feet. Since there is a greater volume going out of the receiver than there is going into it, the pressure will fall until the greater volume taken out by the low-pressure cylinder contains only the same quantity or weight of steam as that delivered in a smaller volume by the high-pressure cylinder. In other words, the receiver pressure will fall until the cylinderful of steam delivered to the receiver at 40 pounds will expand to $1\frac{1}{3}$ times its volume in the receiver, which should require a receiver pressure of $40 \div 1\frac{1}{3} = 30$ pounds. We should therefore have a diagram like Fig. 121, where the dotted lines represent both cylinders cutting off at one-quarter stroke, the full lines, both cylinders cutting off at one-third stroke.

CHAPTER XVIII

ERRORS IN THE DIAGRAM

IN treating of the reducing motion we have described in kind the various errors to which it is liable. It now remains to consider them in degree. Fig. 122 shows the error which would result from taking

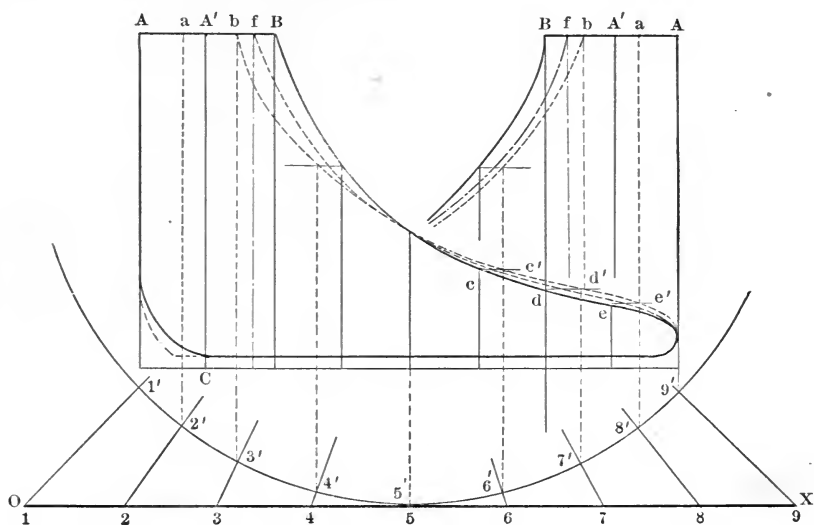

FIG. 122.

the motion from a pin on a lever like Fig. 123, vibrating through about 90° . A diagram which should follow the full line would be distorted by this arrangement to that shown by the dotted lines. The cut-off would appear too early, the expansion line would hold up too much for the apparent cut-off, but would be below its proper position in the first of the stroke, crossing the correct line at the center, and making the terminal appear higher than it should be. It makes the release and compression appear late and reduces the area of the diagram, and hence the apparent indicated horse-power. Both the right- and left-handed diagrams, i.e., those from the head and the crank end, are affected the same way. When you see a diagram which resembles the dotted one in Fig. 122, look over the reducing motion.

As just stated, Fig. 122 was drawn upon the assumption that the lever vibrated through 90° . This is excessive. It is recommended to use a lever not less than one and a half times the length of the stroke. This gives a vibration between 35° and 40° . In Fig. 124 is shown the distortion due to using a lever like Fig. 123, one and a half times the length of the stroke, taking the motion from a pin in the lever, and a cord led off parallel to the guides.

The distortion is much less than with the shorter lever, and the purpose for which the diagram is taken must determine whether this amount can be tolerated for the sake of simplicity in the reducing motion. When we measure for a carpet we do not take into account

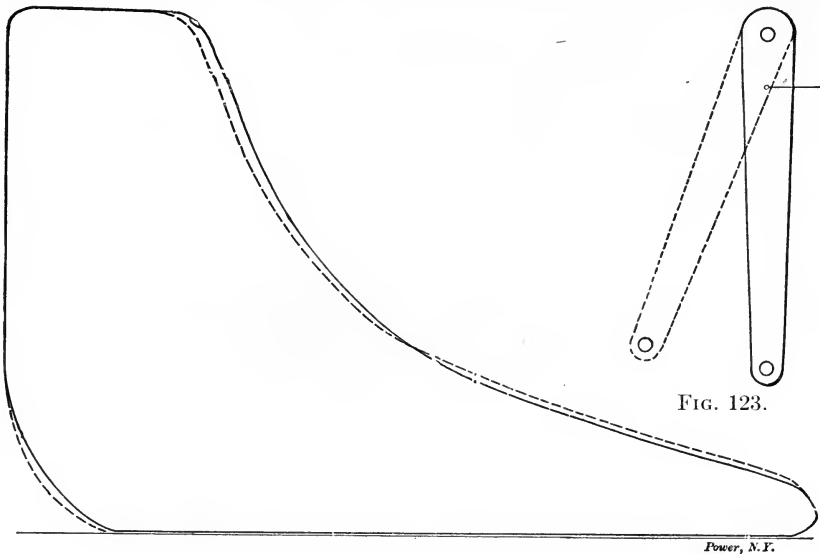

FIG. 124.

the fractions of an inch, and when we weigh coal we do not pay attention to the ounces. In ordinary indicating to see that the valve gear has not become deranged, to make a rough cast of the power for purposes of record, etc., we need not be so precise as though we were testing a cruiser, when the difference of one pound mean effective pressure would mean ten thousand dollars to the builders; or a steam plant where a few horse-power more or less would determine for or against the guarantee; or when with Hirn, we undertake to trace from the diagram the distribution and disposition of the heat units going through the plant. This is when the indicator and its user must get right down to extreme accuracy, and after every precaution is used the results will still be too far from the truth. This motion cannot be corrected by

the use of a brumbo pulley, for the pulley would not move through equal arcs for equal movements of the cross-head. It would pull the cylinder a distance equal to 4', 5', Fig. 122, in the middle of the stroke, and only that equal to 1', 2', etc., at the ends, so that instead of being equally divided for equal movements of the piston the diagram would be divided irregularly, as are the spaces on the arc. If this arc were straightened out, reduced to the length of the diagram without disturbing the proportion of the spacing, corresponding ordinates, as 3' *f*, erected, and the pressure transferred to these from the proper ordinates, as from *B* to *f*, we should get the diagram represented by the broken

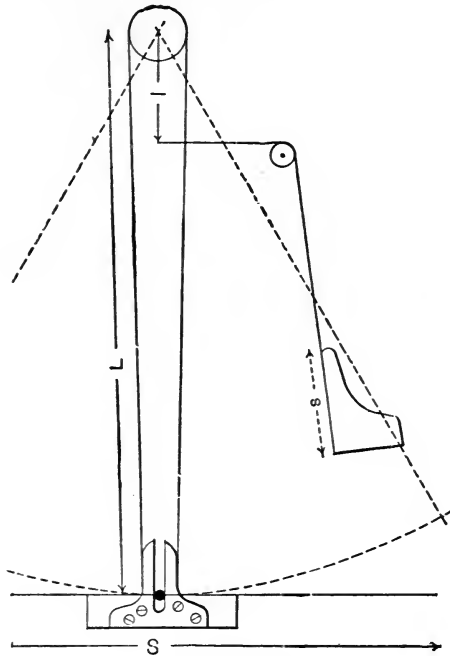

FIG. 125.

line, showing that the use of the arc is productive of greater accuracy in this case. With a lever of constant length, as in Fig. 125, however, the use of the arc introduces an error. (See chapter on reducing motions.)

Leading the cord away from the reducing motion in any other direction than parallel with the guides introduces an error. Let us see how much. Suppose we have a pantograph, as in Fig. 126, or a reducing wheel, as in Fig. 127, and that instead of leading the cord off in the direction *AB* parallel with the guides, we led it off in the direction shown, the angle being 30° when the cross-head is nearest to the cylinder.

The resulting distortion of the diagram will be that shown in Fig. 128. When the piston has traveled one-eighth of its stroke the pencil, which should be at *A*, will be *a*, and so on for the other ordinates. Notice that this makes the apparent cut-off earlier on the head-end and later on the crank-end. At all times and in both directions the travel of the paper-drum is less than it should be, altogether it looks to be more when traveling to the right. Thus, starting with *O* at the right the pin on the pantograph, when the engine cuts off at quarter stroke, will have moved a distance equal to *O2*, but the movement of the paper-drum will be equal to *OC* only. When the stroke is completed the pantograph pin has traveled through a distance equal to *OS*, but the paper-drum has traveled through *OD*, the comparative movement of the pantograph pin and the paper-drum for successive eighths of the

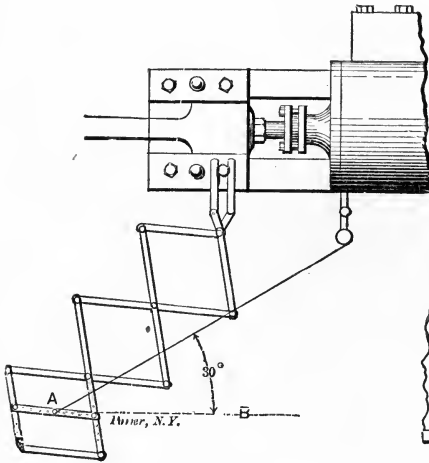

FIG. 126.

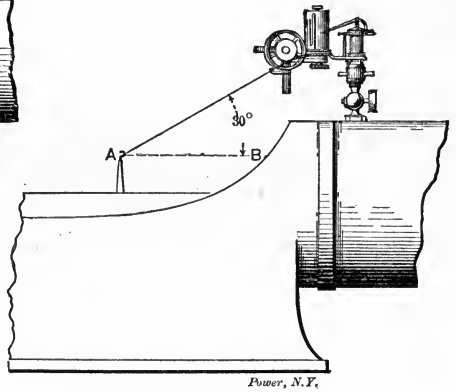

FIG. 127.

stroke, being shown by the bold-faced figures 1, 2, 3, etc., and the dotted ordinates to the right of them. The full-line ordinates are placed upon the equal eighths of the shortened diagram *OD*. Starting at *D* backward the pantograph pin would move in the first eighth of the stroke to 1, in the second eighth to 2, etc. The corresponding position of the pencil on the paper would be at the dotted ordinates as before, a less distance, it will be seen, than the actual movement in every case; but when we come to erect the full-line ordinates on the even eighths of the shortened diagram they fall behind the dotted lines, showing how we can get an apparently excessive movement on the crank end with a movement really less than it should be. Notice that the distortion due to this cause tends to throw the card out of balance, affecting the dia-

grams from the head- and crank-ends in different directions, not in the same way as did the distortion of the lever motion in Fig. 122.

Another source of error in the diagram, briefly referred to before, is that due to a long and indirect passage from the cylinder to the indicator. The errors introduced are: less realized pressure, lower compression and higher terminal. This subject has been discussed in the various technical papers, and varying opinions have been elicited. In order to determine this question, the author, in connection with Mr. A. C. Lippincott, undertook the tests resulting in the diagrams shown in Figs. 129 to 138. We designed the apparatus shown in Fig. 129.

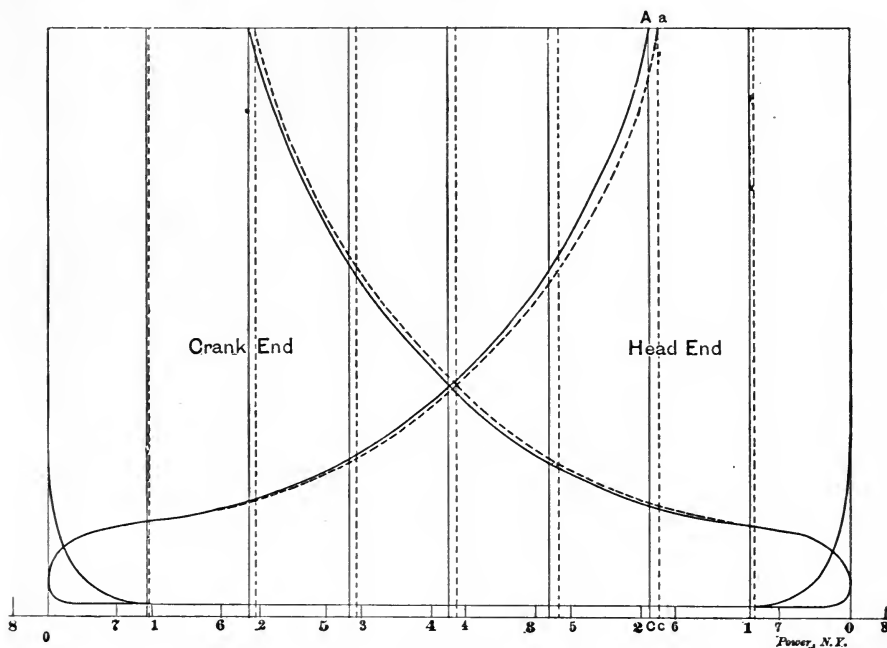

FIG. 128.

Our first test was made on an 11×11 Ball & Wood engine at the Roosevelt Building, New York, through the courtesy of Mr. Thomas Murphy, the engineer in charge. The engine was running at 270 revolutions per minute, driving an electric generator with a very constant load, so constant that when the pencil was held on for 20 revolutions the line of the diagram was scarcely thickened. Three and a half feet of half-inch pipe connected the cross *F* with the tee *G*, and a similar length was used between *E* and *H*, the right and left nipple *I* being about 7 inches long. This pipe was thoroughly heated and drained before each card was taken, by turning the three-way cock, so that steam could issue

through the little escape orifice, opening the drips and the cock *B*, the engine running continuously.

Having taken a diagram with the direct connection, the three-way cock was reversed and the cock *B* opened, compelling the steam to travel through the loop of about 8 feet of $\frac{1}{2}$ -inch pipe and fittings to the indicator. The result is shown in Fig. 130. The pencil was allowed to pass over the card 20 revolutions as before, to insure that the diagram was not erratic or exceptional. This experiment was repeated over and over again. Whenever we switched to the direct connection we got Fig.

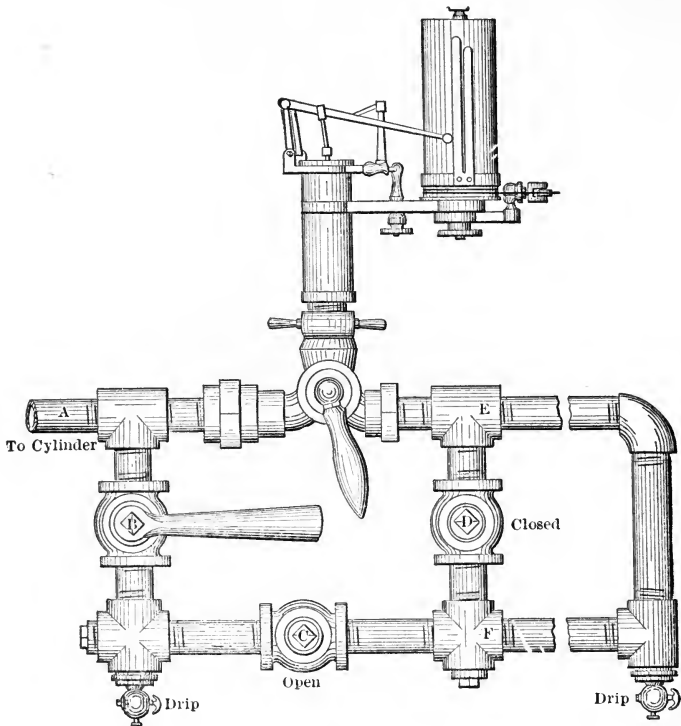

FIG. 129.

131, whenever with the direct connection we opened the connection to the piping, we got Fig. 132; and when the steam was compelled to pass around to the further side of the three-way cock to get to the indicator we got Fig. 130. The passages through the pipes and fittings were perfectly clear, and ordinary $\frac{1}{2}$ -inch plug cocks, half-inch fittings and the three-way cock regularly supplied with the indicator were used. The nipple *A* is screwed into the hole in the cylinder ordinarily provided for the indicator cock. When the handle of the three-way cock is

thrown to the right, as in the drawing, the steam enters the cock from the left and has a direct passage to the indicator, and if the plug cock

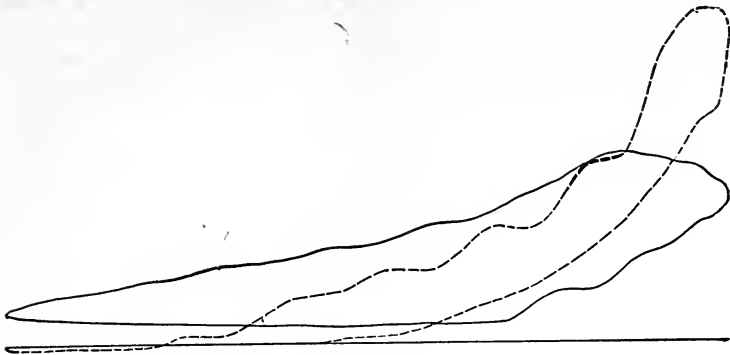

FIG. 130.

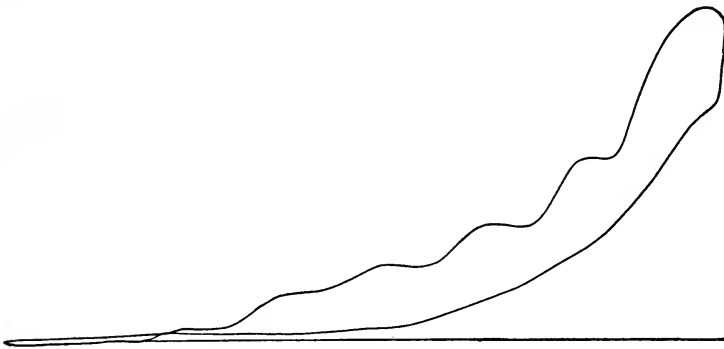

FIG. 131.

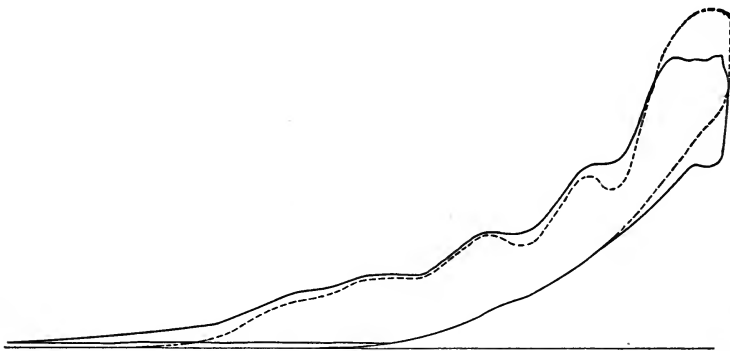

FIG. 132.

B is closed the steam has no access to the extraneous piping, and the indicator is about as directly connected as it would be with the usual

nipple elbow and single cock. The plug cock *C* is open and *D* is closed, so that when *B* is opened steam can pass clear around the loop and enter the three-way cock at the right, as it must do to get to the indicator when the handle of the three-way cock is swung the other way. Any sort of a circuit of piping, steam hose, or fittings may be connected at *EF* for the steam to pass through on its way to the indicator. The handle of the three-way cock can also be left so as to give the steam a direct passage to the indicator and the cock *B* left open so as to obtain the effect of the addition to the clearance without the friction of the pipe.

Fig. 129 shows the apparatus as applied to a cylinder tapped at the side as are engines of the Corliss type. For engines tapped on top of

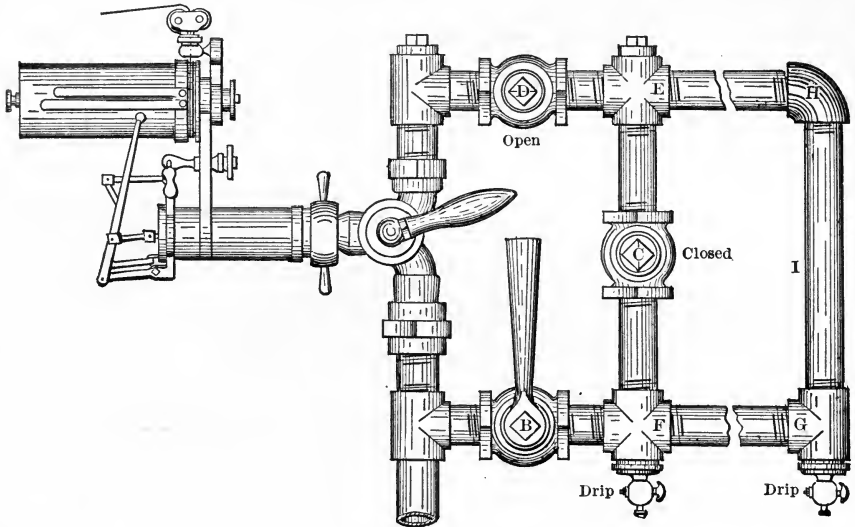

FIG. 133.

the cylinder it is turned as shown in Fig. 133, which will explain the necessity of the cocks *C* and *D*.

Fig. 134 is a card on which all three diagrams were taken as quickly as the cocks could be shifted. Through the kindness of Mr. Gillespie, in charge of the steam plant of the Young Women's Christian Association Building, we were able to repeat the experiment on a 12×12 New York Safety engine, which also ran at 270 revolutions, but was more heavily loaded. This load was also electrical and very steady, Fig. 135 being its diagram with the direct connection and 35 passages of the pencil.

Fig. 136 shows very prettily the effect of added clearance obtained by opening the cock *B*, leaving the passage to the indicator still direct.

Fig. 137 shows the diagram obtained with the indirect connection, the pencil passing 25 times over.

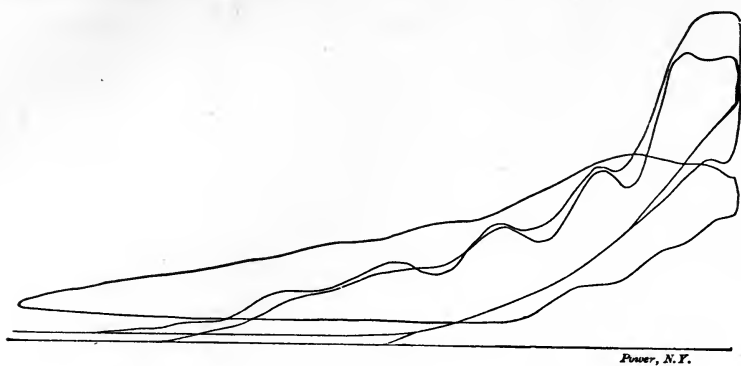

FIG. 134.

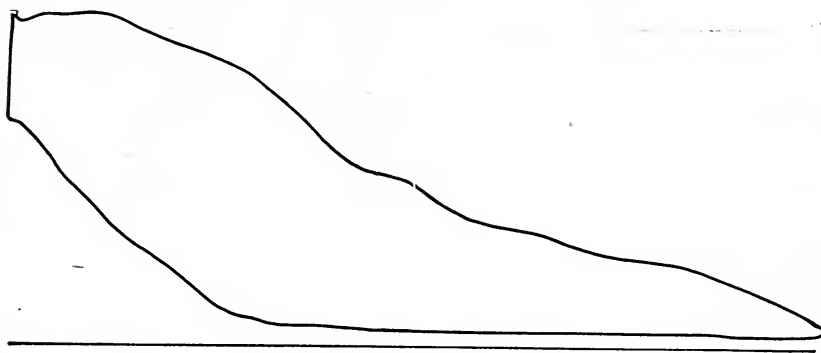

FIG. 135.

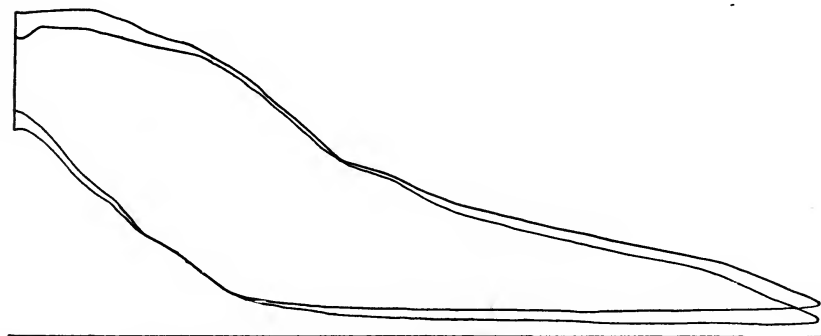

FIG. 136.

Fig. 138 shows all three diagrams on the same card.

Seven or eight feet of pipe is of course excessive for an indicator connection, though not much more so than 6 feet of steam hose. If

such a difference as this exists with 8 feet there should be a visible difference with $4\frac{1}{2}$ feet, or even with the ordinary side pipe on a long cylinder.

Fig. 131 is a photographic reproduction of the diagram obtained from the first engine with the direct connection, the pencil passing over it

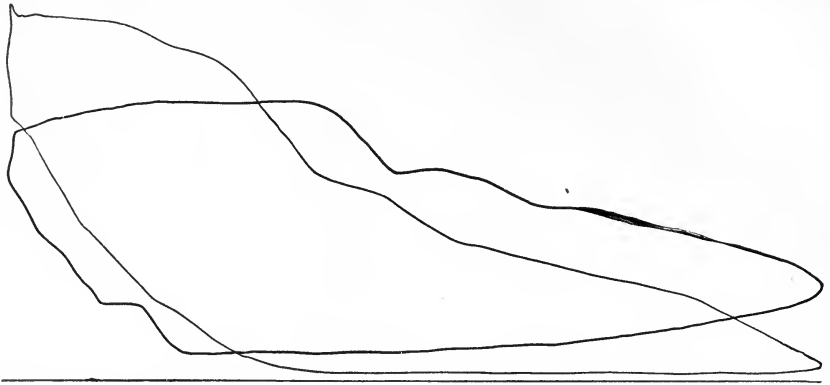

FIG. 137.

fully twenty times. A new card was placed upon the paper-barrel and another diagram taken under the same conditions as Fig. 131. Then leaving the three-way cock so that the steam passed directly to the indicator, the cock *B* was opened, adding the pipe to the volume of the

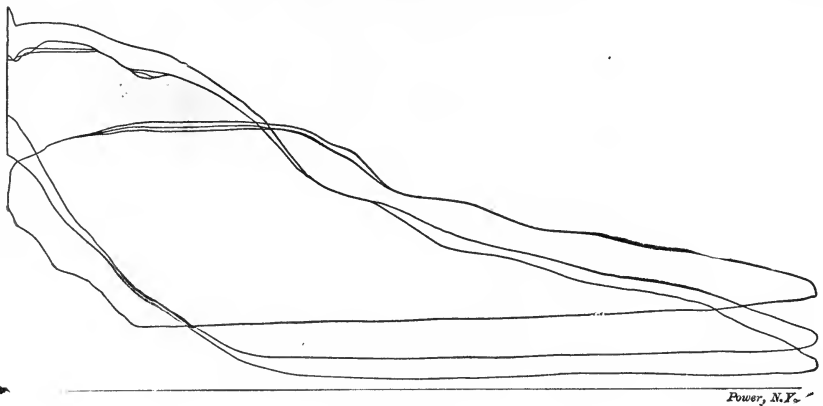

FIG. 138.

clearance, and another diagram was drawn upon the same card. The result is shown in Fig. 132, and is as would have been expected—less realized pressure, lower compression, and higher terminal. For greater distinctness, we have dotted the line of the first diagram, which will be seen to be identical with Fig. 131.

CHAPTER XIX

MEASURING THE CLEARANCE

THE clearance of a steam engine includes not only the space between the piston face and cylinder head, but all of the port or ports up to the valve face when the engine is on the dead center. It is necessary to know its amount whenever any accurate calculations are made concerning the action of the steam. It is usually expressed as a fraction of the volume displaced by one stroke of the piston, or what is equivalent to this, a percentage of the length of the stroke.

Fig. 139 shows a single-valve engine with the steam chest at the side of the cylinder, and the closely shaded portion represents the

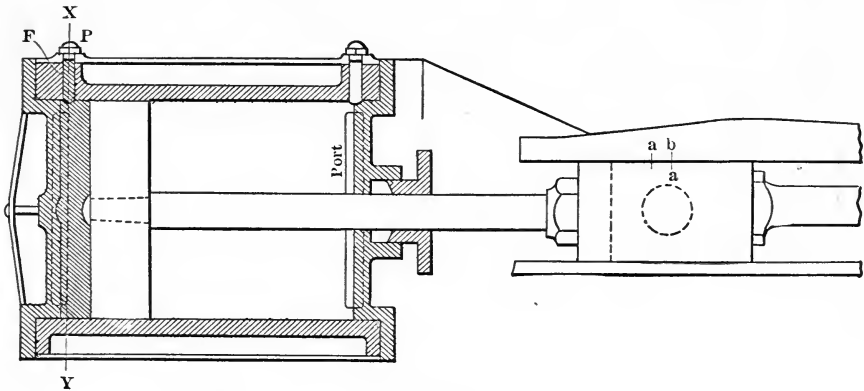

FIG. 139.

clearance. If the valve and piston are tight, the amount of the clearance may be found both easily and accurately as follows:

Put the engine carefully on the dead center in the usual manner and set the valve so that it covers the port, blocking it, if necessary, to hold it up against the seat. Make a fine mark *aa* on the cross-head and guides.

Remove the indicator plug *P* and pour in enough water to fill the clearance space up to the under face *F* of the plug, which is the highest point of the clearance. Measure or weigh carefully the amount of water poured in and make a note of it.

Now turn the engine over until the cross-head has moved 3 or 4 inches of its stroke and pour in a second quantity of water exactly equal to that required to fill the clearance space. Then back the engine up until the water rises again to the original level *F*. The cross-head and piston will now be in the position shown in Fig. 140 and the shaded portion will be filled with water. Make a second mark *b* on the guides opposite the mark *a* on the cross-head. The dotted line *XY*, Fig. 140, represents the original position of the cross-head, and the space to the right of it will be that occupied by the second quantity of water and will represent a volume equal to the clearance. The fraction of the stroke occupied by this equivalent volume will be the distance *ab* on the guides, and all that is needed to find the clearance in decimal parts

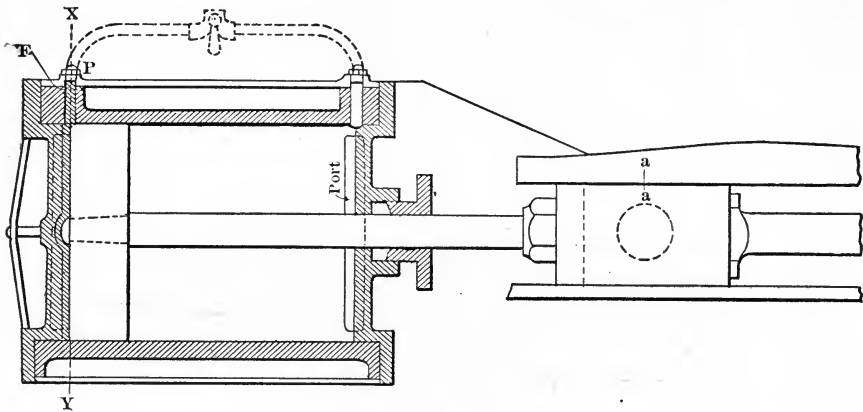

FIG. 140.

of the stroke is to measure in inches the distance *ab* and divide it by the length of the stroke in inches.

For instance, if in an engine of 15 inches stroke the distance *ab* was found to be $1\frac{3}{16}$ inches (1.1875), the clearance would be $\frac{1.1875}{15} = 0.0791$ or $7\frac{9}{100}$ per cent of the stroke.

In engines of the Corliss type, however, the indicator opening is not on top of the cylinder, but usually at the side, as shown in Fig. 141. This objection can be overcome by screwing into the indicator elbow a short, vertical piece of pipe just long enough to bring the top end to the level of the valve face as in the figure. Then pour in the water until it overflows the top end of this pipe, leaving the steam valve open about as for lead to prevent entrapping air at the highest point. If this air were not allowed to escape, it would be compressed until its pressure equaled the slight head of water and it would not be possible to fill the entire clearance space with water.

The distance ab on the guides is then found as before by pouring in a second quantity of water and bringing it to the original level. It is well to note here that if the second pouring is exactly equal to the first, we shall have put in too much by the quantity contained in the short piece of pipe from P to T , Fig. 141. This amount may be obtained

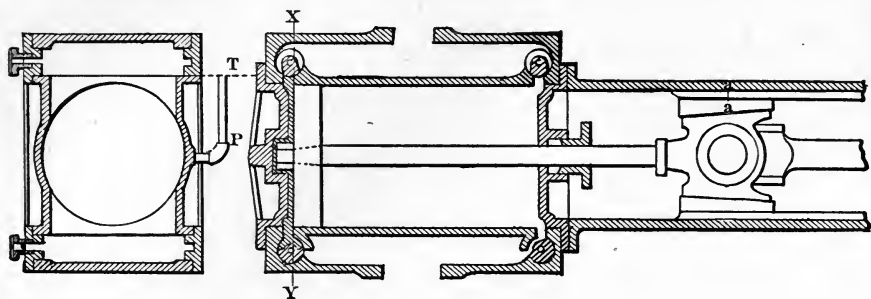

FIG. 141.

by measurement before the pipe is screwed into place and should be deducted from the second pouring in order to correctly locate point b , Fig. 142. In the above method, it is not necessary to measure or weigh the quantity of water in any particular units; a mark on a bucket, any

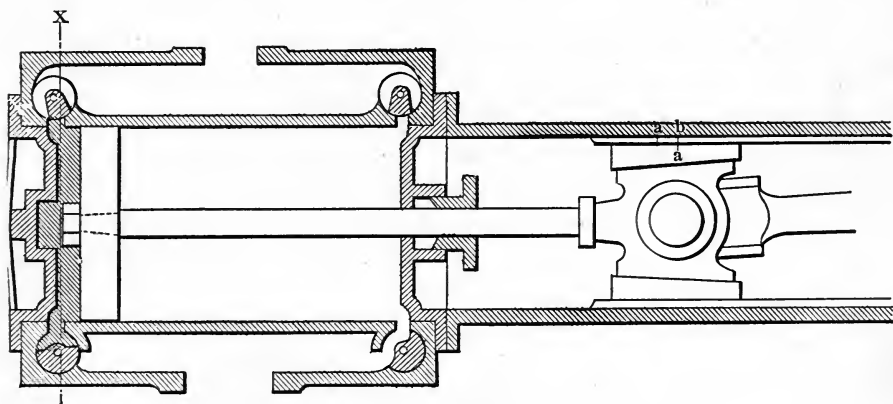

FIG. 142.

known number of canfuls or a balancing weight of unknown value will give two equal quantities.

If a vessel graduated in U. S. liquid measure, i.e., quarts, pints, and gills, be used to measure the first pouring, the second operation, by which mark b was located, may be omitted and the clearance found by a simple calculation.

Suppose it required 3 quarts 1 pint and 2 gills of water to fill the clearance of an engine 15 inches diameter by 15 inches stroke. In U. S. liquid measure

$$\begin{aligned} 4 \text{ gills} &= 1 \text{ pint} \\ 2 \text{ pints} &= 1 \text{ quart} \\ 4 \text{ quarts} &= 1 \text{ gallon} \end{aligned}$$

Since 1 gallon = 231 cubic inches,

$$\begin{aligned} 1 \text{ gill} &= 7.22 \text{ cubic inches} \\ 1 \text{ pint} &= 28.88 \text{ cubic inches} \\ 1 \text{ quart} &= 57.75 \text{ cubic inches} \end{aligned}$$

The volume of the clearance is then

$$\begin{aligned} 3 \text{ quarts} \times 57.75 &= 173.25 \\ 1 \text{ pint} \times 28.88 &= 28.88 \\ 2 \text{ gills} \times 7.22 &= 14.44 \\ \hline \text{Total} &= 216.57 \text{ cu. in.} \end{aligned}$$

The cylinder area is $15^2 \times 0.7854 = 176.71$ square inches, and the piston displacement for one stroke is $176.71 \times 15 = 2650.7$ cubic inches. Therefore the clearance is $216.6 \div 2650.7 = 0.0817$ or 8.17 per cent of the stroke.

Even if the measuring apparatus is not graduated finer than pints it is possible to estimate with reasonable accuracy to quarter pints so that the error will not be serious.

There is another good way to find the clearance without locating point *b* on the guides: it requires only the use of a pair of avoirdupois scales, such as grocers use, and a bucket holding two or more times the water required to fill the clearance.

To illustrate more clearly we will work out an example. Fill the bucket with water and weigh it carefully; let us assume that the bucket and water weigh 20 pounds. Now fill the clearance space from the bucket taking care to spill none of the water, and again weigh the bucket and the remaining water; suppose that it now weighs 12 pounds and 2 ounces. It has then required 20 pounds - 12 pounds 2 ounces = 7 pounds 14 ounces = $7\frac{1}{4}$ or 7.88 pounds of water to fill the clearance space. The volume of a pound of water at the temperature of the usual room is 27.7.

The volume of the clearance is $7.88 \times 27.7 = 218$ cubic inches. The percentage of clearance is then found as before by dividing the clearance volume by the product of the piston area and stroke, i.e., by the piston displacement.

In engines having indicator openings on the side, a correction must be made for the short piece of pipe, as previously mentioned.

We now have three methods of finding clearance:

- 1.—By linear measure, using two equal quantities of water.
- 2.—By liquid measure.
- 3.—By weight.

There is still another method, which is as simple as any; it is shown in Fig. 143. A bucket or other vessel is suspended above the cylinder and a constant supply of water is furnished it by means of a hose or pipe. From the bottom or side of the bucket a small rubber hose or $\frac{1}{8}$ -inch pipe leads the water to the cylinder. The head of the water on the discharge end of the small pipe must be kept constant either by regulating

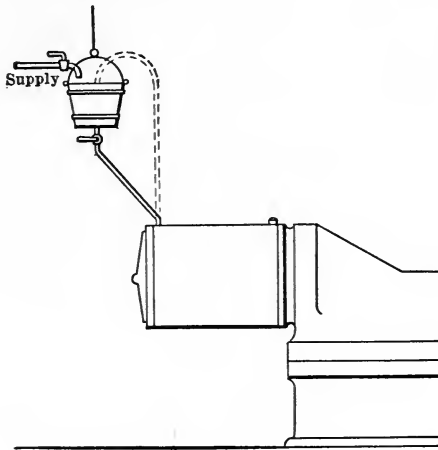

FIG. 143.

the supply to the bucket so as to keep the water level constant, or by allowing the bucket to overflow continually. If the latter is done, the overflowing water must not follow along the small pipe and so get into the cylinder. This can be prevented by using a siphon to supply the cylinder. The operation is as follows: Put the engine on the dead center and note the time in seconds required to fill the clearance space. Shut off the supply to the cylinder and put the engine on the other center. Then through the same pipe and under the same head fill the entire cylinder and clearance space up to the original level, noting separately the time in seconds required to fill the cylinder.

Since the quantity of water flowing through a constant opening under a constant head is exactly proportional to the time, the clearance is equal to the first period of flow divided by the second period.

For example, suppose it requires 1 minute and 25 seconds (85 seconds) to fill the clearance space and 28 minutes and 20 seconds (1700 seconds) to fill the cylinder. The clearance is then $\frac{85}{1700} = 0.05$ or five per cent of the stroke.

The smaller the supply pipe to the cylinder, the longer it will take to fill the clearance space and the less the percentage of error in observation.

Various modifications of the details will suggest themselves for vertical engines, locomotive engines and others. In every case it is important to leave an opening for the escape of air at the highest point.

Suppose that instead of having plugs in the indicator openings the engine were provided with a $\frac{3}{4}$ -inch standard indicator pipe and 3-way cock, as shown by the dotted lines in Fig. 139. The clearance space would then include that portion of the indicator pipe from the face of the 3-way cock to the cylinder connection. For a 15×15 inch engine, this additional amount would be about 11½ inches of $\frac{3}{4}$ -inch standard pipe. The internal area of this pipe is 0.53 of a square inch, and the added clearance volume due to it is $0.53 \times 11\frac{1}{2} = 6.10$ cubic inches. In finding the clearance of an engine equipped thus, the water should be poured in through the indicator connection until it is just visible from the top. When the side pipe is used and it is necessary to use a riser the contents of the riser must be found separately and deducted.

The publication of the foregoing direction for measuring clearance, prepared by Mr. C. G. Robb of the editorial department of *Power*, called out the following suggestion from Prof. John E. Sweet:

The engine valve and piston must be made tight and the engine set on the dead center as in any case. Set upon a platform or counter scale a pail of water and an empty pail, and balance them by the weight on the scale. Fill the clearance space from the pail of water, and then from outside source put enough water in the empty pail to again balance the scale. Mark the cross-head and guide, turn the engine forward a little way and put the water in the second pail in the cylinder, and turn the engine back until the water comes up in the indicator hole, and again mark the cross-head as was clearly explained in the foregoing.

In the case of a Corliss engine where a stand pipe is necessary to fill through the indicator hole, after the scale has been balanced with the pail of water, and empty pail as above described, take off the stand pipe, fill it with water and put it in the pail of water, then after putting on the stand pipe proceed as before.

So far we have in a simple way obtained two marks on the guide which truly represent the distance the piston has to travel to equal the clearance, and whether the result is in even inches, which would

render it simple to determine the per cent, or in fractions, which would complicate the problem, the following graphic method answers equally well, and is readily performed by anyone who can use a rule.

Draw a horizontal line as in Fig. 144, and lay off the stroke of the engine AB , and draw the vertical line from B ; at C draw another vertical line the same distance from A as the two lines marked on the guide. From A with 100 units of any convenient length measure up on the line B , that is to say, if the stroke of the engine be 11 inches, measure up from A to some point on the line F to D $12\frac{1}{2}$ inches, which is a hundred

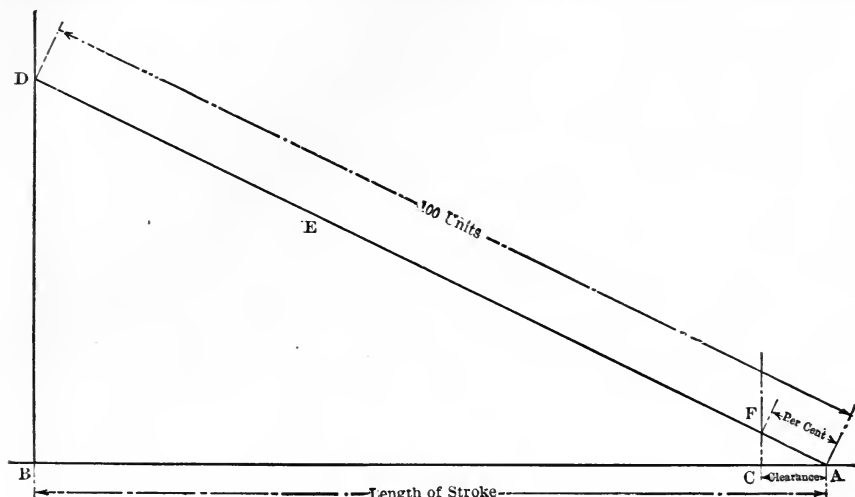

FIG. 144

units of $\frac{1}{8}$ inch each, then from D to A strike the straight line E and as many $\frac{1}{8}$ inches as there are from A to F , so much will be the per cent of clearance in the engine. If the stroke of the engine is between 13 and 18 inches, $18\frac{3}{4}$ inches may be used for the line E when $\frac{3}{16}$ of an inch will be the unit, or if from 18 to 24 inches, then 25 inches for the line E with $\frac{1}{4}$ inch as a unit and so on.

Of course this is not the mathematicians' way of doing things, but it eliminates many sources of error, is quick, easy to understand, and just as accurate as the man who does it is able to work, and that is the measure of accuracy in about everything.

TABLE I.—HYPERBOLIC LOGARITHMS.

N.	Loga- rithm.	N.	Loga- rithm.	N.	Loga- rithm.	N.	Loga- rithm.
1.01	.00995	1.57	.45108	2.13	.75612	2.69	.98954
1.02	.01980	1.58	.45742	2.14	.76081	2.70	.99325
1.03	.02956	1.59	.46373	2.15	.76547	2.71	.99695
1.04	.03922	1.60	.47000	2.16	.77011	2.72	1.00063
1.05	.04879	1.61	.47623	2.17	.77473	2.73	1.00430
1.06	.05827	1.62	.48243	2.18	.77932	2.74	1.00796
1.07	.06766	1.63	.48858	2.19	.78390	2.75	1.01160
1.08	.07696	1.64	.49470	2.20	.78846	2.76	1.01523
1.09	.08618	1.65	.50078	2.21	.79299	2.77	1.01885
1.10	.09531	1.66	.50681	2.22	.79751	2.78	1.02245
1.11	.10436	1.67	.51282	2.23	.80200	2.79	1.02604
1.12	.11333	1.68	.51879	2.24	.80648	2.80	1.02962
1.13	.12222	1.69	.52473	2.25	.81093	2.81	1.03318
1.14	.13103	1.70	.53063	2.26	.81536	2.82	1.03674
1.15	.13977	1.71	.53649	2.27	.81978	2.83	1.04028
1.16	.14842	1.72	.54232	2.28	.82418	2.84	1.04380
1.17	.15700	1.73	.54812	2.29	.82855	2.85	1.04732
1.18	.16551	1.74	.55389	2.30	.83291	2.86	1.05082
1.19	.17395	1.75	.55962	2.31	.83725	2.87	1.05431
1.20	.18232	1.76	.56531	2.32	.84157	2.88	1.05779
1.21	.19062	1.77	.57098	2.33	.84587	2.89	1.06126
1.22	.19885	1.78	.57661	2.34	.85015	2.90	1.06471
1.23	.20701	1.79	.58222	2.35	.85442	2.91	1.06815
1.24	.21511	1.80	.58779	2.36	.85866	2.92	1.07158
1.25	.22314	1.81	.59333	2.37	.86289	2.93	1.07500
1.26	.23111	1.82	.59884	2.38	.86710	2.94	1.07841
1.27	.23902	1.83	.60432	2.39	.87129	2.95	1.08181
1.28	.24686	1.84	.60977	2.40	.87547	2.96	1.08519
1.29	.25464	1.85	.61519	2.41	.87963	2.97	1.08856
1.30	.26236	1.86	.62058	2.42	.88377	2.98	1.09192
1.31	.27003	1.87	.62594	2.43	.88789	2.99	1.09527
1.32	.27763	1.88	.63127	2.44	.89200	3.00	1.09861
1.33	.28518	1.89	.63658	2.45	.89609	3.01	1.10194
1.34	.29267	1.90	.64185	2.46	.90016	3.02	1.10526
1.35	.30010	1.91	.64710	2.47	.90422	3.03	1.10856
1.36	.30748	1.92	.65233	2.48	.90828	3.04	1.11186
1.37	.31481	1.93	.65752	2.49	.91228	3.05	1.11514
1.38	.32208	1.94	.66269	2.50	.91629	3.06	1.11841
1.39	.32930	1.95	.66783	2.51	.92028	3.07	1.12168
1.40	.33647	1.96	.67294	2.52	.92426	3.08	1.12493
1.41	.34359	1.97	.67803	2.53	.92822	3.09	1.12817
1.42	.35066	1.98	.68310	2.54	.93216	3.10	1.13140
1.43	.35767	1.99	.68813	2.55	.93609	3.11	1.13462
1.44	.36464	2.00	.69315	2.56	.94001	3.12	1.13783
1.45	.37156	2.01	.69813	2.57	.94391	3.13	1.14103
1.46	.37844	2.02	.70310	2.58	.94779	3.14	1.14422
1.47	.38526	2.03	.70804	2.59	.95166	3.15	1.14740
1.48	.39204	2.04	.71295	2.60	.95551	3.16	1.15057
1.49	.39878	2.05	.71784	2.61	.95935	3.17	1.15373
1.50	.40547	2.06	.72271	2.62	.96317	3.18	1.15688
1.51	.41211	2.07	.72755	2.63	.96698	3.19	1.16002
1.52	.41871	2.08	.73237	2.64	.97078	3.20	1.16315
1.53	.42527	2.09	.73716	2.65	.97454	3.21	1.16627
1.54	.43178	2.10	.74194	2.66	.97833	3.22	1.16938
1.55	.43825	2.11	.74669	2.67	.98208	3.23	1.17248
1.56	.44469	2.12	.75142	2.68	.98582	3.24	1.17557

TABLE I. *Continued.* — HYPERBOLIC LOGARITHMS.

N.	Loga- rithm.	N.	Loga- rithm.	N.	Loga- rithm.	N.	Loga- rithm.
3.25	1.17865	3.81	1.33763	4.37	1.47476	4.93	1.59534
3.26	1.18173	3.82	1.34025	4.38	1.47705	4.94	1.59737
3.27	1.18479	3.83	1.34286	4.39	1.47933	4.95	1.59939
3.28	1.18784	3.84	1.34547	4.40	1.48160	4.96	1.60141
3.29	1.19089	3.85	1.34807	4.41	1.48387	4.97	1.60342
3.30	1.19392	3.86	1.35067	4.42	1.48614	4.98	1.60543
3.31	1.19695	3.87	1.35325	4.43	1.48840	4.99	1.60744
3.32	1.19996	3.88	1.35584	4.44	1.49065	5.00	1.60944
3.33	1.20297	3.89	1.35841	4.45	1.49290	5.01	1.61144
3.34	1.20597	3.90	1.36098	4.46	1.49515	5.02	1.61344
3.35	1.20896	3.91	1.36354	4.47	1.49739	5.03	1.61542
3.36	1.21194	3.92	1.36609	4.48	1.49962	5.04	1.61741
3.37	1.21491	3.93	1.36864	4.49	1.50185	5.05	1.61939
3.38	1.21788	3.94	1.37118	4.50	1.50408	5.06	1.62137
3.39	1.22083	3.95	1.37371	4.51	1.50630	5.07	1.62334
3.40	1.22378	3.96	1.37624	4.52	1.50851	5.08	1.62531
3.41	1.22671	3.97	1.37877	4.53	1.51072	5.09	1.62728
3.42	1.22964	3.98	1.38128	4.54	1.51293	5.10	1.62924
3.43	1.23256	3.99	1.38379	4.55	1.51513	5.11	1.63120
3.44	1.23547	4.00	1.38629	4.56	1.51732	5.12	1.63315
3.45	1.23837	4.01	1.38879	4.57	1.51951	5.13	1.63511
3.46	1.24127	4.02	1.39128	4.58	1.52170	5.14	1.63705
3.47	1.24415	4.03	1.39377	4.59	1.52388	5.15	1.63900
3.48	1.24703	4.04	1.39624	4.60	1.52606	5.16	1.64094
3.49	1.24990	4.05	1.39872	4.61	1.52823	5.17	1.64287
3.50	1.25276	4.06	1.40118	4.62	1.53039	5.18	1.64481
3.51	1.25562	4.07	1.40364	4.63	1.53256	5.19	1.64673
3.52	1.25846	4.08	1.40610	4.64	1.53471	5.20	1.64866
3.53	1.26130	4.09	1.40854	4.65	1.53687	5.21	1.65058
3.54	1.26412	4.10	1.41099	4.66	1.53902	5.22	1.65250
3.55	1.26695	4.11	1.41342	4.67	1.54116	5.23	1.65441
3.56	1.26976	4.12	1.41585	4.68	1.54330	5.24	1.65632
3.57	1.27257	4.13	1.41828	4.69	1.54543	5.25	1.65823
3.58	1.27536	4.14	1.42070	4.70	1.54756	5.26	1.66013
3.59	1.27815	4.15	1.42311	4.71	1.54969	5.27	1.66203
3.60	1.28093	4.16	1.42552	4.72	1.55181	5.28	1.66393
3.61	1.28371	4.17	1.42792	4.73	1.55393	5.29	1.66582
3.62	1.28647	4.18	1.43031	4.74	1.55604	5.30	1.66771
3.63	1.28923	4.19	1.43270	4.75	1.55814	5.31	1.66959
3.64	1.29198	4.20	1.43508	4.76	1.56025	5.32	1.67147
3.65	1.29473	4.21	1.43746	4.77	1.56235	5.33	1.67335
3.66	1.29746	4.22	1.43984	4.78	1.56444	5.34	1.67523
3.67	1.30019	4.23	1.44220	4.79	1.56653	5.35	1.67710
3.68	1.30291	4.24	1.44456	4.80	1.56862	5.36	1.67896
3.69	1.30563	4.25	1.44692	4.81	1.57070	5.37	1.68083
3.70	1.30833	4.26	1.44927	4.82	1.57277	5.38	1.68269
3.71	1.31103	4.27	1.45161	4.83	1.57485	5.39	1.68455
3.72	1.31372	4.28	1.45395	4.84	1.57691	5.40	1.68640
3.73	1.31641	4.29	1.45629	4.85	1.57898	5.41	1.68825
3.74	1.31909	4.30	1.45861	4.86	1.58104	5.42	1.69010
3.75	1.32176	4.31	1.46094	4.87	1.58309	5.43	1.69194
3.76	1.32442	4.32	1.46326	4.88	1.58515	5.44	1.69378
3.77	1.32707	4.33	1.46557	4.89	1.58719	5.45	1.69562
3.78	1.32972	4.34	1.46787	4.90	1.58924	5.46	1.69745
3.79	1.33237	4.35	1.47018	4.91	1.59127	5.47	1.69928
3.80	1.33500	4.36	1.47247	4.92	1.59331	5.48	1.70111

TABLE I. *Continued.* — HYPERBOLIC LOGARITHMS.

N.	Loga- rithm.	N.	Loga- rithm.	N.	Loga- rithm.	N.	Loga- rithm.
5.49	1.70293	6.05	1.80006	6.61	1.88858	7.17	1.96991
5.50	1.70475	6.06	1.80171	6.62	1.89010	7.18	1.97130
5.51	1.70656	6.07	1.80336	6.63	1.89160	7.19	1.97269
5.52	1.70838	6.08	1.80500	6.64	1.89311	7.20	1.97408
5.53	1.71019	6.09	1.80665	6.65	1.89462	7.21	1.97547
5.54	1.71199	6.10	1.80829	6.66	1.89612	7.22	1.97685
5.55	1.71380	6.11	1.80993	6.67	1.89762	7.23	1.97824
5.56	1.71560	6.12	1.81156	6.68	1.89912	7.24	1.97962
5.57	1.71740	6.13	1.81319	6.69	1.90061	7.25	1.98100
5.58	1.71919	6.14	1.81482	6.70	1.90211	7.26	1.98238
5.59	1.72098	6.15	1.81645	6.71	1.90360	7.27	1.98376
5.60	1.72277	6.16	1.81808	6.72	1.90509	7.28	1.98513
5.61	1.72455	6.17	1.81970	6.73	1.90658	7.29	1.98650
5.62	1.72633	6.18	1.82132	6.74	1.90806	7.30	1.98787
5.63	1.72811	6.19	1.82294	6.75	1.90954	7.31	1.98924
5.64	1.72988	6.20	1.82455	6.76	1.91102	7.32	1.99061
5.65	1.73166	6.21	1.82616	6.77	1.91250	7.33	1.99198
5.66	1.73342	6.22	1.82777	6.78	1.91398	7.34	1.99334
5.67	1.73519	6.23	1.82937	6.79	1.91545	7.35	1.99470
5.68	1.73695	6.24	1.83098	6.80	1.91692	7.36	1.99606
5.69	1.73871	6.25	1.83258	6.81	1.91839	7.37	1.99742
5.70	1.74047	6.26	1.83418	6.82	1.91986	7.38	1.99878
5.71	1.74222	6.27	1.83578	6.83	1.92132	7.39	2.00013
5.72	1.74397	6.28	1.83737	6.84	1.92279	7.40	2.00148
5.73	1.74572	6.29	1.83896	6.85	1.92425	7.41	2.00283
5.74	1.74746	6.30	1.84055	6.86	1.92571	7.42	2.00418
5.75	1.74920	6.31	1.84214	6.87	1.92716	7.43	2.00553
5.76	1.75094	6.32	1.84372	6.88	1.92862	7.44	2.00687
5.77	1.75267	6.33	1.84530	6.89	1.93007	7.45	2.00821
5.78	1.75440	6.34	1.84688	6.90	1.93152	7.46	2.00956
5.79	1.75613	6.35	1.84845	6.91	1.93297	7.47	2.01089
5.80	1.75786	6.36	1.85003	6.92	1.93442	7.48	2.01223
5.81	1.75958	6.37	1.85160	6.93	1.93586	7.49	2.01357
5.82	1.76130	6.38	1.85317	6.94	1.93730	7.50	2.01490
5.83	1.76302	6.39	1.85473	6.95	1.93874	7.51	2.01624
5.84	1.76473	6.40	1.85630	6.96	1.94018	7.52	2.01757
5.85	1.76644	6.41	1.85786	6.97	1.94162	7.53	2.01890
5.86	1.76815	6.42	1.85942	6.98	1.94305	7.54	2.02022
5.87	1.76985	6.43	1.86097	6.99	1.94448	7.55	2.02155
5.88	1.77156	6.44	1.86253	7.00	1.94591	7.56	2.02287
5.89	1.77326	6.45	1.86408	7.01	1.94734	7.57	2.02419
5.90	1.77495	6.46	1.86563	7.02	1.94876	7.58	2.02551
5.91	1.77665	6.47	1.86718	7.03	1.95019	7.59	2.02683
5.92	1.77834	6.48	1.86872	7.04	1.95161	7.60	2.02815
5.93	1.78002	6.49	1.87026	7.05	1.95303	7.61	2.02946
5.94	1.78171	6.50	1.87180	7.06	1.95444	7.62	2.03078
5.95	1.78339	6.51	1.87334	7.07	1.95586	7.63	2.03209
5.96	1.78507	6.52	1.87487	7.08	1.95727	7.64	2.03340
5.97	1.78675	6.53	1.87641	7.09	1.95869	7.65	2.03471
5.98	1.78842	6.54	1.87794	7.10	1.96009	7.66	2.03601
5.99	1.79009	6.55	1.87947	7.11	1.96150	7.67	2.03732
6.00	1.79176	6.56	1.88099	7.12	1.96291	7.68	2.03862
6.01	1.79342	6.57	1.88251	7.13	1.96431	7.69	2.03992
6.02	1.79507	6.58	1.88403	7.14	1.96571	7.70	2.04122
6.03	1.79675	6.59	1.88555	7.15	1.96711	7.71	2.04252
6.04	1.79840	6.60	1.88707	7.16	1.96851	7.72	2.04381

TABLE I. *Continued.* — HYPERBOLIC LOGARITHMS.

N.	Loga- rithm.	N.	Loga- rithm.	N.	Loga- rithm.	N.	Loga- rithm.
7.73	2.04511	8.30	2.11626	8.87	2.18267	9.44	2.24406
7.74	2.04640	8.31	2.11746	8.88	2.18380	9.45	2.24601
7.75	2.04769	8.32	2.11866	8.89	2.18493	9.46	2.24707
7.76	2.04898	8.33	2.11986	8.90	2.18605	9.47	2.24813
7.77	2.05027	8.34	2.12106	8.91	2.18717	9.48	2.24918
7.78	2.05156	8.35	2.12226	8.92	2.18830	9.49	2.25024
7.79	2.05284	8.36	2.12346	8.93	2.18942	9.50	2.25129
7.80	2.05412	8.37	2.12465	8.94	2.19054	9.51	2.25234
7.81	2.05540	8.38	2.12585	8.95	2.19165	9.52	2.25339
7.82	2.05668	8.39	2.12704	8.96	2.19277	9.53	2.25444
7.83	2.05796	8.40	2.12823	8.97	2.19389	9.54	2.25549
7.84	2.05924	8.41	2.12942	8.98	2.19500	9.55	2.25654
7.85	2.06051	8.42	2.13061	8.99	2.19611	9.56	2.25759
7.86	2.06179	8.43	2.13180	9.00	2.19722	9.57	2.25863
7.87	2.06306	8.44	2.13298	9.01	2.19834	9.58	2.25968
7.88	2.06433	8.45	2.13417	9.02	2.19944	9.59	2.26072
7.89	2.06560	8.46	2.13535	9.03	2.20055	9.60	2.26176
7.90	2.06686	8.47	2.13653	9.04	2.20166	9.61	2.26280
7.91	2.06813	8.48	2.13771	9.05	2.20276	9.62	2.26384
7.92	2.06939	8.49	2.13889	9.06	2.20387	9.63	2.26488
7.93	2.07065	8.50	2.14007	9.07	2.20497	9.64	2.26592
7.94	2.07191	8.51	2.14124	9.08	2.20607	9.65	2.26696
7.95	2.07317	8.52	2.14242	9.09	2.20717	9.66	2.26799
7.96	2.07443	8.53	2.14359	9.10	2.20827	9.67	2.26903
7.97	2.07568	8.54	2.14476	9.11	2.20937	9.68	2.27006
7.98	2.07694	8.55	2.14593	9.12	2.21047	9.69	2.27109
7.99	2.07819	8.56	2.14710	9.13	2.21157	9.70	2.27213
8.00	2.07944	8.57	2.14827	9.14	2.21266	9.71	2.27316
8.01	2.08069	8.58	2.14943	9.15	2.21375	9.72	2.27419
8.02	2.08194	8.59	2.15060	9.16	2.21485	9.73	2.27521
8.03	2.08318	8.60	2.15176	9.17	2.21594	9.74	2.27624
8.04	2.08443	8.61	2.15292	9.18	2.21703	9.75	2.27727
8.05	2.08567	8.62	2.15409	9.19	2.21812	9.76	2.27829
8.06	2.08691	8.63	2.15524	9.20	2.21920	9.77	2.27932
8.07	2.08815	8.64	2.15640	9.21	2.22029	9.78	2.28034
8.08	2.08939	8.65	2.15756	9.22	2.22138	9.79	2.28136
8.09	2.09063	8.66	2.15871	9.23	2.22246	9.80	2.28238
8.10	2.09186	8.67	2.15987	9.24	2.22351	9.81	2.28340
8.11	2.09310	8.68	2.16102	9.25	2.22462	9.82	2.28442
8.12	2.09433	8.69	2.16217	9.26	2.22570	9.83	2.28544
8.13	2.09556	8.70	2.16332	9.27	2.22678	9.84	2.28646
8.14	2.09679	8.71	2.16447	9.28	2.22786	9.85	2.28747
8.15	2.09802	8.72	2.16562	9.29	2.22894	9.86	2.28849
8.16	2.09924	8.73	2.16677	9.30	2.23001	9.87	2.28950
8.17	2.10047	8.74	2.16791	9.31	2.23109	9.88	2.29051
8.18	2.10169	8.75	2.16905	9.32	2.23216	9.89	2.29152
8.19	2.10291	8.76	2.17020	9.33	2.23323	9.90	2.29253
8.20	2.10413	8.77	2.17134	9.34	2.23431	9.91	2.29354
8.21	2.10535	8.78	2.17248	9.35	2.23538	9.92	2.29455
8.22	2.10657	8.79	2.17361	9.36	2.23645	9.93	2.29556
8.23	2.10779	8.80	2.17475	9.37	2.23751	9.94	2.29657
8.24	2.10900	8.81	2.17589	9.38	2.23858	9.95	2.29757
8.25	2.11021	8.82	2.17702	9.39	2.23965	9.96	2.29858
8.26	2.11142	8.83	2.17816	9.40	2.24071	9.97	2.29958
8.27	2.11263	8.84	2.17929	9.41	2.24177	9.98	2.30058
8.28	2.11384	8.85	2.18042	9.42	2.24284	9.99	2.30158
8.29	2.11505	8.86	2.18155	9.43	2.24390		

INDEX

- A**CCURACY of reducing motions, 14.
Accuracy of the spring, 5.
Action of the steam shown by the diagram, 41.
Adjustment of the cord, 34.
Admission line, 44.
Allowance for piston rod, 104.
Angularity of cord affecting diagram, 147.
Apparatus for testing for the effect of long indicator piping, 150, 152.
Assembling the instrument, 36.
Attachment of the indicator, 28..
- B**ACK pressure line, 67.
Balancing the effort, 111.
Brumbo pulley, 13.
Brumbo pulley affecting diagram, 147.
Buckeye reducing motion, 24.
- C**ARE of the instrument, 1.
Care of the instrument after using, 39.
Cause of drop in steam line, 47-50.
Centering the diagram, 34.
Change of load affecting distribution in compound engine, 141.
Clearance affecting compression, 72.
Clearance; effect on combined diagrams from compound engines, 141.
Clearance line located from expansion curve, 61.
Clearance, measurement of, 155.
Coffin averaging instrument, 94.
Combining diagrams from compound engines, 135.
Compound-engine diagrams, clearance considered, 139.
Compound-engine diagrams, clearance neglected, 134.
Compression affected by clearance, 72.
Compression and clearance loss, 74.
Compression in condensing engine, 71.
Compression line, 70.
Computing horse-power, 96.
Connection of reducing lever to cross-head, 14, 15, 16.
- Connection of reducing motion to the instrument, 32.
Conventional steam chest diagram, 49.
Cord, 33.
Cord adjustment, 34.
Corrected diagrams for head and crank end, 112.
Correcting theoretical M.E.P. for departures from the ideal, 118.
Counterpressure line, 67.
Cushioning effect of compression, 73.
Cylinder condensation, 50, 76.
- D**EFFECTS of pendulum reducing motion, 14.
Determination of leakage, 63.
Determination of the point of cut-off, 60.
Diagram, the ideal, 41.
Diagrams for head- and crank-end, 112.
Diagrams from compound engines, clearance considered, 139.
Diagrams from compound engines, clearance neglected, 134.
Diagrams taken with excessive indicator piping, 153.
Direction of lead of cord for pendulum reducing motion, 13.
Dirt and scale in indicator piping, 31.
Distortion of diagram due to shortness of pendulum lever, 15.
Distortion of diagram—varying with manner of attachment of cord, to the cross-head, 16, 17.
Drawing the theoretical expansion curve, 55.
Drop in compression line, 75.
Drop in steam line, 47.
Drum-spring tension, 5.
- E**ARLY release, 65.
Economy of expansion, 53.
Effect of brumbo pulley on diagram errors, 147.
Effect of change of load in compound engine, 144.
Effect of clearance on compression, 72.

Effect of clearance on M.E.P., 114.
 Effect of compression on clearance loss, 74.
 Effect of condensation and re-expansion, 61.
 Effect of long indicator piping, on diagram, 149.
 Effect of quality of steam on expansion line, 61.
 Effect of receiver capacity on the combined diagram, 142.
 Effect of small exhaust pipe on back pressure, 67.
 Effect of small ports on back pressure, 67.
 Effect of a variable cut-off in low-pressure cylinder, 142.
 Effect on diagram of angularity of cord, 147.
 Effect on diagram of length of reducing lever, 15.
 Errors in the diagram, 145.
 Expansion, ratio of, 114.
 Experiments with excessive piping, 149.
 Exhaust line, 67.

GRAPHIC method of determining clearance, 61, 161.

HATCHET planimeter, 92.
 Horse-power constant, 100.
 Table of, 107.

Horse-power corrected for piston rod, 104.
 Horse-power (definition), 96.
 Horse power developed by each separate stroke, 106.

IMPROPER connection of the instrument, 29.
 Indicator piping affecting diagram, 149.
 Indicator piping experiments, 149.
 Interchangeable (right- and left-hand) indicators, 31.

LAW of expansion of steam, 55.
 Leads, 9.
 Leakage, 63.
 Length of diagram, 12, 89.
 Location of indicator connection, 27.
 Loop at release, 65.
 Loop in compression line, 75.
 Loss of pressure between boiler and steam chest, 47.
 Lost motion in the indicator, 3.
 Lubrication of the instrument, 10.

M.E.P. affected by clearance, 114.
 Mean effective pressure (definition), 77.
 Mean effective pressure by computation, 113.

Mean effective pressure from diagram, 77.
 Mean pressure of the ideal diagram, 115.
 Mean pressure per pound of initial, 115.
 Table of, 115.

Measuring clearance, 155.
 Measuring loops, 82.
 Measuring loops with planimeter, 88.
 Measuring ordinates on the diagram, 77.
 Measuring scales, 9, 79.
 Methods of drawing the theoretical expansion curve, 55.

NEGATIVE loop, 82-88.

PANTOGRAPH, 18.
 Pantograph table, 19.
 Paper suitable for cards, 10.
 Paper, putting on, 37.
 Parallelism, 3.
 Parallel rules, 81.
 Pencil holders, 6.
 Pendulum lever, 11.
 Piping affecting diagram, 149.
 Piping experiments, 149.
 Piston rod area allowance, 104.
 Piston speed, 97.
 Table of, 101, 102.
 Planimeter, 83.
 Plotting the expansion curve, 55.
 Point of cut-off, 60.
 Point of release, 64.
 Proportional movement of pencil, 4.

RATIO of expansion, 114.
 Reading the planimeter, 85.
 Reading the vernier, 85.
 Receiver capacity affecting distribution, 142.
 Reducing motion, 11.
 Reducing wheels, 26.
 Reduction of compound engine diagrams to correct scales for combining, 135.
 Relation of pressure and volume, 55.
 Release, 64.
 Removal of dirt and scale in indicator piping, 31.
 Right- and left-hand instruments, 31.
 Rod connection for reducing lever, 16.
 Rule for horse-power, 96.
 Rule for mean effective pressure, 118.
 Rule for mean pressure, 114.
 Rule for steam accounted for by indicator, 123.

SCALES, 9, 79.
 Selection of an indicator, 1.

- Separate diagrams for head- and crank-end, 112.
- Setting the pantograph, 19.
- Slotted connection for reducing lever, 14, 15.
- Spacing ordinates on the diagram, 78.
- Springs, 5, 6, 7, 8, 36.
- Steam accounted for by the indicator, 119.
- Steam-chest diagrams, 49.
- Steam consumption from the diagram, 119.
- Steam consumption in compound engine, 129.
- Steam line, 47.
- Sweet's method for measuring clearance, 160.
- T**ABLE for computing mean and initial pressures, points of cut-off and ratios of expansion, 115.
- Table for computing steam consumption values of 13750 W, 132.
- Table for computing steam consumption values of $\frac{13750}{\text{M.E.P.}}$ 100 to 250 pounds, 131.
- Table for computing steam consumption values of $\frac{13750}{\text{M.E.P.}}$ up to 100 pounds, 125.
- Table for using the pantograph, 19.
- Table of horse-power constants, 107.
- Table of hyperbolic logarithms, 162.
- Table of ideal mean effective pressures, 115.
- Tapping the cylinder, 27.
- Test for accuracy of reducing motion, 26.
- Testing the spring, 5.
- V**ACUUM springs, 7.
- Variable cut-off on low-pressure cylinder, 142.
- Variations of compression with back pressure, 72.
- Vernier, 85.
- Volume of steam per hour per horse-power, table of 125-131.
- W**IRE, used as indicator cord, 33.



YC 12889

44 x
/50 net

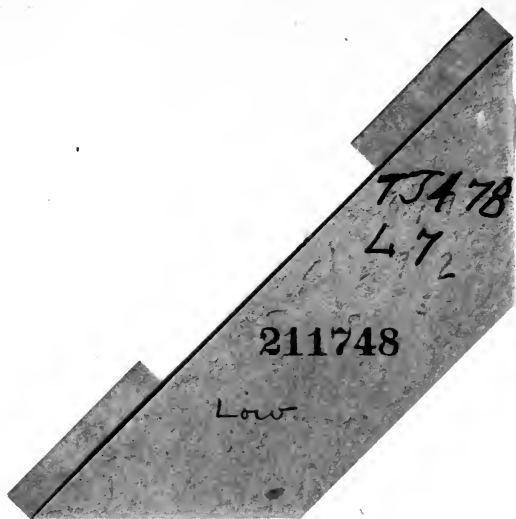

75478

L7

211748

Low

