

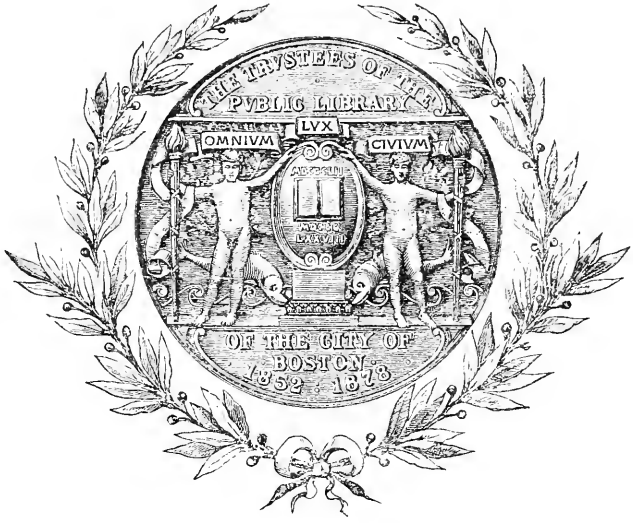

STACK 6 ANNEX

No. H016.95









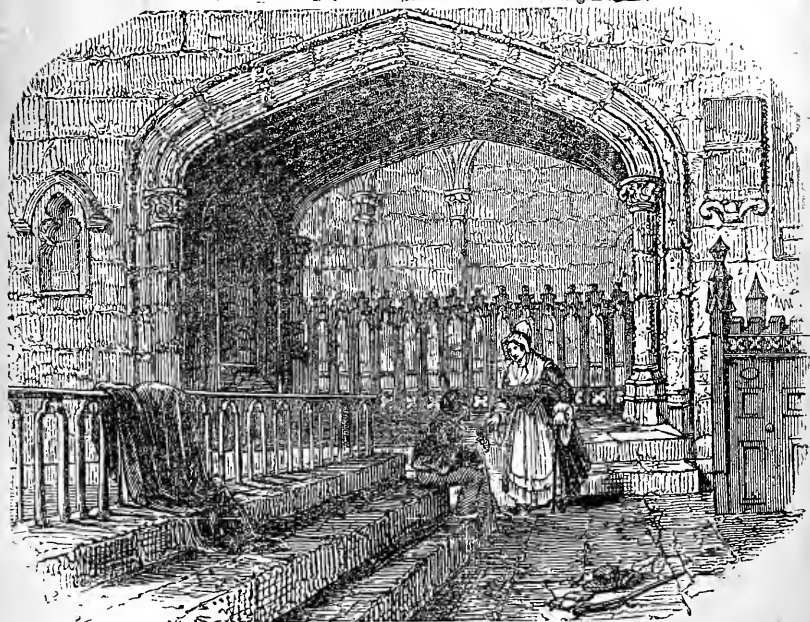
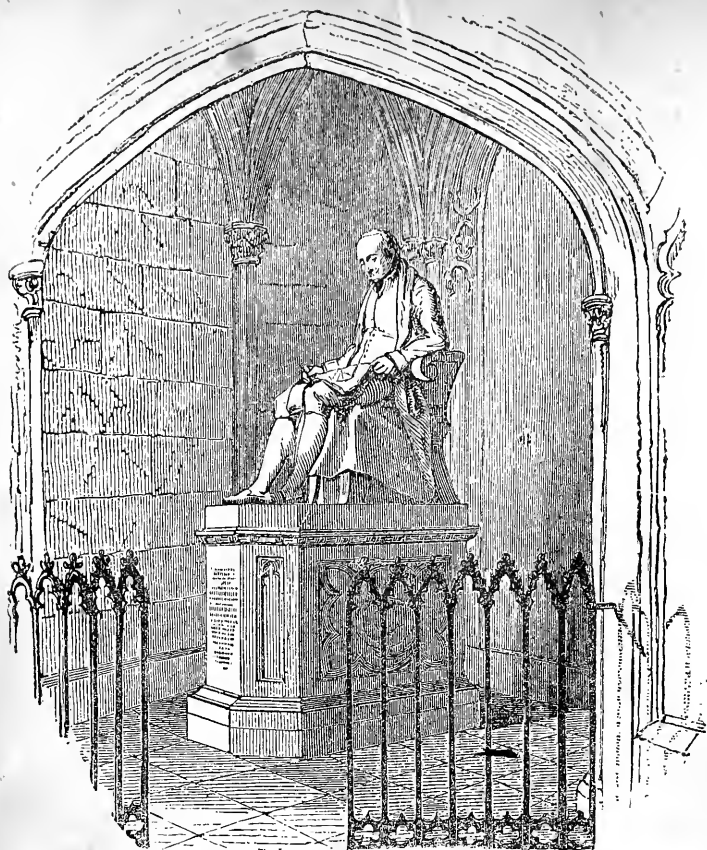

WATT'S MONUMENT AND CHAPEL IN HANDSWORTH CHURCH.

# STEAM AND ITS USES;

INCLUDING

THE STEAM ENGINE,  
THE LOCOMOTIVE, AND  
STEAM NAVIGATION.

By DIONYSIUS LARDNER, D.C.L.,

Formerly Professor of Natural Philosophy and Astronomy in University College, London.

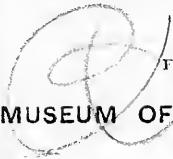

FROM

"THE MUSEUM OF SCIENCE AND ART."

WITH EIGHTY-NINE ILLUSTRATIONS.



9783

LONDON:

LOCKWOOD & CO., 7, STATIONERS' HALL COURT,  
LUDGATE HILL.

LONDON:  
BRADBURY, AGNEW, & CO., PRINTERS, WHITEFRIARS.

11. 1. 11  
Dec. 2, 1875



184041

## CONTENTS.

---

\* \* *As this book is not paged, the figures in the Table of Contents refer to Paragraphs, and not to Pages. Each Subject is separately Paragraphed.*

---

### STEAM.

- |  |   |
|--|---|
| 1. Power of steam manifested by natural evaporation.—2. Early attempts at its mechanical application—Inventions of Watt.—3. Influence of steam power on mankind.—4. Its agency in commerce and the arts.—5. Analysis of its operation.—6. Combustion of coals.—7. Force developed by the evaporation of water.—8. Steam an invisible aëriiform fluid.—9. Measure of the mechanical force developed.—10. Heat absorbed in evaporation.—11. Latent heat of steam.—12. Effect of varying pressure.—13. Mechanical force independent of the pressure.—14. Force developed by expansion.— | 15. Force developed by condensation.—16. Application of these three forces in steam engines.—17. Steam may act variously on piston.—18. Furnaces and boilers.—19. Evaporating power of fuel.—20. Means of economising heat.—21. Prevention of loss by radiation.—22. Inspection and reports of Cornish engines.—23. Greatly improved efficiency.—24. Actual mechanical virtue of coals.—25. Illustrations—Pyramids of Egypt.—26. Menai Bridge.—27. Railway engines.—28. Exhaustion of coal mines improbable.—29. Prospects of scientific discovery. |
|--|---|

### THE STEAM ENGINE.

- |   |   |
|---|---|
| CHAP. I.—1. The steam engine.—2. Consists of two essential parts.—3. The boiler.—4. Material employed in its formation.—5. Feeding apparatus.—6. Importance of keeping the water in the boiler at a proper level.—7. Wet and dry steam.—8. Priming.—9. Means of ascertaining the level of the water in the boiler.—10. Self-acting feeders.—11. Safety valve. | —12. Steam gauge.—13. The furnace.—14. Proper mode of feeding the furnace.—15. Rarely observed.—16. Contrivance for supplying fuel.<br>CHAP. II.—17. Method of regulating the activity of the furnace.—18. How steam is made to produce a mechanical effect.—19. The cylinder and piston.—20. Metallic pistons.—21. Estimate of the |
|---|---|

## CONTENTS.

force with which the piston is moved.—22. Transmission of this force.—23. Piston rod.—24. Cocks, valves, and slides.—25. How employed.—26. Stroke of the engine.—27. Effective pressure.—28. Supply of steam to the cylinder.—29. By valves.—30. By slides.—31. Scaward's slides.—32. Single cock.—33. Four-way cock.—34. Low and high pressure, more properly called condensing and non-condensing engines.—35. Objections to the latter and countervailing advantages.—36. Condensing engines.—37. Condensing apparatus.—

38. Air-pump.—39. Cold water pump.—40. Hot water pump.  
CHAP. III.—41. Comparative merits of the two kinds of engines.—42. Various modes of transmitting force.—43. Description of a factory engine.—44. The governor.—45. The eccentric.—46. The fly-wheel.—47. Parallel motion.—48. Barometer gauge.—49. How to compute the effective moving force of the piston.—50. Method not considered sufficiently accurate.—51. Indicator.—52. Mode of recording its positions.—53. Its application in finding effective force.—54. Watt's counter.—55. Conclusion.

## THE LOCOMOTIVE.

CHAP. I.—1. Familiar to every eye.—2. Its mechanism not generally understood.—3. Object of this Treatise.—4. Two modes of propelling wheel carriages.—5. How locomotive is propelled.—6. Action of piston-rod on wheels.—7. Dead points.—8. Unequal action.—9. How remedied.—10. Connection of piston-rods with wheels.—11. Wheels fixed on their axles.—12. Form of locomotive.—13. Driving-wheels.—14. Coupled wheels.—15. Consumption of steam.—16. Evaporating power of boiler determines efficacy of engine.—17. Fire-box.—18. Tubes through boiler.—19. Fuel.—20. Blast-pipe.—21. Tender.—22. Plans and sections, with their description.

CHAP. II.—23. Speed.—24. Locomotive stock.—25. What record of the performance and condition

of an engine should be kept.—26. Cause of renewals of English locomotives.—27. Average mileage of engines.—28. Locomotive requires rest.—29. Expense of cleaning and lighting.—30. Reserve engines.—31. Bank engines.—32. Time they are kept standing.—33. Economy of fuel.—34. Register of consumption.—35. Small amount of useful service obtained.—36. On Belgian lines.—37. On other Continental lines.—38. On London and North Western line.—39. Comparisons between lines not fairly instituted.—40. Legitimate test of comparison.—41. Amount of locomotive stock required.—42. Gross receipts of European Railways in 1850.—43. Mileage of the same.—44. Great increase since.—45. Enormous consumption of coal.—46. Mileage of passengers and goods.

## STEAM NAVIGATION.

CHAP. I.—1. Inventors of steam navigation uneducated.—2. First steamers on the Hudson and the Clyde.—3. Sea-going steamers due to British engineers.—4. Progress

of steam navigation from 1812 to 1837.—5. Atlantic steamers projected.—6. Abstract possibility of the voyage could not be doubted.—7. The voyage had been already

## CONTENTS.

made by two steamers.—8. Projects advanced in 1836.—9. Discussion at Bristol in 1837.—10. Report of Dr. Lardner's speech in the *Times* of 27th August, showing the falsehood of the report that he pronounced the project impracticable.—11. Atlantic steam voyage advocated by Dr. Lardner in 1836-7.—12. The practical results of the various projects prove the truth of his predictions.—13. The Cunard steamers established on the conditions suggested by him were alone successful.—14. Voyages of these steamers.—15. Other lines established.—16. Probable extension of steam navigation to the general purposes of commerce.—17. Auxiliary steam-power the most probable means of accomplishing this.—18. Advantages of subaqueous propulsion.—19. Means of realising them.—20. Improved adaptation of steam-power to vessels of war required.—21. Mercantile steam-marine available for national defence.—22. Principle of marine-engine.—23. Propellers.—24. Paddle-wheels and screws.—25. Arrangement of paddle-wheels.—26. Paddle-shaft.—27. General arrangement of marine-engine.

CHAP. II.—28. Arrangement of the engine-room; governor and other regulating parts omitted.—29. Flue boilers and tubular boilers.—30. Construction of flue boilers.—31. Tubular boilers.—32. Indications of engineering ignorance.—33. Number and dimensions of tubes.—34. Incrustation produced by sea water.—35. Hydrometric indicators.—37. Thermometric indicators.—38. Seaward's contrivance.—39. Brine-pumps.—40. Blowing out.—41. To detach the scale.—42. Effect of corrosion.—43. Efficiency and economy of fuel.—44. Coating the boiler and pipes with felt.

CHAP. III.—45. Economy of fuel.—46. Width and depth of furnace.

—47. Advantage of expansive action.—48. Siamese engines.—49. Simplified arrangements.—50. Number and position of cylinders.—51. Proportion of diameter to stroke.—52. Oscillating engines.—53. Engines of the "Peterhoff."—54. Propellers.—55. The common paddle-wheels.—56. Feathering paddles.—57. Morgan's paddle-wheel.—58. Field's split paddles.—59. American paddle-wheel.—60. Practical objections to feathering paddles.—61. Proportion of marine engines.—62. Submerged propellers.—63. Their disadvantages.—64. Screw-propellers.—65. Pitch and slip.—66. Manner of mounting screw-propellers.—67. Their various forms.

CHAP. IV.—68. Effect of the screw-propeller, reaction on the vessel.—69. Their best practical proportion.—70. Their varying pitch.—71. Relative advantages of screw and paddle-wheels.—72. Their effects in long sea-voyages.—73. Experiments with the "Rattler" and "Alecto."—74. These experiments continued.—75. Admiralty experiments.—76. Government report.—77. Application of the screw in the commercial marine.—78. Application of screw to mail-vessels. 79. Geared and direct action.—80. Geared engines.—81. Fairbairn's internal gearing.—82. Subdivision of the power among several cylinders.—83. Protection from shot.—84. Regulation of slides.—85. Relative speed of screw and vessel.—86. Engines of the "Great Britain."—87. Engines of the "Arrogant" and "Encounter."—88. Various forms of screw engines.—89. Cross action of H. M.'s screw steam-packet "Plumper."—90. Auxiliary steam-power.—91. Effect of screw-vessels head to wind.—92. Nominal and real horse-power.—93. Official tables of the strength of the steam-navy.

LOCOMOTION BY RIVER AND RAILWAY IN THE  
UNITED STATES.

CHAP. I.—1. Natural apparatus of internal communication in United States.—2. Canal navigation.—3. Erie Canal.—4. Extent of canals.—5. Total cost, and cost per mile.—6. Extent of canals as compared with population.—7. River and coast navigation in United States.—8. Steam navigation on Hudson.—9. Tables of Hudson steamers.—10. Beautifully finished machinery and structure.—11. Their great speed.—12. Application of expansive principle.—13. Explosions on eastern rivers rare.—14. Description of paddle-boards and mode of working steam in steamers of eastern rivers.—15. Power of engines.—16. Fares reduced with increased size of vessels—Form and structure of Hudson steamers.—17. Description of the navigation of that river.—18. Steam navigation of other American rivers.—19. Mississippi steamboats.—20. Cause of explosions.—21. Magnitude and splendour of boats.—22. Extent of the navigation of the Mississippi valley.

CHAP. II.—1. Inland steam navigation.—2. Table of sea-going steam-ships.—3. Towing river steamers.—4. Water goods train.—5. Commencement of railways.—6. Average cost of construction to 1849.—7. Tabular statement of the railways to 1851.—8. Their distribution and general direction.—9. New England lines.—10.

New York lines.—11. New York and Philadelphia.—12. Pennsylvania lines.—13. Great celerity of construction—tabular statement.—14. Extent of lines open and in progress in 1853.—15. Their distribution among the States.—16. Average cost of construction.—17. Railways in central States.—18. General summary.—19. Causes of the low comparative cost of construction.—20. Method of crossing rivers.—21. Modes of construction—rails and curves.—22. Engines.—23. Greater solidity of construction recently practised.—24. Railway carriages.—25. Expedient for passing curves.

CHAP. III.—1. Railways carried to centre of cities—Mode of turning corners of streets.—2. Accidents rare.—3. Philadelphia and Pittsburgh line.—4. Extent and returns of railways.—5. Traffic returns.—6. Western lines—Transport of agricultural produce.—7. Prodigious rapidity of progress.—8. Extent of common roads.—9. Railways chiefly single lines.—10. Organisation of companies and acts of incorporation.—11. Extent of railways in proportion to population.—12. Great advantages of facility of inland transport in the United States.—13. Passengers not classed.—14. Recent report on the financial condition of the United States railways.—15. Table of traffic returns on New England lines.—16. Cuban railways.—17. Recapitulation.

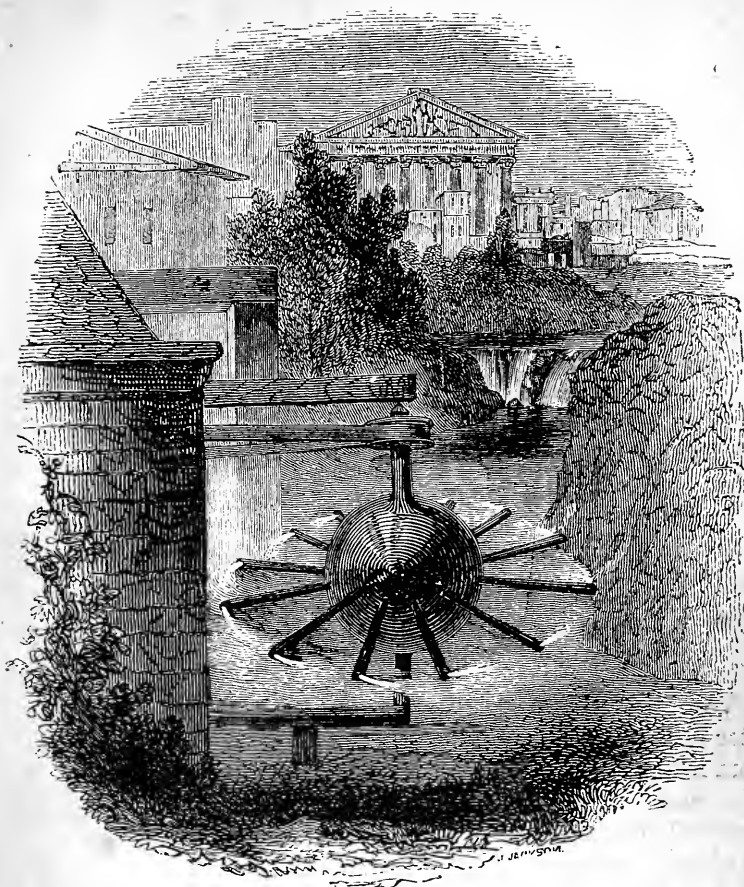

HERO OF ALEXANDRIA.

## STEAM.



1. Power of steam manifested by natural evaporation.—2. Early attempts at its mechanical application—Inventions of Watt.—3. Influence of steam power on mankind.—4. Its agency in commerce and the arts.—5. Analysis of its operation.—6. Combustion of coals.—7. Force developed by the evaporation of water.—8. Steam an invisible aeriform fluid.—9. Measure of the mechanical force developed.—10. Heat absorbed in evaporation.—11. Latent heat of steam.—12. Effect of varying pressure.—13. Mechanical force independent of the pressure.—14. Force developed by expansion.—

15. Force developed by condensation.—16. Application of these three forces in steam engines.—17. Steam may act variously on piston.—18. Furnaces and boilers.—19. Evaporating power of fuel.—20. Means of economising heat.—21. Prevention of loss by radiation.—22. Inspection and reports of Cornish engines.—23. Greatly improved efficiency.—24. Actual mechanical virtue of coals.—25. Illustrations—Pyramids of Egypt.—26. Menai Bridge.—27. Railway engines.—28. Exhaustion of coal mines improbable.—29. Prospects of scientific discovery.

1. THE surface of the globe has been inhabited by the human race for at least fifty or sixty centuries. During that long period their intelligence has been as acute, their interests as exigent, and their craving for material good, as insatiable as at present; yet a natural agent of vast power which existed around them, below them, and above them, whose play was incessant in the air, upon the earth, and in the waters under the earth, remained unobserved and undiscovered until the last century; its powers were imperfectly developed until late in the present century, and its still undeveloped consequences and effects, affecting the well-being and progress, physical, moral, and intellectual, of the whole human race, are such as the most acute and far-sighted cannot foresee. This giant power is STEAM.

Since the day on which the land was divided from the waters by the Word of the Most High, evaporation,—that is the conversion of water into steam,—and condensation,—that is the reconversion of steam into water,—have been incessantly in operation upon a vast scale, and a corresponding amount of mechanical force has been developed and manifested on every part of the globe. By the solar heat, the waters of the ocean have been constantly vaporised and taken up into the higher regions of the air. Assuming there the form of clouds, they have been attracted by the mountains, and the more elevated parts of the land. There condensation has taken place, and the vapour has been re-converted into water, or even reduced by still greater cold to the solid state, and has been precipitated in the form of rain, hail, or snow, more or less, on all parts of the land, but chiefly, and most abundantly, on the summits of mountain chains, and on the more elevated regions. Descending from thence along the surface, they form the streams of rivers, and the torrents of cataracts, manifesting everywhere vast mechanical force, of which man has eagerly availed himself, without reflecting on its origin, or being conscious that he was using the indirect power of steam. By the force exhibited in the flow of rivers, transport from the interior of continents to their coasts has been effected since the earliest times, and among people the least advanced in the arts of life. By the force of cataracts, mills have been worked even in

## WATER POWER PROCEEDS FROM EVAPORATION.

ancient times and among rude nations. In a word, what is called WATER-POWER is, in reality, in all cases, the indirect power of steam, being due to the descent of that mass of liquid which had been previously elevated on so vast a scale by natural evaporation.

2. Nevertheless, these phenomena failed to suggest the artificial application of the same power. It was not until the commencement of the last century that any serious progress had been made towards the solution of that problem. About that time, engines were constructed, in which the elastic force of steam, as well as the force resulting from its re-conversion into water, was applied, as a mechanical power. The engines first constructed were defective, their performance unsatisfactory, and the cost of their maintenance greater than that of the power, which they aspired to supersede. At length, however, towards the middle of the last century, the genius of Watt was fortunately turned to this problem, and those great inventions were made, and improvements effected, the final result of which has been the creation of a power which has exercised a greater influence upon the condition of the human race, material, social, and intellectual, than was ever before recorded in the history of its progress.

3. To enumerate the benefits which the application of steam has conferred upon mankind, would be to count every comfort and every luxury we enjoy, whether physical or intellectual, many of which it has created, and all of which it has augmented in an immense proportion. It has penetrated the crust of the earth, and drawn from beneath it boundless treasures of mineral wealth, which, without its aid, would have remained inaccessible; it has drawn up, in measureless quantity the fuel on which its own life and activity depend; it has relieved men from many of their most slavish toils, and reduced their labour in a great degree to light and easy superintendence. It has increased the sum of human happiness, not only by calling new pleasures into existence, but by so cheapening former enjoyments as to render them attainable by those who before could never have hoped to share them: the surface of the land and the face of the waters are traversed with equal facility by its power; and by thus stimulating and facilitating the intercourse of nation with nation, and the commerce of people with people, it has knit together remote countries by bonds of amity not likely to be broken. Streams of knowledge and information are kept flowing between distant centres of population; those more advanced diffusing civilisation and improvement among those that are more backward. The press itself, to which mankind owes in so large a degree the rapidity of their improvement in

modern times, has had its power and influence increased in a manifold ratio by its union with the steam engine. It is thus that literature is cheapened, and, by being cheapened, diffused; it is thus that Reason has taken the place of Force, and the pen has superseded the sword; it is thus that war has almost ceased upon the earth, and that the differences which inevitably arise between civilised nations are for the most part adjusted by peaceful negotiation.

If this last result of a high state of civilisation and intelligence fails to be manifested, the case can only arise where a barbarous power intervenes, which is deaf to reason, and only controllable by brute force.

4. The steam-engine is a piece of mechanism by which fuel is rendered capable of executing any kind of labour. By it coals are made to spin, weave, dye, print, and dress silks, cottons, woollens, and other cloths; to make paper, and print books on it when made; to convert corn into flour; to press oil from the olive, and wine from the grape; to draw up metal from the bowels of the earth; to pound and smelt it, to melt and mould it; to forge it; to roll it, and to fashion it into every form that the most wayward caprice can desire. Do we traverse the deep?—they lend wings to the ship, and bid defiance to the natural opponents, the winds and the tides. Does the wind-bound ship desire to get out of port?—they throw their arms around her, and place her on the open sea. Do we traverse the land?—they are harnessed to our chariot, and we outstrip the flight of the swiftest bird, and equal in speed the fury of the tempest.

The substance by which these powers are rendered active is one which Nature has provided in boundless quantity in all parts of the earth, and though it has no price, its value is inestimable. This substance is WATER.

5. Those who desire to comprehend clearly and fully this vast agency, to which so much of the advancement and civilisation of mankind is due, must learn successively, 1st. The principles on which heat is evolved from fuel; 2nd. The expedients by which that heat is imparted to water; 3rd. The quantity of it which is absorbed in the conversion of water into steam; 4th. The mechanical power developed in this physical change; and 5th. The mechanism by which that power is applied to industrial uses.

It is obvious that the last of these points would include the exposition of the structure and operation of the varieties of steam-engines which have been applied to the purposes of commerce and manufactures, to railways and navigation. Upon this large subject it is not our present purpose to enter. We shall, however, explain the preceding, so as to enable our readers, with moderate



## COMBUSTION OF FUEL.

attention, to comprehend clearly the origin of the power of steam, and the physical conditions which determine its maintenance and its limits.

6. The general principles upon which heat is developed in the combustion of fuel have been already explained in our Tract on FIRE. It appears from what is there stated, that the varieties of coal are chiefly combinations of carbon and hydrogenous gases, the proportion varying in different sorts, but the carbon entering into its composition in very large proportions in all cases. In different sorts of mineral combustibles, the proportion of carbon varies from 75 to 90 per cent.

When carbon is heated to a temperature of about 700° in an atmosphere of pure oxygen, it will combine chemically with that gas, and the product will be the gas called *carbonic acid*. In this combination heat is evolved in very large quantities. This effect arises from the heat previously latent in the carbon and oxygen being rendered sensible in the process of combustion. The carbonic acid proceeding from the combustion is by such means raised to a very high temperature, and the carbon during the process acquires a heat so intense as to become luminous; no flame, however, is produced.

Hydrogen, heated to a temperature of about 1000°, in contact with oxygen, will combine with the latter, and a great evolution of heat will attend the process; the gases will be rendered luminous, and flame will be produced.\*

If coals, therefore, or other fuel exposed to atmospheric air be raised to a sufficiently high temperature, their combustible constituents will combine with the oxygen of the atmospheric air, and all the phenomena of combustion will ensue. In order, however, that the combustion should be continued, and should be carried on with quickness and activity, it is necessary that the carbonic acid and other products should be removed from the combustible as they are produced, and fresh portions of atmospheric air brought into contact with it; otherwise the combustible would soon be surrounded by an atmosphere composed chiefly of carbonic acid to the exclusion of atmospheric air, and therefore of uncombined oxygen, and consequently the combustion would cease, and the fuel be extinguished. To maintain the combustion, therefore, a current of atmospheric air must be constantly carried through the fuel: the quantity and force of this current must depend on the quantity and quality of the fuel to be consumed. It must be such that it shall supply sufficient oxygen to the fuel to maintain the combustion, and not more than sufficient, since

\* For the full explanation of this process, see Tract on Fire.

any excess would be attended with the effect of absorbing the heat of combustion, without contributing to the maintenance of that effect.\*

The mechanical force of steam is developed in three ways— I. By evaporation; II. By expansion; and III. By condensation. We shall accordingly explain these severally.

7. I.—FORCE DEVELOPED BY EVAPORATION.

To render intelligible the manner in which a mechanical power is developed in the conversion of water into steam, and the circumstances which attend that remarkable

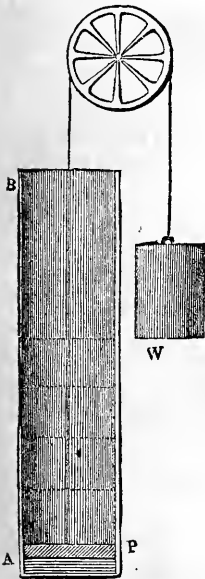

physical change, we will suppose a quantity of pure water deposited in the bottom, A, of a tube, B A, fig. 1. To render the explanation more simple, we will suppose that the area of the section of the tube is equal to a square inch, and that the quantity of water deposited in it is a cubic inch. We will further imagine the tube to be glass, so that the phenomena developed in it may be visible. Let a piston, P, be imagined to be fitted in the tube, air tight and steam tight, and to be placed in immediate contact with the surface of the water, so as to exclude all communication between the water and the air above the piston. In this case the piston would be pressed upon the water by the pressure of the atmosphere upon a square inch of surface added to the weight of the piston itself. But the former pressure is equal to 15 lb.,† and therefore the

pressure on the surface of the water will exceed the weight of the piston by 15lb. Now to simplify our explanation by excluding all reference to the atmospheric pressure, and the particular weight of the piston, P, we shall suppose both of these exactly counterpoised by the weight, w, so that the piston shall be placed in contact with the surface of the water, without, however, exerting any pressure upon it.

These conditions being understood, let a weight, say of 15lb., be placed upon the piston. P, and let a fire, a lamp or any other regular source of heat, be applied to the bottom of the tube. If a thermometer were immersed in the water under the piston, the following effects would then be observed:—

\* See Tract on Fire.

† See Tract on Air.

## EVAPORATION OF WATER.

The thermometer would rise, the piston maintaining its position, and this would continue until the thermometer would rise to the temperature of  $212^{\circ}$ . Upon rising to that temperature the thermometer would remain stationary, and at the same time the piston, *p*, would begin to rise, leaving a space apparently empty between it and the surface of the water. The lamp, or fire, still continuing to impart the same heat to the water, the thermometer nevertheless will remain stationary at  $212^{\circ}$ , but the piston will continue to rise higher and higher in the tube, and if the depth of the water in the bottom of the tube be measured, it will be found that it is constantly diminished. If a sufficiently exact measurement of the decrease of the depth of water, and the height to which the piston is raised could be made, it would be found that the one would bear a fixed and invariable proportion to the other, the height of the piston being always 1669 times the decrease of the depth of water.

In fine, if this process were continued for a sufficient time, and if the tube had sufficient length, the water would altogether disappear from the bottom of the tube, and the piston would be raised 1669 inches, or 139 feet very nearly. For the convenience of round numbers, in a case where the most extreme arithmetical accuracy is not needed, we shall then assume that the piston loaded with 15lb. has been raised 140 feet.

8. After this has taken place the tube below the piston will appear to be quite empty, the water having disappeared, and no visible matter having taken its place. If, however, the tube and its contents were weighed, they would be found to have the same weight precisely as they had when the water was deposited under the piston.

The phenomenon is easily explained. The heat applied to the tube has converted the visible liquid water into invisible steam. It is a great but very common error to suppose that the whitish cloudy vapour which is seen to issue from the safety valve of an engine, or the funnel of a locomotive, or the spout of a boiling kettle, is steam. The semi-transparent matter which floats in the air, and continues to be visible for some time after it escapes from the boiler, is in fact not steam, but water existing in very minute particles, produced by the condensation of the steam by the contact of the colder air. When those particles coalesce and form small drops of water, they either fall to the ground or are evaporated at a lower temperature, and in either case disappear. If the vapour issuing from the safety valve of an engine, or the spout of a boiling kettle, be closely examined, it will not be found to have that cloudy semi-transparent appearance until it has passed to some distance from the point from which it issues.

Pure steam is, in fact, a transparent and invisible elastic fluid like air, and this explains how it is, that in the tube, *A B*, the space below the piston, after the evaporation of the water, *appears* to be empty. It is, however, no more empty than if it were filled with air. It is filled with the invisible elastic vapour into which the water has been converted by the heat which has been applied to it.

9. It remains now to show what is the quantity of mechanical force evolved in this conversion of water into steam, and what quantity of heat has been absorbed in producing it.

From what has been stated above, it appears that the water in passing into vapour has swelled into 1669 times its original bulk, being subject to a compressing force of 15lb. upon the square inch. In thus expanding, the weight of 15lb. has been raised 140 feet, an effect which is mechanically equivalent to 140 times 15lb., that is 2100lb. raised one foot.

10. To estimate the quantity of heat absorbed in producing this effect, let us suppose that in the commencement of this process, the water under the piston has the temperature of  $32^{\circ}$ , and that the lamp, or other source of heat, which is applied to it acts with such uniformity as to impart exactly the same quantity of heat per minute.

Let the time which elapses between the first application of the lamp and the moment at which the water attains the temperature of  $212^{\circ}$  and begins to be evaporated, be observed, and also the interval between the commencement of evaporation and the total disappearance of the water. It will be found that the latter interval is  $5\frac{1}{2}$  times the former. It follows consequently that to convert water at  $212^{\circ}$  into steam requires  $5\frac{1}{2}$  times as much heat as is necessary to raise the same water from  $32^{\circ}$  to  $212^{\circ}$ , or what is the same; the quantity of heat which would convert water at  $212^{\circ}$  into steam would increase the temperature of the same water by  $5\frac{1}{2}$  times  $180^{\circ}$ , that is by  $990^{\circ}$ , if it had remained in the liquid state.

It follows also, that to convert water at  $32^{\circ}$  into steam will take  $6\frac{1}{2}$  times as much fuel as would be sufficient to boil the same water.

11. It may be asked, what becomes of the enormous quantity of heat thus imparted to the water during the process of its evaporation, seeing that the water itself receives no increase of temperature, being maintained steadily at  $212^{\circ}$ , and that the steam into which it is converted has the same temperature? This is answered by showing that the entire quantity of heat which thus disappears to the thermometer is absorbed by the steam, and must in fact be regarded as the immediate cause of its maintaining the elastic or vaporous form. That it is actually contained in the steam, though

## FORCE DEVELOPED IN EVAPORATION.

its presence is not indicated by the thermometer, is incontestably established by the result of the following process:—

Let the steam, at  $212^{\circ}$ , which has been evolved from a cubic inch of water at  $32^{\circ}$ , be mixed with  $5\frac{1}{2}$  cubic inches of water at the temperature of  $32^{\circ}$ . The steam will be at once reconverted into water, and the mixture will be  $6\frac{1}{2}$  cubic inches of water, the temperature of which will be  $212^{\circ}$ . Thus it appears that the steam at  $212^{\circ}$ , when reconverted into a cubic inch of water at  $212^{\circ}$ , parts with as much heat as suffices to raise  $5\frac{1}{2}$  cubic inches of water from  $32^{\circ}$  to  $212^{\circ}$ , which is exactly the quantity of heat which disappeared while the water was converted into steam.

The heat which is thus contained in steam, without affecting the thermometer, is said to be LATENT, and the latent heat of steam is therefore stated to be about  $1000^{\circ}$ , the meaning of which is, that to convert boiling water into steam as much heat must be imparted to it as would raise it  $1000^{\circ}$  higher in temperature if it did not undergo that change of state.

12. In the preceding explanation we have supposed the piston *p* to carry a weight of 15 lb. Let us now consider in what manner the phenomena would be modified if it were loaded with a greater or less weight.

If it were loaded with 30lb., the conversion of the water under it into steam would not commence until the temperature is raised to  $251\frac{1}{2}^{\circ}$ , and when the whole of the water is evaporated, the piston would be raised to the height of only 883 inches, being a very little more than half the height to which it was raised when the evaporation took place under half the pressure. For all practical purposes, then, we shall be sufficiently accurate in stating, that when the weight on the piston *p* is doubled, it will be raised by the evaporation of a given quantity of water to half the height.

In general, in whatever proportion the weight on the piston is increased, the height to which it is raised by the evaporation of a given quantity of water will be decreased, and in whatever proportion the weight is diminished, the height will be increased.

13. It follows, therefore, that in all cases, whatever be the pressure under which the evaporation takes place, the same mechanical force is developed by the evaporation of the same quantity of water. Strictly speaking, there is a little more force with greater pressures, but the difference is so small, and so nearly balanced by certain practical disadvantages attending high pressures, that it may be wholly disregarded.

Since the amount of force developed by each cubic inch of water evaporated is equivalent to 2100 lb. raised one foot, we shall be sufficiently near the truth in stating in round numbers that such a force is equivalent to a ton weight raised a foot high.

## STEAM.

It appears also, that under a pressure of 15 lb. per square inch, water swells into 1669 times its bulk when it is converted into steam. Since a cubic foot is 1728 cubic inches, and since the mean atmospheric pressure is a little under 15 lb., it may be stated with sufficient precision for all practical purposes, that a cubic inch of water, evaporated under the mean atmospheric pressure, will produce a cubic foot of steam.

### 14. II.—FORCE DEVELOPED BY EXPANSION.

Steam, in common with all vapours and gases, exerts a certain mechanical force by its property of expansibility.

To render this source of mechanical power intelligible, let us suppose the piston *p* loaded at first with 60 lb. for example, and under this pressure let the water be evaporated, and the piston raised to the height of 35 feet. The power thus developed will be that due to evaporation alone. But after the evaporation has ceased, and when the piston, with its load of 60 lb., is suspended at the height of 35 feet, let 15 lb. be taken from it, so as to leave a load of only 45 lb. The pressure below the piston being then greater than its load, it will be elevated, and as it is elevated, the steam below it increasing in volume, will be diminished in pressure in the same proportion, until the piston is raised to a height equal to one-third part of 140 feet, when the pressure below it will be equal to the load upon it, and it will remain suspended. During this expansive action of the steam, therefore, 45 lb. have been raised through a height equal to a difference between  $\frac{1}{3}$  and  $\frac{1}{4}$ , that is, through  $\frac{1}{12}$  of 140 feet.

At this point let 15 lb. more be supposed to be removed from the piston, so that its load shall be reduced to 30 lb. The pressure below it being, as before, greater than its load, the piston will be raised, and will continue to rise, until it rise to a height equal to half of 140 feet, when the pressure, reduced by expansion, will become equal to the load, and the piston will again become suspended.

In this interval 30 lb. have therefore been raised by the expansive action of the steam, through the difference between  $\frac{1}{2}$  and  $\frac{1}{3}$ , that is, through  $\frac{1}{6}$  of 140 feet.

Finally, suppose 15 lb. more to be removed, and the piston will rise with the remaining 15 lb. to the height of 140 feet, so that, in this last expansive action, 15 lb. are raised through a height equal to the half of 140 feet.

It is evident that the result of the expansive action may be indefinitely varied by varying the extent of its play.

Meanwhile, whatever may be its amount, it is clearly quite

## EXPANSION AND CONDENSATION.

independent of the process of evaporation, and, indeed, of every property by which vapours are distinguished from air or gases, inasmuch as these latter, being similarly compressed, would similarly expand, and would develop in their expansion precisely the same force.

### 15. III.—FORCE DEVELOPED BY CONDENSATION.

It has been already explained \* that as heat converts water into steam, so, on the other hand, will cold convert steam into water; and as water, in passing from the liquid to the vaporous state, is swelled into a vastly increased volume, so, on the other hand, in passing from the vaporous to the liquid state, it suffers a proportionate diminution of volume. Thus if the evaporation take place under a pressure of 15 lb., a cubic inch of water is dilated into a cubic foot of steam. Now, if by the application of cold this steam is converted into water, it will resume its original dimensions, and will become a cubic inch of water. This change of vapour into water has therefore been called **CONDENSATION**, inasmuch as the matter of which it consists, contracting into a much smaller volume, is rendered proportionally more dense.

This property has supplied another means of rendering steam a mechanical agent. Let us suppose that after the piston *p*, fig. 1, has been raised 140 feet high by the evaporation of a cubic inch of water, the counterpoise, *w*, having descended through the same height, an additional weight of 15 lb. is placed upon *w*, and, at the same time, the lamp withdrawn from the tube and cold applied to its external surface. The steam by which the piston was raised will then be converted into water, or condensed, and will, as at first, fill the bottom of the tube to the height of an inch. The space within the tube above the surface of the water extending to the height of 140 feet, will then be a vacuum, and the atmospheric pressure acting above the piston, not being resisted by any corresponding pressure below it, will force the piston down with a force of 15 lb., and will raise the weight *w*, loaded with the additional 15 lb. through the same height.

Thus, it appears that when steam is condensed, or reconverted into water, by producing a vacuum, it develops a mechanical force equal to that which was developed in the conversion of water into vapour.

The mechanical power developed by the evaporation of water has been sometimes called the *direct* power, and that produced by the conversion of vapour into water the *indirect* power of

\* See Tract on Water.

steam, because the immediate agent in the former case is the elastic force of the steam itself, while the agent in the latter case is the atmospheric pressure, to which effect is given by the vacuum produced by the condensation of steam.

16. The three sources of mechanical power which have been explained, have been used sometimes separately and sometimes together in different forms of steam engine.

In the class of engines commonly called high-pressure engines, the direct power alone is used. In a class of engines, now out of use, called atmospheric engines, the indirect power alone was used. In the engines most generally used in the arts and manufactures, known as low pressure or condensing engines, both powers are used.

To obtain the mechanical effect of the vacuum produced by the condensation of steam, it is not necessary that the atmospheric pressure should be used. If we suppose that while the vacuum is produced below the piston *P*, steam having a pressure equal to that of the atmosphere be admitted to the upper side of it, the piston will be urged downwards into the vacuum with the same force exactly as if the atmosphere acted upon it.

And, in effect, this is the method by which the indirect force of steam is rendered effective in all engines as at present constructed, the piston being in no case exposed to the atmosphere.

17. In the preceding illustration of the power of steam, we have supposed the piston *P* to have the area of a square inch, and to be raised continuously to the height of 140 feet. But it is evident that such conditions are neither necessary nor practicable. If the piston had an area of ten square inches the same amount of evaporation would raise it to the tenth part of the height; but the force with which it would be raised, being at the same time increased in a tenfold proportion, the mechanical effect would be the same, for it is evident that whether 15 lb. be raised 140 feet, or 10 times 15 lb. be raised the 10th part of 140 feet, the same mechanical effect would be produced.

The piston acted upon by the steam, instead of being continuously driven in one direction, may be alternately elevated and depressed, and still the same amount of power will be developed. Thus the evaporation may be continued until the piston has been raised 10 feet. The steam which raised it may then be condensed, and the piston having descended to the bottom of the tube, it may again be raised 10 feet by evaporation as before, and this may be continued indefinitely. In this way, by means of a short tube or cylinder, the mechanical effect attending the evaporation of any quantity of water may be obtained, and this, in



## ACTION OF A PISTON.

fact, is what is accomplished in steam engines as they are practically worked.

The direct and indirect powers of steam may also be easily combined as well in the ascent as in the descent of the piston. If we suppose the upper part of the tube, instead of being open to the atmosphere, to communicate with a reservoir of water, to which, like the bottom of the tube, a lamp or other source of heat is applied, steam may be admitted above the piston *P* as well as below it. Now, if such be the case, it is easy to imagine how the piston can be at the same time affected by the direct and indirect power of the steam. Thus, if we suppose that a vacuum has been formed above it, by the condensation of steam, admitted from the upper reservoir, while steam produced from the lower reservoir acts below it, the piston will be forced upwards by the combined effect of the direct action of the steam below and the indirect action of the condensed steam above, and when the piston has been thus raised, we can imagine that while steam is admitted above it from the upper reservoir, that which is below it may be condensed, in which case it will be forced down by the combined effect of the direct action of the steam above it and the indirect action of the condensed steam below it, and it is evident that such alternate action may be indefinitely continued.

Such is the effect of the broad principle upon which all engines of the class called condensing, or low-pressure engines, are constructed. In their details there are numerous points of great practical importance and of much interest in a mechanical point of view. These arrangements, however, not affecting the principle of steam, regarded in its most general sense, need not here be further noticed. On a future occasion we shall explain such of them as have the greatest popular interest.

18. The apparatus by which the combustion of the fuel is effected, and by which the heat evolved is transmitted to the water to be evaporated, are furnaces and boilers of very various forms and construction, according to the circumstances in which they are applied, the one being adapted to the other, so that as much of the heat shall arrive at the water as the circumstances of their application permit.

19. The quantity of water which would be evaporated, if all the heat evolved in the combustion of a given weight of fuel could be transmitted to the water, is the THEORETICAL EVAPORATING POWER of the fuel, and the quantity of water actually evaporated by it is the PRACTICAL EVAPORATING POWER.

The theoretical evaporating power varies with the quality of the fuel. A given weight of certain species of coal will evolve in combustion a greater or less quantity of heat than other species.

In general, it may be stated that the strongest coals, meaning by that term those which have the greatest evaporating power, are those which are richest in carbon.

The practical evaporating power of a given species of coal varies with the form, construction, and magnitude of the furnace and boiler. That portion of the heat which does not reach the water is dissipated in various ways. A part of it is lost by radiation from the grate; a part by radiation from the boiler; a part is carried by the heated gases of combustion into the chimney. The first two sources of waste of heat are reduced to a very small amount by a variety of ingenious contrivances. But the last is indispensable to the maintenance of the combustion, and ought to be considered as the power by which the furnace is worked, rather than a waste of heat.

20. The grate upon which the fuel is placed is surrounded on every side by parts of the boiler within which water is contained.

In some boilers, even the ash-pit is a part of the surface of the boiler under which there is water. In this case, all the heat radiated from the grate, and the fuel upon it, is transmitted to the boiler; and in all cases the furnace is surrounded on every side, except the bottom of the grate or ash-pit, with surfaces having water within them.

21. The waste of heat by radiation from the surfaces of the boiler, steam-pipes, cylinder, and other parts of the machinery in which steam is contained, or through which it passes, is diminished by various expedients, which in general consist in surrounding such surfaces with packing, casing, or coating, composed of materials which are non-conductors, or at least very imperfect conductors of heat.

In some cases the boiler is built round in brick work. In Cornwall, where economy is carried perhaps to a greater extent than elsewhere, the boiler and steam-pipes are surrounded with a packing of sawdust, which being almost a non-conductor of heat, is impervious to the heat proceeding from the surfaces with which it is in contact, and consequently confines all the heat within the boiler. In marine boilers it has been the practice recently to clothe the boiler and steam-pipes with a coating of felt, which is attended with a similar effect. When these remedies are properly applied, the loss of heat proceeding from the radiation of the boiler is reduced to an extremely small amount. The engine houses of some of the Cornish engines, where the boiler generates steam at a very high temperature, are frequently maintained at a lower temperature than the external air, and on entering them they have in a great degree the effect of a cave.

## ECONOMY OF HEAT.

The cylinders are often cased in wood. The boilers of locomotive engines are always covered with a coating of boards.

By these and many other expedients for the economy of heat, and more especially by the extensive application of the expansive force of steam, the mechanical power evolved from the combustion of coals has been increased to an almost incredible extent.

22. A system of public inspection, of the performance of the engines worked in the mining districts of Cornwall, was established about forty years ago, which has been continued to the present time with the greatest advantage to the mining interests in particular, and to the engineering and commercial world in general. An exact account is kept, and periodical reports published of the quantity of fuel consumed by each engine, and the quantity of work done, the latter being expressed always by an equivalent weight, raised one foot high. The ratio of the fuel consumed to the weight thus raised is called the *DUTY* of the engine.

23. The improved efficiency of steam machinery is illustrated in a striking manner by these reports. It appears by them, that, in 1813, the average mechanical effect of a bushel of coals, applied in the best of the Cornish engines, was 11785 tons raised one foot. In 1837, this duty was 38935 tons raised one foot. The duty was therefore augmented in the ratio of 1 to  $3\frac{1}{3}$ .

The increase of the mechanical efficiency of fuel has still gone on from year to year, and it may now be considered that a bushel of coals, of average quality, applied under good conditions of economy to the most efficient engines, is capable of producing a mechanical effect equivalent to 50000 tons raised one foot.

24. It follows, therefore, that a pound of coal has a mechanical virtue expressed by six hundred tons weight raised one foot high.

25. It is only by comparison with other physical agents that we can duly appreciate this prodigious mechanical power of coals.

It is calculated that the materials composing the great pyramid of Egypt might have been elevated from the level of its base to their actual places by the combustion of 700 tons of coal.

26. Those of the Menai Bridge might have been raised from the level of the water by 400 lb. of coal.

27. A train of coaches weighing 80 tons, and conveying 240 passengers, is drawn from Liverpool to Birmingham, and back from Birmingham to Liverpool by the combustion of 4 tons of coke, the cost of which is 5*l*. To carry the same number of passengers daily on a common road would require an establishment of 20 stage coaches and 3800 horses.

The circumference of the earth measures twenty-five thousand miles; if it were begirt with an iron railway, such a train as above-described, carrying two hundred and forty passengers, would be drawn round it by the combustion of about three hundred tons of coke, and the circuit would be accomplished in five weeks.

28. The enormous consumption of coals produced by the application of the steam-engine in the arts and manufactures, as well as to railways and navigation, has of late years excited the fears of many as to the possibility of the exhaustion of our coal-mines. Such apprehensions are, however, altogether groundless. If the present consumption of coal be estimated at sixteen millions of tons annually, it is demonstrable that the coal-fields of this country would not be exhausted for many centuries.

But in speculations like these, the probable, if not certain progress of improvement and discovery ought not to be overlooked; and we may safely pronounce that, long before such a period of time shall have rolled away, other and more powerful mechanical agents will supersede the use of coal. Philosophy already directs her finger at sources of inexhaustible power in the phenomena of electricity and magnetism. The alternate decomposition and recomposition of water, by electric action, has too close an analogy to the alternate processes of vaporisation and condensation, not to occur at once to every mind: the development of the gases from solid matter by the operation of the chemical affinities, and their subsequent condensation into the liquid form, has already been essayed as a source of power. In a word, the general state of physical science at the present moment, the vigour, activity, and sagacity with which researches in it are prosecuted in every civilised country, the increasing consideration in which scientific men are held, and the personal honours and rewards which begin to be conferred upon them, all justify the expectation that we are on the eve of mechanical discoveries still greater than any which have yet appeared; that the steam-engine itself, with its gigantic powers, will dwindle into insignificance in comparison with the energies of nature which are still to be revealed; and that the day will come when that machine, which is now extending the blessings of civilisation to the most remote skirts of the globe, will cease to have existence except in the page of history.

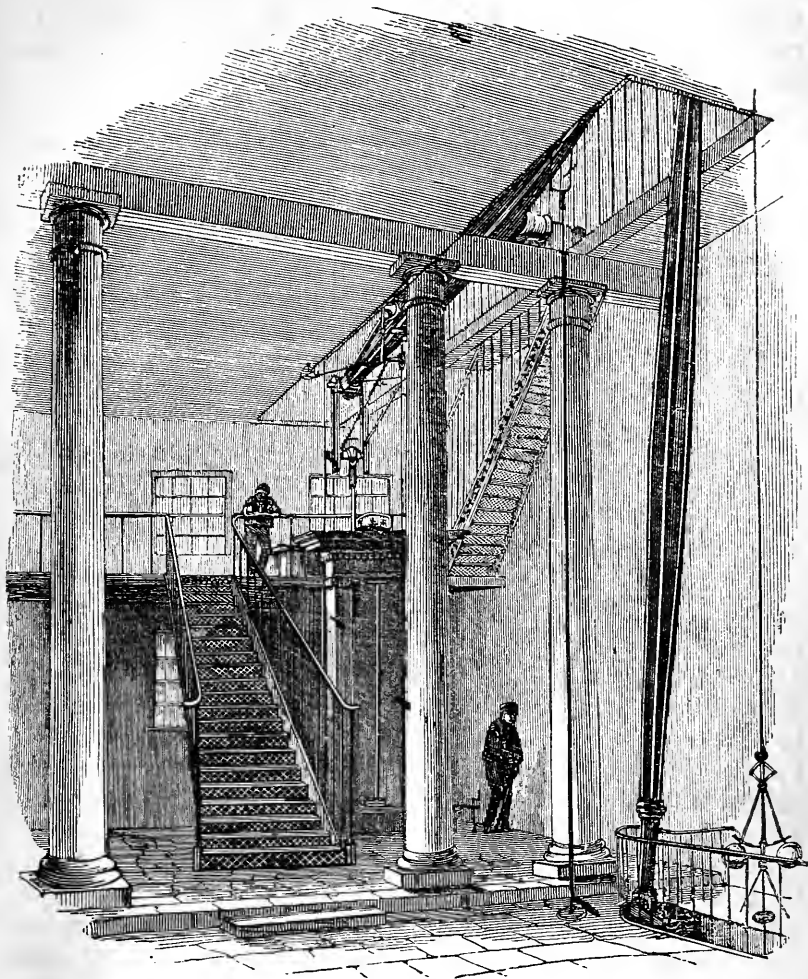

DOUBLE ACTING ENGINE, ZINC WORKS, CITY ROAD, LONDON.

## THE STEAM ENGINE.

### CHAPTER I.

1. The steam engine.—2. Consists of two essential parts.—3. The boiler.—4. Material employed in its formation.—5. Feeding apparatus.—6. Importance of keeping the water in the boiler at a proper level.—7. Wet and dry steam.—8. Priming.—9. Means of ascertaining the level of the water in the boiler.—10. Self-acting feeders.—11. Safety valve.—12. Steam gauge.—13. The furnace.—14. Proper mode of feeding the furnace.—15. Rarely observed.—16. Contrivance for supplying fuel.

1. WHEN the prodigious impetus given to civilisation all over the world, during the last hundred years, by the invention and improvement of the steam-engine is considered, and when it is observed that this, so far from being a temporary influence, is one that has constantly gone on, and still goes on with augmented and vastly accelerated energy,

*Mobilitate viget viresque acquirit eundo,*

it cannot be matter of surprise, that every one endowed with the most moderate gifts of sense and intelligence, whatever may be his position on the social scale, is animated with a strong desire to obtain some knowledge of the extraordinary machine by which results of such vast, enduring, and wide-spread importance have been attained.

Though comparatively few have the time, the inclination, or the peculiar intellectual aptitude to follow out the details of the mechanism of this great invention, as developed in its numerous applications to the various arts of life, all who are by circumstances and education raised above the condition of the rudest and most unskilled labourer have both the time and the mental qualifications to acquire a general acquaintance with the machine, and with the physical principles from which it derives its power. To this large class we now address ourselves, and propose to present them in a very brief compass with a general view of the principle and mechanism of the steam-engine, confining ourselves chiefly to those broad and general features which are common to all varieties of the machine, and discarding for the present such minute details of the mechanism as are applied only in particular forms of steam-engine, and which, though often admirable for ingenuity of design and contrivance, are nevertheless subordinate in interest when brought beside the larger and more general views we now refer to.

2. The steam-engine, whatever be its form or purpose, consists of two essentially different parts; the first, that in which the steam is generated, and the second, that in which the steam is worked. Although these taken together are essential to the performance of the machine, the name steam-engine in its strictest sense would signify only the latter, the former being called the boiler.

3. Boilers vary much in magnitude, form, structure, and even in material, according to the purpose to which they are applied, and the circumstances under which they are used. There are, however, certain characters common to all.

Every boiler consists of a reservoir for the water and steam, and a furnace with its appendages for the combustion of the fuel, the heat evolved from which is the physical agency by which the

## THE BOILER.

evaporation is produced and maintained. The boiler is formed of plates of metal, of suitable thickness, rivetted together, so as to be steam-tight, that is to say, so that steam cannot be forced between them.

The manner in which the plates are rivetted together is shown in fig. 1, the edges of the plates being laid one upon the other and their surfaces forced into steam-tight contact by rivets  $r r'$  passing through holes punched in them, the heads of the rivets being formed by the hammer while the iron is still soft by heat.

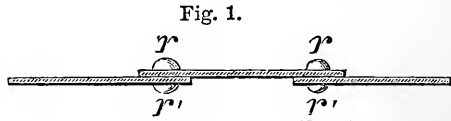

The appearance of the rows of rivets along the edges of the plates composing the boiler is shown in the general view of a waggon-boiler in fig. 7.

4. The material of the boiler is most commonly wrought iron. Copper is sometimes though very rarely used. It has an advantage over iron, inasmuch as it is a better conductor of heat, and is less liable to become incrustated by lime and other earthy matter, which is always held in solution by the water, and precipitated in the process of evaporation. It is also more durable than iron, but is excluded, save in rare and exceptional cases, because of its greater cost.

Cast iron, though cheaper than wrought iron, would be inadmissible for several reasons, one of which is its brittleness. If explosion happened it would fly in pieces, the fragments becoming destructive missiles. In case of explosion wrought iron would be ripped and torn. The one is tough, the other brittle.

5. The boiler is a reservoir not only for water but for steam. The steam, being much lighter, bulk for bulk, than water will always ascend in bubbles through the water, and will collect in the upper parts of the boiler. The space within the boiler, therefore, may be conceived to be divided at a certain level between the water and the steam. All the space below that level is appropriated to the water, all above it to the steam.

But according as the water is converted into steam, the quantity contained in the boiler being proportionally diminished, this level would fall continually lower and lower. That, however, is prevented by a FEEDING APPARATUS, which generally consists of forcing pumps, of adequate power, by which as much water is driven into the boiler as is converted into steam by the furnaces. This feeding apparatus is, in some cases, worked only from time to time to replenish the boiler, in other cases the supply is continual. In the former case, the level which separates the steam from the water alternately rises and falls within certain limits.

## THE STEAM ENGINE.

While the action of the feeding apparatus is suspended it falls gradually as the evaporation proceeds. When it has descended to a certain point the feeding apparatus is put in action and the level rises again to its former limit, after which it is again suspended, and so on. This rise and fall of the level of the water in the boiler is, or ought to be, restrained between such limits, that the level is never either injuriously high or injuriously low.

When the feeding apparatus works incessantly, the water in the boiler is kept always at the same level, the arrangements being such that by a self-adjusting mechanism, the quantity of water supplied to the boiler, from minute to minute, is exactly equal to the quantity evaporated.

6. The importance of keeping the boiler duly supplied with water will be easily understood. So long as those parts of the boiler which are exposed to the action of the furnace are filled with water the metal can never become unduly heated, because all the heat imparted by the furnace is absorbed by the water in evaporation. But if the level of the water were allowed to subside below any part which is exposed to the action of the furnace, the heat acting upon such parts not being taken up by the water, and the steam which in that case would alone be in contact with them, being a slow recipient of heat, the plates of the boiler would soon become red hot, and would consequently be softened, so as no longer to possess the strength necessary to resist the pressure within them, and the boiler would burst. For this reason, it is always of the utmost importance to provide means to ensure such a supply of water as shall prevent the level from ever falling below the highest parts upon which the furnace acts.

Inconvenience of a different kind would be produced by over-feeding, and consequently by raising the level of the water above a certain limit. When the water in a boiler is in a state of strong ebullition, which it always is in the boilers of engines in full operation, bubbles of steam are produced in great quantities in the lowest parts, these being the parts upon which the action of the furnace is most energetic. These bubbles, rising with violence to the surface, throw up the water in spray, so that the part of the boiler above the level of the water is filled with a mixture of pure steam and of particles of water in minute subdivision. The latter, however, fall back into the water by their gravity, provided that the space left for the steam have sufficient height. The upper part of that space will then be supplied with pure steam without intermixture with spray. But if the boiler be over-filled with water, so that the space left for the steam have so little height that more or less spray is mixed even with the highest parts of it, this spray will be drawn into the working part of the



## PRIMING—GAUGE-COCKS.

machine, and will be attended with the two-fold evil of injuring the performance of the engine and wasting a quantity of heat which would otherwise be employed in producing steam, and therefore producing mechanical power.

7. Nevertheless with all practicable precautions spray sometimes issues with the steam from the boiler to the engine. Steam, in this condition, is like the air when a fine misty rain floats in it, and is called WET STEAM by the engineers; the steam when free from this defect being called DRY STEAM. A handkerchief held in dry steam issuing from the valve of a boiler will be no more damped than it would be by a blast of wind; but if the steam be charged more or less with spray, its presence will be shown at once by the moisture it would deposit.

8. The spray with which wet steam is charged is called by the engineers PRIMING.

9. It appears, therefore, that whatever be the form of the machine, or the purpose to which it is applied, it is of great importance so to regulate the feed of the boiler, that the level of the water in it shall neither fall too low nor rise too high.

Considering then the great importance of keeping the level of the water in the boiler within the limits here defined, it will be evident that some expedient ought to be provided by means of which the engineman can at all times ascertain what the level of the water actually is.

Different methods, all more or less efficient and ingenious, have been invented for accomplishing this object.

One of the most simple consists in two common cocks, called gauge cocks, like those used in a beer barrel, which are inserted in the side or end of the boiler, one of which is placed at the lowest, and the other at the highest limit of the water level. If the engineman, on opening the latter, finds that water issues from it, he knows that the level has risen to its highest limit, and he suspends the feed. If, on opening the former, he finds the steam issue from it, he knows that the water level has fallen too low, and he lays on the feed. But so long as water issues from the one and steam from the other, he knows that the water level is within the required limits.

This method, though generally adopted, is not exclusively depended on, and others are used.

A weight  $F$  (fig. 2), half immersed in the water, is supported by a wire, which, passing steam-tight through a small hole in the top, is connected by a flexible string or chain, passing over a wheel  $w$ , with a counterpoise  $A$ , just sufficient to balance  $F$  when half immersed. If  $F$  be raised above the water,  $A$  being lighter will no longer balance it, and  $F$  will descend pulling up  $A$ , and

## THE STEAM ENGINE.

turning the wheel *w*. If *F* be plunged deeper in the water, *A* will more than balance it, and will pull it up, so that the only position

Fig. 2.

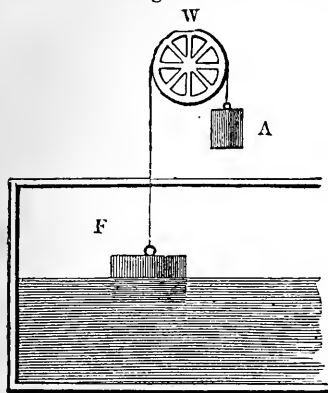

in which *F* and *A* will balance each other is, when *F* is half immersed. The wheel *w* is so adjusted, that when two pins placed on its rim are in the horizontal position, the water is at its proper level. Consequently it follows, that if the water rise above this level, the weight *F* is lifted and *A* falls, so that the pins come into another position, and if it fall lower, *F* falls and *A* rises, so that the pins assume a different position. Thus, in general, the position of the pins becomes an

indication of the quantity of water in the boiler.

Another method is to place a glass tube (fig. 3), with one end *T* entering the boiler above the proper level, and the other end *T'* entering it below the proper level. It must be evident that the water in the tube will always stand at the same level as the water in the boiler, since the lower part has a free communication with that water, while the surface is submitted to the pressure of the same steam as the water in the boiler.

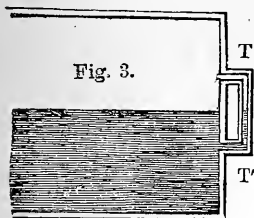

Fig. 3.

This and the last-mentioned gauge have the advantage of addressing the eye of the engineer at once, without any adjustment; whereas the gauge-cocks must be both opened, whenever the depth is to be ascertained.

These gauges, however, require the constant attention of the engine-man; and it becomes desirable either to find some more effectual means of awakening that attention, or to render the supply of the boiler independent of any attention. In order to enforce the attention of the engineman to replenish the boiler when partially exhausted by evaporation, a tube was sometimes inserted at the lowest level to which it was intended that the water should be permitted to fall. This tube was conducted from the boiler into the engine-house, where it terminated in a mouth-piece or whistle, so that whenever the water fell below the level at which this tube was inserted in the boiler, the steam would rush through it, and issuing with great velocity at the mouth-piece, would summon the engineer to his duty with a call that would rouse him even from sleep.

## SELF-ACTING FEEDER.

In the most effectual of these methods, the task of replenishing the boiler must still be executed by the engineer; and the utmost that the boiler itself was made to do, was to give due notice of the necessity for the supply of water. The consequence was, among other inconveniences, that the level of the water was subject to constant variation.

10. To remedy this a method has been invented, by which the engine is made to feed its own boiler. The pipe G (fig. 4), which leads from the hot water pump, terminates in a small cistern c in which the water is received. In the bottom of this cistern, a valve v is placed, which opens upwards and communicates with a feed pipe, which descends into the boiler below the level of the water in it. The stem of the valve v is connected with a lever turning on the centre D, and loaded with a weight F dipped in the water in the boiler in a manner similar to that described in fig. 2, and balanced by a counterpoise A in exactly the same way. When the level of the water in the boiler falls, the float F falls with it, and pulling down the arm of the lever raises the valve v, and lets the water descend into the boiler from the cistern c. When

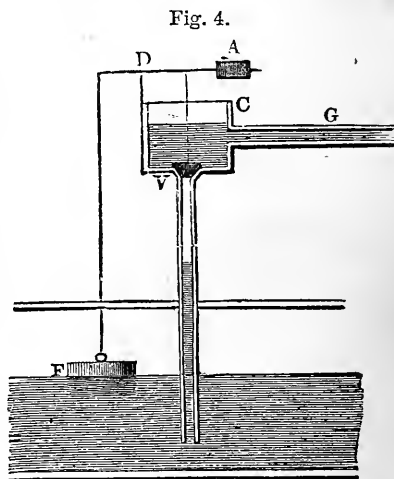

the boiler has thus been replenished, and the level raised to its former place, F will again be raised, and the valve v closed by the weight A. In practice, however, the valve v adjusts itself by means of the effect of the water on the weight F, so as to permit the water from the feeding cistern c to flow in a continued stream, just sufficient in quantity to supply the consumption from evaporation, and to maintain the level of the water in the boiler constantly the same.

By this arrangement the boiler is made to replenish itself; or, more properly speaking, it is made to receive such a supply, as that it never wants replenishing—an effect which no effort of attention on the part of an engineman could produce. But this is not the only good effect produced by this contrivance. A part of the steam which originally left the boiler, having discharged its duty in moving the engine, is lodged in the hot well c (fig. 4), and is again restored to the source from which it came, bringing back to the boiler all the unconsumed portion

## THE STEAM ENGINE.

of its heat preparatory to being once more put in circulation through the machine.

Another method of arranging a self-regulating feeder is shown in fig. 5. A is a hollow ball of metal attached to the end of a lever, whose fulcrum is at B. The other arm of the lever C is connected with the stem of a spindle valve, communicating with a

Fig. 5.

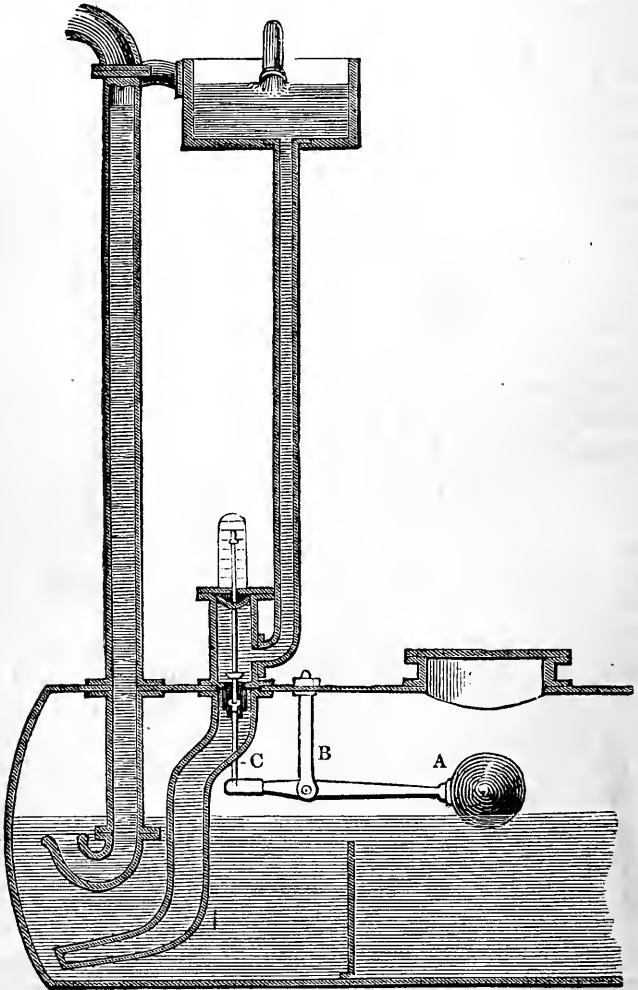

tube which receives water from the feeding cistern. Thus, when the level of the water in the boiler subsides, the ball A preponderating over the weight of the opposite arm, the lever falls, the arm C rises and opens the valve, and admits the feeding water.

## SAFETY VALVE.

This apparatus will evidently act in the same manner and on the same principles as that already described.

11. In different applications of the engine, steam of different pressure is required. The pressure of steam is usually expressed by stating the number of pounds weight upon each square inch of surface which would exactly resist or balance it. All boilers are provided with a valve which opens outwards, and which is loaded with a certain limited and regulated weight. When the bursting pressure with which the steam urges this valve exceeds the weight with which it is loaded, the valve yields, is opened, and the steam escapes through it, and thus continues to escape until the quantity pent up in the boiler is so diminished, that its pressure upon the valve no longer exceeds the weight with which the valve is loaded. When this happens, the valve will remain closed, but will be ready to yield and to open upon the least increase of the pressure of the steam.

Such a valve is called a "safety valve" for the obvious reason that it prevents the pressure of the steam in the boiler from ever attaining such a force as would endanger the boiler.

It sometimes happens that it is necessary to vary from time to time the pressure of the steam according to the work to which the engine is applied, and consequently to vary the weight upon the safety valve. In such cases it is usual to provide two safety valves, one of which shall be regulated by the engineer, and the other placed out of his power. The latter in that case is loaded with the greatest pressure which the boiler can bear without danger; so that even though the engineer should indiscreetly load the valve left at his disposition beyond the limit of safety, the other valve would yield the moment the steam attained a dangerous pressure.

Safety valves are of numerous forms. They consist usually of a circular aperture cut in the boiler, with conical edges inclining from within outwards. In this is placed a circular plate or stopper of corresponding size, with corresponding conical edges, so that it shall exactly fit the aperture; and when pressed upon it, the conical edges shall be in steam-tight contact. This circular plate is attached at its centre to an iron rod, which rises perpendicular to it. Upon this rod sliding weights are placed so as to press down the valve with a greater or less force, according as their number is increased or diminished.

In the general view of a boiler of the form called waggon boiler, shown in fig. 7, the safety valve is shown at N. It is provided with a handle, by means of which the engineman can raise it when necessary.

12. It is necessary to provide a ready method of indicating at all

times the actual pressure of the steam in the boiler. Various methods are used for this purpose. In boilers where steam of great pressure is used, the pressure is indicated by a spring gauge, similar in its principle to those used for steel yards to weigh bodies in commerce. The pressure of the steam acts against a valve which is connected with the arm of the lever of the steel-yard, the other arm being connected with the spring. In this way the varying tension of the spring is made to measure the pressure on the valve.

When steam of low pressure is used, an expedient called a mercurial steam gauge is used. A bent tube containing mercury is inserted into some part of the apparatus, which has free communication with the steam. Let

Fig. 6.

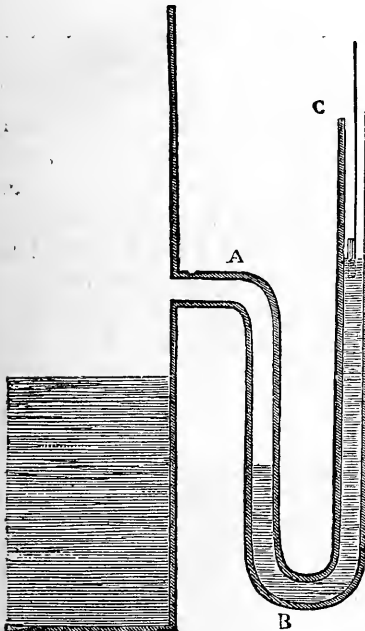

A B C (fig. 6), be such a tube. The pressure of the steam forces the mercury down in the leg A B, and up in the leg B C. If the mercury in both legs be at exactly the same level, the pressure of the steam must be exactly equal to that of the atmosphere; because the steam pressure on the mercury in A B balances the atmospheric pressure on the mercury in B C. If, however, the level of the mercury in B C be above the level of the mercury in B A, the pressure of the steam will exceed that of the atmosphere. The excess of its pressure above that of the atmosphere may be found by observing the difference of the level of the mercury in the tubes B C and B A, allowing a pressure of one pound on each square

inch for every two inches in the difference of the levels.

If, on the contrary, the level of the mercury in B C should fall below its level in A B, the atmospheric pressure will exceed that of the steam, and the quantity of the excess may be ascertained exactly in the same way.

If the tube be glass, the difference of levels of the mercury would be visible; but it is most commonly made of iron; and, in order to ascertain the level, a thin wooden rod with a float is inserted in the open end of B C, so that the portion of the stick within the tube indicates the depth of the level of the mercury below its mouth.

## STEAM GAUGE—FURNACE.

13. The most important appendage of the boiler is the furnace, which consists of a grate, upon which the fuel is maintained in combustion,—a system of flues, by which the flame and heated gases proceeding from the fuel in combustion are conducted in contact with the boiler, so as to impart more or less of their heat to the boiler, and, in fine, a chimney by which these gases escape into the atmosphere, and which maintains the draft necessary to give effect to the combustion.

The explanation of the furnace and its appendages, as well as that of the boiler already given, will be rendered much more easily intelligible by the aid of the figures 7, 8, 9, and 10, which, though they represent a particular form of boiler, indicate those provisions and arrangements which are most generally used in boilers of all forms.

The form here represented is called the waggon-boiler, and consists of a semi-cylindrical top, flat perpendicular sides, flat ends, and a slightly concave bottom. The steam intended to be used in boilers of this description does not exceed the pressure of the external atmosphere by more than from 3 to 5lbs. per square inch; and the flat sides and ends, though unfavourable to strength, can be constructed sufficiently strong for this purpose. In a boiler of this sort, the air and smoke passing through the flues that are carried round it, are in contact at one side only with the boiler. The brickwork, or other materials forming the flue, must therefore be non-conductors of heat, that they may not absorb any considerable portion of heat from the air passing in contact with them.

A perspective view of the boiler and furnace is presented in fig. 7. The grate and a part of the flues are rendered visible by the removal of a portion of the surrounding masonry in which the boiler is set. The interior of the boiler is also shown by cutting off one half of the semi-cylindrical roof. A longitudinal vertical section is shown in fig. 8, and a cross section in fig. 9. A horizontal section taken above the level of the grate, and below the level of the water in the boiler, shewing the course of the flues, is given in fig. 10. The corresponding parts in all the figures are marked by the same letters.

14. The door by which fuel is introduced upon the grate is represented at A, and the door leading to the ash-pit at B. The fire bars at C slope downwards from the front at an angle of about  $25^{\circ}$ , giving a tendency to the fuel to move from the front towards the back of the grate. The ash-pit D is constructed of such a magnitude, form, and depth, as to admit a current of atmospheric air to the grate-bars, sufficient to sustain the combustion. The form of the ash-pit is usually wide below, contracting towards the top.

## THE STEAM ENGINE.

The fuel, when introduced at the fire-door A, should be laid on that part of the grate nearest to the fire-door, called the dead plates: there it is submitted to the process of coking, by which the gases and volatile matter which it contains are expelled, and

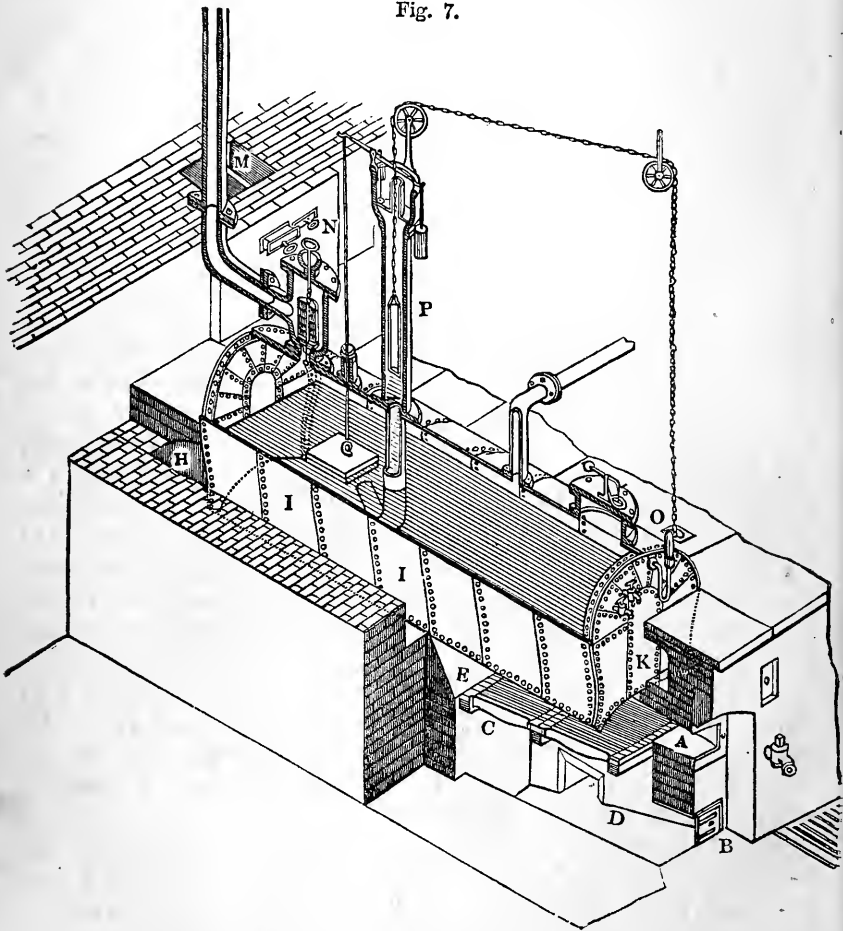

being carried by a current of air admitted through small apertures in the fire-door over the burning fuel in the hinder part of the grate, they are burnt. When the fuel in front of the grate has been thus *coked*, it is pushed back, and a fresh feed introduced in front. The coal thus pushed back soon becomes vividly ignited, and by continuing this process, the fuel spread over the grate is maintained in the most active state of combustion at the hinder part of the grate. By such an arrangement, the smoke produced by the combustion of the fuel may be burnt before it enters the



## FURNACE AND ITS APPENDAGES.

flues. The flame and heated air proceeding from the burning fuel arising from the grate, and rushing towards the back of the furnace, passes over the *fire-bridge* E, and is carried through the flue F which passes under the boiler. This flue (the cross section of which is shown in fig. 9, by the dark shade put under the boiler), is very nearly equal in width to the bottom of the boiler, the space at the bottom of the boiler, near the corners, being only what is sufficient to give the weight of the boiler support on the

Fig. 8.

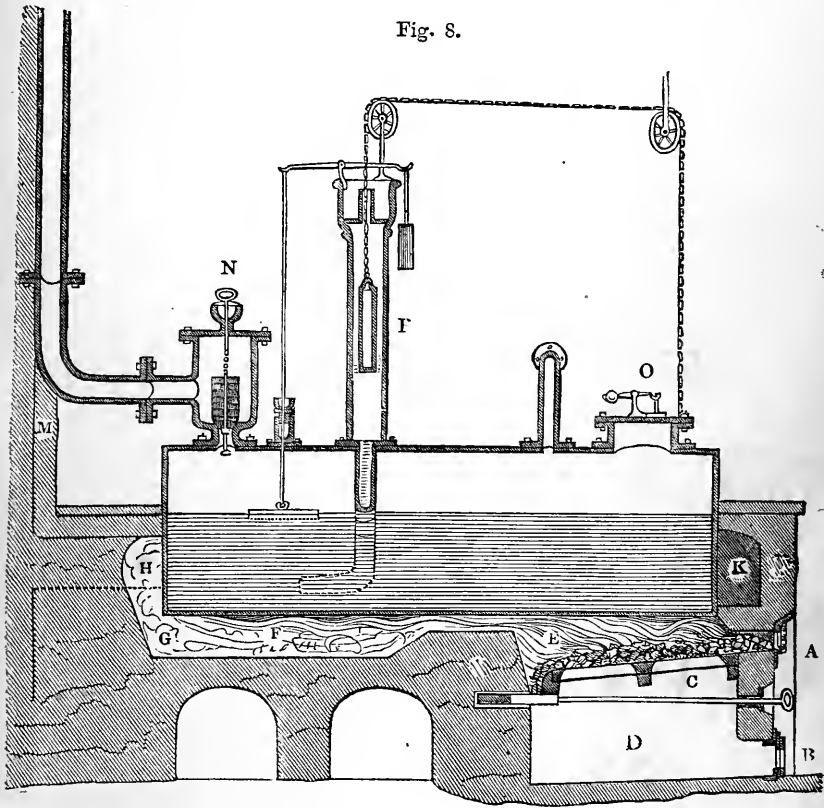

masonry forming the sides of the flue. The bottom of the boiler being concave, the flame and heated air as they pass along the flue rise to the upper part by the effects of their high temperature, and *lick* the bottom of the boiler from the fire-bridge at E to the further end G.

At G the flue rises to H, and turning to the side of the boiler at I I, conducts the flame in contact with the side from the back to the front; it then passes through the flue K across the front, and returns to the back by the other side flue L. The side flue is represented, stripped of the masonry, in fig. 7, and also appears in

## THE STEAM ENGINE.

the plan in fig. 10, and in the cross section in fig. 9. The course of the air is represented in fig. 10 by the arrows. From the flue *L* the air is conducted into the chimney at *M*.

By such an arrangement, the flame and heated air proceeding from the grate are made to circulate round the boiler, and the length and magnitude of the flues through which they are conducted should be such, that when they arrive at the chimney their temperature shall be reduced, as nearly as is consistent with the maintenance of draught in the chimney, to the temperature of the water.

15. The method of feeding the furnace, which has been described above, is one which, if conducted with skill and care, would pro-

Fig. 9.

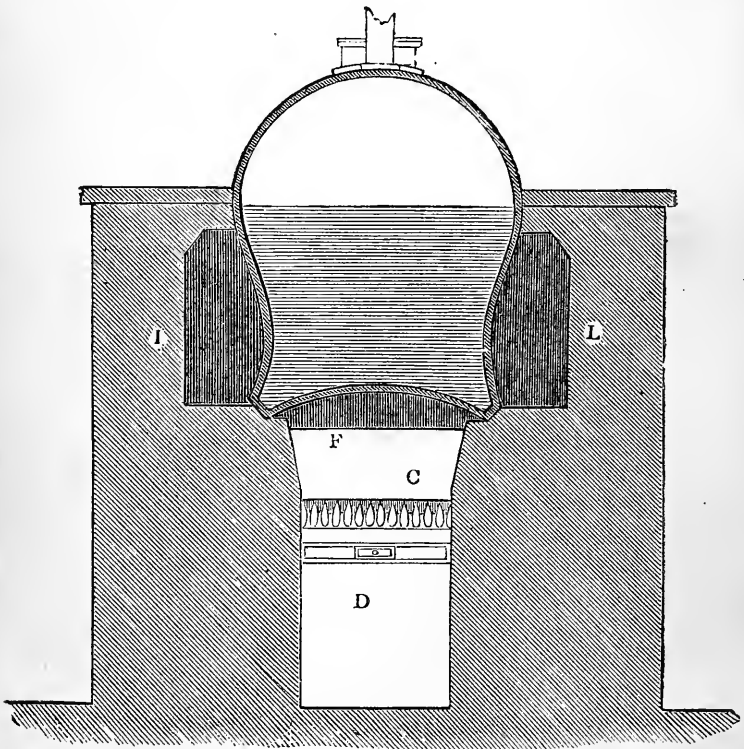

duce a much more perfect combustion of the fuel than would attend the common method of filling the grate from the back to the front with fresh fuel, whenever the furnace is fed. This method, however, is rarely observed in the management of the furnace. It requires the constant attention of the stokers (such is the name given to those who feed the furnaces). The fuel must

## FURNACE AND ITS APPENDAGES.

be supplied, not in large quantities, and at distant intervals, but in small quantities and more frequently. On the other hand, the more common practice is to allow the fuel on the grate to be in a great degree burned away, and then to heap on a large quantity of fresh fuel, covering over with it the burning fuel from the

Fig. 10.

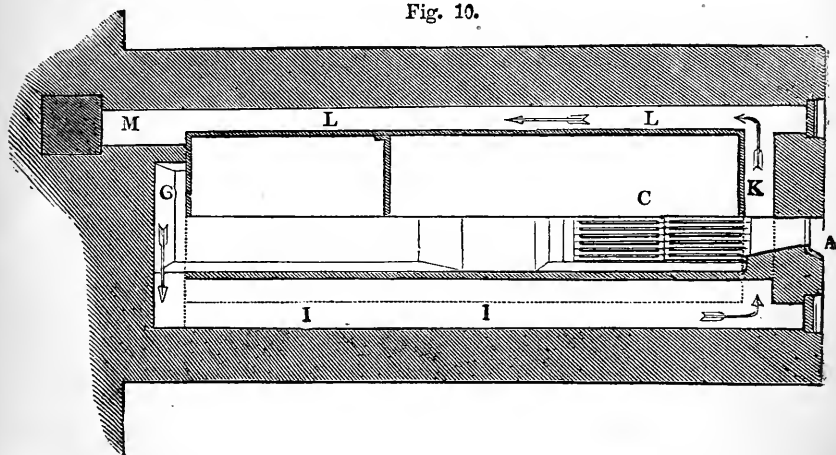

back to the front of the grate. When this is done, the heat of the ignited coal acting upon the fresh fuel introduced, expels the gases combined with it, and, mixed with these, a quantity of carbon, in a state of minute division, forming an opaque black smoke. This is carried through the flues and drawn up the chimney. The consequence is, that not only a quantity of solid fuel is sent out of the chimney unconsumed, but the hydrogen and other gases also escape unburned, and a proportional waste of the combustible is produced; besides which, the nuisance of an atmosphere filled with smoke ensues. Such effects are visible to all who observe the chimneys of steam vessels, while the engine is in operation. When the furnaces are thus filled with fresh fuel, a large volume of dense black smoke is observed to issue from the chimney. This gradually subsides as the fuel on the grate is ignited, and does not reappear until a fresh feed is introduced.

16. The former method of feeding, by which the furnace would be made to consume its own smoke, and the combustion of the fuel be rendered complete, is not however free from counteracting effects. In ordinary furnaces the feed can only be introduced by opening the fire-doors, and during the time the fire-doors are opened a volume of cold air rushes in, which passing through the furnace is carried through the flues to the chimney. Such is the effect of this in lowering the temperature of the flues, that in many cases the loss of heat occasioned is greater than any economy

## THE STEAM ENGINE.

of fuel obtained by the complete consumption of smoke. Various methods, however, may be adopted by which fuel may be supplied to the grate without opening the fire-doors, and without disturbing the supply of air to the fire. A hopper built into the front of the furnace, with a moveable bottom or valve, by which coals may be allowed to drop in from time to time upon the front of the grate, would accomplish this.

In order to secure the combustion of the gases evolved from the coals placed in the front of the grate, it is necessary that a supply of atmospheric air should be admitted with them over the burning fuel. This is effected by small apertures or regulators, provided in the fire-doors, governed by sliding plates, by which they may be opened or closed to any required extent.

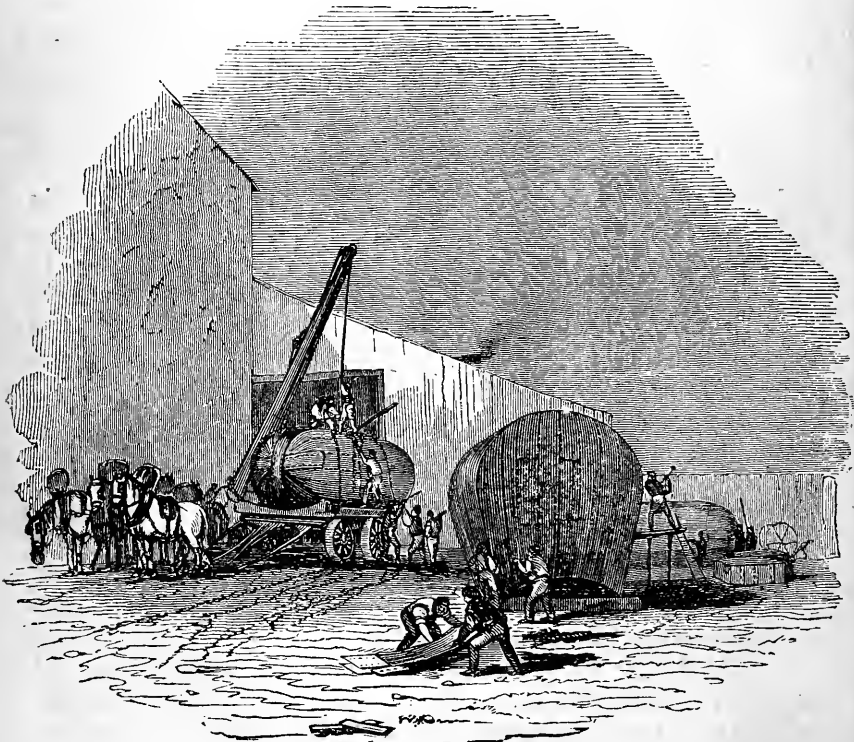

BOILER MANUFACTORY.

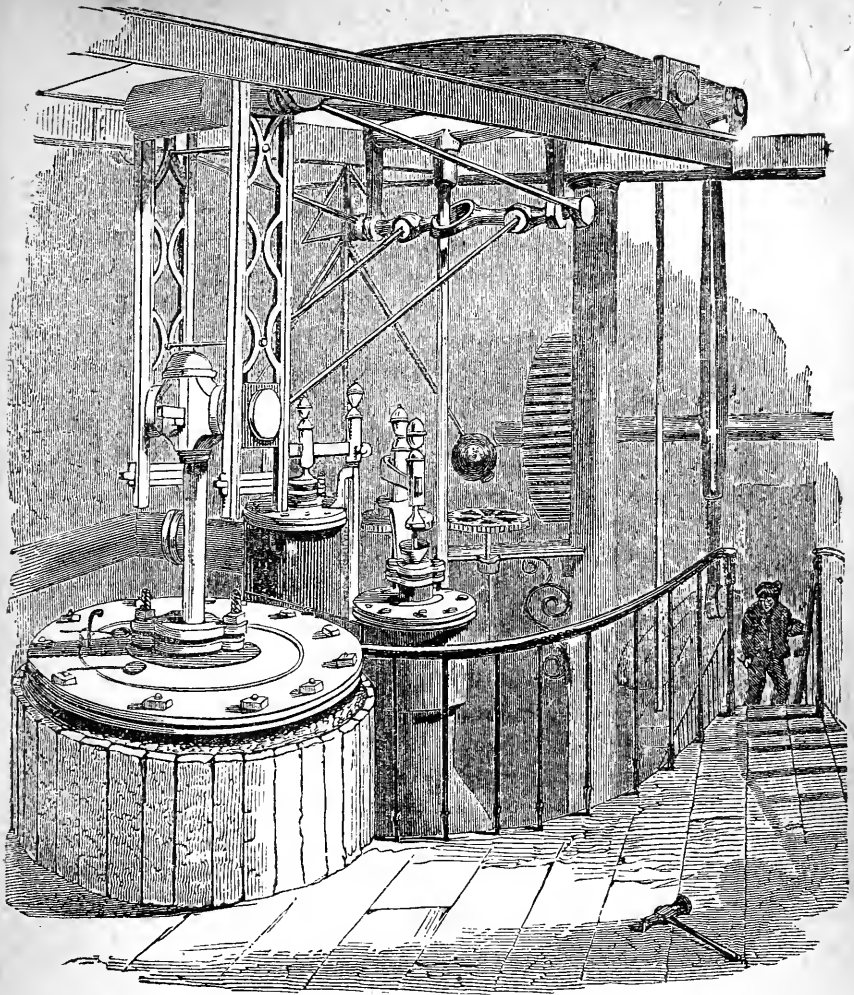

DOUBLE-ACTING ENGINE—CITY SAW-MILLS.

## THE STEAM ENGINE.

### CHAPTER II.

17. Method of regulating the activity of the furnace.—18. How steam is made to produce a mechanical effect.—19. The cylinder and piston.—20. Metallic pistons.—21. Estimate of the force with which the piston is moved.—22. Transmission of this force.—23. Piston rod.—24. Cocks, valves, and slides.—25. How employed.—26. Stroke of the engine.—27. Effective pressure.—28. Supply of steam to the cylinder.—29. By valves.—30. By slides.—31. Seaward's slides.—32. Single cock.—33. Four-way cock.—34. Low and high pressure, more properly called condensing and non-condensing, engines.—35. Objections

to the latter and countervailing advantages.—36. Condensing engines.—37. Condensing apparatus.—38. Air-pump.—39. Cold water pump.—40. Hot water pump.

17. WHATEVER be the form of boiler used, its magnitude and proportions, as well as those of the furnaces and their appendages, must be determined by the rate at which the steam is required to be produced, and in some degree also by the quality of the fuel.

The principle upon which a chimney more or less lofty produces a draft through the fuel in a fire-place in connection with it, has been already explained in our Tract on "Fire." The chimney connected with the furnace of a steam-boiler acts on the same principle, and its dimensions and height must necessarily be proportionate to those of the furnace, and to the quantity of fuel to be consumed in a given time.

But since the evaporation produced in the boiler requires to be varied with the varying work exacted from the engine; and since this evaporation will necessarily be proportionate to the rate at which the fuel is consumed in the furnace, it follows that the rate of combustion in the furnace should be varied with the varying power to be exacted from the engine. In order, therefore, to maintain this proportion between the force of the furnace and the demands upon the engine, it is necessary to stimulate or mitigate the furnace, as the evaporation is to be augmented or diminished.

The activity of the furnace must depend on the current of air which is drawn through the grate bars, and this will depend on the magnitude of the space afforded for the passage of that current through the flues. A plate called a *damper* is accordingly placed with its plane at right angles to the flue, so that by raising and lowering it in the same manner as the sash of a window is raised or lowered, the space allowed for the passage of air through the flue may be regulated. This plate might be regulated by the hand, so that by raising or lowering it the draught might be increased or diminished, and a corresponding effect produced on the evaporation in the boiler: but the force of the fire is rendered uniformly proportional to the rate of evaporation by the following arrangement, without the intervention of the engineer. The column of water sustained in the feed pipe (figs. 7, 8), represents by its weight the difference between the pressure of steam within the boiler and that of the atmosphere. If the engine consumes steam faster than the boiler produces it, the steam contained in the boiler acquires a diminished pressure, and consequently the column of water in the feed pipe will fall. If, on the other hand, the boiler produce steam faster than the engine consumes it, the accumulation of steam in the boiler will cause an increased pressure on the water it contains, and thereby increase the height

## SELF-REGULATING DAMPER.

of the column of water sustained in the feed pipe. This column, therefore, necessarily rises and falls with every variation in the rate of evaporation in the boiler. A hollow float P is placed upon the surface of the water of this column; a chain connected with this float is carried upwards, and passed over two pulleys, after which it is carried downwards through an aperture leading to the flue which passes beside the boiler: to this chain is attached the damper. By such an arrangement it is evident that the damper will rise when the float P falls, and will fall when the float P rises, since the weight of the damper is so adjusted, that it will only balance the float P when the latter rests on the surface of the water.

Whenever the evaporation of the boiler is insufficient, it is evident from what has been stated, that the float P will fall and the damper will rise, and will afford a greater passage for air through the flue. This will stimulate the furnace, will augment its heating power, and will therefore increase the rate of evaporation in the boiler. If, on the other hand, the production of steam in the boiler be more than is requisite for the supply of the engine, the float will be raised and the damper let down, so as to contract the flue, to diminish the draught, to mitigate the fire, and therefore to check the evaporation. In this way the excess, or defect, of evaporation in the boiler is made to act upon the fire, so as to render the heat proceeding from the combustion as nearly as possible proportional to the wants of the engine.

18. Having thus explained generally the principal expedients by which the efficiency of the boiler and furnace of a steam-engine is maintained, it will be only necessary to add, that although these expedients, in the forms in which they are represented in the diagrams, will not be found in every steam boiler, yet equivalents to them in other forms or positions are almost universal. In certain cases the self-regulating apparatus of the boiler and furnace are excluded by want of the necessary height, and then the proper regulation of the machine must depend on the skill and vigilance of those who are in charge of it.

Supposing, then, that by these or other similar or equivalent provisions a supply of steam in the necessary quantity and of the requisite pressure is obtained, it remains to show how the steam is made to produce the desired mechanical effect.

The method universally adopted to render the power of steam available for mechanical purposes is that of a solid piston moving freely in a hollow cylinder in steam-tight contact with its sides. The steam is admitted alternately at one end and at the other, of the cylinder. When it is let in at either end, it is permitted to escape by the other, so that the piston is blown by the steam alternately from end to end of the cylinder. The ends of the

## THE STEAM ENGINE.

cylinder are closed by steam-tight covers, but proper openings are provided for the alternate admission and escape of the steam.

19. The cylinder is made of cast iron of adequate thickness and strength. It is bored with the nicest precision, so that its inner surface is truly cylindrical and of uniform diameter from end to end. The piston is also made of iron, and its contact with the cylinder is rendered steam-tight, either by a packing of hemp and soft rope, called gasket, which fills a circular groove or channel surrounding the piston, or by constructing the external rim of the piston of several metallic segments, which are urged against the side of the cylinder by springs which act upon them from the centre of the piston.

A section of a packed piston is given in fig. 11. The hollow

Fig. 11.

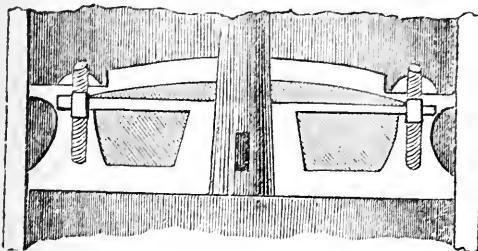

groove containing the packing is represented at the sides next the cylinder, and the top is attached to the piston by screws, by turning which the packing is compressed so as to be forced outwards against the sides of the cylinder

until it is in steam-tight contact with them.

20. Pistons which maintain steam-tight contact with the cylinder without packing, and which are called metallic pistons,

Fig. 12.

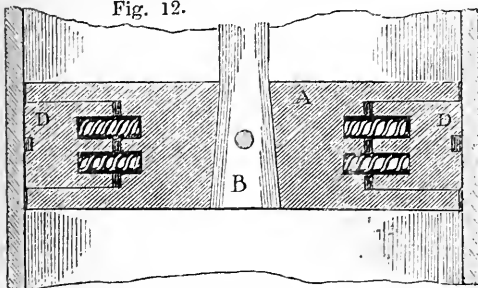

are of very various construction, though all of essentially the same principle. One of these is represented in section in fig. 12, and in plan in fig. 13, p. 21. A deep groove, square in its section, is formed around the piston,

so that while the top and bottom form circles equal in magnitude to that of the cylinder, the intermediate part of the body forms a circle less than the former by the depth of the groove. Let a ring of brass, cast iron, or cast steel, be made to correspond in magnitude and form with this groove, and let it be divided, as represented in fig. 13, into four segments *c c c c*, and four corresponding angular pieces, *D D D D*. Let the groove which surrounds the piston be filled by the four segments with the four wedge-like angular pieces within them, and let the latter be urged against the former by eight spiral springs, as represented



## PISTONS.

in fig. 12 and fig. 13. These springs will abut against the solid centre of the piston, and will urge the segments c against the cylinder. The spiral springs which urge the wedges are confined in their action by steel pins which pass through their centre, and by being confined in cylindrical cavities worked into the wedges and into corresponding parts of the solid centre of the piston, as the segments c wear, the springs urge the wedges outwards, and the points of the latter protruding, are gradually worn down so as to fill up the spaces left between the segments, and thus to complete the outer surface of the piston.

21. The force with which the piston is moved from end to end of the cylinder is estimated by the pressure of the steam which acts upon it, diminished by the reaction of the steam escaping from the side towards which it moves, and the resistance produced by its friction against the sides of the cylinder.

22. The mechanical force with which the piston is thus moved would be practically useless unless an expedient were provided by which it could be transmitted to some convenient point outside the cylinder, and since it is essential that the steam which impels the piston shall be confined within the cylinder, and that no air be allowed to enter, so as to react on the other side of the piston by its pressure, it is also essential that whatever be the means of transmitting the force of the piston to the outside of the cylinder, it shall be accomplished without leaving any interstitial space through which steam can escape or air enter.

23. This object is perfectly attained by a very simple contrivance. A hole is made through the centre of the piston, in which a truly formed cylindrical iron rod, called the piston-rod, is inserted and firmly fixed by a key or lynch-pin. This piston-rod passes through a hole made in the iron cover of the cylinder, as shown in fig. 14. The piston-rod is kept in steam-tight contact with the edges of the hole by a contrivance called a *stuffing box*, B, represented in fig. 14. The hole made in the cover of the cylinder is very little greater in magnitude than

Fig. 13.

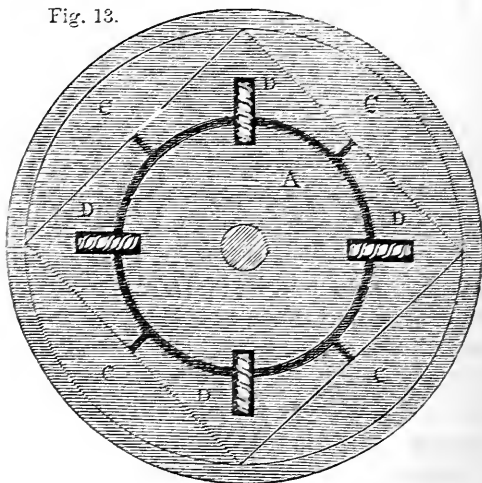

## THE STEAM ENGINE.

the diameter of the piston rod. Above this hole is a cup, in which, around the piston, is placed a stuffing of hemp or tow, which is saturated with oil or melted tallow. This collar of

Fig. 14.

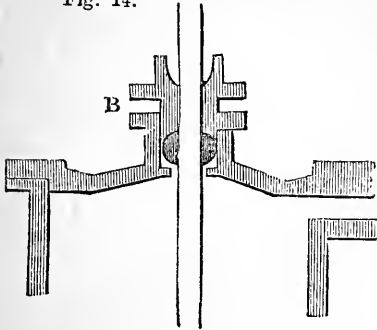

hemp is pressed down by another piece, also perforated with a hole through which the piston rod plays, and which is screwed down on the said collar of hemp.

The piston-rod, by this contrivance, being moved with the same alternate motion, and the same force as the piston itself, can be made to impart that force to any suitable piece of mechanism outside the cylinder, with

which it may be put in connection.

24. Since the ends of the cylinder are closed by metallic covers, in the manner explained above, the openings for the exit and entrance of the steam at the ends, are placed, not in the covers, but in the sides, at points in immediate contiguity with the covers. These openings are governed by contrivances of various forms, and variously denominated COCKS, VALVES, and SLIDES.

25. Let two openings be imagined to be provided at each end of the cylinder, one leading from the boiler, and the other for the escape of the steam. Let stop-cocks, or valves, or sliding shutters, be adapted to these openings, so that they can be closed or opened by acting upon the handles of the cock valve or slide, and let these handles be supposed to be put in such connection with the piston-rod that when the piston arrives at either end of the cylinder the handles are driven by the rod, so as to open the passage which admits steam to the end of the cylinder at which the piston has arrived, and to close the passage which is provided for its escape, and, on the contrary, to open the passage for the escape of the steam from the other end of the cylinder, and to close the passage for its admission from the boiler. By this means the piston, being acted upon by the steam at the end at which it has arrived, and, being relieved from the action of the steam on the other side of it, will be driven to the other end of the cylinder where the piston-rod will again act upon the handles of the cocks, valves, or slides, so as to reverse the flow of the steam, allowing that which has just impelled the piston to escape, and introducing steam from the boiler to the end of the cylinder at which the piston has just arrived. In this way the piston will be driven back to the other end of the cylinder, and so on alternately from end to end.

## VALVES AND SLIDES.

26. We are accustomed to consider the cylinder in a vertical position, to call the covers of its ends the top and bottom, and to speak of the up stroke and the down stroke of the piston. Such is very often the position of the apparatus, but it is not necessarily nor always so. The cylinder is often horizontal. It is almost always so, for example, in locomotive engines, and often so in steamboat engines. It is sometimes placed in an inclined position, and is sometimes moveable, changing its position with the motion of the piston.

The motion of the piston from end to end of the cylinder is called its **STROKE**, and the dimensions are usually expressed by stating the diameter of the piston and the length of the stroke.

27. The **EFFECTIVE PRESSURE** of steam per square inch on the piston is found by deducting from the actual pressure the reaction of the steam escaping, and the friction. This effective pressure being multiplied by the number of square inches in the piston, which is known by its diameter, gives the total effective force of the piston, and this force, multiplied by the number of feet through which the piston moves per minute, which is known by the length of the stroke, and observing the number of strokes per minute, will give the actual mechanical force produced per minute by the steam acting on the piston.

28. From what has been explained it will be apparent that much of the efficiency of the machine must depend upon the precision and regularity with which the steam is alternately admitted to and withdrawn from either end of the cylinder. If it be admitted or withdrawn too soon or too late, it will either obstruct the force of the piston, or delay its return to the other end of the cylinder. For these reasons, and also because there is much beauty and ingenuity in the contrivances by which the steam is admitted and withdrawn, we shall here explain a few of the expedients by which that object is attained.

29. In the arrangement represented in fig. 15, the object is attained by four conical valves, two placed at each end of the cylinder. Let B and B' be two steam boxes, B the upper, and B' the lower, communicating respectively with the top and bottom of the cylinder by proper passages D D'. Let two valves be placed in B, one, s, above the passage D, and the other, c, below it; and in like manner two other valves in the lower valve box B', one, s', above the passage D, and the other c', below it. Above the valve s in the upper steam box is an opening at which the steam

Fig. 15.

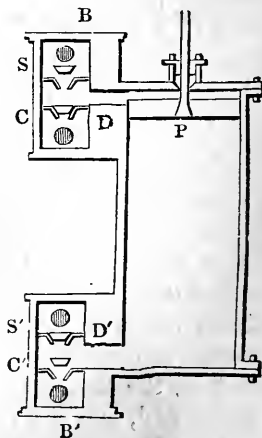

## THE STEAM ENGINE.

pipe from the boiler enters, and below the valve *c* is another opening, at which enters the exhausting pipe. In like manner, above the valve *s'* in the lower steam box enters a steam pipe leading from the boiler, and below the valve *c'* enters an exhausting pipe. It is evident, therefore, that steam can always be admitted above the piston by opening the valve *s*, and below it by opening the valve *s'*; and, in like manner, steam can be withdrawn from the cylinder above the piston, by opening the valve *c*, and from below it by opening the valve *c'*.

Supposing the piston *P* to be at the top of the cylinder, and the cylinder below the piston to be filled with pure steam, let the valves *s* and *c'* be opened, the valves *c* and *s'* being closed, as represented in fig. 15. Steam from the boiler will, therefore, flow in through the open valve *s*, and will press the piston downwards, while the steam that has filled the cylinder below the piston will pass through the open valve *c'* into the exhausting pipe. The piston will, therefore, be pressed downwards by the action of the steam above it. Having arrived at the bottom of the cylinder,

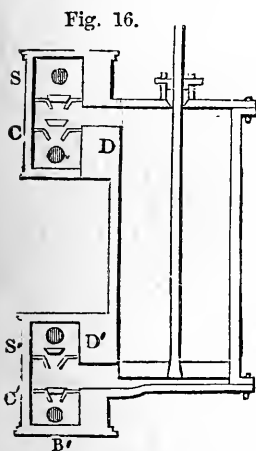

Fig. 16.

let the valves *s* and *c'* be both closed, and the valves *s'* and *c* be opened, as represented in fig. 16. Steam will now be admitted through the open valve *s'* and through the passage *D'* below the piston, while the steam which has just driven the piston downwards, filling the cylinder above the piston, will be drawn off through the open valve *c*, and the exhausting pipe, leaving in the cylinder above the piston a vacuum. The piston will, therefore, be pressed upwards by the action of the steam below it, and will ascend with the same force as that with which it had descended.

The alternate action of the piston upwards and downwards may evidently be continued by opening and closing the valves alternately in pairs. Whenever the piston is at the top of the cylinder, as represented in fig. 15, the valves *s* and *c'*, that is, the upper steam valve and the lower exhausting valve are opened; and the valves *c* and *s'*, that is, the upper exhausting valve and the lower steam valve, are closed; and when the piston has arrived at the bottom of the cylinder, as represented in fig. 16, the valves *c* and *s'*, that is, the upper exhausting valve and the lower steam valve, are opened, and the valves *s* and *c'*, that is, the upper steam valve and the lower exhausting valve, are closed.

If these valves, as has been here supposed, be opened and closed

## VALVES AND SLIDES.

at the moments at which the piston reaches the top and bottom of the cylinder, it is evident that they may be all worked by a single lever connected with them by proper mechanism. When the piston arrives at the top of the cylinder, this lever would be made to open the valves *s* and *c'*, and at the same time to close the valves *s'* and *c*; and when it arrives at the bottom of the cylinder, it would be made to close the valves *s* and *c'*, and to open the valves *s'* and *c*.

30. The methods of opening and closing the passages by means of lids slipping over them called slides, are those most generally used, and have infinitely various forms, although they differ one from another but little in the principle of their action. One of these expedients shown in fig. 17—18, will render the mode of

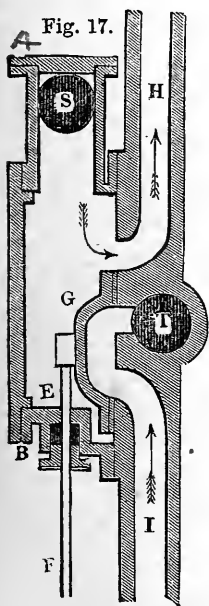

their action easily understood. *AB* is a steam-tight case attached to the side of the cylinder; *EF* is a rod, which receives an alternate motion, upwards and downwards, from the eccentric, or from whatever other part of the engine is intended to move the slide. This rod, passing through a stuffing box, moves the slide *G* upwards and downwards. *s* is the mouth of the steam pipe coming from the boiler; *T* is the mouth of a tube or pipe leading to the condenser; *H* is a passage leading to the top, and *I* to the bottom, of the cylinder. In the position

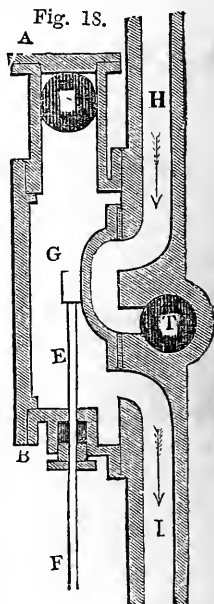

of the slide represented in fig. 17, the steam coming from the boiler through *s* passes through the space *H* to the top of the cylinder, while the steam from the bottom of the cylinder passes through the space *I* into the tube *T*, and goes to the condenser. When the rod *EF* is raised to the position represented in fig. 18, then the passage *H* is thrown into communication with the tube *T*, while the passage *I* is made to communicate with the tube *s*. Steam, therefore, passes from the boiler through *I* below the piston, while the steam which was above the piston, passing through *H* into *T*, goes to the condenser. Thus the single slide *G* performs the office of the four valves described in § 29.

## THE STEAM ENGINE.

31. Another form of slides is shown in fig. 19. The steam pipe proceeding from the boiler to the cylinder is represented at

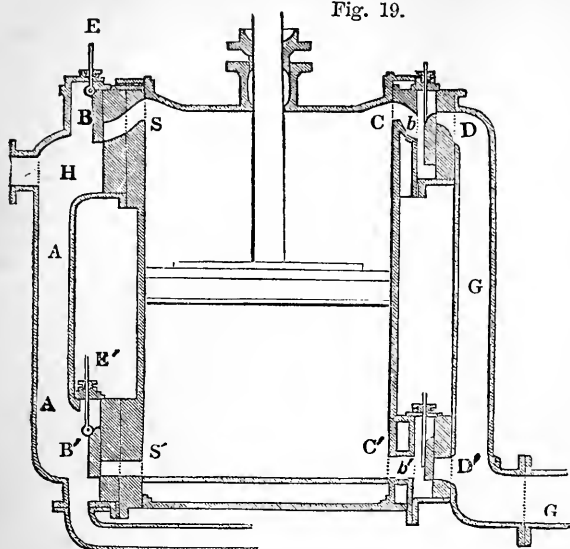

Fig. 19.

A A, and it communicates with passages *s* and *s'* leading to the top and bottom of the cylinder. These passages are formed in nozzles of iron or other hard metal cast upon the side of the cylinder. These nozzles present a smooth face outwards, upon which the slides *B B'*, also formed with smooth faces,

play. The slides *B B'* are attached by knuckle-joints to rods *E E'*, which move through stuffing-boxes, and the connection of these rods with the slides is such that the slides have play so as to detach their surfaces easily from the smooth surfaces of the nozzles when not pressed against these surfaces. The steam in the steam pipe *A A* will press against the backs of the slides *B B'*, and keep their faces in steam-tight contact with the smooth surfaces of the nozzles. These slides may be opened or closed by proper mechanism at any point of the stroke. When steam is to be admitted to the top of the cylinder, the upper slide is raised and the passage *s* opened; and when it is to be admitted to the bottom of the cylinder, the lower slide is raised and the passage *s'* opened: and its communication with the top or bottom of the cylinder is stopped by the lowering of these slides respectively. On the other side of the cylinder are provided two passages *c c'* leading to a pipe *G*, which is continued to the condenser. On this pipe are cast nozzles of iron or other metal presenting smooth faces towards the cylinder, and having passages *D D'* communicating between the top and bottom of the cylinder respectively and the pipe *G G* leading to the condenser. Two slides *b b'*, having smooth faces turned from the cylinder, and pressing upon the faces of the nozzles *D D'*, are governed by rods playing through stuffing-boxes, in the same manner as already described. The faces of these slides being turned from the cylinder, the steam in the cylinder having free

## STEAM COCKS.

communication with them, has a tendency to keep them by its pressure in steam-tight contact with the surfaces in which the apertures leading to the condenser are formed. These two slides may be opened or closed whenever it is necessary.

When the piston commences its descent, the upper steam slide is raised, so as to open the passage *s*, and admit steam above the piston; and the lower exhausting slide *b'* is also raised, so as to allow the steam below the piston to escape through *g*, the other two passages *s'* and *c* being closed by their respective slides. The slide which governs *s* is lowered at that part of the stroke at which the steam is intended to be cut off, the other slides remaining unchanged; and when the piston has reached the bottom of the cylinder, the lower steam slide opens the passage *s'*, and the upper exhausting slide opens the passage *c*, and at the same time the lower exhausting slide closes the passage *c'*. Steam being admitted below the piston through *s'*, and at the same time the steam above it being drawn away through the open passage *c* and the tube *g*, the piston ascends. When it has reached that point at which the steam is intended to be cut off, the slide which governs *s'* is lowered, the other slides remaining unaltered, and the upward stroke is completed in the same manner as the downward.

These four slides may be governed by a single lever, or they may be moved by separate means. From the small spaces between the several slides and the body of the cylinder, it will be evident that the waste of steam by this contrivance will be very small.

32. The admission and escape of the steam is sometimes

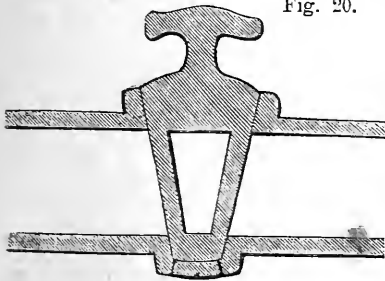

Fig. 20.

governed by cocks, more especially in engines constructed on a small scale. The most common form for cocks is that of a cylindrical or slightly conical plug (fig. 20), inserted in an aperture of corresponding magnitude passing across the pipe or passage which the cock is intended to open or close. One or more holes are

pierced transversely in the cock, and when the cock is turned, so that these holes run in the direction of the tube, the passage through the tube is opened; but when the passage through the cock is placed at right angles to the tube, then the sides of the tube stop the ends of the passage in the cock, and the passage through the tube is obstructed. The simple cock is designed to open or close the passage through a single tube. When the cock is turned, as in fig. 21, so that the passage through the cock shall be at right angles to the length of the tube, then the passage

## THE STEAM ENGINE.

through the tube is stopped; but when the cock is turned from that position through a quarter of a revolution, as in fig. 22, then the passage through the cock takes the direction of the passage

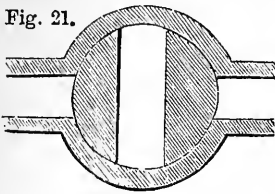

Fig. 21.

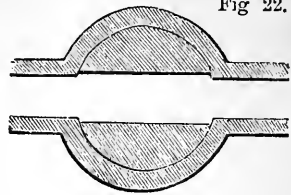

Fig. 22.

through the tube, and the cock is opened, and the passage through the tube unobstructed. In such a cock the passage may be more or less *throttled* by adjusting the position of the cock, so that a part of the opening in it shall be covered by the side of the tube.

33. It is sometimes required to put one tube or passage alternately in communication with two others. This is accomplished by a *two-way cock*. In this cock the passage is curved, opening usually at points on the surface of the cock, at right angles to each other. When it is required to put four passages alternately in communication by pairs, a *four-way cock* is used. Such a cock has two curved passages (fig. 23), each similar to the curved passage

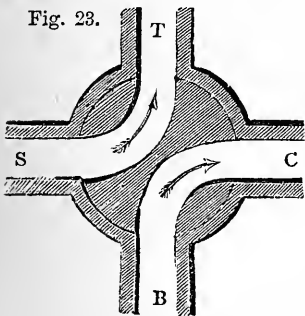

Fig. 23.

in the two-way cock. Let *s c b t* be the four tubes which it is required to throw alternately into communication by pairs. When the cock is in the position (fig. 23), the tube *s* communicates with *t*, and the tube *c* with *b*. By turning the cock through a quarter of a revolution, as in fig. 24, the tube *s* is made to communicate with *b*, and the tube *c* with *t*; and if the cock continue to be turned at intervals

through a quarter of a revolution, these changes of communication will continue to be alternately made. It is evident that this may be accomplished by turning the cock continually in the same direction.

The four-way cock is sometimes used as a substitute for the valves or slides to conduct the steam to and from the cylinder. If *s* represent a pipe conducting steam from the boiler, *c* the exhausting pipe, *t* the tube which leads to the top of the cylinder, and *b* that which leads to the bottom, then when the cock is in the position (fig. 23), steam would flow from the boiler to the top of the piston, while the steam below it would be drawn off: and in the position (fig. 24), steam would flow from the boiler to the bottom of the piston, while the steam above it would be



## FOUR-WAY COCK.

drawn off. Thus by turning the cock through a quarter of a revolution towards the termination of each stroke, the operation of the machine would be continued.

34. It will be understood from all that has been stated that the mechanical effect of the steam engine depends, other things being given, upon the excess of the pressure of the steam which impels the piston above the reaction of the steam which escapes at the end of the cylinder towards which the piston is moving. To whatever extent, therefore, this reaction is diminished, the efficacy of the engine will be increased.

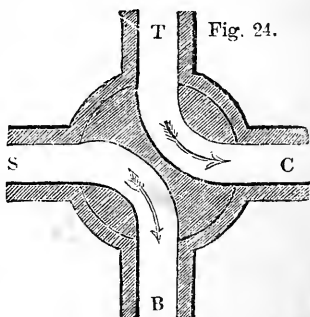

Steam engines are resolved into two distinct classes, according to the way in which the steam escaping from the cylinder is disposed of, called non-condensing and condensing engines, or, more commonly, though less properly, high pressure and low pressure engines. The objection to the latter denomination being that, although non-condensing engines must necessarily be worked with high pressure steam, condensing engines need not be worked with low pressure steam, as will presently appear.

In the class of non-condensing or high pressure engines, the exhaustion pipes of the cylinder open into the atmosphere; in the condensing or low pressure engines, they lead to an apparatus in which the steam is *condensed*, the name given to the process of reconverting it into water by exposure to cold.

35. In non-condensing engines the exhausting pipe communicating with the external air, this air will, when the exhausting valve is open, have a tendency to rush into the cylinder, while the steam has, on the contrary, a tendency to rush out. If, in this case, the pressure of the steam were not greater than that of the atmosphere, its escape would be prevented by the counter pressure of the air, and as the pressure of the steam is the measure of its reaction against the piston, it follows that in this class of steam engine, the reaction on the piston must always be somewhat greater than the atmospheric pressure, which, as has been shown in vol. ii., p. 4, amounts on an average to 15lbs. per square inch.

Since, then, the piston of a non-condensing engine is subject, necessarily and constantly, to a reaction exceeding 15lbs. per square inch, the pressure of the steam by which it is impelled must greatly exceed 15lbs. per square inch. Thus a pressure of 30lbs. per square inch would give an effective pressure much less than 15lbs. per square inch, because, besides the reaction of the

steam, the impelling power is resisted by friction. A pressure of 45lbs. per square inch would give an effective force amounting to less than 30lbs. per square inch, and so on.

Notwithstanding the disadvantage of this reaction on the piston, and the consequent necessity of providing a boiler suitable to the production of steam of this high pressure, non-condensing engines are attended with several countervailing advantages which render them not only preferable in certain cases to condensing engines, but which render them efficient where the adoption of condensing engines would be altogether impracticable.

36. In condensing engines, the exhausting pipes which proceed from the ends of the cylinder lead to a reservoir or vessel called a condenser, in which the steam, being exposed to cold, is reduced to water. Now, since a cubic foot of steam will, when re-converted into liquid, form only about a cubic inch of water, it is plain that by this process of condensation, efficiently conducted, the steam escaping from the cylinder may be considered as passing into a vacuum, and therefore not only is it not subject to the resistance of the atmosphere, but to no resistance whatever, except what may arise from the contracted dimensions of the exhausting pipe. The conversion of the steam into water being, moreover, almost instantaneous, the reaction attending its escape, small as it is, is only momentary, and affects the piston only at the commencement of the stroke, throughout the remainder of which it will be subject to no reaction whatever.

Thus it appears, that, in condensing engines the pressure of the steam which impels the piston instead of being subject, as in non-condensing engines, to a reaction exceeding 15 lbs. per square inch, is subject to scarcely any reaction at all; and consequently its pressure, to be effective, need not exceed a few pounds, say from 4 lbs. to 6 lbs. per square inch. It is for this reason that condensing engines have been commonly called low-pressure engines.

But although low-pressure steam *may* be used in this class of engines, and in most cases *is* used, it is not thus used exclusively or necessarily. Steam of any pressure, however high, may be worked in them, and the condensing apparatus will still render equal service. In certain applications of the engine, steam having a pressure several times greater than that of the atmosphere is worked with great advantage in engines constructed on this principle.

37. Since the condensing apparatus discharges such important functions, it will be useful to show its structure and arrangement, in connection with the piston and cylinder.

A section of such an apparatus is shown in fig. 25. A cistern,

## CONDENSER.

c c, is filled with cold water. Immersed in it is a metal vessel, B, called the condenser. A pipe, s s, connects this condenser with the exhausting pipe of the cylinder, of which s s may be

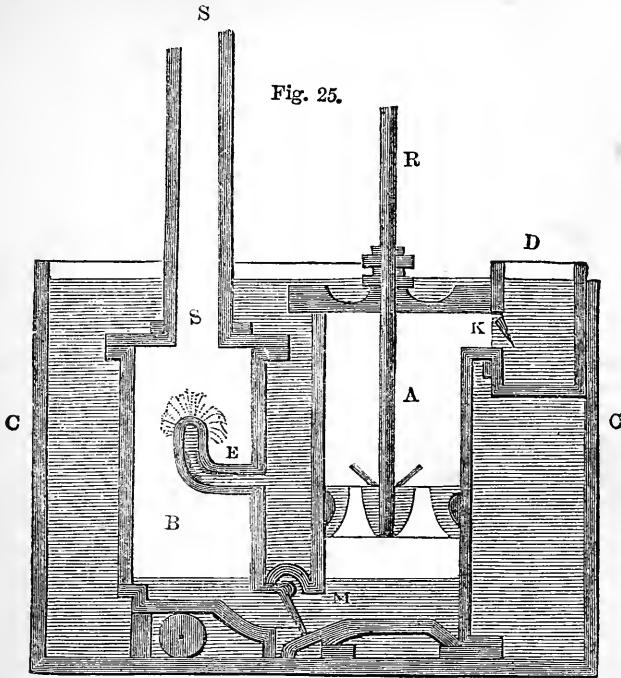

considered as the continuation. A jet-pipe, E, enters the condenser, and is bent upwards. It is terminated with a piece pierced with holes like the rose of a watering-pot, and the cold water of the cistern, c c, being pressed in through the pipe, E, is thrown up in the condenser, as shown in the figure. The steam, escaping from the cylinder along the pipe, s s, encounters this cold jet and is instantly condensed. Mixing with the cold water of the jet, it forms warm water, which collects in the bottom of the condenser.

If means were not provided for the removal of this water, the vessel B would soon become choked with it, so as to arrest the action of the apparatus.

38. But there is also another effect, which it is important to explain. Water as it commonly exists always contains more or less air fixed in or mingled with it. The air thus fixed in the water of the cistern, c c, is disengaged in greater or less quantity by the heat to which it is exposed when the steam is mixed with it in the vessel B. This air, rising through the tube, s s, offers more or less resistance to the escape of the steam, and reacts upon the piston to the detriment of the moving power. Its accumula-

tion, if not removed, would soon obstruct and altogether arrest the action of the machine.

This air, as well as the warm water deposited in the bottom of the condenser, is withdrawn by a pump, A, called the AIR-PUMP, because of its use in the removal of the air just mentioned. In the piston of this pump are valves which open upwards, so that when the piston descends the water and air force themselves through the valves, and when it ascends it lifts the water and air which have thus passed through the valves, and throws them into a small reservoir, D, through a valve, K. This reservoir, D, is called the hot cistern, the water deposited in it having a temperature more or less elevated, owing to the steam which has been condensed by it.

The ascent of the piston of the air-pump has also the effect of drawing by suction, as it is commonly called, the water and air from the condenser, B, through the valve M into the bottom of the barrel of the air-pump, from which they cannot get back into the condenser, inasmuch as the valve, M, opens towards the air-pump, and their returning pressure only closes it more firmly.

39. The continual affluence of the steam to the vessel B, and the water constantly passing through it, the air-pump, and the cistern, D, would at length raise the temperature of the water in the cistern, C C, in which the condensing apparatus is immersed, to such a point that the jet projected into the condenser would be no longer cold enough to condense the steam.

To prevent this a pump, called the cold-water pump, is provided, which throws into the cistern a sufficient quantity of cold water. This water is introduced near the bottom of the cistern, a waste-pipe being provided at the top by which the warm water, which always collects near the upper surface, flows off. In this way the temperature of the water in the cistern, C C, is kept sufficiently low, notwithstanding the heat proceeding from the condensing vessels.

40. To prevent the accumulation of warm water in the cistern, D, a pump called the hot-water pump is connected with it, by which the water is drawn off from it and transferred to the feeding apparatus of the boiler. Thus a part of the heat given out by the condensed steam, and which has already done duty in working the piston, is returned to the boiler to take another round of duty.

Thus it appears that the condensing apparatus consists of the cold cistern, C C, the cold-water pump which supplies it, the condenser, B, the air-pump, A, the hot cistern, D, and the hot-water pump, which draws the water from it.

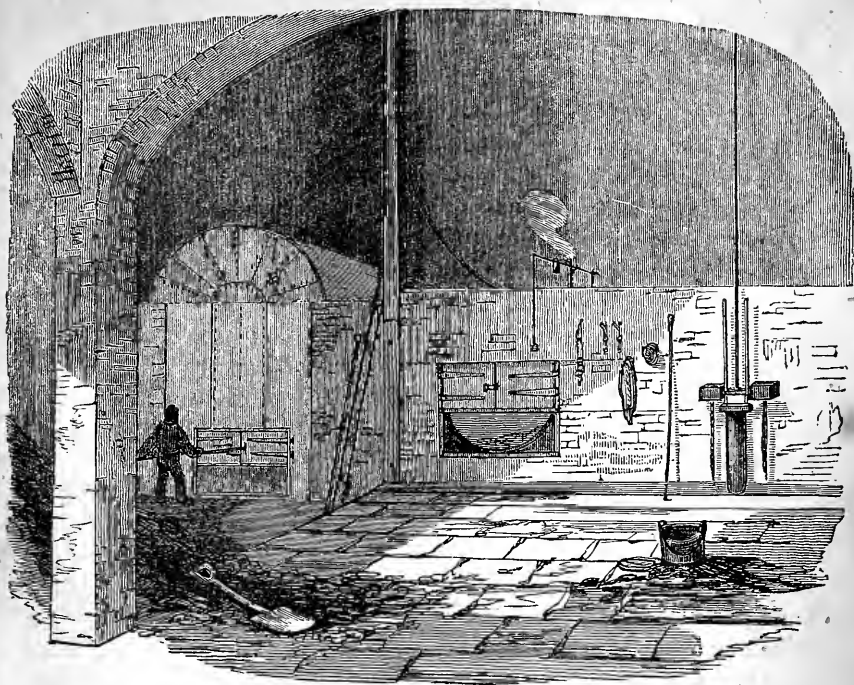

FURNACE AT THE CITY SAW MILLS.

## THE STEAM ENGINE.

### CHAPTER III.

41. Comparative merits of the two kinds of engines.—42. Various modes of transmitting force.—43. Description of a factory engine.—44. The governor.—45. The eccentric.—46. The fly-wheel.—47. Parallel motion.—48. Barometer gauge.—49. How to compute the effective moving force of the piston.—50. Method not considered sufficiently accurate.—51. Indicator.—52. Mode of recording its positions.—53. Its application in finding effective force.—54. Watt's counter.—55. Conclusion.

41. THAT the advantages arising from the diminished reaction on the piston, produced by the condensation of the steam, are not altogether to be placed to the account of increased moving power, will be apparent when it is observed that no inconsiderable part of the power thus gained is absorbed by the cold-water pump, the air pump, and the hot-water pump, all of which are worked by the engine. Neither is the vacuum into which the piston moves,

so absolute as it might at first appear to be. It is not found practicable to keep the water in the condenser at a temperature lower than  $100^{\circ}$ , and at that temperature steam is evolved which has a pressure of about one pound per square inch, which, after all, will still react upon the piston.

In comparing, then, the non-condensing and condensing engine, it is apparent, that while the latter gives a much greater amount of moving power with the same rate of evaporation, and consequently with the same consumption of fuel, the former is vastly more simple in its mechanism, lighter in its weight, more inexpensive in its construction and maintenance, and much more portable.

42. From what has been explained, it will be understood how the piston-rod is made to move with any desired force alternately in one direction or other, through a space equal to the stroke of the piston, or, what is the same, to the length of the cylinder.

The manner in which this force is transmitted to the object to which the engine is applied, is extremely various. In some cases the end of the piston-rod is connected with that of a vibrating beam, to which a motion of oscillation is imparted like that of the handle of a pump. In other cases it is put in connection with a winch or crank, by which a motion of revolution is imparted to an axle or shaft, in the same manner as a man working at a windlass causes a rope to wind upon its axle. In other cases it is connected with a wheel, to which it imparts rotation, as in some forms of the locomotive engine. In short, the expedients by which the alternate force of the piston is applied to the particular work to be performed by the engine are so numerous, and differ so much one from another, that it would be quite impossible to give any general account which would include them.

43. To convey, however, some idea of one of the most common methods of transmitting the force of the piston, we shall take the case of the steam engine generally used to propel the machinery of the larger class of factories, a view of which is given in fig. 26. The several parts will be easily understood, after what has been stated, without further explanation.

c is the steam cylinder.

p, the steam piston.

v v', the valves for admitting and withdrawing the steam, at each end of the cylinder.

R, the piston-rod of the air pump.

L, the piston-rod of the hot-water pump.

N, the piston-rod of the cold-water pump.

I, the handle of the cock by which the jet in the condenser is made to play with more or less force.

b, d, g, c, a system of jointed rods called the parallel motion, by

# FACTORY ENGINE.

means of which the motion of the beam in the arc of a circle is rendered compatible with that of the piston-rod in a straight line.

Fig. 26.

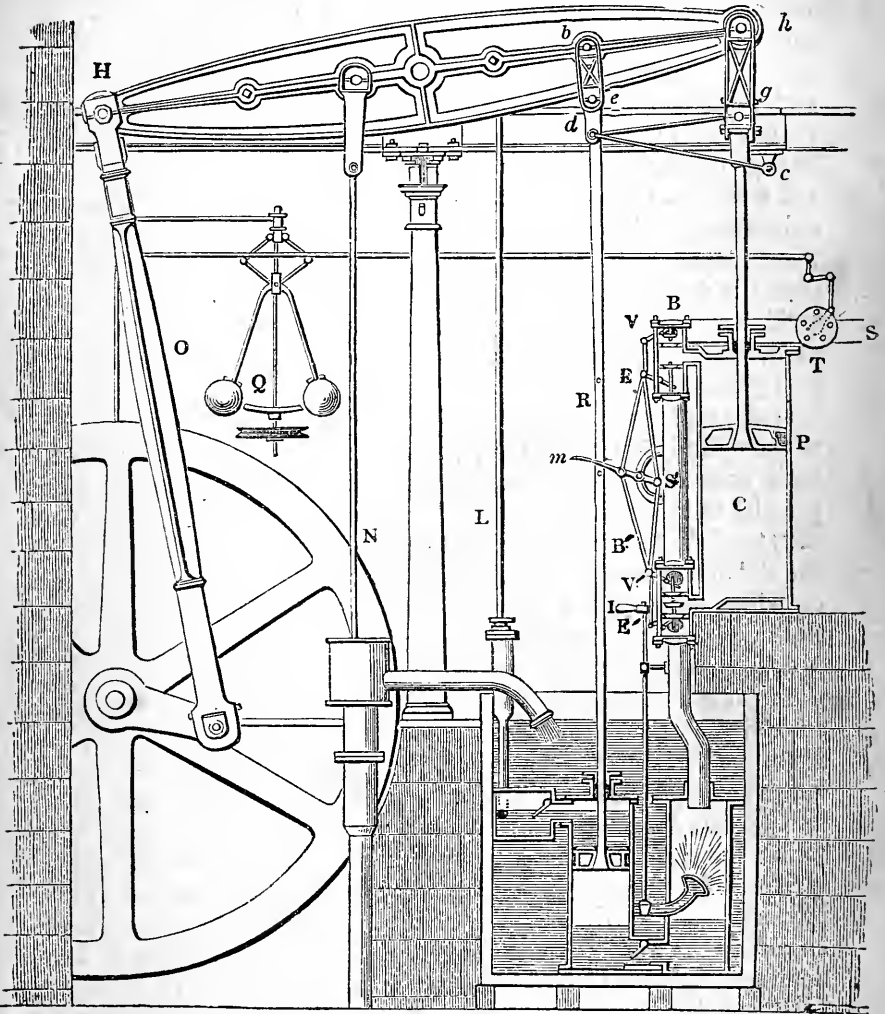

*h*, the pin on the end of the beam connected with the end of the piston-rod by the joint *h g*.

*b*, the pin on the beam connected with the piston-rod of the air pump by the joint *b d*.

*H*, the pin on the working end of the beam.

*o*, a rod called the connecting rod, by which the end *H* of the beam is connected with a crank or winch upon the main shaft, to which it is required to impart rotation.

## THE STEAM ENGINE.

*m*, a lever jointed to a system of rods by which the valves *v v'* admitting and withdrawing the steam at the top and bottom of the cylinder are opened and closed. This lever *m* is acted upon by pins which project from the piston-rod of the air pump, and which appear in the figure. When the piston descends, the upper pin strikes the arm *m*, which closes the upper steam valve and lower exhausting valve, and opens the lower steam valve and upper exhausting valve, so that the steam is admitted below and withdrawn from above the piston, which is accordingly driven up. When the up-stroke is nearly terminated, the lower pin on the rod *R* strikes the arm *m*, driving it upwards, and closes the upper exhausting valve and the lower steam valve, while it opens the upper steam valve and lower exhausting valve, by which means the piston is driven down.

This method of working the valves is however at present rarely used, being replaced by another expedient which we shall presently describe.

*s*, the pipe leading from the boiler by which steam is supplied to the cylinder to impel the piston. This pipe communicates with both ends of the cylinder by means of a passage *s'*, which is parallel to the cylinder.

*r*, the handle of a valve called the throttle valve, which is within the steam pipe *s*, and which is turned by the handle, so as to contract or widen more or less the passage for the steam. By this means the supply of steam to the cylinder is increased or diminished.

*q*, a system of revolving balls called the governor, with which the handle *r* of the throttle valve is connected by a series of levers and joints, which are so constructed, that when the balls recede from the axis of the governor, the valve is more or less closed, and when they fall near the axis, the valve is fully open. These balls receive a motion of revolution from the main shaft upon which the crank is constructed by means of a band or by toothed wheels. In either case their velocity of rotation will be always proportionate to that of the shaft. In all applications of the engine to the purposes of manufacture and the arts, there is some determinate velocity which is required to be given to the shaft. If steam be supplied in too great quantity to the cylinder, the motion given to the shaft will be too rapid; and if it be supplied in too small quantity, the motion will be too slow.

Such irregularities of motion are prevented by the governor. The moment the motion begins to be too rapid, the centrifugal force produced by the revolution causes the balls to fly out, to recede from the axis, and to close more or less the throttle valve. If, on the contrary, the motion begins to be too slow, the balls fall in, approach the axis, and open the throttle valve. Thus



## GOVERNOR.

every undue increase of speed diminishes the supply of steam, and moderates the velocity; and every undue decrease of speed increases the supply of steam, and augments the velocity. In this manner the action of the governor keeps the engine constantly moving at a regulated rate.

44. The manner in which the governor opens the throttle valve will be still more easily understood by the aid of fig. 27.

A small grooved wheel *A B* is attached to a vertical spindle supported in pivots or sockets *c* and *D*, in which it is capable of revolving. An endless cord works in the groove *A B*, and is carried over proper pulleys to the axle of the fly-wheel, where it likewise works in a groove. When this cord is properly tightened,

Fig. 27.

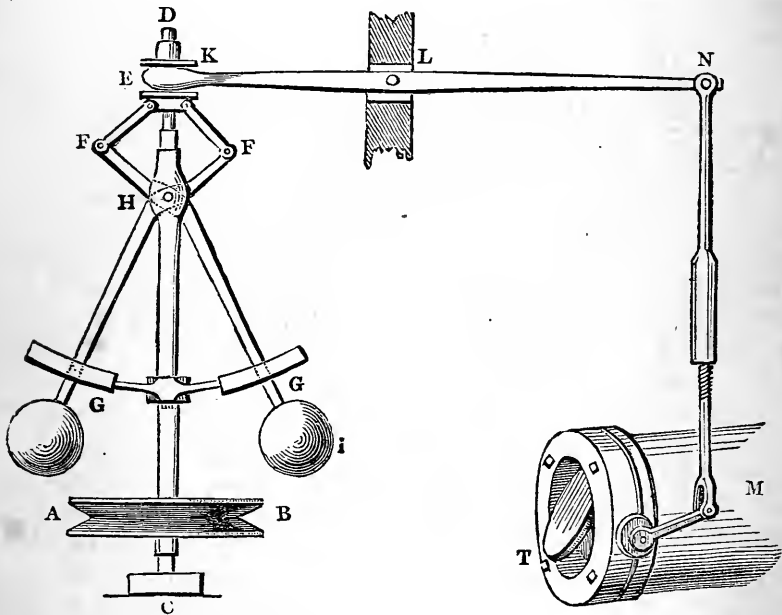

the motion of the fly-wheel will give motion to the wheel *A B*, so that the velocity of the one will be subject to all the changes incidental to the velocity of the other. By this means the speed of the grooved wheel *A B* may be considered as representing the speed of the fly-wheel, and of the machinery which the axle of the fly-wheel drives.

It is evident that the same end might be obtained by substituting for the grooved wheel *A B* a toothed wheel, which might be connected by other toothed wheels, and proper shafts and axles with the axle of the fly-wheel.

## THE STEAM ENGINE.

A ring or collar *E* is placed on the upright spindle, so as to be capable of moving freely upwards and downwards. To this ring are attached by pivots two short levers, *E F*, the pivots or joints at *E* allowing these levers to play upon them. At *F* these levers are joined by pivots to other levers *F G*, which cross each other at *H*, where an axle or pin passes through them, and attaches them to the upright spindle *C D*. These intersecting levers are capable, however, of playing on this axle or pin *H*. To the ends *G* of these levers are attached two heavy balls of metal. The levers *F G* pass through slits in a metallic arc attached to the upright spindle, so as to be capable of revolving upon it. If the balls are drawn outwards from the vertical axis, it is evident that the ends *F* of the levers will be drawn down, and therefore the pivots *E* likewise drawn down. In fact, the angles *E F H* will become more acute, and the angles *F E F* more obtuse. By these means the sliding ring *E* will be drawn down. To this sliding ring *E*, and immediately above it, is attached a grooved collar, which slides on the vertical spindle upwards and downwards with the ring *E*. In the grooved collar are inserted the prongs of a fork *K*, formed at the end of the lever *K L*, the fulcrum or pivot of the lever being at *L*. By this arrangement, when the divergence of the balls causes the collar *E* to be drawn down, the fork *K*, whose prongs are inserted in the groove of that collar, is likewise drawn down; and, on the other hand, when by reason of the balls falling towards the vertical spindle, the collar *E* is raised, the fork *K* is likewise raised.

The ascent and descent of the fork *K* necessarily produce a contrary motion in the other end *N* of the lever. This end is connected by a rod, or system of rods, with the end *M* of the short lever which works the throttle valve *T*. By such means the motion of the balls, towards or from the vertical spindle, produces in the throttle valve a corresponding motion; and they are so connected that the divergence of the balls will cause the throttle valve to close, while their descent towards the vertical spindle will cause it to open.

These arrangements being comprehended, let us suppose that, either by reason of a diminished load upon the engine or an increased activity of the boiler, the speed has a tendency to increase. This would impart increased velocity to the grooved wheel *A B*, which would cause the balls to revolve with an accelerated speed. The centrifugal force which attends their motion would therefore give them a tendency to move from the axle, or to diverge. This would cause, by the means already explained, the throttle valve *T* to be partially closed, by which the supply of steam from the boiler to the cylinder would be

## ECCENTRIC.

diminished, and the energy of the moving power, therefore, mitigated. The undue increase of speed would thereby be prevented.

If, on the other hand, either by an increase of the load, or a diminished activity in the boiler, the speed of the machine was lessened, a corresponding diminution of velocity would take place in the grooved wheel A B. This would cause the balls to revolve with less speed, and the centrifugal force produced by their circular motion would be diminished. This force being thus no longer able fully to counteract their gravity, they would fall towards the spindle, which would cause, as already explained, the throttle valve to be more fully opened. This would produce a more ample supply of steam to the cylinder, by which the velocity of the machine would be restored to its proper amount.

45. The method of working the valves by means of pins projecting from the rod of the air pump has been in most cases superseded by an apparatus called an *eccentric*, by which the motion of the axle of the fly-wheel is made to open and close the valves at the proper times.

An eccentric is a metallic circle attached to a revolving axle, so that the centre of the circle shall not coincide with the centre round which the axle revolves. Let us suppose that G (fig. 28) is a square revolving shaft. Let a circular plate of metal, B D,

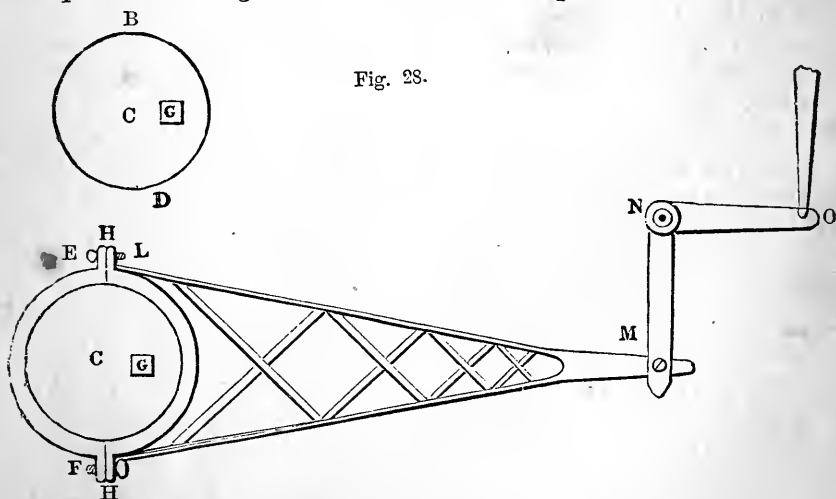

Fig. 28.

having its centre at c, have a square hole cut in it corresponding to the shaft, G, and let the shaft, G, pass through this square aperture, so that the circular plate, B D, shall be fastened upon the shaft, and capable of revolving with it as the shaft revolves. The centre, c, of the circular plate will be carried round the centre, G, of the revolving shaft, and will describe round it a

## THE STEAM ENGINE.

circle, the radius of which will be the distance of the centre,  $c$ , of the circular plate from the centre of the shaft. Such circular plate, so placed upon a shaft, and revolving with it, is an *eccentric*.

Let  $EF$  be a metallic ring, formed of two semicircles of metal screwed together at  $H$ , so as to be capable, by the adjustment of the screws, of having the circular aperture formed by the ring enlarged and diminished within certain small limits. Let this circular aperture be supposed to be equal to the magnitude of the eccentric,  $BD$ . To the circular ring,  $EF$ , let an arm,  $LM$ , be attached. If the ring,  $EF$ , be placed around the eccentric, and the screws,  $H$ , be so adjusted as to allow the eccentric to revolve within the ring,  $EF$ , then, while the eccentric revolves, the ring not partaking of its revolution, the arm,  $LM$ , will be alternately driven to the right and to the left, by the motion of the centre,  $c$ , of the eccentric as it revolves round the centre,  $G$ , of the axle. When the centre,  $c$ , of the eccentric is in the same horizontal line with the centre,  $G$ , and to the left of it, then the position of  $LM$  will be that which is represented in fig. 28; but when, after half a revolution of the main axle, the centre,  $c$ , of the eccentric is thrown on the other side of the centre,  $G$ , then the point,  $M$ , will be transferred to the right, to a distance equal to twice the distance  $cG$ . Thus, as the eccentric revolves within the ring,  $EF$ , that ring, together with the arm,  $LM$ , will be alternately driven right and left, through a space equal to twice the distance between the centre of the eccentric and the centre of the revolving shaft.

If we suppose a notch formed at the extremity of the arm,  $LM$ , which is capable of embracing a lever,  $NM$ , moveable on a pivot at  $N$ , the motion of the eccentric would give to such a lever an alternate motion from right to left, and *vice versa*. If we suppose another lever,  $NO$ , connected with  $NM$ , and at right angles to it, forming what is called a bell-crank; then the alternate motion received by  $M$ , from right to left, would give a corresponding motion to the extremity,  $O$ , of the lever,  $NO$ , upwards and downwards. If this last point,  $O$ , were attached to a vertical arm or shaft, it would impart to such arm or shaft an alternate motion upwards and downwards, the extent of which would be regulated by the length of the levers respectively.

By such a contrivance the revolution of the shaft is made to give an alternate vertical motion of any required extent to a vertical shaft placed near the cylinder, which may be so connected with the valves as to open and close them. Since the upward and downward motion of this vertical shaft is governed by the alternate motion of the centre,  $c$ , to the right and to the left of the centre,

## FLY-WHEEL.

6, it is evident that, by the adjustment of the eccentric upon the shaft, the valves may be opened and closed at any required position of the crank, and therefore at any required position of the piston in the cylinder.

Such is the contrivance by which the valves, whatever form may be given to them, are now almost universally worked in double-acting steam engines.

46. Notwithstanding the regulating influence of the governor, the motion of the engine would still be subject to a certain inequality, owing to the varying action of the connecting rod,  $o$  (fig. 26), on the crank. It will be quite evident that this action is most efficient when  $o$  is placed at right angles to the crank, which it is twice in every revolution, but that the more oblique it is to the crank the less efficient will be its action upon it.

Now this inequality is effaced very nearly, if not altogether, by means of a large and massive wheel of cast iron, called the FLY-WHEEL, which is keyed upon the axle of the crank so as to revolve with it, as shown in fig. 26. This wheel being well constructed, and nicely balanced on its axle, is subject to very little resistance from friction; any moving force which it receives it therefore retains, and is ready to impart such moving force to the main axle whenever that axle ceases to be driven by the power. When the crank, therefore, is in those positions in which the action of the power upon it is most efficient, a portion of the energy of the power is expended in increasing the velocity of the mass of matter composing the fly-wheel. As the crank approaches the dead points, that is the points where it is in the same straight line with the connecting rod, the effect of the moving power upon the axle and upon the crank is gradually enfeebled, and at these points vanishes altogether. The momentum which has been imparted to the fly-wheel then comes into play, and carries forward the axle and crank out of the dead points with a velocity very little less than that which it had when the crank was in the most favourable position for receiving the action of the moving power.

By this expedient, the motion of revolution received by the axle from the steam piston is subject to no other variation than just the amount of change of momentum in the great mass of the fly-wheel which is sufficient to extricate the crank twice in every revolution from the mechanical dilemma to which its peculiar form exposes it; and this change of velocity may be reduced to as small an amount as can be requisite by giving the necessary weight and magnitude to the fly-wheel.

47. The combination of jointed rods represented at  $cdgb$ , in fig. 26, called the parallel motion, constitutes one of the many inventions of Watt, which has always excited the greatest admi-

## THE STEAM ENGINE.

ration, by reason of the remarkable geometrical intuition which it manifested in one who was uninstructed in the advanced principles of geometrical analysis upon which the perfection of its action depends. Although this beautiful arrangement has been very generally superseded by others of greater simplicity, and of sufficient, though less, precision of action, it will not be uninteresting here to attempt a brief and popular explanation of the principles upon which its performance depends.

The end of the beam with which the top of the piston-rod is connected vibrating upon its centre, necessarily plays in a circular arc, the convexity of which is presented to the right in fig. 26. Now it is clear, that if the end  $g$  of the piston-rod were immediately jointed to this end of the beam, it would be bent towards the right through the convexity of the arc, while the beam moves from its highest or lowest position to the middle of its play, and that while it moves from the latter to the former position it will be deflected back towards the left. Now, the efficient performance of the engine absolutely requires that the piston-rod should not be exposed to any such alternate strain, but that it should be guided in a perfectly straight line in the direction of the axis of the cylinder; and this is precisely what the parallel motion accomplishes.

As we have just explained, the point  $h$  plays in an arc whose convexity is presented to the *right*. Now, the joint  $c d$ , or *link*, as it is called, moves upon a fixed centre,  $c$ , and consequently plays in an arc whose convexity is presented to the *left*, that is, contrary to the former. While the point  $h$  throws the upper end of the link  $g h$  to the right, by reason of the convexity of its play being on that side, the point  $d$  throws the lower end  $g$  to the left, by reason of its convexity being on the contrary side.

Now, the proportion of the lengths of the rods is so nicely adjusted, that the effect of the rod  $c d$  in throwing the point  $g$  to the left is exactly equal to the effect of the beam in throwing it to the right; and the consequence of this mutual compensation is, that the point  $g$ , to which the end of the piston-rod is jointed, is thrown neither to the right nor to the left, but is moved upwards and downwards in a straight line.

48. To be enabled to verify the efficiency of the engine and enforce a due economy of fuel, it is necessary to be provided with indicators, by which at all times the effective force of the piston can be ascertained. Now this effective force depends conjointly upon the pressure of the steam which moves the piston and the reaction of the uncondensed steam, and of the gases which the air pump may fail to withdraw from the condenser. Two mercurial gauges are accordingly provided for this purpose in all large stationary engines which are constructed on the condensing principle.

## PARALLEL MOTION—BAROMETER GAUGE.

The force of steam which moves the piston is indicated by the steam gauge already described, and which is shown attached to the exposed end,  $\kappa$ , of the boiler in fig. 7. The reaction of the uncondensed steam and gases is indicated by a gauge called the barometer gauge, inasmuch as it would be in fact a barometer if an absolute vacuum were produced before the piston. This gauge consists of a glass tube,  $A B$  (fig. 29), more than thirty inches long, and open at both ends, placed in an upright or vertical position, having the lower end  $B$  immersed in a cistern of mercury,  $c$ . To the upper end is attached a metal tube, which communicates with the condenser, in which a constant vacuum, or rather high degree of rarefaction, is sustained. The same vacuum must therefore exist in the tube  $A B$ , above the level of the mercury, and the atmospheric pressure on the surface of the mercury in the cistern  $c$  will force the mercury up in the tube  $A B$ , until the column which is suspended in it is equal to the difference between the atmospheric pressure and the pressure of the uncondensed steam. The difference between the column of mercury sustained in this instrument and in the common barometer, will determine the strength of the uncondensed steam, allowing a force proportional to one pound per square inch for every two inches of mercury in the difference of the two columns. In a well-constructed engine which is in good order, there is very little difference between the altitude in the barometer gauge and the common barometer.

Fig. 29.



49. To compute the force with which the piston descends, thus becomes a very simple arithmetical process. First, ascertain the difference of the levels of the mercury in the steam gauge; this gives the excess of the steam pressure above the atmospheric pressure. Then find the height of the mercury in the barometer gauge; this gives the excess of the atmospheric pressure above the uncondensed steam. Hence, if these two heights be added together, we shall obtain the excess of the impelling force of the steam from the boiler, on the one side of the piston, above the resistance of the uncondensed steam on the other side; this will give the effective impelling force. Now, if one pound be allowed for every two inches of mercury in the two columns just mentioned, we shall have the number of pounds of impelling pressure on every square inch of the piston. Then, if the number of square inches in the section of the piston be found, and multiplied by the number of pounds on each square inch, the force with which it moves will be obtained.

From what we have stated it appears that, in order to estimate

## THE STEAM ENGINE.

the force with which the piston is urged, it is necessary to refer to both the barometer and the steam gauge. This double computation may be obviated by making one gauge serve both purposes. If the end *c* of the steam gauge (fig. 7), instead of communicating with the atmosphere, were continued to the condenser, we should have the pressure of the steam acting upon the mercury in the tube *BA*, and the pressure of the uncondensed vapour which resists the piston acting on the mercury in the tube *BC*. Hence the difference of the levels of the mercury in the tubes would at once indicate the difference between the force of the steam and that of the uncondensed vapour, which is the effective force with which the piston is urged.

50. Perfect as these expedients must appear, they have been deemed insufficient as indicators of an element so important as the economy of steam power. If, during the motion of the piston from end to end of the cylinder, the steam really acted upon it with an uniform force, and if the reaction against it were also uniform, then the steam and barometer gauges would give an exact measure of the effective power. But many causes co-operate in preventing such uniformity of action and reaction.

In the first place, the end of the cylinder from which the piston moves is never left in free communication with the boiler through the entire stroke. In all cases the steam is shut off by closing the steam valve before the stroke is completed, and if the engine works by expansion, which most engines do, the steam is shut off after a certain part of the stroke—such as three-fourths, two-thirds, a half, and sometimes even a third, or a fourth—has been made. In all such cases, the pressure on the piston after the steam has been shut off becomes less and less, as the steam in the cylinder expands by the advance of the piston.

Neither is the reaction uniform; for the condensation of the steam in the condenser is not absolutely instantaneous, though very rapid, but still less is the removal of the air and gases, which are fixed in the water injected to produce the condensation, instantaneous. The action of the air pump is gradual, and consequently the reaction on the piston, considerable at first, becomes gradually less and less towards the end of the stroke.

Now it is clear that, under these circumstances, the effective power of the piston, being always measured by the excess of the impelling force over the reaction, must vary continually from the beginning to the end of the stroke; and as the total effective force must consist of the aggregate of this varying action, it would seem to be a problem of the greatest practical difficulty to ascertain it.

51. Nevertheless, the inexhaustible resources of the genius of Watt, which surmounted so many other difficulties, did not shrink



## INDICATOR.

before this; and produced an instrument of most felicitous perfection, called an Indicator, by which the object was perfectly and simply attained.

This contrivance consists of a cylinder of about  $1\frac{3}{4}$  inch in diameter, and 8 inches in length. It is bored with great accuracy, and fitted with a solid piston moving steam-tight in it with very little friction. The rod of this piston is guided in the direction of the axis of the cylinder through a collar in the top, so as not to be subject to friction in any part of its play. At the bottom of the cylinder is a pipe governed by a stop-cock and terminated in a screw, by which the instrument may be screwed on the top of the steam cylinder of the engine. In this position, if the stop-cock of the indicator be opened, a free communication will be made between the cylinder of the indicator and that of the engine. The piston-rod of the indicator is attached to a spiral spring, which is capable of extension and compression, and which by its elasticity is capable of measuring the force which extends or compresses it in the same manner as a spring steel-yard or balance. If a scale be attached to the instrument at any point on the piston-rod to which an index might be attached, then the position of that index upon the scale would be governed by the position of the indicator piston in its cylinder. If any force pressed the indicator piston upwards, so as to compress the spring, the index would rise upon the scale; and if, on the other hand, a force pressed the indicator piston downwards, then the spiral spring would be extended, and the index on the piston-rod descend upon the scale. In each case the force of the spring, whether compressed or extended, would be equal to the force urging the indicator piston, and the scale might be so divided as to show the amount of this force.

Now let the instrument be supposed to be screwed upon the top of the cylinder of a steam engine, and the stop-cock opened so as to leave a free communication between the cylinder of the indicator below its piston and the cylinder of the steam engine above the steam piston. At the moment the upper steam valve is opened, the steam rushing in upon the steam piston will also pass into the indicator, and press the indicator piston upwards: the index upon its piston-rod will point upon the scale to the amount of pressure thus exerted. As the steam piston descends, the indicator piston will vary its position with the varying pressure of the steam in the cylinder, and the index on the piston-rod will play upon the scale, so as to show the pressure of the steam at each point during the descent of the piston.

52. If it were possible to observe and record the varying positions of the index on the piston-rod of the indicator, and to refer each of these varying positions to the corresponding point of the

descending stroke, we should then be able to declare the actual pressure of the steam at every point of the stroke. But it is evident that such an observation would not be practicable. A method, however, was contrived by Mr. Southern, an assistant of Messrs. Boulton and Watt, by which this is perfectly effected. A square piece of paper, or card, is stretched upon a board, which slides in grooves formed in a frame. This frame is placed in a vertical position near the indicator, so that the paper may be moved in a horizontal direction backwards and forwards, through a space of fourteen or fifteen inches. Instead of an index, a pencil is attached to the indicator of the piston-rod: this pencil is lightly pressed by a spring against the paper above mentioned, and as the paper is moved in a horizontal direction, the pencil would trace upon it a line. If the pencil were stationary, this line would be straight and horizontal, but if the pencil were subject to a vertical motion, the line traced on the paper moved under the pencil horizontally would be a curve, the form of which would depend on the vertical motion of the pencil. The board thus supporting the paper is put into connection by a light cord carried over pulleys with some part of the parallel motion, by which it is alternately moved to the right and to the left. As the piston ascends or descends, the whole play of the board in the horizontal direction will therefore represent the length of the stroke, and every fractional part of that play will correspond to a proportional part of the stroke of the steam piston.

53. The apparatus being thus arranged, let us suppose the steam piston at the top of the cylinder commencing its descent. As it descends, the pencil attached to the indicator piston-rod varies its height according to the varying pressure of the steam in the cylinder. At the same time the paper is moved uniformly under the pencil, and a curved line is traced upon it from right to left. When the piston has reached the bottom of the cylinder, the upper exhausting valve is opened, and the steam drawn off to the condenser. The indicator piston being immediately relieved from a part of the pressure acting upon it, descends, and with it the pencil also descends; but at the same time the steam piston has begun to ascend, and the paper to return from left to right under the pencil. While the steam piston continues to ascend, the condensation becomes more and more perfect, and the vacuum in the cylinder, and therefore also in the indicator, being gradually increased in power, the atmospheric pressure above the indicator piston presses it downwards and stretches the spring. The pencil meanwhile, with the paper moving under it from right to left, traces a second curve. As the former curve showed the actual pressure of the steam impelling the piston in its descent, this latter

## INDICATOR.

will show the pressure of the uncondensed steam resisting the piston in its ascent, and a comparison of the two will exhibit the effective force on the piston. Fig 30 represents such a diagram as would be produced by this instrument. *A B C* is the curve traced by the pencil during the descent of the piston, and *C D E*

Fig. 30.

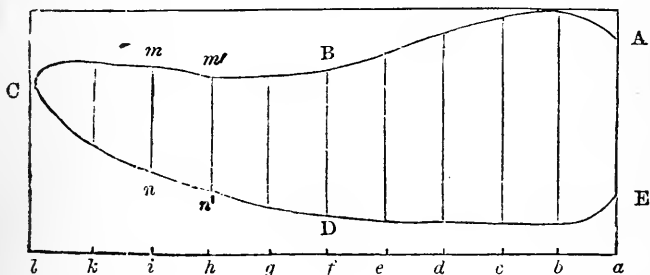

that during its ascent. *A* is the position of the pencil at the moment the piston commences its descent, *B* is its position at the middle of the stroke, and *c* at the termination of the stroke. On closing the upper steam valve and closing the exhausting valve, the indicator piston being gradually relieved from the pressure of the steam, the pencil descends, and at the same time the paper moving from left to right, the pencil traces the curve *C D E*, the gradual descent of this curve showing the progressive increase of the vacuum. As the atmospheric pressure constantly acts above the piston of the indicator, its position will be determined by the difference between the atmospheric pressure and the pressure of the steam below it; and therefore the difference between the heights of the pencil at corresponding points in the ascending and descending stroke will express the difference between the pressure of the steam impelling the piston in the ascent and resisting it in the descent at these points. Thus, at the middle of the stroke, the line *B D* will express the extent to which the spring governing the indicator piston would be stretched by the difference between the force of steam impelling the piston at the middle of the descending stroke, and the force of steam resisting it at the middle of the ascending stroke. The force, therefore, measured by the line *B D* will be the effective force on the piston at that point, and the same may be said of every part of the diagram produced by the indicator.

The whole mechanical effect produced by the stroke of the piston being composed of the aggregate of all its varying effects throughout the stroke, the determination of its amount is a matter of easy calculation by the measurement of the diagram supplied

by the indicator. Let the horizontal play of the pencil from  $A$  to  $C$  be divided into any proposed number of equal parts, say ten: at the middle of the stroke,  $B D$  expresses the effective force on the piston; and if this be considered to be uniform through the tenth part of the stroke, as from  $f$  to  $g$ , then the number of pounds expressed by  $B D$  multiplied by the tenth part of the stroke expressed in parts of a foot, will be the mechanical effect through that part of the stroke expressed in pounds' weight raised one foot. In like manner  $m n$  will express the effective force on the piston after three-fourths of the stroke have been performed, and if this be multiplied by a tenth part of the stroke as before, the mechanical effect similarly expressed will be obtained; and the same process being applied to every successive tenth part of the stroke, and the numerical results thus obtained being added together, the whole effect of the stroke will be obtained, expressed in pounds' weight raised one foot.

54. By means of the indicator, the actual mechanical effect produced by each stroke of the engine can be obtained, and if the actual number of strokes made in any given time be known, the whole effect of the moving power would be determined. An instrument called a *counter* was also contrived by Watt, to be attached either to the working beam, or to any other reciprocating part of the engine. This instrument consisted of a train of wheel-work with governing hands, or indices moved upon divided dials, like the hands of a clock. A record of the strokes was preserved by means precisely similar to those by which the hands of a clock or time-piece indicate and record the number of vibrations of the pendulum or balance-wheel.

55. Such, then, is the machine, and such the principal expedients by which it has been adapted as a moving power of unparalleled importance and efficiency in all the industrial arts. In certain applications of the engine some of these provisions are unnecessary or inapplicable. In others supplementary expedients are required and supplied. Our present purpose, however, will be attained, if we have succeeded in rendering clearly intelligible the general principle upon which the machine as described above acts, and the special uses of the accessories that have been described. These being well understood, no great difficulty will be encountered in comprehending the mechanism and the action of any special form of engine.



LONDON ENTRANCE TO THE LONDON AND NORTH-WESTERN RAILROAD.

## THE LOCOMOTIVE.

### CHAPTER I.

1. Familiar to every eye.—2. Its mechanism not generally understood.—3. Object of this Treatise.—4. Two modes of propelling wheel carriages.—5. How locomotive is propelled.—6. Action of piston-rod on wheels.—7. Dead points.—8. Unequal action.—9. How remedied.—10. Connection of piston-rods with wheels.—11. Wheels fixed on their axles.—12. Form of locomotive.—13. Driving-wheels.—14. Coupled wheels.—15. Consumption of steam.—16. Evaporating power of boiler determines efficacy of engine.—17. Fire-box.—18. Tubes through boiler.—19. Fuel.—20. Blast-pipe.—21. Tender.—22. Plans and sections, with their description.

1. ALTHOUGH it be the variety of the steam-engine, whose invention is the most recent in date, the locomotive is the form of the machine which is most familiar to the public in every country. To behold the vast engines used for drainage, mining countries

## THE LOCOMOTIVE.

must be visited ; to see those adapted to useful machinery, we must go to the factories ; to view those applied to navigation, we must descend into the holds of ships. The locomotive, however, needs not be sought. It is patent and obtrusive. It addresses the senses of hearing and seeing. The warning whistle and the snorting chimney are familiar to every ear, and the flashing speed of the engine, with its snake-like appendage of vehicles of transport, is familiar to every eye.

2. Of the countless multitudes in all civilised countries who witness the extraordinary performances of the locomotive, and participate in its use and enjoyment, few comprehend the source of its power, or the principle of its action. They see it sweep along with the speed of the hurricane, drawing after it carriages, carrying hundreds of human beings, or hundreds of head of cattle, or tons of goods. but the agency which accomplishes this miracle is to them wrapt in mystery. Many desire to possess the key to the enigma, to unlock the secret, but recoil from the labours which the perusal and study of even the most popular treatise on the locomotive would require, a labour for which few have the disposable time, and still fewer the qualifications depending on preliminary knowledge and intellectual aptitude.

3. It is this multitude that we now desire to address, hoping to offer, in a small compass, such a simple and clear account of the variety of steam-engine referred to, as will be intelligible to all persons, without more labour than all can conveniently devote to it.

4. A moving power may be applied in two ways to propel a vehicle supported on wheels. It may be harnessed to it as horses to a carriage, and may draw it on by traces, or it may be applied to the wheels, so as to make them revolve. If the wheels be made to revolve, they must either slip upon the road, or the vehicle must advance. But if the weight upon them be considerable, and the state of the road suitable, they will have such adhesion with the road at the points where they rest upon it, that they will not in general slip ; and if they do not, the vehicle which they support must be propelled by each revolution of the wheels through a space equal to the external circumference of their tires.

5. Now it is by this latter means that the power of steam is applied to propel the locomotive. The steam pistons are connected by iron rods, called connecting-rods, either with the spokes of the wheels, at certain regulated distances from the axles, or with arms, called cranks, formed on the axles between the wheels. The force with which the pistons are alternately driven by the steam from end to end of the cylinders, is conveyed by the connecting rods to the spokes or cranks, and it acts upon them in the

## ACTION OF PISTON ON WHEELS.

same manner as the arm of a man acts upon a windlass, thus imparting a continuous motion of revolution to the wheels.

6. To render this action of the piston on the wheels more apparent, the piston-rod, the connecting-rod, and the spoke or crank, are shown in fig. 1, in eight successive positions assumed by them during each revolution of the crank. The direction in which the connecting-rod acts upon the crank is indicated by the arrow.

The joint  $p$  unites the connecting-rod with the end of the piston-rod, and the joint  $r$  unites it with the end of the crank or spoke, the fixed centre round which the crank or spoke revolves being  $c$ .

While the piston makes a double stroke from one end of the cylinder to the other and back, the joint  $r$  makes one complete revolution round the centre  $c$ .

In the position shown in A, the piston is at the end of the cylinder most remote from the crank, and the joint  $r$  is directly between the centre  $c$  and the joint  $p$ .

In the position B, the joint  $r$  has moved from that position, the piston moving towards  $c$ , and the connecting-rod and crank forming an obtuse angle. The force of the steam impelling the connecting-rod in the direction shown by the arrow, acts at an obtuse angle with the crank.

As the piston continues to move, the angle formed by the connecting-rod and crank becomes less and less, until in the position shown in C the angle becomes a right angle, and then the whole force given to the connecting-rod becomes effective.

In the position D, the angle formed by the connecting rod and crank becomes acute, and in the position E, the joint  $r$  assumes a position in a direct line with  $c$  and  $p$ , and the piston has reached

Fig. 1.

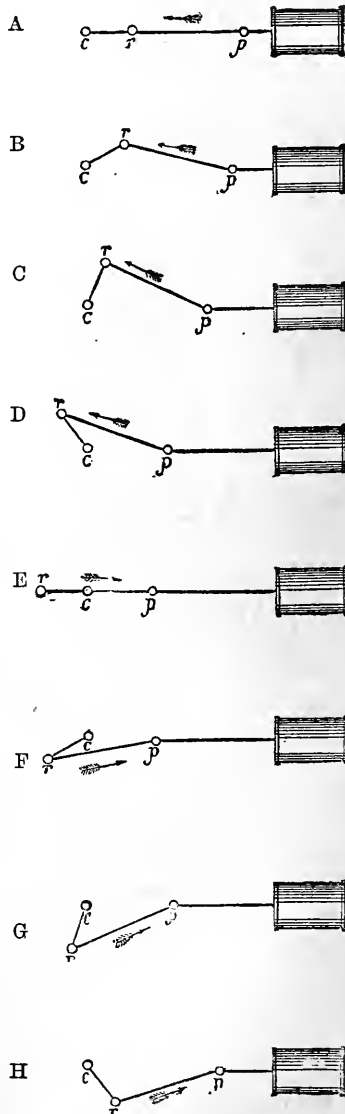

the end of the cylinder nearest to *c*. After this the piston begins to move from *c* towards the more remote end of the cylinder, and the joint *r* assumes successively the positions shown in *F*, *G*, and *H*, the crank making first an acute angle, then a right angle, and, in fine, an obtuse angle with the connecting-rod, until the piston has arrived at the more remote end of the cylinder, when the points *c*, *r*, and *p*, receive the position shown in *A*.

7. It must be observed, that in the positions shown in *A* and *E*, the connecting-rod being parallel to the crank, can have no power to turn it; that in passing from the position *A* to the position *c*, the rod being less and less oblique to the crank, has a continually increasing power to turn it, until at *c*, being at right angles to it, it has full power upon it. After passing the position *c*, the rod becoming more and more oblique to *c*, has less and less power upon it, until arriving at the position *E*, it is parallel with it, and loses all power over it.

The two positions shown in *A* and *E*, in which the piston is at one end or the other of the cylinder, and in which the piston loses all power to move the crank, are called the DEAD POINTS.

8. After passing the position *E*, when the piston, having changed the direction of its motion begins to return to the other end of the cylinder, the rod again forms an acute angle with the crank, and acts upon it, but with disadvantage, as shown in *F*.

The angle formed by the rod and the crank increasing, becomes at length a right angle, as in *G*, when the rod acts with full effect on the crank.

After this, the angle between the rod and the crank becomes obtuse, as in *H*, and the action is again disadvantageous, and more and more so as the angle becomes more and more obtuse, until at length the rod and crank return to the position represented in *A*.

Since the action of the piston upon the wheel is, therefore, unequal, having its greatest efficiency at the points shown in *c* and *e*, and ceasing altogether in the positions *A* and *E*, a single piston would give to the engine an unequal progressive motion. It would advance by starts, being impelled with most effect when the piston has the positions *c* and *e*, and moving only in virtue of the velocity already imparted to it when the piston is at the dead points *A* and *E*. The motion would be alternately fast and slow, according to the varying position of the connecting-rod and crank.

9. This inequality is effaced, and an uniform motion obtained by using two cylinders driving different cranks or different wheels, and so arranging them, that when either is at its dead points, the other is in its positions of greatest efficiency. This is accomplished simply by placing the two cranks at right angles to each other, or



## CRANKED AXLE.

by connecting the rods with spokes at right angles to each other. By such an arrangement, the combined effects of the two cranks will be invariable, or nearly so, the effect of either increasing exactly as that of the other decreases.

10. The cylinders are sometimes placed between and sometimes outside the wheels.

If they are placed between one pair of wheels the axle of another pair is formed with two cranks, placed at right angles to each, which are worked by the connecting-rods of the pistons.

Such a double-cranked axle is shown in fig. 2, the cranks being seen in a position oblique to the plane of the diagram. The connecting-rods are understood to be attached to the cranks at B, and the wheels, which are to be driven, are keyed upon the extremity of the axle at G.

When the cylinders are placed outside the wheels, the connecting-rods are attached to two spokes, one upon each of the wheels which they are intended to drive, these two spokes being in positions at right angles to each other, and the wheels being keyed upon the axles, so that the wheels and axles turn together.

11. It may be stated generally that the wheels of railway vehicles and engines do not turn upon their axles like those of common road carriages, but are always fixed upon the axles, so that the wheel and axle turn together, and, consequently, whether the force of the connecting-rods act upon the spokes of the wheels, or upon cranks formed upon the axle, they will be equally efficient in imparting rotation to the wheels and consequently impelling the engine.

12. The locomotive engine is commonly supported on three pairs of wheels. In some cases of small and light engines there are only two pairs, and in others there are four pairs.

The general form and disposition of the parts of a locomotive upon three pairs of wheels is shown in fig. 3. In this case the two cylinders are placed immediately in front of the fore wheels and under the chimney. The intermediate pair of wheels are driven by the connecting-rods.

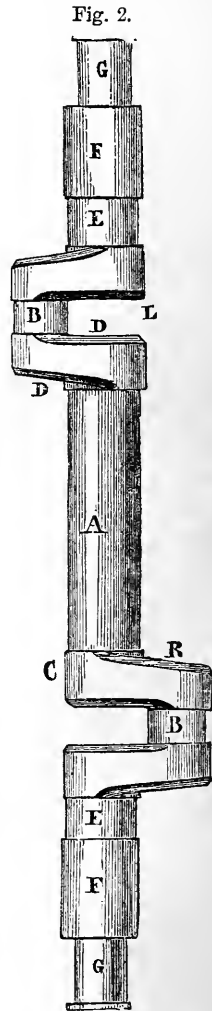

# THE LOCOMOTIVE.

13. The pair of wheels to which revolution is imparted by the piston-rod, through the intervention of the connecting-rods, are

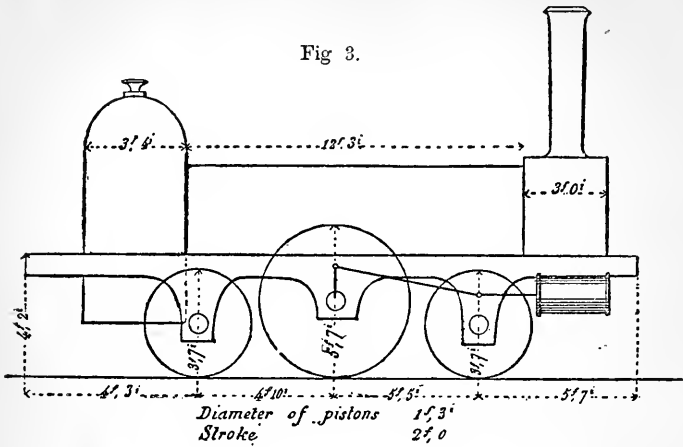

called the **DRIVING-WHEELS**, since it is by their immediate action that the engine draws the train which is attached to it. They are generally of greater diameter than the supporting-wheels, in order that the engine may be propelled through a greater space by each stroke of the piston, since the space through which it moves by each double stroke is equal to the circumference of the driving-wheels.

The actual dimensions of such an engine as is represented, are indicated on the diagram.

In some engines of more recent construction the driving-wheels are placed in the hindermost part of the engine, the cylinders

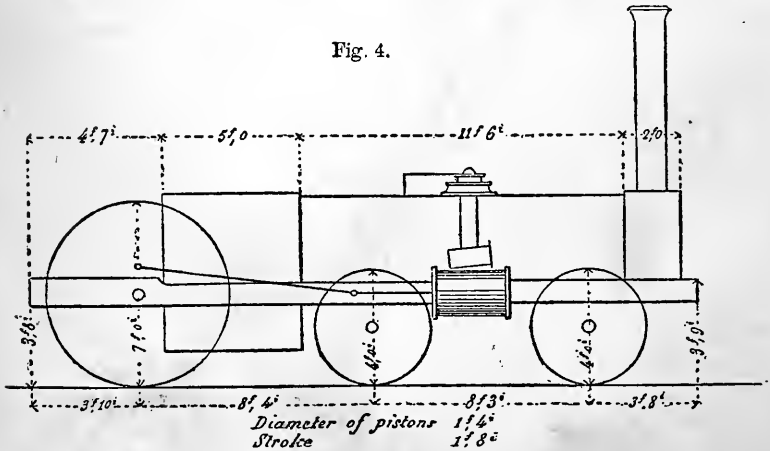

being between the intermediate and foremost pairs of wheels, as

## DIFFERENT FORMS OF LOCOMOTIVES.

represented in fig. 4. In these the driving-wheels are of greater dimensions, and the engine is adapted to attain greater speed.

A lighter and less powerful class of locomotive, supported on two pairs of wheels, is shown in fig. 5, the hinder pair being the driving-wheels.

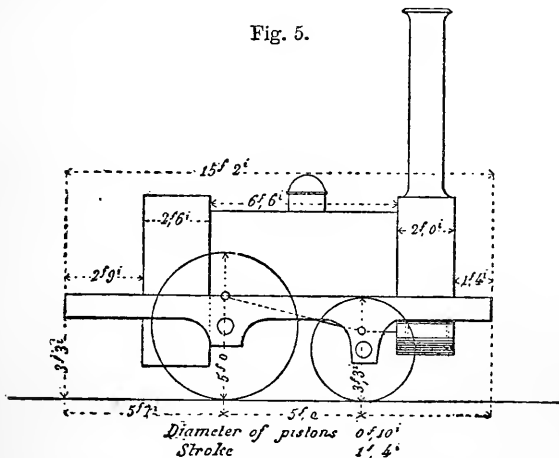

14. When locomotives are intended to draw very heavy loads with less speed, as in the case of goods engines, the driving-wheels have less dimensions, and, in order to give them a greater hold upon the rails, it is usual to connect two pair of side wheels, of exactly equal dimensions, so that the piston shall act at once on both by means of the connecting-rods. The two pair of driving-wheels thus connected are said to be **COUPLED**, and the engine is

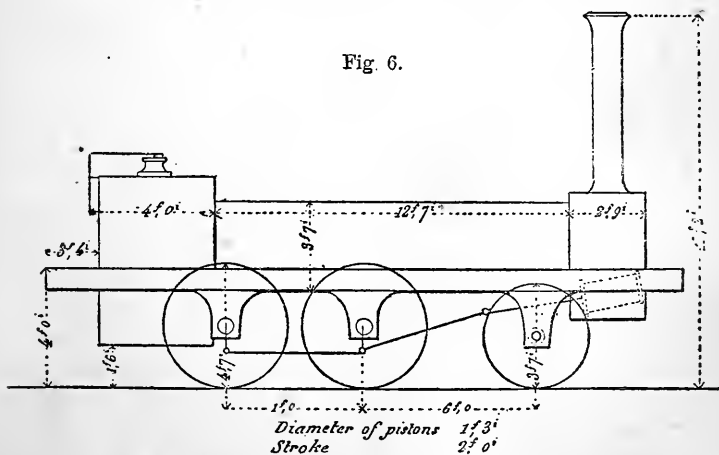

called a **coupled-engine**. Such an engine is shown in fig. 6, where the hinder and intermediate pairs are coupled, the connect-

ing-rods being attached to the intermediate pair, and through them acting also on the hinder pair.

15. It has been shown that to give a revolution to the driving-wheels, each of the pistons must move once backwards and forwards in the cylinder, and consequently the boiler must supply to the cylinders four measures of steam. In this way, the consumption of steam necessary for a given progressive speed of the carriage may be calculated. Thus, if the circumference of the driving-wheels be thirty feet, four cylinders full of steam will be consumed for each thirty feet through which the carriage advances. It is apparent, therefore, that the ability of the engine to move the load with any requisite speed is resolved into the power of the boiler to produce steam of the requisite pressure at this required rate.

Let it be supposed that it is desired to transport a certain load at the rate of thirty miles an hour, which is at the rate of half a mile, or 2640 feet per minute. Let the circumference of the driving-wheels be twenty-six feet and four-tenths. These wheels will revolve one hundred times in moving over 2640 feet, or half a mile, that is to say, one hundred times per minute. But since each revolution requires the boiler to supply four cylinders full of steam, the consumption of steam per minute will be four hundred times the contents of the cylinder.

16. The pressure of the steam will depend upon the resistance of the load. By the common principles of mechanics, the power acting upon the pistons necessary to balance a given resistance at the circumference of the wheel can be easily calculated, and thus the necessary pressure of the steam ascertained. In this manner it can always be determined how much steam, of a given pressure, the boiler must produce, in order to enable the engine to carry a given load with any required speed.

The mechanism being properly constructed, it follows, therefore, that the efficacy of the engine must depend ultimately on the evaporating power of the boiler.

In the case of the locomotive engine there are particular conditions which limit the magnitude and weight of the machinery, and create impediments and difficulties in the construction of the machine, which are not encountered in stationary engines. As the engine itself is transported, and travels with its load, it must necessarily be subject to narrow limits as to weight and bulk. It has to pass under bridges, and through tunnels, which circumstance not only limits its general magnitude, but almost deprives it of the appendage of a chimney, so indispensable to the efficiency of stationary steam-engines.

It follows that this limitation of weight and bulk can only be

## EVAPORATING POWER—FURNACE.

rendered compatible with great power of evaporation by expedients which shall produce, in a small furnace, an extremely intense combustion, and which shall ensure the transmission to the water completely, and immediately, of the heat developed in such combustion.

17. The heat developed in the combustion of fuel in a furnace is propagated in two ways. A part radiates from the vivid fuel in the manner, and according to nearly the same laws which govern the radiation of light. These rays of heat, diverging in every direction from burning fuel, strike upon all the surfaces which surround the furnace. Now, as it is essential that they should be transmitted immediately to the water in the boiler, it follows that the furnace ought to be surrounded on every side with a portion of the boiler containing water; in short, a hollow casing of metal, filled with water, ought to surround the fireplace. By this expedient, the heat radiating from the fuel, striking upon the metal which forms the inner surface of such casing, will enter the water, and become efficient in producing evaporation.

Whatever then be the particular form given to the engine, the furnace must be surrounded by such a casing. This casing is called the FIRE-BOX. The bottom of it is occupied by a grate, which should consist of bars sufficiently deep to prevent them from being fused by the fuel which rests upon them, having sufficient space between them to allow the air to enter so freely as to sustain the combustion, but not such as to allow the unburned fuel to fall through them.

18. The limited magnitude of locomotive boilers renders the construction of the extensive flues used in stationary boilers impracticable; and accordingly, in the early engines, a great waste of heat was occasioned, owing to the flame and heated air being permitted to issue into the chimney before their temperature was sufficiently reduced by contact with the flues.

At length an admirable expedient was adopted which completely attained the desired end. The boiler was traversed by a considerable number of small tubes of brass or copper, running parallel to each other from end to end, the furnace being at one end of the boiler, and the chimney at the other. The flame and heated air which passed from the furnace had no other issue to the chimney except through these tubes. It was thus driven, in a multitude of threads, through the water. The magnitude and number of the tubes was so regulated, that when the air arrived at the chimney, it had given out as much of its heat as was practicable to the water.

The full importance of this expedient was not appreciated until

## THE LOCOMOTIVE.

long after its first adoption. In the first instance, the tubes traversing the boiler were small in number, and considerable in diameter, but as their effects were rendered more and more evident by experience, their diameter was diminished and their number increased, and at length it was not uncommon for the boiler to be traversed by one hundred and fifty tubes of one inch and a half in internal diameter.

The heat was thus, as it were, strained out of the air before the latter was dismissed into the chimney.

These tubes were necessarily kept below the surface of the water in the boiler, so that they were constantly washed by the water, and the heat taken up from them was absorbed immediately by the bubbles of steam generated at their surface, which bubbles continually rose to the top of the boiler and collected in the steam chamber.

It will be understood from these observations, that the evaporating power of the locomotive boiler, is determined by the quantity of surface exposed to the radiant heat in the fire-box and the quantity of surface exposed to the action of the heated air in the tubes. The expression of the quantity of this surface in square feet is the usual test of the evaporating power of the boiler.

19. Much of the efficacy of these boilers depends on the quality of the fuel. As the engines travel through districts of the country more or less populous, the evolution of smoke is inadmissible in consequence of the nuisance it would produce. It was, therefore, resolved to use coke as fuel instead of coal.

Another advantage, however, attended the use of this fuel. Coke being composed chiefly of carbon, to the exclusion of the more volatile constituents of coal which produce flame in the combustion, the chief part of the heat developed acts by radiation. No flame issues from the furnace, and heated air only passes through the tubes. It is more easy, therefore, to extract the heat than would be the case if flame were developed. In short, with this fuel, the portion of the heat developed in the furnace is much greater than that which would be developed in the combustion of coal. The surface of the fire-box becomes relatively more efficient, and the flues less so than in stationary engines where coal is used.

Independently, therefore, of the advantage of developing no smoke, the coke is a form of fuel better adapted to the condition of the locomotive engine.

20. To sustain a rapid and intense combustion on a grate necessarily small, a proportional force of draft is indispensable. In stationary engines, as is well known, the draft in the furnace is usually produced by a chimney of corresponding elevation; but

this being inadmissible under the conditions of the locomotive engine, it is necessary to adopt some other expedient to produce the necessary current of air through the tube. A blower, or fanner, working in the funnel or in any other convenient position, would answer the purpose; but a much better expedient has been adopted.

The steam, after driving the piston, is allowed to escape, but in order to turn it to profitable account, instead of being dismissed into the atmosphere, where it would produce a cloud of vapour around the engine, it is conducted through a pipe to the base of the funnel, where it is allowed to escape in a jet directly up the chimney. In this manner a puff of waste steam escaping from the cylinders as the pistons arrive at the one end or the other, is injected into the chimney, and a constant succession of these puffs take place, four being made for every revolution of the driving-wheels. These continual puffs of vapour maintain in the chimney a constant current upwards, by which the air and gases of combustion are drawn from the fire-box through the tubes.

The pipe by which these jets are directed up the chimney, called the *blast-pipe*, serves the purpose of a most efficient bellows.

Those who are not familiar with steam machinery will not find it difficult to comprehend that a bellows would produce the same effect on the fire if it acted in the chimney, or even at the top of the chimney, as if it were applied at the grate bars, provided only that the mouth of the chimney near the fire be closed by a door, as it always is in steam-engines.

21. To keep the locomotive boiler supplied with water, and its furnace with fuel, it is accompanied by a carriage called a *tender*, which bears a supply of fuel, and a cistern of sufficient magnitude, containing water.

This cistern is connected with the interior of the boiler by pipes and force-pumps. The force-pumps are worked by the engine. The engineer is supplied with a lever, by which he can suspend the action of the pumps at pleasure; so that, if he finds the boiler becoming too full, he can, to use a technical phrase, "cut off the feed." Gauges are provided, by which he can at all times ascertain the quantity of water in the boiler, or, which is the same, the position of its surface. He is accompanied by a stoker or fireman, who from time to time opens the door of the fire-box and feeds the furnace.

22. This general description of a locomotive and its accessories, will be more clearly understood by the aid of diagrams, showing the principal sections and plans of an engine and tender.

A series of drawings, showing in section and elevation various

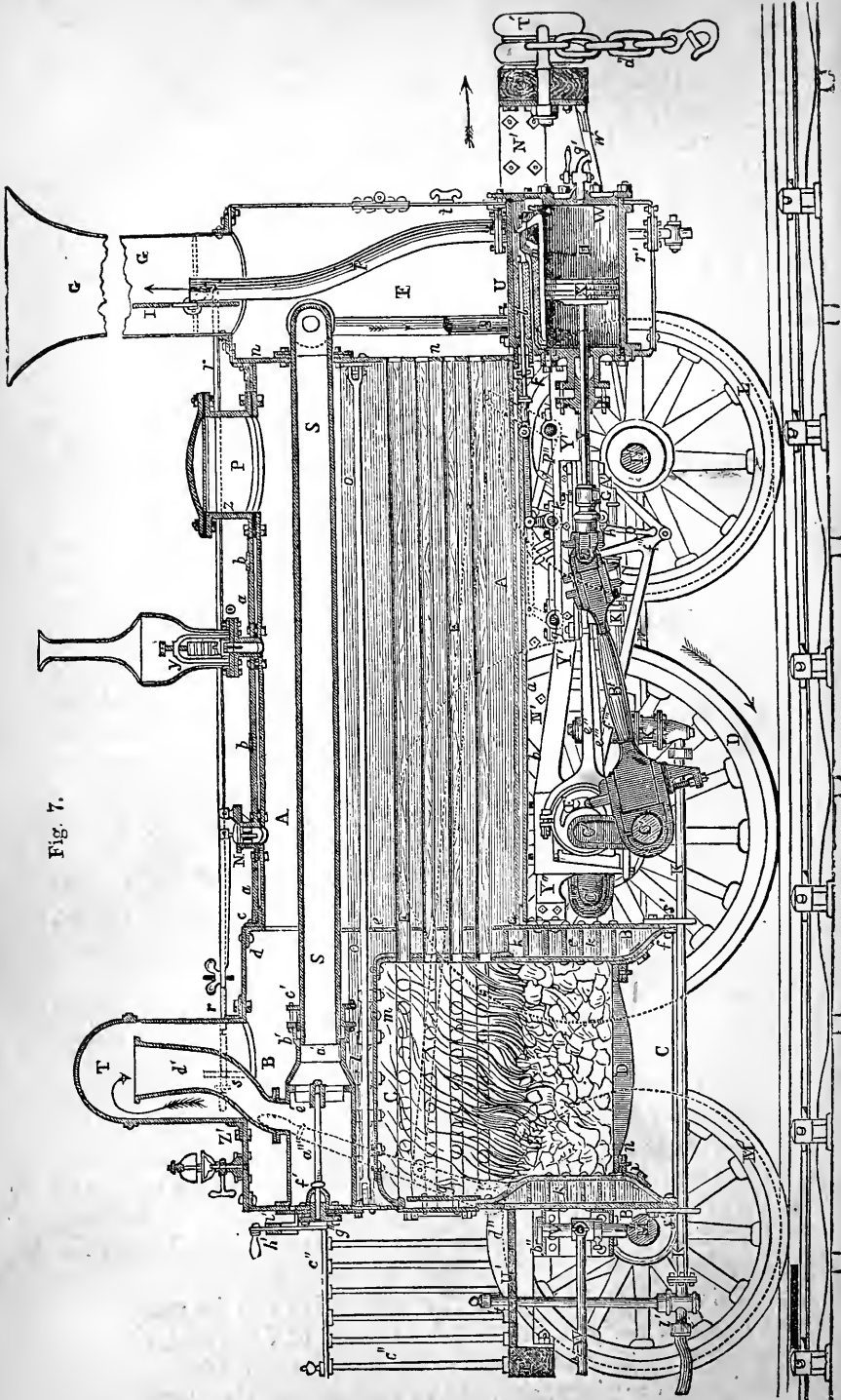

Fig. 7.



PLANS AND SECTIONS OF ENGINE.

views of a loco-  
motive engine on  
three pairs of  
wheels with its  
tender, is given  
in figs. 7, 8, 9, 10,  
11, 12, 13, and 14.

Fig. 7 is a  
longitudinal verti-  
cal section,  
made by a plane  
parallel to the  
wheels, and pass-  
ing through the  
axis of the boiler  
and the smoke-  
funnel.

Fig. 8 is a  
plane of the  
working machi-  
nery between the  
wheels and be-  
neath the boiler.

Fig. 9 is a  
transverse verti-  
cal section made  
by a plane pass-  
ing through the  
fire-box at right  
angles to the  
wheels.

Fig. 10 is a  
similar trans-  
verse section,  
made by a plane  
passing through  
the smoke-box  
and the axis  
of the smoke-  
funnel.

Fig. 11 is an  
elevation of the  
end of the engine  
near the driver's  
stage.

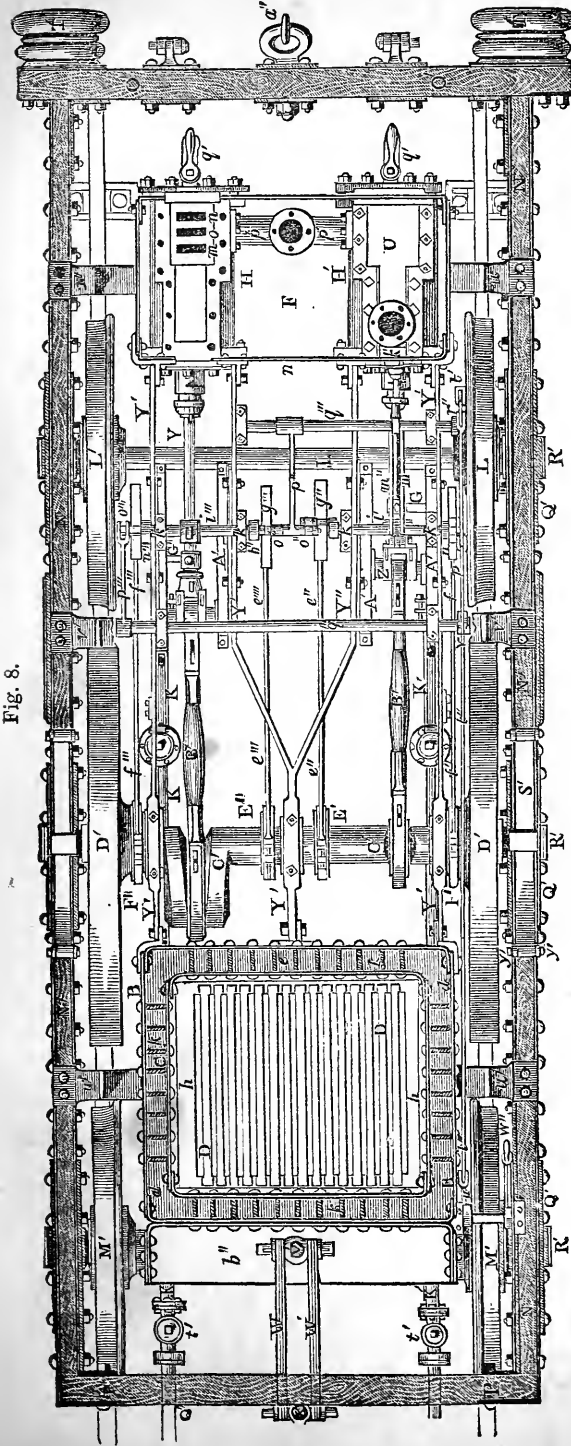

Fig. 8.

# THE LOCOMOTIVE.

Fig. 12 is a similar elevation of the end next the smoke-funnel.

Fig. 9.

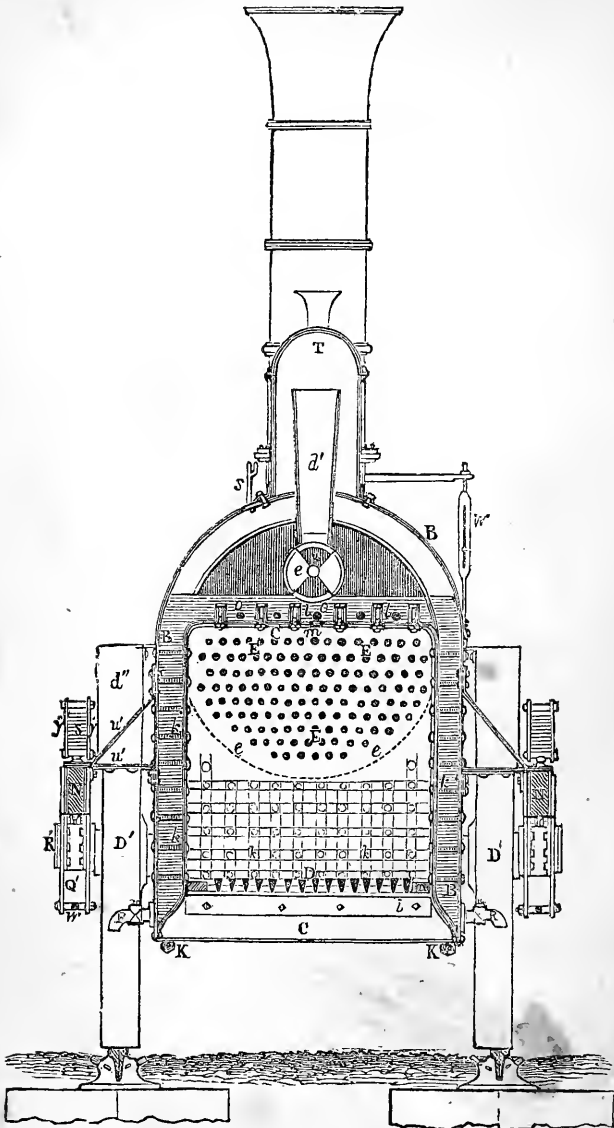

Fig. 13 is a longitudinal vertical section of the tender, by a plane at right angles to the wheels, and midway between them.

Fig. 14 is a plan of the tender seen from above.

The same parts in the different drawings are generally indicated by the same letters.

## PLANS AND SECTIONS.

The principal parts will be recognised by the preceding general description, and the following references:—

	Number of diagram.	Letters of reference.
The steam cylinders . . . . .	7, 8	H
The steam pistons . . . . .	7	X
The piston-rods . . . . .	7, 8	Y
The connecting-rods . . . . .	7, 8	B'
The cranks driven by them which in this case are constructed on the axle of the driving-wheels	7, 8	C'
The driving-wheels . . . . .	7, 8, 9	D'
The supporting-wheels . . . . .	7, 8, 10, 11, 12	L, M
The passages to allow the entrance and escape of the steam to and from the cylinder . . . . .	8	<i>m, n, o</i>
The case containing the slide by which these passages are opened and closed . . . . .	8	U
Two pair of eccentrics by which the slides are moved, one governing the steam so as to move the engine forward, and the other so as to move it backward . . . . .	8	E' E'', F' F''
The rods by which these eccentrics act upon those of the slides . . . . .	8	<i>e'' e''' f'' f'''</i>
The handle or lever by which the engine driver throws one or other pair of eccentrics into connexion with the slides . . . . .	7	<i>a'''</i>
The steam-chest, where dry steam free from mixture with aqueous spray is received from the boiler	7, 11	T
The steam-pipe leading from this chest by which steam flows to the slides and to the cylinder	7	SS
The blast-pipe, by which steam, after entering the piston, is discharged in puffs up the smoke- funnel . . . . .	7, 10	<i>p</i>
The fire-box containing the burning coke . . . . .	7, 9	CC
The hollow metal casing surrounding it secured by bolts and nuts, and filled with water . . . . .	7, 8, 9	<i>k k'</i>
The grate bars forming the bottom of the fire-box	7, 8, 9	D
The fire door through which coke is put in from time to time to feed the furnace . . . . .	11	<i>g</i>
The tubes traversing the boiler longitudinally through which the hot gases of combustion and smoke pass from the fire-box to the smoke-box . . . . .	7, 9, 10	EE
The smoke-box at the base of the funnel, receiving the heated air from the tubes . . . . .	7, 8, 10	F
The smoke-funnel over the smoke-box and blast- pipe . . . . .	7, 10, 12	G
The regulator, by which more or less steam is allowed to pass along the steam-pipe, and by closing which the steam is altogether cut off from the cylinder . . . . .	7	<i>h'</i>
The stage upon which the engine driver and stoker stand . . . . .	7, 11	P' c''

# THE LOCOMOTIVE.

	Number of diagram.	Letters of reference.
The water gauge, being a glass tube communicating above and below with the interior of the boiler, in which the water stands at the same level as in the boiler . . . . .	11	L
Gauge-cocks, which serve a like purpose, one being below and the other above the proper level of the water. If the water be below the proper level, steam would issue from the lower, and if above it, water would issue from the upper cock . . . . .	11	M
The feed-pump, being a force-pump worked by the engine, by which water is forced into the boiler from time to time to replace that which is evaporated . . . . .	7, 8	K'
The feed-pipe, leading from the feed-cistern on the tender to the feed-pump . . . . .	7	K
The levers by which the engine driver governs the feed. These open or close the feed-pipe according as they are turned one way or the other. When the engine driver sees the level fall too low in the water gauge or by the gauge-cocks, he opens the feed-pipe by these cocks and puts on the feed, and when it has risen to the proper point he closes them. There are usually two feed-pumps, with their appendages . . . . .	11	t' t'
The smoke-box door, opening on hinges at the top by which that part of the engine may be cleaned . . . . .	12	t
The buffers, being circular cushions fixed upon the ends of strong iron rods, which re-act against spiral springs, to break the force in case of collision . . . . .	7, 12	T T'
The heads of the cylinders, which are secured by bolts and nuts, and can be taken off for the purpose of cleansing the ash-pit . . . . .	12	W W
The feeding cistern on the tender . . . . .	13, 14	I''
The feed-pipe proceeding from it . . . . .	13	P'' Q''
The coupling of the parts of the feed-pipe attached to the engine and the tender . . . . .	13	P''
The coupling bar of the tender and engine . . . . .	13	W''
The coupling chain of tender and train . . . . .	13	Y''
The buffers of the tender . . . . .	13, 14	D''
The lids of the feed-cistern . . . . .	14	N''
The handle of the brake upon the tender . . . . .	14	X''
The space for coke . . . . .	14	B''

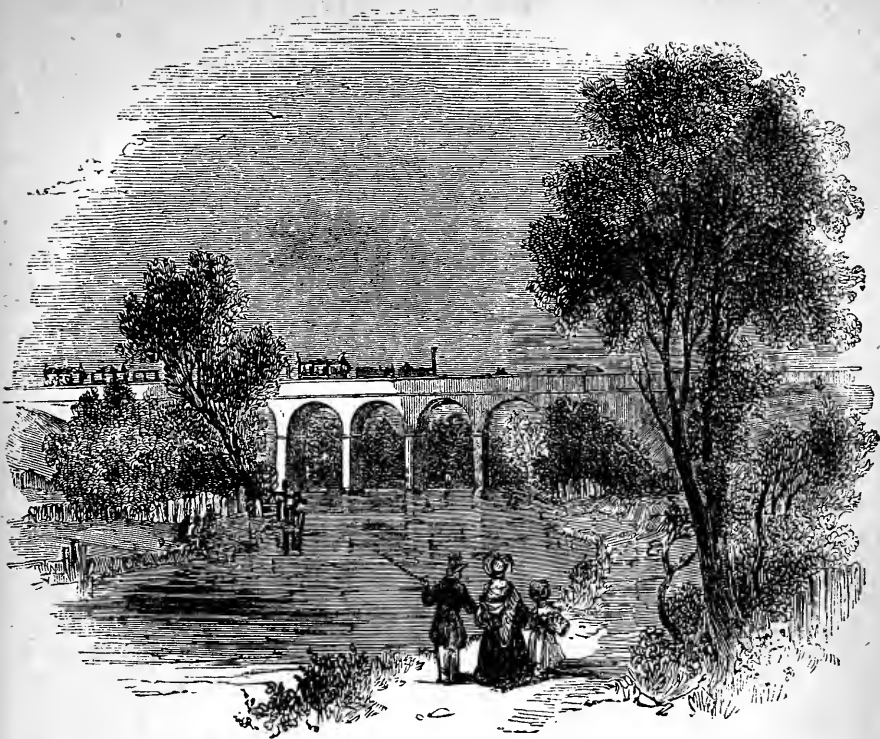

VIADUCT, NEAR WATFORD, LONDON AND NORTH-WESTERN RAIL-ROAD.

## THE LOCOMOTIVE.

### CHAPTER II.

23. Speed.—24. Locomotive stock.—25. What record of the performance and condition of an engine should be kept.—26. Cause of renewals of English locomotives.—27. Average mileage of engines.—28. Locomotive requires rest.—29. Expense of cleaning and lighting.—30. Reserve engines.—31. Bank engines.—32. Time they are kept standing.—33. Economy of fuel.—34. Register of consumption.—35. Small amount of useful service obtained.—36. On Belgian lines.—37. On other Continental lines.—38. On London and North Western line.—39. Comparisons between lines not fairly instituted.—40. Legitimate test of comparison.—41. Amount of locomotive stock required.—42. Gross receipts of European Railways in 1850.—43. Mileage of the same.—44. Great increase since.—45. Enormous consumption of coal.—46. Mileage of passengers and goods.

23. WHEN the extraordinary speed sometimes imparted to the loads drawn by locomotive engines on the English railways is considered, it will not be uninteresting to explain what operations

## THE LOCOMOTIVE.

the machinery of the engine must perform in order to accomplish such effects.

Let us take the example, not uncommon, of a train of coaches

Fig. 10.

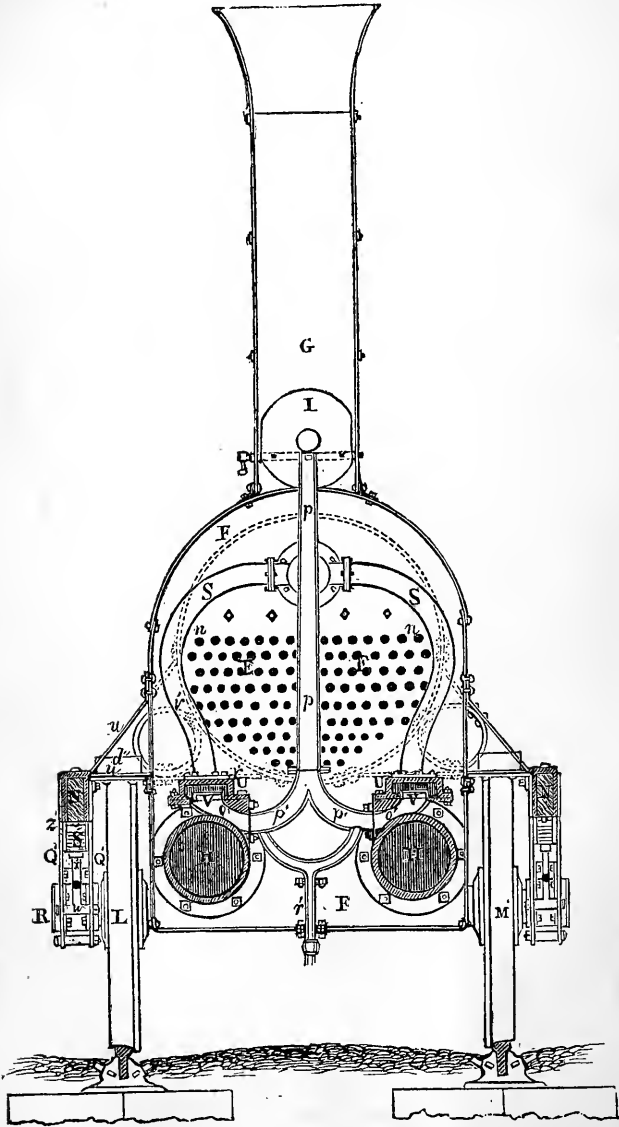

carried upon a railway, at a rate of sixty miles per hour. Assuming, as in a former example, that the circumference of the driving wheel measures  $26\frac{4}{10}$  feet, these wheels, as already explained, will revolve one hundred times in passing over half a mile, and there-

## OPERATION OF ENGINE.

fore two hundred times in passing over a mile. The speed of sixty miles an hour is that of a mile per minute. The driving wheels will, therefore, revolve two hundred times per minute. But it

Fig. 11.

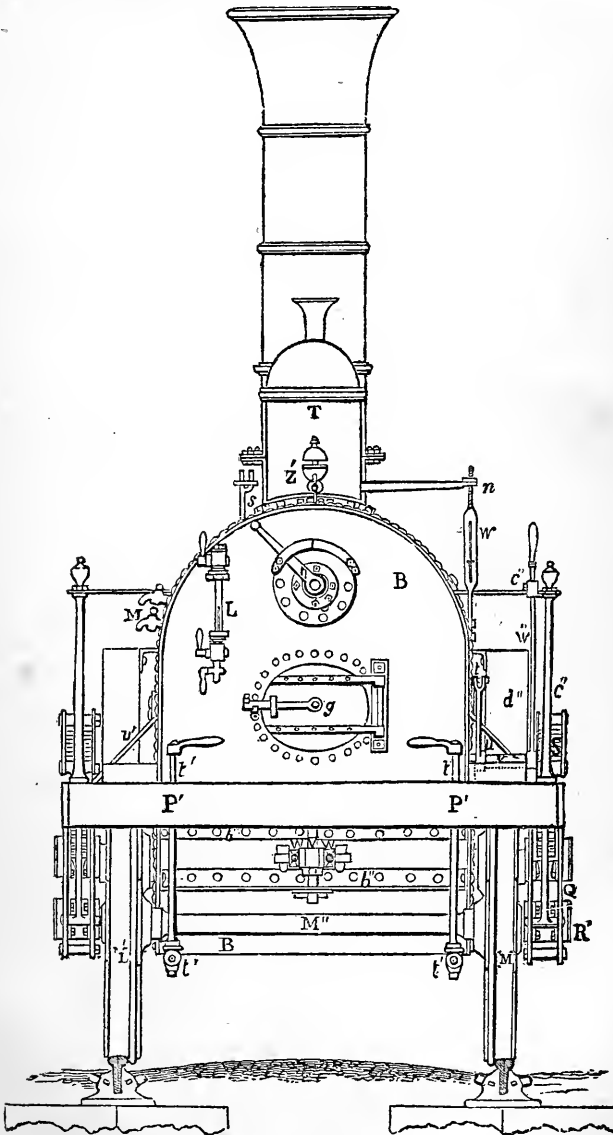

has been already explained that to produce one revolution of the wheels each piston is moved once backwards and forwards in each cylinder, and each cylinder must be twice filled with steam from

# THE LOCOMOTIVE.

the boiler, and that steam must be twice discharged from each cylinder through the blast pipe. It follows, that to accomplish the speed above mentioned, the boiler must supply to the cylinders

Fig. 12.

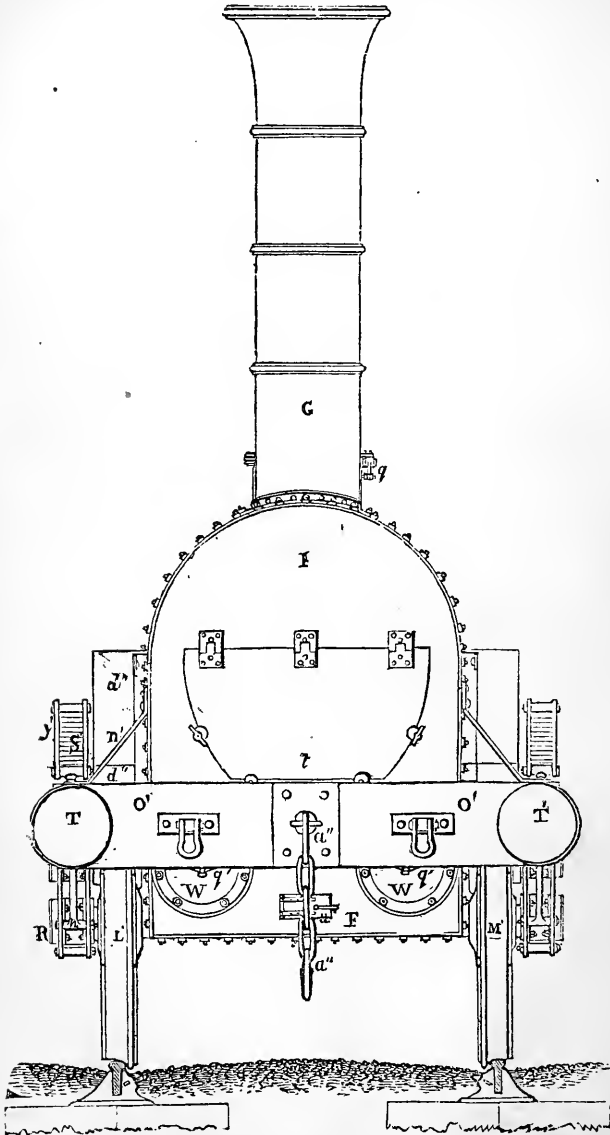

eight hundred measures of steam of the requisite pressure per minute. The valves which admit this steam to each cylinder must be opened four hundred times per minute, as must also both valves



## NECESSARY EVAPORATION.

by which the steam is ejected. The puffs from the blast-pipe must be made at the rate of eight hundred per minute.

If we assume that the contents of each cylinder is one cubic foot and a quarter, then the boiler must supply to the cylinder per minute 1000 cubic feet of steam. If this steam be assumed to have a pressure of 50 lbs. per square inch, then one cubic foot

Fig. 13.

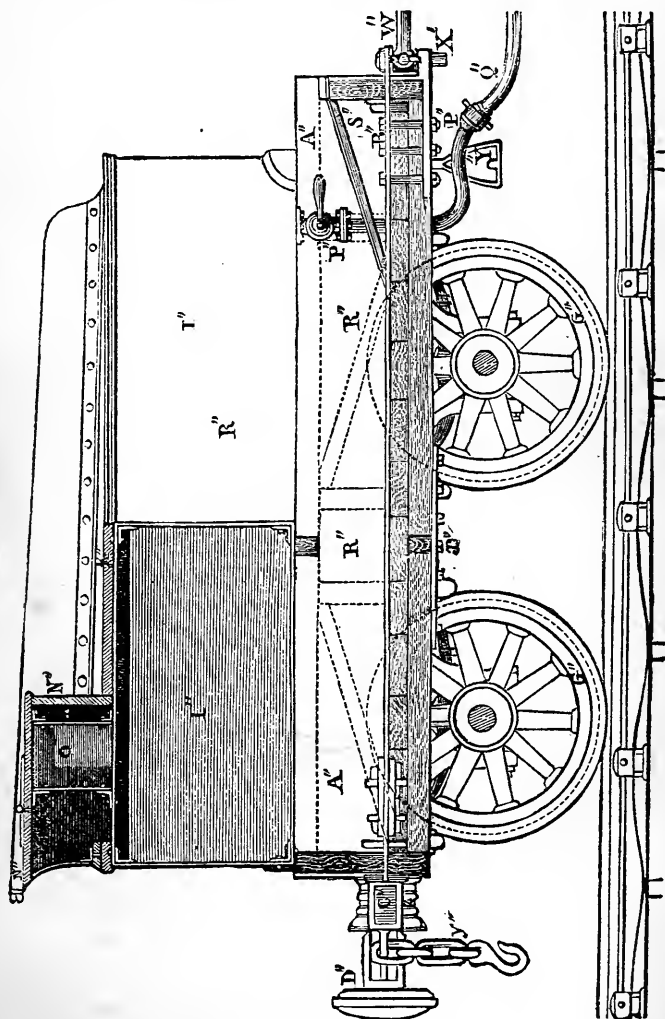

of water evaporated will produce about 500 cubic feet of such steam; and consequently, to supply 1000 cubic feet of steam per minute to the cylinders, the boiler must evaporate two cubic feet of water per minute, or 120 cubic feet per hour. This is a rate of evaporation which would correspond to a stationary boiler of a nominal power of 120 horses.

## THE LOCOMOTIVE.

24. When the magnitude of the capital invested in the locomotive stock of a railway, and the large proportion of the annual revenue absorbed in maintaining it are considered, its economical importance may be readily estimated.

The locomotive stock may be primarily resolved into two classes—that which is employed in working the passenger traffic, and that which is employed in drawing the goods trains.

Fig. 14.

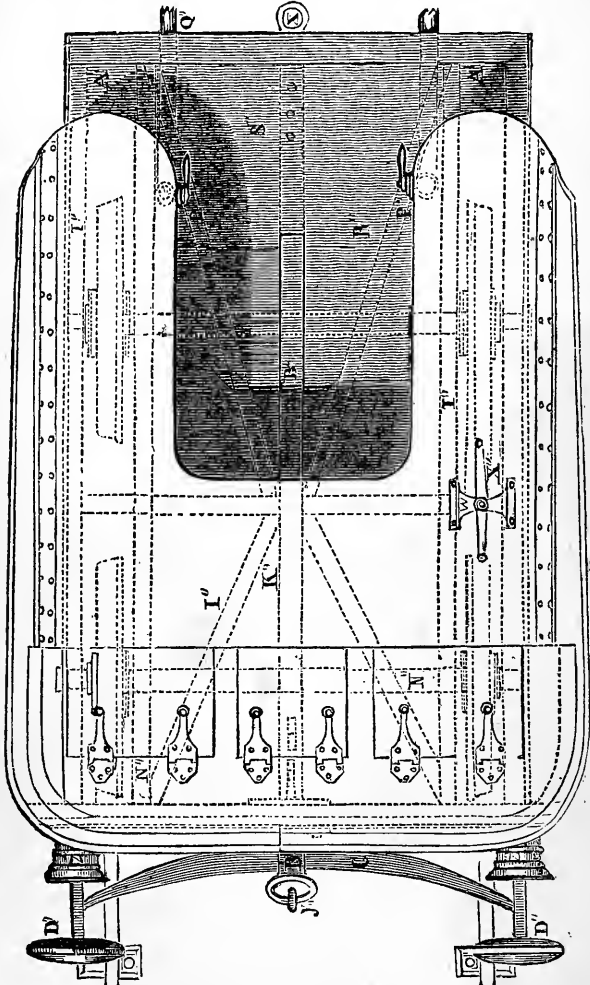

The passenger engines are so constructed as to draw light loads at great speed, the goods engines heavy loads at a low speed. In the one, the driving-wheels are large, so as to carry the train forward through a great space by each stroke of the piston; in the other, they are of more limited magnitude, in order to give the moving power a greater leverage upon the load. In the one, they

## LOCOMOTIVE REGISTER.

are single, rendering the engine light, so as to absorb less of the moving power in propelling itself; in the other, they are double and coupled, and sometimes even tripled, so as to give a greater purchase to the impelling power. In the one class of engine steam of small density is consumed rapidly and in great volume; in the other, steam of greater density is consumed at a slower rate.

These different mechanical requirements render it necessary, in general, to provide a locomotive stock for the goods service, separate from, and independent of, that provided for the passenger service.

25. In the locomotive department a register should be kept containing a record of the past and current performances and condition of every engine in the service of the railway. Such a record should contain the following particulars of the past services of each engine:—

1st. The day and year it was put upon the road.

2nd. Its maker.

3rd. The diameter and stroke of its cylinders.

4th. The diameter and number of its driving-wheels.

5th. The number of times it was cleaned, lighted, and had steam raised.

6th. The number of hours it was standing with steam raised.

7th. Its total mileage, from the commencement of its service to the current date.

8th. The total quantity of fuel it had consumed.

9th. Original cost of engine.

10th. Total sum expended on its repairs.

And, with respect to its current service during the past year, the following details should be given:—

1st. The number of times it was lighted, and had steam raised.

2nd. The number of hours it stood with steam raised.

3rd. Its mileage by months, and its total mileage.

4th. The quantity of fuel consumed in lighting and raising steam.

5th. The quantity of fuel consumed in standing.

6th. The quantity of fuel consumed in working.

7th. A memorandum of any accident, or other notable circumstance, attending the performance of the engine.

Such a record as the above is neither impracticable nor unimportant. A register of this kind is kept by the administration of the Belgian railways, and the principal results of it are published annually, in a tabulated form, in the "Compte Rendu," or official report of the service of the railways, delivered to the Chambers by the Minister of Public Works every session. Such a table exhibits a "coup d'œil" of the condition and the past history of the entire locomotive stock.

## THE LOCOMOTIVE.

26. In the progress of the English railways, locomotives have been, from time to time, cast aside, and put, as it were, upon the retired list; but this has often arisen, not from the circumstance of their being superannuated, but because the conditions of the traffic had undergone such a change that the natural powers of these engines were not suited to it. Immediately after the commencement of the operation of the railway system, the traffic augmented so rapidly as to exceed all the provisions of those who constructed and organised the first railways. The weight and strength of the rails were successively increased, as well as the weight and magnitude of the trains, and the weight and power of the engines underwent a corresponding augmentation.

A regularly kept journal of the life of some of the oldest locomotives working on the English railways would be a record of profound interest. Whether such a register exists, I am not aware; but none such has, I believe, ever been published.

27. From a comparison of the total mileage of each class of the locomotive stock with the number of engines in service, the average mileage of each engine can be ascertained.

As an example of such a calculation, let us take the Belgian railways for 1847.

The total number of engines in active service was 154, and their total mileage was 2,366,885; this divided by 154 gives 15,369 as the average annual mileage of each engine, the average daily mileage being therefore 42 miles.

28. It may be asked, whether a locomotive engine, once lighted, may not be worked almost indefinitely?

It is known that many steam-engines used in the manufactures and in mining are kept for several months together in unceasing action night and day; and the engines used in steam-ships are often kept in incessant operation throughout a voyage of 3000 miles. Why therefore, it may be demanded, may not a locomotive engine be worked for a much longer distance without interruption, and thus distribute the expense of lighting and cleaning over a greater extent of mileage, and thereby diminish the cost per mile?

Although the mileage of the engine might be augmented much beyond its present amount, it is nevertheless indispensable that it should not exceed a certain practical limit. The locomotive engine, an iron horse, requires intervals of repose as much as do the horses of flesh, blood, and bones. It becomes fatigued, so to speak, with its work, and its joints become relaxed by labour, its bolts loosened, its rubbing surfaces heated, and often unequally expanded and strained. Its grate-bars and fire-box become choked with clinkers, its tubes become charged with coke; and were its labour continued

## RESERVE ENGINES.

to a certain point, it would end in a total inability to move. The durability of the engine, therefore, requires that its work should be suspended before these causes of disability operate to an injurious extent.

When its labour ceases, the engine-cleaners, who are, as it were, its grooms, clean out its fireplace, scrape its grate-bars and the internal surface of the fire-box, clean out its tubes, tighten all its bolts and rivets, oil and grease all its moving parts, and, in a word, put it again into working order.

29. The expense of cleaning an engine, and the cost of the fuel consumed in lighting it and raising the steam, so as to prepare it for propulsion, must necessarily be charged upon the mileage which it performs; and the cost of this mileage will therefore be augmented in the inverse proportion of the ratio of the total mileage of the engine to the number of times it has been cleaned and lighted during the period of its service. It is therefore important, in the economy of the locomotive power, to ascertain with precision the proportion which the mileage of the engines bears to the number of times they have been cleaned and lighted.

Hence appears the importance of the record above mentioned, of the number of times each engine has been lighted and cleaned.

To determine the average number of miles run by each engine after such cleaning and lighting, it is only necessary to divide the total mileage of the locomotive stock, or of each class of it, by the total number of engines lighted; the quotient will give the distance run by each engine lighted.

In the practical working of the locomotive stock, it inevitably happens that engines, after they have been lighted, had their steam raised and prepared for starting, have to stand, keeping their steam up more or less time, waiting for trains which they are to draw; and thus an expense is incurred, not directly productive, for fuel and wages.

30. But, besides this, the service of the road requires that, at certain stations, engines shall be kept waiting with their steam up ready for work, for the mere purpose of providing for the contingencies of the active service of the road. Thus, if an accident occur to a train, by which the engine that draws it is disabled, notice is sent forward by the electric telegraph, by signals or otherwise, to the next engine station, summoning an engine to proceed to the spot to take on the train. If an engine were not prepared for such a contingency, with its steam up, the road would be obstructed for a considerable length of time by the train thus accidentally brought to a stand.

The engines thus kept prepared for accidents are called *Reserve Engines*.

## THE LOCOMOTIVE.

31. Another cause which renders it necessary at certain points of the line to keep engines waiting with their steam up, is the existence of exceptional gradients.

Thus, if a railway be generally laid out with gradients of about 15 feet a mile, but at a particular point a natural elevation of the ground, or other cause, renders the construction of a gradient rising at the rate of 60 feet a mile necessary, then the engines which are adapted to the general character of the line become insufficient for such exceptional gradient; and, in such case, the expedient resorted to is to keep one or more powerful engines constantly waiting with their steam up at the foot of the incline, for the purpose of aiding in propelling the trains in their ascent.

These engines are denominated *Assistant Engines* or *Bank Engines*. Their mode of operation is as follows. They wait near the foot of the incline in a siding provided for the purpose; and when a train arrives and begins to ascend, the assistant engine follows it, and, pushing from behind, aids the regular engine in front in propelling it up the plane. When it arrives at the summit, the assistant engine drops off, and, descending the plane, returns to its station.

32. It appeared from calculations, based on the preceding principles, which I made some years since, that on the Belgian lines the average distance run by each engine lighted was 78 miles, and on some of the French lines 76 miles. It also appeared that each engine lighted was kept seven and a half hours standing with steam up, including, of course, the reserve engines. Thus, it follows, that for every ten miles over which an engine works, it is kept an hour standing.

33. The fuel consumed in working a railway may be classed under three heads:—

1st. That which is consumed in lighting the engines and raising their steam, to prepare them for work.

2nd. That which is consumed while the engines stand with their steam up, waiting for the trains they are intended to draw, or standing in reserve, prepared for the contingency of accidents on the line.

3rd. That which is consumed in drawing the trains.

When the engine has stopped work, its fire-box is cleared, preparatory to the engine being cleaned. A certain portion of coke, more or less, according to the state of the fire-box at the moment the engine is stopped, is collected in this way half consumed. This coke is to a certain extent available to aid in lighting the engine when next started. The small coke which has been rejected as unfit for the working engine is mixed, in a greater or less proportion, by the engineer with the large coke used for

## ECONOMY OF FUEL.

raising the steam, for in this process the draft is not so strong as to carry this small coke injuriously through the tubes. The small coke is also used, mixed in a certain proportion with the large coke, for keeping the steam up in the reserve engines.

The quantity of coke consumed in drawing a train will depend upon the magnitude and weight of the train, and the speed with which it is moved. The greater the resistance which it has to overcome, the greater will be the consumption of fuel in a given distance. The resistance increases in a high ratio with the speed. Now as the speed of passenger trains is usually greater than that of goods trains, the consumption of fuel, so far as it is affected by the speed, will be greater in the former than in the latter; but, on the other hand, goods trains consisting of a much greater number of vehicles and of a greater gross weight than passenger trains, the resistance due to the load is greater in the latter case than in the former.

On the Belgian railways the economy of fuel is very strictly attended to. Rules are established by which a certain weight of coke is allowed to the engineer for the different purposes.

For lighting and raising the steam, 280 kilogrammes, equal to 618 lbs., of coke are allowed.

For each passenger coach drawn,  $\frac{3}{4}$  of a kilogramme per kilometre, equal to 2.64 lbs. per mile, are allowed.

For each loaded goods waggon,  $\frac{2}{3}$  of a kilogramme per kilometre, equal to 2.35 lbs. per mile, are allowed.

Two empty waggons are accounted as equal to a loaded one, and  $2\frac{1}{2}$  kilogrammes per kilometre, equal to 8.82 lbs. per mile, are allowed for an engine without a load.

Ten kilogrammes, equal to 22 lbs., per hour are allowed for keeping up the steam while an engine is standing.

These quantities are, however, understood to be average major limits which ought not to be exceeded. To stimulate the engineers and their superintendents to the observance of a due economy of fuel, premiums are awarded, in proportion to the extent of the saving effected upon these allowances; 5s. 6d. a ton is allowed to the engineer for every ton of coke by which his actual consumption falls short of these limits, and a further premium of one-fourth of this amount is allowed to the superintendents of the locomotive department.

34. In the locomotive department, a register should be kept of the fuel consumed, distinguishing such consumption under the three heads of standing, lighting, and working, together with which should be noted the hours standing, the engines lighted, and the mileage worked. There is nothing impracticable or difficult in the maintenance of such a register in every well-organised establishment, and such a one is regularly kept in the

## THE LOCOMOTIVE.

administration of the Belgian railways. It appears from these records, that the following was the fuel consumed for these purposes respectively on the Belgian railways during the years 1846 and 1847:—

	1846.	1847.
Number of hours standing . . . . .	204124	214610
Number of lbs. of coke consumed in standing	4,503077	5,306573
Average number of lbs. consumed per hour .	22'0	24'7
Number of engines lighted . . . . .	27452	30676
Total number of lbs. consumed in lighting .	16,828505	18,605263
Average number of lbs. consumed per engine lighted . . . . .	613'0	606'5
Total mileage worked . . . . .	2,027014	2,366885
Total number of lbs. of coke consumed in working . . . . .	60,698538	71,500965
Average number of lbs. consumed per mile worked . . . . .	30'0	30'0
Average consumption per mile, including coke consumed in lighting and standing . . . . .	40'5	40'3

It may then be stated in round numbers, that 600 lbs. of fuel are consumed in lighting an engine, and raising the steam, and that every engine lighted travels, on an average, as worked upon the Belgian lines, 70 miles.

The fuel consumed in lighting adds, therefore,  $8\frac{1}{2}$  lbs. per mile to the working consumption, which latter being 30 lbs., the proportion consumed in lighting is 28 per cent. The fuel consumed in standing with steam up, either as an engine of reserve or otherwise, adds  $1\frac{1}{2}$  per cent. more to the working consumption per mile, the total amount of which may be taken in round numbers at 40 lbs., as these railways are worked.

35. One of the most striking results of the calculations which I have made of the performance of locomotive engines as well in England as on the continent, is the small amount of useful service obtained from them.

36. It appears that in each run an engine, on the Belgian lines, at the most improved epoch of the service yet reported, did not quite average 78 miles, and that even this was performed only four days in seven. Thus the average daily work of an engine would appear to be only 44 miles.

But it also appears, that for 74 miles run the engine is kept, on an average,  $7\frac{1}{2}$  hours standing. This being reduced to a daily average, leads to the conclusion, that the daily service of the engines consisted in 44 miles run and 4 hours standing with the steam up.

But as the average speed on the Belgian railway is about 20



## MILEAGE OF ENGINES.

miles an hour, the run of 44 miles would occupy more than two hours.

The daily service of an engine, therefore, expressed in time, would be about 2 hours working and 4 waiting with steam up.

37. These inferences are so striking, that we naturally turn elsewhere to inquire how far the results of other railways vary from or corroborate them.

I accordingly made like calculations upon the statistical reports of most of the continental railways, and found that the average daily mileage of the engines is under 33 miles, being therefore inferior to the useful service of the Belgian engines.

38. The data supplied by the English railways are so scanty, and in general so vague, as to afford no adequate means of general comparison with the results above given. In the case of the London and North-Western lines however, a more detailed account was published, which, considering the great extent and traffic of that system of railways, is entitled to much attention.

The traffic of these lines was worked, during the twelve months ending June 30, 1849, by 457 locomotive engines, the total mileage of which was as follows :—

	Mileage.
Passenger engines . . . . .	4,649,556
Goods engines . . . . .	2,882,674
	<hr style="width: 100%;"/>
Total . . . . .	7,532,230

Hence the average daily run of each engine was 45 miles.

These results, obtained from services so various and numerous, leave no doubt that the average daily service of each locomotive engine is much less than would have been expected. If the average speed on the North-Western lines be taken at 28 miles an hour, we shall obtain the singular and somewhat unexpected conclusion, that the engines, taken one with another, are each worked with traffic little more than one hour and a half a day.

By a return which I obtained from the North-Western Company, I found that, in the twelve months ending June 30, 1849, they had in active employment an average number of 275 engine-drivers, and an equal number of firemen. Now it has already been stated, that during the same period the number of engines employed was 457; there were thus 10 engine drivers and firemen for every 16 engines.

By dividing the total annual mileage of the engines by the total number of engine-drivers and firemen employed, we shall find the total annual distance driven by each; and dividing this by 365, we shall obtain the average daily work of each engine-driver and fireman, expressed in *distance*. This distance, divided by the

## THE LOCOMOTIVE.

average speed in miles per hour, will give the daily work on the road in time. The following are the details of this for the lines worked by the North-Western Company:—

Total mileage of engines . . . . .	7,532,230
Number of engine drivers and firemen . . . . .	275
Annual distance worked per head . . . . .	27,300 miles
Daily distance worked per head . . . . .	75 ,,
Time daily on the road (at the average speed of 28 miles per hour) . . . . .	2 $\frac{3}{4}$ hours

If it be assumed that the engines, one with another, work on alternate days, the actual distance run in each trip by each engine on the system of lines worked by the North-Western Company will be 90 miles; which in time, at 28 miles an hour, would be  $3\frac{3}{4}$  hours.

It appears, therefore, that the locomotive power is worked to greater advantage on these than on the continental lines generally. We have seen that the average distance run by each engine lighted on the Belgian lines was about 78 miles.

39. It has been customary, in some of the reports presented to the railway companies, to institute comparisons between one line of railway and another, founded upon the relation between the locomotive stock and the length of the line.

Now such a mode of comparison can afford no legitimate consequence of the least importance, either in a financial or mechanical point of view. The quantity of locomotive power does not in any manner depend on the length of the railway. The locomotive power is used to draw the traffic, and for no other purpose. Its quantity, therefore, will depend on the quantity of the traffic, and the average distance to which it is carried, or, in other words, on the mileage of the goods and passengers.

Two railways having the same traffic mileage will require the same locomotive stock, be their length equal or unequal. If a million of tons of goods require to be annually transported an average distance of 500 miles, and ten millions of passengers also require to be annually transported 300 miles, it is manifest, that the same locomotive power will be requisite to execute the traffic, whether the railway on which it is carried be 400 miles or 800 miles in length.

If the object be to compare the merits of the management of the locomotive power, then the test of comparison should be the quantity of work executed by a given quantity of this power; and the quantity of work must be decided by the useful mileage of the engines, and not by the length of the line.

Nevertheless, we find railway authorities in high repute announcing, that to stock a line requires so many engines per

mile. To such a statement there can be no objection, provided it be made with the understanding that it applies to railways only which have a certain understood amount of average traffic.

But it is clear that, with every variation of the traffic upon the proposed railway, there must be a corresponding and proportional variation in the necessary amount of locomotive stock.

40. A legitimate mode of comparing the merits of the management of the locomotive department will be found in the estimate of the average daily mileage of the engines.

It is evident, that if we find on one railway—for example, the North-Western,—the engines performing a daily mileage of 45 miles, while on another—the North of France, we find them performing a daily service under 30 miles, that the locomotive stock in the one case was more profitably managed than the other in the ratio of 2 to 3, it being understood that other things are similar. But even in this comparison it would be necessary that the length and weight of the trains should be taken into account; for if it prove that the weight of the train drawn 30 miles is greater than the weight of the train drawn 45 miles in the proportion of 3 to 2, then the useful labour of the engines will, after all, be the same. In short, the test, and the only test, of the useful effect of the locomotive power is the actual mileage (including in that term the quantity) of the traffic which it executes in a given time.

41. The conditions which determine the amount of the locomotive stock necessary to work any given railway form a very important subject of inquiry in railway economy; but it is a subject upon which we as yet possess but scanty and unsatisfactory data. As has been already stated, railway authorities have, with more rashness than skill, given a sort of rough estimate of it at so much per mile. This must, however, be regarded as utterly unworthy of attention, for the very intelligible reasons already explained.

The amount of locomotive stock depends exclusively on the mileage of the traffic. The question is thus reduced to the determination of the number of engines necessary to work a given mileage.

If we assume the results of the working of the North-Western lines as a general modulus, it would follow, that to find the quantity of stock necessary for working a given daily mileage, it will be sufficient to divide this mileage by 45; the quotient will express the requisite number of locomotive engines.

42. From calculations based upon authentic statistical returns which were published in a series of articles, written by me for the "Times," in 1851, it appeared, that in the year 1850, the gross receipts of all the European railways then in operation, amounted to 23,309000*l.*, of which 12,755000*l.*, or about the half, was collected on the railways of the United Kingdom.

## THE LOCOMOTIVE.

Of this amount about 60 per cent has been expended on personal locomotion, and 40 per cent on the transport of goods of every denomination.

43. The movement of the locomotive engines in executing this traffic has been as follows :—

	Miles run by engines.
United Kingdom . . . . .	40,162000
Germanic States . . . . .	23,572000
France . . . . .	10,041000
Belgium . . . . .	<u>4,540000</u>

Total distance travelled by locomotive engines  
in 1850 . . . . . 78,315000

44. Since the date of these calculations, the amount of railway locomotion, as well in the United Kingdom as throughout Europe generally, has undergone a great increase. Thus, in the half year ending 30th June, 1852, the gross receipts of the railways in the United Kingdom amounted to 7,195551*l*.

The mileage, or aggregate distance travelled by the locomotive engine, has increased in a proportion still greater than the increase of the gross receipts. Thus, while in 1850, the total annual mileage of the engines on the railways of the United Kingdom was about forty millions, in the first six months of 1852 it was twenty-eight and a half millions, being at the rate of fifty-seven millions in the year.

It may now (1854) be assumed that the aggregate annual mileage of the locomotive engines on all the European railways is not less than *an hundred and twenty millions of miles* !

45. In the performance of this work, the total quantity of coal consumed is two millions and three quarters of tons.

46. This movement is shared between passengers and goods as follows :—

Distance travelled by passenger trains . . .	72,000000
„ „ goods „ . . .	48,000000

Since each passenger train transported on an average 70 passengers, and each goods train 60 tons, it follows that the total locomotion of persons within the year was equivalent to 5040,000000 persons carried one mile, and the transport of goods to 2880,000000 tons transported one mile.

The number of locomotive engines employed in executing this movement was about 7500, of which 3700 were employed on the British railways, and about 5000 were constructed in England.

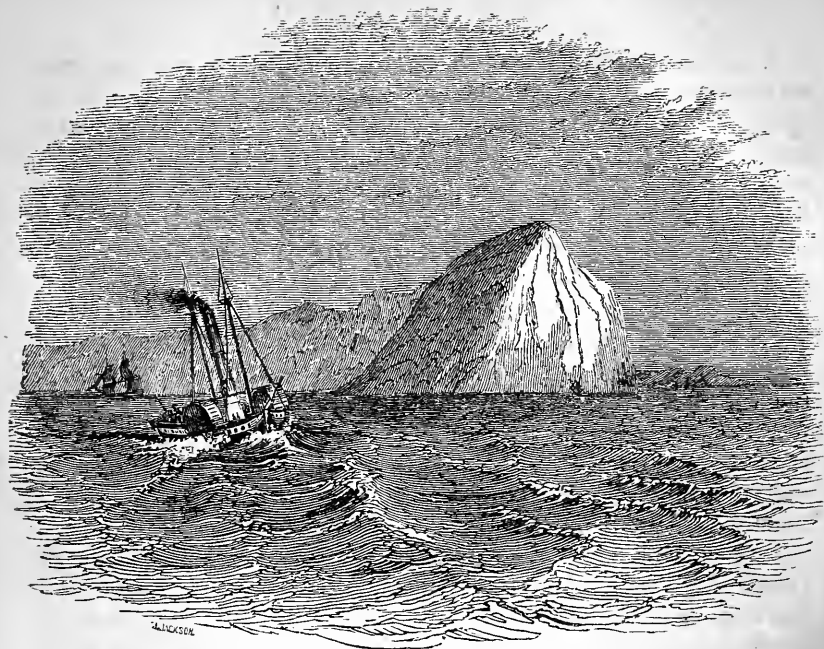

## STEAM NAVIGATION.

### CHAPTER I.

1. Inventors of steam navigation uneducated.—2. First steamers on the Hudson and the Clyde.—3. Sea-going steamers due to British engineers.—4. Progress of steam navigation from 1812 to 1837.—5. Atlantic steamers projected.—6. Abstract possibility of the voyage could not be doubted.—7. The voyage had been already made by two steamers.—8. Projects advanced in 1836.—9. Discussion at Bristol in 1837.—10. Report of Dr. Lardner's speech in the *Times* of 27th August, showing the falsehood of the report that he pronounced the project impracticable.—11. Atlantic steam voyage advocated by Dr. Lardner in 1836-7.—12. The practical results of the various projects prove the truth of his predictions.—13. The Cunard steamers, established on the conditions suggested by him, were alone successful.—14. Voyages of these steamers.—15. Other lines established.—16. Probable extension of steam navigation to the general purposes of commerce.—17. Auxiliary steam-power the most probable means of accomplishing this.—18. Advantages of subaqueous propulsion.—19. Means of realising them.—20. Improved adaptation of steam-power to vessels of war required.—21. Mercantile steam-marine available for national defence.—22. Principle of marine-engine.—23. Propellers.—24. Paddle-wheels and screws.—25. Arrangement of paddle-wheels.—26. Paddle-shaft.—27. General arrangement of marine-engine.

## STEAM NAVIGATION.

1. IF the spirits of Watt, Trevithick, and Fulton can look down on the things of this nether world, and behold the grand results their discoveries and inventions have produced, what triumph must be theirs! For half a century the steam-engine had remained a barren fact in the archives of science, when the self-taught genius of the Glasgow mechanic breathed into it the spirit of vitality, and conferred upon it energies by which it revived the drooping commerce of his country, and, when the auspicious epoch of general peace arrived, diffused its beneficial influence to the very skirts of civilisation. Scarcely had the fruit of the labour of Watt ripened, and this great mover been adopted as the principal power in the arts and manufactures, than its uses received that prodigious extension which resulted from its acquiring the LOCOMOTIVE character. As it had previously displaced animal power in the MILL, and usurped its nomenclature, so it now menaced its displacement on the ROAD. A few years more witnessed perhaps the greatest and most important of all the manifold agencies of steam—that by which it has given wings to the ship, and bade it laugh to scorn the opposing elements, transporting it in triumph over the expanse of the trackless ocean, regardless of wind or current, and conferring upon locomotion over the deep a regularity, certainty, and precision, surpassed by nothing save the movement of chronometers or the course of the heavenly bodies. Such are the vast results which have sprung from the intelligence of men, none of whom shared those privileges of mental culture enjoyed by the favoured sons of wealth; none of whom grew up within the walls of schools or colleges, drawing inspiration from the fountains of ancient learning; none of whom were spurred on by those irresistible incentives to genius arising from the competition of ardent and youthful minds, and from the prospect of scholastic honours and professional advancement. Sustained by that innate consciousness of power, stimulated by that irrepressible force of will, so eminently characteristic of, and inseparable from, minds of the first order, they, in their humble and obscure positions persevered against adverse and embarrassing circumstances, impelled by the faith that was in them, against the doubts, the opposition, and, not unfrequently, the ridicule of an incredulous world, until at length, by time and patience, truth was triumphant, and mankind now gathers the rich harvest sown by these illustrious labourers.

2. It was about the eighth year of the present century that Fulton launched the first steamboat on the Hudson. After the lapse of four years the first European steamboat was established on the Clyde. From that time the art of steam-navigation, in the two great maritime and commercial nations, advanced with a

steady and rapid progress. But it took different directions, governed by the peculiar geographical and commercial circumstances attending these countries. The genius and enterprise of the United States saw before and around it a vast territory, intersected by navigable rivers of unequalled length, forming lines of water communication on a colossal scale between its extensive interior and the sea-board. The Mississippi and its tributaries, with their sources, lost in distant tracts as yet untrodden by civilised man, and navigable by large vessels for many thousands of miles,—the Hudson, all but touching upon those magnificent inland seas that stretch along the northern boundary, and are almost connected with the Mississippi by the noble stream of the Illinois,—the Delaware, the vast Potomac, and, in fine, a coast thousands of miles in extent, fringed by innumerable bays and harbours, and land-locked basins having all the attributes of lakes,—these addressed themselves to the eye of the engineer and the capitalist, and determined the direction of enterprise. The application of steam power to inland navigation—the construction of vessels suited to traverse with speed, safety, and economy, rivers and lakes, harbours, bays, and extensive inlets—this was the task and the vocation of the American engineer, and this the interest of the capitalist and the merchant.\*

3. The problem of steam-navigation, however, presented itself to the British engineer under other conditions. In a group of islands intersected by no considerable navigable rivers, and neither requiring nor admitting any inland navigation save that of artificial canals,—separated, however, from each other and from the adjacent continent of Europe by straits, channels, gulfs, and other arms of the sea,—it was apparent that if steam power should become available at all, it must be adapted to the navigation of these seas and channels—it must be adapted to accelerate and cheapen the intercourse between the British islands, between port and port upon their coasts, between them and the various ports on the adjacent coast of Europe, and finally to establish a communication with the Mediterranean and the coasts of Africa, Asia, and Europe, which are washed by it. While the American, therefore, was called on to contrive a steam-vessel adapted to inland and smooth-water navigation, the British engineer had the more difficult task, to construct one which should be capable of meeting and surmounting all the obstructions arising from the vicissitudes of the deep.

The result of the labour and enterprise of the English nation, directed to this inquiry, has been the present sea-going steam-ship.

\* For a more developed notice of American Steam Navigation, see *Railway Economy*, chap. xvi., and *Museum*, vol. ii. p. 17.

4. In the quarter of a century which elapsed between 1812 and 1837 steam-navigation made a steady and continuous, but not a sudden progress. The first lines of steamers were established naturally between the ports of England and the nearest sea-ports of Ireland on the one side, and France on the other. The length of each unbroken passage was then regarded as the great difficulty of the project. Thus steamers were established between Holyhead and Dublin, and between Dover and Calais, long before projectors ventured to try them between Dublin and Liverpool, or between London and the Low Countries.

After some years' experience, however, and the consequent improvement of the marine engine, passages of greater length were attempted with success. Lines of steamers were established first between more distant parts of the United Kingdom; as, for example, between London and Edinburgh, and between Dublin, Liverpool, and Glasgow. At a later period still longer trips became practicable, and lines of steamers were established between the United Kingdom and the Mediterranean; touching, however, for fuel at the peninsular ports, such as Corunna, Lisbon, and Gibraltar.

During this period, also, a fleet of steamers was constructed by government for post-office purposes, and a steam navy was gradually created, among which were found ships of large tonnage and considerable power.

5. At length, in the year 1836, a project, then considered as a startling one, was first announced, to supersede the far-famed New York and Liverpool packet-ships, by a magnificent establishment of STEAM-SHIPS.

These vessels were to sustain a constant, regular, and rapid communication between the New and Old World. They were to be the great channel for commerce, intelligence, and social intercourse, between the metropolis of the West and the vast marts of the United Kingdom; they were, in a word, to fulfil, not only all the functions which for half a century had been so admirably discharged by the packet-ships, but to do so with expedition increased in a threefold proportion at the least. Such an announcement could not fail to captivate the public. The results to be anticipated were so obvious, so grand, and must be attended with effects so widely spread, that all persons of every civilised nation at once felt and acknowledged their importance. The announcement of the project was accordingly hailed with one general shout of acclamation.

Some, who, being conversant with the actual condition of the art of steam-engineering as applied to navigation, and aware of various commercial conditions which must affect the problem, and



## TRANSATLANTIC STEAMERS.

were enabled to estimate calmly and dispassionately the difficulties and drawbacks, as well as the advantages, of the undertaking, entertained doubts which clouded the brightness of their hopes, and warned the commercial world against the indulgence of too sanguine anticipations, of the immediate and unqualified realisation of the project. They counselled caution and reserve against an improvident investment of extensive capital, in schemes which could still be only regarded as experimental, and which might prove its grave. But the voice of remonstrance was drowned amid the enthusiasm excited, by the promise of an immediate practical realisation of a scheme so grand. The keel of the Great Western was laid; an assurance was given that the seasons would not twice run through their changes, before she would be followed by a splendid line of vessels, which should consign the packet-ships to the care of the historian as "things that were."

6. It cannot be seriously imagined, that any one who had been conversant with the past history of steam-navigation, could entertain the least doubt of the abstract practicability of a steam-vessel making the voyage between Bristol and New York.

A vessel having as her cargo a couple of hundred tons of coals would, *cæteris paribus*, be as capable of crossing the Atlantic as a vessel transporting the same weight of any other cargo. A steam-vessel of the usual form and construction would, it is true, labour under comparative disadvantages, owing to obstructions presented by her paddle-wheels and paddle-boxes; but still it would have been preposterous to suppose that these impediments could have rendered her passage to New York impracticable.

7. But, independently of these considerations, it was a well-known fact, that, long antecedent to the epoch now adverted to, the Atlantic had actually been crossed by the steamers Savannah and Curaçoa. Nevertheless a statement was not only widely circulated, but generally credited, that I had publicly asserted that a steam voyage across the Atlantic was "*a physical impossibility!*"

Although this erroneous statement has been again and again publicly contradicted through various organs of the press, it continues nevertheless to be repeated. I shall therefore take this opportunity once more to put on record, what I really did state on the occasion, on which I am reported to have affirmed that the Atlantic steam voyage was a physical impossibility.

8. Projects had been started in the year 1836 by two different and opposing interests, one advocating the establishment of a line of steamers to ply between the west coast of Ireland and Boston, touching at Halifax; and the other a direct line, making an uninterrupted trip between Bristol and New York. In the year

1836, on the occasion of the meeting of the British Association in Dublin, I had advocated the former of these projects.

9. On the occasion of the next meeting in 1837 at Bristol, I again urged its advantages, and by comparison discouraged the project of a direct line between Bristol and New York. When I say that I advocated one of these projects, it is needless to add that the popular rumour, that I had pronounced the Atlantic voyage impracticable, is utterly destitute of foundation. But I am enabled to offer more conclusive proofs than this, that, so far from asserting that the Atlantic voyage by steam was impossible, *I distinctly affirmed the contrary.*

The *Times* newspaper sent a special reporter to attend the meeting at Bristol, and more particularly to transmit a report of the expected discussion on the Atlantic steam voyage, which at the moment excited much interest.

10. The meeting took place on the 25th, and the report appeared in the *Times* of the 27th of August. From that report I extract the following ;—

“Dr. Lardner said he would beg of any one, and more especially of those who had a direct interest in the inquiry, to dismiss from their minds all previously-formed judgments about it, *and more especially upon this question, to be guarded against the conclusions of mere theory,* for if ever there was one point in practice of a commercial nature which, more than another, required to be founded on experience, it was this one of extending steam-navigation to voyages of extraordinary length. He was aware that since the question had arisen, it had been stated that his own opinion was averse to it. *This statement was totally wrong,* but he did feel that great caution should be used in the adoption of the means of carrying the project into effect. Almost all depended on the first attempt, for a failure would much retard the ultimate consummation of the project.

“Mr. Scott Russell said that he had listened with great delight to the lucid and logical observations they had just heard. He would add one word, Let them try this experiment, with a view only to the enterprise itself, but on no account try any new boiler or other experiment, but to have a combination of the most approved plans that had yet been adopted.

“After some observations from Messrs. Brunel and Field, Dr. Lardner, in reply, said, that *he considered the voyage practicable,* but he wished to point out that which would *remove the possibility of a doubt,* because if the first attempt failed it would cast a damp upon the enterprise, and prevent a repetition of the attempt.”

## MISREPRESENTATION OF DR. LARDNER'S VIEWS.

Such was the report of the *Times* of the speech in which I was afterwards, and have ever since been, represented as having declared a steam voyage across the Atlantic a *mechanical impossibility!* \*

11. What I did affirm and maintain in 1836-7 was, that the long sea voyages by steam which were contemplated, could not at that time be maintained with that regularity and certainty which are indispensable to commercial success, by any revenue which could be expected from traffic alone, and that, without a government subsidy of a considerable amount, such lines of steamers, although they might be started, could not be permanently maintained.

12. Now let us see what has been the practical result. Eight steam-ships, including the Great Western, were, soon after the epoch of these debates, placed upon the projected line between England and New York; the Sirius, the Royal William, the Great Liverpool, the United States,† the British Queen, the President, the Great Western, and the Great Britain.

The Sirius was almost immediately withdrawn; the Royal William, after a couple of voyages, shared the same fate; the Great Liverpool, in a single season, involved her proprietors in a loss of 6000*l.*, and they were glad to remove her to the Mediterranean station. The proprietors of the British Queen, after sustaining a loss which is estimated at little less than 100000*l.*, sold that ship to the Belgian government. The United States was soon transferred, like the Great Liverpool, to the Mediterranean trade. The President was lost. The Great Western, as is well known, after continuing for some time to make the voyage in the summer months, being laid by during the winter, and after involving her proprietors in a loss of unknown and unacknowledged amount, was sold. Of the Great Britain, the fate is well known.

Thus, it appears, in fine, that after the lapse of nearly fourteen years, notwithstanding the great improvements which took place in steam navigation, the project advanced at Bristol, and there pronounced by me to be commercially impracticable, signally failed.

13. Meanwhile another project, based upon the conditions which I had indicated as essential to the permanence and success of the enterprise, was started.

Mr. Samuel Cunard, a Canadian, who had extensive experience

\* Notices of this speech, substantially the same, appeared in the *Edinburgh Review*, the *Monthly Chronicle*, and other periodicals of that date.

† This vessel was not actually placed on the line, but was prepared for it. She was afterwards called the *Oriental*.

## STEAM NAVIGATION.

in maritime affairs, being associated with some large capitalists who had confidence in his sagacity and skill, laid before the British government a project for a line of Post-office steamers, to ply between Liverpool and Boston, touching at Halifax. But Mr. Cunard insisted strongly on the necessity of providing a considerable fleet of steamers, to ensure that permanence and regularity which were indispensable to the success of the project. He demonstrated that the magnitude of the capital it must involve, and the vast expenditure attending its maintenance, were such as could not be covered by any commercial returns to be expected from it, and that, consequently, it could only be sustained by a liberal subsidy to be furnished by the government. After much negotiation, it was agreed to grant him an annual subsidy of 60000*l.*, upon which condition the enterprise was commenced. Mr. Cunard, however, had hardly embarked in it, before it became evident that this grant was insufficient, and it was soon increased to 100000*l.* per annum. Further experience proved that even this was insufficient to enable Cunard and his associates to maintain the communication in a satisfactory and efficient manner, and the annual subvention was in fine raised to its present amount, that is to say, 145000*l.* sterling per annum.

14. Thus supported, the communication was in 1851 maintained throughout the year. During the four winter months, December, January, February, and March, there were two departures per month from each side, and during the eight other months of the year there was a departure once a week, making a total of forty-four departures from each side, or forty-four voyages going and returning.

These voyages make a total distance sailed of 272800 geographical miles within the year. The subsidy, therefore, amounts to ten shillings and eightpence per mile sailed.

Since the epoch here referred to, steam-navigation has, as is well known, undergone great improvements, and its powers have been proportionally extended. The arrangements of this and other lines of ocean navigation have accordingly undergone, and continue to undergo, modifications having the effect of increasing the frequency and extending the lengths of the trips.

15. Soon after the Cunard line of steamers commenced operations, it was proposed to establish, with government support, a transatlantic line of steamers communicating between Great Britain and its West India colonies. Ultimately the present West India Steam-Packet Company was established, and obtained from the government a subvention greater still in amount than had been granted to the Cunard Company. The amount of this annual grant was 240000*l.*

16. Great as the progress of steam-navigation has been within the last quarter of a century, much still remains to be accomplished, before that vast agent of transport can be regarded as having been pushed to the limit of its powers. Its superior speed, regularity, and certainty, comparatively with sailing-vessels, have naturally first attracted to it passengers, despatches, and certain descriptions of merchandise to which expedition is important, and which can bear a high rate of freight. The mechanical conditions which ensure expedition in long voyages, exclude, to a great extent, the transport of general merchandise; for a large part of the tonnage of the vessel is occupied by the machinery and fuel. The heavy expenses, therefore, of the construction and maintenance of these vessels, must be defrayed by appropriating the profitable tonnage to those objects of transport alone which will bring the highest rate of freight. While the steamer, therefore, has allured from the sailing-vessel the chief part of the passenger traffic, the mails altogether, parcels, and some few objects of general traffic, the latter still continues in undisturbed possession of the transport business of general commerce.

The next step in the improvement of the art must therefore be directed to the construction of another class of steam-vessels, which shall bear to the present steam-ships the same relation which the goods-trains, on the railway, bear to the passenger-trains. As in the case of these goods-trains, expedition must be sacrificed to reduce the cost of transport to the limit which shall enable the merchandise to bear the freight. If the steamer for the general purposes of commerce can be made to exceed the sailing-vessel, in anything approaching to the ratio by which the goods-train on the railway exceeds the waggon or canal-boat, we shall soon see the ocean covered with such steamers, and the sailing-vessel will pass from the hands of the merchant to those of the historian.

17. To render steamers capable of attaining these ends, it will be evidently advisable to adopt measures, to combine the qualities of a sailing-vessel with those of a steamer. The ships must possess such steaming power as may give them that increased expedition, regularity, and punctuality, which, in the existing state of the arts, can only be obtained through that agency; but it is also important that they should accomplish this without robbing them, to any injurious extent, of their present capability of satisfying the wants of commerce.

18. In an early edition of my treatise on the Steam-Engine, published long before screw steam-vessels had attained the state of perfection to which they have now arrived, I stated that no expedient was more likely to accomplish this, than one which would

have for its object the removal of the paddle-wheels now generally used, and the substitution of some description of subaqueous propeller. A great reduction in the dimensions of the machinery, and the surrender to the uses of commerce of that invaluable space which it now occupies within the vessel, are also essential. It is incumbent on the engineer who assumes the high responsibility of the superintendence of such a project, to leave the ship in the full and unimpaired enjoyment of its functions as a sailing-vessel. Let him combine, in short, the agency of steam with the undiminished nautical power of the ship. Let him celebrate the marriage of the steam-engine with the sailing-vessel. If he accomplish this with the skill and success of which the project is susceptible, he may fairly hope that his name will go down to posterity as a benefactor of mankind, united with those of Fulton and Watt.

The actual progress of mechanical science encourages us to hope, that the day is fast approaching when such ideas will be realised—when we shall behold a great highway cut across the wide Atlantic, not as now, subserving to those limited ends, the attainment of which will bear a high expense, but answering all the vast and varied demands of general commerce. Ships which would serve the purposes we have here shadowed out, can never compete in mere speed with vessels in which cargo is nothing, expense disregarded, and expedition everything. Be it so. Leave to such vessels their proper functions; let them still enjoy to some extent the monopoly of the most costly branches of traffic, subsidised as they are by the British treasury. Let the commercial steam-ships, securing equal regularity and punctuality, and probably more frequent despatch, be content with somewhat less expedition. This is consistent with all the analogies of commerce.

There is another consideration which ought not to be omitted. In all great advances in the arts of life, extensive improvements are at first attended with individual loss of greater or less amount. The displacement of capital is almost inevitably attended with this disadvantage. It is the duty, therefore, of the scientific engineer, in the arrangement and adoption of his measures, to consider how these objects may be best attained with the least possible injury to existing interests. To accomplish this will not only be a benefit to the public, but will materially facilitate the realisation of his own objects, by conciliating in their favour those large and powerful interests, whose destruction would be otherwise menaced by them. If, then, in the present case, it is found practicable with advantage to introduce into the present sailing-ships, more especially into those most recently constructed, the

agency of steam, a very important advantage will be gained for the public, and the almost unanimous support and countenance of the commercial community will be secured.

19. To attain the objects here developed, it will be evidently indispensable to remove those impediments, which at once disfigure the appearance and destroy the efficiency of the sailing qualities of the ship, by the enormous and unsightly excrescences projecting from the sides in the shape of paddle-wheels, and the wheel-houses or paddle-boxes, as they are called. These appendages are attended with many evils, the least of which is perhaps the impediment which they present to the progress of the ship.

But the form, magnitude, and position of the propelling machinery, is far from being the only obstacle to the full success of the present steam-vessels, when directed to the general purposes of commerce. The engines themselves, and the boilers, from which the moving power proceeds, and the fuel by which they are worked, occupy the very centre of the vessel, and engross the most valuable part of the tonnage. The chimney, which gives efficacy to the furnaces, is also an unsightly excrescence, and no inconsiderable obstruction.

When long ocean-voyages are contemplated, such as those between New York and the ports of England, there is another serious obstacle, which is especially felt in the westward trip, because of the prevalence of adverse winds. When the vessel starts on its long voyage, it is necessarily laden with a large stock of fuel, which is calculated to meet, not merely the average exigencies of the voyage, but the utmost extremity of adverse circumstances of wind and weather to which it can by possibility be exposed. This fuel is gradually consumed upon the voyage; the vessel is proportionally lightened, and its immersion diminished. If its trim be so regulated that the immersion of its wheels at starting be such as to give them complete efficiency, they may, before the end of the voyage, be almost if not altogether raised out of the water. If, on the other hand, the efficiency of propulsion in the latter part of the voyage be aimed at, they must have such a depth at its commencement as to impair in a serious degree their propelling effect, and to rob the vessel of its proper speed. Under such circumstances, there is no expedient left but compromise. The vessel must start with too great and arrive with too little immersion. There is no alternative, save to abandon altogether the form and structure of the present machinery, and to awaken the inventive genius of the age to supply other mechanical expedients, which shall not be obnoxious to these objections.

In fine, then, we look to the improvement of auxiliary steam power, and the extended use of submerged propellers, as the means

which, in the existing state of the art of steam-navigation, are most likely to extend the benefits of that agent of transport to general commerce.

20. If the form and structure of paddle-wheel steam-vessels be obnoxious to these many serious objections, when considered with reference to the purposes of general commerce, they are still more objectionable when considered with reference to the purposes of national defence. It is undoubtedly a great power with which to invest a vessel of war, to be able to proceed at will, in spite of the opposition of wind or tide, in any direction which may seem most fit to its commander. Such a power would have surpassed the wildest dreams of the most romantic and imaginative naval commander of the last century. To confer upon the vessels of a fleet the power immediately, at the bidding of the commander, to take any position that may be assigned to them relatively to the enemy, or to run in and out of a hostile port at pleasure, or fly with the rapidity of the wind past the guns of formidable forts, before giving them time to take effect upon them—are capabilities which must totally revolutionise all the established principles of naval tactics. But these powers at present are not conferred upon steam-ships, without important qualifications and serious drawbacks. The instruments and machinery from which they are immediately derived are, unfortunately, exposed in such a manner as to render the exercise of the powers themselves hazardous in the extreme. It needs no profound engineering knowledge to perceive that the paddle-wheels are eminently exposed to shot, which, taking effect, would altogether disable the vessel, and leave her at the mercy of the enemy; and the chimney is even more exposed, the destruction of which would render the vessel a prey to the enemy within itself in the shape of fire. But besides these most obvious sources of exposure in vessels of the present form intended as a national defence, the engines and boilers themselves, being more or less above the water line, are exposed so as to be liable to be disabled by shot.

A war steamer, to be free from these objections, should be propelled by subaqueous apparatus. Her engines, boilers, and all other parts of her machinery should be below the water-line. Her fuel should be hard coal, burning without visible smoke, so that her approach may not be discoverable from a distance. Her furnaces might be worked by blowers, so that the chimney might be dispensed with, and thus its liability to be carried away by shot removed.

21. The policy of the British government has been to rely on the commercial steam navy as a means of national defence, in the event of the sudden outbreak of war. By the evidence given



before a committee of the House of Commons in 1850, and the report founded thereupon, it appeared that commercial steamers in general are capable of war service, with no other previous alteration or preparation than such as are easily practicable and expeditiously executed. It was shown that all steamers of 400 tons and upwards would be capable, with some additional strengthening, to carry such pivot guns as are used in war-steamers, and that there are few mercantile steamers of any size, which might not carry an armament such as would render them useful in case of an emergency.

22. The principle on which the steam-engine is applied to the propulsion of ships is the same as that by which oars act in propelling boats. In both cases the propelling instruments having a point or points of reaction on the vessel, are made to drive a mass of water backwards, and the moving force, or momentum, thus imparted to the water from stem to stern, is necessarily attended with a reaction from stern to stem, which, taking effect on the vessel, gives it a corresponding progressive motion.

By the well-known mechanical principle of the composition and resolution of force, it can be demonstrated that whatever force may be imparted to the water by the propeller, such force can be resolved into two elements, one of which is parallel, and the other in a plane at right angles to the keel. The former alone can have a propelling effect, and since the latter is wholly ineffective, the propeller should always be so constructed that its whole force, or at least the chief part of it, shall be employed in driving the water in a direction parallel to the keel from stem to stern.

23. The mechanical expedients by which the power of steam is rendered available for the propulsion of vessels are very various, both as regards the form of the engine which acts upon the propeller, and the form of the propeller itself.

In all cases hitherto reduced to practice, the propeller is a wheel fixed upon a horizontal shaft, to which the engine imparts a motion of continued rotation. The wheel is so constructed that when it revolves it imparts to a volume of water, more or less considerable, a motion either directly backwards, or one whose principal component has that direction. The greater the proportion which this principal component has to the entire force exercised by the propeller, the more effective it will be.

24. The propellers hitherto practically applied in steam-navigation are of two kinds, called *paddle-wheels* and *screws*.

The shaft of the paddle-wheels is fixed horizontally across the vessel, and consequently at right angles to the direction of the keel.

## STEAM NAVIGATION.

The shaft of the screws is placed horizontally in the vessel parallel to the keel, and directly above it.

The faces of the paddle-wheels look sideways and are consequently parallel to the keel.

The faces of the screws look sternwards, and are consequently at right angles to the keel.

25. The paddle-wheels are in pairs one at each side of the vessel and outside the hull, being supported on the projecting ends of the paddle-shaft, and covered by large semi-cylindrical drums called *paddle-boxes*.

The screws are generally single wheels, within the vessel under its hull, and placed near the stern.

Only the lower parts of the paddle-wheels are immersed. The screws are altogether submerged.

26. The paddle-shaft being carried on each side beyond the timbers of the vessel, the wheels supported by it and revolving with it, are usually constructed like undershot water-wheels, having attached to their rims a number of flat boards called *paddle-boards*. As the wheels revolve, these paddle-boards strike the water, driving it in a direction contrary to that in which it is intended the vessel should be propelled. On the paddle-shaft two cranks are constructed, similar to the crank on the axle of the fly-wheel of a stationary engine. These cranks are generally placed at right angles to each other, so that when either is in its highest or lowest position the other shall be horizontal. They are driven by two steam-engines, which are usually placed in the hull of the vessel below the paddle-shaft. In the earlier steam-boats a single steam-engine was used, and in that case the unequal action of the engine on the crank was equalised by a fly-wheel. This, however, has been long since abandoned in European vessels, and the use of two engines is now almost universal. By the relative position of the cranks it will be seen, that when either crank is at its dead point the other will be in one of the positions most favourable to its action, and in all intermediate positions, the relative efficiency of the cranks will be such as to render their combined action very nearly uniform.

The steam-engines used to impel vessels may be either condensing engines, similar to those of Watt, and such as are used in manufactures generally, or they may be non-condensing and high-pressure engines, similar in principle to those used on railways. Low-pressure condensing engines are, however, universally used for marine purposes in Europe, and to a great extent in the United States. In the latter country, however, high-pressure engines are also used in some of the river steamers.

27. The arrangement of the parts of a marine engine differs in

## MARINE ENGINES.

some respects from that of a land engine. The limitation of space, which is unavoidable in a vessel, renders greater compactness necessary. The paddle-shaft on which the cranks to be driven by the engine are constructed being very little below the deck of the vessel, the beam, if there be one, and connecting rod could not be placed in the position in which they usually are in land engines, without carrying the machinery to a considerable elevation above the deck. This is done in the steam-boat engines used on the American rivers; but it would be inadmissible in steam-boats in general, and more especially in sea-going steamers. The connecting rods, therefore, instead of being presented downwards towards the cranks which they drive, must, in steam-vessels, be presented upwards, and the impelling force be received from below. If, under these circumstances, the beam were in the usual position above the cylinder and piston-rod, it must necessarily be placed between the engine and the paddle-shaft. This would require a depth for the machinery which would be incompatible with the magnitude of the vessel. The beam, therefore, of marine engines, instead of being above the cylinder and piston, is placed below them. To the top of the piston rods, cross-pieces are attached, of greater length than the diameter of the cylinders, so that their extremities shall project beyond the cylinders. To the ends of these cross-pieces are attached by joints the rods of a parallel motion: these rods are carried downwards, and are connected with the ends of two beams below the cylinder, and placed on either side of it. The opposite ends of these beams are connected by another cross-piece, to which is attached a connecting rod, which is continued upwards to the crank-pin, to which it is attached, and which it drives. Thus the beam, parallel motion, and connecting rod of a marine engine, are similar to those of a land engine, only that they are turned upside down; and in consequence of the impossibility of placing the beam directly over the piston rod, two beams and two systems of parallel motion are provided, one on each side of the engine, acted upon by, and acting on the piston rod and crank by cross-pieces.\*

The proportion of the cylinders differs from that usually observed in land engines for like reasons. The length of the cylinder of land engines is generally greater than its diameter, in the proportion of about two to one. The cylinders of marine engines are, however, commonly constructed with a diameter greater than their length. In proportion, therefore, to their power their stroke is shorter, which infers a corresponding short-

\* We must assume that the reader of the present Tract has already rendered himself familiar with the several Tracts on Steam and the Steam Engine, already published in the Museum.

ness of crank and a greater limitation of play of all the moving parts in the vertical direction. The valves and the gearing by which they are worked, the air-pump, the condenser and other parts of the marine engines, do not differ in principle from those already described in land engines.

These arrangements will be more clearly understood by reference to fig. 1, in which is represented a longitudinal section of one of the many varieties of beam engine, with its boiler as placed in a steam-vessel. The sleepers of oak, supporting the engine, are represented at *x*, the base of the engine being secured to these by bolts passing through them and the bottom timbers of the vessel; *s* is the steam-pipe leading from the steam-chest in the boiler to the slides *c*, by which it is admitted to the top and bottom of the cylinder. The condenser is represented at *B*, and the air-pump at *E*. The hot well is seen at *F*, from which the feed is taken for the boiler; *L* is the piston-rod connected by the parallel motion *a*, with the beam *H*, working on a centre *K*, near the base of the engine. The other end of the beam *I* drives the connecting rod *M*, which extends upwards to the crank, which it works upon the paddle-shaft *O*. *Q R* is the framing by which the engine is supported. The beam here exhibited is shown on dotted lines as being on the further side of the engine. A similar beam similarly placed, and moving on the same axis, must be understood to be at this side connected with the cross-head of the piston in like manner by a parallel motion, and with a cross-piece attached to the lower end of the connecting rod and to the opposite beam. The eccentric which works the slides is placed upon the paddle-shaft *O*, and the connecting arm which drives the slides may be easily detached when the engine requires to be stopped. The section of the boiler, grate, and flues is represented at *w v*. The safety-valve *y* is enclosed beneath a pipe carried up beside the chimney, and is inaccessible to the engine man; *h* are the cocks for blowing the salted water from the boiler, and *r r* the feed-pipe.

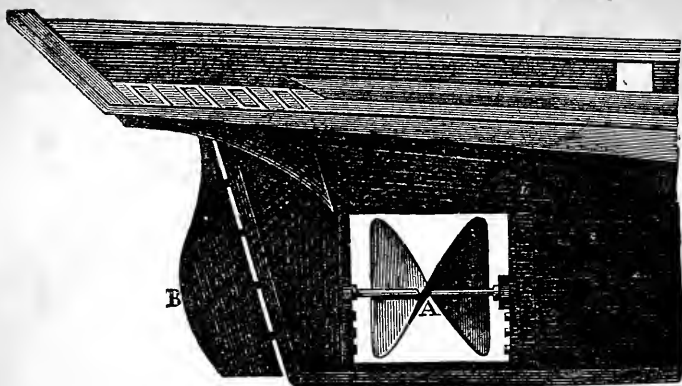

Fig. 2.—FORM AND POSITION OF THE SCREW.

## STEAM NAVIGATION.

### CHAPTER II.

28. Arrangement of the engine-room ; governor and other regulating parts omitted.—29. Flue boilers and tubular boilers.—30. Construction of flue boilers.—31. Tubular boilers.—32. Indications of engineering ignorance.—33. Number and dimensions of tubes.—34. Incrustation produced by sea water.—35. Hydrometric indicators.—37. Thermometric indicators.—38. Seaward's contrivance.—39. Brine-pumps.—40. Blowing out.—41. To detach the scale.—42. Effect of corrosion.—43. Efficiency and economy of fuel.—44. Coating the boiler and pipes with felt.

28. The general arrangement of the engine-room of a steam-vessel is represented in fig. 3, page 131.

The nature of the effect required to be produced by marine engines, does not render either necessary or possible that great regularity of action, which is indispensable in a steam-engine applied to the purposes of manufacture. The agitation of the surface of the sea will cause the immersion of the paddle-wheels to be subject to great variation, and the resistance produced by the water to the engine will undergo a corresponding change. The governor, therefore, and other parts of the apparatus, contrived for giving to the engine that great regularity required in manufactures, are omitted in nautical engines, and nothing is introduced save what is necessary to maintain the machine in its full working efficiency.

Marine boilers are constructed in forms so infinitely various, that, in a notice so brief and popular as the present, we can only indicate some of their more general arrangements, and aid the

Fig. 1.

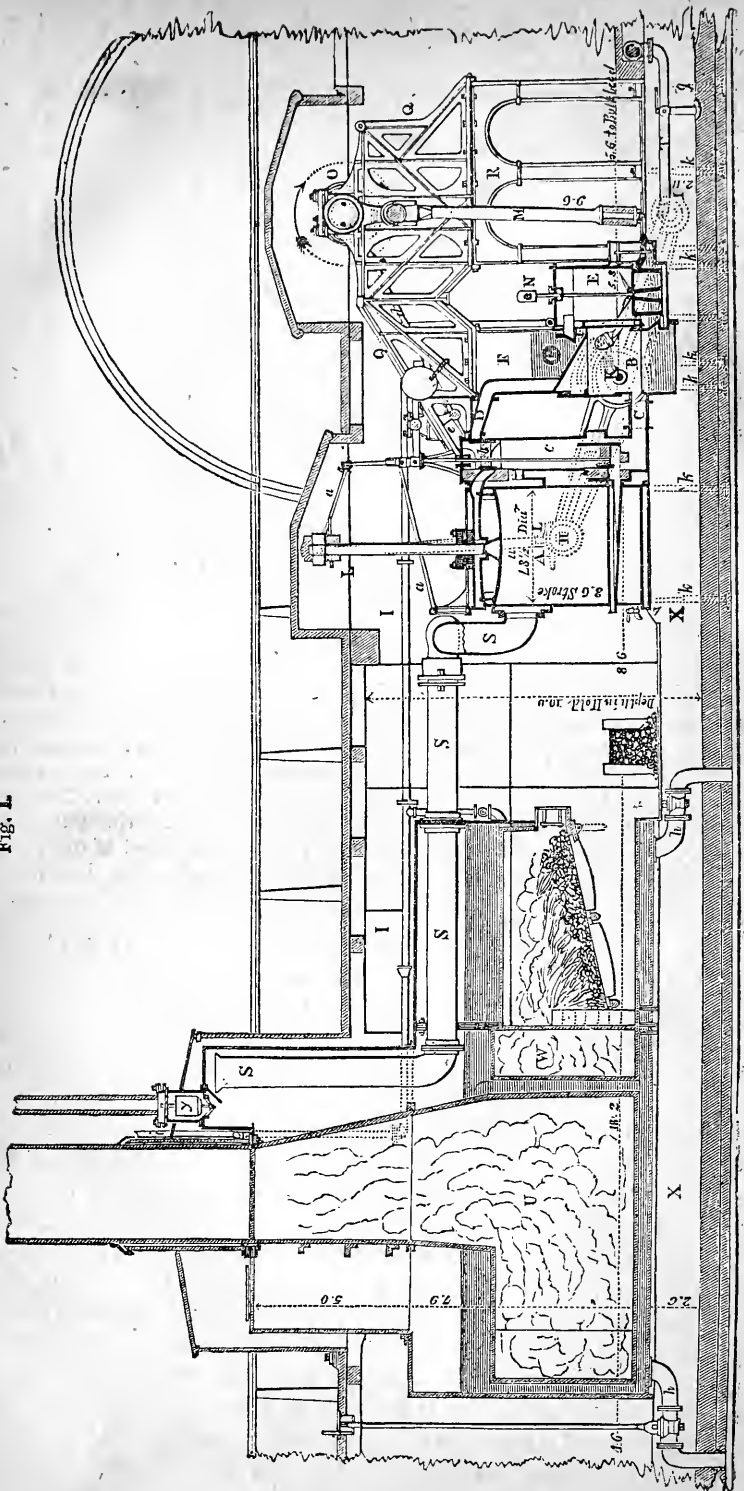

## MARINE BOILERS.

explanation by figures representing examples of particular classes of them.

29. To save space, they are constructed so as to produce the necessary quantity of steam, within the smallest possible dimensions. With this view a more extensive surface in proportion to the capacity of the boiler is exposed to the action of the fire. The flues, by which the flame and heated air are conducted to the chimney, are generally so constructed that the heated air issuing from the furnaces may be made to pass through the boiler, either

Fig. 3.

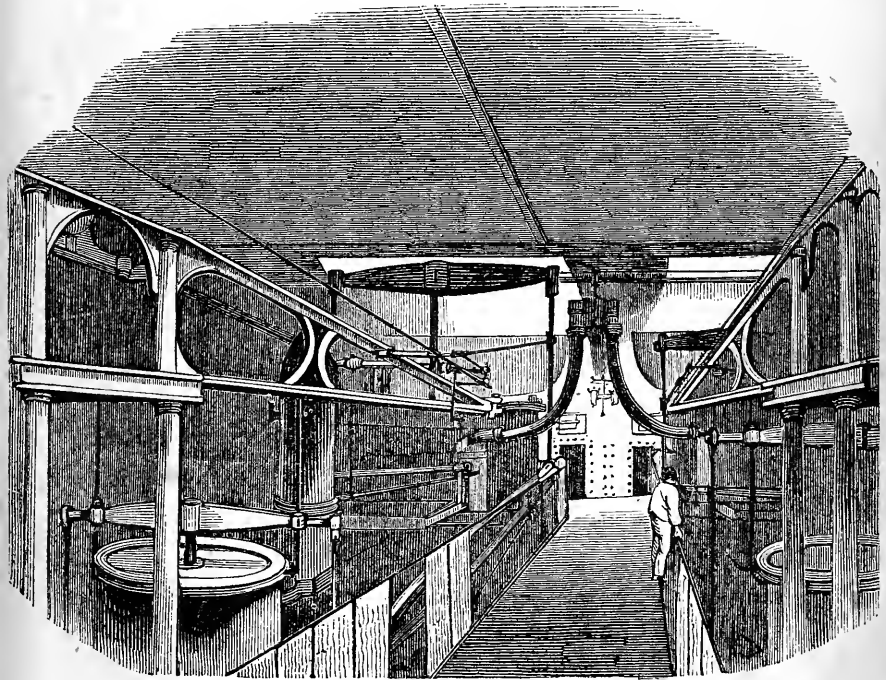

by a series of oblong narrow passages with flat sides, called *flues*, or by a multitude of tubes of small diameter, the one and the other leading from the furnaces to the base of the chimney, and being everywhere below the level of the water in the boiler. The former are called *flue boilers*, and the latter *tubular boilers*.

30. In the former class of boilers the flues are so formed as to traverse the boiler backwards and forwards several times before they terminate in the chimney. Such an arrangement renders the expense of the boilers greater than that of common land boilers, but their steam-producing power is greatly augmented. Experiments made by Mr. Watt, at Birmingham, proved that such boilers with the same consumption of fuel will produce, as compared with

## STEAM NAVIGATION.

common land boilers, an increased evaporation in the proportion of about three to two.

The form and arrangement of the water-spaces and flues in flue boilers are infinitely various. The sections of such boilers are exhibited in figs. 4, 5, 6. A section made by a horizontal

Fig. 4.

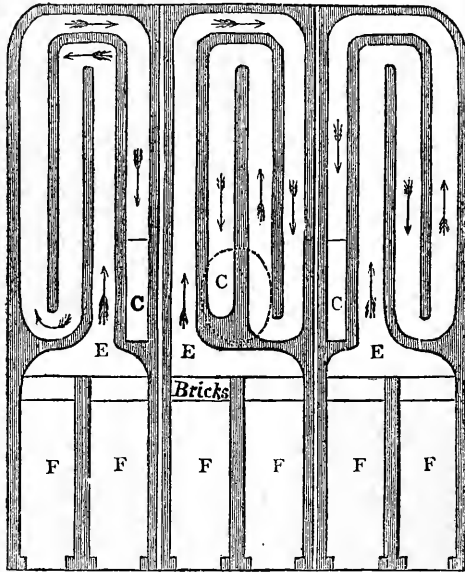

plane passing through the flues is exhibited in fig. 4. The furnaces F communicate in pairs with the flues E, the air following the course through the flues represented by the arrows. The flue E passes to the back of the boiler, then returns to the front, then

Fig. 5.

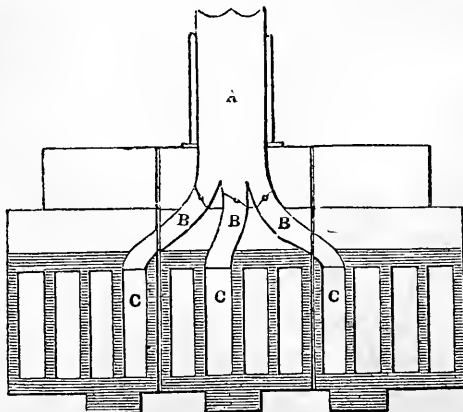



## MARINE BOILERS.

to the back again, and is finally carried back to the front, where it communicates at c with the curved flue B, represented in the transverse vertical section, fig. 5. This curved flue B finally terminates in the chimney A. There are, in this case, three independent boilers, each worked by two furnaces communicating with the same system of flues; and in the curved flues B, fig. 5, by which the air is finally conducted through the chimney, are placed three independent dampers, by means of which the furnace of each boiler can be regulated independently of the other, and by which each boiler may be separately detached from communication with the chimney.

A longitudinal section of the boiler, made by a vertical plane extending from the front to the back, is given in fig. 6, where F, as before, is the furnace, G the grate-bars sloping downwards from the front to the back, H the fire-bridge, c the commencement of the flues, and A the chimney. An elevation of the front of the

Fig. 6.

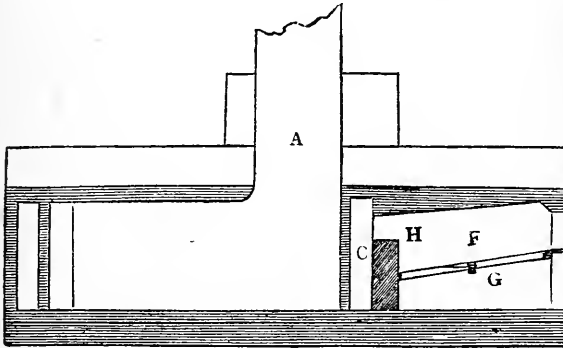

boiler is represented in fig. 7, showing two of the fire-doors closed and the other two removed, displaying the position of the grate-bars in front. Small openings are also provided, closed by proper doors, by which access can be had to the under-side of the flues, between the foundation timbers of the engine, for the purpose of cleaning them.

Each of these boilers can be worked independently of the others. By this means, when at sea, the engine may be worked by any two of the three boilers, while the third is being cleaned and put in order.

In the boilers here represented the flues are all upon the same level, winding backwards and forwards without passing one above the other. In other boilers, however, the flues, after passing backwards and forwards near the bottom of the boiler, turn

## STEAM NAVIGATION.

upwards and pass backwards and forwards through a level of the water nearer its surface, finally terminating in the chimney. More heating surface is thus obtained with the same capacity of boiler.

It is found in practice, that the most efficient parts of the flue-surface for the generation of steam, are those which are horizontal

Fig. 7.

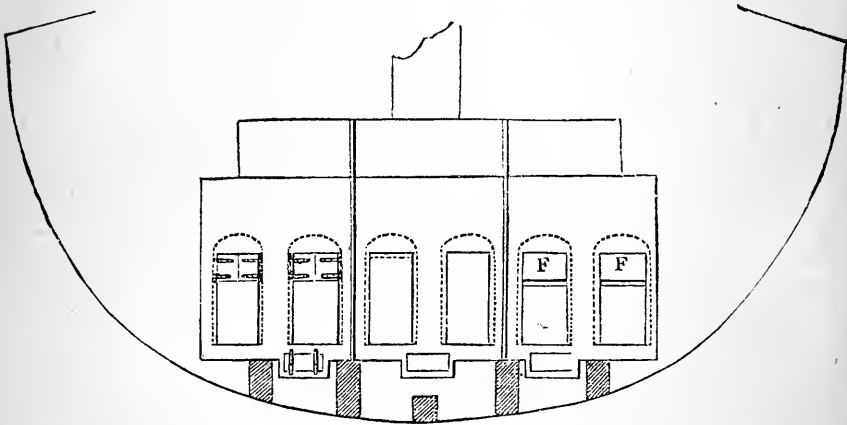

and at the upper parts of the flue, and the least efficient those which are horizontal and at the lowest part, the efficiency of the vertical sides being intermediate.

Since the flues are liable occasionally to become choked with soot and ashes, it is necessary that their magnitude shall be sufficient to allow a boy to enter them for the purpose of cleaning them.

31. Tubular marine boilers are constructed on a principle precisely similar to that of locomotive boilers, described in a former Tract. The flame and gaseous products of combustion, issuing from the furnace at a very elevated temperature, pass through a great number, sometimes several hundred, tubes of iron or brass, of about three inches diameter, which traverse the boiler below the level of the water in it, so that before they enter the chimney their temperature is reduced to a comparatively low point, the heat they thus lose being taken up by the water surrounding the tubes.

Flue boilers have the advantage over tubular boilers in being cheaper and more durable. With the same evaporating power they are however one-third larger and heavier, and consequently occupy a greater portion of the tonnage, and produce, other things being the same, a proportionally greater displacement, the latter condition augmenting the resistance, and therefore either diminishing the speed, or increasing the consumption of fuel.

## MARINE BOILERS.

32. There cannot be a more striking proof of the ignorance of general principles which prevails, respecting this branch of steam engineering, than the endless variety of forms and proportions which are adopted in the boilers and furnaces which are constructed, not only by different engineers but by the same engineer, for steamers of like power and capacity, and even for the same steamer at different times. Thus the original boilers of the *Great Western*, built for the New York and Bristol or Liverpool voyage, were of the common flue sort. They were subsequently taken out and replaced by tubular boilers. The dimensions and relative proportions of these two sets of boilers, thus supplied to the same vessel for the same voyage, differing as completely one from the other as if they had been designed for different vessels and different voyages.

On contemplating engineering proceedings, such as are exhibited in the preceding table, it is impossible to deny that practical men in such cases are groping in the dark, without the slightest benefit from the light which they ought to derive, from the present advanced state of physical science.

33. Tubular flues have been in many steamers adopted in preference to the flat and longer flues already described. In the second set of boilers of the *Great Western* above mentioned, the tubes were eight feet in length and three inches in diameter. In the boilers of the steamer *Ocean*, which are also tubular, the following are the principal dimensions:—

Boilers :	
Number . . . . . 3	Length . . . . . 9 feet
Length . . . . . 14 feet.	Diameter . . . . . 3 $\frac{1}{4}$ inches.
Breadth . . . . . 19 $\frac{1}{2}$ feet.	Cylinders :
Furnaces :	Number . . . . . 2
Number . . . . . 7	Diameter . . . . . 56 inches.
Length . . . . . 7 feet.	Stroke . . . . . 5 $\frac{1}{2}$ feet.
Breadth . . . . . 2 $\frac{11}{12}$ feet.	Pressure of steam above
Tubes :	atmosphere . . . . . 4 $\frac{1}{2}$ lbs. per in.
Material . . . . . Iron.	Consumption of coal
Number . . . . . 378	per hour . . . . . 18 cwt.

Among the more recent specifications of the machinery of marine engines submitted to the Admiralty, are some in which the boilers are traversed by nearly 2000 tubes of 3 $\frac{1}{2}$  inches external diameter, and five feet in length, giving a total heating surface of about 9000 square feet.

34. A formidable difficulty in the application of the steam-engine to sea voyages has arisen from the necessity of supplying the boiler with sea water instead of fresh water. The sea water is injected into the condenser for the purpose of condensing the

steam, and, mixed with the condensed steam, it is thence conducted as feeding water into the boiler.

Sea water holds, as is well known, certain saline and alkaline substances in solution, the principal of which is muriate of soda, or common salt. Ten thousand grains of pure sea water contain two hundred and twenty grains of common salt, the remaining ingredients being thirty-three grains of sulphate of soda, forty-two grains of muriate of magnesia, and eight grains of muriate of lime. The heat which converts pure water into steam does not at the same time evaporate those salts which the water holds in solution. As a consequence it follows, that, as the evaporation in the boiler is continued, the salt, which was held in solution by the water which has been evaporated, remains in the boiler, and enters into solution with the water remaining in it. The quantity of salt contained in sea water being considerably less than that which water is capable of holding in solution, the process of evaporation for some time is attended with no other effect, than to render the water in the boiler a stronger solution of salt. If, however, this process be continued, the quantity of salt retained in the boiler having constantly an increasing proportion to the quantity of water, it must at length render the water in the boiler a saturated solution; that is, a solution containing as much salt as, at the actual temperature, it is capable of holding in solution. If, therefore, the evaporation be continued beyond this point, the salt disengaged from the water evaporated, instead of entering into solution with the water remaining in the boiler, will be precipitated in the form of sediment; and if the process be continued in the same manner, the boiler would at length become a mere salt-pan.

But besides the deposition of salt sediment in a loose form, some of the constituents of sea water having an attraction for the iron of the boiler, collect upon it in a scale or crust, in the same manner as earthy matters, held in solution by spring water, are observed to form and become incrustated on the inner surface of land-boilers and of common culinary vessels.

The coating of the inner surface of a boiler by incrustation, and the collection of salt sediment in its lower parts, are attended with effects highly injurious to the materials of the boiler. The crust and sediment thus formed within the boiler are almost non-conductors of heat, and placed, as they are, between the water contained in the boiler and the metallic plates which form it, they obstruct the passage of heat from the outer surface of the plates in contact with the fire, to the water. The heat, therefore, accumulating in the boiler-plates so as to give them a much higher temperature than the water within the boiler, has the effect of softening them, and by the unequal temperature which will thus

## EFFECTS OF SEA-WATER.

be imparted to the lower plates which are incrustated, compared with the higher parts which may not be so, an unequal expansion is produced, by which the joints and seams of the boiler, are loosened and opened, and leaks produced.

These injurious effects can only be prevented by either of two methods; first, by so regulating the feed of the boiler that the water it contains shall not be suffered to reach the point of saturation, but shall be so limited in its degree of saltness that no injurious incrustation or deposit shall be formed; secondly, by the adoption of some method by which the boiler may be worked with fresh water. This end can only be attained by condensing the steam by a jet of fresh water, and working the boiler continually by the same water, since the supply of fresh water sufficient for a boiler worked in the ordinary way, could never be commanded at sea.

The method by which the saltness of the water in the boiler is most commonly prevented from exceeding a certain limit, has been to discharge from the boiler into the sea a certain quantity of over-salted water, and to supply its place by sea water introduced into the condenser through the injection-cock, for the purpose of condensing the steam, this water being mixed with the steam so condensed, and being, therefore, a weaker solution of salt than common sea water. To effect this, cocks called *blow-off cocks* are usually placed in the lower parts of the boiler, where the over-salted, and therefore heavier, parts of the water collect. The pressure of the steam and incumbent weight of the water in the boiler force the lower strata of water out through these cocks; and this process, called *blowing out*, is, or ought to be practised at such intervals as will prevent the water from becoming over-salted. When the salted water has been blown out in this manner, the level of the water in the boiler is restored by a feed of corresponding quantity.

This process of blowing out, on the due and regular observance of which the preservation and efficiency of the boiler mainly depend, is too often left at the discretion of the engineer, who is, in most cases, not even supplied with the proper means of ascertaining the extent to which the process should be carried. It is commonly required that the engineer should blow out a certain portion of the water in the boiler every two hours, restoring the level by a feed of equivalent amount; but it is evident that the sufficiency of the process, founded on such a rule, must mainly depend on the supposition, that the evaporation proceeds always at the same rate, which is far from being the case with marine boilers.

35. An indicator, by which the saltness of the water in the boiler would always be exhibited, ought to be provided, and the

## STEAM NAVIGATION.

process of blowing out should be regulated by the indications of that instrument. To blow out more frequently than is necessary is attended with a waste of fuel; for hot water is thus discharged into the sea while cold water is introduced in its place, and consequently all the heat necessary to produce the difference of the temperatures of the water blown out, and the feed introduced, is lost. If, on the other hand, the process of blowing out be observed less frequently than is necessary, then more or less incrustation and deposit may be produced, and the injurious effects already described ensue.

36. As the specific gravity of water holding salt in solution is increased with every increase of the strength of the solution, any form of hydrometer capable of exhibiting a visible indication of the specific gravity of the water contained in the boiler, would serve the purpose of an indicator, to show when the process of blowing out is necessary, and when it has been carried to a sufficient extent. The application of such instruments, however, would be attended with some practical difficulties in the case of sea boilers.

37. The temperature at which a solution of salt boils under a given pressure varies considerably with the strength of the solution; the more concentrated the solution is, the higher will be its boiling temperature under the same pressure. A comparison, therefore, of a steam-gauge attached to the boiler, and a thermometer immersed in it, showing the pressure and the temperature, would always indicate the saltiness of the water; and it would not be difficult so to graduate these instruments as to make them at once show the degree of saltiness.

If the application of the thermometer be considered to be attended with practical difficulty, the difference of pressures under which the salt water of the boiler and fresh water of the same temperature boil, might be taken as an indication of the saltiness of the water in the boiler, and it would not be difficult to construct upon this principle a self-registering instrument, which would not only indicate but record from hour to hour the degree of saltiness of the water. A small vessel of distilled water being immersed in the water of the boiler would always have the temperature of that water, and the steam produced from it communicating with a steam-gauge, the pressure of such steam would be indicated by that gauge, while the pressure of the steam in the boiler under which pressure the salted water boils might be indicated by another gauge. The difference of the pressures indicated by the two gauges would thus become a test, by which the saltiness of the water in the boiler would be measured. The two pressures might be made to act on opposite ends of the same

## REMEDIES.

column of mercury contained in a siphon tube, and the difference of the levels of the two surfaces of the mercury, would thus become a measure of the saltness of the water in the boiler. A self-registering instrument, founded on this principle, formed part of the self-registering steam-log which I proposed to introduce into steam-vessels some time since.

38. The Messrs. Seaward of Limehouse adopted, in some of their engines, a method of indicating the saltness of the water, and of measuring the quantity of salted water or brine discharged by blowing out. A glass-gauge, similar in form to that already described in land engines, is provided, to indicate the position of the surface of the water in the boiler. In this gauge two hydrometer balls are provided, the weight of which in proportion to their magnitude is such, that they would both sink to the bottom in a solution of salt of the same strength as common sea water. When the quantity of salt exceeds  $\frac{5}{32}$  parts of the whole weight of the water, the lighter of the two balls will float to the top; and when the strength is further increased until the proportion of salt exceeds  $\frac{6}{32}$  parts of the whole, then the heavier ball will float to the top. The actual quantity of salt held in solution by sea water in its ordinary state is  $\frac{1}{32}$  part of its whole weight; and when by evaporation the proportion of salt in solution has become  $\frac{9}{32}$  parts of the whole, then a deposition of salt commences. With an indicator such as that above described, the ascent of the lighter hydrometer ball gives notice of the necessity for blowing out, and the ascent of the heavier may be considered as indicating the approach of an injurious state of saltness in the boiler.

The ordinary method of blowing out the salted water from a boiler is by a pipe, having a cock in it leading from the boiler through the bottom of the ship, or at a point low down at its side. Whenever the engineer considers that the water in the boiler has become so salted, that the process of blowing out should commence, he opens the cock communicating by this pipe with the sea, and suffers an indefinite and uncertain quantity of water to escape. In this way he discharges, according to the magnitude of the boiler, from two to six tons of water, and repeats this at intervals of from two to four hours, as he may consider to be sufficient. If, by observing this process, he prevents the boiler from getting incrustated during the voyage, he considers his duty to be effectually discharged, forgetting that he may have blown out many times more water than is necessary for the preservation of the boiler, and thereby produced a corresponding and unnecessary waste of fuel. In order to limit the quantity of water discharged, Messrs. Seaward adopted the following method. In

## STEAM NAVIGATION.

fig. 8 is represented a transverse section of a part of a steam-vessel; *w* is the water-line of the boiler, *B* is the mouth of a blow-off pipe, placed near the bottom of the boiler. This pipe rises to *A*, and turning in the horizontal direction, *A C*, is conducted to a tank *T*, which contains exactly a ton of water. This pipe communicates with the tank by a cock *D*, governed by a lever *H*. When this lever is moved to *D'*, the cock *D* is open, and when it is moved to *K*, the cock *D* is closed. From the same tank there proceeds another pipe *E*, which issues from the side of the vessel into the sea, governed by a cock *F*, which is likewise put in

Fig. 8.

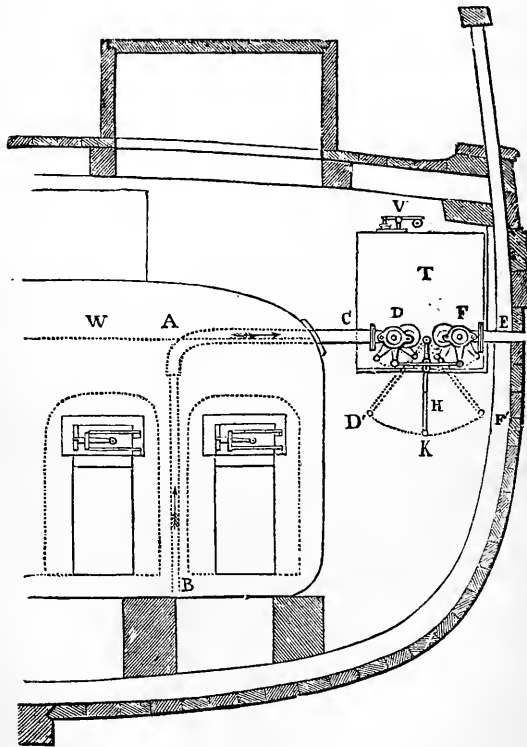

connection with the lever *H*, so that it shall be opened when the lever *H* is drawn to the position *F'*, the cock *D'* being closed in all positions of the lever between *K* and *F'*. Thus, whenever the cock *F* communicating with the sea is open, the cock *D* communicating with the boiler is closed, and *vice versa*, both cocks being closed when the lever is in the intermediate position *K*. By this arrangement the boiler cannot, by any neglect in blowing off, be left in communication with the sea, nor can more than a ton of water be discharged except by the immediate act of the



## BRINE-PUMPS.

engineer. The injurious consequences are thus prevented which sometimes ensue, when the blow-off cocks are left open by any neglect on the part of the engineer. When it is necessary to blow off, the engineer moves the lever H to the position D'. The pressure of the steam in the boiler on the surface of the water forces the salted water or brine up the pipe B A, and through the open cock c into the tank, and this continues until the tank is filled: when that takes place, the lever is moved from the position D' to the position F', by which the cock D is closed, and the cock F opened. The water in the tank flows through the pipe E into the sea, air being admitted through the valve v, placed at the top of the tank, opening inwards. A second ton of brine is discharged by moving the lever back to the position D', and subsequently returning it to the position F'; and in this way the brine is discharged ton by ton, until the supply of water from the feed which replaces it has caused both the balls in the indicator to sink to the bottom.

39. A different method of preserving the requisite freshness of the water in the boiler was adopted by Messrs. Maudslay and Field. Pumps called *brine-pumps* are put into communication with the lower part of the boiler, and so constructed as to draw the brine therefrom, and drive it into the sea. These brine-pumps are worked by the engine, and their operation is constant. The feed-pumps are likewise worked by the engine, and they bear such a proportion to the brine-pumps that the quantity of salt discharged in a given time in the brine is equal to the quantity of salt introduced in solution by the water of the feed-pumps. By this means the same actual quantity of salt is constantly maintained in the boiler, and consequently the strength of the solution remains invariable. If the brine discharged by the brine-pumps contains  $\frac{5}{32}$  parts of salt, while the water introduced by the feed-pumps contains only  $\frac{1}{32}$  part, then it is evident that five cubic feet of the feeding-water will contain no more salt than is contained in one cubic foot of brine. Under such circumstances the brine-pumps would be so constructed as to discharge  $\frac{1}{5}$  of the water introduced by the feed-pumps, so that  $\frac{4}{5}$  of all the water introduced into the boiler would be evaporated, and rendered available for working the engine.

To save the heat of the brine, a method has been adopted in the marine engines constructed by Messrs. Maudslay and Field, similar to one which has been long practised in steam-boilers, and in various apparatus for the warming of buildings. The current of heated brine is conducted from the boiler through a tube which is contained in another, through which the feed is introduced. The warm current of brine, therefore, as it passes out,

imparts a considerable portion of its heat to the cold feed which comes in; and it is found that by this expedient the brine discharged into the sea may be reduced to a temperature of about 100°.

This expedient is so effectual, that when the apparatus is properly constructed, and kept in a state of efficiency, it may be regarded as nearly a perfect preventive against the incrustation, and the deposition of salt in the boilers, and is not attended with any considerable waste of fuel.

40. It is maintained by some practical men, that the economy of heat effected by brine-pumps, such as have been just described, is more than counterbalanced by the risk which attends them, if not accompanied by proper precautions. The pipes through which the salted water is discharged are, it is said, apt to get choked, in which case the pumps will necessarily cease to act, though they appear to the engineer to do so; and thus the water in the boiler may become salted to any extent without the knowledge of the engineer. When the process of *blowing out* is executed in the ordinary way, without brine-pumps, the engineer looks at his water-gauge and keeps the blow-off cock open, until the water level has fallen to the required point. Under these circumstances there is a certainty of having discharged from the boiler a certain quantity of salted water, a certainty which does not exist in the case of a continuous discharge of water by brine-pumps.

Such expedients, therefore, it is contended, should always be accompanied by some indicator, which shall show the degree of saltiness of the water in the boiler, such as we shall presently explain.

41. In practice, if a marine boiler be regularly attended to, and the salted water be discharged either by the common method of blowing-off cocks or by brine-pumps, or any other expedient which shall impose the necessary limit on the degree of concentration of water in the boiler, the evil arising from incrustation will be quite inconsiderable.

A scale will in all cases be formed on the inner surface of the boilers, which must be removed from time to time when the vessel is in port. The best method of effecting this is by lighting some shavings, or other light and flaming combustible, in the furnaces when the boilers are empty and the safety-valves open. The expansion of the metal by the heat thus produced being greater than that of the matter composing the scale, the latter will be detached and will fall in pieces to the bottom of the boiler, from which it can be withdrawn with the water at the man-holes.

In some cases, however, it will be preferable to detach the scale by the hammer or chisel.

42. It is a great error to suppose that incrustation is either the

## ECONOMY OF FUEL.

sole or principal cause of the rapid destruction of marine boilers. If it were so, it would necessarily happen that marine boilers in which expedients are adopted by which fresh water is used, or even those in which the process of blowing out has been regularly observed, and in which the scale is detached before it is allowed to thicken to an injurious extent, would last as long, or nearly as long, as land boilers. It is found, however, that the boilers in which these expedients are adopted with the greatest effect and regularity are, nevertheless, less durable in a very large proportion than land boilers. Thus, while a land boiler will last for twenty years, a marine boiler, similarly constructed, will, even with the greatest care, be worn out in four or five years.

The cause of this rapid destruction of the boiler is corrosion, but how this corrosion is produced is a question which has not hitherto been satisfactorily answered. It is contended that this is not to be ascribed to any chemical action of the sea water on the iron, inasmuch as the flues of marine boilers rarely show any deterioration from this cause, and even in worn-out marine boilers the hammer-marks on the flues are as conspicuous as when they are fresh from the boiler-maker. The thin film of scale which covers the interior surface would rather protect the iron from the action of the water. In fine, the seat of the corrosion is almost never those parts of the boiler which are in contact with the water. It is that part of the metal which includes the steam space that exhibits corrosion; but even there the effect is so irregular, that no data can be obtained by which the cause can be satisfactorily traced. The part which is most rapidly corroded in one boiler is not at all affected in another; and in some cases we find one side of the steam-chest attacked, the other side being untouched. Sometimes the iron exfoliates in flakes, while in others it appears as though it were eaten away by an acid.

43. In the application of the steam-engine to the propulsion of vessels in voyages of great extent, the economy of fuel acquires an importance greater than that which appertains to it in land engines, even in localities the most removed from coal-mines, and where its expense is greatest. The practical limit to steam voyages being determined by the greatest quantity of coals which a steam vessel can carry, every expedient by which the efficiency of the fuel can be increased becomes a means, not merely of a saving of expense, but of an increased extension of steam-power to navigation. Much attention has been bestowed on the augmentation of the duty of engines in the mining districts of Cornwall, where the question of their efficiency is merely a question of economy; but far greater care should be given to this subject, when the practicability of maintaining intercourse by steam

between distant points of the globe, will perhaps depend on the effect produced by a given quantity of fuel. So long as steam navigation was confined to river and channel transport and to coasting voyages, the speed of the vessel was a paramount consideration, at whatever expenditure of fuel it might be obtained; but since steam navigation has been extended to ocean voyages, where coals must be transported sufficient to keep the engine in operation for a long period of time without a fresh relay, greater attention has been bestowed upon the means of economising it.

Much of the efficiency of fuel must depend on the management of the fires, and therefore on the skill and care of the stokers. Formerly the efficiency of firemen was determined by the abundant production of steam; and so long as the steam was evolved in superabundance, however it might have blown off to waste, the duty of the stoker was considered as well performed. The regulation of the fires according to the demands of the engine was not thought of, and whether much or little steam was wanted, the duty of the stoker was to urge the fires to their extreme limit.

Since the resistance opposed by the action of the paddle-wheels of a steam-vessel varies with the state of the weather, the consumption of steam in the cylinders must undergo a corresponding variation; and if the production of steam in the boilers be not proportioned to this, the engines will either work with less efficiency than they might do under the actual circumstances of the weather, or more steam will be produced in the boilers than the cylinders can consume, and the surplus will be discharged to waste through the safety valves. The stokers of a marine engine, therefore, to perform their duty with efficiency, and obtain from the fuel the greatest possible effect, must discharge the functions of a self-regulating furnace, such as has been already described: they must regulate the force of the fires by the amount of steam which the cylinders are capable of consuming, and they must take care that no unconsumed fuel is allowed to be carried away from the ash-pit.

44. Formerly the heat radiated from every part of the surface of the boiler was allowed to go to waste, and to produce injurious effects on those parts of the vessel to which it was transmitted. This evil, however, has been removed by coating the boilers, steam-pipes, &c., of steam-vessels with felt, by which the escape of heat from the surface of the boiler is very nearly, if not altogether, prevented. This felt is attached to the boiler surface by a thick covering of white and red lead. This expedient was first applied in the year 1818 to a private steam vessel of Mr. Watt's, called the *Caledonia*; and it was subsequently adopted in another vessel, the machinery of which was constructed at Soho, called the *James Watt*.

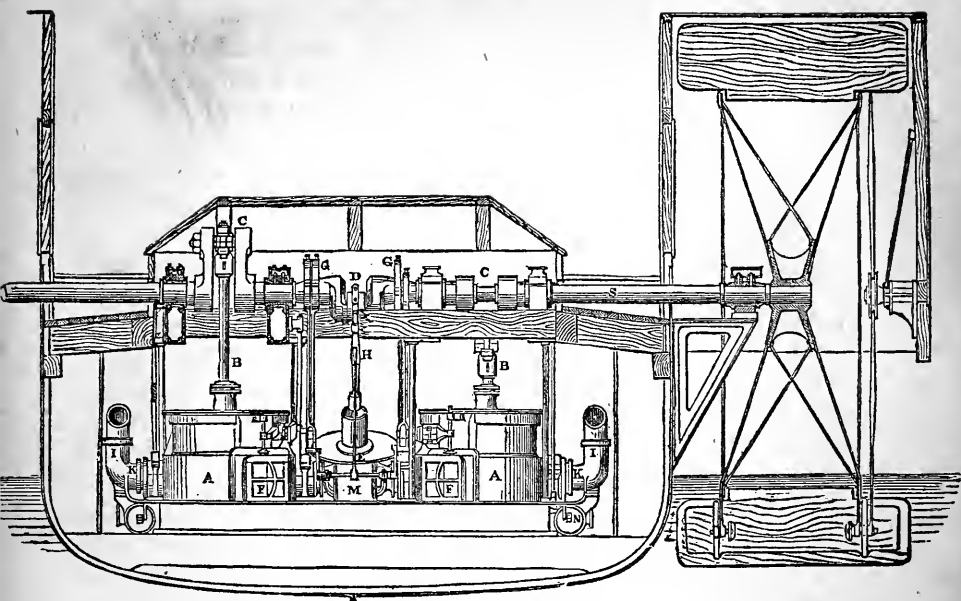

Fig. 10.

## STEAM NAVIGATION.

### CHAPTER III.

45. Economy of fuel.—46. Width and depth of furnace.—47. Advantage of expansive action.—48. Siamese engines.—49. Simplified arrangements.—50. Number and position of cylinders.—51. Proportion of diameter to stroke.—52. Oscillating engines.—53. Engines of the Peterhoff.—54. Propellers.—55. The common paddle-wheels.—56. Feathering paddles.—57. Morgan's paddle-wheel.—58. Field's split paddles.—59. American paddle-wheel.—60. Practical objections to feathering paddles.—61. Proportion of marine engines.—62. Submerged propellers.—63. Their disadvantages.—64. Screw-propellers.—65. Pitch and slip.—66. Manner of mounting screw-propellers.—67. Their various forms.

45. THE economy of fuel depends in a great degree on the arrangement of the furnaces, and the method of feeding them. In general, each boiler is worked by two or more furnaces communicating with the same system of flues. While the furnace

is fed, the door being open, a stream of cold air rushes in, passing over the burning fuel and lowering the temperature of the flues : this is an evil to be avoided. But, on the other hand, if the furnaces be fed at distant intervals, each furnace will be unduly heaped with fuel, a great quantity of smoke will be evolved, and the combustion of the fuel will be proportionally imperfect. The process of coking in front of the grate, which would insure a complete combustion of the fuel, has been already described in our tract on the Steam Engine. A frequent supply of coals, however, laid carefully on the front part of the grate, and gradually pushed backwards as each fresh feed is introduced, would require the fire door to be frequently opened, and cold air to be admitted. It would also require greater vigilance on the part of the stokers, than can generally be obtained in the circumstances in which they work. In steam-vessels the furnaces are therefore fed less frequently, fuel is introduced in greater quantities, and a less perfect combustion produced.

When several furnaces are constructed under the same boiler, communicating with the same system of flues, the process of feeding, and consequently opening one of them, obstructs the due operation of the others, for the current of cold air which is thus admitted into the flues checks the draught, and diminishes the efficiency of the furnaces in operation. It was formerly the practice in vessels exceeding one hundred horse-power, to place four furnaces under each boiler, communicating with the same system of flues. Such an arrangement was found to be attended with a bad draught in the furnaces, and therefore to require a greater quantity of heating surface to produce the necessary evaporation. This entailed upon the machinery the occupation of more space in the vessel in proportion to its power ; it has therefore been more recently the practice to give a separate system of flues to each pair of furnaces, or, at most, to every three furnaces. When three furnaces communicate with a common flue, two will always be in operation, while the third is being cleared out ; but if the same quantity of fire were divided among two furnaces, then the clearing out of one would throw out of operation half the entire quantity of fire, and during the process the evaporation would be injuriously diminished.

46. It is found by experience, that the side plates of furnaces are liable to more rapid destruction than their roofs, owing, probably, to a greater liability to deposit. Furnaces, therefore, should not be made narrower than a certain limit. Great depth from front to back is also attended with practical inconvenience, as it renders firing tools of considerable length, and a corresponding extent of stoking room necessary. It is recommended by those who have had

much practical experience in steam-vessels, that furnaces six feet in depth from front to back should not be less than three feet in width to afford means of firing with as little injury to the side plates as possible, and of keeping the fires in the condition necessary for the production of the greatest effect. The tops of the furnaces scarcely ever decay, and are seldom subject to an alteration of figure, unless the level of the water be allowed to fall below them.

47. The method by which the greatest quantity of practical effect can be obtained from a given quantity of fuel must, however, mainly depend on the extended application of the expansive principle. This has been the means by which an extraordinary amount of duty has been obtained from the Cornish engines. The difficulty of the application of this principle in marine engines, has arisen from the objections entertained in Europe to the use of steam of high-pressure, under the circumstances in which the engine must be worked at sea. To apply the expansive principle, it is necessary that the moving power at the commencement of the stroke shall considerably exceed the resistance, its force being gradually attenuated till the completion of the stroke, when it will at length become less than the resistance. This condition may, however, be attained with steam of limited pressure, if the engine be constructed with a sufficient quantity of piston surface.

48. This method of rendering the expansive principle available at sea, and compatible with low-pressure steam, was projected and executed by Messrs. Maudslay and Field. Their improvement consists in adapting two steam cylinders in one engine, in such a manner that the steam shall act simultaneously on both pistons, causing them to ascend and descend together. The piston-rods are both attached to the same horizontal cross-head, whereby their combined action is applied to one crank by means of a connecting-rod placed between the pistons.

A section of such an engine (which has been called the Siamese engine), made by a plane passing through the two piston-rods  $p$   $p'$  and cylinders, is represented in fig. 9. The piston-rods are attached to a cross-head  $c$ , which ascends and descends with them. This cross-head drives upwards and downwards an axle  $d$ , to which the lower end of the connecting-rod  $e$  is attached. The other end of the connecting-rod drives the crank-pin  $f$ , and imparts revolution to the paddle-shaft  $g$ . A rod  $h$  conveys motion by means of a beam  $i$  to the rod  $k$  of the air-pump  $l$ .

Engines constructed on this principle were applied in several steamers, and amongst others in her Majesty's steam-frigate "Retribution."

49. Within the last ten or fifteen years, and especially since the more general adoption of the screw-propeller, the marine engine has been greatly simplified in its mechanical arrangements. Its bulk has thus been diminished, as well as

## STEAM NAVIGATION.

the cost of construction; and the profitable tonnage of the vessel has been increased in a corresponding proportion. The beam and its appendages have been very generally laid aside, and the piston-rods have been more directly connected with the cranks.

In some cases the piston-rods are kept in their direction by guides, and their rectilinear motion is accommodated to the

Fig. 9.

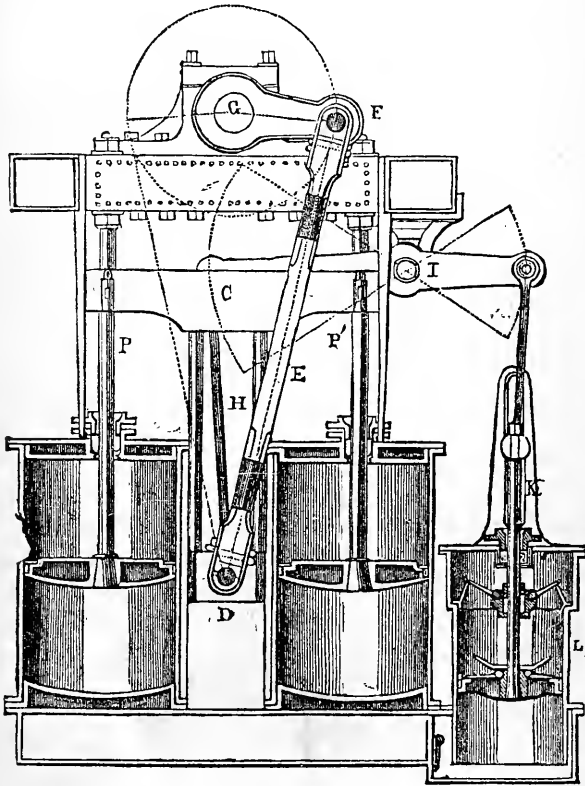

rotation of the cranks by connecting-rods, which consequently have an oscillation between the extreme points of the play of the cranks.

In other cases the cylinders themselves receive this oscillation. In such cases the connecting-rods are dispensed with, and the ends of the piston-rods are immediately jointed to the cranks. The oscillation of the piston causes the motion of the valves necessary for the alternate admission and escape of the steam on the one and the other side of the piston.

50. The number of cylinders varies, being generally two, but



sometimes three, sometimes four, and sometimes, though very exceptionally, only one.

The position of the cylinders is subject to great variation. They are placed with their axes sometimes vertical, sometimes horizontal, and sometimes oblique.

51. The proportion of the diameter to the stroke is subject to like variation. The general tendency has been to increase the relative magnitude of the diameter, which in recently built engines is sometimes more than twice the stroke, and rarely less than two-thirds of it. Thus in the engines of the "Niger," constructed by Messrs. Maudslay and Field, the cylinders have 48 inches diameter, with only 22 inches stroke; and in the "Simoom," by Boulton and Watt, they have 44 inches diameter, with 30 inches stroke.

The object of shortening the stroke is to diminish the momentum of the piston, of which the motion requires to be so frequently reversed.

52. In engines constructed on the oscillating principle, the top of the piston-rod is coupled with the crank, and the piston-rod moves backward and forward in the direction of the axis of the cylinder, while its extremity revolves in a circle with the crank. It is therefore necessary that the cylinder should oscillate from side to side, to accommodate the motion of the piston-rod to that of the crank. For this purpose the cylinder is provided on each side with a short hollow pivot or trunnion, on which it swings; and through one of these trunnions the steam enters the cylinder from the boiler, while it escapes through the other to the condenser. The alternate admission and escape of steam on the one side and the other of the piston, is regulated by a valve attached to the cylinder and swinging with it. In the larger class of engines, however, two valves are usually employed for this purpose, and are so arranged as to balance one another.

Oscillating engines are usually placed immediately under the cranks, and occupy no greater length in the vessel than the diameter of the cylinder. On the shaft which connects the engine, called the intermediate shaft, a crank is forged which in its revolutions gives motion to the piston of the air-pump.

53. The arrangements generally employed at present in the most improved vessels propelled by oscillating engines, will be understood by reference to fig. 10, which represents the transverse section of the steam-yacht "Peterhoff," constructed for the Emperor of Russia, by Messrs. Rennie, and fig. 11, which is a side view of the engines of the same vessel. These figures are copied with the permission of the publishers and the authors, from the article on the steam-engine, in the last edition of Brande's "Dictionary of Science." A, A are the cylinders; B, B are the piston-rods, which are connected immediately with the cranks c, c; D is a crank on

## STEAM NAVIGATION.

the intermediate shaft for working the piston of the air-pump  $\epsilon$  ;  $F, F$  are

Fig. 11.

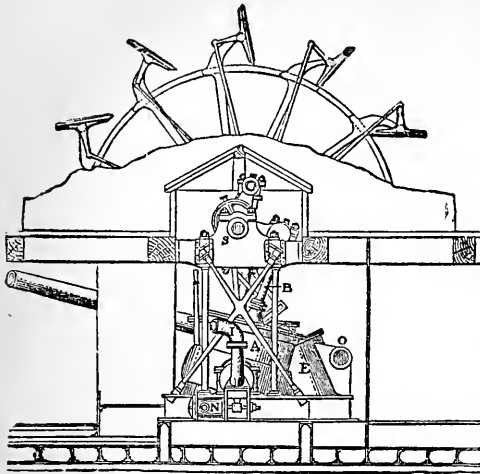

the slide-valves, by which the admission of the steam to the cylinders is regulated ;  $g, g$  are double eccentrics on the intermediate shaft, whereby the valves  $F, F$  are moved ;  $h$  is a handle, whereby the engines may be stopped, started, or reversed ;  $i, i$  are the steam-pipes leading to the steam-trunnions  $k, k$ , on which, and on other trunnions, connected with the pipe  $m$ , the cylinders oscillate ;  $n, n$  are pumps, the pistons of which are attached to the trunnions, and are worked by the oscillation of the cylinders ;  $o$  is the waste-water pipe, through which

the water which has accomplished the function of condensing the steam is ejected over-board. The same letters refer to the same parts in the two figures.

54. To obtain from the moving power its full amount of mechanical effect in propelling the vessel, it would be necessary that it should constantly act against the water in a horizontal direction, and with a motion contrary to the course of the vessel. No system of propellers has, however, yet been contrived capable of perfectly accomplishing this. Patents have been granted for many ingenious mechanical combinations to impart to the propelling surfaces such angles as appeared to the respective contrivers most advantageous. In most of these the mechanical complexity has formed a fatal objection. No part of the machinery of a steam-vessel is so liable to become deranged at sea as the propellers ; and, therefore, that simplicity of construction which is compatible with those repairs which are possible on such emergencies is quite essential for safe practical use.

55. The ordinary paddle-wheel, as has been already stated, is a wheel revolving upon a shaft driven by the engine, and carrying upon its circumference a number of flat boards, called paddle-boards, which are secured by nuts and braces in a fixed position ; and that position is such that the planes of the paddle-boards diverge from the centre of the shaft on which the wheel turns. The consequence of this arrangement is that each paddle-board can only act in that direction which is most advantageous for the propulsion of the vessel when it arrives at the lowest point of the wheel. In fig. 12, let  $o$  be the shaft on which the common paddle-wheel revolves ; the positions of the paddle-boards are represented at  $A, B, C$ , &c. ;  $x y$  represents the water-line, the course of the vessel being supposed to be from  $x$  to  $y$  ; the arrows represent the direction in which the paddle-wheel

## COMMON PADDLE-WHEEL.

revolves. The wheel is immersed to the depth of the lowest paddle-board, since a less degree of immersion would render a portion of the surface of each paddle-board mechanically useless. In the position A, the whole force of the paddle-board is efficient for propelling the vessel; but as the paddle enters the water in the position H, its action upon the water not being horizontal, is only partially effective for propulsion: a part of the force which drives the paddle is expended in depressing the water, and the remainder in driving it contrary to the course of the vessel, and, therefore,

Fig. 12.

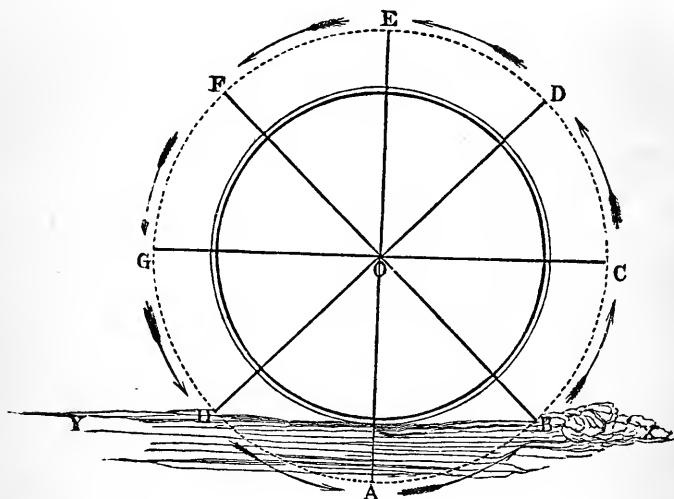

by its re-action producing a certain propelling effect. The tendency, however, of the paddle entering the water at H is to form a hollow or trough, which the water, by its ordinary property, has a continual tendency to fill up. After passing the lowest point A, as the paddle approaches the position B, where it emerges from the water, its action again becomes oblique, a part only having a propelling effect, and the remainder having a tendency to raise the water, and throw up a wave and spray behind the paddle-wheel. It is evident that the more deeply the paddle-wheel becomes immersed, the greater will be the proportion of the propelling power thus wasted in elevating and depressing the water; and if the wheel were immersed to its axis, the whole force of the paddle-boards, on entering and leaving the water, would be lost, no part of it having a tendency to propel. If a still deeper immersion take place, the paddle-boards above the axis would have a tendency to retard the course of the vessel. When the vessel is, therefore, in proper trim, the immersion should not exceed nor fall short of the depth of the lowest paddle; but for various reasons it is impossible in practice to maintain this fixed immersion: the agitation of the surface of the sea causing the vessel to roll, will necessarily produce a great variation in the immersion of the paddle-wheels, one becoming frequently immersed to its axle, while the other is raised altogether out of the water. Also the draught of water of the vessel is liable to change, by the variation in the cargo; this will necessarily happen in steamers which take long voyages. At starting they are heavily laden with fuel, which as they proceed is gradually consumed, whereby the vessel is lightened.

56. To remove this defect, and economise as much as possible the propelling effect of the paddle-boards, it would be necessary so to construct them that they may enter and leave the water edgeways,

Fig. 13.

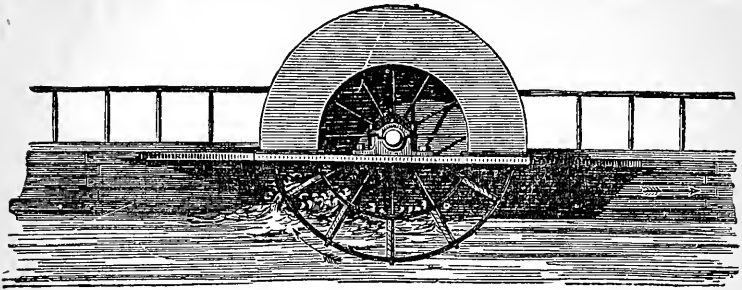

or as nearly so as possible; such an arrangement would be, in effect, equivalent to the process called feathering, as applied to oars. Any mechanism which would perfectly accomplish this would cause the paddles to work in almost perfect silence, and would very nearly remove the inconvenient and injurious vibration which is produced by the action of the common paddles. But the construction of feathering paddles is attended with great difficulty, under the peculiar circumstances in which such wheels work. Any mechanism so complex that it could not be easily repaired when deranged, with such engineering implements and skill as can be obtained at sea, would be attended with great objections.

Feathering paddle-boards must necessarily have a motion independently of the motion of the wheel, since any fixed position which could be given to them, though it might be most favourable to their action in one position, would not be so in their whole course through the water. Thus the paddle-board when at the lowest point should be in a vertical position, or so placed that its plane, if continued upwards, would pass through the axis of the wheel. In other positions, however, as it passes through the water, it should present its upper edge, not towards the axle of the wheel, but towards a point above the highest point of the wheel. The precise point to which the edge of the paddle-board should be directed is capable of mathematical determination. But it will vary according to circumstances, which depend on the motion of the vessel. The progressive motion of the vessel, independently of the wind or current, must obviously be slower than the motion of the paddle-boards round the axle of the wheel; since it is by the difference of these velocities that the re-action of the water is produced, by which the vessel is propelled. The proportion, however, between the progressive speed of the vessel and the rotative speed of the paddle-boards is not fixed; it will vary with the shape and

## FEATHERING PADDLES.

structure of the vessel, and with its depth of immersion; nevertheless it is upon this proportion that the manner in which the paddle-boards should shift their position must be determined. If the progressive speed of the vessel were nearly equal to the rotative speed of the paddle-boards, the latter should so shift their position that their upper edges should be presented to a point very little above the highest point of the wheel. This is a state of things which could only take place in the case of a steamer of a small draught of water, shallop-shaped, and so constructed as to suffer little resistance from the fluid. On the other hand, the greater the depth of immersion, and the less fine the lines of the vessel, the greater will be the resistance in passing through the water, and the greater will be the proportion which the rotative speed of the paddle-boards will bear to the progressive speed of the vessel. In this latter case the independent motion of the paddle-boards should be such that their edges, while in the water, shall be presented towards a point considerably above the highest point of the paddle-wheel.

A vast number of ingenious mechanical contrivances have been invented and patented, for accomplishing the objects just explained. Some of these have failed from the circumstance of their inventors not clearly understanding what precise motion it was necessary to impart to the paddle-boards; others have failed from the complexity of the mechanism by which the desired effect was produced.

57. One of these contrivances of late construction is represented in fig. 11, being the paddle-wheel of the Russian steamer "Peterhoff." To convey a general idea of the feathering principle, however, we have represented in fig. 14 the form of wheel known as Morgan's paddle-wheel.

This contrivance may be shortly stated to consist in causing the wheel which bears the paddles to revolve on one centre, and the radial arms which move the paddles to revolve on another centre. Let  $A B C D E F G H I K L$  be the polygonal circumference of the paddle-wheel, formed of straight bars, securely connected together at the extremities of the spokes or radii of the wheel which turns on the shaft which is worked by the engine; the centre of this wheel being at  $o$ . So far this wheel is similar to the common paddle-wheel; but the paddle-boards are not, as in the common wheel, fixed at  $A B C$ , &c., so as to be always directed to the centre  $o$ , but are so placed that they are capable of turning on axles which are always horizontal, so that they can take any angle with respect to the water which may be given to them. From the centres, or the line joining the pivots on which these paddle-boards turn, there proceed short arms  $k$ , firmly fixed to the paddle-boards at an angle of about  $120^\circ$ . On a motion given to this arm  $k$ , it will therefore give a corresponding angular motion to the paddle-board, so as to make it turn on its pivots. At the extremities of the several arms marked  $k$  is a pin or pivot, to which the extremities of the radial arms  $l$  are severally attached, so that the angle between each radial arm  $l$  and the short paddle arm  $k$  is capable of being

## STEAM NAVIGATION.

changed by any motion imparted to *l*; the radial arms are connected at the other end with a centre, round which they are capable of revolving. Now, since the points *A B C*, &c., which are the pivots on which the paddle-boards turn, are moved in the circumference of a circle, of which the centre is *o*, they are always at the same distance from that point, consequently they will continually vary their distance from the other centre *p*. Thus, when a paddle-board arrives at that point of its revolution at which the centre

Fig. 14.

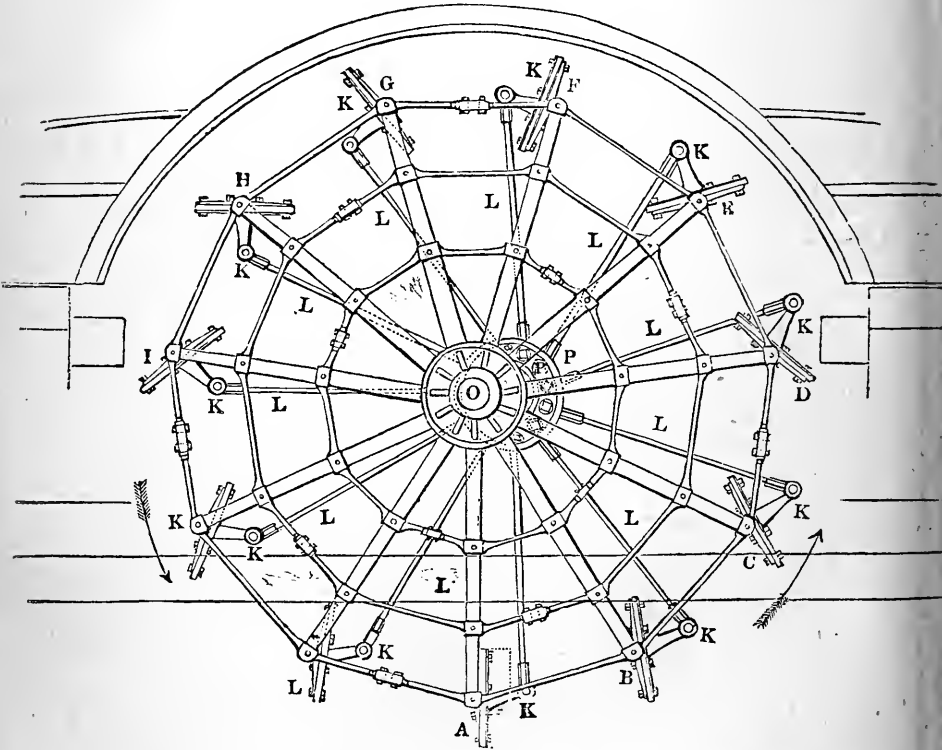

round which it revolves lies precisely between it and the centre *o*, its distance from the former centre is less than in any other position. As it departs from that point, its distance from that centre gradually increases until it arrives at the opposite point of its revolution, where the centre *o* is exactly between it and the former centre; then the distance of the paddle-board from the former centre is greatest. This constant change of distance between each paddle-board and the centre *p* is accommodated by the variation of the angle between the radial arm *l* and the short paddle-board arm *k*: as the paddle-board approaches the centre *p*, this gradually diminishes; and as the distance of the paddle-board increases, the angle is likewise augmented. This change in the magnitude of the angle, which thus accommodates the varying position of the paddle-board with respect to the centre *p*, will be observed in the figure. The paddle-board *p* is nearest to *p*; and it will be observed that the angle contained between *l* and *k* is there very acute; at *e* the angle between *l* and *k* increases,

## SPLIT PADDLES.

but is still acute; at *G* it increases to a right angle; at *H* it becomes obtuse; and at *K*, where it is most distant from the centre *P*, it becomes most obtuse. It again diminishes at *L*, and becomes a right angle between *A* and *B*. Now this continual shifting of the direction of the short arm *K* is necessarily accompanied by an equivalent change of position in the paddle-board to which it is attached; and the position of the second centre *P* is, or may be, so adjusted that this paddle-board, as it enters the water and emerges from it, shall be such as shall be most advantageous for propelling the vessel, and therefore attended with less of that vibration which arises chiefly from the alternate depression and elevation of the water, owing to the oblique action of the paddle-boards.

58. *Field's split paddles.*—In the year 1833, Mr. Field, of the firm of Maudslay and Field, constructed a paddle-wheel with fixed paddle-boards, but each board being divided into several narrow slips arranged one a little behind the other, as represented in fig. 15. These divided boards he pro-

Fig. 15.

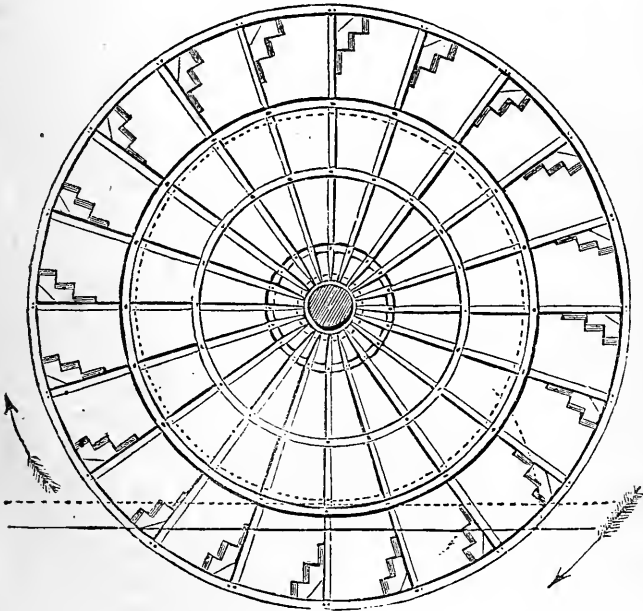

posed to arrange in such cycloidal curves that they must all enter the water at the same place in immediate succession, avoiding the shock produced by the entrance of the common board. These split paddle-boards are as efficient in propelling when at the lowest point as the common paddle-boards, and, when they emerge, the water escapes simultaneously from each narrow board, and is not thrown up, as is the case with common paddle-boards.

The number of bars, or separate parts into which each paddle-board is divided, has been very various. When first introduced, each board was divided into six or seven parts: this was subsequently reduced; and in the wheels of this form constructed for the government vessels, the paddle-boards consist only of two parts, coming as near to the common wheel

as is possible, without altogether abandoning the principle of the split paddle.

59. The paddle-wheels generally used in American steam-boats are formed, as if by the combination of two or more common paddle-wheels, placed one outside the other, on the same axle, but so that the paddle-boards of each may have an intermediate position between those of the adjacent one, as represented in fig. 16.

The spokes, which are bolted to cast-iron flanges, are of wood. These

Fig. 16.

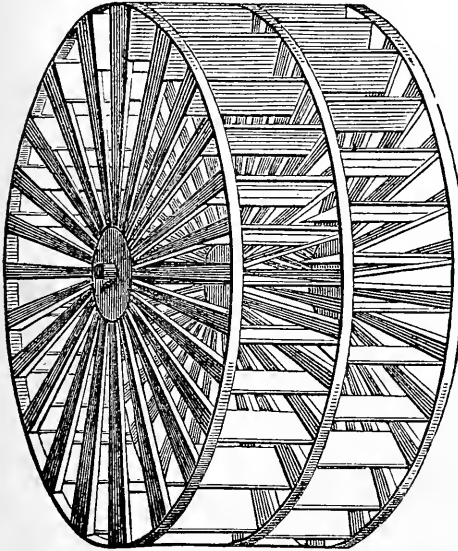

flanges, to which they are so bolted, are keyed upon the paddle-shaft. The outer extremities of the spokes are attached to circular bands or hoops of iron, surrounding the wheel; and the paddle-boards, which are formed of hard wood, are bolted to the spokes. The wheels, thus constructed, sometimes consist of three, and not unfrequently four, independent circles of paddle-boards, placed one beside the other, and so adjusted in their position, that the boards of no two divisions shall correspond.

The great magnitude of the paddle-wheels, and the circumstance of the navigation being carried on, for the most part, in smooth water, have rendered unnecessary, in America, the adoption of any of

those expedients for neutralising the effects of the oblique action of the paddles, which have been tried, but hitherto with so little success, in Europe.\*

60. The practical objections to the use of the feathering principle in general, go far to balance the advantages attending them. According to Mr. Bourne, whose skill and experience on this subject entitle his opinion to the highest respect, all expedients of this class are expensive, both to make and maintain. The wear and friction in such a multitude of joints is very considerable; and if any of the arms get adrift, or break, they will be whirled round like a flail, and may perhaps cut through the paddle-box, or even the vessel. If the injury be of such a nature that the wheels cannot be turned round (and this has sometimes happened), it will follow that the engines will be virtually disabled until the obstruction can be cleared away; and if the weather be very stormy, or the vessel be in a critical situation,

\* For a notice of the inland steam navigation of the United States, see "Railway Economy," chap. xvi. Also "Museum of Science and Art," vol. ii. p. 17.



she may be lost in consequence of her temporary derangement. Upon the whole, therefore, the application of feathering wheels to vessels intended to perform long voyages through stormy seas, appears to be of doubtful propriety. For channel trips, and in situations where the wheels can be carefully examined at short intervals, the risk is not so great; but in that case nearly the same benefits will be attained by increasing the length of the paddle-floats, and giving the wheels less dip. There is no material difference between the performance of a feathering wheel and that of a radial wheel, if the two wheels be of the same diameter, and if they have both a light dip with long narrow floats. And, as in sea-going vessels, the wheels must necessarily be of considerable diameter, and as there is nothing to prevent the other circumstances conducive to efficiency from being observed, it follows that in ocean-vessels radial wheels would be about as efficient as feathering wheels, but for the circumstance of a variable immersion. It is not necessary, however, that there should be much variation in the immersion if large vessels be employed, or if coal is more frequently taken on board during the voyage; and as neither of these alternatives is attended with the risk incident to the use of feathering wheels, they appear to be entitled to that preference which ultimately they are likely to obtain.

61. In oscillating engines the piston-rod is usually made one-ninth of the diameter of the cylinder, and the crank-pin is made about one-seventh of the diameter of the cylinder. The diameter of the paddle-shaft must have reference not merely to the diameter of the cylinder, but also to the length of the stroke of the piston, or, what is the same thing, to the length of the crank. If the square of the diameter of the cylinder in inches be multiplied by the length of the crank in inches, and the cube-root of the product be extracted, then that root multiplied by  $\cdot 242$  will give the diameter proper for the shaft in inches at the smallest part. The diameter of the trunnions is regulated by the diameter of the steam and eduction pipes, and these are each usually about one-fifth of the diameter of the cylinder; but it is better to make the steam trunnions a little less, and the eduction trunnions a little more, than this proportion. The steam and eduction pipes, where they enter their respective trunnions, are kept tight by a packing of hemp, which is compressed by a suitable ring or gland, tightened by screws. In land engines the air-pump and condenser are each made about one-eighth of the capacity of the cylinder, but in marine engines they are made somewhat larger.

62. Submerged propellers, whatever be their form, are exempt from many of the disadvantages which are common to every species of paddle-wheel. It will be evident that the effect of

such a propeller will be nearly the same, whatever position may be given to it in the water. However the ship may pitch or roll, or however unequal the surface of the sea may be, such a propeller will always produce the same backward current without any variation of effect.

The circumstances which prevent the co-operation of the power of steam with that of the sails in steam-vessels propelled by the common paddle-wheels, will not operate with submerged propellers, inasmuch as their effect is altogether independent of the careening of the ship.

63. But though this defect is remedied, the submerged propellers in general are still subject to objections, to which even the common paddle-wheel is not obnoxious. Being permanently submerged and liable to accident, fracture, and derangement from various causes, they are inaccessible, and cannot be repaired at sea. But, besides this, when the object in view is to take full advantage of the power of the sails at times when it is expedient to suspend the action of the machinery, the submerged propeller becomes an obstruction, more or less considerable, to the progress of the vessel. Various expedients have been contrived, and in some instances practically applied, by which the propeller can be lifted out of the water when it is not in operation, but hitherto this has not been found practically convenient, at least for commercial vessels, though sometimes adopted for vessels of war.

64. The screw-propeller is similar in form and mechanical principle to the hydraulic machine known as the screw of Archimedes. A cylinder placed at the bottom of the vessel, and in the direction of the keel, is surrounded by a spiral blade similar, precisely, to the thread of a common screw, but projecting from it instead of being cut into its surface. If such a screw were turned in a solid, it would move forward through a space equal to the distance between two contiguous threads in each revolution; but the water, not being solid, yields more or less to the re-action of the screw, and consequently the screw moves forward through a space in each revolution less than the distance between two contiguous threads.

65. The distance between two contiguous threads is technically called the *pitch* of the screw; a term, however, which is sometimes also used to express the angle formed by the blade of the screw with its axis, such angle supplying the means of calculating the distance between such contiguous threads. We shall here, however, use the term *pitch* in the former sense. The difference between the *pitch* of the screw and the space through which the screw actually progresses in the water in one revolution is called the *slip*.

In the first vessels to which screw-propellers were applied, the screw consisted of a single spiral blade, which made one convo-

## SCREW-PROPELLERS.

lution only round the cylinder. This arrangement was subsequently modified, and two convolutions and a half of a double-threaded screw were used instead of one complete convolution of a single-threaded screw. This plan has been occasionally varied, a smaller fraction of a convolution being sometimes used.

It is found in practice that the amount of the slip in general varies from one-tenth to one-twentieth of the pitch; that is to say, the actual velocity of the screw through the water is from one-tenth to one-twentieth less than it would be if the screw worked through a solid, or as an ordinary screw in its nut.

66. The screw-propeller is usually fixed upon an axis parallel to the keel of the vessel, and mounted in a space in the dead wood between the stern-post and rudder-post. It is usually suspended on a short shaft, carried by a metal frame, having a rack on each side, in which endless screws work, by means of which the frame supporting the propeller can be lifted out of the water, so that the screw can be repaired if required or a new one introduced without putting the vessel into dock.

To enable the water to react in a manner analogous to that in which the nut reacts upon the common screw, the thread requires to be much deeper than if the screw worked in metal or wood, and the pressing surface to be proportionally larger. Accordingly screw-propellers are always made with much smaller central bodies, and a much deeper thread than the common screw. They are also made as large as possible in diameter, extending generally from the keel to a point nearly level with the surface of the water. Thus the diameter of the screw is little less than the draft of the vessel.

67. To convey some idea of the forms of screw-propellers, we have represented in the annexed figures the forms of some of the propellers most generally adopted.

In fig. 17 is represented a perspective view of Smith's screw-propeller, with two threads or blades, as finally adopted in her Majesty's steamer

Fig. 17.



Fig. 18.



Fig. 19.



Fig. 20.

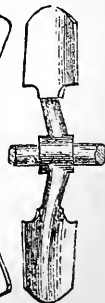

“Rattler.” This is the form of the screw now most generally adopted in the

## STEAM NAVIGATION.

British navy. An end view or an elevation looking against the end of the shaft is shown in fig. 18. Smith's three-thread screw differs from this only in having three arms instead of two.

Fig. 21.

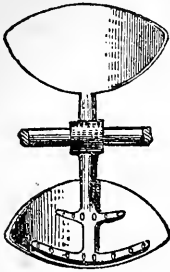

Fig. 23.

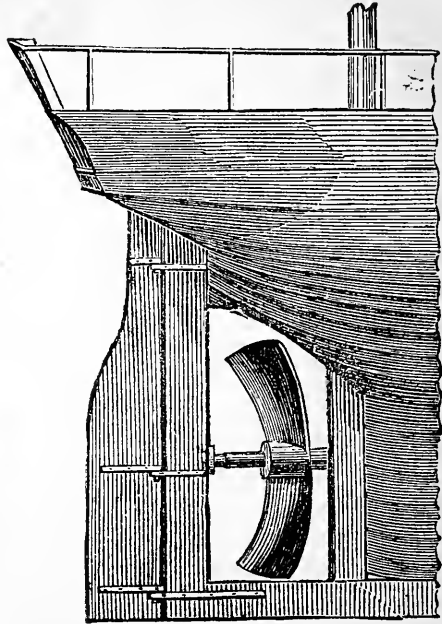
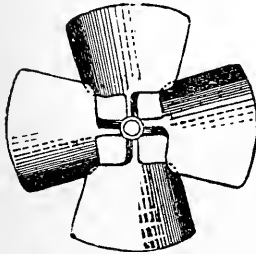

Fig. 22.



Strimman's propeller is shown by an end view in fig. 19, and a side view in fig. 20.

Sunderland's propeller, as applied in the "Rattler," is shown in fig. 21, consisting of two flat plates, set upon arms, fixed to an axis revolving beneath the water in the stern. In the "Rattler," this propeller was placed in the stern in the dead wood, instead of projecting out behind the rudder as in the Sunderland arrangement.

In fig. 22 is represented Woodcroft's propeller, also applied in the "Rattler." This has four arms or blades, and the pitch of the screw at its leading edge is less than the pitch at its terminal edge.

In fig. 23\* is represented, as set in the stern of the vessel, the form of Hodson's screw, from which excellent results are said to have been obtained. This form of screw has been much used in France, Holland, and other countries of the continent; and in some cases in which the common screw has been superseded by a screw of this description, an improvement has been obtained in the speed amounting to about a knot an hour. Such results will only ensue when the original screw has been of inadequate dimension, so that the loss by slip has been large in amount; and the more the slip is reduced, the less will become the advantage of any deviation from Smith's form of screw with uniform pitch.†

\* Figs. 17 to 23 have been taken with the permission of the author from Mr. Bourne's work "on the Screw-propeller."

† Bourne "on the Screw-propeller," p. 136.

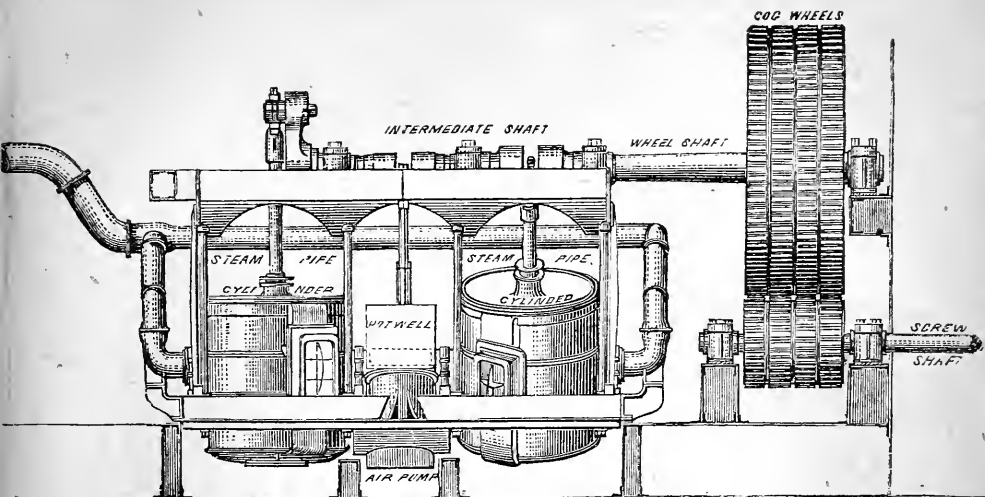

Fig. 26.

## STEAM NAVIGATION.

### CHAPTER IV.

68. Effect of the screw-propeller reaction on the vessel.—69. Their best practical proportion.—70. Their varying pitch.—71. Relative advantages of screw and paddle-wheels.—72. Their effects in long sea-voyages.—73. Experiments with the “Rattler” and “Alecto.”—74. These experiments continued.—75. Admiralty experiments.—76. Government report.—77. Application of the screw in the commercial marine.—78. Application of screw to mail-vessels.—79. Geared and direct action.—80. Geared-engines.—81. Fairbairn’s internal gearing.—82. Subdivision of the power among several cylinders.—83. Protection from shot.—84. Regulation of slides.—85. Relative speed of screw and vessel.—86. Engines of the “Great Britain.”—87. Engines of the “Arrogant” and “Encounter.”—88. Various forms of screw-engines.—89. Cross action of H. M.’s screw steam-packet “Plumper.”—90. Auxiliary steam-power.—91. Effect of screw-vessels head to wind.—92. Nominal and real horse-power.—93. Official tables of the strength of the steam-navy.

68. THE screw, whatever be its form or structure, in driving the water sternwards, sustains a corresponding reaction which takes effect upon the screw-shaft, and produces an equivalent pressure on its bearing to its anterior extremity. The force of this forward thrust of the screw-shaft, combined with its velocity of rotation, produced, in the earlier screw-vessels, considerable inconvenience in consequence of the friction attending it, and several cases

occurred where the end of the shaft being rendered white-hot was actually welded to the steel plate against which it pressed, although a stream of water was continually running over the surface in contact. Various expedients have since then been proposed for remedying this inconvenience. One of these was to let the end of the shaft enter a tight cylinder of oil in the manner of a piston, so that it would press against a liquid instead of a solid. Another was to place a large collar upon the shaft which should press against a number of balls or small rollers like those of a swivel-bridge. Neither of these plans, however, appears to have been so successful as to get into general use, and one or other of the following expedients is now generally adopted. The thrust of the screw-shaft is received either upon a number of collars or a series of discs placed at the end of the shaft and resting on a cistern of oil which is usually cast upon the base plate or some solid part of the engine, and its end is sufficiently strong to bear the thrust of the screw. Interposed, however, between the end of the cistern and that of the shaft are two, three, or more discs of metal, generally two inches thick, and having diameters equal to that of the shaft. A bolt passes through their centre to keep them in line, but they are each free to revolve in the bolt, and where the shaft passes out of the cistern a collar of leather is applied to prevent the oil from escaping. It will be obvious from such an arrangement that if the end of the shaft which it presses upon the discs begins to heat from undue friction, it will revolve with somewhat more difficulty, and will consequently carry the first disc round with it. The rubbing surfaces are therefore no longer at the end of the shaft, but at the first disc and the second disc. In fact the rubbing surfaces, instead of being limited to a single disc, are distributed over several. Those surfaces which begin to heat, and consequently to stick, will cease to rub, whereby they will speedily become cool again and their efficiency consequently be restored. (See Mr. Bourne's article on the "Screw-Propeller" in the Appendix to Brande's "Dictionary of Science and Art.")

69. According to the same authority the best practical proportion and form of screw-propellers for mercantile vessels are as follows. Those of three blades are on the whole preferable. The diameter should be as large as possible. When the area of the circle described by the extremity of the arms of the screw has one square foot for every two-and-a-half square feet in the area of the midship section immersed, a very efficient performance is obtained. The pitch of the screw should be equal to its diameter, or perhaps a little exceed it, and the length measured parallel to its shaft should be about one-sixth of a convolution. Thus, for

## PROPORTIONS OF SCREWS.

example, in the case of a screw 12 feet in diameter, the pitch would be from 12 to 14 feet, and the length about 2 feet.

70. Screws are generally made with one uniform pitch, and their blades are set at right angles to the shaft. A gradual increase of pitch towards the leading end of the screw is, however, recommended. Thus, the pitch of the centre should be about 10 per cent. less than at the circumference, for the centre should merely screw through the water, without producing any reaction or propelling force. The efficient part being near the circumference, it is also recommended that the blades, instead of being precisely perpendicular to the shaft, should be inclined a little sternwards, so as to produce a tendency in the water which they drive backwards to converge to a point. It is assumed that this convergent tendency may balance the divergent tendency due to the centrifugal force attending the revolution: so that the two forces being in equilibrium will cause the water to be projected backwards from the screw in a cylindrical column. In the case of the ordinary screw, with blades at right angles to the shaft, the water projected backwards assumes the figure of the frustum of a cone, and a certain proportion of the power is thereby lost.

71. The relative advantages of screw and paddle-propellers depend in a great degree upon the immersion. It appeared from experiments made on a considerable scale with steamers of the Royal Navy, that in deep immersion the screw has an advantage over the paddle-wheel of one-and-a-half per cent.; but that, with medium immersion, the paddle-wheel had an advantage of one-and-three-quarters per cent. over the screw, an advantage which was augmented to four-and-three-quarters per cent. for light immersions. It appears, therefore, that the screw-propeller has a certain advantage over the paddle when the vessel is deep in the water, and that, on the other hand, the paddle gains an advantage over the screw in proportion as the immersion is less.

72. In long sea voyages, where the immersion is liable to considerable variation by reason of the lightening of the vessel owing to the consumption of the fuel, the screw will have the advantage over the paddle in the commencement of the voyage, and the paddle over the screw towards the end of it. In rough weather, where, by the rolling and pitching of the vessel, the paddle-wheels are liable at one time to be deeply plunged in the water, and at another to be raised out of it, the screw will have an obvious advantage.

73. In his work upon the screw-propeller, Mr. Bourne has given the details of a series of important experiments made with H. M. steamers "Rattler" and "Alecto," to determine the relative advantages of screw and paddle-wheels against a head wind. The result of these experiments seemed to prove, that

## STEAM NAVIGATION.

under such conditions the screw is less efficient than the paddle ; for though both vessels attained the same speed of four knots against a strong head wind, yet, in the case of the "Alecto," this performance was attained with a velocity of the engine of 12 strokes per minute, whereas in the "Rattler" it was only attained with a velocity of the engine of 22 strokes per minute. It follows, therefore, that a screw-vessel in proceeding head to wind will require 1·8 times, or nearly twice the quantity of fuel to do the same amount of work. The screw, in fact, revolves at nearly the same velocity whether the wind is adverse or favourable, or whether the vessel is lying at anchor ; and this is a serious defect in the case of vessels intended to encounter adverse winds. In the case of vessels, however, which use the screw only as a resource in calms, or as an auxiliary to the sails, this disadvantage will not be experienced, since such vessels have no pretensions to the capability of proceeding in direct opposition to a strong head wind.

74. Among the experiments made with the "Alecto" and "Rattler," some of the most interesting and important were directed to the determination of the relative towing powers of the screw and paddle-wheel. For this purpose the two ships were lashed stern to stern, and the engines of both were set to work so as to make them draw the connecting chain in opposite directions. In these and all other cases where screw and paddle-vessels of equal power and size have been thus connected, the screw-vessel has preponderated, and towed the paddle-vessel as soon as the engines were set to work.

When the "Rattler" and "Alecto" were lashed together in this manner, the "Alecto's" engines were set on first, and she was allowed to tow the "Rattler" at the rate of two knots an hour. The "Rattler's" engines were then set on. In five minutes the two vessels became completely stationary. The "Rattler" then began to move ahead, and towed the "Alecto" against the whole force of her engines, at the rate of 2·8 knots per hour. In like manner the "Niger" towed the "Basilisk" astern, in opposition to the force of her engines at the rate of 1·1 knots per hour. The natural inference from this experiment would be that the screw is more suitable for towing than the paddle ; yet this inference is not confirmed by the experiment, for when the "Niger" and "Basilisk" were each set to tow the other alternately, in the usual manner in which a steamer tows a ship, it was found that the "Niger" towed the "Basilisk" at a speed of 5·63 knots, with 593·9 horse-power, and that the "Basilisk" towed the "Niger" at the rate of 6 knots, with 572·3 horse-power. The paddle-vessel, therefore, accomplished in towing the largest speed with the least power. It has also been found that when a paddle



## ADMIRALTY EXPERIMENTS.

and screw-vessel set stern to stern push one another instead of pulling one another, the paddle-vessel preponderates, whereas, if they pull, the screw-vessel preponderates. These circumstances seem to show that the power of a screw-vessel to tow a paddle-vessel astern, when the two are tied together, does not arise from any superior tractive efficacy of the screw itself, but is due to the centrifugal action of the screw, which raises the level of the water at the stern, so that the vessel gravitates down an inclined plane.\*

75. The first experiments tried by the Admiralty with the screw-propeller were made in 1840-41; and in the next three years, 1842-44, eight screw vessels were built. This number was augmented by twenty-six in 1845. In 1848 there were not less than forty-five government screw-steamers afloat; and since that time, and more especially since the commencement of the war with Russia, the increase of the screw-steam navy has gone on at a rate which justifies the conclusion that ere long no vessel of war, of whatever class, in the British navy will be unprovided with the power, to a greater or less extent, of steam propulsion.

76. In a government official report of the results of various trials of the performance of screw-steamers, dated so far back as May 1850, before that propeller had yet reached its present state of perfection, it is stated as then highly probable that fine sailing vessels, fitted with auxiliary screw-power, would be found able, if not to rival, at least to approach, full-powered and expansively acting steam-ships, in respect of their capability of making a long voyage with certainty and in a reasonably short time.

“Another application of the screw, although inferior in general importance to its application as a propeller to ordinary ships,” says the same report, “is certainly deserving of more attention than is commonly paid to it, namely, as a manœuvrer to those large ships in which engines of considerable power cannot be placed, or in which it is considered unadvisable to place them. No doubt can be entertained of the efficiency of such an instrument worked by an engine of even fifty horse-power. The full extent, however, of its utility cannot perhaps be thoroughly appreciated until it shall have been extensively used in her Majesty’s navy.”

Since the date of this report that experience which was wanted has been obtained, and the extensive use of the screw has been adopted, and the results fully confirm all those anticipations.

77. But it is not only in her Majesty’s navy, but in the national commercial marine, and not only as an auxiliary propeller, but as an independent and most efficient agent of propulsion, that the screw has been found to answer in practical navigation. In 1849,

\* Bourne “on the Screw-propeller,” Chap. IV.

before it had yet attained all its present degree of perfection, it was in extensive operation under the direction of the General Screw Shipping Company. Seven vessels belonging to that company were in operation during the twelve months ending 31st December, 1849, during which time they performed 170 voyages, being an average of about  $24\frac{1}{2}$  voyages per vessel. The total distance run was 110849 geographical miles, being at the average rate of 15835 miles per vessel, and about 648 miles per voyage. The average speed was 8 to  $8\frac{1}{2}$  geographical miles per hour, and only one casualty, and that one in the Thames, occurred during the year.

The speed of the best and most recent of these vessels in still water, running the measured mile in the long reach of the Thames, was found to be 9.68 knots per hour.

78. Practical authorities have suggested, that the greatly increased and rapidly increasing number of screw ships running between the British and American ports, suggests the expediency of a revision of the post-office contracts, with a view to public economy, without any real sacrifice of efficiency. It is considered that no difference of time worthy of consideration now prevails between the passages of the mail-packets and the screw-vessels; but even admitting a difference, it is certainly not so great as that which exists between the speed of the mail and that of the express trains on railways. If then the mail contracts on the iron lines are sufficiently well performed by the trains of second-rate speed, why may not the like contracts on the lines of water be similarly executed, where the difference of cost would be enormous, and the difference of speed comparatively insignificant.

It is obvious that these observations are applicable not only to the lines of steamers which carry the United States and Canadian, but also to the West Indian, and in a word, to all the ocean lines.

79. But when screw propulsion is used, a much greater velocity of revolution is required to be given to the screw-shaft,—a much greater number of revolutions per minute being necessary, than the greatest number of strokes per minute made by any steam-engine of the common construction. It was necessary, therefore, in adopting screw propulsion, either to provide expedients by which the velocity of rotation of the screw-shaft shall be greater than that of the crank-shaft, in the requisite proportion, or to modify the form and proportions of the steam cylinders and their appendages, so that the number of strokes per minute should be augmented, so as to be equal to the necessary number of revolutions per minute of the screw-shaft.

Both these contrivances have been adopted by different constructors. Engines constructed on the former plan are called *geared engines*, and those constructed on the latter *direct acting engines*.

## GEARED-ENGINES.

80. In geared engines the cranks are formed on one shaft, and the screw fixed upon another, the directions of the two shafts being parallel. On the crank-shaft is fixed a toothed-wheel, which works in a smaller one, called a pinion, fixed on the screw-shaft. Thus in fig. 24, A may be regarded as the pinion fixed on the screw-shaft, and B the wheel fixed on the crank-shaft, the teeth of the one being engaged in those of the other at c.

Fig 24.

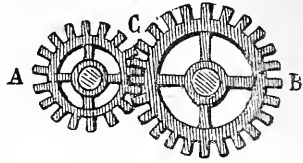

It is evident that the velocity of rotation of A will be greater than that of C in the same proportion as that in which the number of teeth in C is greater than the number of teeth in A. It is always possible, therefore, with a given speed of the crank-shaft, to impart a speed greater in any required proportion to the screw-shaft by regulating in a corresponding manner the proportion of the teeth in those geared wheels.

81. One of the objections to the use of gearing in sea-going vessels is the liability of the teeth to rapid wear, and to fracture from sudden shocks in a rough sea. In order to diminish the risk of this by distributing the pressure over a greater number of teeth, Mr. Fairbairn has adopted in large screw-engines, constructed by him for the Royal Navy, a system of internal gearing in which the crank-shaft wheel has the teeth on its internal periphery, the screw-shaft pinion revolving within it, as shown in fig. 25.

In screw-vessels of war, all the machinery should be placed below the water-line, so as to be as effectually protected from shot as the screw itself is.

82. When direct-acting engines without gearing are applied to screw-propelled vessels, the reciprocating motion of the piston

Fig. 25.

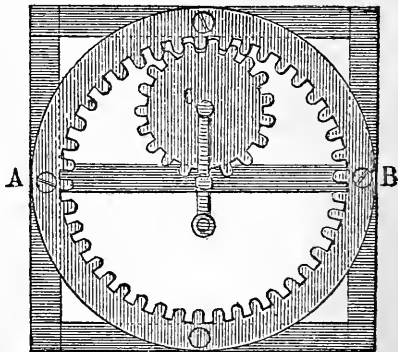

must be equal to the velocity of the screw, that is, the number of strokes per minute of the piston must be equal to the number of revolutions per minute of the screw. Now to render this compatible with a sufficiently moderate rectilinear motion of the piston, the length of the stroke must bear a very small proportion to the diameter of the cylinder. This has, in many cases, rendered it necessary in such vessels to subdivide the power of the engines among four smaller cylinders, all the pistons being directly attached to cranks on the screw-shaft instead of producing it by two larger cylinders, in which an unmanageable proportion must be adopted between the diameter and the stroke.

Another advantage derived from this subdivision of power is, that

a number of small cylinders, ranged often in a horizontal position on either side of the screw-shaft, allow of the play of all the reciprocating parts within a small height, so as to keep the whole below the water-line.

83. Another expedient for the protection of the machinery from shot, is to place the coal-boxes on each side of it, and between it and the timbers of the vessel, so that before a shot could reach it, the fuel must be thoroughly penetrated.

84. The efficiency of a marine, like that of a land engine, depends on the exact regulation of the slides by which the admission and escape of the steam to and from the cylinder is governed. In all cases the steam should be admitted at either end of the cylinder a little before the arrival of the piston there, and at the same moment the escape to the condenser should be stopped. By this means the piston, on arriving at the end of the stroke, is received by the steam just admitted mixed with a small portion of uncondensed steam and air, whose escape to the condenser has been intercepted. These form a sort of air-cushion, against which the stroke of the piston is broken, an effect which is called by the practical men, not inappropriately, *cushioning* the piston. When the steam is worked expansively, the slides must be capable of such regulation as to shut it off at any required fraction of the entire stroke, and when not so worked, it ought at all events to be shut off before the stroke is quite completed, so as to relieve the piston from its action a little before the termination of the stroke.

It is easy to conceive that, to accomplish all these points, the slides require the nicest imaginable adjustment; and the openings for the admission and escape of steam, the most exact regulation both as to magnitude and position.

85. It will be evident on comparing the pitch of the ordinary screw with the progressive rate at which the vessel moves through the water, that, to produce the necessary speed, a much greater velocity of rotation must be imparted to the screw, than is consistent with the ordinary rate at which steam-engines work. It has been already shown that this great velocity of rotation has been obtained either by the interposition of gearing so adapted as to augment the velocity, or by assimilating the engine in its form and structure to a locomotive.

86. An example of a marine-engine, by which the necessary velocity is imparted to the screw-shaft, by means of intermediate gearing, is presented in the case of the screw-engine constructed by Messrs. Penn and Son, for the "Great Britain" steam-ship. The engines which are represented in fig. 26, are constructed on the oscillating principle, and are almost identical with the paddle-wheel engines, built by the same firm for the "Sphinx."

## ARROGANT AND ENCOUNTER.

The "Great Britain" is a vessel of 3500 measured tons; her tonnage by displacement being 2970, and her draught 16 feet. The diameter of the cylinder is  $82\frac{1}{2}$  inches; the length of stroke, 6 feet; the nominal power, 500 horses; the diameter of the screw,  $15\frac{1}{2}$  feet; its pitch, 19 feet, and its length, 3 feet 2 inches. The screw has three arms or blades, and its shaft is connected with the crank-shaft by a pair of toothed-wheels, which have a multiplying power of 3 to 1, so that for every stroke of the piston, the screw-shaft revolves three times. The ample proportion of  $17\frac{1}{2}$  square feet of heating surface per nominal horse-power, is provided in the boiler.

The crank-shaft, being put in motion by the engine, carries round the great cog-wheel, or combination of cog-wheels, which are fixed upon it; and this wheel acting on smaller ones called pinions, on the screw-shaft, impart to the latter the threefold velocity of revolution just mentioned.

87. As an example of screw-propelling engines working without gearing, we give in fig. 27 those constructed by Messrs. Penn and Son for H. M.'s screw-steamers "Arrogant" and "Encounter." In this case the cylinders are horizontal, and are traversed through the centre by a pipe or trunk, upon which the piston is cast. This trunk is projected through both ends of the cylinder—the orifices through which it passes being rendered steam-tight by proper packing. One end of the connecting-rod is attached to the centre of the trunk, the other end being connected with the crank, which is formed directly upon the screw-shaft. The air-pump lies in a horizontal position, is double-acting, and placed within the condenser. A large pipe, called the eduction pipe, leads from the cylinder to the condenser, where the condensation is produced by a jet of cold water, and the warm water resulting from the process is ejected by the air-pump through the waste-pipe, and discharged overboard. In fig. 27 one cylinder and one air-

Fig. 27.

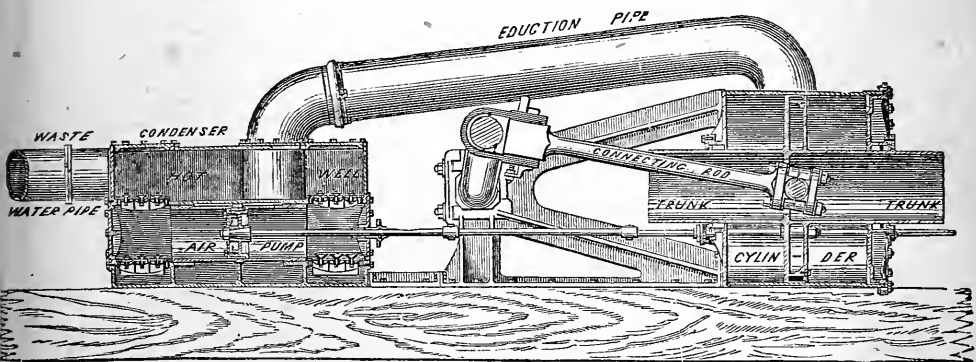

pump only are represented, but it must be understood that there are two, precisely similar to each other, placed side by side. The valves by which the water is admitted to the air-pump from the condenser, and those by which it passes from the air-pump to the hot well and waste-pipe, consist of several discs of caoutchouc kept down by a central bolt, so as to cover radial slits or orifices in a perforated plate. These valves are found to operate without noise or shock, notwithstanding the high speed at which the engine must work, in order to give the necessary velocity to the screw-shaft without intervening gearing. The diameter of the cylinder of the "Arrogant" and "Encounter" is 60 inches, and the diameter of the trunk 24 inches; the latter being deducted from the former, leaves an effective

piston area equal to that of a piston 55 inches in diameter. In the "Arrogant" the length of stroke is 3 feet, and in the "Encounter" it is 2 feet 3 inches. The nominal power of both engines is 360 horses; and the diameter of the "Arrogant's" screw is 15 feet 6 inches, that of the "Encounter" being 12 feet. The pitch of both is 15 feet, and the length 2 feet 6 inches. The "Arrogant" is a vessel of 1872 tons burden, and the "Encounter" of 953 tons. The whole machinery, including the boilers, is placed below the water line, so as to be protected from shot.\*

88. The forms of screw-propelling engines, whether they act on the screw-shaft by intermediate gearing or directly, are infinitely various. Drawings of not less than 15 different forms of geared-engines, and the like number of direct acting engines, are given in two large plates prefixed to Mr. Bourne's work on the screw-propeller, to which we must refer those who require information of this detailed description. In the vessels of the Royal Marine generally the cylinders are placed upon the sides, so that, by diminishing the total height of the machinery above the floor on which it rests, it may be kept below the water-line. In commercial vessels a form of engines is frequently employed resembling the land beam-engines, with the cylinder at one end of the beam, and the connecting-rod at the other. In such cases the connecting-rod extends downwards from the end of the beam to the crank. In either case the cylinder is inverted, and the connecting-rod proceeds from the end of the piston-rod to turn the crank, the end of the piston-rod being of course steadied by suitable guides. According to Mr. Bourne, the construction of the engines described above in the case of the "Arrogant" and "Encounter" is, on the whole, the best for screw-vessels, but he thinks it might be preferable to put the trunk into the air-pump instead of the cylinder. He considers also that the condenser might be dispensed with, and the condensations performed in the air-pump. In that case the flow of water to and from the air-pump might be governed by a slide-valve, similar to that which is employed to regulate the admission and escape of steam to and from the cylinder. It seems probable that slide-valves may be brought into general use for pumps of every sort, but in the case of ordinary ones for raising water these valves need not be like the common slide-valves, which in fact are not well adapted to give sufficient area for such purposes, but may consist of a short wide cylinder with gridiron orifices revolving slowly at the top and bottom of the air air-pump.

89. The general arrangement of the machinery and fuel in screw-propelled vessels of the Royal Navy is illustrated by the transverse section of H.M.'s screw steam-packet "Plumper," shown in fig. 28.

\* Figs. 26 and 27 are copied, with the permission of the publisher and the author, from Brande's "Dictionary of Science and Art," to which the

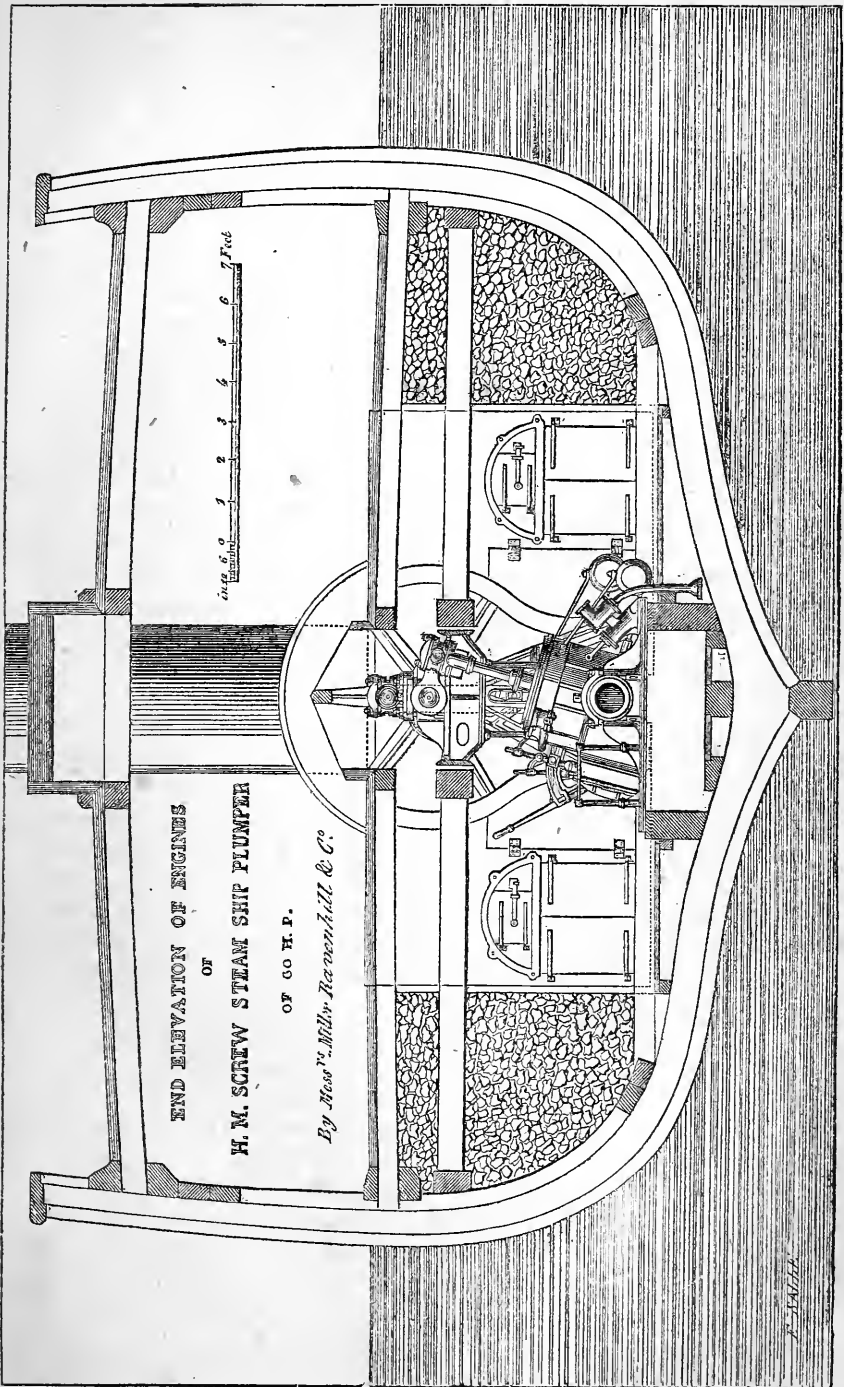

Fig. 28.

## STEAM NAVIGATION.

90. The question of auxiliary steam power to be used occasionally, as well for commercial as for war purposes, is one of the highest importance and interest, and one, moreover, which experience has not yet enabled us perfectly to understand and elucidate. For commercial purposes the saving of fuel, when the vessel has favourable winds, and the adaptation of her structure to the conditions necessary for a sailing-vessel, is of the highest importance; and in naval warfare a propelling power, however inadequate it may be for constant propulsion and the maintenance of high speeds in long voyages, may nevertheless be all-sufficient for conducting vessels into action or into hostile ports.

91. It has been already stated on the authority of Mr. Bourne, and as the result of experiments made on a large scale, that screw-vessels intended to go head to wind and work against head-seas, are not as efficient with the same consumption of fuel as paddle-wheel vessels. Under the combined operation of sails and steam, however, they are generally as efficient, and, when deeply laden, more so. A screw-vessel being divested of paddle-boxes partakes more of the character of a sailing-ship; nevertheless, from the experiments made with the "Niger" and "Basilisk," it does not appear that a screw-vessel is more efficient under sails than a paddle-vessel, though such a result may naturally be expected. The advantages, therefore, which attend the use of screw-propelling engines as an auxiliary power, do not result from any superiority of the screw as a propeller, nor from the increased facility which it presents for the application of sails, but are to be ascribed to the late employment in screw-vessels of wind-power which costs nothing, instead of steam-power which costs much, and also to the maintenance of lower rates of speed than are thought necessary in paddle-wheel vessels. The screw is a less cumbrous propeller than the paddle, and since it permits a much higher speed of the engine, a greater engine power may be compressed in a smaller compass.

On the whole, therefore, the screw for all the purposes of auxiliary propulsion is much to be preferred; nevertheless it must be understood that its superior eligibility is not so much due to its greater efficiency, as to the greater convenience in the application of auxiliary steam-power which its employment affords.

92. The horse-power of marine engines is either nominal or real. The nominal power is estimated by assuming a certain average effective pressure of steam, and a certain average linear velocity

reader is referred for a great mass of important details, for which we cannot here afford space. Still further information on the same subject may be found in Mr. Bourne's work "on the Screw-propeller" already quoted, that gentleman being also the author of the article in Brande.



## TABLES OF STEAM NAVY.

of the piston. The pressure multiplied by the velocity gives the effective force of the piston, or, what is the same, of the engine exerted through a given number of feet per minute; and since the force called a horse-power means 33000 lbs. acting thus one foot per minute, it follows that the nominal power of the engine will be found by dividing the effective force exerted by the piston, multiplied by the number of feet per minute through which it acts, by 33000.

It is assumed in all Admiralty contracts, and generally also in those of the commercial marine, that, after deducting from the total pressure of steam in the boiler that portion which is neutralised by the gases and uncondensed steam in the condenser, the friction of the moving parts and all other sources of resistance, the actual available or effective pressure of steam upon the piston is at the rate of 7 lbs. per square inch of piston surface. The total nominal effective action of the piston in pounds will therefore be found by multiplying the number of square inches in the area of the piston by 7.

93. In the following tables, obtained from the government authorities, will be found a complete statement of the strength of her Majesty's steam navy up to the 1st of April, 1856.

By Table I. it appears that the number of line-of-battle ships fitted and fitting with the screw-propeller was then 43, carrying a total number of 3797 guns, and propelled by engines of the collective power of 22950 horses. This is at the average rate of  $88\frac{1}{3}$  guns, and 533 horses per vessel; the proportion of guns to horses being about 6 horses per gun.

By Table II. it appears that the number of frigates and mortar-ships was 24, carrying collectively 889 guns, and propelled by engines of 10560 horse-power, being at the average rate of 37 guns, and 440 horses per vessel; the proportion of horses to guns being about 12 horses per gun.

By Table III. it appears that there were 90 war steamers fitted with paddle-wheels, carrying the total number of 500 guns, and propelled by engines having the collective power of 24640 horses, being at the average rate of  $5\frac{1}{2}$  guns, and 274 horses per vessel; the proportion of horse-power to guns being about 50 horses per gun.

By Table IV. it appears that there were 76 smaller vessels fitted with screw-propellers, consisting of corvettes, sloops, and despatch boats, carrying in all 761 guns, and propelled by engines of the collective power of 16202 horses, being at the average rate of 10 guns and 213 horses per vessel; the proportion of horse-power to guns being therefore about 21 horses per gun.

In Table V. is given the number and power of the troop and store-ships, water-tanks, &c.; in Table VI. a statement of the

## STEAM NAVIGATION.

steam-propelled gun-boats ; and in Table VII. a general summary of the entire steam navy.

In Table VIII. is given a statement of the commercial steam navy in March 1853.

### TABLE I.

*Line-of-Battle Ships fitted and fitting with the Screw-Propeller in Her Majesty's Navy.*

Name.			Name.			Name.						
	Guns.	Horse Power.		Guns.	Horse Power.		Guns.	Horse Power.				
1	Agamemnon . . .	91	600	Brought forward	1253	7500	Brought forward	2475	14700			
2	Ajax . . . . .	60	450	16	Exmouth . . . .	90	400	20	Orion . . . . .	91	600	
3	Algiers . . . . .	90	450	17	Gibraltar . . . .	100	800	31	Pembroke . . . .	60	200	
4	Bleuheim . . . .	60	450	18	Hannibal . . . . .	90	450	32	Princess Royal . .	91	400	
5	Brunswick . . . .	80	400	19	Hastings . . . . .	60	200	33	Renown . . . . .	90	800	
6	Cæsar . . . . .	91	400	20	Hawke . . . . .	60	200	34	Revenge . . . . .	90	800	
7	Centurion . . . .	80	400	21	Hero . . . . .	90	600	35	Royal Albert . . .	121	500	
8	Colossus . . . . .	80	400	22	Hogue . . . . .	60	450	36	Royal George . . .	102	400	
9	Conqueror . . . .	100	800	23	Howe . . . . .	120	1000	37	Royal Sovereign . .	120	1000	
10	Cornwallis . . . .	60	200	24	Irresistible . . .	80	400	38	Russell . . . . .	60	200	
11	Cressy . . . . .	80	400	25	James Watt . . . .	91	600	39	St. Jean d'Acree . .	101	600	
12	Donegal . . . . .	100	800	26	Majestic . . . . .	80	400	40	Sanspareil . . . .	70	350	
13	D. of Wellington .	131	700	27	Marlborough . . .	130	800	41	Victor Emanuel . .	90	600	
14	Edgar . . . . .	90	600	28	Mars . . . . .	80	400	42	Victoria . . . . .	120	1000	
15	Edinburgh . . . .	60	450	29	Nile . . . . .	91	500	43	Windsor Castle . .	116	800	
1253			7500	2475			14700	Total . . . . .			3797	22950

### TABLE II.

*Frigates and Mortar-ships fitted and fitting with the Screw-Propeller in Her Majesty's Navy.*

Name.			Name.			Name.						
	Guns.	Horse Power.		Guns.	Horse Power.		Guns.	Horse Power.				
1	Amphion . . . . .	34	300	Bt. forward	355	4140	Bt. forward	621	7350			
2	Ariadne . . . . .	30	350	10	Doris . . . . .	32	800	18	Liffey . . . . .	50	600	
3	Arrogant . . . . .	46	360	11	Emerald . . . . .	50	600	19	San Fiorenzo . . .	50	600	
4	Aurora . . . . .	50	400	12	Eurotas . . . . .	12	200	20	Sea-horse . . . . .	12	200	
5	Bacchante . . . .	50	600	13	Euryalus . . . . .	51	400	21	Shannon . . . . .	51	600	
6	Chesapeake . . . .	50	400	14	Forte . . . . .	50	400	22	Termagant . . . .	24	310	
7	Curaçoa . . . . .	30	350	15	Forth . . . . .	12	200	23	Topaz . . . . .	50	600	
8	Dauntless . . . . .	33	580	16	Horatio . . . . .	8	250	24	Tribune . . . . .	31	300	
9	Diadem . . . . .	32	800	17	Impérieuse . . . .	51	360	Total . . . . .			889	10560
355			4140	621			7350					

TABLE III.—A List of War Steamers in Her Majesty's Service fitted with Paddle-wheels.

Name.			Name.			Name.			
	Guns.	Horse Power.		Guns.	Horse Power.		Guns.	Horse Power.	
1	Alecto . . . . .	5	200	Bt. forward	112	7560	Bt. forward	233	15869
2	Albany . . . . .	4	100	32 Furious . . . . .	16	400	62 Penelope . . . . .	16	650
3	Ardent . . . . .	5	200	33 Fury . . . . .	6	515	63 Porcupine . . . . .	3	132
4	Arctelope . . . . .	3	260	34 Geyser . . . . .	6	230	64 Prometheus . . . . .	5	200
5	Argus . . . . .	6	300	35 Gorgon . . . . .	6	320	65 Rhadamanthus . . . . .	4	220
6	Asp . . . . .	5	50	36 Gladiator . . . . .	6	430	66 Redpole . . . . .	1	160
7	Avon . . . . .	3	160	37 Harpy . . . . .	1	200	67 Retribution . . . . .	28	400
8	Bann . . . . .	8	80	38 Hecate . . . . .	6	240	68 Rosamond . . . . .	6	280
9	Banshee . . . . .	2	350	39 Hecla . . . . .	6	240	69 Sampson . . . . .	6	467
10	Barracouta . . . . .	6	300	40 Hermes . . . . .	6	220	70 Salamander . . . . .	6	220
11	Basilisk . . . . .	6	400	41 Hydra . . . . .	6	220	71 Scourge . . . . .	6	420
12	Black Eagle . . . . .	6	260	42 Inflexible . . . . .	6	378	72 Shearwater . . . . .	8	160
13	Blood Hound . . . . .	3	150	43 Jackal . . . . .	4	150	73 Sidon . . . . .	22	560
14	Brune . . . . .	8	80	44 Kite . . . . .	3	170	74 Spiteful . . . . .	6	280
15	Bull Dog . . . . .	6	500	45 Leopard . . . . .	18	560	75 Spitfire . . . . .	5	140
16	Buzzard . . . . .	6	300	46 Lightning . . . . .	3	100	76 Sphinx . . . . .	6	500
17	Caradoc . . . . .	2	350	47 Lizard . . . . .	1	150	77 Stromboli . . . . .	6	280
18	Centaur . . . . .	6	540	48 Locust . . . . .	3	100	78 Styx . . . . .	6	280
19	Columbia . . . . .	6	100	49 Lucifer . . . . .	2	180	79 Tartarus . . . . .	4	136
20	Comet . . . . .	8	80	50 Magicienne . . . . .	16	400	80 Terrible . . . . .	21	800
21	Cuckoo . . . . .	3	100	51 Medea . . . . .	6	350	81 Triton . . . . .	6	350
22	Cyclops . . . . .	6	320	52 Medina . . . . .	4	312	82 Triton . . . . .	3	260
23	Dasher . . . . .	2	100	53 Medusa . . . . .	4	312	83 Valorous . . . . .	16	400
24	Dee . . . . .	4	200	54 Merlin . . . . .	6	312	84 Vesuvius . . . . .	6	280
25	Devastation . . . . .	6	400	55 Oberon . . . . .	3	260	85 Virago . . . . .	6	300
26	Dragon . . . . .	6	560	56 Odin . . . . .	16	560	86 Vulture . . . . .	6	470
27	Dover . . . . .	8	90	57 Osborne . . . . .	2	430	87 Weser . . . . .	6	160
28	Driver . . . . .	6	280	58 Otter . . . . .	3	120	88 Widgeon . . . . .	..	90
29	Firefly . . . . .	4	220	59 Pigmy . . . . .	3	100	89 Wildfire . . . . .	..	76
30	Firebrand . . . . .	6	410	60 Polyphemus . . . . .	5	200	90 Zephyr . . . . .	3	100
31	Fire Queen . . . . .	..	120	61 Pluto . . . . .	4	100			
		112	7560		283	15869	Total . . . . .	500	24640

TABLE IV.—Corvettes, Sloops, and Despatch Gun-vessels fitted and fitting with the Screw-Propeller in Her Majesty's Service.

Name.			Name.			Name.			
	Guns.	Horse Power.		Guns.	Horse Power.		Guns.	Horse Power.	
1	Alacrity . . . . .	16	200	Bt. forward	305	5700	Bt. forward	541	1090
2	Alert . . . . .	16	100	27 Flying Fish . . . . .	6	350	52 Plumper . . . . .	9	600
3	Ariel . . . . .	9	60	28 Fox Hound . . . . .	4	200	53 Pylades . . . . .	20	350
4	Archer . . . . .	14	202	29 Harrier . . . . .	17	100	54 Rattler . . . . .	11	200
5	Arrow . . . . .	4	160	30 Hesperus . . . . .	11	120	55 Recruit . . . . .	6	160
6	Assurance . . . . .	4	200	31 Highflyers . . . . .	21	250	56 Renard . . . . .	4	200
7	Beagle . . . . .	4	160	32 Hornet . . . . .	17	100	57 Rifleman . . . . .	8	100
8	Brisk . . . . .	14	250	33 Icarus . . . . .	..	..	58 Ringdove . . . . .	4	200
9	Cadmus . . . . .	20	400	34 Intrepid . . . . .	6	350	59 Roebuck . . . . .	6	350
10	Cameleon . . . . .	16	100	35 Lapwing . . . . .	4	200	60 Reward . . . . .	4	200
11	Challenger . . . . .	20	400	36 Lynx . . . . .	4	160	61 Satellite . . . . .	20	400
12	Charybdis . . . . .	20	400	37 Lyra . . . . .	8	60	62 Scout . . . . .	20	400
13	Clio . . . . .	20	400	38 Malacca . . . . .	17	200	63 Scylla . . . . .	20	400
14	Conflict . . . . .	8	400	39 Minx . . . . .	3	10	64 Sharpshooter . . . . .	8	202
15	Coquette . . . . .	4	200	40 Miranda . . . . .	14	250	65 Snake . . . . .	4	160
16	Cordelia . . . . .	8	60	41 Mohawk . . . . .	4	200	66 Sparrowhawk . . . . .	4	200
17	Cormorant . . . . .	4	200	42 Mutine . . . . .	16	100	67 Surprise . . . . .	4	200
18	Cossack . . . . .	20	250	43 Myrmidon . . . . .	3	150	68 Swallow . . . . .	9	60
19	Cruiser . . . . .	17	60	44 Niger . . . . .	14	400	69 Tartar . . . . .	20	250
20	Curlew . . . . .	9	60	45 Nimrod . . . . .	6	350	70 Teazer . . . . .	3	40
21	Desperate . . . . .	8	400	46 Osprey . . . . .	4	200	71 Victor . . . . .	6	350
22	Encounter . . . . .	14	360	47 Pearl . . . . .	20	400	72 Vigilant . . . . .	4	200
23	Esk . . . . .	21	250	48 Pelican . . . . .	16	100	73 Viper . . . . .	4	160
24	Etna . . . . .	14	200	49 Pelorus . . . . .	20	400	74 Wanderer . . . . .	4	200
25	Falcon . . . . .	17	100	50 Phoenix . . . . .	6	200	75 Wasp . . . . .	14	100
26	Fawn . . . . .	..	128	51 Pioneer . . . . .	6	350	76 Wrangler . . . . .	4	160
		305	5700		541	10900	Total . . . . .	761	16202

TABLE V.—Trooper, Store-ships, Water-tanks, Flour-mills, Yachts, and Floating-factories.

	Name.	Guns.	Horse Power.		Name.	Guns.	Horse Power.		Name.	Guns.	Horse Power.
1	Abundance	..	100		Bt. forward	..	1856		Bt. forward	11	4076
2	Assistance	..	400	18	Hearty	..	100	34	Prospero	..	144
3	Advice	..	100	19	Helen Faucit	..	..	35	Resistance	..	400
4	Adder	..	100	20	Himalaya	..	700	36	Resolute	..	400
5	African	..	90	21	Humber	..	80	37	Simoom	..	350
6	Bruiser	..	100	22	Industry	..	2	38	Sprightly	..	100
7	Buffalo	..	60	23	Malta	..	50	39	Supply	..	80
8	Bustler	..	100	24	Megæra	..	6	350	Sulina	..	120
9	Chasseur	..	100	25	Monkey	..	130	41	Sultana	..	..
10	Confiance	..	100	26	Moslem	..	120	42	Thais	..	80
11	Coromandel	..	..	27	Myrtle	..	50	43	Torch	..	150
12	Crescent	..	50	28	Nimble	..	..	44	Transit	..	500
13	Danube	..	..	29	Pera	..	30	45	Urgent	..	450
14	Echo	..	140	30	Perseverance	..	2	360	Vulcan	..	350
15	Elfin	..	140	31	Pike	..	50	47	Wye	..	100
16	Fearless	..	76	32	Pigeon	..	50				
17	Fox	..	200	33	Princess Alice	..	1	120			
			1856				11	4076	Total	37	7300

TABLE VI.

Statement of the Total Number and Power of Steam Gun-boats in the Royal Navy on the 1st April, 1856.

No.	Guns.	Horse Power.	Total Guns.	Total Horse Power.
122	4	60	488	7320
13	4	40	52	520
20	2	20	40	400
155	10	120	580	8240

TABLE VII.

Statement of the Number and Power of Steam Vessels of all classes in the Royal Navy on the 1st April, 1856.

	No.	Guns.	Horse Power.
Line-of-Battle Ships	43	3797	22950
Frigates & Mortar-ships.	24	889	10560
Paddle-wheel Vessels	90	500	24640
Corvettes, Sloops, &c.	76	761	16202
Troop-ships	47	37	7300
Gun-boats	155	580	8249
	435	6564	89892

TABLE VIII.—Showing the number of vessels (wood and iron) belonging to the Mail Contract Steam Packet Companies in March, 1853; also their Tonnage and Horse Power, from Parliamentary return ordered to be printed 29th June, 1853.

To what Company belonging.	Number of Vessels.			Tonnage.			Horse Power.		
	Wood.	Iron.	Total.	Wood.	Iron.	Total.	Wood.	Iron.	Total.
Peninsula and Oriental	11	22	33	11800	26449	38249	4086	7481	11567
Royal West India	19	1	20	32612	2700	35312	8750	800	9550
British and N. American Pacific	8	1	9	14991	2500	17491	5690	1000	6690
General Screw Steam Shipping	..	8	8	..	6688	6688	..	2298	2298
Australian	..	8	8	..	13496	13496	..	2250	2250
South Western	..	5	5	..	8600	8600	..	1800	1800
African	..	4	4	..	1612	1612	..	677	677
Total	..	4	4	..	3920	3920	..	530	530
	38	53	91	59403	65965		18526	16836	
Grand total	91			125368			35362		

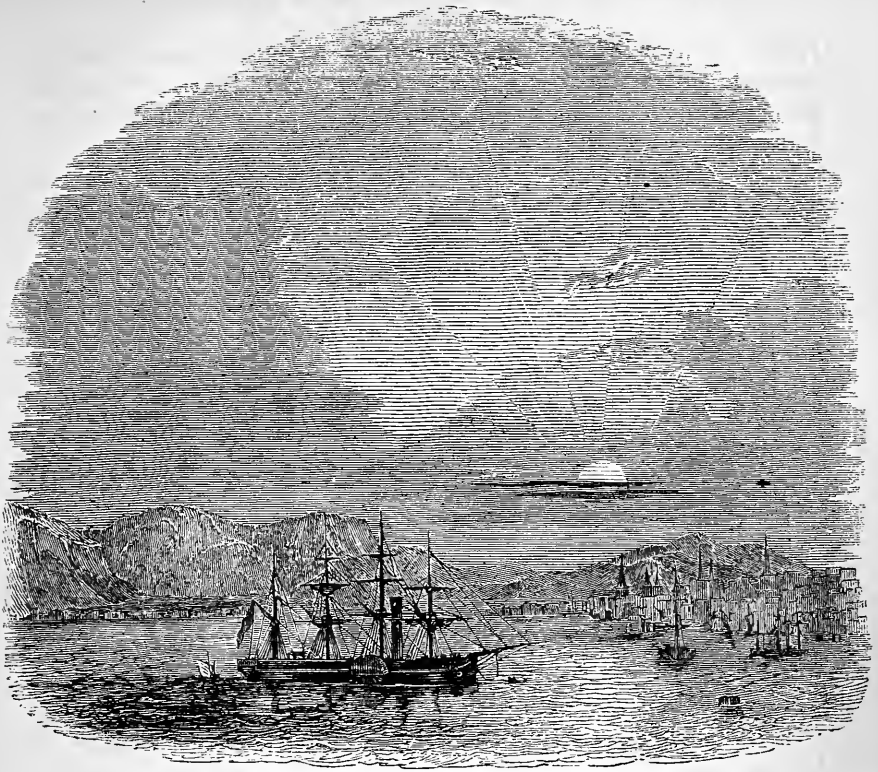

NEW YORK HARBOUR.

## LOCOMOTION BY RIVER AND RAILWAY IN THE UNITED STATES.

### CHAPTER I.

1. Natural apparatus of internal communication in United States.—
2. Canal navigation.—
3. Erie Canal.—
4. Extent of canals.—
5. Total cost, and cost per mile.—
6. Extent of canals as compared with population.—
7. River and coast navigation in United States.—
8. Steam navigation on Hudson.—
9. Tables of Hudson steamers.—
10. Beautifully finished machinery and structure.—
11. Their great speed.—
12. Application of expansive principle.—
13. Explosions on eastern rivers rare.—
14. Description of paddle-boards and mode of working steam in steamers of eastern rivers.—
15. Power of engines.—
16. Fares reduced with increased size of vessels—Form and structure of Hudson steamers.—
17. Description of the navigation of that river.—
18. Steam navigation of other American rivers.—
19. Mississippi steam-boats.—
20. Cause of explosions.—
21. Magnitude and splendour of boats.—
22. Extent of the navigation of the Mississippi valley.

## LOCOMOTION BY RIVER AND RAILWAY.

1. No quarter of the globe presents a natural apparatus of internal communication so stupendous as that which the European settlers found at their disposal on the North American continent.

This immense tract, included between the Atlantic and the Rocky Mountains on the east and west, the great chain of lakes extending from Lake Superior to Lake Ontario on the north, and the Gulf of Mexico on the south, is divided into two districts by the ridge of the Alleghanies, which traverses it in a direction north and south. The western division consists of the vast valley drained by the Mississippi and its tributaries, a territory greater in superficial extent than Western Europe. The eastern district consists of that portion between the Alleghany ridge and the Atlantic, falling towards the ocean and drained by innumerable rivers, navigable for vessels of greater or less burthen, and running generally eastward.

Provided with such means of water communication, it might have been expected that a population thinly scattered over an area so extensive, and engrossed by the exigencies of incipient agriculture, would have continued for ages contented with means of transport afforded them on so vast a scale, without having recourse to the resources of art.

It is, however, the character of man, and more especially of Anglo-Saxon man, never to rest satisfied until he renders the gifts of nature, however munificent, ten times more fruitful by his industry and skill; and it will be presently seen to what a prodigious extent the enterprise of the population of the United States has improved these means of inland transport.

### I. CANAL NAVIGATION.

2. The spectacle of a machinery of commerce so imposing in magnitude and power, and so remarkably co-extensive with the vastness, the fertility, and the mineral wealth of the territory of which this emigrant people found themselves possessors, only provoked their ambition to rival the enterprise of the parent country, and to import and naturalise its improvements and its arts. Their independence was scarcely established before the same resources of art and science which ages had not been more than sufficient to develop in Britain were invoked; and a system of artificial communication was undertaken, and finally executed, on the new continent, for which, all things considered, there is no parallel in the history of civilisation.

Immediately after the acknowledgment of the independence of the American colonies by England in 1783, several companies were formed in the two principal states of the Union, those of

## CANAL NAVIGATION.

New York and Pennsylvania, for the purpose of constructing a system of canals. These enterprises were accordingly commenced, but on a scale too limited for the attainment of the ultimate objects; and as the United States advanced in commercial prosperity, more extensive plans were adopted. In 1807, the senate charged the Secretary of State, Mr. Galatin, to prepare a project for a general system of intercommunication by canals, based upon the geographical character of the territory of the Union.

A system of artificial water-communication was accordingly projected, which, with some modifications, was at a later period adopted and carried into execution.

These projects, however, suffered an interruption from the renewal of the war in 1812; and it was not until five years later that the vast works were commenced, the result of which has been a system of inland navigation which is without a rival in any country in the world.

3. On the anniversary of the declaration of independence celebrated the 4th July, 1817, the commencement of the great line of canal connecting the Hudson with Lake Erie was inaugurated. The river Hudson presented a navigable communication for vessels of a large class from New York to Albany. The object of this line of canal was to open a water-communication between Albany and the northern lakes, so as to connect, by continuous water-communication, the North-Western States with the Atlantic.

In less than eight years this work was accomplished by the state of New York, with its exclusive resources.

That state alone executed and brought into operation the largest canal in the world. As first constructed, the Erie canal, with its branches, cost 2,600,000*l.* sterling; but its magnitude and proportions being still found inadequate to the exigencies of a continually increasing traffic, its enlargement was decided upon in 1835, and it was finally completed, at a cost of upwards of 5,000,000*l.* sterling. The total length of this canal is 363 miles, and its cost of construction per mile was therefore about 13,700*l.*

Meanwhile, the other states of the Union did not remain inactive. Pennsylvania especially rivalled New York in these enterprises, and became intersected with canals in all directions. In short, these works were undertaken to a greater or less extent in most of the Atlantic and some of the Western States; and the American Union now possesses a system of internal artificial water-communication amounting to nearly 4500 miles, executed with a degree of skill and perfection rarely surpassed by any similar works constructed in the states of Europe.

4. According to M. Michel Chevalier, whose work on this

## LOCOMOTION BY RIVER AND RAILWAY.

subject supplies most voluminous and valuable details,\* the extent of canals which were in operation in the United States on January, 1, 1843, was 4333 miles. There was a further extent projected, but not executed, amounting to 2359 miles.

5. The total cost of executing the canals which were completed was, according to M. Chevalier, 27,870964*l.*, being at the average rate of 6432*l.* per mile.

Since the date of these returns considerable extension has been given to the system of canal navigation by the opening of new lines and the increased length of former ones, and it is probable that the actual extent of artificial water-communication now in use in the United States considerably exceeds 5000 miles. The average cost of executing this prodigious system of water-roads was at the rate of 6432*l.* per mile, so that 5000 miles would have absorbed a capital of above 32,000000*l.*

6. This extent of canal transport, compared with the population, exhibits in a striking point of view the activity and enterprise which characterise the American people. In the United States there is a mile of canal navigation for every 5000 inhabitants, while in England the proportion is a mile to every 9000 inhabitants, and in France a mile to every 13000. The ratio, therefore, of this instrument of intercommunication in the United States is greater than in the United Kingdom, in proportion to the population, as 9 to 5, and greater than in France in the ratio of 13 to 5.

### II. RIVER NAVIGATION.

7. The river navigation of the United States is on a scale commensurate with the extent of their territory. The division of the country east of the Alleghanies, forming the Atlantic States, is drained by a vast number of rivers, of the first and second class, all navigable for vessels of considerable burthen, the principal of which are the Hudson, the Delaware, the Susquehanna, the Connecticut, the Potomac, the James, the Roanoke, the Savannah, and, to the southwards, the Atamala and the Alabama.

The western division is drained by the Mississippi and its hundred tributaries, navigable for vessels of great tonnage for several thousands of miles.

Besides the internal communication supplied by rivers, properly so called, a vast apparatus of water transport is derived from the geographical character of the extensive coast, stretching for about four thousand miles, from the Gulf of St. Lawrence to the

\* "Histoire et Description des Voies de Communication aux États Unis, et des Travaux d'Art qui en dépendent," par Michel Chevalier. Paris, 1840—1843.



## RIVER NAVIGATION.

delta of the Mississippi, indented and serrated in every part with natural harbours and sheltered bays, fringed with islands, forming sounds, throwing out capes and promontories, which inclose arms of the sea, in which the waters are free from the roll of the ocean, and which, for all the purposes of internal navigation, have the character of rivers and lakes. The lines of communication, formed by the vast and numerous rivers, are completed in the interior by chains of lakes, presenting the most extensive bodies of fresh water in the known world.

8. Whatever may be the dispute maintained among the historians of art as to the conflicting claims for the invention of steam navigation, it is an incontestable fact that the first steam-boat practically exhibited for any useful purpose, was placed on the Hudson to ply between New York and Albany in the beginning of the year 1808. From that time to the present, this river has been the theatre of the most remarkable series of experiments on locomotion on water ever recorded in the history of man.

The Hudson rises near Lake Champlain, the easternmost of the great chain of lakes or inland seas which extend from east to west across the northern boundary of the United States. The river follows nearly a straight course southwards for two hundred and fifty miles, and empties itself into the sea at New York. The influence of the tide is felt as far as Albany, above which the stream begins to contract. Although this river, in magnitude and extent, is by no means equal to several others which intersect the States, it is nevertheless rendered an object of great interest by reason of the importance and extent of its trade. The produce of the state of New York, and that of the banks of the lakes Ontario and Erie, are transported by it to the city; and one of the most extensive and populous districts of the United States is supplied with the necessary imports by its waters. A large fleet of vessels is constantly engaged in its navigation; nor is the tardy but picturesque sailing vessel as yet excluded by the more rapid steamer. The current of the Hudson is said to average nearly three miles an hour; but as the ebb and flow of the tide are felt as far as Albany, the passage of the steamers between that place and New York may be regarded as equally affected by currents in both directions. The passage, therefore, whether in ascending or descending the river, is made in the same time.

This river is navigable by steamers of a large class as far as Albany, nearly one hundred and fifty miles above New York.

Attempts have been made, but hitherto without much success, to push the navigation a few miles higher, as far as the important town of Troy. The impediments arising however from the shallowness of the river appear to be so serious, that Albany has

## LOCOMOTION BY RIVER AND RAILWAY.

continued, and probably will continue, to be the limit of steam navigation in this direction.

The steam navigation of the Hudson is entitled to attention, not only because of the immense traffic of which it is the vehicle, but because it forms a sort of model for most of the rivers of the Atlantic States. This navigation is conducted, as will be seen, in a manner and on a principle altogether different from that which prevails on the Mississippi and its tributaries.

In the steam-vessels used on these rivers, no other strength or stability is required than is sufficient to enable them to float and bear a progressive motion through the water. Not having to encounter the agitated surface of an open sea, they are supplied with neither rigging nor sails, and are built exclusively with a view to speed. Compared with sea-going steamers, they are slender and weak in their structure, with great length in proportion to their beam, and a very small draft of water.

The position and form of the machinery are affected by these circumstances. Without the necessity of being protected from a rough sea, the engines are placed on the deck in a comparatively elevated situation. The cylinders of large diameter and short stroke, almost invariably used in sea-going ships, are rejected in these river boats, and the proportions are reversed,—a comparatively small diameter and a stroke of great length being adopted. It is but rarely that two engines are used. A single engine, placed in the centre of the deck, drives a crank placed on the axle of the enormous paddle-wheels. The great magnitude of these latter, and the velocity imparted to them, enable them to perform the office of fly-wheels, and to carry the engine through its dead points with but little perceptible inequality of motion. The length of stroke adopted in these engines supplies the means of using the expansive principle with great effect.

The steamers which navigate the Hudson are vessels of great magnitude, splendidly fitted up for the accommodation of passengers; and this magnitude and splendour of accommodation have been continually augmented from year to year to the present time.

9. In the following table (p. 23) we have given the dimensions of nine steamers which were worked on the Hudson previously to 1838.

Since the date of these returns, considerable changes have been made in the proportion and dimensions of the vessels navigating this river; all these changes having a tendency to augment their magnitude and power, to diminish their draft of water, and to increase the play of the expansive principle. Increased length and beam have been resorted to with great success. Vessels of the largest class now draw only as much water as the smallest drew a few years ago: 4ft. 6in. is now regarded as the maximum.

## HUDSON STEAMERS.

Names.	Length of Deck.	Breadth of Beam.	Draft.	Diameter of Wheel.	Length of Paddles.	Depth of Paddles.	Number of Engines.	Diameter of Cylinder.	Length of Stroke.	Number of Revolutions.	Part of Stroke at which Steam is cut off.
	ft.	ft.	ft.	ft.	ft.	in.	in.	ft.			
Dewit Clinton .	230	28	5.5	21	13.7	36	1	65	10	29	$\frac{1}{2}$ $\frac{1}{2}$ $\frac{1}{2}$ $\frac{1}{2}$ $\frac{1}{2}$ $\frac{1}{2}$ $\frac{1}{2}$ $\frac{1}{2}$ $\frac{1}{2}$ $\frac{1}{2}$ $\frac{1}{2}$ $\frac{1}{2}$
Champlain .	180	27	5.5	22	15	34	2	44	10	27.5	
Erie .	180	27	5.5	22	15	34	2	44	10	27.5	
North America .	200	30	5	21	13	30	2	44.5	8	24	
Independence .	148	26	—	—	—	—	1	44	10	—	
Albany .	212	26	—	24.5	14	30	1	65	—	19	
Swallow .	233	22.5	3.75	24	11	30	1	46	—	27	
Rochester .	200	25	3.75	23.5	10	24	1	43	10	23	
Utica .	200	21	3.5	22	9.5	24	1	39	10	—	
Providence .	180	27	9	—	—	—	1	65	10	—	
Lexington .	207	21	—	23	9	30	1	42	11	24	
Narragansett .	210	26	5	25	11	30	1	60	12	—	
Massachusetts .	200	29.5	8.5	22	10	28	2	44	8	26	
Rhode Island .	210	26	6.5	24	11	30	1	60	11	21	

In the following table we have exhibited the dimensions and other particulars of nine of the most efficient of the more recently built steamers plying on the Hudson and its collateral streams; and by a comparison of this with the former table, it will be seen to what an extent the dimensions and efficiency of these vessels have been increased.

Name of Vessel.	DIMENSIONS OF VESSEL.				ENGINE.			PADDLE-WHEEL.		
	Length.	Beam.	Depth of Hold.	Tonnage	Diameter of Cylinder.	Length of Stroke.	Number of Strokes.	Diameter.	Length of Bucket.	Depth of Bucket.
Isaac Newton .	333	40 4	10 0	—	81	12	18 $\frac{1}{2}$	39 0	12 4	32
Bay State .	300	39 0	13 2	—	76	12	21 $\frac{1}{2}$	33 0	10 3	32
Empire State .	304	39 0	13 6	—	76	12	21 $\frac{1}{2}$	33 0	10 3	32
Oregon .	305	35 0	—	—	72	11	18	34 0	11 0	28
Hendrik Hudson	320	35 0	9 6	1050	72	11	22	33 0	11 0	33
C. Vanderbilt	300	35 0	11 0	1075	72	12	21	35 0	9 0	33
Connecticut .	300	37 0	11 0	—	72	13	21	35 0	11 6	36
Commodore .	280	33 0	10 6	—	65	11	22	31 6	9 0	33
New World .	376	35 0	10 0	—	76	15	18	44 6	12 0	36
Alida .	286	28 0	9 6	—	56	12	24 $\frac{1}{2}$	32 0	10 0	32

## LOCOMOTION BY RIVER AND RAILWAY.

10. It is not only in dimensions that these vessels have undergone improvements. The exhibition of the beautifully finished machinery of the English Atlantic steamers did not fail to excite the emulation of the American engineers and steam-boat proprietors, who ceased to be content with the comparatively rude though efficient structure of the mechanism of their steam-boats. All the vessels more recently constructed are accordingly finished and even decorated in the most luxurious manner. In respect of the accommodations which they afford to passengers, no water-communication in any country in the world can compare with them. Nothing can exceed the splendour and luxury of the furniture. Silk, velvet, and the most expensive carpeting, mirrors of immense magnitude, gilding and carving, are used profusely in their decorations. Even the engine-room in some of them is lined with mirrors. In the *Alida*, for example, the end of the room containing the engine is composed of one large mirror, in which the movements of the highly-finished machinery are reflected.

11. The new and largest class of steamers are capable of running from twenty to twenty-two miles an hour, and make, on an average, eighteen miles an hour. These extraordinary speeds are obtained usually by rendering the boilers capable of carrying steam from forty to fifty pounds pressure above the atmosphere, and by urging the fires with fanners, worked by an independent engine, by which the furnaces can be forced to any desired extent.

It is right to observe here that this extreme increase of speed is obtained at a disproportionately increased consumption of fuel. When the speed is increased, the space through which the vessel must be propelled per minute is increased in the same proportion: and, at the same time, the resistance which the moving power has to overcome is augmented in the proportion of the square of the speed. Hence, the effect to be produced by the moving power per minute, is increased by two causes: first, the actual resistance which it has to overcome is augmented in the ratio of the square of the speed; and, secondly, the space through which the moving power has to act against this resistance in each minute is increased in the ratio of the speed. Thus, the total expenditure of moving power per minute will be augmented in the proportion of the cube of the speed.

Let us suppose the speed to be increased, for example, from eighteen to twenty-one miles an hour: the power to be expended per minute to produce this effect must be increased in the ratio of the cube of 18 to the cube of 21; or, what is the same, in the ratio of the cube of 6 to the cube of 7, that is, in the ratio of 216 to 343, or as 3 to 5 very nearly.

Hence, if the furnaces could be worked with equal economy, an

## HUDSON STEAMERS.

increased consumption of fuel per hour would be necessary in the proportion of 3 to 5; but the waste incurred by urging the blowers so as to produce a sufficiently vivid combustion is so great, that it is practically found that the consumption of fuel is increased in a much higher ratio than that which results from the increased resistance, and indeed in some cases that the increase of three or four miles an hour on eighteen miles will cause nearly triple the consumption of fuel.

12. Much of the efficiency of these engines arises from the application of the expansive principle; but to this there has been hitherto a limit, owing to the inequality of the action of the piston when urged by expanding steam on the crank. When the steam is cut off at less than half-stroke, the force of the piston is diminished before the termination of the stroke to less than one half its original amount. This inequality is aggravated by the relative position of the crank and connecting rod, the leverage diminishing in nearly the same proportion as the power of the piston diminishes. On this account it has not been found generally practicable to cut off the steam at less than half-stroke.

13. It must be observed, in relation to the navigation of these eastern rivers, that the occurrence of explosions is almost unheard-of. During the last ten years, not a single catastrophe of that kind has occurred on them, although cylindrical boilers ten feet in diameter, and composed of plating  $\frac{5}{16}$ ths of an inch thick, are commonly used with steam of fifty pounds pressure above the atmosphere.

14. It will be seen by the table given above, that the paddle-wheels used on these rivers have extraordinary magnitude. There is nothing particular in their construction. The split paddle-board, which was adopted about ten years since, has been discontinued, and has given way to the simple and continuous paddle-board. These boards, however, are generally placed alternately at greater and less distances from the centre, somewhat like a break-joint. Wooden spokes, with cast-iron centre pieces, are generally adopted.

The steam is universally worked with expansion, the valves for its admission and emission being moved independently of each other. A separate engine is generally provided for driving the blowers, and a cylindrical fan-blower is employed for each boiler. Some of these blowers are ten feet in diameter, being driven by a crank placed on their axle, which receives its motion from the small independent engine.

15. The great power developed by these river engines is due, not so much to the magnitude of their cylinders, as the pressure of steam used in them. Some of the most recently constructed

## LOCOMOTION BY RIVER AND RAILWAY.

boats have cylinders seventy-six inches in diameter, and fifteen feet stroke. The steam has forty pounds pressure in the boiler, and is cut off at half-stroke. The wheels, which are forty-five feet in diameter, make sixteen revolutions per minute. The speed of the circumference of the wheel will therefore be twenty-five miles an hour; so that, if the speed of the boat be twenty miles an hour, we have the difference, five miles, giving the relative movement of the edge of the paddle-boards through the water.

To ascertain the power developed by these engines, let us suppose the mean effective pressure on the piston, taking into account the degree of vacuum produced by the condenser, and supposing the steam to be cut off at half-stroke, to be 40 lbs. per square inch, the area of the piston 4536 square inches, and the stroke 15 feet; the piston moves through 30 feet during each revolution of the wheels; and since 16 revolutions take place per minute, we shall find the effective force developed by the piston by multiplying its area, 4536, by twice the length of the stroke, which is 30, and by 16, which is the number of revolutions per minute. This product multiplied by 40, the number of pounds effective pressure per square inch, gives 87,091,200 lbs. raised one foot high per minute as the power developed by the engine. This is equivalent, according to the ordinary mode of expressing steam power, to 2,640 horse power.

Whatever allowance, therefore, may be made for friction, &c., it is clear that the effective power thus obtained must be greater than anything hitherto executed on water.

The increase of the dimensions of these vessels and their machinery has been attended with a greatly augmented economy of fuel.

On comparing the Hendrik Hudson, for example, with the Troy, a vessel formerly well known, plying between New York and Albany, it has been found that when the speed of the former is reduced to an equality with that of the latter, the trip between New York and Albany being performed in the same time, the former consumed thirteen tons of coal while the latter consumed twenty; yet the displacement of the Hendrik Hudson, owing to its increased dimensions, is nearly twice that of the Troy.

The ease with which these vessels of extraordinary length and beam and small draft move through the water is very remarkable. The results of their performance show that the resistance per square foot of immersed midship section is not perceptibly increased by the increased length of the vessel, and the consequently augmented surface and friction. This anomaly has not been explained, but it is certain that the increased length does not diminish the effect of the moving power in any perceptible degree.

## HUDSON STEAMERS.

16. Practical evidence of the economy arising from this increase of power and dimensions is supplied by the fact that the proprietors of the Hudson steam-boats reduced their tariff for passengers, as well as for freight, as they increased the size of their vessels.

Previously to 1844 the lowest fare from New York to Albany, a distance of 145 miles, was 4*s.* 4*d.*; at present the fare is 2*s.* 2*d.*; and for an additional sum of the same amount the passenger can command the luxury of a separate cabin. When the splendour and magnitude of the accommodation is considered, the magnificence of the furniture and accessories, and the luxuriousness of the table, it will be admitted that no similar example of cheap locomotion can be found in any part of the globe. Passengers may there be transported in a floating palace, surrounded with all the conveniences and luxuries of the most splendid hotel, at the average rate of twenty miles an hour, for less than *one-sixth* of a penny per mile!

It is not an uncommon occurrence during the warm season to meet persons on board these boats who have lodged themselves there permanently, in preference to hotels on the banks of the river. Their daily expenses in the boat are as follow:—

	<i>s.</i>	<i>d.</i>
Fare . . . . .	2	2
Separate bed-room . . . . .	2	2
Breakfast, dinner, and supper . . . . .	6	6
Total daily expense for board, lodging, attendance, and travelling 150 miles at 20 miles an hour . . . . .	10	10

Such accommodation is, on the whole, more economical than an hotel. The bed-room is as luxuriously furnished as the handsomest chamber in an hotel or private house, and is much more spacious than the room similarly designated in the largest packet ships.

To obtain an adequate notion of the form and structure of one of the first-class steam-boats on the Hudson, let it be supposed that a boat is constructed similar in form to a Thames wherry, but above 300 feet long and 25 or 30 feet wide. Upon this, let a platform of carpentry be laid, projecting several feet upon either side of the boat, and at stem and stern. The appearance to the eye will then be that of an immense raft, from 250 to 350 feet long, and some 30 or 40 feet wide. Upon this flooring let us imagine an oblong rectangular wooden erection, two stories high to be raised. In the lower part of the boat, and under the flooring just mentioned, a long narrow room is constructed, having a series of berths at either side, three or four tiers high. In the centre

## LOCOMOTION BY RIVER AND RAILWAY.

of this flooring is usually, but not always, enclosed an oblong, rectangular space, within which the steam machinery is placed, and this enclosed space is continued upwards through the structure raised on the platform, and is intersected at a certain height above the platform by the shaft or axle of the paddle-wheels.

These wheels are propelled, generally, by a single engine, but occasionally, as in European states, by two. The paddle-wheels are usually of great diameter, varying from 30 to 40 feet, according to the magnitude of the boat. In the wooden building raised upon the platform, already mentioned, is contained a magnificent saloon devoted to ladies, and to those gentlemen who accompany them. Over this, in the upper story, is constructed a row of small bed-rooms, each handsomely furnished, which those passengers can have who desire seclusion, by paying a small additional fare.

The lower apartment is commonly used as a dining or breakfast-room.

In some boats, the wheels are propelled by two engines, which are placed on the platform which overhangs the boat at either side, each wheel being propelled by an independent engine; the wheels, in this case, acting independently of each other, and without a common shaft or axle. This leaves the entire space in the boat, from stem to stern, free from machinery. It is impossible to describe the magnificent *coup d'œil* which is presented by the immense apparent length when the communication between them is thrown open. Some of these boats, as has been already stated, are upwards of three hundred feet long, and the uninterrupted length of the saloons corresponds with this.

This arrangement of machinery is attended with some practical advantages, one of which is a facility of turning, as the wheels, acting independently of each other, may be driven in opposite directions, one propelling forwards and the other backwards, so that the boat may be made to turn, as it were, on its centre. Although, from the great width of the Hudson, no great difficulty is encountered in turning the longest boat, yet cases occur in which this power of revolution is found extremely advantageous.

Another advantage of this system is, that when one of the two engines becomes accidentally disabled, the boat can be propelled by the other.

The general appearance of the Hudson steamers is represented in the annexed engraving of the "Iron Witch."

17. No spectacle can be more remarkable than that which the Hudson presents for several miles above New York. The skill with which these enormous vessels, measuring from three to four hundred feet in length, are made to thread their way through the crowd of shipping, of every description, moving over the face



## HUDSON STEAMERS.

of this spacious river, and the rare occurrence of accidents from collision, are truly admirable. In a dark night these boats run at the top of their speed through fleets of sailing vessels. The bells through which the steersman speaks to the engineer scarcely ever cease. Of these bells there are several of different tones, indicating the different operations which the engineer is commanded to make, such as stopping, starting, reversing, slackening, accelerating, &c. At the slightest tap of one of these bells, these enormous engines are stopped, or started, or reversed by the engineer, as though they were the plaything of a child. These vessels, proceeding at sixteen or eighteen miles an hour, are propelled among the crowded shipping with so much skill as almost to graze the sides, bows, or sterns of the vessels among which they pass.

The difficulty attending the evolutions by a vessel such as the *New World*, for example, one hundred and twenty-five yards long and twelve yards wide, may be easily imagined; and the promptitude and certainty with which an engine whose pistons are seventy-six inches in diameter, and whose stroke is five yards in length, is governed must be truly surprising.

18. The navigation of the other rivers of the Atlantic States differs in nothing from that of the Hudson and its collateral branches, except in the extent of their traffic and the magnitude and power of the steamers. The engines, in all cases, are constructed on the condensing principle; and although steam of forty or fifty pounds above the pressure of the atmosphere is frequently used, it is worked expansively, and

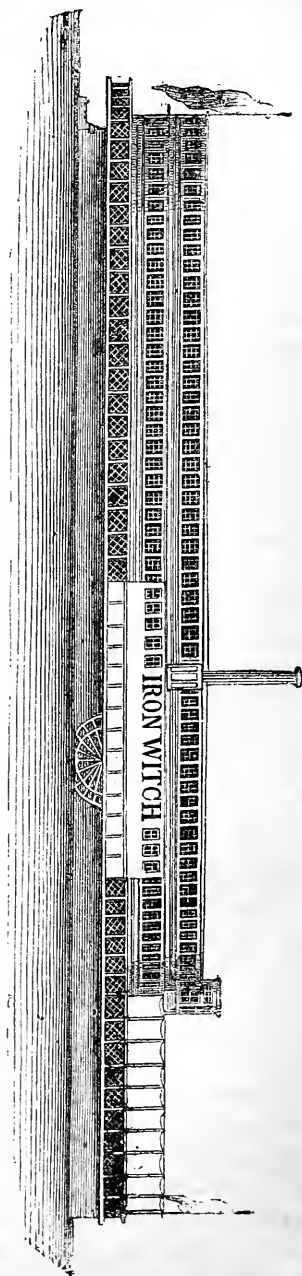

## LOCOMOTION BY RIVER AND RAILWAY.

a good vacuum is always sustained behind the piston by means of the condenser.

19. The steam navigation of the Mississippi is conducted in a manner entirely different from that of the Hudson and the eastern rivers. Every one must be familiar with the lamentable accidents which happen from time to time, and the loss of life from explosion which continually takes place in those regions.

These accidents, instead of diminishing with the improvements of art, appear rather to have increased. Engineers, disregarding the heart-rending narratives continually published, have done literally nothing to check the evil; and it may be almost said to be a disgrace to humanity, that the legislature of the Union has not ere this interposed its authority to check abuses, which are productive of such calamities.

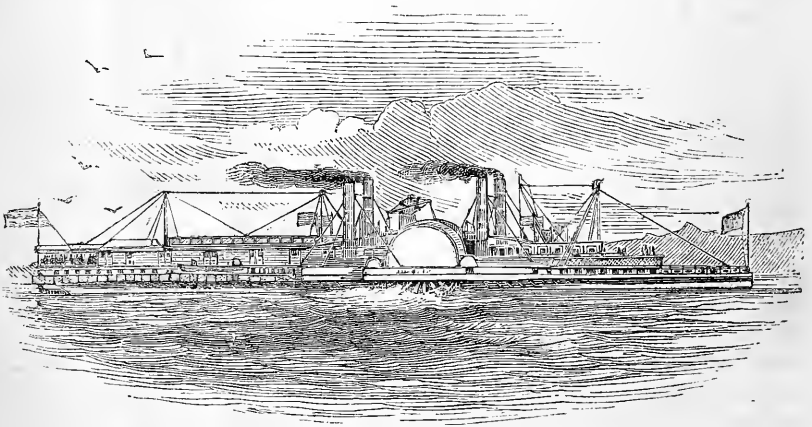

MISSISSIPPI STEAMBOAT.

In a Mississippi steam-boat the cabins and saloons provided for the accommodation of the passengers, though less magnificently furnished, are as spacious as those already described in the boats on the Hudson. They are, however, erected on a flooring or platform, six or eight feet above the deck of the vessel. Upon this deck, and in the space under the cabins and saloons allotted to the passengers, are placed the engines, which are of the coarsest structure. They are invariably worked with high-pressure steam without condensation; and in order to obtain that effect, which, in the boats on the Hudson, is due to the vacuum, the steam is worked at an extraordinary pressure. I have myself frequently witnessed boilers of the most inartificial construction worked with steam of the full pressure of 120 lbs. per square inch; but more recently this pressure has been increased, the ordinary working pressure

## MISSISSIPPI STEAMERS.

being now 150 lbs., and I am assured, on good authority, that it is not unfrequently raised to even 200 lbs. The boilers are cylindrical, of large diameter, and of the rudest kind. When returning flues are constructed in them, the space left is so small, that the slightest variation in the quantity of water they contain, or in the trim of the vessel, causes the upper flues to be uncovered, and the intense action of the furnace in this case soon renders them red-hot, when a frightful collapse is almost inevitable. The red-hot iron, no longer able to resist the intense pressure, gives way, the boiler explodes, and the scalding water is scattered in all directions, often producing more terrible effects than even the fragments of the boiler which are projected around with destructive force.

20. Another frequent cause of explosion in these boilers is the quantity of mud held in suspension in the waters of the Mississippi below the mouth of the Missouri. As the water in the boiler is evaporated, the earthy matter which it held in suspension remains behind, and accumulates in the boiler, in the bottom of which it is at length collected in a thick stratum. This produces effects similar to those which take place in marine boilers, in consequence of the deposition of salt. This earthy stratum collected within the boiler being a non-conductor, the heat proceeding from the furnace is interrupted, and, instead of being absorbed by the water, is accumulated in the boiler-plates, which it ultimately renders red-hot. Being thus softened, they give way, and the boiler bursts. The only preventive remedy of this catastrophe is, to blow the water out of the boiler from time to time, before a dangerous accumulation of mud takes place, in the same manner as marine boilers are blown out to prevent the accumulation of salt. The engine-drivers and captains, however, rarely attend to this process. They are too intent upon obtaining speed, and, to use their own phrase, "going a-head." They do not hesitate to endanger their own lives and those of the passengers, rather than allow themselves to be outrun by a rival boat.

Not only the Mississippi, but the Ohio, the Missouri, the Illinois, the Red River, and, in a word, all the tributaries of the Father of Rivers, are navigated for many thousands of miles by this description of boats, worked with the same reckless disregard of human life.

21. The magnitude and splendour of these boats is little, if at all, inferior to those of the Hudson. They are, however, constructed more with a view to the accommodation of freight, as they carry down the river large quantities of cotton and other produce, as well as passengers, to the port of New Orleans. Many of these vessels are three hundred feet and upwards in length, and are capable of carrying a thousand tons freight, and three or four

## LOCOMOTION BY RIVER AND RAILWAY.

hundred deck passengers, besides the cabin passengers. The traffic in goods and passengers of the entire extent of the immense valley of the Mississippi is carried by these vessels, except that portion which is floated down by the stream in a species of raft called flat-boats.

22. This line of steam-navigation is continued up the Mississippi, branching east and west along its great tributaries. The Ohio carries it eastwards as far as Pittsburgh, in Pennsylvania. A canal connects the Ohio at Cincinnati with Lake Erie. The navigation of the Upper Mississippi is continued by the Illinois river to a port near Lake Michigan, with which it is connected by a canal extending to Chicago, on the western shore of that lake. Here commences the great chain of lake steam-navigation, which extends across the northern division of the States, traversing Lakes Michigan, Huron, Erie, and Ontario, and being continued along the St. Lawrence, to Montreal and Quebec. The lakes are connected by canals.

By the Erie canal, connecting the lake of that name with the head of the Hudson navigation at Albany, the circuit of navigation round the United States is completed.

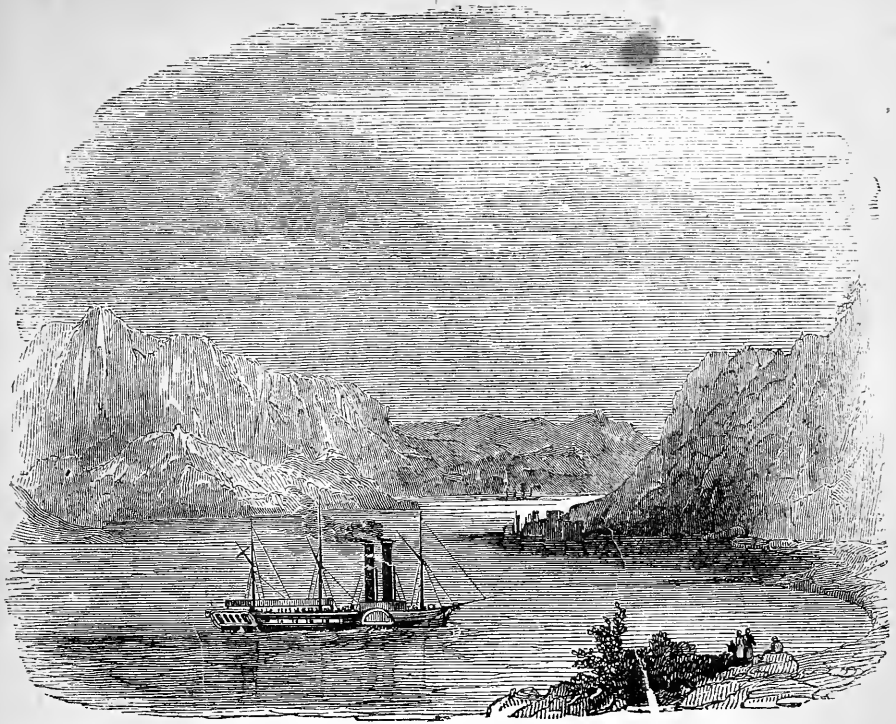

# LOCOMOTION BY RIVER AND RAILWAY

## IN THE UNITED STATES.

### CHAPTER II.

1. Inland steam navigation. — 2. Table of sea-going steam-ships. — 3. Towing river steamers. — 4. Water goods train. — 5. Commencement of railways. — 6. Average cost of construction to 1849. — 7. Tabular statement of the railways to 1851. — 8. Their distribution and general direction. — 9. New England lines. — 10. New York lines. 11. New York and Philadelphia. — 12 Pennsylvania lines. — 13. Great celerity of construction — tabular statement. — 14. Extent of lines open and in progress in 1853. — 15. Their distribution among the States. — 16. Average cost of construction. — 17. Railways in central States. — 18. General summary. — 19. Causes of the low comparative cost of construction. — 20. Method of crossing rivers. — 21. Modes of construction — rails and curves. — 22. Engines. — 23. Greater solidity of construction recently practised. — 24. Railway carriages. — 25. Expedient for passing curves.

1. NOTWITHSTANDING the facilities for coast navigation which are offered along the Atlantic shores from New York southwards, successful efforts have been directed to establish a parallel inland

## LOCOMOTION BY RIVER AND RAILWAY.

communication by the Potomac and the Hudson. A line of inland steamers is established between the Potomac and New York by Chesapeake Bay, the Delaware, the Chesapeake and Delaware canal, the Delaware and Rariton canal, and the Rariton river, and by these means the same line of communication is extended to the shores of New England and Long Island Sound.

A project is introduced, and likely to be carried into effect, for enlarging the Great Erie canal, so as to admit of steamers. When this shall be effected, the entire extent of the States, from Washington, by New York, Albany, the great Northern Lakes, and the Mississippi, to New Orleans, will be surrounded by a continuous chain of inland steam-navigation. The importance of this internal communication in the event of a war must be apparent.

The form and structure of these river-steamers, as described in general terms in the last chapter, will be more easily understood

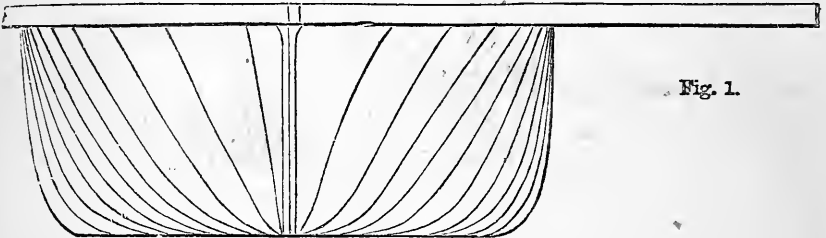
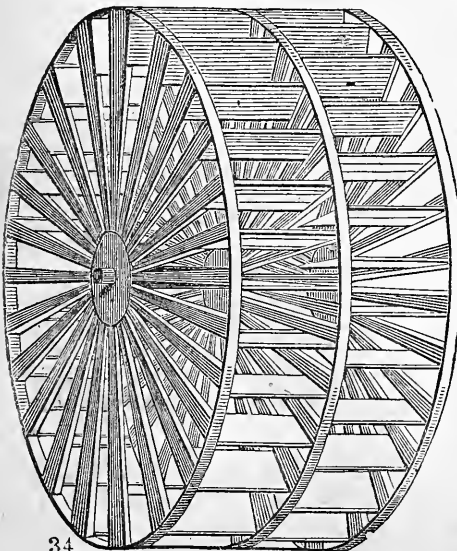

Fig. 1.

by figure 1, which represents a cross section of the hull with one-half of the platform, which is placed upon it, and which supports the upper cabins and saloons. This hull is

Fig. 2.



constructed with a perfectly flat bottom and perpendicular sides, and is rounded at the angles. At the bow or cutwater they are made very sharp.

The split paddle-wheel, which until very lately was exclusively used in these boats, is represented in fig. 2, and is formed as if by the combination of two or more common paddle-wheels, placed one outside the other, on the same axle, but so that the paddle-boards of each

## CONSTRUCTION OF RIVER-STEAMERS.

may have an intermediate position between those of the adjacent one, as represented in fig. 2.

The spokes, which are bolted to cast-iron flanges, are of wood. These flanges, to which they are so bolted, are keyed upon the paddle-shaft. The outer extremities of the spokes are attached to circular bands or hoops of iron, surrounding the wheel; and the paddle-boards, which are formed of hard wood, are bolted to the spokes. The wheels thus constructed, sometimes consist of three, and not unfrequently four, independent circles of paddle-boards, placed one beside the other, and so adjusted in their position that the boards of no two divisions shall correspond.

2. Although the subject of this tract is limited to inland transport, it will not be without interest to exhibit here some particulars of the progress made in the United States in sea steam-navigation. With this view we have given, in the following table, (p. 36), the dimensions and power of some of the principal sea-going steamers which had been constructed and brought into operation at the date of the last reports accessible to us. It must, however, be always remembered, that the progress of enterprise, more especially in this department, in the United States is so rapid, that probably before these pages come into the hands of the reader many other and more magnificent vessels will have been launched.

3. The other class of steamers used for towing the commerce of the rivers corresponds to the goods trains on railways. No spectacle can be more remarkable than these locomotive machines, dragging their enormous load up the Hudson. They may be seen in the midst of this vast stream, surrounded by a cluster of twenty or thirty loaded craft of various magnitudes. Three or four tiers are lashed to them at each side, and as many more at their bow and at their stern. The steamer is almost lost to the eye in the midst of this crowd of vessels which cling around it, and the moving mass is seen to proceed up the river, no apparent agent of propulsion being visible, for the steamer and its propellers are literally buried in the midst of the cluster which clings to it and floats round and near it.

4. As this *water goods train*, for so it may be called, ascends the Hudson, it drops off its load, vessel by vessel, at the towns which it passes. One or two are left at Newburgh, another at Powkeepsie, two or three more at Hudson, one or two at Fishkill, and, in fine, the tug arrives with a residuum of some half-dozen vessels at Albany.

# LOCOMOTION BY RIVER AND RAILWAY.

Name and Route of Vessel.	DIMENSIONS OF VESSEL.				ENGINE.			PADDLE-WHEEL.		
	Length.	Beam.	Depth of Hold.	Ton-nage.	Diam. of Cylinder.	Length of Strokes.	Number of Strokes.	Diam.	Length of Bucket.	Depth of Bucket.
	ft.	ft. in.	ft. in.		in.	ft. in.		ft. in.	ft. in.	in.
Panama, Panama and San Francisco .....	200	33 6	20 0	..	70	8 0	17	26 0	8 9	30
Pacific, New York and Liverpool .....	280	45 6	24 0	..	95	9 0	16½	35 0	11 6	34
Antarctic, ditto .....	280	45 6	24 0	..	96	10 0	16½	35 6	12 0	32
Washington, New York, Southampton, and Bremen .....	230	39 0	32 0	1750	72	10 0	12	85 0	7 6	36
Hermann, Do. ....	235	40 0	32 0	1850	72	10 0	12	36 0	8 0	36
Southern, New York and Charleston .....	196	32 0	22 0	850	67	8 0	14	31 0	7 6	30
Northerner, Do. ....	206	33 0	22 0	1000	70	8 0	14	31 0	7 6	30
Cherokee, New York and Savannah .....	212	35 0	22 0	1250	75	8 0	14	31 0	8 0	30
Tennessee, Do. ....	212	35 0	22 0	1250	75	8 0	14	31 0	8 0	30
Oregon, Panama and Oregon .....	200	34 0	20 0	1100	70	8 0	15	26 0	9 0	30
California, Do. ....	200	33 0	20 0	1050	70	8 0	15	26 0	9 0	30
Franklin, New York and Havre .....	260	42 0	26 0	2300	94	8 0	..	34 0	12 0	30
Atlantic, New York and Liverpool .....	280	46 0	32 0	2800	95	9 0	..	35 0	12 0	32
United States, New York, New Orleans, and Chagres .....	250	40 0	34 6	..	80	9 0	16	35 0	9 0	36
Crescent City, Do. ....	220	34 0	17 0	..	80	9 0	16	32 0	8 0	30
Empire City, Do. ....	230	38 0	17 6	..	83	9 0	..	32 0	8 0	30
Georgia, Do. ....	260	45 0	34 6	..	90	8 0	..	36 0	10 6	30
Ohio, Do. ....	260	47 0	34 6	..	90	8 0	..	36 0	10 6	30
Falcon, Do., touching at Savannah .....	206	32 0	22 0	..	60	5 0	16	30 0	7 8	13
Powhatan .....	254	45 0	26 6	2419 <sup>32</sup>	70	10 0	..	31 0	10 0	30
Susquehanna .....	252	45 0	26 6	2398 <sup>2</sup>	70	10 0	..	31 0	9 6	34
Saranac .....	215	38 0	23 6	1450 <sup>31</sup>	60	9 0	..	27 0	9 6	30
} Government vessels.										
San Jacinto .....	215	38 0	23 6	..	62½	4 2	..	14 0	5 0	6
Carolinian, Philadelphia and Charleston .....	175	28 0	18 0	660	44	3 0	..	11 0	..	..
Philadelphia, Do. ....	192	33 0	18 6	..	56	6 9	19	27 0	8 9	..
Isabel, Charleston and Savannah .....	222	33 0	21 6	1115	72	8 0	16	31 0	8 0	..
Republic, Baltimore and Charleston .....	200	30 0	18 6	800	54	6 0	..	25 6	8 9	..



## III. RAILWAYS.

5. The phenomena of transport so unexpectedly developed on the opening of the Liverpool and Manchester Railway, and the miracles of swift locomotion there exhibited, had no sooner been announced, than the Americans, with their usual ardour, resolved to import this great improvement; and projects of passenger railways, on the vast scale which characterises all their enterprises, were immediately set forth.

Some lines of railway in isolated positions, around coal-works and manufactories, had been, as in England, already for some years in operation. It was not, however, until after 1830 that the railway system began to assume in America the character which it had already taken in England. A few years were sufficient to bring it into practical operation in several parts of New England and in the State of New York; and, once commenced, its progress was extremely rapid.

As might naturally be expected, the chief theatre of railway enterprise is the Atlantic States. The Mississippi and its tributaries have hitherto served the purposes of commerce and inter-communication to the comparatively thinly scattered population of the Western States so efficiently, that notwithstanding the extraordinary enterprise of the people, the railway system has hitherto made comparatively small progress in these vast forest-covered plains and open prairies. Nevertheless they have not altogether escaped the operations of the engineer; and the traveller already feels the benefit, even in these remote regions, of the new art of transport. These railways consist as yet of detached and single lines, unconnected with the vast network which we shall presently notice.

To the traveller in these wild regions, the aspect of such artificial agents of transport in the midst of a country, a great portion of which is still in the state of native forest, is most remarkable, and strongly characteristic of the irrepressible spirit of enterprise of its people. Travelling in the backwoods of Mississippi, through native forests, where, till within a few years, human foot never trod, through solitudes, the silence of which was never broken, even by the red man, we have been sometimes filled with wonder to find ourselves transported by an engine constructed at Newcastle-on-Tyne, and driven by an artisan from Liverpool, at the rate of twenty miles an hour. It is not easy to describe the impression produced by the juxtaposition of these refinements of art and science with the wildness of the country, where one sees the frightened deer start from its lair at the snorting of the ponderous machine and the appearance of the snake-like train which follows it.

## LOCOMOTION BY RIVER AND RAILWAY.

6. The first American railway was opened for passengers on the last day of 1829. It appears that in 1849, after an interval of just twenty years, there were in actual operation 6565 miles of railway in the States. The cost of construction and plant of this system of railways, according to official reports, was 53,386885*l.*, being at the average rate of 8129*l.* per mile.

7. We have, however, before us documents which supply data to a more recent period, and have computed from them the following table, exhibiting the number of miles of railway which were in actual operation in the United States, the capital expended in their construction and plant, and the length of the lines in process of construction, but not yet completed in 1851:—

	Railways in operation.	Cost of Construction and Plant.	Railways projected and in progress.	Cost per mile.
	Miles.	£	Miles.	£
Eastera States, including Maine, New Hampshire, Vermont, Massachusetts, Rhode Island, and Connecticut . . . . .	2845	23,100987	567	8120
Atlantic States, including New York, the Jerseys, Pennsylvania, Delaware, and Maryland . . . .	3503	27,952500	2020	7979
Southern States, including Virginia, the Carolinas, Georgia, Florida, and Alabama . . . . .	2106	8,253130	1283	3919
Western States, including Mississippi, Louisiana, Texas, Tennessee, Kentucky, Ohio, Michigan, Indiana, Illinois, Missouri, Iowa, and Wisconsin . . . . .	1835	7,338290	5762	3999
Totals and averages . . . .	10289	66,644907	9632	6478

8. Of the total length of railways which overspread the territory of the Union, more than the half are constructed in the States of Pennsylvania, New York, and those of New England. The principal centres from which these lines of communication diverge are Boston, New York, and Philadelphia.

A considerable extent, though of less importance, diverges from Baltimore; and recently lines of communication of great length have been constructed, from Charleston in South Carolina, and from Savannah in Georgia.

## RAILWAYS OF NEW YORK.

9. From Boston three trunk-lines issue ; the chief of which passes through the State of Massachusetts to Albany, on the Hudson. This line of railway is 200 miles in length, and appears destined to carry a considerable traffic. Its ramifications southward, through the smaller states of New England, are numerous, chiefly leading to the ports upon Long Island Sound, which communicate by steam-boats with New York. The first branch is carried from Worcester, in Massachusetts, to New London on the Sound, where it meets a short steam-ferry which communicates with Greenport, at the eastern extremity of Long Island, from which another railway, nearly fifty miles long, is carried to Brooklyn, which occupies the shore of that island immediately opposite New York, and communicates with the latter city by a steam-ferry.

Thus there is a continued railway communication from Boston to New York, interrupted only by two ferries.

Another branch of the great Massachusetts line is carried south from Springfield, through Hartford to Newhaven; and a third from Pittsfield to Bridgeport, both the latter places being on the Sound, and communicating with New York by steamboats.

The second trunk-line from Boston proceeds southwards to Providence, and thence to Stonington, from which it communicates by a ferry with the Long Island Railway. This trunk-line throws off a branch from Foxburgh to New Bedford, where it communicates by ferries with the group of islands and promontories clustered round Cape Cod.

A third trunk-line proceeds from Boston through the State of Maine.

10. Notwithstanding the speed and perfection of the steam navigation of the Hudson, a railway is constructed on the east side of that river to Albany.

From Albany an extensive line of railway communication, 323 miles in length, is carried across the entire State of New York to Buffalo, at the head of Lake Erie, with branches to some important places on the one side and on the other. This line forms the continuation of the western railway, carried from Boston to Albany, and, combined with this latter, completes the continuous railway communication from the harbour of Boston to that of Buffalo on Lake Erie, making an entire length of railway communication, from Boston to Buffalo, of 523 miles.

The branches constructed from this trunk-line are not numerous. There is one from Schenectady to Troy, on the Hudson, and another from Schenectady to Saratoga; another from Syracuse to Oswego, on Lake Ontario; and another from Buffalo to the falls of Niagara, and from thence to Lockport.

## LOCOMOTION BY RIVER AND RAILWAY.

Not content with this fine line of communication to the Western Lakes, the commercial interests of New York have projected, and in part constructed, a more direct route from New York to Buffalo, independent of the Hudson.

The disadvantage of this river as a sole means of communication is, that, during a certain portion of the winter, all traffic upon it is suspended by frost. In this case, the line of railway communicating already from Bridgeport and Newhaven to Albany has been resorted to by travellers. However, it may be regarded as certain, that the intermediate traffic of the State of New York along the direct line of railway now in progress from that city to Buffalo, will very speedily be sufficient for the support of an independent line of railway.

The immediate environs of New York are served by several short railways, as is usual indeed in all great capitals where the railway system of transport prevails.

The line connecting that city with Haarlem is analogous in many respects to the Greenwich and Blackwall lines at London, and the Versailles and St. Germain lines at Paris. It is supported by a like description of traffic. The New York line, however, has this peculiarity, that it is conducted through the streets of the capital upon their natural level, without either cutting, tunnel, or embankment. The carriages, on entering the town, are drawn by horses, four horses being allowed to each coach; each coach carrying from sixty to eighty persons, and being constructed like the railway coaches in general in the United States.

The rails along the streets are laid down in a manner similar to that which is customary at places where lines of railway in England cross turnpike roads on a level. The surface of the rail is flush with the pavement, and a cavity is left for the flange to sink in.

Other short railways, from New York to Paterson, Morristown, and Somerville, require no particular note.

11. The great line of railway already described, from Boston to New York, is continued southwards from that capital to Philadelphia. There are here two rival lines; one of which, commencing from Jersey city on the Hudson, opposite the southern part of New York, is carried to Bordentown, on the left bank of the Delaware, whence the traffic is carried by steamboats a few miles further to Philadelphia. The rival line commences from South Amboy in New Jersey, to which the traffic is brought from New York by steamers plying on the Rariton river, which separates New Jersey from Staten Island. From Amboy, the railway is continued to Camden, on the left bank of the Delaware, opposite Philadelphia.

## DISTRIBUTION OF RAILWAYS.

By far the greater part of the traffic between New York and Philadelphia is carried by the former line.

12. Philadelphia is the next great centre from which railways diverge. One line is carried westward through the state of Pennsylvania, passing through Reading, and terminating at Pottsville, in the midst of the great Pennsylvanian coal-field. There it connects with a network of small railways, serving the coal and iron mines of this locality. This line of railway is a descending line towards Philadelphia, and serves the purposes of the mining districts better than a level. The loaded trains descend usually with but little effort to the moving power, while the empty waggons are drawn back.

The passenger traffic is chiefly between Reading and Philadelphia.

Another line of railway is carried westward through the state of Pennsylvania, passing through Lancaster, Harrisburg, the seat of the legislature, Carlisle, and Chambersburg, where it approaches the Baltimore and Ohio Railway. The length of this railway from Philadelphia to Chambersburg is 154 miles. The former, to Pottsville and Mount Carbon, is 108 miles, the section to Reading being 64.

13. The rate at which this prodigious extent of public works has been executed will appear by the following table:—

Year.	Miles in operation.
1830 . . . . .	167
1832 . . . . .	213
1835 . . . . .	787
1840 . . . . .	2380
1845 . . . . .	3659
1846 . . . . .	4144
1847 . . . . .	4249
1848 . . . . .	5258
1849 . . . . .	7000
1850 . . . . .	8797
1851 . . . . .	10289

14. It appears from returns still more recent that on the 1st of January, 1853, the number of miles of railway in operation was 13315, and the number of miles in process of construction was 12029; so that in the two years ending the first of January, 1853, a total extent of railway measuring 3026 miles was brought under traffic, and the construction of 2397 miles of new railway was commenced.

15. The proportion in which this enormous extent of overland communication is distributed among the confederated States, and the proportion of its extent in each State to the superficial area and to the population, are exhibited in the following table:—

LOCOMOTION BY RIVER AND RAILWAY.

TABLE showing the Area, Population, Length of Railway, and the Ratio of the Railway to the Area and Population in each of the State of the American Union in 1853.

STATES.	AREA SQ. MILES.	POPULATION.			MILES OF RAILWAY.			MILES PER 100 SQUARE MILES OF SURFACE.			MILES PER 1000 INHABITANTS.			
		583188	317964	314120	439	66	1206	506	1-30	0-67	1-67	0-68	0-19	0-87
Maine .....	30280	583188	395	111	506	1-30	0-67	1-67	0-68	0-19	0-87	0-19	0-87	
New Hampshire .....	9000	317964	500	42	542	5-55	0-47	6-02	1-27	0-13	1-70	0-13	1-70	
Vermont .....	10212	314120	439	..	439	4-30	..	4-30	1-40	..	1-40	..	1-40	
Massachusetts .....	7800	994499	1140	66	1206	14-61	0-85	15-46	1-15	0-07	1-22	0-07	1-22	
Rhode Island .....	1306	147544	50	32	82	3-85	2-46	6-31	0-34	0-22	0-56	0-22	0-56	
Connecticut .....	4674	370791	630	198	828	13-48	4-24	17-73	1-70	0-53	2-23	0-53	2-23	
New York .....	46000	3,997349	2150	1004	3154	4-67	2-18	6-85	0-69	0-32	1-01	0-32	1-01	
New Jersey .....	8320	480553	254	85	339	3-06	1-00	4-06	0-53	0-18	0-71	0-18	0-71	
Pennsylvania .....	46000	2,311786	1211	914	2125	2-63	2-00	4-63	0-52	0-40	0-92	0-40	0-92	
Delaware .....	2120	91585	16	11	27	0-76	0-50	1-26	0-17	0-12	0-29	0-12	0-29	
Maryland .....	9356	583035	521	..	521	0-56	..	0-56	0-89	..	0-89	..	0-89	
Virginia .....	6352	1,421661	624	610	1234	9-82	9-60	19-42	0-44	0-43	0-87	0-43	0-87	
North Carolina .....	45000	388903	249	248	497	0-55	0-55	1-10	0-29	0-29	0-58	0-29	0-58	
South Carolina .....	24500	668507	599	296	895	2-45	1-21	3-66	0-90	0-44	1-34	0-44	1-34	
Georgia .....	58000	905999	857	203	1060	1-48	0-35	1-83	0-95	0-22	1-17	0-22	1-17	
Florida .....	59268	87401	23	..	23	0-04	..	0-04	0-26	..	0-26	..	0-26	
Alabama .....	50722	771671	236	666½	902½	0-47	1-31	1-78	0-31	0-86	1-17	0-86	1-17	
Mississippi .....	47156	600555	95	875	970	0-20	1-86	2-06	0-16	1-46	1-62	1-46	1-62	
Louisiana .....	46431	517739	63	200	263	0-14	0-43	0-57	0-12	0-39	0-51	0-39	0-51	
Texas .....	237321	1,002625	32	..	32	0-01	..	0-01	0-15	..	0-15	..	0-15	
Tennessee .....	45608	1,002625	185	509½	694½	0-41	1-12	1-53	0-18	0-51	0-69	0-51	0-69	
Kentucky .....	37680	382405	94	669	753	0-25	1-75	2-00	0-09	0-67	0-76	0-67	0-76	
Ohio .....	39964	1,980408	1418	1736	3154	3-54	4-34	7-88	0-72	0-88	1-60	0-88	1-60	
Michigan .....	56243	397654	427	..	427	0-76	..	0-76	1-07	..	1-07	..	1-07	
Indiana .....	33869	988415	755	979	1734	2-23	2-89	5-12	0-76	0-99	1-75	0-99	1-75	
Illinois .....	55405	851470	296	1662	1958	0-53	3-00	3-53	0-35	1-95	2-30	1-95	2-30	
Missouri .....	67380	682033	..	515	515	..	0-77	0-77	0-76	0-76	0-76	0-76	0-76	
Wisconsin .....	53924	305091	56	417	473	0-10	0-77	0-87	0-18	1-37	1-55	1-37	1-55	
<b>Total .....</b>	<b>1,139891</b>	<b>22,537493</b>	<b>13315</b>	<b>12089</b>	<b>25354</b>	<b>77-75</b>	<b>44-02</b>	<b>121-77</b>	<b>16-57</b>	<b>13-38</b>	<b>29-95</b>	<b>13-38</b>	<b>29-95</b>	

## GREAT EXTENT OF RAILWAYS.

It must be admitted that the results here exhibited present a somewhat astonishing spectacle. It appears from this statement that in 1853 there were in actual operation in the United States 13315 miles of railway, and 12029 projected and in process of execution. So that when a few years more shall have rolled away, this extraordinary people will actually have above 25000 miles of iron road in operation.

16. It results from the above, compared with the previous report, that the average cost of construction has been diminished as the operations progressed. The average cost of construction of the 6500 miles of railway in operation in 1849 was 8129%. per mile, whereas it appears from the preceding table that the actual cost of 10289 miles, in operation in 1851, has been at the average rate of 6478%. per mile. On examining the analysis of the distribution of these railways among the States, it appears that this discordance of the two statements is apparent rather than real, and proceeds from the fact that the railways opened since 1849, being chiefly in the southern and western States, are cheaply constructed lines, in which the landed proprietors have given to a great extent their gratuitous co-operation, and in which the plant and working stock is of very small amount, so that their average cost per mile is a little under 4000%. It is also worthy of observation that the distribution of this network of railways is extremely unequal, not only in quantity, but in its capability, as indicated by its expense of construction. Thus, in the populous and wealthy States of Massachusetts, New Jersey, and New York, the proportion of railways to surface is considerable, while in the southern and western States it is trifling.

17. The States of Ohio, Indiana, and Illinois, which form the great highway along which the vast tide of western emigration flows, have, within the last few years, been making extraordinary exertions to complete a system of internal railway communication; and, before ten years shall have elapsed, their extensive territory will be literally overspread with a network of railways and canals.

18. A glance at any recent map of the internal communications of the United States will fill any reflecting observer with astonishment at the enterprise of this extraordinary people. A line of railway, already 1200 miles in length, and which is incessantly increasing, stretches along the Atlantic coast. There are besides not less than eight great trunk-lines extending from the seaboard to the interior:—

	Miles.
1. Portland (Maine) to Montreal, communicating with the St. Lawrence and Ottawa rivers . . . . .	300
2. Boston to Ogdensburg, where the St. Lawrence issues from Lake Ontario . . . . .	400
3. Boston to Buffalo on Lake Erie . . . . .	600

## LOCOMOTION BY RIVER AND RAILWAY.

	Miles.
4. New York to Lake Erie . . . . .	400
5. Philadelphia to Pittsburgh on the Ohio . . . . .	400
6. Baltimore to the Ohio . . . . .	350
7. Charleston, South Carolina, to Chatianooogy, in Tennessee	350
8. Savannah, Georgia, to Decatur, Georgia, and Montgomery, on the Alabama . . . . .	500

There are also in progress of construction several detached lines of railway along the southern shores of the great lakes, intended to connect together the numerous cross-lines which traverse that country, and so to form an unbroken system of railway communication with the interior. An extensive line commencing at Galena, on the Upper Mississippi, in the heart of the mining region, crosses the state of Illinois, and passing Chicago, skirts the southern shore of Lake Michigan. This line is complete and under traffic. From Michigan city it crosses the State of that name, arriving at Sandusky, on the southern shore of Lake Erie. From Sandusky this vast artery, following the shore of the lake, arrives at Dunkirk, where it unites with several great trunk-lines, which, traversing the States of New York and Pennsylvania, communicate with the seaboard at Baltimore, Philadelphia, and New York. The extent of this line, running west and east from the Mississippi to the Atlantic, is not less than 1800 miles.

19. When it is considered that the railways in this country have cost upon an average about 40000*l.* per mile, the comparatively low cost of the American railways will doubtless appear extraordinary.

This circumstance, however, is explained partly by the general character of the country, partly by the mode of constructing the railways, and partly by the manner of working them. With certain exceptions, few in number, the tract of country over which these lines are carried is nearly a dead level. Of earthwork there is but little; of works of art, such as viaducts and tunnels, commonly none. Where the railways are carried over streams or rivers, bridges are constructed in a rude but substantial manner of timber supplied from the roadside forest, at no greater cost than that of hewing it. The station-houses, booking-offices, and other buildings, are likewise slight and cheaply constructed of timber. On some of the best lines in the more populous states the timber bridges are constructed with stone pillars and abutments, supporting arches of trusswork, the cost of such bridges varying from 4*s.* per foot, for 60 feet span, to 6*l.* 10*s.* per foot for 200 feet span, for a single line, the cost on a double line being 50 per cent. more.

20. When the railways strike the course of rivers, such as the Hudson, Delaware, or Susquehanna—too wide to be crossed by bridges—the traffic is carried by steam-ferries. The management of these ferries is deserving of notice. It is generally so



## CHEAPNESS OF CONSTRUCTION.

arranged that the time of crossing them corresponds with a meal of the passengers. A platform is constructed level with the line of railway, and carried to the water's edge. Upon this platform rails are laid, by which the waggons which bear the passengers' luggage and other matters of light and rapid transport are rolled directly upon the upper deck of the ferry-boat, the passengers meanwhile going under a covered way to the lower deck. The whole operation is accomplished in five minutes. While the boat is crossing the spacious river, the passengers are supplied with their breakfast, dinner, or supper, as the case may be. On arriving at the opposite bank the upper deck comes in contact with a like platform, bearing a railway, upon which the luggage waggons are rolled; the passengers ascend, as they descended, under a covered way, and, resuming their places in the railway carriages, the train proceeds.

21. The prudent Americans have availed themselves of other sources of economy, by adopting a mode of construction adapted to the expected traffic. Formed to carry a limited commerce, the railways are frequently single lines, sidings being provided at convenient situations. Collision is impossible, for the first train which arrives at a siding must enter it, and remain there until the following train arrives. This arrangement would be attended with inconvenience with a crowded traffic like that of many lines on the English railways, but even on the principal American lines the trains seldom pass in each direction more than twice a day, and their time and place of meeting is perfectly regulated. In the structure of the roads, also, principles have been adopted which have been attended with great economy compared with the English lines. The engineers, for example, do not impose on themselves the difficult and expensive condition of excluding all curves but those of large radius, and all gradients exceeding a certain small limit of steepness. Curves of 500 feet radius, and even less, are frequent, and acclivities rising at the rate of 1 foot in 100 are considered a moderate ascent, while there are not less than fifty lines laid down with gradients varying from 1 in 100 to 1 in 75; nevertheless, these lines are worked with facility by locomotives, without the expedient of assistant or stationary engines. The consequences of this have been to reduce in an immense proportion the cost of earthwork, bridges, and viaducts, even in parts of the country where the character of the surface is least favourable. But the chief source of economy has arisen from the structure of the line itself. In many cases where the traffic is lightest, the rails consist of flat bars of iron, two-and-a-half inches broad and six-tenths of an inch thick, nailed and spiked to planks of timber laid longitudinally on the road in parallel lines, so as to form what are called continuous bearings. Some of the most profitable American

## LOCOMOTION BY RIVER AND RAILWAY.

railways, and those of which the maintenance has proved least expensive, have been constructed in this manner. The road structure, however, varies according to the traffic. Rails are sometimes laid weighing only from 25 lb. to 30 lb. per yard. In some cases of great traffic they are supported on transverse sleepers of wood, like the European railways; but in consequence of the comparative cheapness of wood and the high price of iron, the strength necessary for the road is mostly obtained by reducing the distance between the sleepers, so as to supersede the necessity of giving greater weight to the rails.

22. The same observance of the principles of economy is maintained with regard to their locomotive stock. The engines are strongly built, safe, and powerful, but are destitute of much of that elegance of exterior and beauty of workmanship which have excited so much admiration in the machines exhibited in the Crystal Palace. The fuel is generally wood, but on certain lines near the coal districts coal is used. The use of coke is nowhere resorted to. Its expense would make it inadmissible, and in a country so thinly inhabited, the smoke proceeding from coal is not objected to. The ordinary speed, stoppages included, is from fourteen to sixteen miles an hour. Independently of other considerations, the light structure of many of the roads would not allow a greater velocity without danger; nevertheless, we have frequently travelled on some of the better constructed lines at the ordinary speed of the English railways, say thirty miles an hour and upwards.

Of late years, however, many exceptions to this system of economical construction are presented. The competition for goods traffic which has been recently produced by the great and rapid extension of railway communication has induced the companies to impose a more strict limit on the gradients and curves, and the engineer is often restricted in laying out the lines to gradients not exceeding forty feet per mile, and curves not less than 2000 feet radius.

23. The lines are also more generally now built with greater solidity. The flat bar rail is fast giving way to rails of the more durable form, weighing from 40 lb. to 60 lb. per yard. On the Camden and Amboy roads, rails have lately been laid down, having a depth of not less than seven inches, and weighing 90 lb. per yard.

Within the last few years, also, more attention has been given to the style of the engines. They still continue generally light compared with the English locomotives, but the working machinery vies with that of the river boats in beauty of workmanship, and the engine is often even covered with a profusion of superfluous ornament.

On the railways of the Northern and Eastern States, the platform

## PASSENGER CARRIAGES.

on which the engine-driver stands is now invariably surrounded and covered so as to shelter the engine-driver from the inclemency of the weather, from the cold, wind, and snow in winter, and the scorching rays of the sun in summer. This covering is glazed at the front and the sides, so as to enable the driver to see the line before him, and at either side, and to prevent, at the same time, the blinding effect of rain, snow, or sleet. He is thus always enabled to act with promptitude and energy in case of any accident or emergency.

24. All passenger-carriages on these lines, which make long trips of above twelve hours, are furnished at one extremity with a saloon for ladies only, supplied with sofas, chairs, and all the necessary comforts and conveniences.

The form and structure of the carriages is a source of considerable economy in the working of the lines. The passenger carriages are not distinguished, as in Europe, by different modes of providing for the ease and comfort of the traveller. There are no first, second, and third classes. All are first class, or rather all are of the same class. The carriage consists of a long body like that of a London omnibus, but much wider, and twice or thrice the length. The doors of exit and entrance are at each end; a line of windows being placed at each side, similar exactly to those of an omnibus. Along the centre of this species of caravan is an alley or passage, just wide enough to allow one person to walk from end to end. On either side of this alley are seats for the passengers, extending crossways. Each seat accommodates two persons; four sitting in each row, two at each side of the alley. There are from fifteen to twenty of these seats, so that the carriage accommodates from sixty to eighty passengers. In cold weather, a small stove is placed near the centre of the carriage, the smoke-pipe of which passes out through the roof; and a good lamp is placed at each end for illumination during the night. The vehicle is thus perfectly lighted and warmed. The seats are cushioned; and their backs, consisting of a simple padded board, about six inches broad, are so supported that the passenger may at his pleasure turn them either way, so as to turn his face or his back to the engine. For the convenience of ladies who travel unaccompanied by gentlemen, or who otherwise desire to be apart, a small room, appropriately furnished, is sometimes attached at the end of the carriage, admission to which is forbidden to gentlemen.

25. It will occur at once to the engineer, that vehicles of such extraordinary length would require a railway absolutely straight; it would be impossible to move them through any portion of a line which has sensible curvature. Curves which would be altogether inadmissible on any European line are nevertheless admitted in the construction of American railways without difficulty or hesi-

## LOCOMOTION BY RIVER AND RAILWAY.

tation, and through these the vehicles just described move with the utmost facility. This is accomplished by a simple and effectual arrangement. Each end of this oblong caravan is supported on a small four-wheeled railway truck, on which it rests on a pivot; exactly similar to the expedient by which the forewheels of a carriage sustain the perch. These railway carriages have in fact two perches, one at each end; but instead of resting on two wheels, each of them rests on four. The vehicle has therefore the facility of changing the direction of its motion at each end; and in moving through a curve, one of the trucks will be in one part of the curve while the other is at another,—the length of the body of the carriage forming the *chord* of the intermediate arc! For the purposes they are designed to answer, these carriages present many advantages. The simplicity of the structure renders the expense of their construction incomparably less than that of any class of carriage on an European railway. But a still greater source of saving is apparent in their operation. The proportion of the dead weight to the profitable load is far less than in the first or second-class carriages, or even than in the third-class on the English railways. It is quite true that these carriages do not offer to the wealthy passenger all the luxurious accommodation which he finds in our best first-class carriages; but they afford every necessary convenience and comfort.

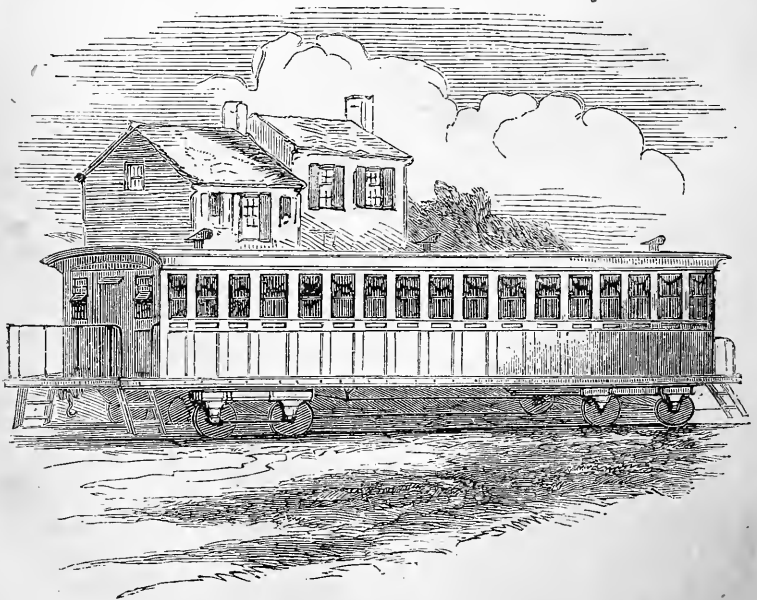



AMERICAN RAILWAY CARRIAGE.—INTERIOR.

## LOCOMOTION BY RIVER AND RAILWAY IN THE UNITED STATES.

### CHAPTER III.

1. Railways carried to centre of cities—Mode of turning corners of streets.—2. Accidents rare.—3. Philadelphia and Pittsburgh line.—4. Extent and returns of railways.—5. Traffic returns.—6. Western lines—Transport of agricultural produce.—7. Prodigious rapidity of progress.—8. Extent of common roads.—9. Railways chiefly single lines.—10. Organisation of companies and acts of incorporation.—11. Extent of railways in proportion to population.—12. Great advantages of facility of inland transport in the United States.—13. Passengers not classed.—14. Recent report on the financial condition of the United States railways.—15. Table of traffic returns on New England lines.—16. Cuban railways.—17. Recapitulation.

1. IN several of the principal American cities, the railways are continued to the very centre of the town, following the windings of the streets, and turning without difficulty the sharpest corners. The locomotive station is, however, always in the suburbs. Having arrived there, the engine is detached from the train, and

## LOCOMOTION BY RIVER AND RAILWAY.

horses are yoked to the carriages, by which they are drawn to the passenger depôt, usually established at some central situation. Four horses are attached to each of these oblong carriages. The sharp curves at the corners of the streets are turned, by causing the outer wheels of the trucks to run upon their flanges, so that they become (while passing round the curve) virtually larger wheels than the inner ones. I have seen, by this means, the longest railway carriages enter the depôts in Philadelphia, Baltimore, and New York, with as much precision and facility as was exhibited by the coaches that used to enter the gateway of the Golden Cross or the Saracen's Head.

2. Notwithstanding the apparently feeble and unsubstantial structure of many of the lines, accidents to passenger trains are scarcely ever heard of. It appears by returns now before us that of 9,355,474 passengers booked in 1850 on the crowded railways of Massachusetts, each passenger making an average trip of eighteen miles, there were only fifteen who sustained accidents fatal to life or limb. It follows from this, that when a passenger travels one mile on these railways, the chances against an accident producing personal injury, even of the slightest kind, are 11,226,568 to 1; and, of course, in a journey of 100 miles, the chances against such accident are 112,266 to 1. It has been shown that the chances against accident on an English railway, under like circumstances, are 40,000 to 1.\* The American railways are, therefore, safer than the English in the ratio of 112 to 40.

3. A great line of communication was established, 400 miles in length, between Philadelphia and Pittsburg, on the left bank of the Ohio, composed partly of railway and partly of canal. The section from Philadelphia to Colombia (eighty-two miles) is railway; the line is then continued by canal for 172 miles to Holidaysburg; it is then carried by railway thirty-seven miles to Johnstown, whence it is continued 104 miles further to Pittsburg by canal. The traffic on this mixed line of transport was conducted so as to avoid the expense and inconvenience of transshipment of goods and passengers at the successive points where the railway and canals unite. The merchandise was loaded and the passengers accommodated in the boats adapted to the canals at the depôt in Market Street, Philadelphia. These boats, which were of considerable magnitude and length, were divided into segments by partitions made transversely, and at right angles to their length, so that each boat can be, as it were, broken into three or more pieces. These several pieces were placed each on two railway trucks, which support it at its ends, a proper body being

\* Museum, Vol. i., p. 168.

## PHILADELPHIA AND PITTSBURG.

provided for the trucks, adapted to the form of the bottom and keel of the boat. In this manner the boat was carried in pieces, with its load, along the railway. On arriving at the canal, the pieces were united so as to form a continuous boat, which being launched, the transport is continued on the water. On arriving again at the railway, the boat was once more resolved into its segments, which, as before, were transferred to the railway trucks, and transported to the next canal station by locomotive engines. Between the depôt in Market Street and the locomotive station, situated in the suburbs of Philadelphia, the segments of the boat were drawn by horses on railways conducted through the streets. At the locomotive station the trucks were formed into a continuous train, and delivered over to the locomotive engine. As the body of the truck rests upon a pivot, under which it is supported by wheels, it is capable of revolving, and no difficulty is found in turning the shortest curves; and these enormous vehicles, with their contents of merchandise and passengers, were seen daily issuing from the gates of the depôt in Market Street, and turning with facility the corners at the entrance of each successive street.

More recently, a continuous line of railway has been completed, and is now in operation, between Philadelphia and Pittsburgh. Indeed, so rapid is the progress of improvement in the United States, that a report of the state of inland communication, as it existed a year or two ago, will be found to be full of inaccuracies as applied to the present moment.

4. By a comparison of the returns published in my work already quoted, with the more recent results already given, it will appear that within the last four years not less than 6750 miles of railway have been opened for traffic in the United States. Among these are included several of the most important lines, of which the most especially to be noticed is the great artery of railway communication extending across the State of New York to the shores of Lake Erie, the longest line which any single company has yet constructed in the United States, its length being 467 miles. The total cost of this line, including the working stock, has been 4,500000*l.* sterling, being at the average rate of 9636*l.* per mile—a rate of expense about 50 per cent. above the average cost of the American railways taken collectively. This is explained by the fact that the line itself is one constructed for a large traffic between New York and the Interior, and therefore built to meet a heavy traffic. Immediately after being opened, its average receipts have amounted to 11000*l.* per week, which gave a net profit of 6½ per cent. on the capital, the working expenses being taken at 50 per cent. of the gross receipts. One of the great lines connects New York with Albany, following the valley of the

## LOCOMOTION BY RIVER AND RAILWAY.

Hudson. It will no doubt create surprise, considering the immense facility of water transport afforded by this river, that a railway should be constructed on its bank, but it must be remembered that for a considerable interval during the winter the navigation of the Hudson is suspended from the frost.

5. It is difficult to obtain authentic reports from which the movement of the traffic on the American railways can be ascertained with precision. I obtained, however, the necessary statistical data relating to nearly 1200 miles of railway in the states of New England and New York, from which I was enabled to collect all the circumstances attending the working of these lines.

It appears from calculations, the details of which will be found in my work,\* that upon those railways the total average receipts per mile per annum was 4694*l.*, and that the profit per cent. of capital amounted to 8·6 per cent.

6. It appears by recent and well-authenticated returns, that the Western lines, most of which are of recent construction, and derive their revenue almost exclusively from the transport of agricultural produce, have proved even more profitable than the Eastern Railways, whose traffic is chiefly passengers. A large proportion of these Western lines paid from 7 to 10 per cent., even before they were quite completed, according to a report obtained by the "Times."† This prosperous result was obtained even from the lines which traversed uncleared districts and dense forests. The source of this advantage is the profit sure to be obtained from the transport of agricultural produce. In these districts there are no inland markets. The farmer is obliged to send his produce either to the sea-coast or to the bank of one of the great rivers, where alone markets are found. There alone are the manufacturers, and there alone the exporting merchants established. It has been proved that agricultural produce can, at least in the United States, be transported on railways at one-tenth of the expense of its carriage on common roads. In the following table (page 53) is given the comparative value of a ton of wheat and of maize at various distances from the farm-yard, the cost of its transport by each mode of conveyance being deducted from its cost at the place of production.

It appears, therefore, that the whole value of wheat is absorbed by the cost of its transport 330 miles on a common road, while 10 per cent. of its value is absorbed by its transport the same distance by railway. In like manner, while the entire value of maize is absorbed by its transport over 160 miles of common road, no more than  $9\frac{3}{4}$  per cent. of its value is absorbed by transport to the same distance by railway.

\* Railway Economy, chap. xvi.

† September 3, 1853.



GOODS TRANSPORT.

Value at . . .	Transportation by Railroad.		Transportation by Ordinary Highway.	
	Wheat. dols. c.	Maize. dols. c.	Wheat. dols. c.	Maize. dols. c.
10 miles . . .	49 50	24 75	49 50	24 75
20 " . . .	49 35	24 60	48 0	23 25
30 " . . .	49 20	24 45	46 50	21 75
40 " . . .	49 5	24 30	45 0	20 25
50 " . . .	48 90	24 15	43 50	18 75
60 " . . .	48 75	24 0	42 0	17 25
70 " . . .	48 60	23 85	40 50	15 75
80 " . . .	48 45	23 70	39 0	14 25
90 " . . .	48 30	23 55	37 50	12 75
100 " . . .	48 15	23 40	36 0	11 25
110 " . . .	48 0	23 25	34 50	9 75
120 " . . .	47 85	23 10	33 0	8 25
130 " . . .	47 70	22 95	31 50	6 75
140 " . . .	47 55	22 80	30 0	5 25
150 " . . .	47 40	22 65	28 50	3 75
160 " . . .	47 25	22 50	27 0	2 25
170 " . . .	47 10	22 35	25 50	0 75
180 " . . .	46 95	22 20	24 0	
190 " . . .	46 80	22 5	22 50	
200 " . . .	46 65	21 90	21 0	
210 " . . .	46 50	21 75	19 50	
220 " . . .	46 35	21 60	18 0	
230 " . . .	46 20	21 45	16 50	
240 " . . .	46 5	21 30	15 0	
250 " . . .	45 90	21 15	13 50	
260 " . . .	45 75	21 0	12 0	
270 " . . .	45 60	20 85	10 50	
280 " . . .	45 45	20 70	9 0	
290 " . . .	45 30	20 55	7 50	
300 " . . .	45 15	20 40	6 0	
310 " . . .	45 0	20 25	4 50	
320 " . . .	44 85	20 10	3 0	
330 " . . .	44 70	19 95	1 50	
330 " . . .	44 55	19 80	0 0	

These results are important to the holder of stock in these western lines, in so far as they demonstrate how permanent and secure must be the revenue of the western railroads. The vast bulk of the western population is agricultural, and will long continue to be so, and by far the largest proportion of the receipts of their railways will be from the transportation of freight. There is, besides, hardly a country in the world where the same amount of labour produces an equal amount of freight. These, and other reasons which will suggest themselves from the facts given, go to show how solid the basis would seem to be for the prosperity of the western roads generally, while the premium for which their

## LOCOMOTION BY RIVER AND RAILWAY.

stocks are selling, and the dividends they divide, illustrate the matter by incontestable facts.

The year 1852 was the most prosperous year for the American western railroads in operation and in progress. Their increased earnings are said, upon good authority, to average an increase of 15 per cent. upon their *mileage*, and 10 per cent. upon their *cost*. This vast increase is attributed partly to abundant crops and partly to a general increase of activity in every department of business; but in that country more than in any other, the extension of the railroad system seems likely to exert a beneficial effect upon each individual railroad for itself. There is scarcely such a thing now heard of as travelling or freight transportation, except on railroads or by water. The public sees that undue importance has been hitherto attached to canals, and it is now found to be difficult, if indeed it will not ultimately prove impossible, to get the people of the State of New York to appropriate 10,000,000 dollars more for the final enlargement or completion of the canals already built in that State alone. Transportation or travel by canals is too slow—it does not suit the electric speed of the age. We may, therefore, expect in the future that little more will be done for canals, while a network of railroads seems destined inevitably to cover that continent.

7. Americans themselves can hardly imagine the railroad progress of the United States till they come to the figures of what has actually been done; much less can they comprehend their probable progress in the future. Those who have bestowed the most reflection on the subject entertain no doubt that the construction of railways in the south-west and west—that boundless granary of the world—will continue and increase with augmented ratio for a long time to come. If that vast district should be supplied with railways as Massachusetts now is, it would demand at least 100000 miles of railway! What political economist in England or in America can fail to draw an inference here in favour of Free Trade? With the superior facilities of Great Britain for manufacturing iron, and the still greater facilities of the United States for the prosecution of agriculture, who is so blind as not to see that they ought to take our iron and to pay for it in bread, unless bad and unhealthy legislation interrupt this natural order of the law of Providence? \*

8. The extraordinary extent of railway constructed at so early a period in the United States has been by some ascribed to the absence of a sufficient extent of communication by common roads. Although this cause has operated to some extent in certain districts, it is by no means so general as has been supposed. In the year

\* "Times," September 3, 1853.

## EXTENT OF RAILWAYS.

1838, the United States mails circulated over a length of way amounting on the whole to 136218 miles, of which two-thirds were land transport, including railways as well as common roads. Of the latter there must have been about 80000 miles in operation, of which, however, a considerable portion was bridle-roads. The price of transport in the stage coaches was, upon an average, 3·25*d.* per passenger per mile, the average price by railway being about 1·47*d.* per mile.

From what has been stated above, it will be apparent that the true cause of the vast extension of railways in the United States is the immense economy and speed of transport upon them compared with transport on common roads.

9. Of the entire extent of railway constructed in the United States, by far the greater portion, as has been already explained, consists of single lines, constructed in a light and cheap manner, which in England would be regarded as merely serving temporary purposes: while, on the contrary, the entire extent of the English system consists, not only of double lines, but of railways constructed in the most solid, permanent and expensive manner, adapted to the purposes of an immense traffic. If a comparison were to be instituted at all between the two systems, its basis ought to be the capital expended, and the traffic served by them, in which case the result would be somewhat different from that obtained by the mere consideration of the length of the lines. It is not, however, the same in reference to the canals, in which it must be admitted that America far exceeds all other countries in proportion to her population.

10. The American railways have been generally constructed by joint-stock companies, which, however, the State controls much more stringently than in England. In some cases a major limit to the dividends is imposed by the statute of incorporation, in some the dividends are allowed to augment, but when they exceed a certain limit the surplus is divided with the State; in some the privilege granted to the companies is only for a limited period, in some a sort of periodical revision and restriction of the tariff is reserved to the State. Nothing can be more simple, expeditious, and cheap than the means of obtaining an act for the establishment of a railway company in America. A public meeting is held at which the project is discussed and adopted, a deputation is appointed to apply to the Legislature, which grants the Act without expense, delay, or official difficulty. The principle of competition is not brought into play as in France, nor is there any investigation as to the expediency of the project with reference to future profit or loss, as in England. No other guarantee or security is required from the company than the

payment by the shareholders of a certain amount, constituting the first call. In some States the non-payment of a call is followed by the confiscation of the previous payments, in others a fine is imposed on the shareholders, in others the share is sold, and if the produce be less than the price at which it was delivered, the surplus can be recovered from the shareholder by process of law. In all cases the Acts creating the companies fix a time within which the works must be completed, under pain of forfeiture. The traffic in shares before the definite constitution of the company is prohibited.

Although the State itself has rarely undertaken the execution of railways, it holds out, in most cases, inducements in different forms to the enterprise of companies. In some cases the State takes a great number of shares, which is generally accompanied by a loan made to the company, consisting in State stock delivered at par, which the company negotiate at its own risk. This loan is often converted into a subvention.

11. The great extent of internal communication, by railways and canals, in America, in proportion to its population, has been a general subject of admiration. The population of the United States in 1840 amounted to 17 millions, and if its rate of increase during the ten years commencing at that epoch be equal to the rate during the preceding ten years, its present population must be about 23 millions. There are, as I have stated, about 6500 miles of railway in actual operation within the territory of the Union. This, in round numbers, is at the rate of one mile of railroad for every 3200 inhabitants.

In the United Kingdom, there are in operation 5000 miles of railway, with a population of 30 millions, which is at the rate of one mile for every 6000 inhabitants.

It would therefore appear that, in proportion to the population, the length of railway communication in the United States is greater than in the United Kingdom in the proportion of 6 to  $3\frac{1}{2}$ . The result of this calculation, however, requires considerable modification.

12 There is no country where easy and rapid means of communication are likely to produce more beneficial results than in the United States. Composed of twenty-six independent republics, having various, and in some instances opposite interests, the American confederacy would speedily be in danger of dissolution, if its population, scattered over a territory so vast, were not united by communications sufficiently rapid to produce a practical diminution of distance. In this means of intercommunication, Nature has greatly aided the efforts of art, for certainly no country in the world presents such magnificent lines of natural water communication.

To say nothing of the streams which intersect the Atlantic States, and carry an amount of inland steam navigation wholly

## FINANCIAL RESULTS.

unexampled in Europe, we have the gigantic stream of the Mississippi, intersecting the immense valley to which it gives its name, with innumerable tributaries, navigable by steam-boats having a tonnage of first-rate ships for many thousands of miles, and traversing territories which present immense tracts of soil, of the highest degree of fertility, as well as sources of mineral wealth which are as yet unexplored.

13. On the American railways, passengers are not differently classed, or admitted at different rates of fare, as on those in Europe. There is but one class of passengers and one fare. In one or two instances, second and third-class carriages were attempted to be established, but it was found that the number of passengers availing themselves of the lower fares and inferior accommodation was so small that they were discontinued. The only distinction observable among passengers on railways is that which arises from colour. The coloured population, whether emancipated or not, are generally excluded from the vehicles provided for the whites. Such travellers are but few; and they are usually accommodated either in the luggage van or in the carriage in which the guard or conductor travels.

14. We take the following observations on the financial condition of the railways of the United States from the report already quoted from the "Times." Although it emanates evidently from a partisan, it is from an intelligent, well-informed, and honest partisan, and is well deserving of attention.

"1. In all instances the railroads of the United States have received their charters from the governments of the several States through which their routes extend. I am not aware, with a few exceptions, of an instance in which the application of a company for a charter for a railway has been refused, provided the responsibility of the applicants, or the amount of capital stock subscribed, has afforded a satisfactory guarantee for the execution of their designs. The powers and privileges conferred by these State charters are very similar to those conferred by the British Parliament. Railroad property in the United States occupies the same relations to State Governments as the property of individuals: The companies are independent in their action, and responsible to the State authorities as private citizens.

"2. I shall dwell more particularly upon the western railroads, because their history, condition, and prospects more materially concern European readers, their bonds being those now most frequently in the market. A very large number of the western railroads have obtained their charters under what are termed general railroad laws, in distinction from special statutes enacted for the incorporation of companies named within the Acts.

## LOCOMOTION BY RIVER AND RAILWAY.

Within the last few years the tendency in this country has been to general rather than to special legislation. The great States (New York leading the way) have many of them enacted general laws authorising the construction and providing for the management of railways, as well as other corporations and great institutions. General railroad laws now exist in New York, Illinois, Ohio, Indiana, and Wisconsin, in all which States special charters conferring special powers are prohibited. The same principle of legislation will doubtless be adopted in other States. There are many advantages to the public in general laws, particularly as they concern railways; for monopolies are thereby rendered impossible, and the principle of *laissez faire* is adopted and carried out with the least possible interference with private rights. Under their operation, associations of men have the same right to construct railroads as to build factories or ships, and it is found by experience that each community is fully competent to regulate its own affairs.

“3. The stock and bonds of railroads are regarded as personal property, and, as such, within specific limitations, subject to taxation. No tax ever can be laid upon the bed of a road, its iron, cars, &c.; but where valuable real estate is owned for depôts, taxes may be levied. But shares and bonds can only be taxed to the holder thereof; and, of course, cannot be taxed when held abroad. In this respect, European holders of American shares and stocks have an advantage over ourselves.

“4. Companies organised under general laws cannot be dissolved without special authority from the legislature of a State; and, if the time comes that any American railway company asks for a dissolution, then, and then only, will the property of the company be distributed *pro rata* among the stockholders. I do not know of a single onerous condition or obligation laid upon an American railroad company by any State, while I am not aware that any railroad corporation has been formed in England of which the same can be said.

“5. No railroad can exist in the United States that has any right to declare dividends until it has discharged all its obligations due at the time; and all its bonds and debts of every description take precedence, and can be prosecuted and collected before the original stockholders can either receive a dividend or profit from it in any shape whatever. If there be a failure to pay its bonds or mortgages, the bondholders or mortgagees can, by a short and simple legal process, become vested with entire control over the property, and manage it on their own account. In other words, the right to apply the well-known principles of law to the relation of mortgagees and mortgagors obtain in all our railroads,

## FINANCIAL RESULTS.

and they can be enforced by any court of equity within the judicial district. The payment of railroad bonds is generally secured by deed of trust to some known and responsible citizen of New York as trustee, with full power given in the deed to the trustee to take possession of the road, its income, franchises, personal effects, &c., in case of default, and to sell the same for cash to the highest bidder, at sixty days' notice, without the intervention of a Court of Chancery.

“6. Nearly all the bonds issued by American railways have the same general features. They are either secured by mortgage upon the property of the roads themselves, or they are common bonds for the payment of money. But they are subdivided into two classes—those which are convertible into stock at the option of the owner, to the amount on their face, whenever the holder sees fit ; or they have no such condition attached. Convertible bonds have an advantage over the latter, inasmuch as they can be converted into stock so soon as that stock rises above par. This condition has been found peculiarly advantageous to many of the holders of the bonds on the western roads, since the stocks of most of these roads have gone above par as soon as they were completed.

“7. Nearly all the western railroads were projected and built for the special benefit of the people themselves in those districts through which they pass. Their sole object was to be brought nearer to a market for their produce, and many municipal bodies subscribed for stocks with no expectation that they would ever become valuable in any other way. Capital was scarce in the west, as it is in most new countries. There was a serious want of outlets to New York and navigable streams. Hence these railroads were undertaken with the expectation of general advantages to the community. But cities and counties could not create debts, or expend the money in their treasuries for such purposes, without special authorisation from the State legislatures. The object of this was to give character and legality to their acts, that they might have binding force, and also to equalise the burden of those debts over the owners of property in those sections. The charters, therefore, of almost all the western railroads authorised those cities and counties through which they passed to subscribe by a uniform mode to the stock of those roads. But invariably one safe condition was attached to this permission—that such action should also be authorised by a vote of the majority of the citizens themselves. This voluntary principle has worked admirably ; because no city or county has had the right to subscribe for stock in roads until a majority of the voters thereof so decided ; and thus the highest sanction of the will of the taxpayers and of law was imparted to their action. In no one instance can I

## LOCOMOTION BY RIVER AND RAILWAY.

ascertain that any city or county has thus incurred a debt of more than from 2 to 5 per cent. on the taxable property of its citizens. The amount subscribed by cities and counties has ranged from 50,000 to 400,000 dollars, where the taxables would rise as high as from 4,000,000 to 16,000,000 dollars.

“8. These municipal debts thus created have been secured by all the guarantees that the State legislatures could throw around them. The cities and counties have been required to levy and collect, in case of necessity, taxes (as any and all other municipal taxes are) from their own citizens, sufficient to pay the interest, and provide a balance as a sinking fund to pay off the debt, when it should finally become due. In no instance has any western city or county hitherto neglected to do this, nor is it likely that any ever will.

“9. The bonds thus issued to railroad companies by cities and counties are guaranteed by the roads, and then sold in the market. They have all the legal force of a lien on all the property of those cities or counties, real and personal, and, if the proper authorities do not provide for the payment of the interest and principal, a *mandamus*, or an ordinary suit at law, can be issued, by which all the real and personal property of the citizens of those cities and counties can be attached and sold. Many years since the city of Bridgeport, in Connecticut, gave her bonds to a railway company for 100,000 dollars. For some reason the payment of these bonds was delayed. A holder brought a suit against the city in the State Court, and the Supreme Court decided on appeal that the individual property, real and personal, of each citizen, was liable for the debt of the city, and could be sold on execution of the decree.

“10. The operation of these laws and of this system of subscription to roads has been uniformly, I believe, beneficent. I cannot learn that there is a completed road in Ohio, for instance, that has paid less than from 10 to 14 per cent. ; and, as in a great majority of instances, the cities and counties that gave their bonds have been enabled, either by converting them at their will into stock or otherwise, to sell them, and often at a large premium, thus realising large profits for thus lending their credit. The city of Cleveland, in Ohio, subscribed 400,000 dollars to two or three roads, and she is now selling that stock at a premium of from 24 to 27 dollars advance. Her taxable property since 1849 has risen from 3,000,000 to 7,000,000 dollars, while the population as well as taxable property has increased in almost the same ratio in those cities and those counties throughout the west where railroads have been built.”

15. It would be extremely interesting, were it practicable, to obtain even an approximate estimate of the actual commerce in



## ANALYSIS OF TRAFFIC.

passengers and goods on the American railways. No such general return, however, is attainable. In my work on Railway Economy, in the absence of more complete information, I have given the necessary statistical data to determine the commerce on nearly twelve hundred miles of railway in the States of New England and in that of New York, from which I was enabled to calculate all the circumstances attending the working of these lines. I have, accordingly, given these in the following table :—

**TABULAR ANALYSIS of the average daily Movement of the Traffic on Twenty-eight principal Railways in the States of New England and in the State of New York during the year 1847.**

	PASSENGER TRAFFIC.				GOODS TRAFFIC.			
	Number booked.	Mileage.	Receipts.	Mileage of Trains.	Tons booked.	Mileage.	Receipts.	Mileage of Trains.
Albany and Schenectady . . . . .	630	9,787	£ 65	136			32	62
Utica-Schenectady . . . . .	733	37,600	300	406			111	360
Syracuse-Utica . . . . .	544	21,550	169	288			38	151
Auburn-Rochester . . . . .	518	24,200	197	400			37	212
Tonawanda . . . . .	367	13,000	92	212			23	40
Attica-Buffalo . . . . .	358	9,850	61	162			19	48
Saratoga-Schenectady . . . . .	146	2,068	22	54	1730*	65,550*	4	4
Troy-Schenectady . . . . .	189	3,840	20	140			8	9
Ranssailer-Saratoga . . . . .	181	2,625	24	680			12	26
Troy and Greenbush . . . . .	545	3,090	21	181			25	19
New York and Harlem . . . . .	4,336	17,000	133	450			80	170
New York-Erie . . . . .	326	12,400	60	246			102	191
Boston-Worcester . . . . .	1,640	39,672	180	580	775	29,450	221	459
Western . . . . .	1,062	48,952	296	648	752	76,580	471	1,408
Norwich-Worster . . . . .	434	8,158	67	326	249	7,858	64	204
Connecticut River . . . . .	650	6,454	42	203	122	2,210	28	64
Pittsfield-N. Adam . . . . .	98	11,048	9	45	29	469	6	31
Boston-Providence . . . . .	1,338	19,680	133	464	240	5,310	69	143
Tarenton . . . . .	297	3,234	20	60	83	910	10	19
New Bedford . . . . .	268	4,460	40	173	53	930	13	53
Stoughton Branch . . . . .	46	482	3	11	22	238	3	4
Lowell . . . . .	1,328	26,050	120	452	770	19,450	139	194
Nashua . . . . .	618	8,540	41	81	414	6,130	49	55
Boston-Maine . . . . .	1,995	34,500	189	625	330	9,880	106	200
Fitchburg . . . . .	1,342	21,920	98	434	670	14,230	119	192
Eastern . . . . .	2,240	34,910	203	557	112	3,190	30	93
Old Colony . . . . .	1,068	13,420	73	288	117	2,048	24	77
Fall River . . . . .	474	8,860	46	219	79	1,718	18	72
	23,771	447,350	2,724	8,471	6,547	246,151	1,861	4,560

\* The reports do not supply the tonnage and mileage of these railways separately, and the above numbers are estimated by analogy with the other American railways.

## LOCOMOTION BY RIVER AND RAILWAY.

Total length of the above railways in the State of New York	Miles. 490
" " " States of New England	670
Total . . . . .	1160

Average cost of construction and stock per mile in the		£
State of New York		7,010
" " " States of New England		10,800
General average . . . . .		9,200

	Receipts.	Expenses.	Profits.
Total average receipts, expenses, and profits per day in the State of New York	1654	684	970
" " States of New England	3040	1505	1535
Totals . . . . .	4694	2189	2505

	Per Mile of Railway per day.	Per Mile run by Trains.	Per Cent. per Annum on Capital.
Receipts . . . . .	4·05	7 5	16·1
Expenses . . . . .	1·89	3 5½	7·5
Profits . . . . .	2·16	2 11½	8·6
Expense per cent. of receipts			46·8

Average receipts per passenger booked	27·0d.
Average distance travelled per passenger . . . . .	18·2 miles.
Average receipts per passenger per mile . . . . .	1·47d.
Average number of passengers per train . . . . .	54·0
Total average receipts per passenger train per mile	7s.
Average receipts per ton of goods booked . . . . .	5s. 8½d.
Average distance carried per ton . . . . .	38·0 miles.
Average receipts per ton per mile . . . . .	1·8d.
Average number of tons per train . . . . .	54·5
Total average receipts per goods train per mile . . . . .	8·2s.

The railways, of the traffic of which I have here given a synopsis, include the most active and profitable enterprises of this kind in the United States. We cannot, therefore, infer from the results obtained the corresponding movement on the remaining lines. It appears that of the entire system of American railways, the dividends, exclusive of those contained in the preceding analysis, are in general small, and in many instances nothing. It is therefore probable that, in the aggregate, the average profits on the total amount of capital invested in the railways do not exceed, if they equal, the average profits obtained on the capital invested in English railways.

16. Although Cuba is not yet *annexed* to the United States, its local proximity here suggests some notice of a line of railway which traverses that island, forming a communication between the

## CONCLUSION.

city of Havannah and the centre of the island. This is an excellently constructed road, and capially worked by British engines, British engineers, and British coals. The impressions produced in passing along this line of railway, though different from those already noticed in the forests of the far west, is not less remarkable. We are here transported at thirty miles an hour by an engine from Newcastle, driven by an engineer from Manchester, and propelled by fuel from Liverpool, through fields yellow with pine-apples, through groves of plantain and cocoa-nut, and along roads inclosed by hedge-rows of ripe oranges.

17. To what extent this extraordinary rapidity of advancement made by the United States in its inland communications is observable in other departments will be seen by the following table, exhibiting a comparative statement of those data, derived from official sources, which indicate the social and commercial condition of a people through a period which forms but a small stage in the life of a nation :—

X	-1793-	1851.
Population . . . . .	3,939,325	24,267,488
Imports . . . . .	£6,739,130	£38,723,545
Exports . . . . .	£5,675,869	£32,367,000
Tonnage . . . . .	520,704	3,535,451
Lighthouses, beacons, and lightships	7	373
Cost of their maintenance . . . . .	£2,600	£115,000
Revenue . . . . .	£1,230,000	£9,516,000
National expenditure . . . . .	£1,637,000	£8,555,000
Post-offices . . . . .	209	21,551
Post roads (miles) . . . . .	5,642	178,670
Revenues of Post-office . . . . .	£22,800	£1,207,000
Expenses of Post-office . . . . .	£15,650	£1,130,000
Mileage of mails . . . . .	—	46,541,423
Canals (miles) . . . . .	—	5,000
Railways (miles) . . . . .	—	10,287
Electric telegraph (miles) . . . . .	—	15,000
Public libraries (volumes) . . . . .	75,000	2,201,623
School libraries (volumes) . . . . .	—	2,000,000

If they were not founded on the most incontestable statistical data, the results assigned to the above table would appear to belong to fable rather than history. In an interval of little more than half a century it appears that this extraordinary people have increased above 500 per cent. in numbers; their national revenue has augmented nearly 700 per cent., while their public expenditure has increased little more than 400 per cent. The prodigious extension of their commerce is indicated by an increase of nearly 500 per cent. in their imports and exports, and 600 per cent. in

their shipping. The increased activity of their internal communications is expounded by the number of their post-offices, which has been increased more than a hundred fold; the extent of their post-roads, which has been increased thirty-two fold; and the cost of their post-office, which has been augmented in a seventy-two fold ratio. The augmentation of the machinery of public instruction is indicated by the extent of their public libraries, which have increased in a thirty-one fold ratio, and by the creation of school libraries, amounting to 2,000,000 volumes. They have completed a system of canal navigation, which, placed in a continuous line, would extend from London to Calcutta; and a system of railways which, continuously extended, would stretch from London to Van Diemen's Land, and have provided locomotive machinery by which that distance would be travelled over in three weeks, at the cost of  $1\frac{1}{2}d.$  per mile. They have created a system of inland navigation, the aggregate tonnage of which is probably not inferior in amount to the collective inland tonnage of all the other countries in the world; and they possess many hundreds of river steamers, which impart to the roads of water the marvellous celerity of roads of iron. They have, in fine, constructed lines of electric telegraph which, laid continuously, would extend over a space longer by 3000 miles than the distance from the north to the south pole, and have provided apparatus of transmission by which a message of three hundred words despatched under such circumstances from the north pole might be delivered *in writing* at the south pole in one minute, and by which, consequently, an answer of equal length might be sent back to the north pole in an equal interval.

These are social and commercial phenomena for which it would be vain to seek a parallel in the past history of the human race.\*

\* Lardner on the Great Exhibition, p. 251.

LONDON, May, 1874.

# A Catalogue of Books

INCLUDING MANY

## NEW & STANDARD WORKS

IN

ENGINEERING, ARCHITECTURE,  
AGRICULTURE, MATHEMATICS, MECHANICS,  
SCIENCE, &c. &c.

PUBLISHED BY

**LOCKWOOD & CO.,**

7, STATIONERS'-HALL COURT, LUDGATE HILL, E.C.

---

### ENGINEERING, SURVEYING, &c.

---

#### *Humber's New Work on Water-Supply.*

A COMPREHENSIVE TREATISE on the WATER-SUPPLY of CITIES and TOWNS. By WILLIAM HUMBER, Assoc. Inst. C.E., and M. Inst. M.E. Author of "Cast and Wrought Iron Bridge Construction," &c. &c. This work, it is expected, will contain about 50 Double Plates, and upwards of 300 pages of Text. Imp. 4to, half bound in morocco. [In the press.]

\* \* \* *In accumulating information for this volume, the Author has been very liberally assisted by several professional friends, who have made this department of engineering their special study. He has thus been in a position to prepare a work which, within the limits of a single volume, will supply the reader with the most complete and reliable information upon all subjects, theoretical and practical, connected with water supply. Through the kindness of Messrs. Anderson, Bateman, Hawksley, Homersham, Baldwin Latham, Lawson, Milne, Quick, Rawlinson, Simpson, and others, several works, constructed and in course of construction, from the designs of these gentlemen, will be fully illustrated and described.*

AMONGST OTHER IMPORTANT SUBJECTS THE FOLLOWING WILL BE TREATED IN THE TEXT:—

Historical Sketch of the means that have been proposed and adopted for the Supply of Water.—Water and the Foreign Matter usually associated with it.—Rainfall and Evaporation.—Springs and Subterranean Lakes.—Hydraulics.—The Selection of Sites for Water Works.—Wells.—Reservoirs.—Filtration and Filter Beds.—Reservoir and Filter Bed Appendages.—Pumps and Appendages.—Pumping Machinery.—Culverts and Conduits, Aqueducts, Syphons, &c.—Distribution of Water.—Water Meters and general House Fittings.—Cost of Works for the Supply of Water.—Constant and Intermittent Supply.—Suggestions for preparing Plans, &c. &c., together with a Description of the numerous Works illustrated, viz:—Aberdeen, Bideford, Cockermouth, Dublin, Glasgow, Loch Katrine, Liverpool, Manchester, Rotherham, Sunderland, and several others; with copies of the Contract, Drawings and Specification in each case.

## *Humber's Modern Engineering. First Series.*

A RECORD of the PROGRESS of MODERN ENGINEERING, 1863. Comprising Civil, Mechanical, Marine, Hydraulic, Railway, Bridge, and other Engineering Works, &c. By WILLIAM HUMBER, Assoc. Inst. C.E., &c. Imp. 4to, with 36 Double Plates, drawn to a large scale, and Photographic Portrait of John Hawkshaw, C.E., F.R.S., &c. Price 3*l.* 3*s.* half morocco.

### *List of the Plates.*

NAME AND DESCRIPTION.	PLATES.	NAME OF ENGINEER.
Victoria Station and Roof—L. B. & S. C. Rail.	1 to 8	Mr. R. Jacobm Hood, C.E.
Southport Pier .....	9 and 10	Mr. James Brunlees, C.E.
Victoria Station and Roof—L. C. & D. & G. W. Railways .....	11 to 15A	Mr. John Fowler, C.E.
Roof of Cremorne Music Hall.....	16	Mr. William Humber, C.E.
Bridge over G. N. Railway .....	17	Mr. Joseph Cubitt, C.E.
Roof of Station—Dutch Rhenish Railway ..	18 and 19	Mr. Euschedi, C.E.
Bridge over the Thames—West London Extension Railway .....	20 to 24	Mr. William Baker, C.E.
Armour Plates .....	25	Mr. James Chalmers, C.E.
Suspension Bridge, Thames.....	26 to 29	Mr. Peter W. Barlow, C.E.
The Allen Engine .....	30	Mr. G. T. Porter, M.E.
Suspension Bridge, Avon .....	31 to 33	Mr. John Hawkshaw, C.E. and W. H. Barlow, C.E.
Underground Railway .....	34 to 36	Mr. John Fowler, C.E.

With copious Descriptive Letterpress, Specifications, &c.

“ Handsomely lithographed and printed. It will find favour with many who desire to preserve in a permanent form copies of the plans and specifications prepared for the guidance of the contractors for many important engineering works.”—*Engineer.*

## *Humber's Modern Engineering. Second Series.*

A RECORD of the PROGRESS of MODERN ENGINEERING, 1864; with Photographic Portrait of Robert Stephenson, C.E., M.P., F.R.S., &c. Price 3*l.* 3*s.* half morocco.

### *List of the Plates.*

NAME AND DESCRIPTION.	PLATES.	NAME OF ENGINEER.
Birkenhead Docks, Low Water Basin .....	1 to 15	Mr. G. F. Lyster, C.E.
Charing Cross Station Roof—C. C. Railway.	16 to 18	Mr. Hawkshaw, C.E.
Digswell Viaduct—Great Northern Railway.	19	Mr. J. Cubitt, C.E.
Robbery Wood Viaduct—Great N. Railway.	20	Mr. J. Cubitt, C.E.
Iron Permanent Way.....	20a	—
Clydach Viaduct—Merthyr, Tredegar, and Abergavenny Railway .....	21	Mr. Gardner, C.E.
Ebbw Viaduct ditto ditto ditto	22	Mr. Gardner, C.E.
College Wood Viaduct—Cornwall Railway ..	23	Mr. Brunel.
Dublin Winter Palace Roof.....	24 to 26	Messrs. Ordish & Le Feuvre.
Bridge over the Thames—L. C. & D. Railw.	27 to 32	Mr. J. Cubitt, C.E.
Albert Harbour, Greenock .....	33 to 36	Messrs. Bell & Miller.

With copious Descriptive Letterpress, Specifications, &c.

“ A *resumé* of all the more interesting and important works lately completed in Great Britain; and containing, as it does, carefully executed drawings, with full working details will be found a valuable accessory to the profession at large.”—*Engineer.*

“Mr. Humber has done the profession good and true service, by the fine collection of examples he has here brought before the profession and the public.”—*Practical Mechanic's Journal.*

*Humber's Modern Engineering. Third Series.*

A RECORD of the PROGRESS of MODERN ENGINEERING, 1865. Imp. 4to, with 40 Double Plates, drawn to a large scale, and Photographic Portrait of J. R. M'Clean, Esq., late President of the Institution of Civil Engineers. Price 3*l.* 3*s.* half morocco.

*List of Plates and Diagrams.*

## MAIN DRAINAGE, METROPOLIS.

## NORTH SIDE.

Map showing Interception of Sewers.  
 Middle Level Sewer. Sewer under Regent's Canal.  
 Middle Level Sewer. Junction with Fleet Ditch.  
 Outfall Sewer. Bridge over River Lea. Elevation.  
 Outfall Sewer. Bridge over River Lea. Details.  
 Outfall Sewer. Bridge over River Lea. Details.  
 Outfall Sewer. Bridge over Marsh Lane, North Woolwich Railway, and Bow and Barking Railway Junction.  
 Outfall Sewer. Bridge over Bow and Barking Railway. Elevation.  
 Outfall Sewer. Bridge over Bow and Barking Railway. Details.  
 Outfall Sewer. Bridge over Bow and Barking Railway. Details.  
 Outfall Sewer. Bridge over East London Waterworks' Feeder. Elevation.  
 Outfall Sewer. Bridge over East London Waterworks' Feeder. Details.  
 Outfall Sewer. Reservoir. Plan.  
 Outfall Sewer. Reservoir. Section.  
 Outfall Sewer. Tumbling Bay and Outlet.  
 Outfall Sewer. Penstocks.

## SOUTH SIDE.

Outfall Sewer. Bermondsey Branch.  
 Outfall Sewer. Bermondsey Branch.  
 Outfall Sewer. Reservoir and Outlet. Plan.

## MAIN DRAINAGE, METROPOLIS,

*continued—*

Outfall Sewer. Reservoir and Outlet. Details.  
 Outfall Sewer. Reservoir and Outlet. Details.  
 Outfall Sewer. Reservoir and Outlet. Details.  
 Outfall Sewer. Filth Hoist.  
 Sections of Sewers (North and South Sides).

## THAMES EMBANKMENT.

Section of River Wall.  
 Steam-boat Pier, Westminster. Elevation.  
 Steam-boat Pier, Westminster. Details.  
 Landing Stairs between Charing Cross and Waterloo Bridges.  
 York Gate. Front Elevation.  
 York Gate. Side Elevation and Details.  
 Overflow and Outlet at Savoy Street Sewer. Details.  
 Overflow and Outlet at Savoy Street Sewer. Penstock.  
 Overflow and Outlet at Savoy Street Sewer. Penstock.  
 Steam-boat Pier, Waterloo Bridge. Elevation.  
 Steam-boat Pier, Waterloo Bridge. Details.  
 Steam-boat Pier, Waterloo Bridge. Details.  
 Junction of Sewers. Plans and Sections.  
 Gullies. Plans and Sections.  
 Rolling Stock.  
 Granite and Iron Forts.

With copious Descriptive Letterpress, Specifications, &c.

*Opinions of the Press.*

"Mr. Humber's works—especially his annual 'Record,' with which so many of our readers are now familiar—fill a void occupied by no other branch of literature. . . . The drawings have a constantly increasing value, and whoever desires to possess clear representations of the two great works carried out by our Metropolitan Board will obtain Mr. Humber's last volume."—*Engineering*.

"No engineer, architect, or contractor should fail to preserve these records of works which, for magnitude, have not their parallel in the present day, no student in the profession but should carefully study the details of these great works, which he may be one day called upon to imitate."—*Mechanic's Magazine*.

"A work highly creditable to the industry of its author. . . . The volume is quite an encyclopædia for the study of the student who desires to master the subject of municipal drainage on its scale of greatest development."—*Practical Mechanic's Journal*

*Humber's Modern Engineering. Fourth Series.*

A RECORD of the PROGRESS of MODERN ENGINEERING, 1866. Imp. 4to, with 36 Double Plates, drawn to a large scale, and Photographic Portrait of John Fowler, Esq., President of the Institution of Civil Engineers. Price 3*l.* 3*s.* half-morocco.

*List of the Plates and Diagrams.*

NAME AND DESCRIPTION.	PLATES.	NAME OF ENGINEER.
Abbey Mills Pumping Station, Main Drainage, Metropolis.....	1 to 4	Mr. Bazalgette, C.E.
Barrow Docks .....	5 to 9	Messrs. M <sup>r</sup> Clean & Stillman, [C. E.]
Manquis Viaduct, Santiago and Valparaiso Railway .....	10, 11	Mr. W. Loyd, C.E.
Adams' Locomotive, St. Helen's Canal Railw. Cannon Street Station Roof, Charing Cross Railway .....	12, 13	Mr. H. Cross, C.E.
Road Bridge over the River Moka.....	14 to 16	Mr. J. Hawkshaw, C.E.
Telegraphic Apparatus for Mesopotamia ....	17, 18	Mr. H. Wakefield, C.E.
Viaduct over the River Wye, Midland Railw. St. Germans Viaduct, Cornwall Railway ....	19	Mr. Siemens, C.E.
Wrought-Iron Cylinder for Diving Bell.....	20 to 22	Mr. W. H. Barlow, C.E.
Millwall Docks.....	23, 24	Mr. Brunel, C.E.
	25	Mr. J. Coode, C.E.
	26 to 31	Messrs. J. Fowler, C.E., and William Wilson, C.E.
Milroy's Patent Excavator .....	32	Mr. Milroy, C.E.
Metropolitan District Railway.....	33 to 38	Mr. J. Fowler, Engineer-in-Chief, and Mr. T. M. Johnson, C.E.
Harbours, Ports, and Breakwaters.....	A to C	—

*The Letterpress comprises—*

A concluding article on Harbours, Ports, and Breakwaters, with Illustrations and detailed descriptions of the Breakwater at Cherbourg, and other important modern works; an article on the Telegraph Lines of Mesopotamia; a full description of the Wrought-iron Diving Cylinder for Ceylon, the circumstances under which it was used, and the means of working it; full description of the Millwall Docks; &c., &c., &c.

*Opinions of the Press.*

“Mr. Humber's ‘Record of Modern Engineering’ is a work of peculiar value, as well to those who design as to those who study the art of engineering construction. It embodies a vast amount of practical information in the form of full descriptions and working drawings of all the most recent and noteworthy engineering works. The plates are excellently lithographed, and the present volume of the ‘Record’ is not a whit behind its predecessors.”—*Mechanics' Magazine*.

“We gladly welcome another year's issue of this valuable publication from the able pen of Mr. Humber. The accuracy and general excellence of this work are well known, while its usefulness in giving the measurements and details of some of the latest examples of engineering, as carried out by the most eminent men in the profession, cannot be too highly prized.”—*Artizan*.

“The volume forms a valuable companion to those which have preceded it, and cannot fail to prove a most important addition to every engineering library.”—*Mining Journal*.

“No one of Mr. Humber's volumes was bad; all were worth their cost, from the mass of plates from well-executed drawings which they contained. In this respect, perhaps, this last volume is the most valuable that the author has produced.”—*Practical Mechanics' Journal*.



## *Humber's Great Work on Bridge Construction.*

A COMPLETE and PRACTICAL TREATISE on CAST and WROUGHT-IRON BRIDGE CONSTRUCTION, including Iron Foundations. In Three Parts—Theoretical, Practical, and Descriptive. By WILLIAM HUMBER, Assoc. Inst. C. E., and M. Inst. M. E. Third Edition, revised and much improved, with 115 Double Plates (20 of which now first appear in this edition), and numerous additions to the Text. In 2 vols. imp. 4to., price 6*l.* 16*s.* 6*d.* half-bound in morocco.

“A very valuable contribution to the standard literature of civil engineering. In addition to elevations, plans, and sections, large scale details are given, which very much enhance the instructive worth of these illustrations. No engineer would willingly be without so valuable a fund of information.”—*Civil Engineer and Architect's Journal*.

“The First or Theoretical Part contains mathematical investigations of the principles involved in the various forms now adopted in bridge construction. These investigations are exceedingly complete, having evidently been very carefully considered and worked out to the utmost extent that can be desired by the practical man. The tables are of a very useful character, containing the results of the most recent experiments, and amongst them are some valuable tables of the weight and cost of cast and wrought-iron structures actually erected. The volume of text is amply illustrated by numerous woodcuts, plates, and diagrams; and the plates in the second volume do great credit to both draughtsmen and engravers. In conclusion, we have great pleasure in cordially recommending this work to our readers.”—*Artizan*.

“Mr. Humber's stately volumes lately issued—in which the most important bridges erected during the last five years, under the direction of the late Mr. Brunel, Sir W. Cubitt, Mr. Hawkshaw, Mr. Page, Mr. Fowler, Mr. Hemans, and others among our most eminent engineers, are drawn and specified in great detail.”—*Engineer*.

## *Weale's Engineer's Pocket-Book.*

THE ENGINEER'S, ARCHITECT'S, and CONTRACTOR'S POCKET-BOOK (LOCKWOOD & CO.'S; formerly WEALE'S). Published Annually. In roan tuck, gilt edges, with 10 Copper-Plates and numerous Woodcuts. Price 6*s.*

“A vast amount of really valuable matter condensed into the small dimensions of a book which is, in reality, what it professes to be—a pocket-book. . . . We cordially recommend the book to the notice of the managers of coal and other mines; to them it will prove a handy book of reference on a variety of subjects more or less intimately connected with their profession.”—*Colliery Guardian*.

“Every branch of engineering is treated of, and facts, figures, and data of every kind abound.”—*Mechanics' Mag.*

“It contains a large amount of information peculiarly valuable to those for whose use it is compiled. We cordially commend it to the engineering and architectural professions generally.”—*Mining Journal*.

## *Iron Bridges, Girders, Roofs, &c.*

A TREATISE on the APPLICATION of IRON to the CONSTRUCTION of BRIDGES, GIRDERS, ROOFS, and OTHER WORKS; showing the Principles upon which such Structures are Designed, and their Practical Application. Especially arranged for the use of Students and Practical Mechanics, all Mathematical Formulæ and Symbols being excluded. By FRANCIS CAMPIN, C. E. With numerous Diagrams. 12mo., cloth boards, 3*s.*

“For numbers of young engineers the book is just the cheap, handy, first guide they want.”—*Middlesborough Weekly News*.

“Invaluable to those who have not been educated in mathematics.”—*Colliery Guardian*.

“Remarkably accurate and well written.”—*Artizan*.

### *Barlow on the Strength of Materials, enlarged.*

A TREATISE ON THE STRENGTH OF MATERIALS, with Rules for application in Architecture, the Construction of Suspension Bridges, Railways, &c.; and an Appendix on the Power of Locomotive Engines, and the effect of Inclined Planes and Gradients. By PETER BARLOW, F.R.S. A New Edition, revised by his Sons, P. W. BARLOW, F.R.S., and W. H. BARLOW, F.R.S., to which are added Experiments by HODGKINSON, FAIRBAIRN, and KIRKALDY; an Essay (with Illustrations) on the effect produced by passing Weights over Elastic Bars, by the Rev. ROBERT WILLIS, M.A., F.R.S. And Formulæ for Calculating Girders, &c. The whole arranged and edited by W. HUMBER, Assoc. Inst. C.E., Author of "A Complete and Practical Treatise on Cast and Wrought-Iron Bridge Construction," &c. &c. Demy 8vo, 400 pp., with 19 large Plates, and numerous woodcuts, price 18s. cloth.

"Although issued as the sixth edition, the volume under consideration is worthy of being regarded, for all practical purposes, as an entirely new work . . . the book is undoubtedly worthy of the highest commendation."—*Mining Journal*.

"An increased value has been given to this very valuable work by the addition of a large amount of information, which cannot prove otherwise than highly useful to those who require to consult it. . . . The arrangement and editing of this mass of information has been undertaken by Mr. Humber, who has most ably fulfilled a task requiring special care and ability to render it a success."—*Mechanics' Magazine*.

"The best book on the subject which has yet appeared. . . . We know of no work that so completely fulfils its mission."—*English Mechanic*.

"There is not a pupil in an engineering school, an apprentice in an engineer's or architect's office, or a competent clerk of works, who will not recognise in the scientific volume newly given to circulation, an old and valued friend."—*Building News*.

"The standard treatise upon this particular subject."—*Engineer*.

### *Strains, Formulæ & Diagrams for Calculation of.*

A HANDY BOOK for the CALCULATION of STRAINS in GIRDERS and SIMILAR STRUCTURES, and their STRENGTH; consisting of Formulæ and Corresponding Diagrams, with numerous Details for Practical Application, &c. By WILLIAM HUMBER, Assoc. Inst. C.E., &c. Fcap. 8vo, with nearly 100 Woodcuts and 3 Plates, price 7s. 6d. cloth.

"The arrangement of the matter in this little volume is as convenient as it well could be. . . . The system of employing diagrams as a substitute for complex computations is one justly coming into great favour, and in that respect Mr. Humber's volume is fully up to the times."—*Engineering*.

"The formulæ are neatly expressed, and the diagrams good."—*Athenæum*.

"We heartily commend this really *handy* book to our engineer and architect readers."—*English Mechanic*.

### *Mechanical Engineering.*

A PRACTICAL TREATISE ON MECHANICAL ENGINEERING: comprising Metallurgy, Moulding, Casting, Forging, Tools, Workshop Machinery, Mechanical Manipulation, Manufacture of the Steam Engine, &c. &c. With an Appendix on the Analysis of Iron and Iron Ore, and Glossary of Terms. By FRANCIS CAMPIN, C.E. Illustrated with 91 Woodcuts and 28 Plates of Slotting, Shaping, Drilling, Punching, Shearing, and Riveting Machines—Blast, Refining, and Reverberatory Furnaces—Steam Engines, Governors, Boilers, Locomotives, &c. 8vo, cloth, 12s.

*Strains.*

THE STRAINS ON STRUCTURES OF IRONWORK; with Practical Remarks on Iron Construction. By F. W. SHEILDS, M. Inst. C.E. Second Edition, with 5 plates. Royal 8vo, 5s. cloth.

CONTENTS.—Introductory Remarks; Beams Loaded at Centre; Beams Loaded at unequal distances between supports; Beams uniformly Loaded; Girders with triangular bracing Loaded at centre; Ditto, Loaded at unequal distances between supports; Ditto, uniformly Loaded; Calculation of the Strains on Girders with triangular Basings; Cantilevers; Continuous Girders; Lattice Girders; Girders with Vertical Struts and Diagonal Ties; Calculation of the Strains on Ditto; Bow and String Girders; Girders of a form not belonging to any regular figure; Plate Girders; Apportionments of Material to Strain; Comparison of different Girders; Proportion of Length to Depth of Girders; Character of the Work; Iron Roofs.

*Construction of Iron Beams, Pillars, &c.*

IRON AND HEAT, Exhibiting the Principles concerned in the Construction of Iron Beams, Pillars, and Bridge Girders, and the Action of Heat in the Smelting Furnace. By JAMES ARMOUR, C.E. Woodcuts, 12mo, cloth boards, 3s. 6d.; cloth limp, 2s. 6d.

“A very useful and thoroughly practical little volume, in every way deserving of circulation amongst working men.”—*Mining Journal*.

“No ironworker who wishes to acquaint himself with the principles of his own trade can afford to be without it.”—*South Durham Mercury*.

*Power in Motion.*

POWER IN MOTION: Horse Power, Motion, Toothed Wheel Gearing, Long and Short Driving Bands, Angular Forces, &c. By JAMES ARMOUR, C.E. With 73 Diagrams. 12mo, cloth boards, 3s. 6d. [Recently published.]

“Numerous illustrations enable the author to convey his meaning as explicitly as it is perhaps possible to be conveyed. The value of the theoretic and practical knowledge imparted cannot well be over estimated.”—*Newcastle Weekly Chronicle*.

*Metallurgy of Iron.*

A TREATISE ON THE METALLURGY OF IRON: containing Outlines of the History of Iron Manufacture, Methods of Assay, and Analyses of Iron Ores, Processes of Manufacture of Iron and Steel, &c. By H. BAUERMAN, F.G.S., Associate of the Royal School of Mines. With numerous Illustrations. Fourth Edition, revised and much enlarged. 12mo., cloth boards, 5s. 6d.

[Just published.]

“Carefully written, it has the merit of brevity and conciseness, as to less important points, while all material matters are very fully and thoroughly entered into.”—*Standard*.

*Trigonometrical Surveying.*

AN OUTLINE OF THE METHOD OF CONDUCTING A TRIGONOMETRICAL SURVEY, for the Formation of Geographical and Topographical Maps and Plans, Military Reconnaissance, Levelling, &c., with the most useful Problems in Geodesy and Practical Astronomy, and Formulæ and Tables for Facilitating their Calculation. By LIEUT.-GENERAL FROME, R.E., late Inspector-General of Fortifications, &c. Fourth Edition, Enlarged, thoroughly Revised, and partly Re-written. By CAPTAIN CHARLES WARREN, R.E., F.G.S. With 19 Plates and 115 Woodcuts, royal 8vo, price 16s. cloth.

## *Hydraulics.*

HYDRAULIC TABLES, CO-EFFICIENTS, and FORMULÆ for finding the Discharge of Water from Orifices, Notches, Weirs, Pipes, and Rivers. By JOHN NEVILLE, Civil Engineer, M.R.I.A. Second Edition, with extensive Additions, New Formulæ, Tables, and General Information on Rain-fall, Catchment-Basins, Drainage, Sewerage, Water Supply for Towns and Mill Power. With numerous Woodcuts, 8vo, 16s. cloth.

\* \* This work contains a vast number of different hydraulic formulæ, and the most extensive and accurate tables yet published for finding the mean velocity of discharge from triangular, quadrilateral, and circular orifices, pipes, and rivers; with experimental results and co-efficients; effects of friction; of the velocity of approach; and of curves, bends, contractions, and expansions; the best form of channel; the drainage effects of long and short weirs, and weir-basins; extent of back-water from weirs; contracted channels; catchment-basins; hydrostatic and hydraulic pressure; water-power, &c. &c.

## *Levelling.*

A TREATISE on the PRINCIPLES and PRACTICE of LEVELLING; showing its Application to Purposes of Railway and Civil Engineering, in the Construction of Roads; with Mr. TELFORD'S Rules for the same. By FREDERICK W. SIMMS, F.G.S., M. Inst. C.E. Fifth Edition, very carefully revised, with the addition of Mr. LAW'S Practical Examples for Setting out Railway Curves, and Mr. TRAUTWINE'S Field Practice of Laying out Circular Curves. With 7 Plates and numerous Woodcuts. 8vo, 8s. 6d. cloth. \* \* TRAUTWINE on Curves, separate, price 5s.

"One of the most important text-books for the general surveyor, and there is scarcely a question connected with levelling for which a solution would be sought but that would be satisfactorily answered by consulting the volume."—*Mining Journal*.

"The text-book on levelling in most of our engineering schools and colleges."—*Engineer*.

"The publishers have rendered a substantial service to the profession, especially to the younger members, by bringing out the present edition of Mr. Simms's useful work."—*Engineering*.

## *Tunnelling.*

PRACTICAL TUNNELLING; explaining in Detail the Setting out of the Works; Shaft Sinking and Heading Driving; Ranging the Lines and Levelling Under-Ground; Sub-Excavating, Timbering, and the Construction of the Brickwork of Tunnels; with the Amount of Labour required for, and the Cost of the various Portions of the Work. By FREDK. W. SIMMS, F.R.A.S., F.G.S., M. Inst. C.E., Author of "A Treatise on the Principles and Practice of Levelling," &c. &c. Second Edition, revised by W. DAVIS HASKOLL, Civil Engineer, Author of "The Engineer's Field-Book," &c. &c. With 16 large folding Plates and numerous Woodcuts. Imperial 8vo, 17. 1s. cloth.

*Strength of Cast Iron, &c.*

A PRACTICAL ESSAY on the STRENGTH of CAST IRON and OTHER METALS. By the late THOMAS TREDGOLD, Mem. Inst. C.E., Author of "Elementary Principles of Carpentry," &c. Fifth Edition, Edited by EATON HODGKINSON, F.R.S.; to which are added EXPERIMENTAL RESEARCHES on the STRENGTH and OTHER PROPERTIES of CAST IRON. By the EDITOR. The whole Illustrated with 9 Engravings and numerous Woodcuts. 8vo, 12s. cloth.

\*\* HODGKINSON'S EXPERIMENTAL RESEARCHES ON THE STRENGTH AND OTHER PROPERTIES OF CAST IRON may be had separately. With Engravings and Woodcuts. 8vo, price 6s. cloth.

*The High-Pressure Steam Engine.*

THE HIGH-PRESSURE STEAM ENGINE; an Exposition of its Comparative Merits, and an Essay towards an Improved System of Construction, adapted especially to secure Safety and Economy. By Dr. ERNST ALBAN, Practical Machine Maker, Plau, Mecklenberg. Translated from the German, with Notes, by Dr. POLE, F.R.S., M. Inst. C.E., &c. &c. With 28 fine Plates, 8vo, 16s. 6d. cloth.

"A work like this, which goes thoroughly into the examination of the high-pressure engine, the boiler, and its appendages, &c., is exceedingly useful, and deserves a place in every scientific library."—*Steam Shipping Chronicle*.

*Steam Boilers.*

A TREATISE ON STEAM BOILERS: their Strength, Construction, and Economical Working. By ROBERT WILSON, late Inspector for the Manchester Steam Users' Association for the Prevention of Steam Boiler Explosions, and for the Attainment of Economy in the Application of Steam. 12mo, cloth boards, 328 pages, price 6s.

*Tables of Curves.*

TABLES OF TANGENTIAL ANGLES and MULTIPLES for setting out Curves from 5 to 200 Radius. By ALEXANDER BEAZELEY, M. Inst. C.E. Printed on 48 Cards, and sold in a cloth box, waistcoat-pocket size, price 3s. 6d.

"Each table is printed on a small card, which, being placed on the theodolite, leaves the hands free to manipulate the instrument—no small advantage as regards the rapidity of work. They are clearly printed, and compactly fitted into a small case for the pocket—an arrangement that will recommend them to all practical men."—*Engineer*.

"Very handy: a man may know that all his day's work must fall on two of these cards, which he puts into his own card-case, and leaves the rest behind."—*Athenæum*.

*Laying Out Curves.*

THE FIELD PRACTICE of LAYING OUT CIRCULAR CURVES for RAILROADS. By JOHN C. TRAUTWINE, C.E. (Extracted from SIMMS'S Work on Levelling). 8vo, 5s. sewed.

### *Estimate and Price Book.*

THE CIVIL ENGINEER'S AND CONTRACTOR'S ESTIMATE AND PRICE BOOK for Home or Foreign Service : in reference to Roads, Railways, Tramways, Docks, Harbours, Forts, Fortifications, Bridges, Aqueducts, Tunnels, Sewers, Waterworks, Gasworks, Stations, Barracks, Warehouses, &c. &c. &c. With Specifications for Permanent Way, Telegraph Materials, Plant, Maintenance, and Working of a Railway ; and a Priced List of Machinery, Plant, Tools, &c. By W. D. HASKOLL, C.E. Plates and Woodcuts. Published annually. 8vo, cloth, 6s.

"As furnishing a variety of data on every conceivable want to civil engineers and contractors, this book has ever stood perhaps unrivalled."—*Architect.*

### *Surveying (Land and Marine).*

LAND AND MARINE SURVEYING, in Reference to the Preparation of Plans for Roads and Railways, Canals, Rivers, Towns' Water Supplies, Docks and Harbours ; with Description and Use of Surveying Instruments. By W. DAVIS HASKOLL, C.E., Author of "The Engineer's Field Book," "Examples of Bridge and Viaduct Construction," &c. Demy 8vo, price 12s. 6d. cloth, with 14 folding Plates, and numerous Woodcuts.

"A most useful and well arranged book for the aid of a student. . . . We can strongly recommend it as a carefully-written and valuable text-book."—*Builder.*

"Mr. Haskoll has knowledge and experience, and can so give expression to it as to make any matter on which he writes, clear to the youngest pupil in a surveyor's office."—*Colliery Guardian.*

"A volume which cannot fail to prove of the utmost practical utility. . . . It is one which may be safely recommended to all students who aspire to become clean and expert surveyors."—*Mining Journal.*

### *Engineering Fieldwork.*

THE PRACTICE OF ENGINEERING FIELDWORK, applied to Land and Hydraulic, Hydrographic, and Submarine Surveying and Levelling. Second Edition, revised, with considerable additions, and a Supplementary Volume on WATERWORKS, SEWERS, SEWAGE, and IRRIGATION. By W. DAVIS HASKOLL, C.E. Numerous folding Plates. Demy 8vo, 2 vols. in one, cloth boards, 1l. 1s. (published at 2l. 4s.)

### *Mining Surveying and Valuing.*

THE MINERAL SURVEYOR AND VALUER'S COMPLETE GUIDE, comprising a Treatise on Improved Mining Surveying, with new Traverse Tables ; and Descriptions of Improved Instruments ; also an Exposition of the Correct Principles of Laying out and Valuing Home and Foreign Iron and Coal Mineral Properties: to which is appended M. THOMAN'S (of the Crédit Mobilier, Paris) TREATISE on COMPOUND INTEREST and ANNUITIES, with LOGARITHMIC TABLES. By WILLIAM LINTERN, Mining and Civil Engineer. 12mo, strongly bound in cloth boards, with four Plates of Diagrams, Plans, &c, price 10s. 6d.

"Contains much valuable information given in a small compass, and which, as far as we have tested it, is thoroughly trustworthy."—*Iron and Coal Trades Review.*

"The matter, arrangement, and illustration of this work are all excellent, and make it one of the best of its kind."—*Standard.*

## *Fire Engineering.*

FIRES, FIRE-ENGINES, AND FIRE BRIGADES. With a History of Fire-Engines, their Construction, Use, and Management; Remarks on Fire-Proof Buildings, and the Preservation of Life from Fire; Statistics of the Fire Appliances in English Towns; Foreign Fire Systems; Hints on Fire Brigades, &c., &c. By CHARLES F. T. YOUNG, C.E. With numerous Illustrations, handsomely printed, 544 pp., demy 8vo, price 17. 4s. cloth.

"We can most heartily commend this book. . . . It is really the only English work we now have upon the subject."—*Engineering*.

"We strongly recommend the book to the notice of all who are in any way interested in fires, fire-engines, or fire-brigades."—*Mechanics' Magazine*.

## *Manual of Mining Tools.*

MINING TOOLS. For the use of Mine Managers, Agents, Mining Students, &c. By WILLIAM MORGANS, Lecturer on Practical Mining at the Bristol School of Mines. Volume of Text. 12mo. With an Atlas of Plates, containing 235 Illustrations. 4to. Together, price 9s. cloth boards. [Recently published.]

"Students in the Science of Mining, and not only they, but subordinate officials in mines, and even Overmen, Captains, Managers, and Viewers may gain practical knowledge and useful hints by the study of Mr. Morgans's Manual."—*Colliery Guardian*.

"A very valuable work, which will tend materially to improve our mining literature."—*Mining Journal*.

## *Gas and Gasworks.*

A TREATISE on GASWORKS and the PRACTICE of MANUFACTURING and DISTRIBUTING COAL GAS. By SAMUEL HUGHES, C.E. Third Edition, revised by W. RICHARDS, C.E. With 68 Woodcuts, bound in cloth boards, 12mo, price 4s.

## *Waterworks for Cities and Towns.*

WATERWORKS for the SUPPLY of CITIES and TOWNS, with a Description of the Principal Geological Formations of England as influencing Supplies of Water. By SAMUEL HUGHES, F.G.S., Civil Engineer. New and enlarged edition, 12mo, cloth boards, with numerous Illustrations, price 5s.

"One of the most convenient, and at the same time reliable works on a subject, the vital importance of which cannot be over-estimated."—*Bradford Observer*.

## *Coal and Coal Mining.*

COAL AND COAL MINING: a Rudimentary Treatise on. By WARINGTON W. SMYTH, M.A., F.R.S., &c., Chief Inspector of the Mines of the Crown and of the Duchy of Cornwall. New edition, revised and corrected. 12mo., cloth boards, with numerous Illustrations, price 4s. 6d.

"Every portion of the volume appears to have been prepared with much care, and as an outline is given of every known coal-field in this and other countries, as well as of the two principal methods of working, the book will doubtless interest a very large number of readers."—*Mining Journal*.

"Certainly experimental skill and rule-of-thumb practice would be greatly enriched by the addition of the theoretical knowledge and scientific information which Mr. Warrington Smyth communicates in combination with the results of his own experience and personal research."—*Colliery Guardian*.

### *Field-Book for Engineers.*

THE ENGINEER'S, MINING SURVEYOR'S, and CONTRACTOR'S FIELD-BOOK. By W. DAVIS HASKOLL, Civil Engineer. Third Edition, much enlarged, consisting of a Series of Tables, with Rules, Explanations of Systems, and Use of Theodolite for Traverse Surveying and Plotting the Work with minute accuracy by means of Straight Edge and Set Square only; Levelling with the Theodolite, Casting out and Reducing Levels to Datum, and Plotting Sections in the ordinary manner; Setting out Curves with the Theodolite by Tangential Angles and Multiples with Right and Left-hand Readings of the Instrument; Setting out Curves without Theodolite on the System of Tangential Angles by Sets of Tangents and Offsets; and Earthwork Tables to 80 feet deep, calculated for every 6 inches in depth. With numerous wood-cuts, 12mo, price 12s. cloth.

"A very useful work for the practical engineer and surveyor. Every person engaged in engineering field operations will estimate the importance of such a work and the amount of valuable time which will be saved by reference to a set of reliable tables prepared with the accuracy and fulness of those given in this volume."—*Railway News*.

"The book is very handy, and the author might have added that the separate tables of sines and tangents to every minute will make it useful for many other purposes, the genuine traverse tables existing all the same."—*Athenæum*.

"The work forms a handsome pocket volume, and cannot fail, from its portability and utility, to be extensively patronised by the engineering profession."—*Mining Journal*.

"We strongly recommend this second edition of Mr. Haskoll's 'Field Book' to all classes of surveyors."—*Colliery Guardian*.

### *Earthwork, Measurement and Calculation of.*

A MANUAL on EARTHWORK. By ALEX. J. S. GRAHAM, C.E., Resident Engineer, Forest of Dean Central Railway. With numerous Diagrams. 18mo, 2s. 6d. cloth.

"As a really handy book for reference, we know of no work equal to it; and the railway engineers and others employed in the measurement and calculation of earthwork will find a great amount of practical information very admirably arranged, and available for general or rough estimates, as well as for the more exact calculations required in the engineers' contractor's offices."—*Artizan*.

### *Harbours.*

THE DESIGN and CONSTRUCTION of HARBOURS: A Treatise on Maritime Engineering. By THOMAS STEVENSON, F.R.S.E., F.G.S., M.I.C.E. Second Edition, containing many additional subjects, and otherwise generally extended and revised. With 20 Plates and numerous Cuts. Small 4to, 15s. cloth.

### *Mathematical and Drawing Instruments.*

A TREATISE ON THE PRINCIPAL MATHEMATICAL AND DRAWING INSTRUMENTS employed by the Engineer, Architect, and Surveyor. By FREDERICK W. SIMMS, M. Inst. C.E., Author of "Practical Tunnelling," &c. Third Edition, with numerous Cuts. 12mo, price 3s. 6d. cloth.



*Bridge Construction in Masonry, Timber, & Iron.*

EXAMPLES OF BRIDGE AND VIADUCT CONSTRUCTION OF MASONRY, TIMBER, AND IRON; consisting of 46 Plates from the Contract Drawings or Admeasurement of select Works. By W. DAVIS HASKOLL, C.E. Second Edition, with the addition of 554 Estimates, and the Practice of Setting out Works, illustrated with 6 pages of Diagrams. Imp. 4to, price 2*l.* 12*s.* 6*d.* half-morocco.

"One of the very few works extant descending to the level of ordinary routine, and treating on the common every-day practice of the railway engineer. . . . A work of the present nature by a man of Mr. Haskoll's experience, must prove invaluable to hundreds. The tables of estimates appended to this edition will considerably enhance its value."—*Engineering*.

*Mathematical Instruments, their Construction, &c.*

MATHEMATICAL INSTRUMENTS: THEIR CONSTRUCTION, ADJUSTMENT, TESTING, AND USE; comprising Drawing, Measuring, Optical, Surveying, and Astronomical Instruments. By J. F. HEATHER, M.A., Author of "Practical Plane Geometry," "Descriptive Geometry," &c. Enlarged Edition, for the most part entirely rewritten. With numerous Wood-cuts. 12mo, cloth boards, price 5*s.*

*Oblique Arches.*

A PRACTICAL TREATISE ON THE CONSTRUCTION OF OBLIQUE ARCHES. By JOHN HART. Third Edition, with Plates. Imperial 8vo, price 8*s.* cloth.

*Oblique Bridges.*

A PRACTICAL AND THEORETICAL ESSAY ON OBLIQUE BRIDGES, with 13 large folding Plates. By GEO. WATSON BUCK, M. Inst. C.E. Second Edition, corrected by W. H. BARLOW, M. Inst. C.E. Imperial 8vo, 12*s.* cloth.

"The standard text-book for all engineers regarding skew arches, is Mr. Buck's treatise, and it would be impossible to consult a better."—*Engineer*.

*Weale's Series of Rudimentary Works.*

These highly popular and cheap Series of Books, now comprising nearly Three Hundred distinct Works in almost every department of Science, Art, and Education, are recommended to the notice of Engineers, Architects, Builders, Artizans, and Students generally, as well as to those interested in Workmen's Libraries, Free Libraries, Literary and Scientific Institutions, Colleges, Schools, Science Classes, &c., &c.

\*.\* Lists may be had on application to LOCKWOOD & CO.

*Weale's Dictionary of Terms in Architecture, Engineering, Art, &c.*

A DICTIONARY OF TERMS used in ARCHITECTURE, BUILDING, ENGINEERING, MINING, METALLURGY, ARCHÆOLOGY, the FINE ARTS, &c. By JOHN WEALE. Fourth Edition, enlarged and revised by ROBERT HUNT, F.R.S., Keeper of Mining Records, Editor of "Ure's Dictionary of Arts," &c. 12mo, cloth boards, price 6*s.*

# ARCHITECTURE, &c.

## *Construction.*

THE SCIENCE of BUILDING: an Elementary Treatise on the Principles of Construction. By E. WYNDHAM TARN, M.A., Architect. Illustrated with 47 Wood Engravings. Demy 8vo, price 8s. 6d. cloth. [Recently published.]

"A very valuable book, which we strongly recommend to all students."—*Builder.*

"While Mr. Tarn's valuable little volume is quite sufficiently scientific to answer the purposes intended, it is written in a style that will deservedly make it popular. The diagrams are numerous and exceedingly well executed, and the treatise does credit alike to the author and the publisher."—*Engineer.*

"No architectural student should be without this hand-book of constructional knowledge."—*Architect.*

"The book is very far from being a mere compilation; it is an able digest of information which is only to be found scattered through various works, and contains more really original writing than many putting forth far stronger claims to originality."—*Engineering.*

## *Beaton's Pocket Estimator.*

THE POCKET ESTIMATOR FOR THE BUILDING TRADES, being an easy method of estimating the various parts of a Building collectively, more especially applied to Carpenters' and Joiners' work, priced according to the present value of material and labour. By A. C. BEATON, Author of 'Quantities and Measurements.' 33 Woodcuts. Leather, waistcoat-pocket size. 2s.

## *Beaton's Builders' and Surveyors' Technical Guide.*

THE POCKET TECHNICAL GUIDE AND MEASURER FOR BUILDERS AND SURVEYORS: containing a Complete Explanation of the Terms used in Building Construction, Memoranda for Reference, Technical Directions for Measuring Work in all the Building Trades, with a Treatise on the Measurement of Timbers, and Complete Specifications for Houses, Roads, and Drains. By A. C. BEATON, Author of 'Quantities and Measurements.' With 19 Woodcuts. Leather. Waistcoat pocket size. 2s.

[Now ready.]

## *Villa Architecture.*

A HANDY BOOK of VILLA ARCHITECTURE; being a Series of Designs for Villa Residences in various Styles. With Detailed Specifications and Estimates. By C. WICKES, Architect, Author of "The Spires and Towers of the Mediæval Churches of England," &c. First Series, consisting of 30 Plates; Second Series, 31 Plates. Complete in 1 vol., 4to, price 2l. 10s. half morocco. Either Series separate, price 1l. 7s. each, half morocco.

"The whole of the designs bear evidence of their being the work of an artistic architect, and they will prove very valuable and suggestive to architects, students, and amateurs."—*Building News.*

## *The Architect's Guide.*

THE ARCHITECT'S GUIDE; or, Office and Pocket Companion for Engineers, Architects, Land and Building Surveyors, Contractors, Builders, Clerks of Works, &c. By W. DAVIS HASKOLL, C.E., R. W. BILLINGS, Architect, F. ROGERS, and P. THOMPSON. With numerous Experiments by G. RENNIE, C.E., &c. Woodcuts, 12mo, cloth, price 3s. 6d.

*Vitruvius' Architecture.*

THE ARCHITECTURE OF MARCUS VITRUVIUS POLLIO. Translated by JOSEPH GWILT, F.S.A., F.R.A.S. Numerous Plates. 12mo, cloth limp, price 5s.

*The Young Architect's Book.*

HINTS TO YOUNG ARCHITECTS. By GEORGE WIGHTWICK, Architect, Author of "The Palace of Architecture," &c. &c. Second Edition. With numerous Woodcuts. 8vo, 7s., extra cloth.

*Drawing for Builders and Students.*

PRACTICAL RULES ON DRAWING for the OPERATIVE BUILDER and YOUNG STUDENT in ARCHITECTURE. By GEORGE PYNE, Author of a "Rudimentary Treatise on Perspective for Beginners." With 14 Plates, 4to, 7s. 6d., boards.

CONTENTS.—I. Practical Rules on Drawing—Outlines. II. Ditto—the Grecian and Roman Orders. III. Practical Rules on Drawing—Perspective. IV. Practical Rules on Light and Shade. V. Practical Rules on Colour, &c. &c.

*Drawing for Engineers, &c.*

THE WORKMAN'S MANUAL OF ENGINEERING DRAWING. By JOHN MAXTON, Instructor in Engineering Drawing, South Kensington. Second Edition, carefully revised. With upwards of 300 Plates and Diagrams. 12mo, cloth, strongly bound, 4s. 6d.

"Even accomplished draughtsmen will find in it much that will be of use to them. A copy of it should be kept for reference in every drawing office."—*Engineering*.

"An indispensable book for teachers of engineering drawing."—*Mechanics' Magazine*.

*Cottages, Villas, and Country Houses.*

DESIGNS and EXAMPLES of COTTAGES, VILLAS, and COUNTRY HOUSES; being the Studies of several eminent Architects and Builders; consisting of Plans, Elevations, and Perspective Views; with approximate Estimates of the Cost of each. In 4to, with 67 plates, price 1l. 1s., cloth.

*Builder's Price Book.*

THE BUILDER'S AND CONTRACTOR'S PRICE BOOK for 1874 (Lockwood & Co.'s), with which is incorporated Atchley's Builder's Price-Book and the Illustrated Price-Book, containing the present prices of all kinds of Builders' Materials and Labour, and of all Trades connected with Building; with Memoranda and Tables required in making Estimates and taking out Quantities, and Lists of the Members of the Metropolitan Board of Works, of Districts, District Officers, and District Surveyors, and the Metropolitan Bye-laws, with Five Plates, containing Plans, Elevations, and Views of Mansions, Villas, and Cottages, and a Specification. Fcap. 8vo, strongly half-bound, price 4s.

## *Handbook of Specifications.*

THE HANDBOOK OF SPECIFICATIONS; or, Practical Guide to the Architect, Engineer, Surveyor, and Builder, in drawing up Specifications and Contracts for Works and Constructions. Illustrated by Precedents of Buildings actually executed by eminent Architects and Engineers. Preceded by a Preliminary Essay, and Skeletons of Specifications and Contracts, &c., &c., and explained by numerous Lithograph Plates and Woodcuts. By Professor THOMAS L. DONALDSON, President of the Royal Institute of British Architects, Professor of Architecture and Construction, University College, London, M.I.B.A., Member of the various European Academies of the Fine Arts. With A REVIEW OF THE LAW OF CONTRACTS, and of the Responsibilities of Architects, Engineers, and Builders. By W. CUNNINGHAM GLEN, Barrister-at-Law, of the Middle Temple. 2 vols., 8vo, with upwards of 1100 pp. of text, and 33 Lithographic Plates, cloth, 2*l.* 2*s.* (Published at 4*l.*)

"In these two volumes of 1,100 pages (together), forty-four specifications of executed works are given, including the specifications for parts of the new Houses of Parliament, by Sir Charles Barry, and for the new Royal Exchange, by Mr. Tite, M.P.

"Amongst the other known buildings, the specifications of which are given, are the Wiltshire Lunatic Asylum (Wyatt and Brandon); Tothill Fields Prison (R. Abraham); the City Prison, Holloway (Bunning); the High School, Edinburgh (Hamilton); Clothworkers' Hall, London (Angel); Wellington College, Sandhurst (J. Shaw); Houses in Grosvenor Square, and elsewhere; St. George's Church, Doncaster (Scott); several works of smaller size by the Author, including Messrs. Shaw's Warehouse in Fetter Lane, a very successful elevation; the Newcastle-upon-Tyne Railway Station (J. Dobson); new Westminster Bridge (Page); the High Level Bridge, Newcastle (R. Stephenson); various works on the Great Northern Railway (Brydone); and one French specification for Houses in the Rue de Rivoli, Paris (M.M. Armand, Hittorff, Pellechet, and Rohault de Fleury, architects). The majority of the specifications have illustrations in the shape of elevations and plans.

"About 140 pages of the second volume are appropriated to an exposition of the law in relation to the legal liabilities of engineers, architects, contractors, and builders, by Mr. W. Cunningham Glen, Barrister-at-law; intended rather for those persons than for the legal practitioner. Donaldson's Handbook of Specifications must be bought by all architects."—*Builder*.

## *Specifications for Practical Architecture.*

SPECIFICATIONS FOR PRACTICAL ARCHITECTURE:

A Guide to the Architect, Engineer, Surveyor, and Builder; with an Essay on the Structure and Science of Modern Buildings. By FREDERICK ROGERS, Architect. With numerous Illustrations.

Demy 8vo, price 15*s.*, cloth.

\* \* A volume of specifications of a practical character being greatly required, and the old standard work of Alfred Bartholomew being out of print, the author, on the basis of that work, has produced the above. Some of the specifications he has so altered as to bring in the now universal use of concrete, the improvements in drainage, the use of iron, glass, asphalt, and other material. He has also inserted specifications of works that have been erected in his own practice.

## *The House-Owner's Estimator.*

THE HOUSE-OWNER'S ESTIMATOR; or, What will it Cost to Build, Alter, or Repair? A Price-Book adapted to the Use of Unprofessional People as well as for the Architectural Surveyor and Builder. By the late JAMES D SIMON, A.R.I.B.A. Edited and Revised by FRANCIS T. W. MILLER, Surveyor. With numerous Illustrations. Crown 8vo, cloth, price 3*s.* 6*d.* [*Ready*].

## Grantham's Iron Ship-Building, enlarged.

ON IRON SHIP-BUILDING; with Practical Examples and Details. Fifth Edition. Imp. 4to, boards, enlarged from 24 to 40 Plates (21 quite new), including the latest Examples. Together with separate Text, 12mo, cloth limp, also considerably enlarged, By JOHN GRANTHAM, M. Inst. C.E., &c. Price 2*l.* 2*s.* complete.

### Description of Plates.

- |   |   |
|---|---|
| <p>1. Hollow and Bar Keels, Stem and Stern Posts. [Pieces.]</p> <p>2. Side Frames, Floorings, and Bilge</p> <p>3. Floorings <i>continued</i>—Keelsons, Deck Beams, Gunwales, and Stringers.</p> <p>4. Gunwales <i>continued</i>—Lower Decks, and Orlop Beams.</p> <p>4<i>a</i>. Gunwales and Deck Beam Iron.</p> <p>5. Angle-Iron, T Iron, Z Iron, Bulb Iron, as Rolled for Building.</p> <p>6. Rivets, shown in section, natural size; Flush and Lapped Joints, with Single and Double Riveting.</p> <p>7. Plating, three plans; Bulkheads and Modes of Securing them.</p> <p>8. Iron Masts, with Longitudinal and Transverse Sections.</p> <p>9. Sliding Keel, Water Ballast, Moulding the Frames in Iron Ship Building, Levelling Plates.</p> <p>10. Longitudinal Section, and Half-breadth Deck Plan of Large Vessels on a reduced Scale.</p> <p>11. Midship Sections of Three Vessels.</p> <p>12. <i>Large Vessel</i>, showing Details—<i>Fore End</i> in Section, and End View, with Stern Post, Crutches, &amp;c.</p> <p>13. <i>Large Vessel</i>, showing Details—<i>After End</i> in Section, with End View, Stern Frame for Screw, and Rudder.</p> <p>14. <i>Large Vessel</i>, showing Details—<i>Midship Section</i>, half breadth.</p> <p>15. <i>Machines</i> for Punching and Shearing Plates and Angle-Iron, and for Bending Plates; Rivet Hearth.</p> <p>15<i>a</i>. Beam-Bending Machine, Independent Shearing, Punching and Angle-Iron Machine.</p> | <p>15<i>b</i>. Double Lever Punching and Shearing Machine, arranged for cutting Angle and T Iron, with Dividing Table and Engine.</p> <p>16. <i>Machines</i>.—Garforth's Riveting Machine, Drilling and Counter-Sinking Machine.</p> <p>16<i>a</i>. Plate Planing Machine.</p> <p>17. <i>Air Furnace</i> for Heating Plates and Angle-Iron: Various Tools used in Riveting and Plating.</p> <p>18. <i>Gunwale</i>; Keel and Flooring; Plan for Sheathing with Copper.</p> <p>18<i>a</i>. Grantham's Improved Plan of Sheathing Iron Ships with Copper.</p> <p>19. Illustrations of the Magnetic Condition of various Iron Ships.</p> <p>20. Gray's Floating Compass and Binnacle, with Adjusting Magnets, &amp;c.</p> <p>21. Corroded Iron Bolt in Frame of Wooden Ship; Jointing Plates.</p> <p>22-4. <i>Great Eastern</i>—Longitudinal Sections and Half-breadth Plans—Midship Section, with Details—Section in Engine Room, and Paddle Boxes.</p> <p>25-6. Paddle Steam Vessel of Steel.</p> <p>27. <i>Scarborough</i>—Paddle Vessel of Steel.</p> <p>28-9. Proposed Passenger Steamer.</p> <p>30. <i>Persian</i>—Iron Screw Steamer.</p> <p>31. Midship Section of H.M. Steam Frigate, <i>Warrior</i>.</p> <p>32. Midship Section of H.M. Steam Frigate, <i>Hercules</i>.</p> <p>33. Stem, Stern, and Rudder of H.M. Steam Frigate, <i>Bellerophon</i>.</p> <p>34. Midship Section of H.M. Troop Ship, <i>Serapis</i>.</p> <p>35. Iron Floating Dock.</p> |
|---|---|

"A thoroughly practical work, and every question of the many in relation to iron shipping which admit of diversity of opinion, or have various and conflicting personal interests attached to them, is treated with sober and impartial wisdom and good sense. . . . As good a volume for the instruction of the pupil or student of iron naval architecture as can be found in any language."—*Practical Mechanics' Journal*.

"A very elaborate work. . . . It forms a most valuable addition to the history of iron shipbuilding, while its having been prepared by one who has made the subject his study for many years, and whose qualifications have been repeatedly recognised, will recommend it as one of practical utility to all interested in shipbuilding."—*Army and Navy Gazette*.

## Pocket-Book for Marine Engineers.

A POCKET-BOOK FOR MARINE ENGINEERS. Containing Useful Rules and Formulæ in a compact form. By FRANK PROCTOR, Associate of the Institution of Naval Architects. Royal 32mo, oblong, leather, gilt edges, price 4*s.* [Ready.

## CARPENTRY, TIMBER, &c.

### *Tredgold's Carpentry, new, enlarged, and cheaper Edition.*

THE ELEMENTARY PRINCIPLES OF CARPENTRY : a Treatise on the Pressure and Equilibrium of Timber Framing, the Resistance of Timber, and the Construction of Floors, Arches, Bridges, Roofs, Uniting Iron and Stone with Timber, &c. To which is added an Essay on the Nature and Properties of Timber, &c., with Descriptions of the Kinds of Wood used in Building ; also numerous Tables of the Scantlings of Timber for different purposes, the Specific Gravities of Materials, &c. By THOMAS TREGOLD, C.E. Edited by PETER BARLOW, F.R.S. Fifth Edition, corrected and enlarged. With 64 Plates (11 of which now first appear in this edition), Portrait of the Author, and several Woodcuts. In 1 vol., 4to, published at 2*l.* 2*s.*, reduced to 1*l.* 5*s.*, cloth. /

“ ‘Tredgold's Carpentry’ ought to be in every architect's and every builder's library, and those who do not already possess it ought to avail themselves of the new issue.”—*Builder*.

“ A work whose monumental excellence must commend it wherever skilful carpentry is concerned. The Author's principles are rather confirmed than impaired by time, and, as now presented, combine the surest base with the most interesting display of progressive science. The additional plates are of great intrinsic value.”—*Building News*.

“ ‘Tredgold's Carpentry’ has ever held a high position, and the issue of the fifth edition, in a still more improved and enlarged form, will give satisfaction to a very large number of artisans who desire to raise themselves in their business, and who seek to do so by displaying a greater amount of knowledge and intelligence than their fellow-workmen. It is as complete a work as need be desired. To the superior workman the volume will prove invaluable ; it contains treatises written in language which he will readily comprehend.”—*Mining Journal*.

### *Grandy's Timber Tables.*

THE TIMBER IMPORTER'S, TIMBER MERCHANT'S, and BUILDER'S STANDARD GUIDE. By RICHARD E. GRANDY. Comprising :—An Analysis of Deal Standards, Home and Foreign, with comparative Values and Tabular Arrangements for Fixing Nett Landed Cost on Baltic and North American Deals, including all intermediate Expenses, Freight, Insurance, Duty, &c., &c. ; together with Copious Information for the Retailer and Builder. 12mo, price 7*s.* 6*d.* cloth.

“ Everything it pretends to be : built up gradually, it leads one from a forest to a treenail, and throws in, as a makeweight, a host of material concerning bricks, columns, cisterns, &c.—all that the class to whom it appeals requires.”—*English Mechanic*.

“ The only difficulty we have is as to what is NOT in its pages. What we have tested of the contents, taken at random, is invariably correct.”—*Illustrated Builder's Journal*.

### *Tables for Packing-Case Makers.*

PACKING-CASE TABLES ; showing the number of Superficial Feet in Boxes or Packing-Cases, from six inches square and upwards. Compiled by WILLIAM RICHARDSON, Accountant. Oblong 4to, cloth, price 3*s.* 6*d.*

“ Will save much labour and calculation to packing-case makers and those who use packing-cases.”—*Grocer*. “ Invaluable labour-saving tables.”—*Ironmonger*.

*Nicholson's Carpenter's Guide.*

THE CARPENTER'S NEW GUIDE; or, BOOK of LINES for CARPENTERS: comprising all the Elementary Principles essential for acquiring a knowledge of Carpentry. Founded on the late PETER NICHOLSON'S standard work. A new Edition, revised by ARTHUR ASHPITEL, F.S.A., together with Practical Rules on Drawing, by GEORGE PYNE. With 74 Plates, 4to, 1*l.* 1*s.* cloth.

*Dowsing's Timber Merchant's Companion.*

THE TIMBER MERCHANT'S AND BUILDER'S COMPANION; containing New and Copious Tables of the Reduced Weight and Measurement of Deals and Battens, of all sizes, from One to a Thousand Pieces, and the relative Price that each size bears per Lineal Foot to any given Price per Petersburg Standard Hundred; the Price per Cube Foot of Square Timber to any given Price per Load of 50 Feet; the proportionate Value of Deals and Battens by the Standard, to Square Timber by the Load of 50 Feet; the readiest mode of ascertaining the Price of Scantling per Lineal Foot of any size, to any given Figure per Cube Foot. Also a variety of other valuable information. By WILLIAM DOWSING, Timber Merchant. Second Edition. Crown 8vo, 3*s.* cloth.

"Everything is as concise and clear as it can possibly be made. There can be no doubt that every timber merchant and builder ought to possess it."—*Hull Advertiser.*

*Timber Freight Book.*

THE TIMBER IMPORTERS' AND SHIPOWNERS' FREIGHT BOOK: Being a Comprehensive Series of Tables for the Use of Timber Importers, Captains of Ships, Shipbrokers, Builders, and all Dealers in Wood whatsoever. By WILLIAM RICHARDSON, Timber Broker, author of "Packing Case Tables," &c. Crown 8vo, cloth, price 6*s.*

---



---

## MECHANICS, &c.

---

*Mechanic's Workshop Companion.*

THE OPERATIVE MECHANIC'S WORKSHOP COMPANION, and THE SCIENTIFIC GENTLEMAN'S PRACTICAL ASSISTANT; comprising a great variety of the most useful Rules in Mechanical Science; with numerous Tables of Practical Data and Calculated Results. By W. TEMPLETON, Author of "The Engineer's, Millwright's, and Machinist's Practical Assistant." Eleventh Edition. with Mechanical Tables for Operative Smiths, Millwrights, Engineers, &c.; together with several Useful and Practical Rules in Hydraulics and Hydrodynamics, a variety of Experimental Results, and an Extensive Table of Powers and Roots. 11 Plates. 12mo, 5*s.* bound. [*Recently published.*]

"As a text-book of reference, in which mechanical and commercial demands are judiciously met, TEMPLETON'S COMPANION stands unrivalled."—*Mechanics' Magazine.*

"Admirably adapted to the wants of a very large class. It has met with great success in the engineering workshop, as we can testify; and there are a great many men who, in a great measure, owe their rise in life to this little work."—*Building News.*

### *Engineer's Assistant.*

THE ENGINEER'S, MILLWRIGHT'S, and MACHINIST'S PRACTICAL ASSISTANT ; comprising a Collection of Useful Tables, Rules, and Data. Compiled and Arranged, with Original Matter, by W. TEMPLETON. 5th Edition. 18mo, 2s. 6d. cloth.

"So much varied information compressed into so small a space, and published at a price which places it within the reach of the humblest mechanic, cannot fail to command the sale which it deserves. With the utmost confidence we commend this book to the attention of our readers."—*Mechanics' Magazine*.

"Every mechanic should become the possessor of the volume, and a more suitable present to an apprentice to any of the mechanical trades could not possibly be made."—*Building News*.

### *Designing, Measuring, and Valuing.*

THE STUDENT'S GUIDE to the PRACTICE of MEASURING, and VALUING ARTIFICERS' WORKS ; containing Directions for taking Dimensions, Abstracting the same, and bringing the Quantities into Bill, with Tables of Constants, and copious Memoranda for the Valuation of Labour and Materials in the respective Trades of Bricklayer and Slater, Carpenter and Joiner, Painter and Glazier, Paperhanger, &c. With 43 Plates and Woodcuts. Originally edited by EDWARD DOBSON, Architect. New Edition, re-written, with Additions on Mensuration and Construction, and several useful Tables for facilitating Calculations and Measurements. By E. WYNDHAM TARN, M.A., Architect. 8vo, 10s. 6d. cloth. [Recently published.]

"This useful book should be in every architect's and builder's office. It contains a vast amount of information absolutely necessary to be known."—*The Irish Builder*.

"The book is well worthy the attention of the student in architecture and surveying, as by the careful study of it his progress in his profession will be much facilitated."—*Mining Journal*.

"We have failed to discover anything connected with the building trade, from excavating foundations to bell-hanging, that is not fully treated upon in this valuable work."—*The Artizan*.

"Mr. Tarn has well performed the task imposed upon him, and has made many further and valuable additions, embodying a large amount of information relating to the technicalities and modes of construction employed in the several branches of the building trade. . . . From the extent of the information which the volume embodies, and the care taken to secure accuracy in every detail, it cannot fail to prove of the highest value to students, whether training in the offices of provincial surveyors, or in those of London practitioners."—*Colliery Guardian*.

"Altogether the book is one which well fulfils the promise of its title-page, and we can thoroughly recommend it to the class for whose use it has been compiled. Mr. Tarn's additions and revisions have much increased the usefulness of the work, and have especially augmented its value to students. Finally, it is only just to the publishers to add that the book has been got up in excellent style, the typography being bold and clear, and the plates very well executed."—*Engineering*.

### *Superficial Measurement.*

THE TRADESMAN'S GUIDE TO SUPERFICIAL MEASUREMENT. Tables calculated from 1 to 200 inches in length, by 1 to 108 inches in breadth. For the use of Architects, Surveyors, Engineers, Timber Merchants, Builders, &c. By JAMES HAWKINGS. Fcp. 3s. 6d. cloth.



# MATHEMATICS, &c.

## *Gregory's Practical Mathematics.*

MATHEMATICS for PRACTICAL MEN ; being a Common-place Book of Pure and Mixed Mathematics. Designed chiefly for the Use of Civil Engineers, Architects, and Surveyors. Part I. PURE MATHEMATICS—comprising Arithmetic, Algebra, Geometry, Mensuration, Trigonometry, Conic Sections, Properties of Curves. Part II. MIXED MATHEMATICS—comprising Mechanics in general, Statics, Dynamics, Hydrostatics, Hydrodynamics, Pneumatics, Mechanical Agents, Strength of Materials. With an Appendix of copious Logarithmic and other Tables. By OLINTHUS GREGORY, LL.D., F.R.A.S. Enlarged by HENRY LAW, C.E. 4th Edition, carefully revised and corrected by J. R. YOUNG, formerly Professor of Mathematics, Belfast College ; Author of "A Course of Mathematics," &c. With 13 Plates. Medium 8vo, 1l. 1s. cloth.

"As a standard work on mathematics it has not been excelled."—*Artizan*.

"The engineer or architect will here find ready to his hand, rules for solving nearly every mathematical difficulty that may arise in his practice. As a moderate acquaintance with arithmetic, algebra, and elementary geometry is absolutely necessary to the proper understanding of the most useful portions of this book, the author very wisely has devoted the first three chapters to those subjects, so that the most ignorant may be enabled to master the whole of the book, without aid from any other. The rules are in all cases explained by means of examples, in which every step of the process is clearly worked out."—*Builder*.

"One of the most serviceable books to the practical mechanics of the country. . . . The edition of 1847 was fortunately entrusted to the able hands of Mr. Law, who revised it thoroughly, re-wrote many chapters, and added several sections to those which had been rendered imperfect by advanced knowledge. On examining the various and many improvements which he introduced into the work, they seem almost like a new structure on an old plan, or rather like the restoration of an old ruin, not only to its former substance, but to an extent which meets the larger requirements of modern times. . . . In the edition just brought out, the work has again been revised by Professor Young. He has modernised the notation throughout, introduced a few paragraphs here and there, and corrected the numerous typographical errors which have escaped the eyes of the former Editor. The book is now as complete as it is possible to make it. . . . We have carried our notice of this book to a greater length than the space allowed us justified, but the experiments it contains are so interesting, and the method of describing them so clear, that we may be excused for overstepping our limit. It is an instructive book for the student, and a Text-book for him who having once mastered the subjects it treats of, needs occasionally to refresh his memory upon them."—*Building News*.

## *The Metric System.*

A SERIES OF METRIC TABLES, in which the British Standard Measures and Weights are compared with those of the Metric System at present in use on the Continent. By C. H. DOWLING, C. E. Second Edition, revised and enlarged. 8vo, 10s. 6d. strongly bound.

"Mr. Dowling's Tables, which are well put together, come just in time as a ready reckoner for the conversion of one system into the other."—*Athenæum*.

"Their accuracy has been certified by Professor Airy, the Astronomer-Royal."—*Builder*.

"Resolution 8.—That advantage will be derived from the recent publication of Metric Tables, by C. H. Dowling, C.E."—*Report of Section F, British Association, Bath*.

*Inwood's Tables, greatly enlarged and improved.*

TABLES FOR THE PURCHASING of ESTATES, Freehold, Copyhold, or Leasehold; Annuities, Advowsons, &c., and for the Renewing of Leases held under Cathedral Churches, Colleges, or other corporate bodies; for Terms of Years certain, and for Lives; also for Valuing Reversionary Estates, Deferred Annuities, Next Presentations, &c., together with Smart's Five Tables of Compound Interest, and an Extension of the same to Lower and Intermediate Rates. By WILLIAM INWOOD, Architect. The 19th edition, with considerable additions, and new and valuable Tables of Logarithms for the more Difficult Computations of the Interest of Money, Discount, Annuities, &c., by M. FÉDOR THOMAN, of the Société Cr dit Mobilier of Paris. 12mo, 8s. cloth.

\* \* \* *This edition (the 19th) differs in many important particulars from former ones. The changes consist, first, in a more convenient and systematic arrangement of the original Tables, and in the removal of certain numerical errors which a very careful revision of the whole has enabled the present editor to discover; and secondly, in the extension of practical utility conferred on the work by the introduction of Tables now inserted for the first time. This new and important matter is all so much actually added to INWOOD'S TABLES; nothing has been abstracted from the original collection: so that those who have been long in the habit of consulting INWOOD for any special professional purpose will, as heretofore, find the information sought still in its pages.*

"Those interested in the purchase and sale of estates, and in the adjustment of compensation cases, as well as in transactions in annuities, life insurances, &c., will find the present edition of eminent service."—*Engineering*.

*Geometry for the Architect, Engineer, &c.*

PRACTICAL GEOMETRY, for the Architect, Engineer, and Mechanic; giving Rules for the Delineation and Application of various Geometrical Lines, Figures and Curves. By E. W. TARN, M.A., Architect, Author of "The Science of Building," &c. With 164 Illustrations. Demy 8vo. 12s. 6d.

"No book with the same objects in view has ever been published in which the clearness of the rules laid down and the illustrative diagrams have been so satisfactory."—*Scotsman*.

*Compound Interest and Annuities.*

THEORY of COMPOUND INTEREST and ANNUITIES; with Tables of Logarithms for the more Difficult Computations of Interest, Discount, Annuities, &c., in all their Applications and Uses for Mercantile and State Purposes. With an elaborate Introduction. By F DOR THOMAN, of the Soci t  Cr dit Mobilier, Paris. 12mo, cloth, 5s.

"A very powerful work, and the Author has a very remarkable command of his subject."—*Professor A. de Morgan*.

"We recommend it to the notice of actuaries and accountants."—*Athenæum*.

## SCIENCE AND ART.

### *The Military Sciences.*

AIDE-MÉMOIRE to the MILITARY SCIENCES. Framed from Contributions of Officers and others connected with the different Services. Originally edited by a Committee of the Corps of Royal Engineers. Second Edition, most carefully revised by an Officer of the Corps, with many additions; containing nearly 350 Engravings and many hundred Woodcuts. 3 vols. royal 8vo, extra cloth boards, and lettered, price 4*l.* 10*s.*

"A compendious encyclopædia of military knowledge, to which we are greatly indebted."—*Edinburgh Review*.

"The most comprehensive work of reference to the military and collateral sciences. Among the list of contributors, some seventy-seven in number, will be found names of the highest distinction in the services."—*Volunteer Service Gazette*.

### *Field Fortification.*

A TREATISE on FIELD FORTIFICATION, the ATTACK of FORTRESSES, MILITARY, MINING, and RECONNOITRING. By Colonel I. S. MACAULAY, late Professor of Fortification in the R. M. A., Woolwich. Sixth Edition, crown 8vo, cloth, with separate Atlas of 12 Plates, price 12*s.* complete.

### *Naval Science.*

NAVAL SCIENCE: a Quarterly Magazine for Promoting the Improvement of Naval Architecture, Marine Engineering, Steam Navigation, Seamanship. Edited by E. J. REED, C.B., M.P., and late Chief Constructor of the Navy, and JOSEPH WOOLLEY, M.A., LL.D.; F.R.A.S. Copiously illustrated. Price 2*s.* 6*d.* Now ready, Vol. II., containing Nos. 4 to 7, cloth boards, price 12*s.* 6*d.*

\* \* \* *The Contributors include the most Eminent Authorities in the several branches of the above subjects.*

### *Dye-Wares and Colours.*

THE MANUAL of COLOURS and DYE-WARES: their Properties, Applications, Valuation, Impurities, and Sophistications. For the Use of Dyers, Printers, Dry Salters, Brokers, &c. By J. W. SLATER. Post 8vo, cloth, price 7*s.* 6*d.*

"A complete encyclopædia of the *materia tinctoria*. The information respecting each article is full and precise, and the methods of determining the value of articles such as these, so liable to sophistication, are given with clearness, and are practical as well as valuable."—*Chemist and Druggist*.

### *Electricity.*

A MANUAL of ELECTRICITY; including Galvanism, Magnetism, Diamagnetism, Electro-Dynamics, Magno-Electricity, and the Electric Telegraph. By HENRY M. NOAD, Ph.D., F.C.S., Lecturer on Chemistry at St. George's Hospital. Fourth Edition, entirely rewritten. Illustrated by 500 Woodcuts. 8vo, 1*l.* 4*s.* cloth.

"The commendations already bestowed in the pages of the *Lancet* on the former editions of this work are more than ever merited by the present. The accounts given of electricity and galvanism are not only complete in a scientific sense, but, which is a rarer thing, are popular and interesting."—*Lancet*.

## *Text-Book of Electricity.*

THE STUDENT'S TEXT-BOOK OF ELECTRICITY: including Magnetism, Voltaic Electricity, Electro-Magnetism, Diamagnetism, Magneto-Electricity, Thermo-Electricity, and Electric Telegraphy. Being a Condensed Résumé of the Theory and Application of Electrical Science, including its latest Practical Developments, particularly as relating to Aërial and Submarine Telegraphy. By HENRY M. NOAD, Ph.D., Lecturer on Chemistry at St. George's Hospital. Post 8vo, 400 Illustrations, 12s. 6d. cloth.

"We can recommend Dr. Noad's book for clear style, great range of subject, a good index, and a plethora of woodcuts."—*Athenæum*.

"A most elaborate compilation of the facts of electricity and magnetism, and of the theories which have been advanced concerning them."—*Popular Science Review*.

"Clear, compendious, compact, well illustrated, and well printed."—*Lancet*.

"We can strongly recommend the work, as an admirable text-book, to every student—beginner or advanced—of electricity."—*Engineering*.

"Nothing of value has been passed over, and nothing given but what will lead to a correct, and even an exact, knowledge of the present state of electrical science."—*Mechanics' Magazine*.

"We know of no book on electricity containing so much information on experimental facts as this does, for the size of it, and no book of any size that contains so complete a range of facts."—*English Mechanic*.

## *Rudimentary Magnetism.*

RUDIMENTARY MAGNETISM: being a concise exposition of the general principles of Magnetical Science, and the purposes to which it has been applied. By Sir W. SNOW HARRIS, F.R.S. New and enlarged Edition, with considerable additions by Dr. NOAD, Ph.D. With 165 Woodcuts. 12mo, cloth, 4s. 6d.

"There is a good index, and this volume of 412 pages may be considered the best possible manual on the subject of magnetism."—*Mechanics' Magazine*.

"As concise and lucid an exposition of the phenomena of magnetism as we believe it is possible to write."—*English Mechanic*.

"Not only will the scientific student find this volume an invaluable book of reference, but the general reader will find in it as much to interest as to inform his mind. Though a strictly scientific work, its subject is handled in a simple and readable style."—*Illustrated Review*.

## *Chemical Analysis.*

THE COMMERCIAL HANDBOOK of CHEMICAL ANALYSIS; or Practical Instructions for the determination of the Intrinsic or Commercial Value of Substances used in Manufactures, in Trades, and in the Arts. By A. NORMANDY, Author of "Practical Introduction to Rose's Chemistry," and Editor of Rose's "Treatise of Chemical Analysis." Illustrated with Woodcuts. (*A new Edition of this work, revised by Dr. Noad, is in preparation.*)

"We recommend this book to the careful perusal of every one; it may be truly affirmed to be of universal interest, and we strongly recommend it to our readers as a guide, alike indispensable to the housewife as to the pharmaceutical practitioner."—*Medical Times*.

"The very best work on the subject the English press has yet produced."—*Mechanics' Magazine*.

## Science and Art.

THE YEAR-BOOK of FACTS in SCIENCE and ART; exhibiting the most important Improvements and Discoveries of the Past Year in Mechanics and the Useful Arts, Natural Philosophy, Electricity, Chemistry, Zoology and Botany, Geology and Mineralogy, Meteorology and Astronomy. By JOHN TIMBS, F.S.A., Author of "Curiosities of Science," "Things not Generally Known," &c. With Steel Portrait and Vignette. Fcap. 5s. cloth.

\* \* \* This work, published annually, records the proceedings of the principal scientific societies, and is indispensable to all who wish to possess a faithful record of the latest novelties in science and the arts.

The back Volumes, from 1861 to 1874, each containing a Steel Portrait, and an extra Volume for 1862, with Photograph, may still be had, price 5s. each.

"Persons who wish for a concise annual summary of important scientific events will find their desire in the 'Year Book of Facts.'"—*Athenæum*.

"The standard work of its class. Mr. Timbs's 'Year Book' is always full of suggestive and interesting matter, and is an excellent *résumé* of the year's progress in the sciences and the arts."—*Builder*.

"A correct exponent of scientific progress . . . a record of abiding interest. If anyone wishes to know what progress science has made, or what has been done in any branch of art during the past year, he has only to turn to Mr. Timbs's pages, and is sure to obtain the required information."—*Mechanics' Magazine*.

"There is not a more useful or more interesting compilation than the 'Year Book of Facts.' . . . The discrimination with which Mr. Timbs selects his facts, and the admirable manner in which he condenses into a comparatively short space all the salient features of the matters which he places on record, are deserving of great praise."—*Railway News*.

## Science and Scripture.

SCIENCE ELUCIDATIVE OF SCRIPTURE, AND NOT ANTAGONISTIC TO IT; being a Series of Essays on—1. Alleged Discrepancies; 2. The Theory of the Geologists and Figure of the Earth; 3. The Mosaic Cosmogony; 4. Miracles in general—Views of Hume and Powell; 5. The Miracle of Joshua—Views of Dr. Colenso: The Supernaturally Impossible; 6. The Age of the Fixed Stars—their Distances and Masses. By Professor J. R. YOUNG, Author of "A Course of Elementary Mathematics," &c. &c. Fcap. 8vo, price 5s. cloth lettered.

"Professor Young's examination of the early verses of Genesis, in connection with modern scientific hypotheses, is excellent."—*English Churchman*.

"Distinguished by the true spirit of scientific inquiry, by great knowledge, by keen logical ability, and by a style peculiarly clear, easy, and energetic."—*Nonconformist*.

"No one can rise from its perusal without being impressed with a sense of the singular weakness of modern scepticism."—*Baptist Magazine*.

"A valuable contribution to controversial theological literature."—*City Press*.

## Practical Philosophy.

A SYNOPSIS of PRACTICAL PHILOSOPHY. By the Rev. JOHN CARR, M.A., late Fellow of Trin. Coll., Cambridge. Second Edition. 18mo, 5s. cloth.

## *Dr. Lardner's Museum of Science and Art.*

THE MUSEUM OF SCIENCE AND ART. Edited by DIONYSIUS LARDNER, D.C.L., formerly Professor of Natural Philosophy and Astronomy in University College, London. CONTENTS: The Planets; are they inhabited Worlds?—Weather Prognostics—Popular Fallacies in Questions of Physical Science—Latitudes and Longitudes—Lunar Influences—Meteoric Stones and Shooting Stars—Railway Accidents—Light—Common Things:—Air—Locomotion in the United States—Cometary Influences—Common Things: Water—The Potter's Art—Common Things: Fire—Locomotion and Transport, their Influence and Progress—The Moon—Common Things: The Earth—The Electric Telegraph—Terrestrial Heat—The Sun—Earthquakes and Volcanoes—Barometer, Safety Lamp, and Whitworth's Micrometric Apparatus—Steam—The Steam Engine—The Eye—The Atmosphere—Time—Common Things: Pumps—Common Things: Spectacles, the Kaleidoscope—Clocks and Watches—Microscopic Drawing and Engraving—Locomotive—Thermometer—New Planets: Leverrier and Adams's Planet—Magnitude and Minuteness—Common Things: The Almanack—Optical Images—How to observe the Heavens—Common Things: the Looking-glass—Stellar Universe—The Tides—Colour—Common Things: Man—Magnifying Glasses—Instinct and Intelligence—The Solar Microscope—The Camera Lucida—The Magic Lantern—The Camera Obscura—The Microscope—The White Ants: their Manners and Habits—The Surface of the Earth, or First Notions of Geography—Science and Poetry—The Bee—Steam Navigation—Electro-Motive Power—Thunder, Lightning, and the Aurora Borealis—The Printing Press—The Crust of the Earth—Comets—The Stereoscope—The Pre-Adamite Earth—Eclipses—Sound. With upwards of 1200 Engravings on Wood. In 6 Double Volumes, handsomely bound in cloth, gilt, red edges, price £1 1s.

"The 'Museum of Science and Art' is the most valuable contribution that has ever been made to the Scientific Instruction of every class of society."—*Sir David Brewster in the North British Review.*

"Whether we consider the liberality and beauty of the illustrations, the charm of the writing, or the durable interest of the matter, we must express our belief that there is hardly to be found among the new books, one that would be welcomed by people of so many ages and classes as a valuable present."—*Examiner.*

\* \* *Separate books formed from the above, suitable for Workmen's Libraries, Science Classes, &c.*

COMMON THINGS EXPLAINED. With 233 Illustrations, 5s. cloth.

THE ELECTRIC TELEGRAPH POPULARIZED. 100 Illustrations, 1s. 6d. cloth.

THE MICROSCOPE. With 147 Illustrations, 2s. cloth.

POPULAR GEOLOGY. With 201 Illustrations, 2s. 6d. cloth.

POPULAR PHYSICS. With 85 Illustrations. 2s. 6d. cloth.

POPULAR ASTRONOMY. With 182 Illustrations, 4s. 6d. cloth.

STEAM AND ITS USES. With 89 Illustrations, 2s. cloth.

THE BEE AND WHITE ANTS. With 135 Illustrations, cloth, 2s.

DR. LARDNER'S SCIENTIFIC HANDBOOKS.

*Astronomy.*

THE HANDBOOK OF ASTRONOMY. By DIONYSIUS LARDNER, D.C.L., formerly Professor of Natural Philosophy and Astronomy in University College, London. Third Edition. Revised and Edited by EDWIN DUNKEN, F.R.A.S., Superintendent of the Altazimuth Department, Royal Observatory, Greenwich. With 37 plates and upwards of 100 Woodcuts. In 1 vol., small 8vo, cloth, 550 pages, price 7s. 6d.

"We can cordially recommend it to all those who desire to possess a complete manual of the science and practice of astronomy."—*Astronomical Reporter*.

*Optics.*

THE HANDBOOK OF OPTICS. New Edition. Edited by T. OLVER HARDING, B.A. Lond., of University College, London. With 298 Illustrations. Small 8vo, cloth, 448 pages, price 5s.

*Electricity.*

THE HANDBOOK of ELECTRICITY, MAGNETISM, and ACOUSTICS. New Edition. Edited by GEO. CAREY FOSTER, B.A., F.C.S. With 400 Illustrations. Small 8vo, cloth, price 5s.

"The book could not have been entrusted to any one better calculated to preserve the terse and lucid style of Lardner, while correcting his errors and bringing up his work to the present state of scientific knowledge."—*Popular Science Review*.

*Mechanics.*

THE HANDBOOK OF MECHANICS. [Reprinting.

*Hydrostatics.*

THE HANDBOOK of HYDROSTATICS and PNEUMATICS. New Edition, Revised, and Enlarged by BENJAMIN LOEWY, F.R.A.S. With numerous Illustrations. 5s. [Just published.

*Heat.*

THE HANDBOOK OF HEAT. New Edition, Re-written and Enlarged. By BENJAMIN LOEWY, F.R.A.S. [Preparing.

*Animal Physics.*

THE HANDBOOK OF ANIMAL PHYSICS. With 520 Illustrations. New edition, small 8vo, cloth, 7s. 6d. 732 pages. [Just published.

*Electric Telegraph.*

THE ELECTRIC TELEGRAPH. New Edition. Revised and Re-written by E. B. BRIGHT, F.R.A.S. 140 Illustrations. Small 8vo, 2s. 6d. cloth.

"One of the most readable books extant on the Electric Telegraph."—*Eng. Mechanic*.

NATURAL PHILOSOPHY FOR SCHOOLS. By DR. LARDNER 328 Illustrations. Fifth Edition. 1 vol. 3s. 6d. cloth.

"A very convenient class-book for junior students in private schools. It is intended to convey, in clear and precise terms, general notions of all the principal divisions of Physical Science."—*British Quarterly Review*.

ANIMAL PHYSIOLOGY FOR SCHOOLS. By DR. LARDNER. With 190 Illustrations. Second Edition. 1 vol. 3s. 6d. cloth.

"Clearly written, well arranged, and excellently illustrated."—*Gardener's Chronicle*.

## *Geology and Genesis Harmonised.*

THE TWIN RECORDS of CREATION; or, Geology and Genesis, their Perfect Harmony and Wonderful Concord. By GEORGE W. VICTOR LE VAUX. With numerous Illustrations. Fcap. 8vo, price 5s. cloth.

"We can recommend Mr. Le Vaux as an able and interesting guide to a popular appreciation of geological science."—*Spectator*.

"The author combines an unbounded admiration of science with an unbounded admiration of the Written Record. The two impulses are balanced to a nicety; and the consequence is, that difficulties, which to minds less evenly poised, would be serious, find immediate solutions of the happiest kinds."—*London Review*.

"Vigorously written, reverent in spirit, stored with instructive geological facts, and designed to show that there is no discrepancy or inconsistency between the Word and the works of the Creator. The future of Nature, in connexion with the glorious destiny of man, is vividly conceived."—*Watchman*.

"No real difficulty is shirked, and no sophistry is left unexposed."—*The Rock*.

## *Geology, Physical.*

PHYSICAL GEOLOGY. (Partly based on Major-General Portlock's Rudiments of Geology.) By RALPH TATE, A.L.S., F.G.S. Numerous Woodcuts. 12mo, 2s. [Ready.]

## *Geology, Historical.*

HISTORICAL GEOLOGY. (Partly based on Major-General Portlock's Rudiments of Geology.) By RALPH TATE, A.L.S., F.G.S. Numerous Woodcuts. 12mo, 2s. 6d. [Ready.]

\* \* Or PHYSICAL and HISTORICAL GEOLOGY, bound in One Volume, price 5s.

## *Wood-Carving.*

INSTRUCTIONS in WOOD-CARVING, for Amateurs; with Hints on Design. By A LADY. In emblematic wrapper, handsomely printed, with Ten large Plates, price 2s. 6d.

"The handicraft of the wood-carver, so well as a book can impart it, may be learnt from 'A Lady's' publication."—*Athenæum*.

"A real practical guide. It is very complete."—*Literary Churchman*.

"The directions given are plain and easily understood, and it forms a very good introduction to the practical part of the carver's art."—*English Mechanic*.

## *Popular Work on Painting.*

PAINTING POPULARLY EXPLAINED; with Historical Sketches of the Progress of the Art. By THOMAS JOHN GULLICK, Painter, and JOHN TIMBS, F.S.A. Second Edition, revised and enlarged. With Frontispiece and Vignette. In small 8vo, 6s. cloth.

\* \* This Work has been adopted as a Prize-book in the Schools of Art at South Kensington.

"A work that may be advantageously consulted. Much may be learned, even by those who fancy they do not require to be taught, from the careful perusal of this unpretending but comprehensive treatise."—*Art Journal*.

"A valuable book, which supplies a want. It contains a large amount of original matter, agreeably conveyed, and will be found of value, as well by the young artist seeking information as by the general reader. We give a cordial welcome to the book, and augur for it an increasing reputation."—*Builder*.

"This volume is one that we can heartily recommend to all who are desirous of understanding what they admire in a good painting."—*Daily News*.



*Delamotte's Works on Illumination & Alphabets.*

A PRIMER OF THE ART OF ILLUMINATION ; for the use of Beginners : with a Rudimentary Treatise on the Art, Practical Directions for its Exercise, and numerous Examples taken from Illuminated MSS., printed in Gold and Colours. By F. DELAMOTTE. Small 4to, price 9s. Elegantly bound, cloth antique.

"A handy book, beautifully illustrated ; the text of which is well written, and calculated to be useful. . . . The examples of ancient MSS. recommended to the student, which, with much good sense, the author chooses from collections accessible to all, are selected with judgment and knowledge, as well as taste."—*Athenæum*.

ORNAMENTAL ALPHABETS, ANCIENT and MEDIÆVAL ; from the Eighth Century, with Numerals ; including Gothic, Church-Text, large and small, German, Italian, Arabesque, Initials for Illumination, Monograms, Crosses, &c. &c., for the use of Architectural and Engineering Draughtsmen, Missal Painters, Masons, Decorative Painters, Lithographers, Engravers, Carvers, &c. &c. &c. Collected and engraved by F. DELAMOTTE, and printed in Colours. Royal 8vo, oblong, price 4s. cloth.

"A well-known engraver and draughtsman has enrolled in this useful book the result of many years' study and research. For those who insert enamelled sentences round gilded chalices, who blazon shop legends over shop-doors, who letter church walls with pithy sentences from the Decalogue, this book will be useful."—*Athenæum*.

EXAMPLES OF MODERN ALPHABETS, PLAIN and ORNAMENTAL ; including German, Old English, Saxon, Italic, Perspective, Greek, Hebrew, Court Hand, Engrossing, Tuscan, Riband, Gothic, Rustic, and Arabesque ; with several Original Designs, and an Analysis of the Roman and Old English Alphabets, large and small, and Numerals, for the use of Draughtsmen, Surveyors, Masons, Decorative Painters, Lithographers, Engravers, Carvers, &c. Collected and engraved by F. DELAMOTTE, and printed in Colours. Royal 8vo, oblong, price 4s. cloth.

"To artists of all classes, but more especially to architects and engravers, this very handsome book will be invaluable. There is comprised in it every possible shape into which the letters of the alphabet and numerals can be formed, and the talent which has been expended in the conception of the various plain and ornamental letters is wonderful."—*Standard*.

MEDIÆVAL ALPHABETS AND INITIALS FOR ILLUMINATORS. By F. DELAMOTTE, Illuminator, Designer, and Engraver on Wood. Containing 21 Plates, and Illuminated Title, printed in Gold and Colours. With an Introduction by J. WILLIS BROOKS. Small 4to, 6s. cloth gilt.

"A volume in which the letters of the alphabet come forth glorified in gilding and all the colours of the prism interwoven and intertwined and intermingled, sometimes with a sort of rainbow arabesque. A poem emblazoned in these characters would be only comparable to one of those delicious love letters symbolized in a bunch of flowers well selected and cleverly arranged."—*Sun*.

THE EMBROIDERER'S BOOK OF DESIGN ; containing Initials, Emblems, Cyphers, Monograms, Ornamental Borders, Ecclesiastical Devices, Mediæval and Modern Alphabets, and National Emblems. Collected and engraved by F. DELAMOTTE, and printed in Colours. Oblong royal 8vo, 2s. 6d. in ornamental boards.

# AGRICULTURE, &c.

## *Youatt and Burn's Complete Grazier.*

THE COMPLETE GRAZIER, and FARMER'S and CATTLE-BREEDER'S ASSISTANT. A Compendium of Husbandry. By WILLIAM YOUATT, ESQ., V.S. 11th Edition, enlarged by ROBERT SCOTT BURN, Author of "The Lessons of My Farm," &c. One large 8vo volume, 784 pp. with 215 Illustrations. 1*l.* 1*s.* half-bd.

### CONTENTS.

*On the Breeding, Rearing, Fattening, and General Management of Neat Cattle.*

—Introductory View of the different Breeds of Neat Cattle in Great Britain.—Comparative View of the different Breeds of Neat Cattle.—General Observations on Buying and Stocking a Farm with Cattle.—The Bull.—The Cow.—Treatment and Rearing of Calves.—Feeding of Calves for Veal.—Steers and Draught Oxen.—Grazing Cattle.—Summer Soiling Cattle.—Winter Box and Stall-feeding Cattle.—Artificial Food for Cattle.—Preparation of Food.—Sale of Cattle.

*On the Economy and Management of the Dairy.*—Milch Kine.—Pasture and other Food best calculated for Cows, as it regards their Milk.—Situation and Buildings proper for a Dairy, and the proper Dairy Utensils.—Management of Milk and Cream, and the Making and Preservation of Butter.—Making and Preservation of Cheese.—Produce of a Dairy.

*On the Breeding, Rearing, and Management of Farm-horses.*—Introductory and Comparative View of the different Breeds of Farm-horses.—Breeding Horses, Cart Stallions and Mares.—Rearing and Training of Colts.—Age, Qualifications, and Sale of Horses.—Maintenance and Labour of Farm-horses.—Comparative Merits of Draught Oxen and Horses.—Asses and Mules.

*On the Breeding, Rearing, and Fattening of Sheep.*—Introductory and Comparative View of the different Breeds.—Merino, or Spanish Sheep.—Breeding and Management of Sheep.—Treatment and Rearing of House-lambs, Feeding of Sheep, Folding Sheep, Shearing of Sheep, &c.

*On the Breeding, Rearing, and Fattening of Swine.*—Introductory and Comparative View of the different Breeds of Swine.—Breeding and Rearing of Pigs.—Feeding and Fattening of Swine.—Curing Pork and Bacon.

*On the Diseases of Cattle.*—Diseases Incident to Cattle.—Diseases of Calves.—Diseases of Horses.—Diseases of Sheep.—Diseases of Lambs.—Diseases Incident to Swine.—Breeding and Rearing of Domestic Fowls, Pigeons, &c.—Palmipedes, or Web-footed kinds.—Diseases of Fowls.

*On Farm Offices and Implements of Husbandry.*—The Farm-house, the Farm-yard, and its Offices.—Construction of Ponds.—Farm Cottages.—Farm Implements.—Steam Cultivation.—Sowing Machines, and Manure Distributors.—Steam Engines, Thrashing Machines, Corn-dressing Machines, Mills, Bruising Machines.

*On the Culture and Management of Grass Land.*—Size and Shape of Fields.—Fences.—Pasture Land.—Meadow Land.—Culture of Grass Land.—Hay-making.—Stacking Hay.—Impediments to the Scythe and the Eradication of Weeds.—Faring and Burning.—Draining. Irrigation.—Warping.

*On the Cultivation and Application of Grasses, Pulse, and Roots.*—Natural Grasses usually cultivated.—Artificial Grasses or Green Crops.—Grain and Pulse commonly cultivated for their Seeds, for their Straw, or for Green Forage.—Vegetables best calculated for Animal Food.—Qualities and Comparative Value of some Grasses and Roots as Food for Cattle.

*On Manures in General, and their Application to Grass Land.*—Vegetable Manures.—Animal Manures.—Fossil and Mineral Manures.—Liquid or Fluid Manures.—Composts.—Preservation of Manures.—Application of Manures.—Flemish System of Manuring.—Farm Account and Tables for Calculating Labour by the Acre, Rod, &c., and by the Day, Week, Month, &c.—Monthly Calendar of Work to be done throughout the Year.—Observations on the Weather.—INDEX.

"The standard and text-book, with the farmer and grazier."—*Farmer's Magazine.*

## *Ewart's Land Improvers' Pocket Book.*

THE LAND IMPROVERS' POCKET-BOOK OF FORMULÆ, Tables, and Memoranda, required in any Computation relating to the Permanent Improvement of Landed Property. By JOHN EWART, Land Surveyor and Agricultural Engineer. Royal 32mo, oblong. [In the Press.]

*Scott Burn's System of Modern Farming.*

OUTLINE OF MODERN FARMING. By R. SCOTT BURN. Soils, Manures, and Crops—Farming and Farming Economy, Historical and Practical—Cattle, Sheep, and Horses—Management of the Dairy, Pigs, and Poultry, with Notes on the Diseases of Stock—Utilisation of Town-Sewage, Irrigation, and Reclamation of Waste Land. New Edition. In 1 vol. 1250 pp., half-bound, profusely Illustrated, price 12s.

"There is sufficient stated within the limits of this treatise to prevent a farmer from going far wrong in any of his operations. . . . The author has had great personal experience, and his opinions are entitled to every respect."—*Observer*.

*Scott Burn's Introduction to Farming.*

THE LESSONS OF MY FARM: a Book for Amateur Agriculturists, being an Introduction to Farm Practice, in the Culture of Crops, the Feeding of Cattle, Management of the Dairy, Poultry, and Pigs, and in the Keeping of Farm-work Records. By ROBERT SCOTT BURN, Editor of "The Year-Book of Agricultural Facts," &c. With numerous Illustrations. Fcp. 6s. cloth.

"A most complete introduction to the whole round of farming practice."—*John Bull*.

"There are many hints in it which even old farmers need not be ashamed to accept."—*Morning Herald*.

*Tables for Land Valuers.*

THE LAND VALUER'S BEST ASSISTANT: being Tables, on a very much improved Plan, for Calculating the Value of Estates. To which are added, Tables for reducing Scotch, Irish, and Provincial Customary Acres to Statute Measure; also, Tables of Square Measure, and of the various Dimensions of an Acre in Perches and Yards, by which the Contents of any Plot of Ground may be ascertained without the expense of a regular Survey; &c. By R. HUDSON, C.E. New Edition, price 4s. strongly bound.

"This new edition includes tables for ascertaining the value of leases for any term of years; and for showing how to lay out plots of ground of certain acres in forms, square, round, &c., with valuable rules for ascertaining the probable worth of standing timber to any amount; and is of incalculable value to the country gentleman and professional man."—*Farmer's Journal*.

*Auctioneer's Assistant.*

THE APPRAISER, AUCTIONEER, BROKER, HOUSE AND ESTATE AGENT, AND VALUER'S POCKET ASSISTANT, for the Valuation for Purchase, Sale, or Renewal of Leases, Annuities, and Reversions, and of property generally; with Prices for Inventories, &c. By JOHN WHEELER, Valuer, &c. Third Edition, enlarged, by C. NORRIS. Royal 32mo, strongly bound, price 5s. [Recently published.]

"A neat and concise book of reference, containing an admirable and clearly-arranged list of prices for inventories, and a very practical guide to determine the value of furniture, &c."—*Standard*.

*The Civil Service Book-keeping.*

BOOK-KEEPING NO MYSTERY: its Principles popularly explained, and the Theory of Double Entry analysed. By an EXPERIENCED BOOK-KEEPER, late of H.M. Civil Service. Second Edition. Fcp. 8vo. price 1s. 6d. cloth.

"A book which brings the so-called mysteries within the comprehension of the simplest capacity."—*Sunday Times*.

*“A Complete Epitome of the Laws of this Country.”*

EVERY MAN'S OWN LAWYER; a Handy-Book of the Principles of Law and Equity. By A BARRISTER. 11th Edition carefully revised, including a Summary of the Ballot Act, The Adulteration of Food Act, The Masters' and Workmen's Arbitration Act, the Reported Cases of the Courts of Law and Equity, &c With Notes and References to the Authorities. 12mo, price 6s. 8a (saved at every consultation), strongly bound.

[Now ready.

*Comprising the Rights and Wrongs of Individuals, Mercantile and Commercial Law, Criminal Law, Parish Law, County Court Law Game and Fishery Laws, Poor Men's Lawsuits.*

THE LAWS OF

BANKRUPTCY—BILLS OF EXCHANGE—CONTRACTS AND AGREEMENTS—COPYRIGHT—DOWER AND DIVORCE—ELECTIONS AND REGISTRATION—INSURANCE—LIBEL AND SLANDER—MORTGAGES—SETTLEMENTS—STOCK EXCHANGE PRACTICE—TRADE MARKS AND PATENTS—TRESPASS, NUISANCES, ETC.—TRANSFER OF LAND, ETC.—WARRANTY—WILLS AND AGREEMENTS, ETC.

Also Law for

Landlord and Tenant—Master and Servant—Workmen and Apprentices—Heirs Devises, and Legatees—Husband and Wife—Executors and Trustees—Guardian and Ward—Married Women and Infants—Partners and Agents—Lender and Borrower—Debtor and Creditor—Purchaser and Vendor—Companies and Associations—Friendly Societies—Clergymen, Churchwardens—Medical Practitioners &c.—Bankers—Farmers—Contractors—Stock and Share Brokers—Sportsmen and Gamekeepers—Farriers and Horse-Dealers—Auctioneers, House-Agents—Innkeepers, &c.—Pawnbrokers—Surveyors—Railways and Carriers, &c. &c.

“No Englishman ought to be without this book . . . any person perfectly unformed on legal-matters, who may require sound information on unknown law points will, by reference to this book, acquire the necessary information; and thus on many occasions save the expense and loss of time of a visit to a lawyer.”—*Engineer.*

“It is a complete code of English Law, written in plain language which all can understand . . . should be in the hands of every business man, and all who wish to abolish lawyers' bills.”—*Weekly Times.*

“A useful and concise epitome of the law, compiled with considerable care.”—*Law Magazine.*

“What it professes to be—a complete epitome of the laws of this country, thorough and intelligible to non-professional readers. The book is a handy one to have in readiness when some knotty point requires ready solution.”—*Bell's Life.*

*Pawnbrokers' Legal Guide.*

THE PAWNBROKERS', FACTORS', and MERCHANTS' GUIDE to the LAW of LOANS and PLEDGES. With the Statutes and a Digest of Cases on Rights and Liabilities, Civil and Criminal, as to Loans and Pledges of Goods, Debentures, Mercantile, and other Securities. By H. C. FOLKARD, Esq., of Lincoln's Inn, Barrister-at-Law, Author of the “Law of Slander and Libel,” &c. 12mo, cloth boards, price 7s. [Just published.

*The Laws of Mines and Mining Companies.*

A PRACTICAL TREATISE on the LAW RELATING to MINES and MINING COMPANIES. By WHITTON ARUNDELL, Attorney-at-Law. Crown 8vo. 4s. cloth.



BOSTON PUBLIC LIBRARY



3 9999 06561 599 7

**Boston Public Library**  
**Central Library, Copley Square**

**Division of**  
**Reference and Research Services**

**Science and Technology**  
**Department**

The Date Due Card in the pocket indicates the date on or before which this book should be returned to the Library.

Please do not remove cards from this pocket.

SEP 12 1947

