



This is a digital copy of a book that was preserved for generations on library shelves before it was carefully scanned by Google as part of a project to make the world's books discoverable online.

It has survived long enough for the copyright to expire and the book to enter the public domain. A public domain book is one that was never subject to copyright or whose legal copyright term has expired. Whether a book is in the public domain may vary country to country. Public domain books are our gateways to the past, representing a wealth of history, culture and knowledge that's often difficult to discover.

Marks, notations and other marginalia present in the original volume will appear in this file - a reminder of this book's long journey from the publisher to a library and finally to you.

Usage guidelines

Google is proud to partner with libraries to digitize public domain materials and make them widely accessible. Public domain books belong to the public and we are merely their custodians. Nevertheless, this work is expensive, so in order to keep providing this resource, we have taken steps to prevent abuse by commercial parties, including placing technical restrictions on automated querying.

We also ask that you:

- + *Make non-commercial use of the files* We designed Google Book Search for use by individuals, and we request that you use these files for personal, non-commercial purposes.
- + *Refrain from automated querying* Do not send automated queries of any sort to Google's system: If you are conducting research on machine translation, optical character recognition or other areas where access to a large amount of text is helpful, please contact us. We encourage the use of public domain materials for these purposes and may be able to help.
- + *Maintain attribution* The Google "watermark" you see on each file is essential for informing people about this project and helping them find additional materials through Google Book Search. Please do not remove it.
- + *Keep it legal* Whatever your use, remember that you are responsible for ensuring that what you are doing is legal. Do not assume that just because we believe a book is in the public domain for users in the United States, that the work is also in the public domain for users in other countries. Whether a book is still in copyright varies from country to country, and we can't offer guidance on whether any specific use of any specific book is allowed. Please do not assume that a book's appearance in Google Book Search means it can be used in any manner anywhere in the world. Copyright infringement liability can be quite severe.

About Google Book Search

Google's mission is to organize the world's information and to make it universally accessible and useful. Google Book Search helps readers discover the world's books while helping authors and publishers reach new audiences. You can search through the full text of this book on the web at <http://books.google.com/>

K.F. WENDT LIBRARY
UW COLLEGE OF ENGR.
215 N. RANDALL AVENUE
MADISON, WIS. 53706

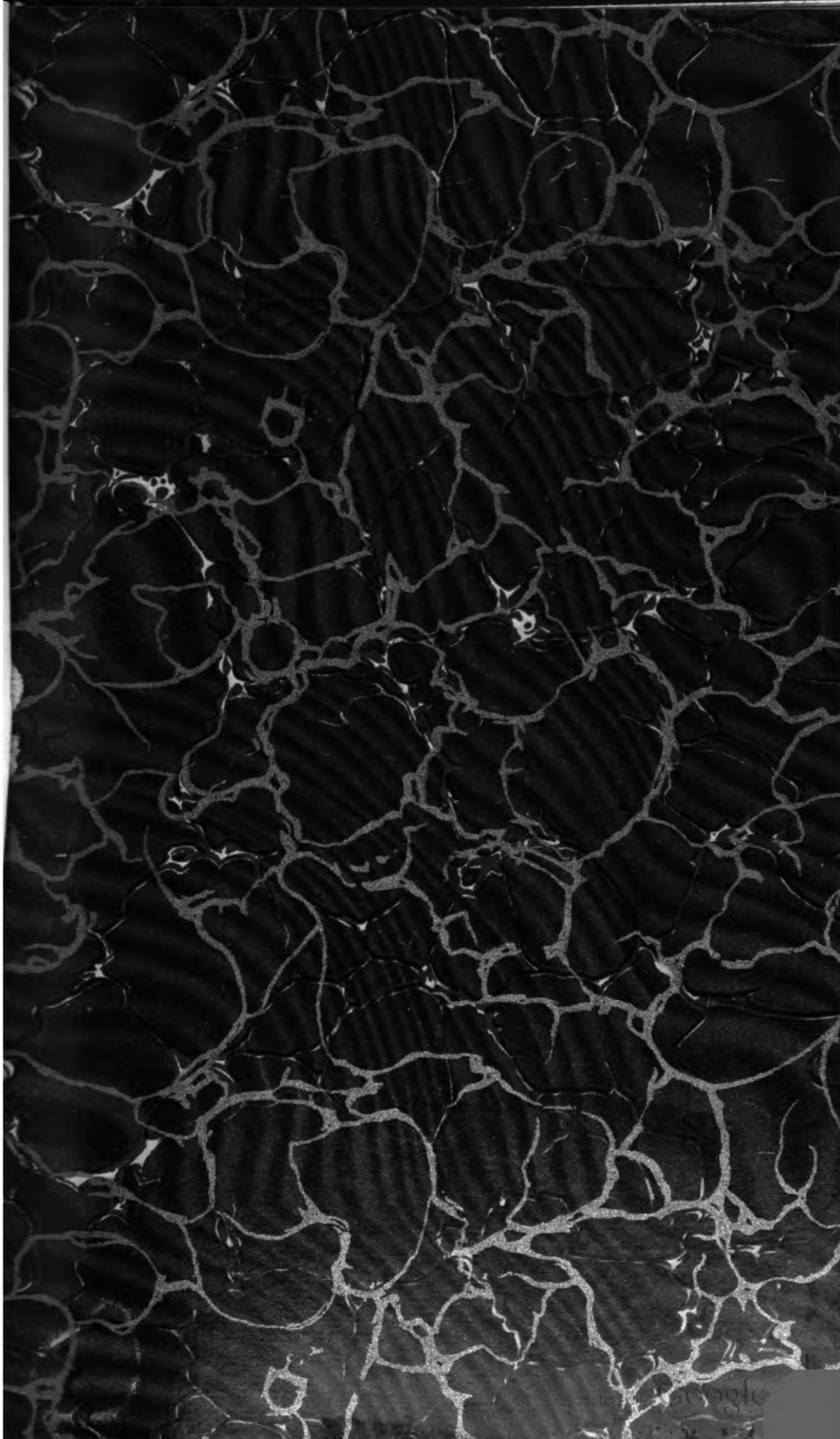

INTERNATIONAL LIBRARY OF TECHNOLOGY

A SERIES OF TEXTBOOKS FOR PERSONS ENGAGED IN THE ENGINEERING
PROFESSIONS AND TRADES OR FOR THOSE WHO DESIRE
INFORMATION CONCERNING THEM. FULLY ILLUSTRATED
AND CONTAINING NUMEROUS PRACTICAL
EXAMPLES AND THEIR SOLUTIONS

STORAGE BATTERIES
INCANDESCENT LIGHTING
ARC LIGHTING
INTERIOR WIRING
MODERN ELECTRIC-LIGHTING DEVICES
ELECTRIC SIGNS
ELECTRIC HEATING

SCRANTON:
INTERNATIONAL TEXTBOOK COMPANY

14C

Copyright, 1905, 1906, by INTERNATIONAL TEXTBOOK COMPANY.

Entered at Stationers' Hall, London.

**Storage Batteries: Copyright, 1905, by INTERNATIONAL TEXTBOOK COMPANY.
Entered at Stationers' Hall, London.**

**Incandescent Lighting: Copyright, 1905, by INTERNATIONAL TEXTBOOK COMPANY.
Entered at Stationers' Hall, London.**

**Arc Lighting: Copyright, 1905, by INTERNATIONAL TEXTBOOK COMPANY. Entered
at Stationers' Hall, London.**

**Interior Wiring: Copyright, 1905, by INTERNATIONAL TEXTBOOK COMPANY. Entered
at Stationers' Hall, London.**

**Modern Electric-Lighting Devices: Copyright, 1907, by INTERNATIONAL TEXTBOOK
COMPANY. Entered at Stationers' Hall, London.**

**Electric Signs: Copyright, 1907, by INTERNATIONAL TEXTBOOK COMPANY. Entered
at Stationers' Hall, London.**

**Electric Heating: Copyright, 1907, by INTERNATIONAL TEXTBOOK COMPANY.
Entered at Stationers' Hall, London.**

All rights reserved.

PRINTED IN THE UNITED STATES

**BURR PRINTING HOUSE
FRANKFORD AND JACOB STREETS
NEW YORK**



It 14C

T-14 C-6

PREFACE

The International Library of Technology is the outgrowth of a large and increasing demand that has arisen for the Reference Libraries of the International Correspondence Schools on the part of those who are not students of the Schools. As the volumes composing this Library are all printed from the same plates used in printing the Reference Libraries above mentioned, a few words are necessary regarding the scope and purpose of the instruction imparted to the students of—and the class of students taught by—these Schools, in order to afford a clear understanding of their salient and unique features.

The only requirement for admission to any of the courses offered by the International Correspondence Schools, is that the applicant shall be able to read the English language and to write it sufficiently well to make his written answers to the questions asked him intelligible. Each course is complete in itself, and no textbooks are required other than those prepared by the Schools for the particular course selected. The students themselves are from every class, trade, and profession and from every country; they are, almost without exception, busily engaged in some vocation, and can spare but little time for study, and that usually outside of their regular working hours. The information desired is such as can be immediately applied in practice, so that the student may be enabled to exchange his present vocation for a more congenial one, or to rise to a higher level in the one he now pursues. Furthermore, he wishes to obtain a good working knowledge of the subjects treated in the shortest time and in the most direct manner possible.

In meeting these requirements, we have produced a set of books that in many respects, and particularly in the general plan followed, are absolutely unique. In the majority of subjects treated the knowledge of mathematics required is limited to the simplest principles of arithmetic and mensuration, and in no case is any greater knowledge of mathematics needed than the simplest elementary principles of algebra, geometry, and trigonometry, with a thorough, practical acquaintance with the use of the logarithmic table. To effect this result, derivations of rules and formulas are omitted, but thorough and complete instructions are given regarding how, when, and under what circumstances any particular rule, formula, or process should be applied; and whenever possible one or more examples, such as would be likely to arise in actual practice—together with their solutions—are given to illustrate and explain its application.

In preparing these textbooks, it has been our constant endeavor to view the matter from the student's standpoint, and to try and anticipate everything that would cause him trouble. The utmost pains have been taken to avoid and correct any and all ambiguous expressions—both those due to faulty rhetoric and those due to insufficiency of statement or explanation. As the best way to make a statement, explanation, or description clear is to give a picture or a diagram in connection with it, illustrations have been used almost without limit. The illustrations have in all cases been adapted to the requirements of the text, and projections and sections or outline, partially shaded, or full-shaded perspectives have been used, according to which will best produce the desired results. Half-tones have been used rather sparingly, except in those cases where the general effect is desired rather than the actual details.

It is obvious that books prepared along the lines mentioned must not only be clear and concise beyond anything heretofore attempted, but they must also possess unequalled value for reference purposes. They not only give the maximum of information in a minimum space, but this information is so ingeniously arranged and correlated, and the

PREFACE

v

indexes are so full and complete, that it can at once be made available to the reader. The numerous examples and explanatory remarks, together with the absence of long demonstrations and abstruse mathematical calculations, are of great assistance in helping one select the proper formula, method, or process and in teaching him how and when it should be used.

This volume treats of storage batteries, incandescent and arc lighting, interior wiring, modern electric-lighting devices, electric signs, and electric heating. The standard types of storage batteries are freely illustrated and described, and very complete directions are given for the proper care of storage batteries. Open-arc lamps, enclosed-arc lamps, recent types of flaming-arc lamps, incandescent lamps with filaments of carbon, tantalum, osmium, and tungsten, Nernst lamps, mercury-vapor lamps, and Moore lighting tubes are treated in great detail. The descriptions, connecting diagrams, and light-distribution curves of these devices will be found especially valuable. In presenting the subject of interior wiring, the object has been to show how such work should be done in order to be safe and in accord with the latest requirements of the Underwriters. The sections on electric signs and electric heating contain explanations of recent devices employed in these rapidly growing branches of the electrical industry.

The method of numbering the pages, cuts, articles, etc. is such that each subject or part, when the subject is divided into two or more parts, is complete in itself; hence, in order to make the index intelligible, it was necessary to give each subject or part a number. This number is placed at the top of each page, on the headline, opposite the page number; and to distinguish it from the page number it is preceded by the printer's section mark (§). Consequently, a reference such as § 16, page 26, will be readily found by looking along the inside edges of the headlines until § 16 is found, and then through § 16 until page 26 is found.

INTERNATIONAL TEXTBOOK COMPANY

CONTENTS

	<i>Section</i>	<i>Page</i>
STORAGE BATTERIES		
General Description	27	1
Lead Accumulators	27	2
Bimetallic Accumulators	27	25
Installation and Care of Storage Cells . .	27	30
The Electrolyte	27	34
Charging	27	37
Discharging	27	39
Use of Accumulators in Central Stations .	27	54
Storage-Battery Regulating Appliances .	27	64
End-Cell Switches	27	64
Storage-Battery Boosters	27	68
General Data on Storage Cells	27	83
INCANDESCENT LIGHTING		
Incandescent Lighting	32	3
The Incandescent Lamp	32	3
Measurements and Lamp Calculations . .	32	12
Light Distribution	32	21
Recent Types of Incandescent Lamps . .	32	35
Systems of Distribution	33	1
Methods of Connecting Lamps	33	2
Direct-Current Constant-Potential System	33	6
Direct-Current Constant-Current System .	33	15
Alternating-Current Constant-Potential System	33	15
Alternating-Current Constant-Current System	33	34
Lamps	33	36
Line Calculations	33	44

INCANDESCENT LIGHTING—Continued	Section	Page
Transformer Testing	33	52
Storage Batteries in Lighting Stations	33	62
 ARC LIGHTING		
The Arc	34	1
Arc-Light Carbons	34	11
Photometry of the Arc Lamp	34	15
Methods of Distribution	34	26
Arc Lamps	34	35
Special Applications of Arc Lamps	34	60
Care and Adjustment of Arc Lamps	34	64
Line Work for Arc Lighting	35	1
Testing Arc-Light Lines	35	10
Lightning Protection for Arc Circuits	35	16
Arc-Light Dynamos	35	17
Direct-Current Machines	35	17
Arc-Light Switchboards	35	32
 INTERIOR WIRING		
Preliminary Considerations	43	1
Fires Caused by Electric Wiring	43	2
The National Electrical Code	43	2
General Rules	43	10
Wiring for Low-Potential Systems	43	16
Switches and Cut-Outs	43	23
Open Work in Dry Places	43	32
Simple Example of Factory Wiring	43	32
Fuses	43	32
Uniform Drop in Feeder Lines	44	1
Calculating Sizes of Wire Required	44	1
Wiring in Damp Places	44	17
Concealed Wiring	44	19
Wiring a Dwelling House	44	29
Specifications for Concealed Electric-Light Wiring	44	36
Switches	44	38
Fixtures	44	43
Location and Distribution of Lamps	44	47

CONTENTS

INTERIOR WIRING—Continued	<i>Section</i>	<i>Page</i>
Conduit Wiring	44	48
Wooden Moldings	44	60
Tests	44	62
Marine Work	44	65
Wiring Estimates	44	69
Combining Several Wiring Systems . . .	45	1
Store Lighting	45	1
Theater Wiring	45	4
Wiring for Special Purposes	45	5
High-Potential Systems	45	11
Wiring for Arc Lamps	45	13
Wiring for Electric Motors	45	17
Bell Wiring	45	20
Batteries	45	23
Annunciators	45	26
Bell and Annunciator Circuits	45	29
Special Appliances	45	38
Burglar Alarms	45	40
Electric Gas Lighting	45	44
Burners for Parallel System	45	44
Apparatus for Series Lighting System . .	45	49
MODERN ELECTRIC-LIGHTING DEVICES		
Luminous Efficiency	55	1
Incandescent Lamps	55	2
Metallized-Filament Lamps	55	2
Metallic-Filament Lamps	55	5
Tantalum Lamps	55	6
Osmium Lamps	55	10
Tungsten Lamps	55	13
The Nernst Lamp	55	16
Tube Lighting	55	27
Mercury-Vapor Lamps	55	28
Connections of Mercury-Vapor Lamps . .	55	31
Operation of Mercury-Vapor Lamps . . .	55	36
Comparison of Mercury-Vapor Lamps With Other Light Sources	55	37

MODERN ELECTRIC-LIGHTING DEVICES—

Continued

	<i>Section</i>	<i>Page</i>
Moore Lighting Tubes	55	39
Flaming-Arc Lamps	55	47
Excello Flaming-Arc Lamps	55	50
The Beck Lamp	55	56
Characteristics of Flaming-Arc Lamps	55	58
Carbone Arc Lamps	55	61
Magnetite Luminous-Arc Lamp	55	62
 ELECTRIC SIGNS		
Fixed Electric Signs	56	1
Illuminated Signs	56	2
Transparent Signs	56	2
Exposed-Bulb Signs	56	5
Changeable Signs	56	10
Changes in Intensity of Light	56	10
Thermostats for Signs	56	10
Mechanical Flashers	56	15
Changes in Display	56	19
Talking Signs	56	21
 ELECTRIC HEATING		
Heating Effects of Electric Currents	57	1
Applications of Electric Heat	57	8
Thawing Frozen Water Pipes	57	10
Welding	57	13
Annealing	57	18
Electrolytic Forge	57	18
Electric Furnaces	57	20
Air Heating	57	21
Water Heating	57	28
Heating Appliances for Domestic Use	57	24
Miscellaneous Heating Devices	57	29

STORAGE BATTERIES

GENERAL DESCRIPTION

1. A storage battery, secondary battery, or accumulator, as it is variously called, is an apparatus consisting of certain materials so arranged that when they have undergone chemical action, due to the influence of a current of electricity, the combination has acquired the properties of a primary cell and is enabled to discharge into a closed circuit approximately the same quantity of electricity as the original charge. Strictly speaking, a storage battery is a group of individual cells connected together, but the term battery is often used when a single cell is meant.

Many forms of primary cell may, when exhausted, be more or less regenerated by passing through them, in the opposite direction to the current they produce, a current from some external source. It is customary, however, to consider as accumulators only those cells whose original construction is similar to an exhausted battery; that is, they cannot be used as sources of electricity until they have been charged by passing a current through them.

Much confusion exists in the use of the terms positive and negative when speaking of the plates of a secondary cell, for in charging the cell the current is in the reverse direction to that which flows when the cell is acting as a primary cell and discharging; it is customary, however, to speak of the plate at which the current enters the cell (while charging) as the *positive plate*. In fact, whether charging or discharging, this plate is at a higher potential than the other, which justifies this use of the term, although with respect to the chemical

For notice of copyright, see page immediately following the title page

actions in the cell the positive and the negative plates are reversed in the two operations.

Accumulators may be divided into two general classes: (1) *lead accumulators*, and (2) *bimetallic accumulators*; the cells now in use are almost wholly of the first class.

LEAD ACCUMULATORS

PLANTÉ CELL

2. The original **lead accumulator**, as made by Planté, consists of two plates of lead, usually rolled together in a spiral and separated by strips of rubber or other suitable insulating material, placed in dilute sulphuric acid. On sending a current from some external source through this cell, the water becomes decomposed—the oxygen combines with the positive plate, forming lead oxide or peroxide, while the hydrogen collects at the negative plate.

On disconnecting the source of the applied current, and completing the external circuit of the cell, the water is again decomposed—the oxygen uniting with the hydrogen collected at the negative plate and with the lead plate itself, and the hydrogen uniting with the oxygen of the oxide of lead at the positive plate—thus producing a current in the opposite direction to the applied current.

Owing to the fact that the formation of the layer of oxide prevents further oxidation, the amount of chemical change due to the applied current is small, so the secondary current from the cell is of short duration; after this current has ceased, however, the surface of the positive plate is much increased, owing to the removal of the oxygen from the lead oxide, leaving the metallic lead in a spongy form. On again sending a current through the cell a further oxidation of this (positive) plate takes place, and by continuing this process, reversing the current each time it is sent through, both positive and negative plates become porous to a considerable depth, thus very much increasing the surface of

which the oxidation can take place. This process might be carried on until the whole plate is reduced to spongy lead; in that case the plate would not hold together, so a sufficient amount of the original plate must be left for mechanical strength. After the plates are so *formed*, they are ready to be used as an accumulator.

This forming process is, however, too slow and expensive for commercial use. Batteries in which the Planté type of plate is used are now formed by special electrochemical methods, so that the active material can be produced in a comparatively short time.

FAURE CELL

3. Another method of preparing the plates is to apply the active substance in the form of a paste. This process was invented by Faure. The first charging current converts the paste on the positive plate into lead peroxide, and that on the negative into spongy lead. The substance applied may be lead oxide (litharge) PbO , lead sulphate, minium Pb_3O_4 , lead peroxide PbO_2 , or mixtures of these substances.

The substances are applied in various ways; one method is to make a paste of Pb_3O_4 (minium) with dilute sulphuric acid for the positive and a similar paste with PbO (litharge) for the negative. The sulphuric acid and the litharge combine to form lead sulphate and water. On the positive plate the acid combines with Pb_3O_4 to form lead peroxide, lead sulphate, and water. In each case the action is only partial, the amount of lead sulphate and lead peroxide formed depending on the strength of the acid solution. These pastes were originally applied directly to the surface of the plain lead plate, but as they proved to be only slightly adhesive, the plates were prepared by scratching or otherwise roughening the surface, which process has been gradually extended until the lead plates are now cast into grids, or latticework plates, in the spaces of which the paste is applied.

The grids are usually designed to hold the active material securely in position; to this end their perforations are not of the same area throughout the thickness of the plate, but

wider or narrower in the center, so as to hold the filling of active material by the dovetailing action of their shape.

After the grids have been filled with active material, they are set up in pairs in suitable vessels and surrounded by an electrolyte consisting of sulphuric acid diluted to about 1.17 specific gravity, which density corresponds to about 23 per cent. of acid in the liquid. A charging current is then sent through the cell from some external source; the action of this current decomposes the water, the oxygen of which further oxidizes the lead oxide (litharge or minium) to peroxide, at the positive plate, the hydrogen going to the negative plate, where it reduces the lead sulphate to spongy lead by uniting with SO_2 , forming sulphuric acid. Thus, the active material becomes lead peroxide on the positive plate and spongy lead on the negative. By many investigators this lead peroxide is thought to be hydrated lead peroxide; that is, it contains a certain amount of hydrogen and oxygen in excess of the normal peroxide, and is represented by the formula $H_2Pb_2O_5$. This, as well as many of the actions that occur in accumulators, is not clearly established as yet.

Continuing the charging current when all the active material is thus converted produces no effect, except to further decompose the water; the resulting gases pass off through the water, giving it a milky appearance. This phenomenon is known as *gassing*, or boiling, and is an indication that the cells are fully charged.

4. On discontinuing the charging current at the gassing point and completing the external circuit of the cell, a current will flow in the opposite direction to that of the charging current, the resulting chemical action being to change lead peroxide to lead sulphate at the positive plate and the spongy lead to lead sulphate at the negative. The sulphates thus formed may not be all of the same proportions; one may exist as red, another as yellow, and a third as white crystals, of which the white sulphate is best known, as it is formed when the cell is considerably discharged, and is extremely troublesome. This discharge may be continued until all

chemical action ceases and the E. M. F. consequently falls to zero; but this is not advisable, since, if the discharge is carried beyond a certain point, the red or yellow sulphates, probably by combination with the litharge, PbO , form the white insoluble sulphate; this, being a non-conductor, materially increases the internal resistance of the cell, and when removed usually carries some of the active material with it, as it is very adhesive.

The exact nature of the chemical reactions taking place in a storage cell are not altogether understood. There are a number of more or less complicated secondary reactions, but it is now generally accepted that the main reaction on charging is the formation of lead peroxide at the positive plate and spongy lead at the negative; on discharging, the final result is the formation of lead sulphate on both plates, as explained above. The reaction may be expressed as follows:

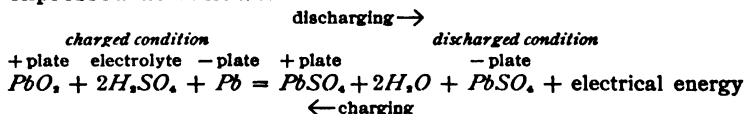

The left-hand side of the equation represents the fully charged condition. The active material on the positive plate is lead peroxide and that on the negative, spongy lead. These plates are immersed in the electrolyte containing sulphuric acid, H_2SO_4 . When the cell is discharged, it gives up electrical energy and the substances are changed to those shown on the right-hand side of the equation. Lead sulphate, $PbSO_4$, is formed on both plates and water is also formed. This water mixes with the electrolyte and lowers its specific gravity. When the operation is reversed and the cells charged, the plates are in the initial condition represented by the right-hand side of the equation. Electrical energy is supplied from an outside source and the lead sulphate on the positive plate is converted into lead peroxide, while that on the negative is changed into spongy lead. Sulphuric acid is also formed and this mixes with the electrolyte, causing the specific gravity to increase as the charging progresses. When the cells have

been properly charged, the positive plate is a chocolate color, while the negative is a slaty gray.

The presence of the insoluble sulphate is made apparent by the formation of a white coating or glaze over the plates, which are then said to be *sulphated*. If the cells are discharged and left to stand with the electrolyte in place, sulphating takes place rapidly.

5. It has been shown that sulphuric acid is formed during the charge and decomposed during discharge; thus, the proportions of it in the electrolyte, consequently, the density of the electrolyte, vary with the state of charge of the cell; starting with a specific gravity of 1.150, the specific gravity will be found to be about 1.20 when the cell is fully charged, indicating the presence of about 27 per cent. of sulphuric acid in the electrolyte. The variation in density of the electrolyte with discharge and charge is shown by the lower curves in Figs. 1 and 2.

The E. M. F. of this cell is approximately 2 volts, being 2.04 when the discharge starts, which gradually falls to 1.75 volts when nearly discharged; beyond this point, further discharging causes the E. M. F. to fall more rapidly, the decrease after 1.75 volts being very marked. The upper curves in Figs. 1 and 2 show the variation in the potential difference at the terminals of a cell, the curve in Fig. 1 showing the falling off during discharge and Fig. 2 the rise during charge.

6. **Buckling.**—The rating of accumulators is usually based on their capacity when discharged to an E. M. F. of 1.75 or 1.8 volts; cells should not be continuously discharged to below 1.75 volts, as below this point injurious sulphating will occur. This sulphating may lead to a distortion of the positive plate, known as **buckling**, unless the grids are strong mechanically. As the plates are located very close together in the cells to reduce the internal resistance, buckling is liable to cause the plates to touch, thus short-circuiting the cell.

The cause of buckling seems to be the formation of sulphate

in the plugs of active material that fill the spaces of the grids, thus causing an expansion; lead having very little elasticity, the grid is forced out of shape. As frequently constructed, the edges of the grid are heavier than the intermediate portion, so that the effect of the distortion is to bulge the plate in the center. If the plates are not discharged too far and too rapidly, the expansion of the active material is gradual, causing the grid to stretch evenly.

7. Rating of Cells.—The quantity of electricity that may be taken from a completely charged cell depends on the amount (weight) of material altered by the chemical action, as in a primary cell; while the rate at which this material is altered, consequently, the rate at which the electricity can be taken out (the rate of discharge in amperes), and, to a large extent, the amount of material altered, depends on the surface of the active material exposed to the chemical action.

Cells are rated at a certain number of ampere-hours capacity, depending on both the weight and the surface area of the active material in the cell; a certain economical discharge rate is also recommended, depending on the surface of the plates exposed to the electrolyte. If this discharge rate be continually exceeded, the chemical action goes on too rapidly, the white sulphate is formed in the active material of the positive plate, finally causing disintegration of the active material, even if the discharge is not carried beyond the point (1.75) given above. With the ordinary construction, the normal discharge rate is about .04 ampere per square inch of surface (both sides) of positive plate, and the discharge capacity about 4 ampere-hours per pound of plate (both positive and negative plate included).

8. Change of E. M. F. With Discharge.—The upper curve in Fig. 1 shows the manner in which the E. M. F. of an accumulator falls as the discharge proceeds. In this case the cell was connected to a variable external resistance, such that about the normal discharge current, as advised by the manufacturers, was maintained throughout the test in the external

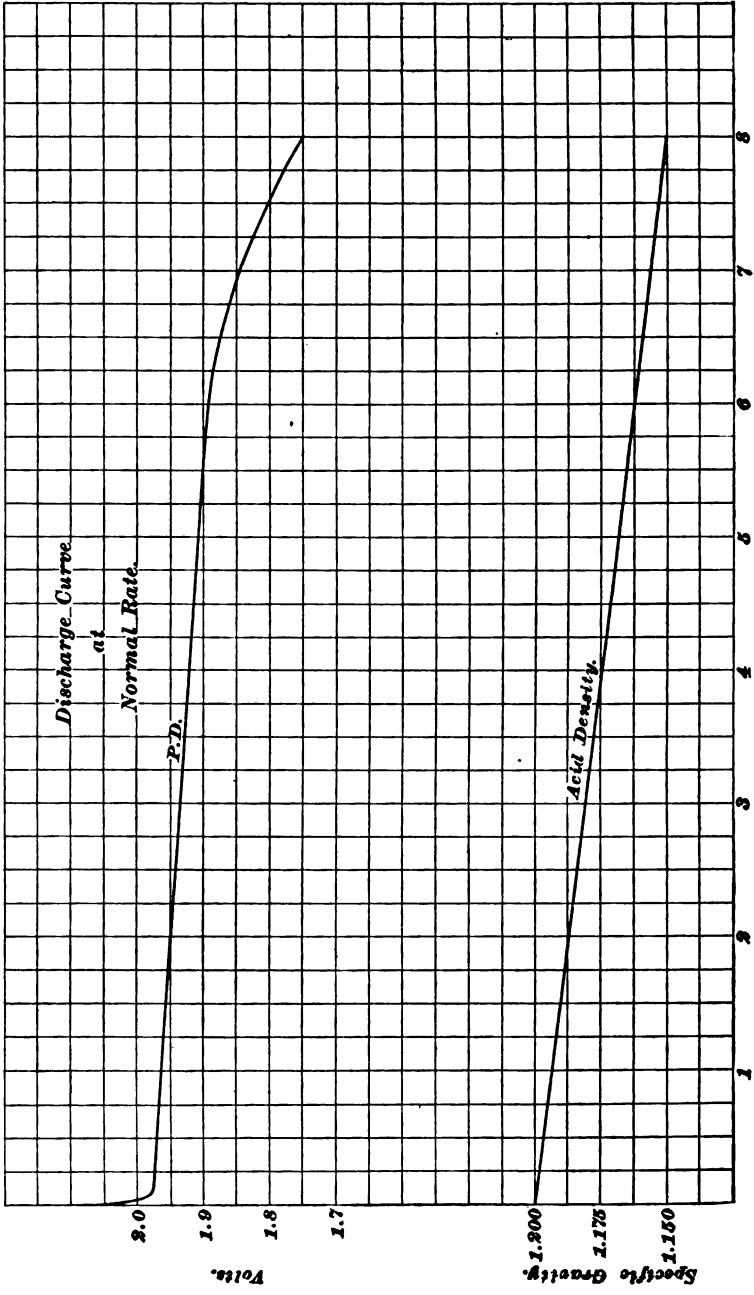

Hours Discharge.
FIG. 1

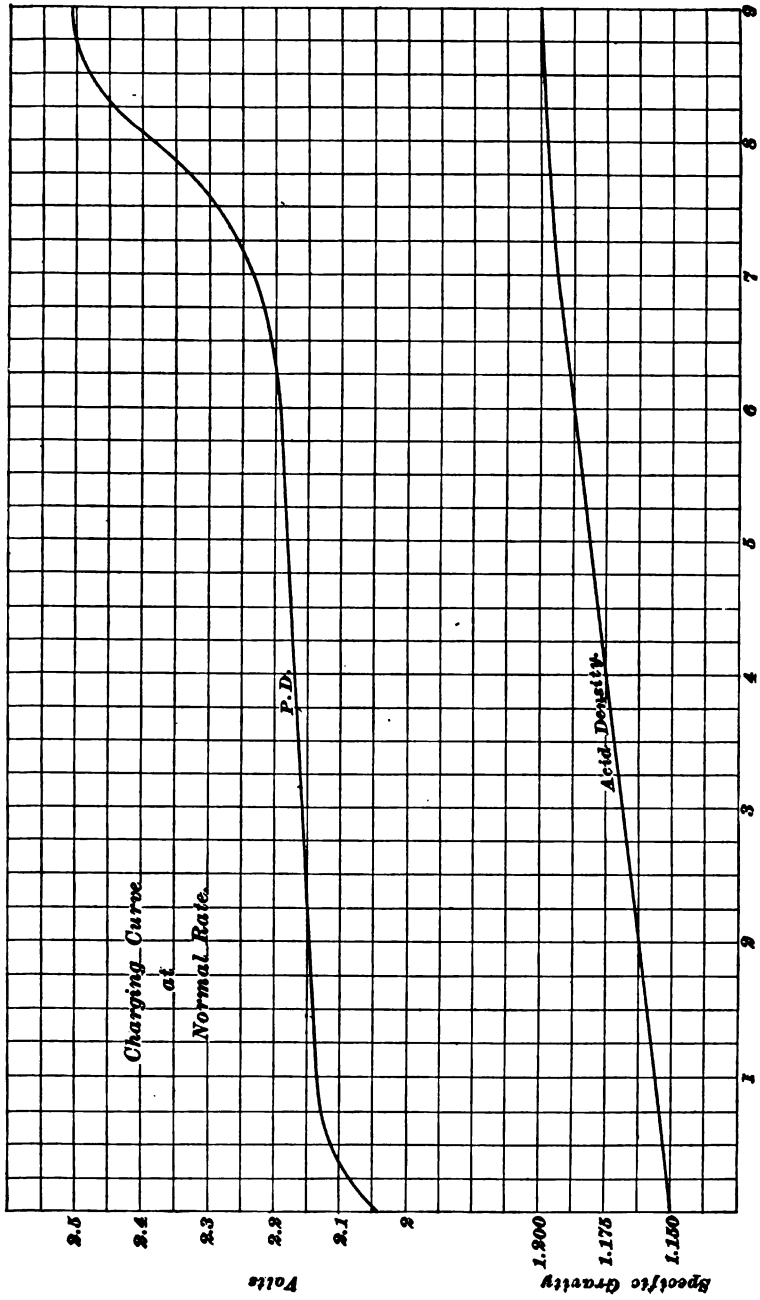

FIG. 2
Hours Charge.

circuit. The state of polarization of the slight surface layer of both plates resulting from the charge causes the E. M. F. to be high at first, but as this is quickly disposed of, the E. M. F. falls in the first 5 minutes or so to 1.98 volts; on continuing the discharge, the E. M. F. falls slowly and evenly until after 8 hours of discharging the E. M. F. falls to 1.75 volts. If the discharge is continued beyond this point, the nature of the chemical action changes somewhat, and the fall of E. M. F. becomes more rapid.

This falling off of the E. M. F. is due to the weakening of the acid solution and to the gradual changing of the spongy lead on the one plate and the peroxide on the other to sulphate. As this reduction can only go on at the points where the acid is in contact with the spongy lead or the peroxide, it is evident that the interior portions of the active material are affected much more slowly than the surface, as the acid penetrates the active material only at a comparatively slow rate. On this account, discharging at slow rates allows the active material to be more uniformly and thoroughly acted on, thus giving a greater output.

This also accounts for the fact that on discontinuing the discharge at any point the E. M. F. will soon rise to practically its original value, 2.04 volts; for unless the cell is entirely discharged there is always some unconverted active material in the interior of the plate, which serves to give the original E. M. F. when reached by the acid. If the discharge is resumed, this acid is soon exhausted, and the E. M. F. rapidly falls to the value it had when the discharge was stopped.

In the above case, the product of the amperes and the hours will give the output of the accumulator in ampere-hours; if the discharge rate had been greater, the output in ampere-hours would have been diminished, the discharge being continued until the E. M. F. falls to the same value in each case. Conversely, if the discharge rate had been lower, the output would have been increased.

For example, assume the limiting E. M. F. to be 1.75 volts. In a certain cell, with a discharge current of 30 amperes, the E. M. F. reaches its limit in 8 hours, giving an output of

240 ampere-hours. If the discharge current were 40 amperes, the limiting E. M. F. would be reached in about 5 hours, giving an output of only 200 ampere-hours, while if it were 20 amperes, the limiting E. M. F. would not be reached for about 13 hours, giving an output of 260 ampere-hours.

For the sake of uniformity, the rating of the capacity of accumulators is made on the basis of a discharge current that will cause the E. M. F. to fall to 1.75 volts in 8 hours, although most manufacturers give tables showing the comparative capacity of the various sizes of cells at other rates of discharge. The rate of charge (charging current) for accumulators of this class should be about the same as the normal (8-hour) discharge rate, although much smaller currents, continued for a proportionately longer time, may be used.

EFFICIENCY OF STORAGE CELLS

9. Although storage batteries do not store electricity, they certainly do store energy by converting the kinetic energy of the electric current into chemical potential energy, which may be realized as kinetic energy again. The efficiency of the accumulator (or of any other means of storing or transforming energy) is the output divided by the input. This quotient is always less than 1, as the accumulator is not a perfect storer of energy; that is, there are certain losses in the transformation of kinetic electrical to potential chemical energy, and vice versa, besides the loss of the energy required to force the current through the cell, that is, the loss due to the resistance of the plates and electrolyte.

10. **Ampere-Hour Efficiency.**—The input and output of an accumulator may be expressed either in ampere-hours (the quantity of electricity) or in watt-hours (the work done by the current). If secondary cells of this class be fully charged at normal rate, after a discharge to 1.75 volts, and then discharged to the same point, also at normal rate, the **ampere-hour efficiency** will be ordinarily from .87 to .93, or 87 to 93 per cent. If charged and discharged to the same point at very slow rates, this efficiency may rise to 96 or 97 per cent.

11. Watt-Hour Efficiency.—The watt-hour efficiency at normal rates of charge and discharge is lower, being from 70 to 80 per cent., depending on the construction of the cell. When batteries are used for regulating purposes to take up rapid load fluctuations, the battery is alternately charged and discharged and the chemical action is confined largely to a thin surface film on the plates. Under such circumstances the watt-hour efficiency becomes considerably higher than when the battery charges and discharges continuously, and the watt-hour efficiency may be as high as from 92 to 94 per cent.

The cause of the loss represented by the foregoing figures is, for the ampere-hour efficiency, due to the fact that the charging current must perform several chemical decompositions, the elements of which either do not recombine or, recombining, do not give up their potential energy in the form of electrical energy.

The loss shown in the watt-hour efficiency figures is due partly to the fact that the E. M. F. of charge is higher than that of discharge, partly to the E. M. F. required to perform the wasteful chemical actions referred to above, and partly to the drop in volts caused by the passage of the current against the resistance of the plates and electrolyte. This drop adds to the E. M. F. required to perform the chemical decompositions in charging, and subtracts from the E. M. F. due to the chemical recompositions, and its amount depends more on the construction of the cell than does the loss represented by the ampere-hour efficiency, as it varies with the shape and size of the plates, their distance apart, their state of charge (on account of variations of the resistance of the electrolyte as the percentage of acid varies), the rate of charge and discharge, and other conditions.

The loss due to the internal resistance in well-designed cells usually amounts to about 3 per cent. at normal rates of charge and discharge; the loss is correspondingly less at low rates and more at high rates, being proportional to the square of the current flowing.

These efficiency figures, as stated, are given for a discharge

to 1.75 volts E. M. F., the usual manufacturers' rating; if the cells are not discharged to so great an extent, both ampere-hour and watt-hour efficiencies are higher.

12. Resistance of Cells.—In a good modern cell exposing about 1,100 square inches of positive-plate surface, and listed as having 400 ampere-hours capacity, the internal ohmic resistance is about .0007 ohm when charged. Cells of greater capacity have a proportionately lower resistance.

CHARGING E. M. F.

13. The E. M. F. required to send a given charging current through a secondary cell varies with the state of charge of the cell. Fig. 2 shows the E. M. F. required to charge the same type of cell that gave the discharge E. M. F. curve, Fig. 1. The curve shows the voltage across the terminals of the cell when it is being charged at the normal rate.

This curve shows that the charging E. M. F. during the first hour rises at a comparatively rapid rate from 2.04 to 2.13 volts. During the next 5 hours the rise in voltage is slower and practically uniform, having become 2.19 volts at the end of 6 hours. For the next $2\frac{1}{2}$ hours the rise in voltage becomes more rapid and at the end of 8 hours reaches 2.38 volts, and at $8\frac{1}{2}$ hours 2.48 volts. On continuing the charging current beyond the $8\frac{1}{2}$ -hour period the E. M. F. rises a little more, and then remains practically constant at about 2.50 volts; as the only action that now takes place is the decomposition of the electrolyte, giving off gas, further charging will only result in a waste of energy.

From this curve it appears that the cell became completely charged in practically 9 hours; as the discharge curve, Fig. 1, shows that with the same number of amperes the discharge is complete (to 1.75 volts) in 8 hours, the ampere-hour efficiency of this cell is $\frac{8}{9}$, or nearly 90 per cent.

CONSTRUCTION OF LEAD-SULPHURIC ACID CELLS

14. The usual construction of lead-sulphuric acid cells is as follows: The plates and electrolyte are contained in a vessel of approximately cubical form; this vessel is of

glass, if the cells are not intended to be portable, the glass allowing the examination of the condition of the plates while the cell is in operation. If the cells are intended to be portable, the vessel is usually made of hard rubber, or of wood lined with rubber or lead. Very large accumulators for central-station use are set up in lead-lined wooden tanks.

The plates are usually approximately square, except in large cells, and from $\frac{1}{4}$ inch to $\frac{1}{2}$ inch thick, according to size. To get a large surface area without using single large plates, and to allow of one size of plate being used for cells of

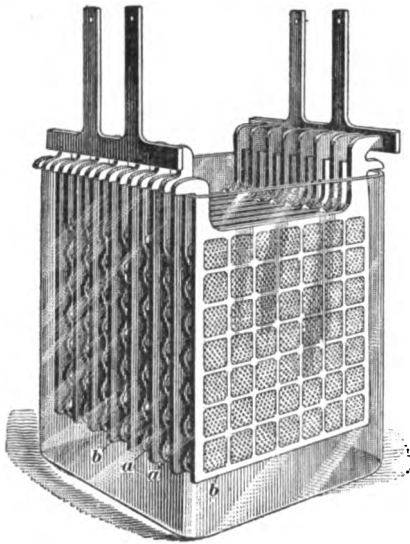

FIG. 3

various capacities, each cell contains a number of positive and negative plates arranged alternately side by side a short distance apart. The number of negative plates is always one more than the number of positive plates, so that each side of each positive plate has presented to it the surface of a negative. All like plates are connected together by a connecting strap, usually at one corner of the plate. The arrangement of a widely used type of cell that will be described more in detail later is represented in Fig. 3, where *a, a* are the positive plates and *b, b* the negative. From a corner of each plate a lug projects; those on the negative plates are joined to a connecting strap, and those on the positive plates to another; the projections on the plates rest on the edges of the jar so that the bottoms of the plates are some distance from the bottom of the jar. This is done in order to prevent any active material or foreign matter that may accumulate in the bottom of the cell, from short-circuiting

the plates. The joints are made by a process called *burning*, which consists in melting the lugs and straps together by a hydrogen flame; this flame absorbs the oxygen from the film of lead oxide with which the lead is usually covered, thus making a clean and solid joint. The connecting straps are extended beyond the limits of the cell, and serve to connect the various cells of the battery, the connection being made by a lead-covered brass bolt in the case of small cells. Large cells are nearly always joined together by burning the connections.

TYPES OF LEAD-SULPHURIC ACID CELL

15. A great many different styles of storage cell of the lead-sulphuric acid type have been brought out both in North America and in Europe. The operation of all of them is substantially as described, their distinguishing features lying in the style of grid used and the methods of preparing or applying the active material. As it is impossible to here consider all the different types, we will confine our attention to a few of those that have been used most widely in America.

16. **The Chloride Accumulator.**—The Chloride accumulator made by the Electric Storage Battery Company is a type that is extensively used. Fig. 3 shows one of these cells in which the elements are mounted in a glass jar. The large cells used for central-station work are mounted in lead-lined wooden tanks. In the Chloride cell, the positive plate is of the Planté type and is known as the Manchester type of plate. The active material is formed from metallic lead. The negative plate is made by a special process. Fig. 4 shows the construction of the positive plate. The supporting grid *A* is a casting made of a mixture of lead and antimony and the holes in which the active material is placed are tapered from each side, as shown in the sectional view. This grid is not acted on by the acid and takes no part in the chemical changes that take place in the cell. It is strong mechanically, and serves to hold the active material *B* which is in the form of round plugs about $\frac{3}{4}$ inch in diameter, made by rolling up a corrugated ribbon of pure lead, as shown at (*b*); the

strip is slightly wider than the thickness of the supporting grid so that, when pressed in place, the plug projects a little on each side. The coiled-up piece of lead expands in the forming process, so that there is no possibility of its falling out. After the lead ribbon is in place it is converted into lead peroxide, as described, thus forming the active material. This construction gives a rigid plate, and, since the active material in each hole is free to expand and contract a certain amount, buckling is avoided.

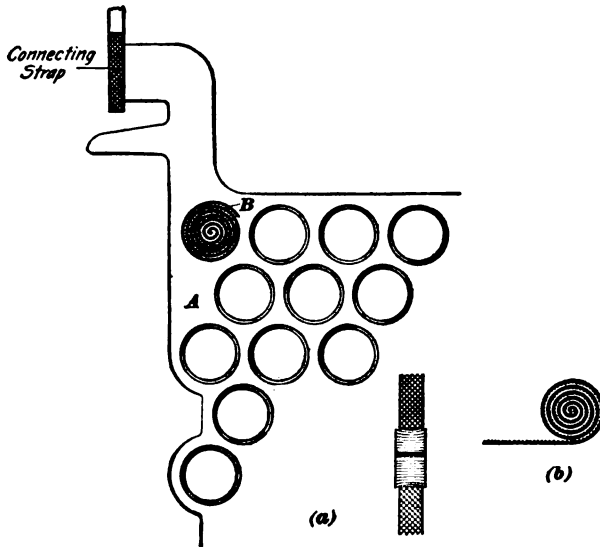

FIG. 4

The Chloride cell is so called because zinc chloride was at one time used in the construction of the negative plate. Though it is not used in the present type of plate the name is retained. Fig. 5 shows the construction of the negative plate known as the **box negative**. It is made of two parts *A, B* riveted together. Each part is made by casting lead-alloy ribs *c, c* on a sheet of perforated sheet lead; these ribs divide the sheet into a number of squares about $1\frac{1}{2}$ inches each way. When the halves are riveted together, as shown in the sectional view, a number of small boxes, or recesses,

are formed; the halves are firmly held together by cast projections, at the rib intersections, that project from one half through corresponding holes in the other half. Before the halves are riveted together, the active material, litharge or lead monoxide, is placed in the recesses. The litharge is first made into a paste and molded into pellets, which are slowly dried. Four of these pellets are placed in each compartment of the plate, and as they fit in loosely they are free to expand and contract. The first charge given the battery after it is

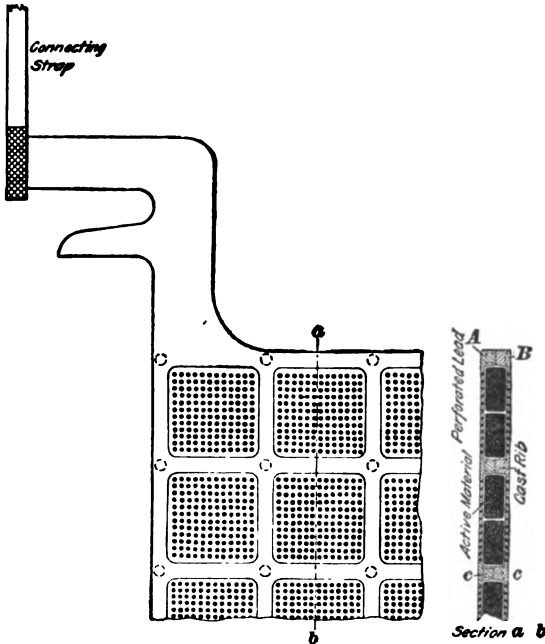

FIG. 5

installed converts the litharge into spongy lead, which constitutes the active material of the negative plate. This construction allows free access of the electrolyte to the active material and it is not possible for the latter to fall away from the plate as it did in some of the older types.

The requisite number of these prepared plates, positive and negative, are then set up together to form a cell, some

form of separator being usually placed between them. In the Chloride accumulator a number of different kinds of separators have been used. In the earlier cells the plates were separated by sheet asbestos, but the separator now generally used is a board diaphragm used in connection with wooden strips. The arrangement of these diaphragms and separators will be explained in detail in connection with the setting up of cells.

Fig. 6 shows the general arrangement of some large Chloride cells used with a central-station lighting system. Each cell here contains 87 plates $15\frac{1}{2}$ in. \times 32 in. The lugs l, l on the plates are burned on to the channel-shaped pieces c, c that form the connections between the cells; d is the edge of the lead lining of the tank; and e, e are glass rods formerly used for separating the plates. The heavy bar m forms one terminal of the battery and is connected to the last set of plates by means of the copper cross-piece n .

17. The E. M. F. and action of the Chloride accumulator are the same as that of the Faure (pasted) type or the Planté. It is claimed by the manufacturers that, from the solidity of the construction, buckling and loosening of the active material are practically impossible, so that the cells may be occasionally discharged to a low E. M. F. or at high rates without serious injury. Its output per pound of element is greater than that usually assigned to lead accumulators, being from 4 to 6 ampere-hours, according to the type of cell, per pound of plates (both positive and negative) at normal discharge rates.

18. **The Gould Storage Battery.**—The Gould battery is of the Planté type. Both positive and negative plates are made of rolled sheet lead; and the distinguishing feature of the cell is the method of increasing the active surface of the plates. Fig. 7 shows a Gould plate before it has been subjected to the forming process; the sheet lead is spun up so as to form thin ridges with grooves between them in which the active material is formed. Sheet-lead blanks are placed in steel frames and made to move back and forth between

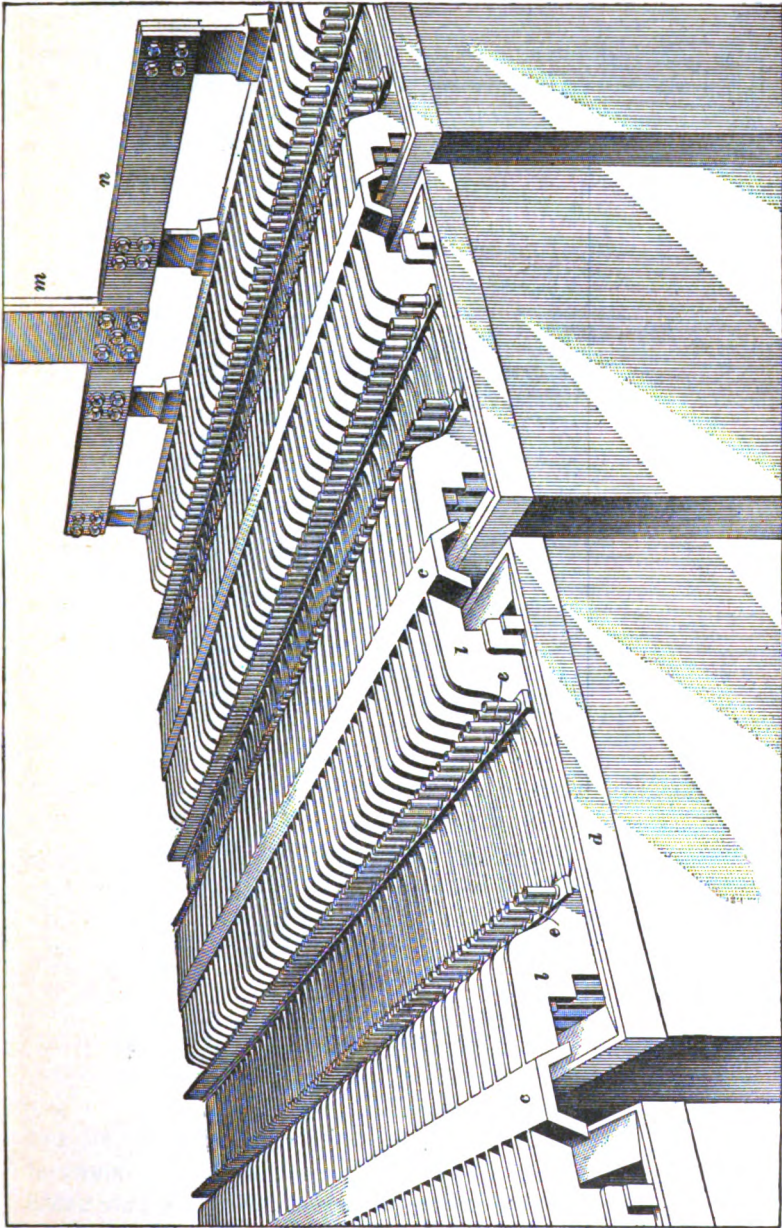

FIG. 6.

two rapidly revolving shafts on which are mounted steel disks alternating with steel washers. The thickness of the disks and washers determines the width of the grooves and the thickness of the ribs. The pressure maintained between

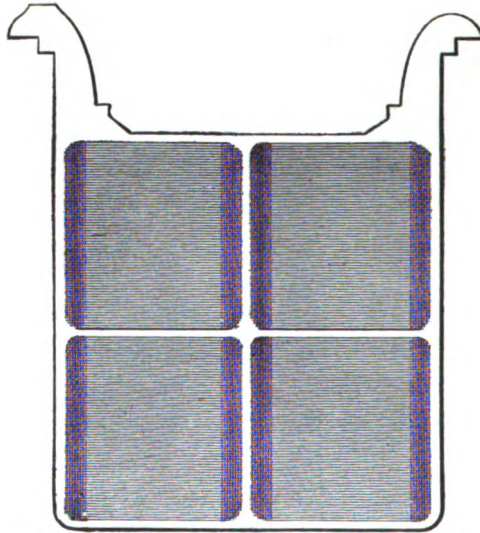

FIG. 7

the rolls and lead causes the latter to be spun up in thin ridges, as shown in Fig. 8 (a). No lead is removed from the blank; the form is merely changed so as to give a greatly increased surface. In all except the smallest plates the spun

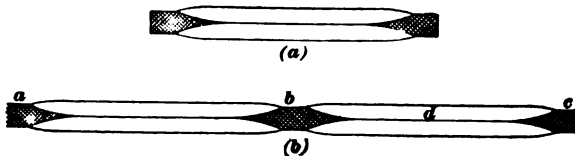

FIG. 8

portion is divided into sections, as shown in Fig. 8 (b), and the unspun parts *a*, *b*, *c* form bars of solid conducting material to which the thin webs are anchored. There is also a thin dividing line *d* in the center of the plate. The width of the

grooves is governed by the kind of work that the cell has to perform, and varies from .005 to .024 inch. By spinning up the lead, the superficial area is increased from ten to twenty times, and gives from 200 to 400 square inches per pound of lead. This permits a low current density at the contact surface between acid and plate, the density at normal discharge rate being about 1 ampere for each 250 square inches of contact

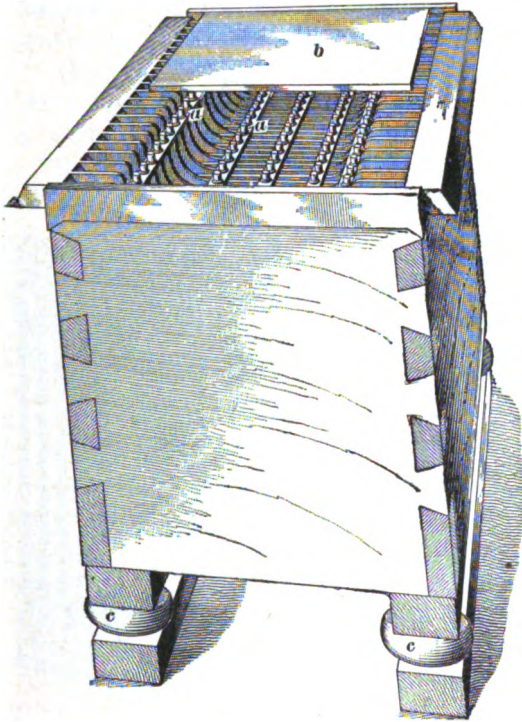
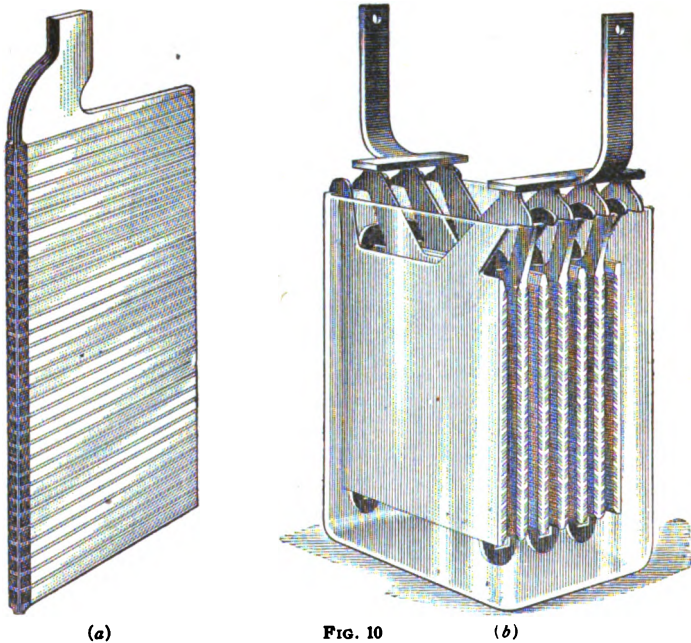

FIG. 9

surface. The thickness of the ribs varies from .005 to .040 inch on the positive plate, and is about .012 inch on the negative. The active material is formed electrochemically, and fills the narrow spaces between the ribs; these spaces are so narrow that there is little chance for the material to fall out. After the plates have been formed, the thin ribs do not appear as distinctly as shown in Fig. 7.

Fig. 9 shows a Gould cell arranged for central-station work. The elements are mounted in a lead-lined wooden tank, and are separated by glass rods *a, a*. This cell has 41 plates—20 positive and 21 negative—and has a capacity of 400 amperes for 8 hours, 560 amperes for 5 hours, or 800 amperes for 3 hours. It is covered by heavy glass, half of which *b* is shown in the figure, in order to prevent acid spray being thrown off when the battery gasses. The whole cell is supported on porcelain insulators *c, c*.



(a)

FIG. 10

(b)

19. The Willard Storage Battery.—The Willard battery is of the Planté type, the active material being held in narrow grooves cut in a rolled lead plate. Fig. 10 (a) shows a Willard plate; its grooves are inclined upwards in order to hold the active material more effectively in place. Fig. 10 (b) shows a complete cell of the Willard type. The action of the cell is the same as the Planté cell, so that further comment is unnecessary.

20. The foregoing will give a fair idea as to the construction of storage batteries. The list might be prolonged almost indefinitely, for many makes that are perfectly satisfactory in operation are not mentioned here. As before stated, nearly all of these cells operate on the same principle, the only difference being in the method of making the plates. A vast amount of time and money have been spent in the improvement of storage-battery elements and in perfecting the manufacturing details. The above, however, will be sufficient to show the general construction of such batteries as are made at the present time. It seems as if the Planté type were used most largely in America, especially for stationary work; in Europe, the Faure, or pasted type, is more common. The Faure type is used by some makers for automobile batteries, because, in general, the pasted cell gives a greater output per pound of weight than the Planté type. On the other hand, it has been found that pasted plates are more liable to disintegration, so that where weight is not an objection, the Planté type is favored.

AUTOMOBILE BATTERIES

21. In batteries intended for automobiles, electric launches, or similar class of service, every effort must be made to secure a large output with a minimum weight. The cells must at the same time have sufficient mechanical strength to withstand the jarring to which they are subjected. The grids used in these cells are of lighter construction than those used for stationary batteries and carry a larger proportion of active material.

Fig. 11 shows the general construction of the plates used in the "Exide" battery made for automobile use by the Electric Storage Battery Company. The foundation for the positive plate is a light but stiff cast grid made of a mixture of lead and antimony; the general form of the grid is indicated in Fig. 11 (*a*). These grids are pasted with red lead, which is afterwards converted into lead peroxide; the staggered arrangement of the cross-ribs, shown in the

sectional view, insures a firm locking of the active material. The negative plate, shown in (b), is of lighter construction than the positive. It is made up of a sheet of lead *a* with a stiff frame *b* cast around it. This sheet has a number of holes punched in it, half of these *c* being punched through from one side and the other half *d* from the other side. The metal is not removed but is torn or burred up as indicated. The torn projections are pressed down flush with the edge of the cast frame and the plate is then pasted on both sides with litharge, which is afterwards converted into spongy lead. The torn projections, when pressed down,

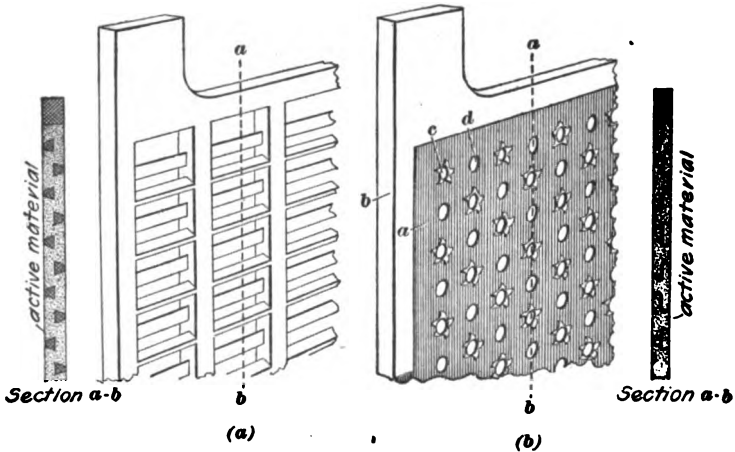

FIG. 11

form a series of hooks that lock the material securely to the plate. This cell is, therefore, of the Faure type, both plates being pasted.

The Porter automobile battery is also of the pasted type, while the Willard and Gould automobile batteries are of the Planté type, and have plates made in practically the same way as those used for stationary batteries. The elements of automobile batteries are usually mounted in hard-rubber cells in order to avoid breakage, and are separated from each other by perforated hard-rubber diaphragms. The output of automobile batteries is usually from 5 to 6.5 ampere-hours

per pound total weight when discharged at a 4-hour rate. However, it is difficult to compare such batteries simply by their capacity per pound weight. The ability to withstand rough usage and constant jarring is of more importance than mere lightness for this class of service.

BIMETALLIC ACCUMULATORS

22. Owing to the great weight of lead accumulators many attempts have been made to produce a storage cell that will be equal or superior to the lead cell and a great deal lighter. A vast amount of experimenting has been done along this line, but so far the lead cell has proved the most economical in the long run. In bimetallic cells, the elements consist of two metals, the electrolyte being a salt of one of the metals or a hydroxide. Though many combinations of metals have been proposed for these cells, the most satisfactory are the *zinc-lead*, *copper-lead*, *copper-zinc*, and, later, the *nickel-iron cell* of Edison. The principal trouble with bimetallic accumulators has been due to local action, which soon causes deterioration of the plates; also, many of these cells will not work well at ordinary temperatures, making it necessary to keep the electrolyte hot in order to secure satisfactory action. A few of these cells are described in order to show what has been done in this line, though few of them have been used to any great extent.

23. Zinc-Lead Cell.—The zinc-lead cell usually consists of plates of zinc and lead in a solution of zinc sulphate. On sending a charging current through this cell (the zinc being the negative plate) the zinc sulphate is decomposed, depositing zinc on the zinc plate and forming free sulphuric acid with the hydrogen of the water, which is also decomposed, its oxygen uniting with the lead plate, forming peroxide of lead. On open circuit and while charging, the free sulphuric acid in the solution slowly attacks the deposited zinc, reforming zinc sulphate, so that the efficiency of this form of cell is low; it will not retain a charge more than a few days. The E. M. F. is high, being about 2.35 volts to 2.5 volts.

By substituting copper sulphate for zinc sulphate, and copper plates for the zinc or other negative plates in this type of cell, the acid formed during charge cannot attack the copper, so that this loss is obviated; the E. M. F., however, is but 1.25 volts under these circumstances, so the watt output is materially reduced. Fig. 12 shows a zinc-lead cell

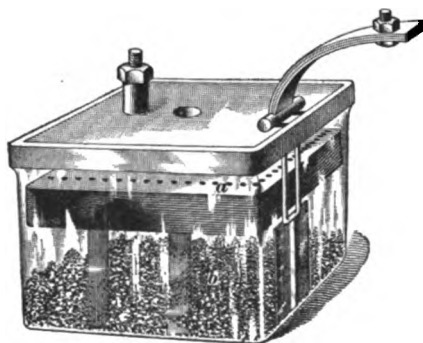

FIG. 12

made by the United States Battery Company. The positive element *a* is perforated lead, and the negative element *b* granulated zinc amalgam. The amalgam is placed in the bottom of the cell and the lead plate arranged horizontally above it in order to avoid short-circuiting by any particles that may drop off the

positive plate; by thoroughly amalgamating the zinc it is claimed that local action is avoided. This type of cell gives an average E. M. F. about 15 per cent. higher than that of the lead-sulphuric acid cell, and is somewhat lighter. The electrolyte is a solution of zinc sulphate.

Owing to the variations in the composition of the electrolyte, the internal resistance of these cells is variable, being lowest when charged and increasing during discharge as the sulphuric acid forms sulphate of copper or zinc.

24. Copper-Zinc Cells.—The copper-zinc accumulators were at one time in commercial use to a limited extent, the best known being the Phillips-Entz accumulator, made by the Waddell-Entz Electric Company. This accumulator employed the same active materials as the Lalande-Chaperon or Edison-Lalande primary cell, modified in mechanical construction to adapt them for accumulator use. The positive plate was made of porous copper on a solid foundation. The negative plate was a thin sheet of steel, and the plates were

mounted in a jar made of steel. The electrolyte was a solution of potassium zincate and potassium hydrate (caustic potash).

The reactions in a cell of this kind are complicated, but when the cell is charged zinc is deposited, from the potassium zincate, on the steel plates and the porous copper is oxidized. On discharge, the action is the same as in the Edison-Lalande primary cells; that is, the zinc is dissolved, the potassium zincate is reformed, and the copper oxide reduced to metallic (spongy) copper.

The efficiency of this type of accumulator is about the same as that of the lead accumulator, while its output is very much greater, weight for weight, the ampere-hour output being about five times that of a lead cell. The E. M. F. is much lower than that of the lead accumulator, averaging .75 volt during discharge, so that the comparison on a basis of watt-hour output is not so favorable; still, the copper-zinc accumulator will show an output of about 15 watt-hours per pound of plates, while the lead accumulators seldom exceed from 7 to 10 watt-hours per pound of plates, the latter figure being seldom reached at normal rates of discharge.

The efficiency and internal resistance of the copper-zinc accumulator vary quite largely with the temperature, on account of the considerable variations in the density of the electrolyte; on this account the cells are ordinarily charged and discharged at a temperature of about 54° C. (130° F.), at which point the resistance is about the same as in a similar lead accumulator.

These cells are not much affected by the rate of discharge, there being no such occurrence as sulphating or buckling; but on account of the difficulty of depositing the zinc in a solid form, the charging must be done at a low rate, and the action of the cells is improved by intermittent charging. The E. M. F. required to charge one of these cells varies from .9 volt at the start to 1.05 volts at the finish. On account of these features the copper-zinc accumulator can be used only in installations where it is charged and discharged daily, thus preventing local action, and when it can have the necessary appliances, care, and attention in charging, to

insure proper charging rate, temperature, etc.; so, in spite of its large output per unit of weight, it can hardly come into general use. Another serious objection to this type of cell is its low voltage; for a system operating at a given voltage nearly three times as many cells would be required as would be sufficient if lead-sulphuric acid cells were used. This objection, of course, applies to any cell that gives a low voltage. Like all cells using caustic potash or other hydroxide for the electrolyte, the air must be kept from the electrolyte to prevent the absorption of CO_2 (carbonic-acid gas) from the atmosphere, and the formation thereby of carbonates. The necessity of excluding the air by means of a layer of oil or by other means constitutes quite a serious drawback in the practical operation of these cells. Although this type of accumulator has many good points, it has never been able to displace the lead-sulphuric acid cell in commercial work on account of the above-mentioned drawbacks and has, in fact, never been used to any great extent.

25. Edison Nickel-Iron Cell.—A bimetallic cell has been developed by Edison that, it is claimed, is lighter and more durable than the lead type and does not have the disadvantages of other bimetallic cells. The cell has been developed with particular reference to the requirements of electric vehicle service, but at present it has not been used to a sufficient extent commercially to indicate whether or not it will be able to displace the lead type of cell. The active material of the positive plate is peroxide of nickel and that of the negative plate, finely divided iron. Both plates are constructed as indicated in Fig. 13. The active material is held in flat stamped steel boxes, or pockets, made by shallow halves that fit tightly together. These boxes are perforated with narrow slits that allow the electrolyte to come in contact with the material contained within. The plate proper is made of steel, nickel plated, and is punched with twenty-four rectangular openings, as shown at *a*, Fig. 13. The boxes *b* are held in the openings as shown in the complete plate *c*. The plates are quite thin and the number required for a cell

are assembled with rubber separators between adjacent plates. The electrolyte is a 20-per-cent. solution of caustic potash (KOH), and as the amount required for the cell is small, the plates can be placed close together. The nest of plates is placed in a sheet-steel containing vessel. The regular automobile cell measures 13 in. \times 5.1 in. \times 3.5 in. and weighs

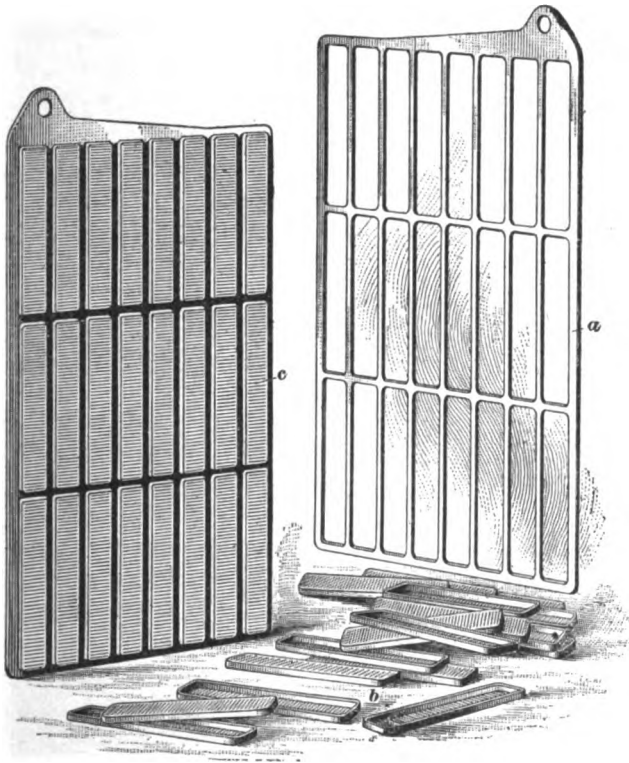

FIG. 18

17.8 pounds. The E. M. F. of the cell is 1.33 volts, and the output varies from 173 to 142 ampere-hours on discharges ranging from 30 amperes to 200 amperes. This corresponds to about 13 watt-hours per pound at the lower discharge rate. Like all other cells using a hydroxide for the electrolyte, the air must be excluded to prevent the formation of carbonates.

INSTALLATION AND CARE OF STORAGE CELLS

SETTING UP CELLS

26. The following instructions regarding the installation and care of storage cells are an abstract of those furnished by the Electric Storage Battery Company, and refer to the Chloride cell as used for stationary work. However, the instructions may be taken as applying for the most part to any of the ordinary types of lead-sulphuric acid cell. Manufacturers send out instructions regarding their cells and give any special recommendations that may relate to their particular type. For the most part these instructions apply also to automobile or other portable cells.

27. Location.—Storage cells should be located in a well-ventilated room of moderate temperature, say from 50° to 75° F. The floor should be of cement with drainage facilities, and the room should be light enough to allow easy inspection of the cells. Generally, the battery room is located somewhere near the dynamo room in case the battery is used in connection with a central station, as a near-by location cuts down the length of conductors between the battery and station, and also allows the outfit to be watched to better advantage.

28. Method of Supporting Cells.—The cells are usually mounted on racks made of heavy wooden framework securely braced. It must be remembered that these cells are heavy, and sagging of the framework is not allowable, as it may result in broken cells. If there is plenty of space available, the cells should be in a single tier, in which case all the framework that is necessary is a set of stringers properly

fastened together. Fig. 14 shows a framework recommended by the Electric Storage Battery Company for those places where it is necessary to arrange the cells in two tiers. Each cell is placed in a shallow wooden tray *a* partly filled with sand, and each tray is set on four single petticoat glass insulators. The sand distributes the strains on the glass jar and avoids breakage. Where wooden tanks are used, these trays are not necessary. Fig. 15 shows the shape of the glass insulators. Any current leakage from the cells has to take place over the petticoat *a*, taking the long path indicated by the dotted line.

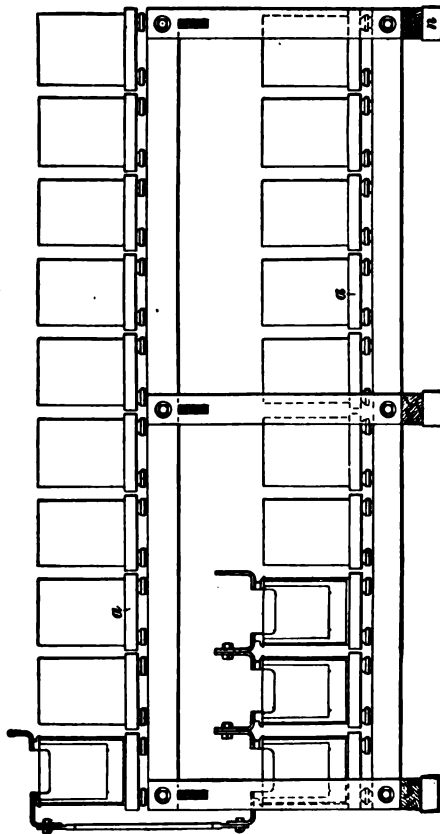
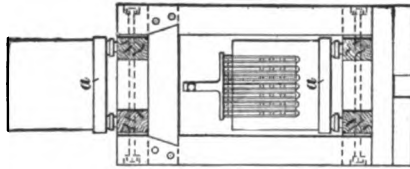

29. Placing Elements in Jar.—The elements and jars are shipped separately, so that the battery usually has to be assembled at the place where it is to be used. The plates should be unpacked carefully, because if handled roughly they may be bent or

otherwise damaged. The positive and negative plates are, except in the case of very large cells, connected together in groups; the positive group is easily distinguished by

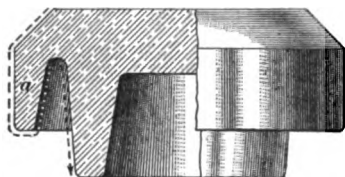

FIG. 15

its dark-brown, color. Fig. 16 shows the various parts of a Chloride accumulator after they have been unpacked and separated; *a* is the negative group, *b* the positive, *c* the jar, *d* the wood diaphragms for placing between the plates, *e* the slotted wood separators for slipping over the diaphragms and holding them up in place, and *f* one of the diaphragms with its pair of slotted wood separators in place. The block *g* is used in mounting and arranging the elements and the lead-covered brass screws *h* are for bolting the terminals of the cell

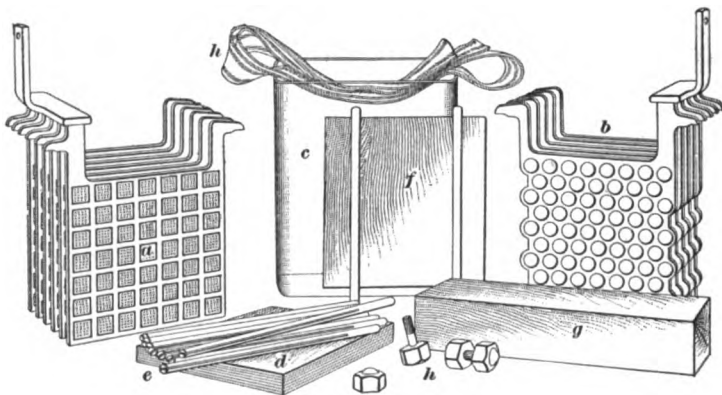

FIG. 16

together. Before placing the board diaphragms between the plates, the grain of the wood always being parallel to the edges or sides of the plates, two of the slotted wood separators must be slipped over each board and spaced $1\frac{1}{4}$ inches from the edge. The elements are then slipped together, as shown in Fig. 17 (*a*), and the diaphragms adjusted in place. The whole group of elements is then lifted, by means of a broad piece of webbing, on to the block mentioned above.

This allows the diaphragms to be pushed down into place, and the elements further adjusted, as shown in Fig. 17 (b). The elements are then lifted by means of the webbing, as shown in (c), and gently lowered into the jar.

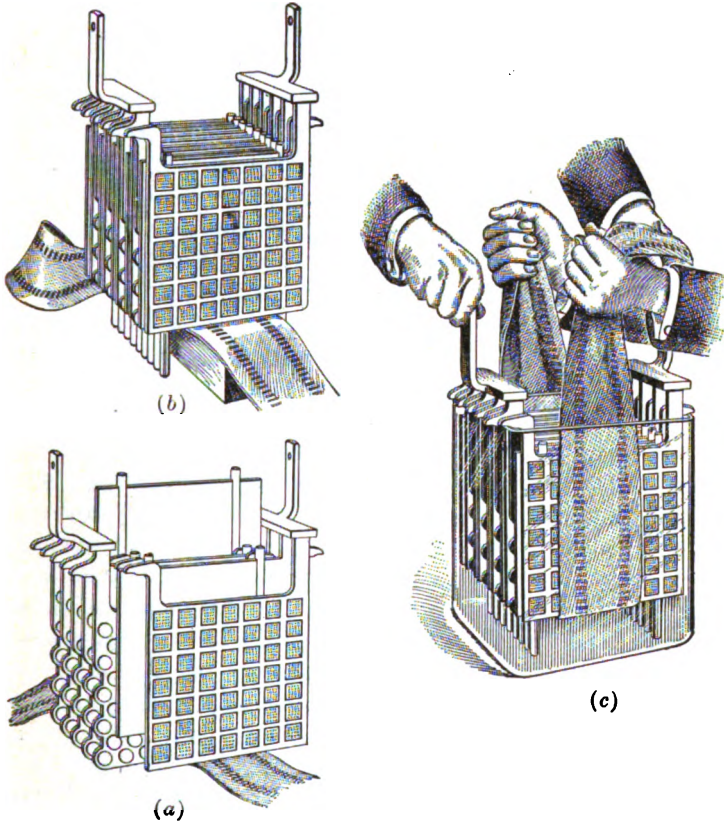

FIG. 17

Though this method of placing plates refers particularly to the Chloride accumulator it can be used with almost any of the ordinary types of storage cell. After the cells have been assembled the lead terminals should be well scraped at the point where they are bolted together in order to secure good electrical contact.

THE ELECTROLYTE

30. Mixing the Electrolyte.—The electrolyte used in storage batteries differs slightly with different makes of cell; it is always dilute sulphuric acid, but the specific gravity of the solution recommended by different manufacturers varies somewhat. The electrolyte should have a specific gravity of 1.20 to 1.24, as indicated by the hydrometer when the cells are charged. The specific gravity is taken at normal temperature of about 60° F. Most manufacturers of storage cells furnish electrolyte ready mixed, but it can be prepared by diluting suitable commercial sulphuric acid (oil of vitriol) with pure water. In selecting sulphuric acid none but the sulphur or brimstone acid should be used; acid made from pyrites is liable to contain impurities, such as iron or arsenic. It is absolutely essential that the acid and water be free from impurities, such as iron, arsenic, and nitric or hydrochloric acid. When diluting, the acid must be poured slowly and with great caution into the water; do not pour water into the acid because the sudden evolution of heat and the consequent boiling action may throw acid into the operator's face. The proportions of acid (of 1.84 specific gravity or 66° Beaume) and water are 1 part of acid to 5 of water (by volume). The vessel used for the mixing must be a lead-lined tank, or one of wood that has not been used for other purposes; a wooden wash tub or spirits barrel answers very well. The electrolyte when placed in the cell should come $\frac{1}{2}$ inch above the top of the plates. Before putting the electrolyte in the cells, the circuits connecting the battery with the charging source should be complete. The positive pole of the charging source must be connected to the positive pole of the battery. Also, care must be taken in placing the cells to see that positive and negative poles of adjacent cells are connected together. It is an easy matter to connect one or more cells backwards if the terminals are not closely inspected when the cells are being connected. After the electrolyte has been placed in the jars, the battery should be charged at once, if possible; in any event, the cells

should never be allowed to stand more than 2 hours after the electrolyte has been placed in them, before they are charged. The value at which the density of the electrolyte should be maintained is usually specified by the manufacturer, but it is generally in the neighborhood of 1.2; automobile batteries are usually supplied with an electrolyte having a slightly higher density. During regular operation of the battery, the density of the electrolyte changes; as the battery is charged the specific gravity rises until it reaches a maximum not necessarily fixed; when the battery is discharged the specific gravity lowers. The acid does not evaporate so that any evaporation of the electrolyte should be made up by the addition of water; however, a certain small amount of acid may be thrown off in the form of fine spray or be absorbed by sediment in the bottom of the cell. The addition of some acid every 1 or 2 years is, therefore, necessary in order to maintain the specific gravity at the standard density. The most convenient way of adding the acid is to prepare a mixture of acid and water having a density of about 1.4, and add as much of this as may be necessary. As mentioned above, it is particularly important that the acid be free from impurities; if there is any doubt on this score a sample should be analyzed. As the proper performance of a battery depends very much on the condition of the electrolyte, hydrometer readings should be taken at regular weekly intervals.

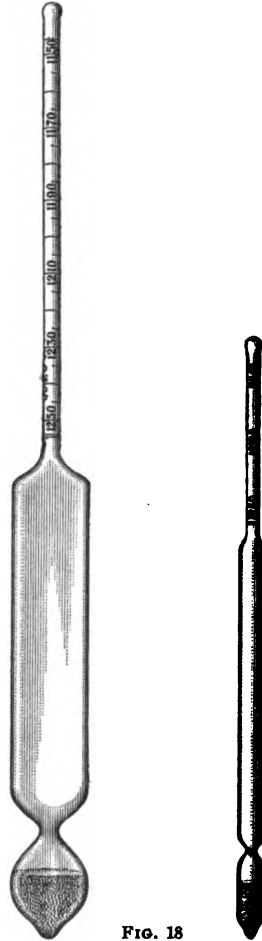

FIG. 18

31. Hydrometers.—In order to facilitate the determination of the density of the electrolyte, special forms of **hydrometers** are used in connection with storage-battery work. Fig. 18 shows two styles of battery hydrometer suitable for use in stationary cells where there is plenty of

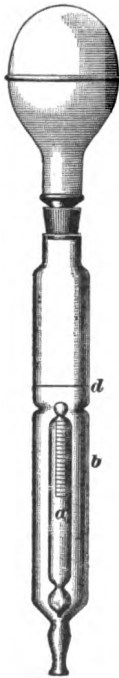

FIG. 19

room around the plates for placing the hydrometer in the liquid. The larger size is preferable, as the density can be determined more easily and more closely than with the smaller, which is only used in cells where there is not sufficient room for the larger size. Each of the hydrometers has a small bulb at the lower end and that contains a quantity of fine shot. Some hydrometers have mercury in the bulb, but shot is preferable because, if the bulb becomes broken, no mercury as an impurity is introduced into the electrolyte. Moreover, if mercury gets into a lead-lined tank it attacks the lead lining or rather amalgamates with it and a leak is likely to result. The air in the large bulb floats the hydrometer, which, when placed in the electrolyte, stands upright, and the reading on the stem is taken at the point where it emerges from the liquid.

Fig. 19 shows a style of hydrometer more particularly adapted to cells where it would be difficult to place a hydrometer directly in the liquid, as, for example, in automobile batteries. The hydrometer *a* is placed within the glass tube *b*, and by means of the rubber bulb sufficient electrolyte can be drawn up to float the hydrometer. Enough liquid is drawn up to fill the tube up to the mark *d* ground on the glass, and the reading is taken at the point where the floating tube *a* emerges from the liquid.

CHARGING

32. After the battery has been set up, it should be given a full charge at the normal rate. The rate of charging is usually the same as the 8-hour rate of discharge as specified by the manufacturers. It is desirable that the charging be continued uninterruptedly, though this is not absolutely essential. The charge should be continued until it is certain that the charging is complete according to the signs given below. It should not be repeatedly carried beyond the full-charge point, because it entails an unnecessary waste of energy, causes a rapid accumulation of sediment, wastes acid through spraying, and what is still worse, shortens the life of the plates. It is advisable to overcharge the batteries slightly, about once a week, in order that the prolonged gassing may thoroughly stir up the electrolyte, and also in order to correct any inequality in the voltage of the cells that may have developed. At the end of the first charge it is advisable to discharge the battery about one-half, and then immediately recharge it. Repeat this operation two or three times, and the battery will then be in condition for regular use.

33. Indications of a Complete Charge.—A complete charge should exceed the previous discharge, in ampere-hours, from 12 to 15 per cent. The principal indications of a complete charge are: (1) The voltage and specific gravity reach a maximum value, which value is not necessarily fixed; for example, the voltage at the end of a charge may be from 2.4 to 2.7. (2) The amount of gas given off at the plates also increases when the cells are fully charged. (3) The positive plates become a dark brown, and the negatives a light gray. (4) With all the cells of the battery in normal condition, with pure electrolyte and no material lodged between the plates or sediment touching them at the bottom, the maximum voltage and specific gravity are reached when, with the charging current constant at the normal rate, there is no further increase in either during a period from $\frac{1}{4}$ to $\frac{1}{2}$ hour; for example, if the charge has been,

carried on for 5 hours with a gradual rise in the voltage and specific gravity during that time and with an additional $\frac{1}{2}$ hour of charging, there should be no further rise in either, then the charge is complete.

34. Voltage at End of Charge.—The voltage at the end of a charge is not always the same. It depends on the age of the plates and the temperature of the electrolyte; hence, both of these must be taken into consideration when determining the completion of a charge. When the battery is first installed, the voltage at the end of the charge will be 2.5 volts per cell or higher, at normal rate of charge and at normal temperature. As the age of the battery increases, the point at which it will be fully charged is gradually lowered and may drop as low as 2.4 volts at normal rate and temperature. With charging rates lower than the normal, the voltage at the end of the charge will be approximately .05 volt less for each 25 per cent. decrease in the rate. For example, if the final voltage were 2.50 at the normal rate, say, of 1,000 amperes, it would be 2.45 at 750 amperes, and 2.40 at 500 amperes. If the temperature is increased above normal, the final charging voltage is noticeably lowered, and vice versa, irrespective of the age of the plates. It is understood in the preceding that all voltage readings are taken with the current flowing; readings taken with the battery on open circuit are of little value and are frequently misleading. After the completion of a charge and when the current is off, the voltage per cell will drop to about 2.15 volts and then to 2 volts, or slightly less, when the discharge is started. If the discharge is not begun at once, the pressure will quite rapidly drop to 2.05 volts and remain there while the battery is on open circuit. Cells should never be charged at the maximum rate except in cases of emergency; if charged at the maximum rate, the final voltage per cell will be about .05 volt higher than if charged at normal rate.

DISCHARGING

35. One of the most valuable features of a storage battery is its ability to deliver large currents for short intervals. While such is the case, repeated heavy overdischarges are almost sure to injure the cells if maintained for a considerable time. Batteries should, therefore, be discharged at about the normal rate as nearly as possible. The amount that a battery has discharged can be determined in the same manner as the amount of charge, i. e., from voltage and specific-gravity readings. During the greater part of a complete discharge the drop in voltage is slight and very gradual until near the end, when the falling off becomes much more marked. The limit of discharge is reached when the voltage has fallen to 1.7 volts per cell; a battery should never be discharged below this point, and in ordinary service it is advisable to stop the discharge considerably above it. Cells, as a rule, are not discharged below 1.75 volts, and 1.7 represents the limit that should not be passed under any circumstances. If a reserve is to be kept in the battery for use in case of emergency, the discharge must be stopped at a correspondingly higher voltage. The fall in density of the electrolyte is in direct proportion to the ampere-hours taken out, and is, therefore, a reliable guide as to the amount of discharge. In this respect it differs from the drop in voltage, which varies irregularly for different rates of discharge; consequently, the specific gravity of the electrolyte is the more satisfactory guide. The actual amount of variation in the strength of the electrolyte between full charge and full discharge depends on the quantity of solution compared with the bulk of the plates in the cell. If a cell contains the full number of plates, the change in specific gravity is about 35 points. With fewer plates in the same size containing vessel, the range will be lessened. Also, at higher rates of discharge than normal the drop in specific gravity will be less because of the smaller number of ampere-hours discharged. As the discharging progresses, the positive plates become somewhat lighter and

the negatives darker, so that the color of the plates is a rough indication of the amount of discharge.

After a battery has been completely discharged it should be immediately charged again. It should be allowed to stand but a very short interval, if at all, before recharging.

MISCELLANEOUS POINTS

36. Inspection of Cells.—In order to secure satisfactory operation of a battery each of the cells should be inspected at regular intervals. The voltage of individual cells may become low, the electrolyte may not be of the proper specific gravity, or foreign substances may become lodged between the plates or in the bottom of the cell, and regular inspection is necessary to locate any such defects that may develop. Such readings as are taken from the cells should be recorded in such a way that consecutive readings can be easily compared; if a cell is acting irregularly, the fact will then be at once apparent. Each cell should be thoroughly inspected at least once a month. This can be easily done by examining a certain number of cells each day in case the battery is too large to examine all the cells in a single day.

For the inspection of individual cells, a portable lamp should be used so that any tendency for an accumulation or lodgment of material between the plates can be at once noticed. If the elements are in glass jars, an ordinary lamp with extension cord will be found most convenient; by holding the lamp behind the jar and looking through between the plates, the condition of the cell can at once be seen. If wooden tanks are used, a lamp suitable for immersion to the bottom of the electrolyte will be needed. When examining a cell great care should be taken to look between all the plates, and any accumulation of material should be removed at once. If the accumulation is from the plates themselves, it may be pushed down to the bottom of the containing vessel by means of a stick of hard rubber or wood; if it is any foreign substance it should be removed from the cell. A

metal rod should never be used for removing obstructions in a storage cell; it is sure to cause short circuits and do damage.

In addition to the examination of the cells with the lamp, an examination should be made near the end of each charge to see if all the cells are gassing equally, and readings of voltage and specific gravity should be taken at the end of a prolonged charge, while the current is still flowing. If any of the cells show readings lower than normal and do not gas freely at the end of the charge, they should be examined at once with a cell lamp to determine the cause of the falling off. Very likely it is due to short-circuiting between the plates, caused either by a lodgment of material in the intervening space or else by an accumulation of mud in the bottom of the cell.

37. It is advisable, in storage-battery installations, to use recording instruments to show the variations in voltage or current. There are many types of these instruments, but in most of them a paper chart is moved at a uniform rate by means of clockwork and on it the pointer of the ammeter or voltmeter draws a line showing the variations in voltage or current. Sometimes the record is made on a straight strip of paper but more often it is made on a circular chart, as in the Bristol recording instruments. Records of this kind are valuable because they show just what the battery has been doing; and if it is not performing satisfactorily, steps can at once be taken to remedy the defect. The most generally useful instrument is a recording voltmeter. Recording wattmeters are sometimes used where the expense is warranted. A special type of Thomson recording wattmeter is made for this purpose. The instrument is provided with two recording dials, one of which is moved by the meter mechanism when the battery is charging and the other when it is discharging. The amount of charge given to the battery during any given period can thus be compared with the amount of discharge and the watt-hour efficiency thereby determined.

38. Getting Low Cells Into Normal Condition.—A cell that has become low will generally require more than the usual amount of charging to get it into condition again after the cause of the trouble has been removed. The simplest way of doing this is to overcharge the whole battery until the low cells are brought up to the proper point, but care must be taken not to carry this to excess. Another method is to cut the low cells out of circuit over one or two discharges, and then cut them in on the charges. A third method is to give the faulty cells an individual charge while the other cells are on the discharge; the most convenient way of doing this is by means of a small motor-driven dynamo. Before putting a cell that has been defective into service again, care should be taken to see that all the signs of a full charge are present.

39. Sediment in Cells.—After cells have been in service for some time there is an accumulation of sediment in the bottom caused by small particles dropping from the plates. This sediment should never be allowed to touch the bottom of the plates and thus short-circuit them; it should be carefully watched, especially under the middle plates, as it accumulates there more rapidly than under the side plates. If there is any free space at the end of the cells, the sediment can be raked from under the plates and then scooped up; the device used for this purpose must have no metal in its make-up. If this method is impracticable, the electrolyte should be drawn off into clean containing vessels after the battery has been fully charged. The cells should then be thoroughly flushed with water, from the local water supply, in such a way as to stir up the sediment thoroughly and get it out of the cells. All the water should then be drawn off; if the cells are too low for siphoning, a rotary pump with bronze parts should be used. After the cells have been thoroughly cleaned, the electrolyte should be at once replaced before the plates have had a chance to become dry, and thus necessitate the long charge required by dry plates. In addition to the electrolyte withdrawn, new electrolyte must be added to make

good that displaced by the sediment; this should be of 1.3 or 1.4 specific gravity to counteract the effect of the water absorbed by the plates during the washing process, and also to reduce the bulk of the new supply. The electrolyte must be kept free from impurities; if it is known that any impurity, especially any of the metals other than lead, or other acid has got into a cell in any except very minute quantities, the electrolyte should be renewed immediately.

40. Battery Used Occasionally.—When the battery is used but occasionally, or if the discharge is at a very low rate, the battery should be given a weekly freshening charge.

41. Putting Battery Out of Commission.—If the use of the battery is to be discontinued for a considerable time, say 6 months or more, it is usually best to take it entirely out of service by withdrawing the electrolyte. This should be done as follows: After giving a complete charge, siphon off the electrolyte into convenient receptacles, preferably carboys that have previously been cleaned and have never been used for other kinds of acid. As each cell is emptied, immediately refill it with water. After water has been placed in all the cells, begin discharging and continue until the voltage falls to or below 1 volt per cell at normal load. Then draw off the water; the battery may then stand without further attention until it is needed again.

42. Putting Battery Into Commission.—To put a battery into commission proceed in the same manner as when giving the battery its first charge. First make sure that the polarity of the charging source has not been altered during the interval that the battery has been out of use, and that the positive pole of the battery connects to the positive pole of the charging source. Put in the electrolyte and begin charging at once at the normal rate, and continue until the charge is complete; from 25 to 30 hours at this rate will be required.

43. Cadmium Test.—It may sometimes happen that the plates of a cell are unevenly acted on; that is, the material on one plate may be wholly changed during the charge,

while that on the other plate may be only partially changed. When the cell is discharged, it is evident that under these conditions the voltage will fall off sooner than it should because the capacity of the cell will be limited by the capacity of the partially converted plate. In order to determine the existence of such a condition it is necessary to test each of the plates separately because the voltage of the cell as a whole will not indicate the relative condition of the plates. In order to make the test, a third electrode, consisting of a piece of cadmium, is used; a piece of zinc could be used if it were chemically pure. The cadmium test piece is dipped into the electrolyte and the voltage between it and the plates of the battery measured by means of a low-reading voltmeter. Care should be taken to see that the cadmium is not allowed to touch either plate. If both plates are fully charged, and the normal charging current flowing through the battery, the voltage between the positive and negative plates will be about 2.45 to 2.5 volts. The voltage between the cadmium and the negative plate will be about .18 or .19 and between the cadmium and positive plate about 2.3 volts, the voltage of the cell being the sum of the two readings. When the battery has been discharged until the voltage per cell is reduced to 1.8 or 1.75 volts, the voltage between the cadmium test piece and the positive plate will be about 2.05 and between the cadmium and negative about .25, the voltage of the cell being the difference of the two readings. When the cell is fully discharged, the cadmium is positive to both plates; when it is fully charged, the cadmium is positive with regard to the positive plate and negative with regard to the negative plate. All the readings given above and the statements regarding the polarity of the cadmium with respect to the plates assume that the normal charging or discharging current is flowing when the readings are taken.

44. Sulphating.—Unless a battery is properly looked after, **sulphating** is liable to set in, and if allowed to go too far may cause a great deal of trouble. As already explained, lead sulphate, $PbSO_4$, is formed during each discharge of a

cell. This sulphate does no harm; in fact, it is essential to the operation of the cell. However, under certain conditions a white insoluble sulphate, Pb_2SO_4 , may be formed, and it is this that is credited with the action known as *sulphating*. When a cell is sulphated, the plates, more particularly the positive, become covered in spots with this white insoluble sulphate, which is difficult to remove. As the sulphate usually accumulates in patches and as it prevents, to a large extent, chemical action on the active material underneath it, the capacity of the cell is reduced and the uneven action is liable to lead to buckling unless the mechanical structure of the plate is such that buckling is practically impossible. The most frequent causes of sulphating are overdischarging, wrong specific gravity of electrolyte, and allowing the battery to stand for a considerable length of time in a discharged condition; if a battery is looked after, as it should be, there will be little trouble from this source. If cells are repeatedly discharged below 1.7 volts, sulphating may be expected; too strong an electrolyte will also cause it. At the end of a complete charge, a lodgment of white powder that may easily be brushed off will sometimes be noticed on top of the plates; provided the body of the plates is the proper color, no attention need be paid to this powder as it is composed of particles from the plates thrown off by the gassing at the end of the charge; these particles become sulphated and of a light color while in suspension in the electrolyte.

In case white insoluble sulphate appears on the plates, the battery should be given a long continued charge at a low rate, somewhat below the normal 8-hour rate until the cells give all the signs of a full charge, and the plates have resumed their normal color. In case of badly sulphated cells, the color of the positive becomes lighter than normal and the negatives considerably darker.

45. Treatment of End Cells.—In order to allow the voltage of a battery to be varied, a number of cells at one end are frequently arranged so that they may be cut into or out of circuit. These are called end cells. Owing to the

fact that these cells are cut in and out of circuit, they are specially liable to become unevenly discharged and, therefore, require more attention than the remainder of the cells. They are successively cut into service on the discharge; hence, on the charge they should be successively cut out in the reverse order, otherwise the ones that were last cut in will be overcharged. Special care should be taken in regard to this, as it is easy to forget that a number of the cells were not cut into circuit until probably near the end of the discharge, and thus require but a small proportion of the amount of charge required for the main battery. As an aid in determining the state of charge of the end cells, there is usually installed on the switchboard a multi-circuit voltmeter switch by which the voltage of each end cell can be obtained. If any of the end cells are not used regularly or stand idle, they should be given a complete charge once a week.

SIMPLE CONNECTIONS FOR CHARGING

46. Where cells are used for portable purposes it is necessary to provide some convenient means for charging them from the ordinary sources of electrical supply. The best method of doing this will depend on the available source of charging current. It goes almost without saying that alternating current, as such, cannot be used for charging a battery, and when it is the only available source, some means must be provided for changing it to direct either by means of an alternating-current motor coupled to a direct-current dynamo, or by a rotary or mercury-vapor converter. If the ordinary 110-volt, direct-current, lighting circuit is available, it is an easy matter to charge the cells as indicated in Fig. 20 (*a*). A double-pole switch *a* with fuses *b* is connected between the mains and the battery as shown. In series with the battery *c* are a number of lamps by means of which the charging current is limited to the proper amount. It is advisable to connect an ammeter *d* in circuit, though this is not absolutely necessary. The number of lamps required depends on the line voltage and on the charging rate of the

cells. If the line pressure is 100 to 120 volts and but three or four cells are to be charged with a current of 5 amperes, then five 32-candlepower lamps connected as in Fig. 20 (a) will be sufficient. If 16-candlepower lamps are used, it will

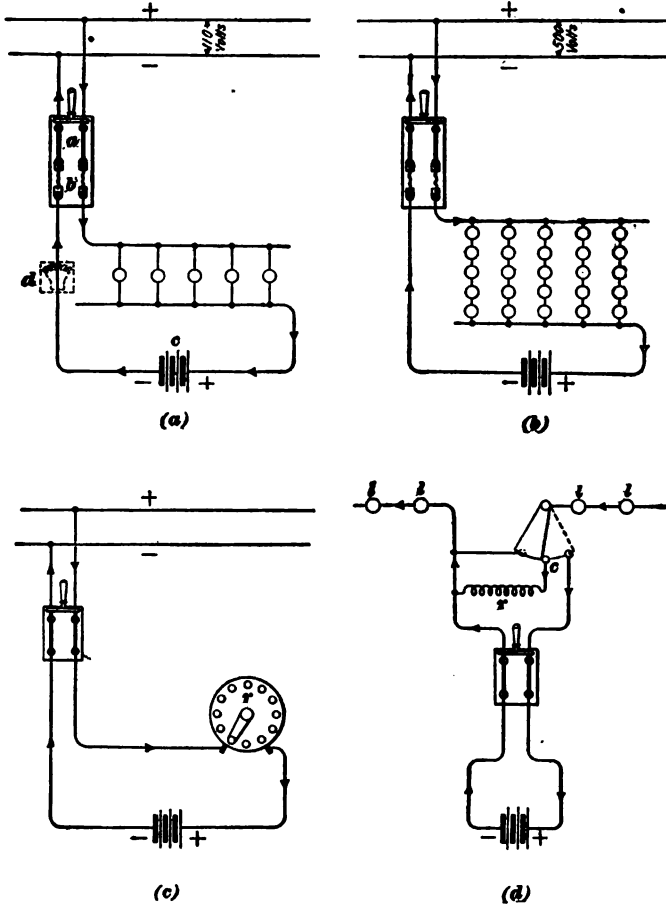

FIG. 20

be necessary to connect ten in parallel. If the line pressure is 500 volts it will be necessary to connect twenty-five 32-candlepower lamps in five rows of five lamps in series in each row, or fifty 16-candlepower lamps in ten rows, five

lamps in series in each row as shown in (b). In case it is convenient to charge at a lower rate, fewer lamps will be needed, but the time for charging will be proportionately increased.

Lamps form a convenient resistance as they are easily obtained, but an adjustable rheostat r is frequently used, as shown in (c). The amount of resistance required in the rheostat can be easily obtained as follows: Let N be the number of cells to be charged in series, then $2N$ will be the approximate voltage for charging, since each cell may be taken as requiring 2 volts at the beginning of the charge. If E is the line E. M. F., then $E - 2N$ is the number of volts effective in forcing current through the circuit, because the E. M. F. of the cells is opposed to that of the line. If I is the charging current, then the resistance of the circuit will be

$$R = \frac{E - 2N}{I} \quad (1)$$

and this will be practically equal to the amount of resistance required in the rheostat, because the resistance of the cells is very low.

EXAMPLE.—Twenty storage cells are to be charged from a 220-volt circuit. How much resistance should be connected in series with them if the charging current is to be 5 amperes?

SOLUTION.—From formula 1, $E = 220$, $N = 20$, and $I = 5$; hence,

$$R = \frac{220 - 2 \times 20}{5} = 36 \text{ ohms. Ans.}$$

This resistance should be adjustable so that some of it can be cut out as the voltage of the cells increases, and it must be made of wire large enough to carry at least 5 amperes without overheating.

Charging with resistance in series is at best a makeshift because it involves a large loss of energy; as a rule, it is used only where a few cells are to be charged and where no other method is available. A resistance is not used with regular batteries because the number of cells is such that the battery can either be connected directly across the charging circuit or else used in connection with a booster in power or lighting stations or with motor generators in

telephone or telegraph stations. The use of a resistance involves a waste of energy, but in the case of small portable batteries this waste is not a very serious matter, especially as the use of the series-resistance gives the most convenient and simple means of charging from existing circuits.

47. Charging From Constant-Current Arc Circuit.

Sometimes cells are charged from constant-current arc-light circuits, but the practice is dangerous and this source of charging current should never be used if any other is available. Constant-current arc-light dynamos generate a very high pressure, and as arc-light lines are nearly always grounded to a greater or less extent, there is quite an element of danger in working around a battery that is being charged from such a source. Great care must be taken to see that the arc-light circuit is not opened when the battery is being switched on and off. This method of charging is shown in Fig. 20 (*d*), where I, I represent arc lamps. In this kind of circuit the current is maintained at a constant value, usually from 6 to 10 amperes, so that when the battery is to be charged it must be placed in series with the lamps. The battery is cut into circuit by means of a special switch called a *consumer's switch*, which is constructed so that it will neither open the circuit nor short-circuit the battery. This is done by means of a contact point c connected to a resistance r . When the broad blade is moved to the dotted position, the resistance is first placed in series so that the line is not opened, and at the same time there is no short-circuiting of the battery. It will be noticed that when the switch is in the dotted position, the resistance is in parallel with the battery so that part of the main current is shunted around the battery. For example, the main current might be 9 amperes and the required charging current 5 amperes, in which case the resistance should be such that the difference between the two, i. e., 4 amperes, will flow through it. The pressure between the terminals of the resistance is equal to the E. M. F. of the cells; hence, if I is the current shunted through the resistance, E the voltage of

the series of cells, and R the resistance, then R is easily obtained from the relation $R = \frac{E}{I}$.

48. Direction of Current.—When charging a battery from any source, especially when there is any doubt as to the direction of flow of the current, a test should be made to determine whether or not the positive plates are connected to the positive pole, so that the current flows in at this pole when the battery is charging. A simple method of doing this is to attach two wires to the mains, connect some resistance in series to limit the current, and dip the free ends into a glass of acidulated water, keeping the ends about 1 inch apart. The end from which bubbles of gas are given off most freely is connected to the negative main, so that the main to which the other end connects is the one to be attached to the positive pole of the battery. Another convenient method of testing the polarity is by means of a Weston voltmeter, or instrument of similar type, which will give a deflection over the scale only when the terminal marked + is connected to the positive line.

49. Battery Charged From Dynamo.—Fig. 21 shows about the simplest possible arrangement of connections for charging a storage battery from a dynamo, all appliances that are not absolutely necessary having been left out in order to avoid confusion. A is a dynamo, usually either of the shunt-wound or compound-wound type; f is the rheostat in the shunt field, by means of which the voltage of the machine may be varied through a considerable range; V is a voltmeter connected to the voltmeter switch S , which is so arranged that the voltmeter may be connected to either the battery C or the dynamo A ; E is a double-pole knife switch, by means of which the battery may be thrown in connection with the dynamo; F is an ammeter that shows the amount of the charging current. The ammeters used with storage batteries are usually made with their zero point at the middle of the scale. When the battery is charging, the needle is deflected to one side of the zero mark; when discharging,

it is deflected to the other side, thus showing at a glance which way the cells are acting. It should be noted that the + side of the dynamo is connected to the + side of the battery when the switch is thrown in, the direction of the charging current being indicated by the arrows. In this case, we have assumed that the number of cells to be charged is sufficiently great to take up the voltage of the

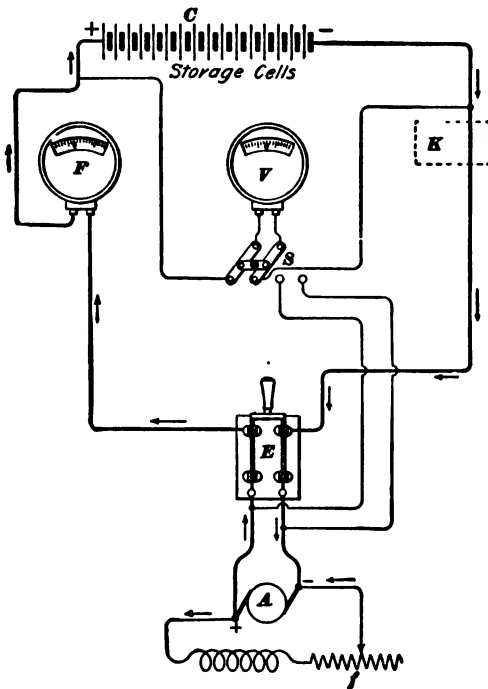

FIG. 21

dynamo; if this were not the case, a resistance would have to be inserted in series with the battery. Charging is effected as follows: Having made sure that the connections are all right, and that switch *E* is open, get the dynamo up to speed. Then measure the voltage of the cells and adjust the field rheostat of the dynamo until the voltage of the latter is from 5 to 10 per cent. higher than that of the

cells. Throw in the main switch and adjust the rheostat until the ammeter indicates the charging current called for by the makers of the cells.

The outfit shown in Fig. 21 is sufficient where a battery is simply to be charged and where a fairly close watch can be kept on it while the charging process is going on. Generally, however, the connections

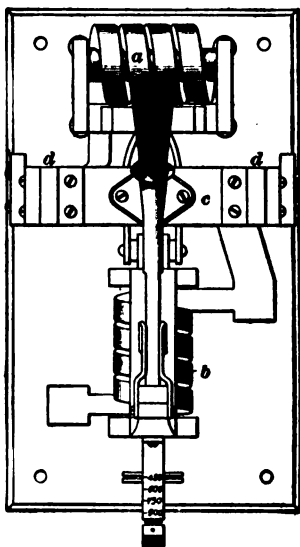

FIG. 22

must be arranged so that the cells may be either charged from the dynamo or allowed to discharge into the line. It is also necessary to have fuses or an automatic circuit-breaker of some kind to protect the battery against overloads. An underload switch is also connected between the cells and the dynamo, as indicated by the dotted outline *K*, Fig. 21. The duty of this switch is to prevent the cells from discharging into the dynamo and running it as a motor; it is, usually, an automatic switch controlled by an electromagnet connected in series between the dynamo and the battery. If for

any reason the current drops to a very low value, the electromagnet releases its armature, thus opening the switch and disconnecting the cells from the machine.

50. Cutter Automatic Overload and Underload Switch.—Fig. 22 shows a special automatic switch designed to protect the dynamo from any backward rush of current and also to protect the battery from overloads. Two coils *a*, *b* are connected in series between the battery and dynamo, as indicated at *K*, Fig. 21. If the current becomes excessive, coil *b* pulls up a core that releases a trip and allows a spring to throw the arm out, thus breaking the circuit at *d, d*. When the battery is charging, coil *a* holds its armature, but if the

current becomes very small, as it must do before it begins to reverse and flow back from the batteries, the armature is released and causes the switch to open. The instrument is therefore a protection against both underload and overload. For example, a battery might be charging and the speed of the dynamo might drop or the belt fly off. In either case, the voltage of the dynamo would drop and the charging current fall to zero.

If the circuit were not opened, a current would flow from the battery through the dynamo and run it as a motor. Another instance in which damage might result if an underload switch were not used is in case the field circuit of the dynamo should become broken. This would reduce the E. M. F. of the dynamo to zero and a large rush of current could take place through the armature, because the cells would be unable to

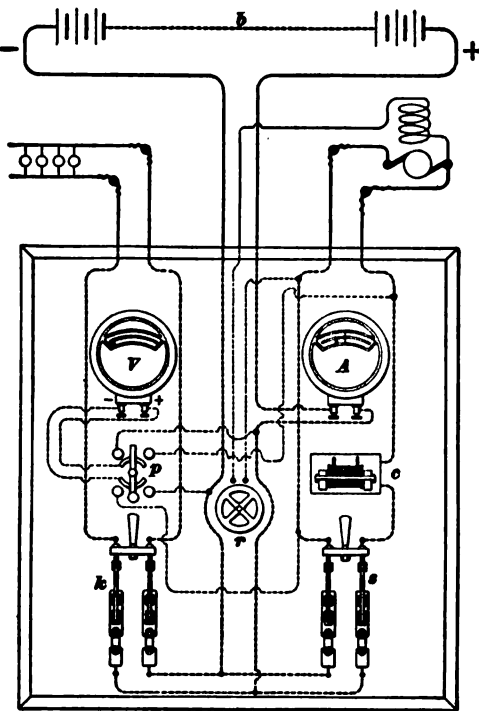

FIG. 28

excite the field so as to enable the machine to generate any counter E. M. F. as a motor. In the case of a compound-wound dynamo, a backward rush of current might result in a reversal of the dynamo field. In the case of a simple shunt dynamo, the current flows around the shunt in the same direction no matter whether the dynamo is charging the battery or whether the battery is forcing current back

through the dynamo. Fig. 23 shows a simple switchboard suitable for a small plant where a battery is used in conjunction with a dynamo for lighting or other purposes; k and s are double-pole knife switches provided with fuses, k controls the lighting circuit while s is connected to the dynamo through the underload circuit-breaker c . The ammeter A is connected in series with the battery b and indicates the charging or discharging current. V is a voltmeter connected to a switch p , by means of which it may be connected across either the dynamo or the battery; r is the handle of the field rheostat that is connected in series with the shunt field of the dynamo. When the battery is being charged, the switch k is open and the switch s closed. When the battery alone is furnishing current to the line, s is open and k closed. If it is desired to have both battery and dynamo furnish current to the line, both switches are closed.

In Fig. 23, it will be noticed that no provision is made for varying the E. M. F. of the battery, either by cutting cells in or out or by any other means. In all but small installations such provision is usually necessary.

USE OF ACCUMULATORS IN CENTRAL STATIONS

51. In central stations furnishing current for lighting or other purposes, the demand for current varies greatly at different periods in the day; for example, a lighting station in a large city will probably be called on to furnish, from 5 to 8 P. M., ten times the amount of current that is required from 5 to 6 A. M., and in small stations the disproportion is even greater. As economy of operation demands that the engines and dynamos be worked at or near their full capacity, especially if the engines be compound or triple expansion, both of these conditions can be met only by dividing the machinery into a large number of small units, or by using some system of storage of the electrical energy. In the first case, the small units require more attention and are much less efficient than larger ones, so that most modern large stations have their machinery divided into a few

large units, employing large compound engines. Storage batteries can be used to great advantage, therefore, in connection with stations. The way in which they are used will, however, depend largely on the nature of the load, and the following will point out the more common methods.

52. Battery Taking Peak of Load. Probably the most common method of using a central-station battery is to charge it during intervals of light load and discharge it when the heavy load comes on; in other words, make it take the peak of the load. Fig. 24 shows the load line of a lighting station where a battery is used in this way. The full line shows the variation in the output of the station for a period of one week beginning on a Sunday at 12:30 A. M. Each horizontal division represents 3 hours and each vertical division 250 amperes.

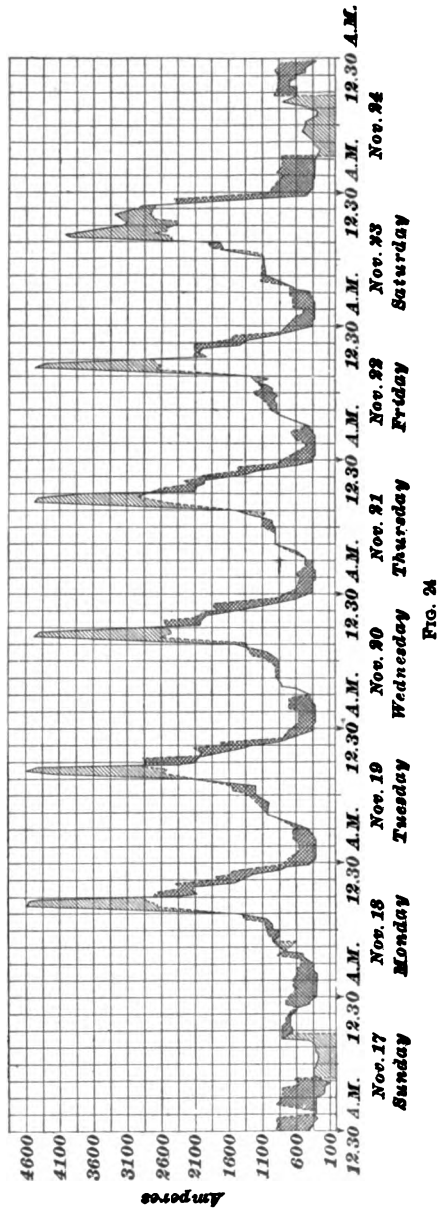

FIG. 24

On Sunday, the load is light and the battery is allowed to charge, as shown by the double-shaded area, from 12:30 until about 10 A. M. All the generating plant is then shut down and the whole load carried by the battery for about 8 hours. The generators are again started about 4 P. M. and in addition to carrying the load, they charge the battery until a little after 3:30 on Monday when the heavy load begins to come on. The load rises very rapidly between 3:30 and 6:30 and reaches a maximum of 4,600 amperes—of which nearly 1,750 amperes is supplied from the battery, as indicated by the single-shaded area. After the load has dropped to about 2,600 amperes, the charging is again started and so on throughout the week. On Saturday, the peak of the load is not as high as on the other week days, but it is broader on account of the earlier closing of offices and later closing of retail stores.

By examining Fig. 24, the great advantage of the battery is at once apparent. If no battery were provided, generating equipment capable of supplying the maximum output of 4,600 amperes would be necessary. With the battery, the generator output never exceeds 2,950 amperes, approximately, so that the battery takes the place of engines, boilers, and dynamos equivalent to an output of 1,650 amperes. The combined areas in Fig. 24 representing the charge, must of course be somewhat greater than the combined areas of discharge, because the ampere-hour efficiency is less than 1.

There are many advantages incident to the use of the battery other than the saving in generating equipment. The battery is valuable as an insurance against complete shut-downs in case of serious accident to the generating equipment. It also holds a supply of energy that is instantly available in case of a sudden demand for current caused, for example, by darkness due to a storm. It is of very great benefit in preventing voltage fluctuations on the system as a whole, thus making the lights burn steadier and last longer. By installing a battery in a station of given generating equipment, the output of the station and the revenue obtained therefrom can be considerably increased without additional

expenditure for generating equipment. Moreover, the equipment already installed will be worked to the best advantage, because the load on the engines and dynamos can be kept more nearly uniform and also more nearly at the full capacity of the units employed, thus securing maximum efficiency of operation. Against these various advantages must be set the cost of the battery, the expense of looking after it, and the allowance for deterioration which with storage batteries is greater than with engines or dynamos. The fact, however, that so many large central stations are installing storage batteries or are adding to their present installations, is the best proof that they are desirable and that a distinct saving is effected by their use.

53. Battery Used to Carry Whole Load.—In Fig. 24, a case was shown of where the battery is used to carry the whole load on Sunday. This allows all the machinery to be shut down for 8 hours and gives a good opportunity for inspection or repairs, besides allowing the operation of the station with a small working force.

54. Battery Used to Take Up Fluctuations in Load. In street-railway power stations of small or moderate size, or in substations supplied from a large central station, the output varies between wide limits owing to the starting and stopping of the cars, and if a storage battery is not used the station machinery must stand these wide and rapid fluctuations. This is liable to strain the engines and dynamos to say nothing of its being an uneconomical method of working. Also, wide and rapid variation of load on the generating outfit is almost sure to cause considerable variation in voltage. Storage batteries are now largely used in railway power stations to take up these fluctuations, discharging when the load is heavy and charging when it becomes light. Regulating appliances make this action automatic, so that the load on the generating outfit is kept nearly uniform.

Fig. 25 shows the current output from a street-railway station equipped with a battery of 258 Chloride cells. The

full line shows the station output, which varies from a minimum of less than 100 amperes to a maximum of over 850 amperes. It will be noted that this load diagram is for an interval of 15 minutes only, so that the variations are very sudden. In spite of these sudden variations, the load on the dynamos is kept within 350 and 400 amperes, as shown by the dotted line, the double-sectioned areas above this line representing discharge intervals, and those below the line charge intervals. The ampere-hours discharge, indicated in Fig. 25 by the combined double-sectioned areas, is considerably greater than the charge, as represented by the single-shaded areas. It must be remembered, however, that the interval of time represented is only 15 minutes. If the

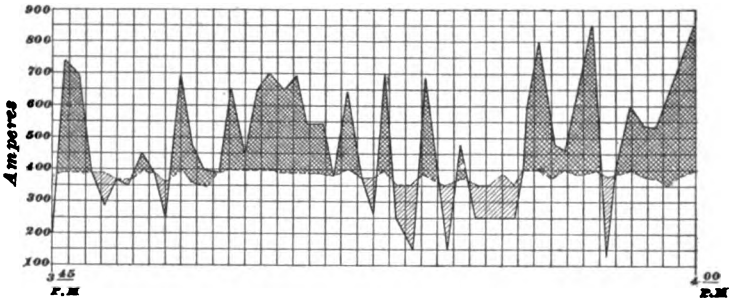

FIG. 25

load curve were drawn for a longer period, say 24 hours, the charge would likely be in excess of the discharge, since the regulating appliances are usually adjusted so that sufficient charge is given to the battery during its regular operation to make up for the discharge and thus render extra charging unnecessary.

The curves in Fig. 26 are taken from a street-railway substation from which current is supplied from a rotary converter used in conjunction with a storage battery to take up the load fluctuations. In this case the charge and discharge areas of the battery curve are more nearly equal than in Fig. 25. The load on the rotary converter is here plotted separately and the lowest curve represents the total output

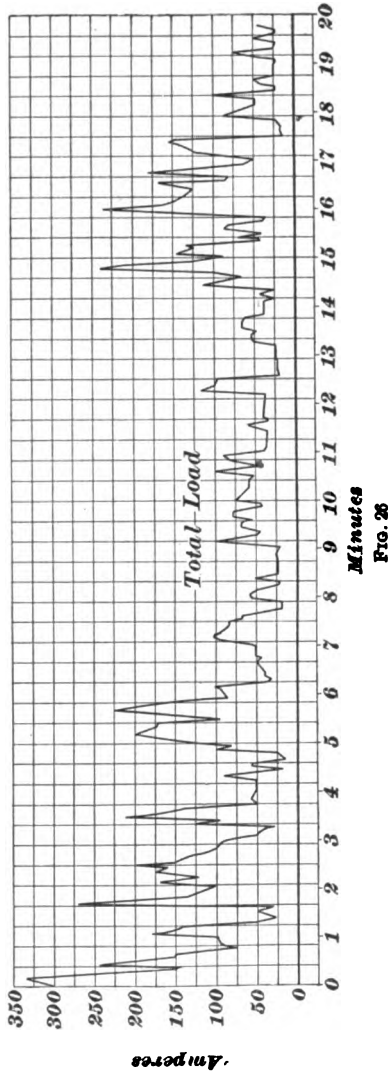
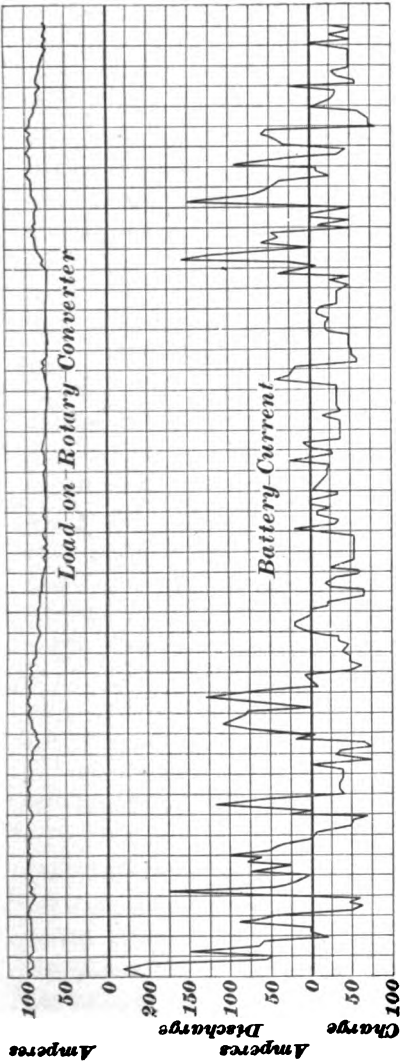

FIG. 26

of the substation obtained by adding the battery and rotary-converter load curves together, charging currents being taken as negative and hence subtracted from the converter output to obtain the current delivered to the line. The load on the converter remains comparatively steady, between 75 and 100 amperes, while the line current varies from below 25 amperes to over 325 amperes. The readings only cover a period of 20 minutes and the fluctuations in load are very rapid, yet the load on the converter and hence the current supplied to the substation from the line is kept fairly steady

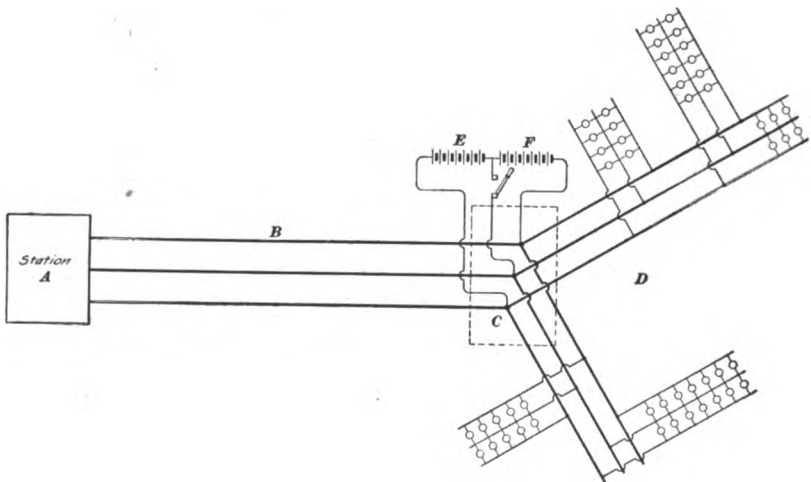

FIG. 27

and is small compared with the maximum that would be required if the battery were not used.

55. Battery Out on Line.—Batteries are frequently placed at the end of feeders supplying certain sections. By this means the voltage at the distributing center is maintained at a nearly uniform value, the variations of load in the central station are reduced, and the feeders are worked to the best possible advantage. This method of using a battery will be understood by referring to Fig. 27, which shows a three-wire network *D* of incandescent lamps supplied from a distributing center or substation *C*, which is in turn supplied by

feeders *B* running to the main station *A*. Under normal conditions, the battery *EF* is connected across the outside lines, but a connection to the neutral wire from the middle point is provided so that it can be used if necessary. The load of lamps represented by *D* may be much in excess of what could be supplied over the feeders *B* without giving rise to a prohibitive drop in voltage. If, however, a battery is installed, it may be charged during the daytime when the demand on the feeders is small, and thus relieve the feeders at night when the heavy load comes on; in other words, by using the battery, the feeders are worked at an approximately uniform rate throughout the day. Looking at it in another way, the installation of the battery out on the line allows a larger amount of work to be done without increasing either the feeder or generator capacity, and the further important gain is made that a heavy drop in voltage in the feeders is eliminated, thus rendering the service much more satisfactory.

A battery installed on the line regulates automatically. When the demand is large, the

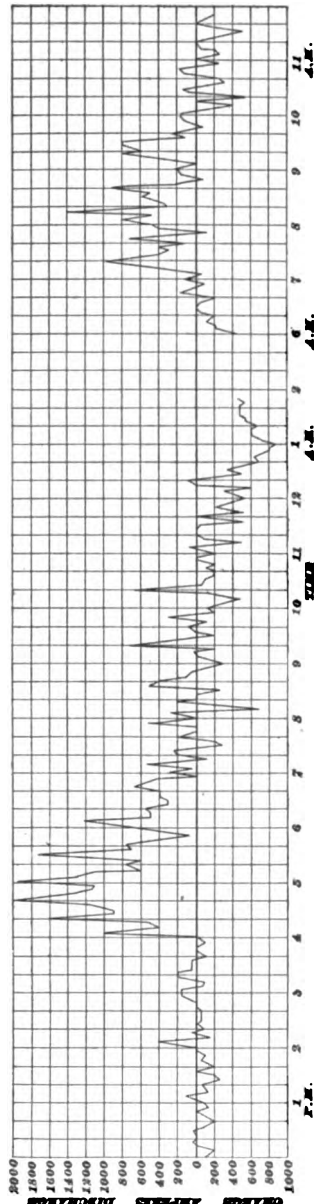

FIG. 28

drop in the feeders becomes greater than normal, thus lowering the pressure at the battery terminals and allowing it to discharge into the line. When the load is light, the drop in the feeders is small, the pressure applied to the battery is higher than that of the battery, and a charging current flows into it.

Fig. 28 shows the variation in output of a Chloride battery placed on a street-railway line 4 miles from the power house. This shows how the battery takes up the fluctuations and supplies the peak of the load between 4 and 7 P. M. Since this large current is supplied from the battery and not brought over the long feeders from the power house, it follows that the voltage is maintained much better than if the battery were not used. After 11 P. M. the load on the feeders becomes so light that the battery charges most of the time, and between 7 and 9 A. M. it again takes a peak, though in this case the peak is smaller than in the evening.

The curves in Fig. 29 show the effect that a battery, used at the end of the line, has on the voltage regulation of a railway system. Curve *A* shows the current delivered by the battery when discharging or taken by it when charging. Curve *B* shows the variation in voltage when the battery is in use and curve *C* shows the variation when the battery is out of service. When the battery is not used, the voltage varies from 550 to 325 volts, owing to the heavy momentary currents that must be transmitted over the line. When the battery is in use the voltage varies between 450 and 525 volts, thus maintaining a much better pressure on the system and enabling the cars to make better time. When the load is light, voltage high, the battery charges, hence the maximum voltage with the battery on is not as high as with the battery off because of the drop in the line due to the charging current. When the battery is off there are instants when there is practically zero current in the line and the pressure at the end of the line then becomes equal to the station pressure.

56. Selection of Battery for Given Service.—The only way to arrive at an intelligent conclusion regarding the

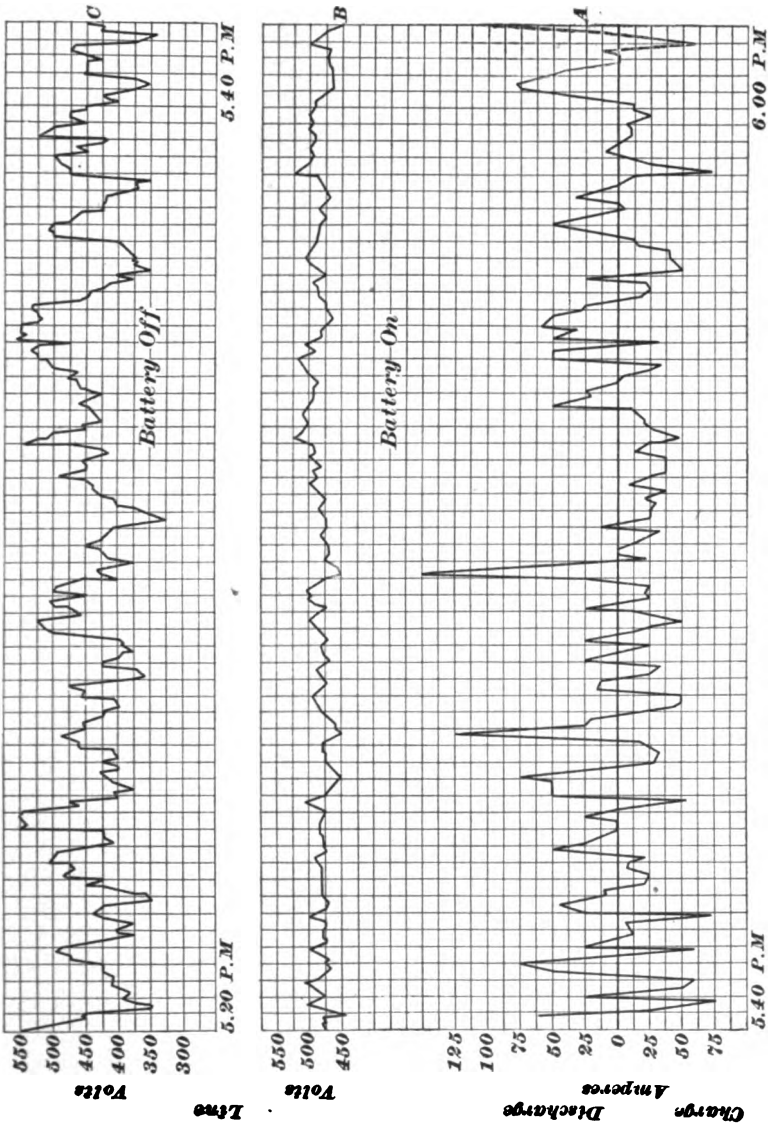

FIG. 29

size of battery to be used for any given case is to determine as nearly as possible the load line of the station in question. The generating capacity is usually known, so that by laying out a diagram and measuring up the probable discharge areas on it, a fairly close idea as to the capacity needed can be obtained. As the output of most plants is always increasing, it is common practice to install jars or tanks somewhat larger than required at the start. The capacity of the cells can then be easily increased by simply adding more pairs of plates to each cell.

The number of cells required for a given installation will depend on the voltage of the system, and also on the range of voltage regulation that is desired by cutting cells in or out. Assuming that the cells are discharged down to 1.75 volts, the minimum number of cells required would be the voltage of the system divided by 1.75. For example, a battery for a 110-volt system would require $\frac{110}{1.75} = 63$ cells.

STORAGE-BATTERY REGULATING APPLIANCES

57. In order that the charging and discharging of a battery shall be under control, it is necessary to use auxiliary apparatus that will allow the effective voltage of the battery to be varied at will. The appliances used in any given case will depend on the nature of the work that the battery has to do. For example, the regulating devices necessary with a slowly changing lighting load are not adapted to the operation of a battery on a rapidly fluctuating railway load.

END-CELL SWITCHES

58. The simplest device for varying the effective voltage of a battery is the **end-cell switch**, the use of which will be understood by referring to Fig. 30; *A* is the main battery and *B* a number of cells from each of which connection is made to the contacts *b* of the end-cell switch. **A**

contact piece *a* is arranged so that it can be slid from *a* to *a'* by means of a suitable mechanism, and the number of cells in use thereby varied. When the battery has been fully charged, the end cells are cut out of circuit and the contact *a* occupies the position *a'*. As the voltage runs down, *a* is moved to the left and fresh cells cut in, thus maintaining the voltage *E* at the desired amount. Fig. 31 shows a horizontal type of motor-driven, end-cell switch made by the Electric Storage Battery Company; this switch accommodates 20 end cells. The traveling laminated contact is shown at *a a'*, and the cells are connected to the terminal blocks *b, b* mounted on a slate slab. The bar *c* connects to the line, the terminal connection being attached at *d*. The cross-head is

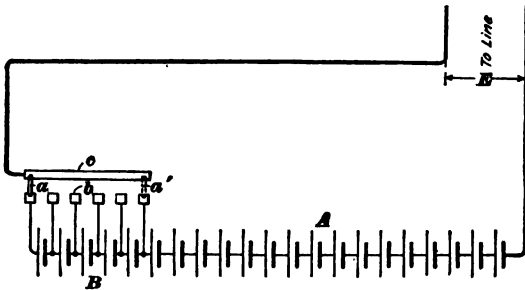

FIG. 30

operated by the screw *s* driven by a small series-motor *m*, which is controlled from the switchboard and can be run in either direction, the motion being transmitted to the screw through the worm *w*. An electric brake *b* is provided to stop the motor promptly when the current is turned off. In some of the later switches this braking action is effected by short-circuiting the armature of the series-motor while the field is fully excited. An automatic switch, not shown in the figure, is operated by the shaft *s* so that after the motor has been started in either direction by the switchboard attendant, the screw will revolve until contact *a* has moved to the next cell contact and will then stop. Insulated bearing pieces *e, e* are provided between the blocks *b, b* for the contact *a* to slide on. The laminated contact *a* is not wide enough to bridge

46B-6

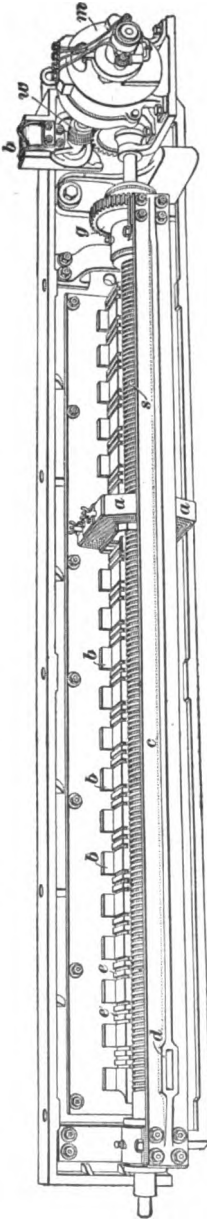

FIG. 31

over the space between contacts *b*, and thereby short-circuit a cell. In order to avoid interruption of the circuit while *a* is passing from one cell to another, auxiliary carbon contacts are carried on the cross-head; the resistance of these is sufficient to prevent short-circuiting of the cell during the movement, and at the same time keep the battery in connection with *c*. Gear *g* is used when two or more end-cell switches are geared together so as to be operated simultaneously. End-cell switches are frequently equipped with *end-cell indicators*, which, by means of small signal lamps, a traveling pointer, or other device operated from the end-cell switch, show the switchboard attendant at all times the exact position of the switch and the number of cells in service.

59. Battery With Single End-Cell Switch.—Fig. 32 shows about the simplest possible arrangement for a battery with an end-cell switch operated in parallel with a dynamo. In this figure all minor devices, such as voltmeter switches, circuit-breakers, etc. have been omitted. An automatic circuit-breaker should be provided in series with the dynamo, and an overload and underload circuit-breaker should be connected between the dynamo and battery.

In Fig. 32, *A* is the dynamo, either shunt or compound wound, but usually the latter type in America, *B* is the main battery, and *C* the end-cell switch connected to the end cells, as shown.

Switches are provided at *d, e, f, g, h,* and *k*. An ammeter *l* connected to its shunt *o* indicates the output of *A*, and ammeter *m* indicates the output of the battery; this ammeter has its zero point in the center of the scale. When the battery is working on the load in parallel with the dynamo, all switches are closed; and as the battery becomes discharged fresh cells are cut in by means of the end-cell switch. When the battery is to be charged, all switches are first opened and the end-cell switch placed in the extreme left position. The dynamo is then brought up to a voltage slightly higher than that of the battery, and switches *d, e, h,* and *k* closed. The field is then adjusted further until *m* shows the correct charging current. The pressure

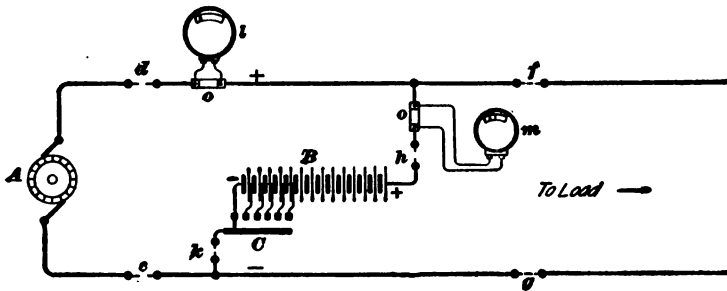

FIG. 32

required for charging the battery is considerably higher than the normal line voltage; hence, it is not possible with this arrangement to use the dynamo, running at a high voltage, for charging purposes, and also for furnishing current to the line unless a resistance is connected in series with the line to take up the surplus voltage. This involves considerable waste of power, so that with the arrangement shown in Fig. 32 the charging is done at such times as current is not required on the line.

60. Battery With Double End-Cell Switch.—Fig. 33 shows a battery with two end-cell switches *C, D*. By using a double arrangement as shown, the normal voltage may be supplied to the line while at the same time the battery is

being charged by a current supplied at high voltage from the dynamo. In Fig. 33 switches 1, 2, and 3 are closed and the double-throw switch 4, 5 is thrown to the upper position; the battery is charging and the path of the charging current is represented by the dotted arrows. At the same time the dynamo is furnishing current to the line, as indicated by the full-line arrows. From the position of end-cell switch *D* it is seen that the pressure between the outgoing lines is equal

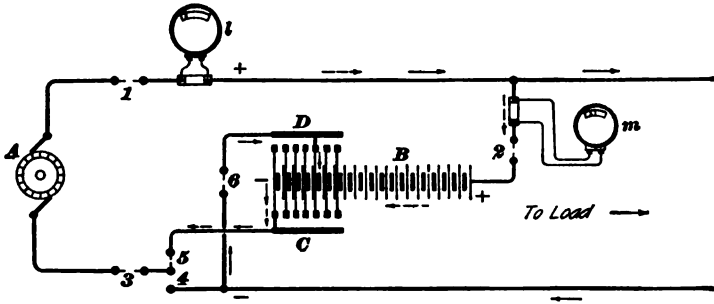

FIG. 33

to that of the main battery *B* plus that of two end cells, while from the position of *C* the pressure furnished by the dynamo must be high enough to charge the whole battery. When it is necessary to arrange a battery so that the generator can furnish current for charging purposes, and at the same time furnish current to the line, it is usual to provide a booster for increasing the generator voltage the desired amount.

STORAGE-BATTERY BOOSTERS

61. A storage-battery booster is an auxiliary dynamo, generally of small size compared with the main-station generators, the armature of which is usually, though not always, connected in series with the storage battery. The voltage of this dynamo may be either added to or subtracted from that of the battery, thus increasing or decreasing its effective voltage. For example, in Fig. 34, *A* is a battery working in parallel with a dynamo, and *B* is the armature of the

booster connected in series with the battery. Suppose that the booster is, for the present, generating no voltage and that the voltage of both battery and dynamo is 110 volts. Under these circumstances the battery would neither charge nor discharge. If the field of the booster is excited so that its brush *a*, which is connected to the negative pole of the battery, is positive, it is seen that whatever voltage is generated in the booster is added to that of the battery, and the pressure between points *c* and *d* is raised above 110 volts; the battery, therefore, discharges and the rate of discharge depends on the pressure generated by the booster. If the polarity of the booster were reversed, brush *a* being - and *b* +,

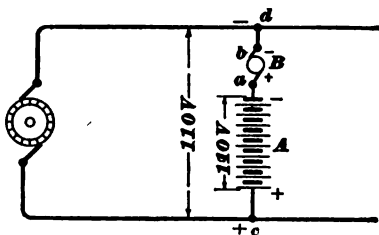

FIG. 24

the booster voltage would be opposed to that of the battery, and the pressure between *d* and *c* would be less than 110 volts by the amount of the booster voltage. Or, looking at it in another way, the pressure of the booster is added to that of the dynamo, so that the pressure applied to the terminals of the battery is raised above the battery voltage, and a charging current therefore flows. With this explanation in mind the student will more readily understand the explanations of the following types of storage-battery booster.

Storage-battery boosters may be divided into four classes: *shunt, compound, differential, and constant current.*

SHUNT BOOSTER

62. The **shunt booster** is so called because its field is provided with a plain shunt winding similar to that of a shunt dynamo or motor. Boosters are usually driven at approximately constant speed by means of a shunt motor mounted on the same base and directly coupled to the booster armature, though in some special cases they might be driven by an engine. The shunt booster is used in those places where

the battery is intended to take the peak of the load or for other work where it does not have to be continually charging and discharging. It is, therefore, well adapted for use in lighting stations where the load changes gradually, and where the battery charges or discharges for fairly long intervals of time.

Fig. 35 shows the general arrangement of a shunt booster. *A* is the main generator and *B* the armature of the booster driven by means of a motor not indicated. *C* is the storage

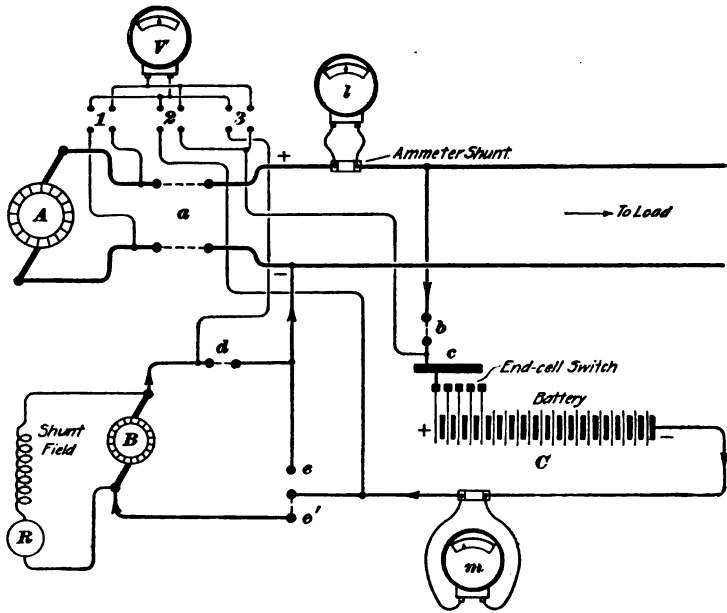

FIG. 35

battery, and *c* the end-cell switch by means of which the effective voltage of the battery may be varied. In order to charge the battery to its full capacity, it is necessary to have a voltage considerably higher than that generated by *A*; this increase in voltage is supplied by the booster *B*. Suppose that the battery is to be charged; switches *a*, *b*, and *d* are closed and the double-throw switch *e'* is thrown to the lower position. The end-cell switch is placed on the last point, as

shown, so that all the cells will be included in the circuit. When d and e' are closed, the armature B is connected in series with the battery and the two are across the line. The polarity of the booster voltage is such that it assists A in forcing current through the battery; or, in other words, B increases the E. M. F. applied to the battery terminals. The voltage of B can be adjusted by means of a field rheostat R until the battery ammeter m indicates the proper charging current. When the battery is fully charged, the E. M. F. of all the cells will be greater than that of A , but the voltage with the end cells cut out will be about equal to that of A .

When the battery is to discharge into the line, switches d and b are opened and e' is thrown to the position e . End cells are then cut out until the voltage of the battery agrees with that of the line and switch b is closed, thus connecting the battery across the line. The ammeter m indicates the discharge current. As the voltage of the battery falls, due to the discharge, end cells are cut in by means of switch c .

In many cases shunt boosters are arranged so that they can be made to assist the battery to discharge as well as charge. In order to do this, provision must be made for reversing the shunt-field current so as to reverse the polarity of the brushes. The field winding of the booster is here shown connected across the brushes of the booster, though it may be connected across the bus-bars or battery, provided the winding is designed for the voltage impressed on it. In Fig. 35, ammeter l indicates the load on the generator, and the voltmeter V may be used to indicate the voltage of A by inserting a plug at 1. The voltage of the battery is indicated by inserting a plug at 2, and the voltage of the battery plus that of the booster is indicated by inserting a plug at 3.

63. Reversing Rheostat for Booster Field.—Fig. 36 illustrates a special type of field rheostat used when the voltage of the booster is to be reversed and controlled by gradual steps in either direction. A, B are equal resistances split into a number of sections and connected to the insulated

segments g, g as shown; d, e are contact arcs and a lever pivoted at h carries contacts a, b that bridge over between the contacts and the contact arcs. Terminals x, y are connected either to the bus-bars or to the battery, and the arcs d, e are connected to the field winding C of the booster. The whole scheme of connections is, in fact, the same as a Wheatstone bridge where the galvanometer is replaced by the field C . It is evident that, when the lever is in the vertical position $a b$, there is no difference of potential

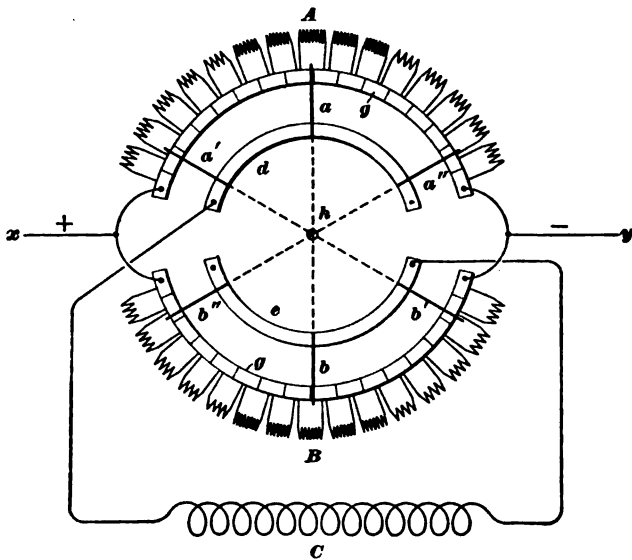

FIG. 36

between the field terminals and the field is unexcited. As the lever is moved over to the position $a'' b''$, the pressure across the field terminals is gradually increased until the extreme position of the lever is reached and e is connected directly to the + terminal and d to the - terminal. A movement of the lever in the reverse direction, i. e., from the vertical position toward $a' b'$, gradually increases the pressure across the field but in the reverse direction. This rheostat, therefore, allows the booster to be used as an aid either in

charging or discharging, and also allows close regulation of the charging and discharging current. In order to make the waste of energy small, the central sections of the rheostat have a high resistance.

COMPOUND BOOSTER

64. When the load fluctuates rapidly, as in electric railway or power plants, and the battery is used to even up these fluctuations, it is not practicable to regulate the charge and discharge by means of an end-cell switch, because the regulation cannot be effected quickly enough. For work of this kind the charge and discharge is usually regulated by means of either a compound or a differential booster. A number of patents have been taken out relating to various

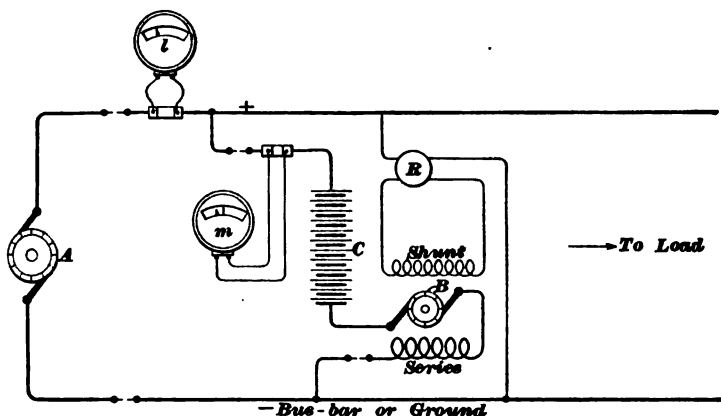

FIG. 37

arrangements of these boosters, but the general operation of a **compound booster** will be understood by referring to Fig. 37. *A* is the armature of the main dynamo, *B* the armature of the booster, and *C* the battery. The field of the booster is provided with two windings, one of which is in series with the armature. The other winding is excited from the battery, or bus-bars, and has a rheostat *R* in series with it; this rheostat is usually of the reversing type so

that the current in the shunt winding can be made either to oppose or aid that in the series-winding.

Under normal conditions of operation the shunt winding aids the series-winding in magnetizing the field of the booster. It is necessary for the operation of this type of booster that the voltage of the generator should drop with increasing load. If A is compound wound, the series-coils may be cut out of service or shunted when the machine is used in conjunction with the battery. The operation of the booster is as follows: The rheostat R is adjusted so that when the generator is delivering its normal load at normal voltage, the voltage of the booster plus that of the battery just equals the voltage of the dynamo; under these conditions there will be neither a charging nor a discharging current. If the load on the line increases, the voltage of A tends to drop on account of the increased load momentarily thrown on it. This allows the battery to discharge, and the discharging current flowing through the series-coils of the booster raises the combined E. M. F. of the battery and booster, thus making the battery at once take such a share of the load that the E. M. F. across the lines is restored to its normal amount. On the other hand, a decrease in the external load below the normal tends to make the dynamo voltage increase. The battery then charges, and the charging current flowing back through the series-coils of the booster opposes the shunt coils, thus lowering the booster voltage and allowing the charging current to increase until the generator voltage comes down to the normal amount. In actual working, the voltage changes very slightly, as any tendency to change is checked by the operation of the battery and its booster.

DIFFERENTIAL BOOSTER

65. The differential booster is used on systems where a load subject to wide and rapid fluctuations is handled. It has two sets of field windings, series and shunt, as in the compound booster, but is distinguished from it by the fact that under normal conditions of operation the magnetizing

effects of the series and shunt coils are opposed to each other. A number of types of differential booster have been patented, their differences consisting principally in the method of arranging and connecting the field windings. Fig. 38 shows a scheme of connections very commonly used. *A* is the generator, *B* the booster armature, and *C* the battery. The field of the booster is provided with two sets of series-coils *D*, *E* connected as shown; the shunt field is connected across the line. The effect of the shunt field can be varied by means of the rheostat *R*. Coils *D*, *E* are connected so that their magnetizing effect is opposed to that of the shunt coil. The battery *C* is connected in series with the booster by throwing switch *c c'* to

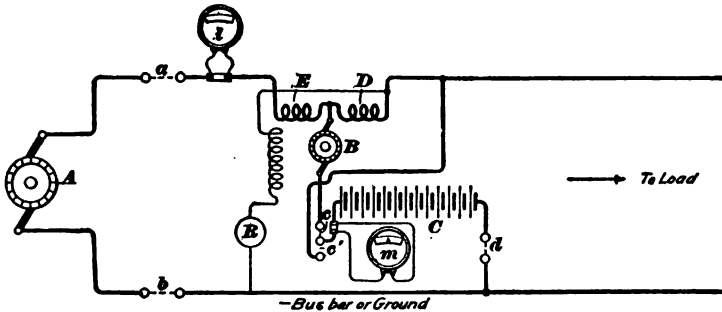

FIG. 38

the upper position; by throwing to the lower position *c'* and also closing switch *d*, the battery is connected directly across the line and the booster thereby thrown out of service. Coil *D*, when battery *C* is discharging, carries the combined output of the battery and dynamo; coil *E* carries the dynamo output only. The magnetizing effect of *D* will therefore vary with the load on the line, and that of *E* will vary with the current delivered by the dynamo; this latter is supposed to be nearly constant, so that coil *E* may be considered as furnishing an approximately constant magnetizing force. The coils are adjusted (in case of the series-coils, by adjustable shunt resistances across their terminals) so that when the normal load is delivered there is neither charge nor

discharge from the battery, because the effects of the magnetizing coils neutralize each other, making the booster E. M. F. zero and allowing the battery E. M. F. to balance that of the generator. If the load increases above normal, the magnetizing effect of D is increased, thus causing the booster to generate an E. M. F. in such a direction as to assist the battery to discharge and take up the surplus load. If the load falls below normal, the magnetizing effect of the shunt field predominates, thus making the booster generate an E. M. F. in the reverse direction and allowing the battery to charge. The load on the dynamo is therefore kept practically constant in spite of the fluctuations of the current delivered from the station.

The connections shown in Fig. 38 have been simplified as much as possible in order to bring out the main points connected with the operation of the booster; in practice, a number of additional connections might be used. For example, switches are often provided so that the series-coils may be cut out of service and the machine operated as a plain shunt booster. The battery is occasionally charged up when the load is light, as the intermittent charging that it receives during its regular operation may not be sufficient. In case the battery were used on a fairly steady load, the machine would, of course, be operated as a plain shunt booster and whatever regulation was necessary to control the battery current would be obtained by varying the field rheostat.

66. Fig. 39 shows a scheme of switchboard connections for a differential booster. A is the generator armature, B the booster armature, D an underload-and-overload battery circuit-breaker, E the generator circuit-breaker, F the generator ammeter, G the battery ammeter with its zero point in the center of the scale, and H the voltmeter. The voltmeter is connected to a voltmeter switch, so that readings may be taken of the generator voltage, the battery voltage, or the voltage of the battery plus that of the booster; the voltmeter connections have been omitted in order not to confuse the

figure. *K* is the generator-field rheostat, *L* the reversing rheostat in the shunt field of the booster, *M* a starting rheostat for the shunt motor *N* that drives the booster, and

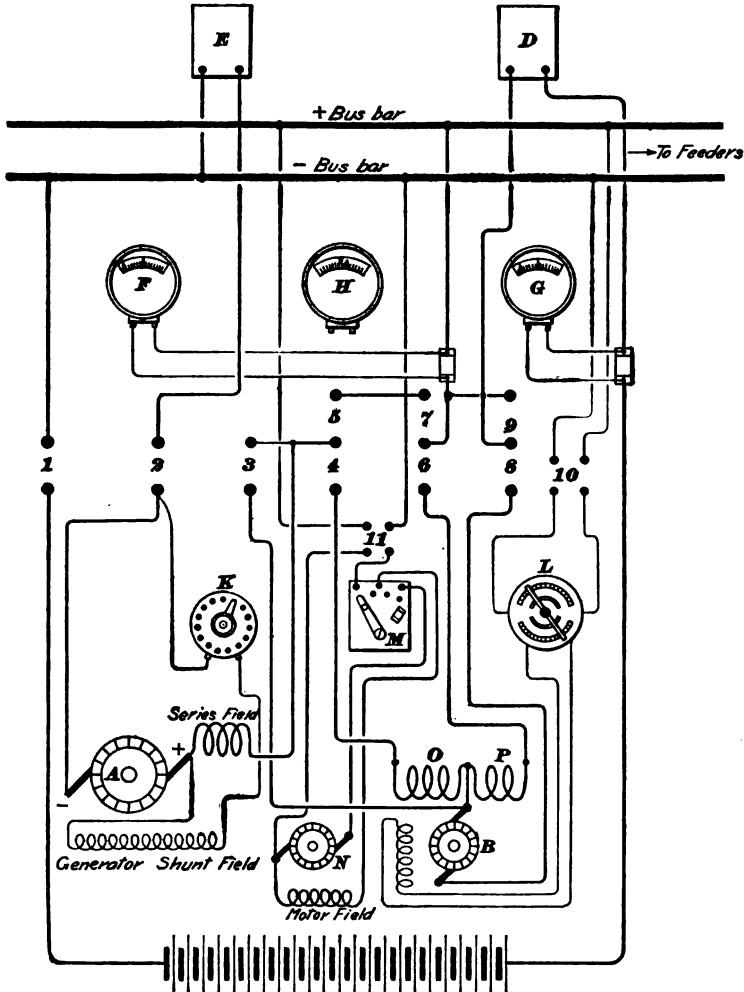

FIG. 39

OP the series-fields of the booster. Single-pole switches 1, 2, 3, etc. are connected as shown; switches 4-5, 6-7, 8-9,

are single-pole double-throw, and are used for making the various combinations described later. Switch 10 connects the shunt field of the booster to the bus-bars, and 11 is the main switch for the motor. The combinations that may be effected are as follows:

(a) Generator working alone on bus-bars with battery and booster cut out of service. Switch 2 is closed, and switches 5 and 7 thrown to the upper position. All other switches are open.

(b) Battery working alone on bus-bars, generator and booster cut out of service. Switch 1 is closed, and switch 9 thrown to the upper position, all other switches open.

(c) Battery and generator operating in parallel on bus-bars with booster in service. Switches 1 and 2 are closed, and switches 4, 6, and 8 thrown to the lower position. Switches 10 and 11 are also closed because the booster is now in operation.

(d) Battery in parallel with generator, series-coils of booster cut out. In this case *B* is operated as a shunt-wound booster and the battery is being charged. Switches 1, 2 and 3 are closed; switch 8 is thrown to the lower position and switches 5 and 7 to the upper position. Switches 10 and 11 are also closed and *L* is adjusted so that the booster helps the battery to charge.

CONSTANT-CURRENT BOOSTER

67. The constant-current booster is used principally in office buildings or manufactories where the feeders are not long and where a considerable portion of the load, such as motors and elevators, is of a fluctuating nature. It is also used to some extent for street-railway systems instead of the compound or differential types. Its object is to maintain an approximately constant current delivery from the generators, the fluctuations of the load being taken up by the battery. It therefore accomplishes the same purpose as a compound or differential booster as far as keeping the dynamo current at a constant value is concerned, while on account of the way in which it is used, the machine can be smaller and cheaper than

either of the other types. This booster can be used to advantage where constant voltage on the power circuit is not essential. Fig. 40 shows a common arrangement of connections. *A* is the generator supplying current to the bus-bars *E, F* to which the steady load is connected. The fluctuating load is connected to bus-bars *G, H*, and the booster armature *B* and series-field are connected in series between *E* and *G*. That is, the fluctuating load does not pass through any of the booster windings as in the case of the compound and differential boosters. The booster carries only the average current supplied by the generator to the power

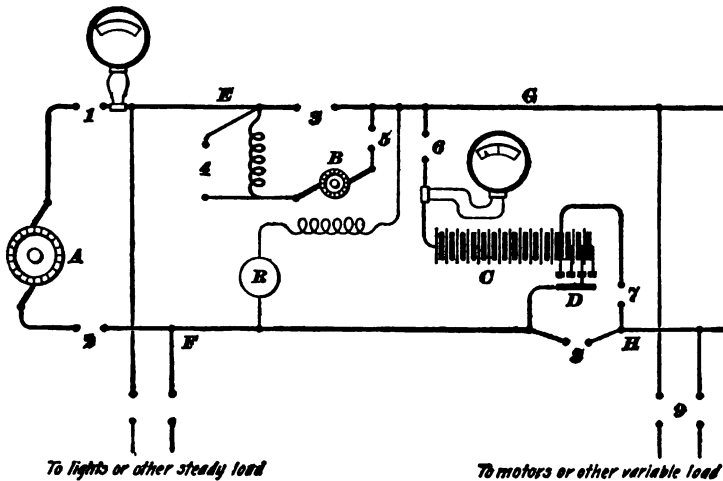

FIG. 40

system and can be of comparatively small output; moreover, the steady load is connected between the generator and the booster so that this part of the load current does not pass through the booster. The battery is usually provided with an end-cell switch *D* so that, if desired, it may be operated on the lighting load only, the cells being cut in as the voltage drops. The booster is provided with a shunt winding, which sets up an E. M. F. in the armature in a direction such as to aid the generator E. M. F. The series-coils oppose the shunt coils and set up an E. M. F.

opposed to that of *A*. It will be noticed that the current through the booster is not reversed, because the only current that flows through it is that supplied by the generator. Under ordinary operating conditions switches 1, 2, 5, 6, and 7 are closed, at which time the operation is as follows: In case a heavy load comes on the power circuits, the tendency is for a heavy current to be delivered by the generator through the booster. Now the voltage across the terminals of the battery is equal to the generator voltage plus that of the booster; any increase of current in the series-field causes a lowering of the booster E. M. F., because the series-winding opposes the shunt winding. The result is that the pressure across the battery terminals decreases, thus causing the battery to discharge and supply the extra demand for current. Conversely, a decrease in the fluctuating load causes the battery to charge. The dynamo, therefore, delivers an approximately constant current. Of course, the generator current does not remain absolutely constant, but the irregularities due to the heavily fluctuating motor load are so smoothed out that the pressure supplied to the lamps is practically uniform and the objectionable flickering, so often apparent where a variable load is operated from the machine, is done away with.

If both loads must be operated directly from the dynamo without the use of the battery or booster, these may be cut out as follows: The booster is shut down and switch 3 closed. Switch 3 cannot be closed while the booster is generating, because armature *B* would be short-circuited. Switch 5 is then opened and the booster thereby cut out of service. By opening switches 6 and 7 and closing switch 8, the battery is cut out and the dynamo supplies all the current. Note that switch 7 must be opened before 8 is closed, otherwise the end cells will be short-circuited. If it is desired to cut off the fluctuating load and run the lights from the battery alone, switches 8 and 9 are opened, and switch 6 closed. This cuts off the fluctuating load and places the battery, with its end cells, in parallel with the generator, it being understood that the booster is now out of service. By opening switches 1 and 2 the generator is cut off and the whole

lighting load is carried by the battery, the regulation being effected by means of the end-cell switch. When the battery is to be given a full charge, *B* can be operated as a plain shunt booster by cutting out the series-coils by means of the short-circuiting switch 4.

CAPACITY OF BOOSTERS

68. The maximum amount of power that a booster has to deliver depends on the circumstances under which it is used. Generally speaking, the voltage generated by a battery booster is comparatively low, while the current capacity must be large. The maximum output, in watts, is obtained by multiplying the maximum number of volts by which the current must be raised or lowered by the maximum current that is likely to pass through the booster. In actual work this maximum demand is made but seldom, and then only for short intervals, so that if a machine of 70 or 80 per cent. of the above capacity is installed, it will be large enough. The amount of current that the booster will probably be called on to handle can only be determined by carefully noting the demand for current from the battery, as indicated by the load line of the station.

Fig. 41 shows a differential battery booster made by the General Electric Company for street-railway work. The differentially wound generator *A* is driven by a direct-coupled, shunt-wound motor *B* which is wound for 500 volts and has a capacity of 150 horsepower; the generator is wound for 115–180 volts and has a maximum output of 115 kilowatts at 525 revolutions per minute. It will be noted that the booster does not differ much in construction from an ordinary compound-wound generator. The commutator is somewhat larger than usual on account of the large current sent through the machine, though the size of the commutator, as compared with the output of the generator, does not in this case appear so excessive as in the case of boosters designed for lower voltage and larger current. On low-voltage boosters it is sometimes necessary to use two commutators, one at each end of the armature, in order to provide sufficient current-carrying capacity. The

two sets of field windings are indicated at *a* and *b*. In order to accommodate the special field windings required for a machine of this kind the field-magnet cores have to be unusually long; this makes the booster field magnet of large diameter as compared with that of the motor.

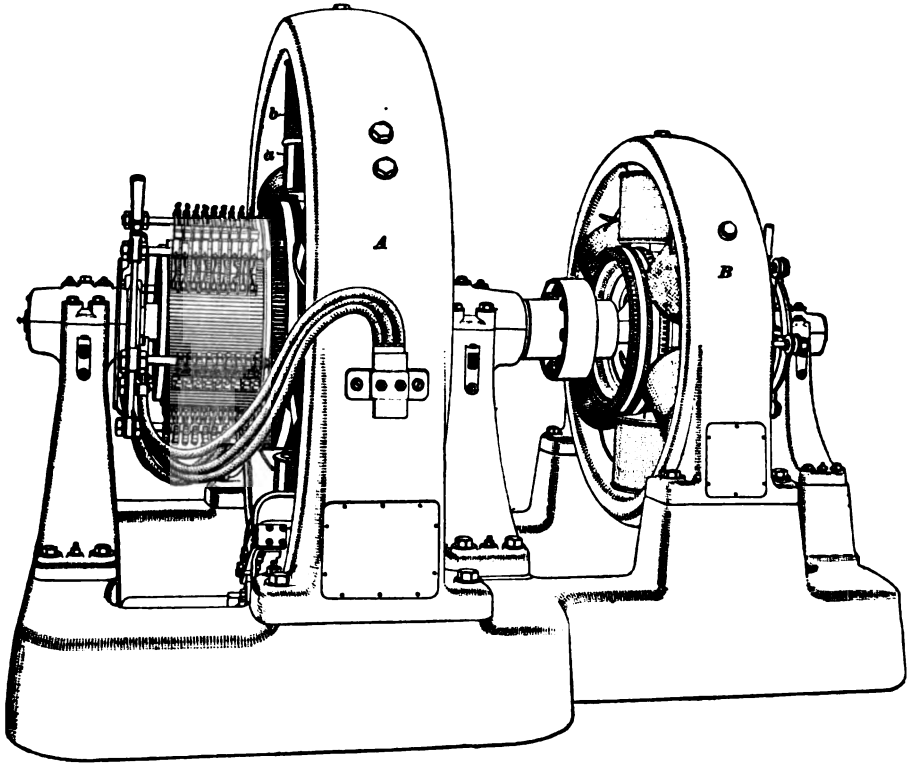

FIG. 41

These descriptions will give a general understanding of the methods used for storage-battery regulation. The conditions under which batteries are used vary so much that the switchboard connections for scarcely any two installations are alike in all particulars. However, if the foregoing methods are kept well in mind there should be little difficulty in tracing out the connections for any particular installation.

GENERAL DATA ON STORAGE CELLS

69. In order to give an idea as to the size, capacity, weight, etc. of storage cells Tables I, II, and III are here given. These tables do not show all the sizes of each type because cells can be made up with almost any number of plates desired. In each table, the first cell of a given type is the smallest size made in that type and the last given is the largest. The number of plates per cell is always an odd number because there is always one less plate in the group of positives than in the group of negatives. For example, a 13-plate cell would be made up of six positives and seven negatives. The capacities of cells with a number of plates different from that shown in the tables can be easily calculated. For example, in Table I, the 9-plate, type F cell has an 8-hour capacity of 40 amperes and a 15-plate cell of the same type has a capacity of 70 amperes. The addition of six plates or three pair of plates increases the capacity 30 amperes; hence, the capacity per pair of plates is 10 amperes. A 27-plate cell has thirteen pair; hence, its capacity is $13 \times 10 = 130$ amperes for 8 hours. In making estimates of the room occupied by a given battery, about $1\frac{1}{2}$ inches clearance should be allowed between glass jars, $2\frac{1}{4}$ inches between metal tanks, and 2 inches between wooden tanks.

TABLE I
GENERAL DATA ON CHLORIDE ACCUMULATORS

Type of Cell	Size of Plates Inches		Number of Plates	Normal Charge Amperes	8-Hour Discharge Rate	Weight of Cell Complete With Acid, Glass Jar Pounds	Weight of Cell Complete With Acid, Metal Tank Pounds	Weight of Cell Complete, Lead- Lined Tank Pounds	Dimensions of Glass Jars Inches			Dimensions of Lead- Lined Tanks Inches			
	Length	Width							Height	Length	Width	Height	Length	Width	Height
C	4 $\frac{1}{2}$ X 4 $\frac{1}{2}$		3	1 $\frac{1}{2}$	1 $\frac{1}{2}$	6 $\frac{1}{2}$ (rubber jar)			3 $\frac{1}{2}$	5 $\frac{1}{2}$	7 $\frac{1}{2}$				
C	4 $\frac{3}{8}$ X 4		5	2 $\frac{1}{2}$	2 $\frac{1}{2}$	10 (rubber jar)			4 $\frac{1}{2}$	5 $\frac{1}{2}$	7 $\frac{1}{2}$				
C	4 $\frac{3}{8}$ X 4		7	3 $\frac{1}{2}$	3 $\frac{1}{2}$	13 (rubber jar)			5 $\frac{1}{2}$	5 $\frac{1}{2}$	7 $\frac{1}{2}$				
D	6 X 6		3	2 $\frac{1}{2}$	2 $\frac{1}{2}$	20			3 $\frac{1}{2}$	7 $\frac{1}{2}$	9 $\frac{1}{2}$				
D	6 X 6		5	5	5	28			4 $\frac{1}{2}$	7 $\frac{1}{2}$	9 $\frac{1}{2}$				
D	6 X 6		7	7 $\frac{1}{2}$	7 $\frac{1}{2}$	38			6 $\frac{1}{2}$	7 $\frac{1}{2}$	9 $\frac{1}{2}$				
D	6 X 6		13	15	15	63			11	8 $\frac{1}{2}$	9 $\frac{1}{2}$				
E	7 $\frac{1}{2}$ X 7 $\frac{1}{2}$		5	10	10	49	85		5 $\frac{1}{2}$	9 $\frac{1}{2}$	11 $\frac{1}{2}$				
E	7 $\frac{1}{2}$ X 7 $\frac{1}{2}$		9	20	20	75	125		8	9 $\frac{1}{2}$	11 $\frac{1}{2}$				
E	7 $\frac{1}{2}$ X 7 $\frac{1}{2}$		15	35	35	115	183		11	9 $\frac{1}{2}$	11 $\frac{1}{2}$				
F	11 X 10 $\frac{1}{2}$		9	40	40	163	239	250	9	12 $\frac{1}{2}$	15 $\frac{1}{2}$		15	18 $\frac{1}{2}$	20 $\frac{1}{2}$
F	11 X 10 $\frac{1}{2}$		15	70	70	246	352	372	12	12 $\frac{1}{2}$	15 $\frac{1}{2}$		15	18 $\frac{1}{2}$	20 $\frac{1}{2}$
F	11 X 10 $\frac{1}{2}$		27	130	130		581	615					13 $\frac{1}{2}$	18 $\frac{1}{2}$	20 $\frac{1}{2}$
G	15 $\frac{1}{2}$ X 15 $\frac{1}{2}$		11	100	100			561					15 $\frac{1}{2}$	19 $\frac{1}{2}$	26
G	15 $\frac{1}{2}$ X 15 $\frac{1}{2}$		25	240	240			1,156					15 $\frac{1}{2}$	20 $\frac{1}{2}$	26 $\frac{1}{2}$
G	15 $\frac{1}{2}$ X 15 $\frac{1}{2}$		55	540	540			2,434					27 $\frac{1}{2}$	21 $\frac{1}{2}$	27 $\frac{1}{2}$
G	15 $\frac{1}{2}$ X 15 $\frac{1}{2}$		75	740	740			3,260					53 $\frac{1}{2}$	21 $\frac{1}{2}$	27 $\frac{1}{2}$
H	15 $\frac{1}{2}$ X 30 $\frac{1}{2}$		21	400	400			1,885					69 $\frac{1}{2}$	25 $\frac{1}{2}$	48 $\frac{1}{2}$
H	15 $\frac{1}{2}$ X 30 $\frac{1}{2}$		41	800	800			3,408					25 $\frac{1}{2}$	21 $\frac{1}{2}$	49 $\frac{1}{2}$
H	15 $\frac{1}{2}$ X 30 $\frac{1}{2}$		75	1,480	1,480			5,986					41 $\frac{1}{2}$	21 $\frac{1}{2}$	49 $\frac{1}{2}$

TABLE II
GENERAL DATA ON GOULD STORAGE CELLS

Type of Cell	Size of Plates Inches	Number of Plates	Normal Charge Amperes	8-Hour Discharge Rate Amperes	Weight of Cell Complete With Acid, Rubber Jar Pounds	Weight of Cell Complete With Lined Tank, Acid, Lead Pounds	Dimensions of Rubber Jar Inches			Dimensions of Glass Jar Inches			Dimensions of Lead-Lined Tank Inches		
							Width	Length	Height	Width	Length	Height	Width	Length	Height
K	3 X 3	3	.75	.63	4.3		2 1/2	3 1/2	5 1/2	4 1/2	5 1/2	11 1/2	15	18	
K	3 X 3	5	1.5	1.25	7.7		3 1/2	4 1/2	5 1/2	4 1/2	5 1/2	16 1/2	15	18	
L	4 X 4	3	1.5	1.25	6.6		2 1/2	4 1/2	6 1/2	5 1/2	6 1/2	16 1/2	20 1/2	27 1/2	
L	4 X 4	7	4.5	3.75	16.6		5 1/2	6 1/2	8 1/2	7 1/2	9 1/2	33 1/2	20 1/2	27 1/2	
M	6 X 6	3	3	2.5	12.8		2 1/2	6 1/2	8 1/2	5 1/2	6 1/2	35 1/2	21 1/2	27 1/2	
M	6 X 6	7	9	7.5	31.2		6 1/2	8 1/2	10 1/2	7 1/2	9 1/2	35 1/2	21 1/2	27 1/2	
M	6 X 6	11	15	12.5	49.9		8 1/2	10 1/2	12 1/2	7 1/2	9 1/2	35 1/2	21 1/2	27 1/2	
N	7 X 7	5	10	10	34.3		4	8 1/2	10 1/2	9 1/2	11 1/2	35 1/2	21 1/2	27 1/2	
N	7 X 7	9	20	20	64.9		7 1/2	10 1/2	12 1/2	9 1/2	11 1/2	35 1/2	21 1/2	27 1/2	
N	7 X 7	13	30	30	104.9		10 1/2	12 1/2	15	11 1/2	13 1/2	35 1/2	21 1/2	27 1/2	
O	10 X 10	5	20	20	95.5		8 1/2	10 1/2	12 1/2	11 1/2	13 1/2	58 1/2	22 1/2	28 1/2	
O	10 X 10	11	50	50	220		10 1/2	12 1/2	15	11 1/2	13 1/2	58 1/2	22 1/2	28 1/2	
O	10 X 10	17	80	80	328		10 1/2	12 1/2	15	11 1/2	13 1/2	58 1/2	22 1/2	28 1/2	
S	15 X 15	5	40	40	337		10 1/2	12 1/2	15	11 1/2	13 1/2	58 1/2	22 1/2	28 1/2	
S	15 X 15	19	180	180	839		10 1/2	12 1/2	15	11 1/2	13 1/2	58 1/2	22 1/2	28 1/2	
S	15 X 15	35	340	340	1,527		10 1/2	12 1/2	15	11 1/2	13 1/2	58 1/2	22 1/2	28 1/2	
S	15 X 15	67	660	660	2,903		10 1/2	12 1/2	15	11 1/2	13 1/2	58 1/2	22 1/2	28 1/2	
L	15 X 31	11	200	200	870		10 1/2	12 1/2	15	11 1/2	13 1/2	58 1/2	22 1/2	28 1/2	
L	15 X 31	53	1,040	1,040	4,064		10 1/2	12 1/2	15	11 1/2	13 1/2	58 1/2	22 1/2	28 1/2	
L	15 X 31	105	2,080	2,080	8,066		10 1/2	12 1/2	15	11 1/2	13 1/2	58 1/2	22 1/2	28 1/2	

TABLE III
GENERAL DATA ON ELECTRIC VEHICLE CELLS

Type of Cell	Size of Plates Inches	Number of Plates	Discharge for 4 Hours Amperes	Weight of Cell Complete With Acid Pounds	Dimensions of Hard-Rubber Jar Inches		
					Width	Length	Height
Exide M V	$5\frac{3}{4} \times 8\frac{3}{8}$	7	21	19 $\frac{1}{2}$	2 $\frac{7}{8}$	6 $\frac{3}{8}$	11 $\frac{1}{2}$
Exide M V	$5\frac{3}{4} \times 8\frac{3}{8}$	9	28	26	3 $\frac{1}{2}$	6 $\frac{3}{8}$	11 $\frac{1}{2}$
Exide M V	$5\frac{3}{4} \times 8\frac{3}{8}$	11	35	32	4 $\frac{1}{2}$	6 $\frac{3}{8}$	11 $\frac{1}{2}$
Exide M V	$5\frac{3}{4} \times 8\frac{3}{8}$	15	49	44 $\frac{1}{2}$	5 $\frac{3}{8}$	6 $\frac{3}{8}$	11 $\frac{1}{2}$
Exide M V	$5\frac{3}{4} \times 8\frac{3}{8}$	19	63	56 $\frac{1}{2}$	7 $\frac{3}{8}$	6 $\frac{1}{2}$	11 $\frac{7}{8}$
Exide P V	$4\frac{1}{2} \times 8\frac{3}{8}$	5	12	12	1 $\frac{3}{8}$	5 $\frac{3}{8}$	11 $\frac{1}{2}$
Exide P V	$4\frac{1}{2} \times 8\frac{3}{8}$	7	18	17 $\frac{1}{2}$	2 $\frac{3}{8}$	5 $\frac{3}{8}$	11 $\frac{1}{2}$
Exide P V	$4\frac{1}{2} \times 8\frac{3}{8}$	11	30	27 $\frac{1}{2}$	4 $\frac{1}{2}$	5 $\frac{3}{8}$	11 $\frac{1}{2}$
Gould E V	$5\frac{7}{8} \times 9$	5	17	20 $\frac{1}{2}$	2 $\frac{1}{2}$	6 $\frac{1}{2}$	11 $\frac{1}{2}$
Gould E V	$5\frac{7}{8} \times 9$	9	33	37	4 $\frac{1}{2}$	6 $\frac{1}{2}$	11 $\frac{1}{2}$
Gould E V	$5\frac{7}{8} \times 9$	15	57 $\frac{1}{2}$	59 $\frac{1}{2}$	7 $\frac{1}{2}$	6 $\frac{1}{2}$	11 $\frac{1}{2}$

INCANDESCENT LIGHTING

(PART 1)

INTRODUCTION

1. The subject of electric lighting involves a consideration of the different methods used for carrying out artificial illumination by means of electrical energy. Thus, not only must the actual means of converting the electrical energy into light be considered, but the methods used for its generation and distribution must also be given due attention. The general subject of electric transmission has already been considered, so that it will only be necessary to take up such features regarding distribution as relate more particularly to lighting work.

2. There are two methods in common use for producing light by means of electricity: (a) By means of *incandescent lamps*, and (b) by means of *arc lamps*. Both methods are extensively used, the arc light being especially adapted for street lighting, although it is largely used for interior lighting as well. The principal field for incandescent lighting is interior illumination, but incandescent lamps are also used for street lighting, especially in places where the streets are thickly shaded by trees, or in cases where a uniform distribution of light is desired.

3. In the incandescent electric lamp, light is produced by bringing a continuous conductor of high resistance to a very high temperature by passing a current through it. If a current is sent through a conductor, there will be a certain loss of energy in the conductor due to the resistance that the

For notice of copyright, see page immediately following the title page

current encounters in flowing through it, and this loss reappears in the form of heat. In the incandescent lamp the heating effect is so intense that it raises the conductor to incandescence and so produces the desired illumination.

4. The illumination produced by the arc lamp is brought about in a different manner. The current is made to pass between two electrodes (usually carbon) that are held a short distance apart. The points of these electrodes become heated to an exceedingly high temperature and a very brilliant light is produced. The arc lamp was first publicly exhibited by Sir Humphry Davy, in London, in the year 1810, when he used a battery of 2,000 cells for its operation; but it did not come into commercial use until a much later period, because current could not be supplied cheaply enough by means of batteries, and the introduction of the light was not accomplished until the dynamo-electric machine had been developed sufficiently to insure the generation of electrical energy at reasonable cost.

5. Arc and incandescent lamps may be operated by means of either alternating current or direct current. Arc lamps have, in the past, been operated principally by direct current, but alternating current is now largely used for this purpose. Incandescent lamps will operate quite as well with alternating as with direct current, provided the frequency is not too low. The heating effect in a conductor is independent of the direction in which the current flows; hence, an alternating current, which periodically reverses its direction of flow, will operate an incandescent lamp just as well as direct current. The reversals of the current are so rapid that the conductor in the lamp does not have time to cool off perceptibly, and hence there is no flickering noticeable to the eye. If, however, a frequency below 30 cycles per second is used, the lamps are apt to flicker, and if alternating current is to be used for incandescent lighting work, the frequency should not be below this value.

6. In taking up the subject of electric lighting, there will then be the four following divisions to consider:

1. Incandescent lighting by direct current.
2. Incandescent lighting by alternating current.
3. Arc lighting by direct current.
4. Arc lighting by alternating current.

These main divisions of the subject cover broadly the numerous systems in common use; they may be still further subdivided, but the various modifications will be taken up when each of the above divisions is considered by itself.

INCANDESCENT LIGHTING

THE INCANDESCENT LAMP

7. The incandescent lamp is naturally the first thing to be considered in connection with the subject of incandescent lighting, as it is by means of this lamp that the electric energy is made to furnish the required illumination. Fig. 1 shows a typical incandescent lamp with which every one is familiar.

In order that the lighting service supplied from an incandescent plant shall be satisfactory, it is highly important that the lamps be efficient. If poor lamps are used, or if the lamps are burned beyond their useful life, poor service will result, no matter how efficient the system may be in other respects. It is useless to install the best generating machinery available and then expect to give a good service with old or cheap lamps that soon run down in candlepower. Central-station managers are coming to realize this point more than was once the case, and are devoting more attention to the quality of the lamps that they buy; in fact, most progressive companies now provide means for testing their lamps.

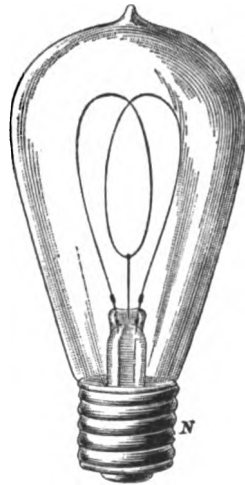

FIG. 1

CONSTRUCTION OF LAMPS

8. Early Experiments.—It was not long after the invention of the arc lamp until inventors turned their attention to the production of electric light by heating continuous conductors to a high temperature by means of the current, instead of using the arc, because the early forms of arc lamps were not well suited to interior illumination. The first experiments were made with platinum or iridium wire. These wires were mounted in the open air and current sent through them, the current bringing the wire to a white heat and thus causing light to be given off. All these lamps proved failures because the wire very soon burned out. The temperature to which it had to be raised was very near the melting point of the metal, and if great care were not exercised the wire would fuse. In later experiments, the wire was enclosed in a glass globe from which the air was exhausted. This was a great step in advance, because it prevented the conductor from becoming oxidized and thus destroyed by the action of the air; it also prevented the wire from cooling so fast, and thus allowed the high temperature to be maintained by a much smaller current than would be required were the wire heated in the open air. Even when the platinum or iridium wire was enclosed in a globe from which the air had been exhausted, it was found that, although the lamps were very much improved, they were not suitable for commercial use. It became evident that some substance that would be cheaper and capable of standing a higher temperature would be necessary. Carbon was finally selected as the substance most suitable and is now universally used.

9. Filaments.—Edison tried a great many experiments to determine the best substance for the conductor, or filament, as it is usually called. The material that he finally selected was bamboo fiber, which was cut to the proper size and then carbonized. Maxim made lamps with filaments of carbonized paper. These lamps embodied all the essential parts contained in the modern lamp shown

in Fig. 1, but lamps as now made are very much improved in efficiency and are decidedly cheaper. Fig. 2 shows the general shape of one of the early bamboo filaments. The ends *a, a* were enlarged so that the heating at the joint between the leading-in wires and the filament was much less than that of the filament proper. Lamp filaments as now made are usually in the forms shown in Fig. 3 (*a*), (*b*), and (*c*). (*a*) is the plain loop filament, (*b*) the spiral, and (*c*) the oval. In Fig. 3 (*c*), the filament is fastened at *x* to a small iron or nickel wire fused into the glass, and is called an *anchored filament*. This is done to prevent violent vibrations of the filament, which would tend to shorten the

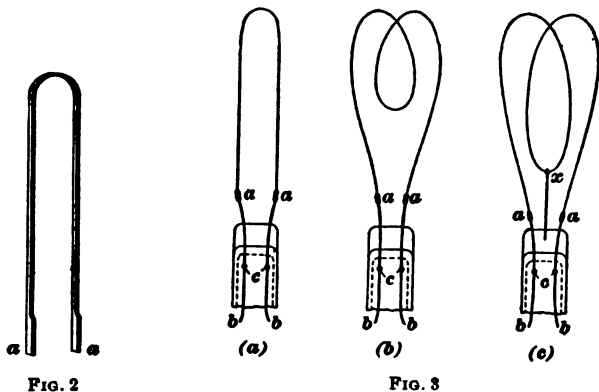

FIG. 2

FIG. 3

life of the lamp, and lamps of this type should be used in any place where they are subjected to vibration, as, for example, on street cars.

10. Filaments have been made of carbonized silk or cotton thread, but the usual method of manufacture at present is by the so-called *squirting process*. The raw material of which the filaments are made is usually a fine grade of cotton, though filter paper is sometimes used. This is dissolved in a strong solution of zinc chloride made acid by the addition of hydrochloric acid; the solution digests the cotton, at first producing a jelly-like substance and finally a complete solution. While hot, the solution is filtered and subjected to

a vacuum treatment to remove all traces of air. The mixture is then forced through small holes, or dies, and thus squirted into the form of threads which, as they emerge from the dies, run into jars containing wood alcohol; the alcohol hardens the squirted thread, which coils up in the bottom of the jars. When a jar is full, the alcohol is removed and the white cellulose thread washed thoroughly for several hours to remove all traces of zinc chloride, after which the thread is wound on drums and dried. In the drying process the thread shrinks greatly; if squirted through a .023-inch hole, it will shrink to about .008 inch. The carbonized filaments are made by winding bunches of the dried thread on carbon forms, which are then bedded in charcoal or graphite in a crucible and subjected to a high temperature for several hours. During the carbonizing process there is a further shrinkage, the diameter being reduced to about .0035 inch.

After carbonization, the filaments vary more or less in diameter and they are sorted into lots having like diameters before being subjected to the *treating*, or *flashing process*, which is carried out as follows: After having been cut to the proper length, the filaments are held in suitable clamps in an air-tight receptacle from which the air has been exhausted, and a thin vapor of gasoline substituted. Sufficient current is then passed through the filaments to bring them to incandescence, thus decomposing the gasoline vapor and causing a dense layer of carbon, in a form similar to graphite, to be deposited on the filament. This deposit greatly lowers the resistance, and when the proper resistance is attained the current is cut off automatically; uniformity of resistance is thus secured. With the older styles of filament made from bamboo or thread, the object of flashing was to even up thin places and make the filaments uniform. Thus, thin parts of the filament would become more highly heated than the parts of lower resistance and there would be a greater deposit of carbon on the hotter parts. In squirted filaments, the flashing is not necessary so far as securing a uniform cross-section is concerned, but it is found that the layer of dense graphitic carbon greatly strengthens the filament and results

in a longer-lived lamp. Also, heat is not so readily radiated from this dense outer layer as from an untreated filament, consequently a smaller current is sufficient to maintain the treated filament in a state of incandescence and the flashing results in an increase in efficiency. It is this layer of graphitic carbon that gives the filaments their familiar steel-like appearance.

11. The size of the filament depends altogether on the candlepower of the lamp and the voltage and current with which it is to be supplied. The lamp shown in Fig. 1 is one of 16 candlepower, such as would ordinarily be used on a 110-volt circuit. Such a lamp would require about $\frac{1}{2}$ ampere; hence, from Ohm's law, its resistance when hot must be in the neighborhood of 220 ohms. In order to get this high resistance, the filament must be long and fine. Lamps designed for low voltage and large current would be provided with short, thick filaments. Fig. 4 shows a low-voltage lamp designed to take about $3\frac{1}{2}$ amperes. In this case the filament is short and correspondingly thick.

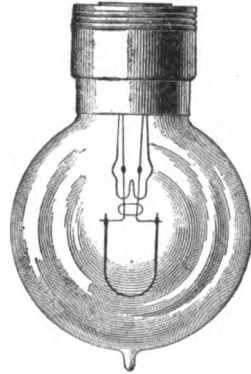

FIG. 4

Fig. 3 shows the way in which the filament is usually mounted; it is fastened to the platinum wires *a, a*, which are sealed into the glass and thus render the globe air-tight. The junction between the filament and the leading-in wire is effected by means of carbon paste; this paste also enlarges the cross-section of the joint, so that the heating is small compared with that which takes place in the filament itself, and the leading-in wires are therefore kept cool.

12. **The Leading-In Wires.**—These are made of platinum, because this metal has almost exactly the same coefficient of expansion as glass, and also because it does not oxidize. If the glass and platinum did not expand at the same rate when heated, cracks would form at the point

where the wires are sealed into the glass. This would let in the air and the filament would soon burn out. A film of oxide on the leading-in wires would also tend to let air leak into the globe, and platinum does not oxidize. Only enough platinum is used to pass through the glass, as shown at *a, a*, Fig. 3. Connection is made to the base by means of small copper wires *b, b* fused to the platinum at *c, c*. In early lamps, the whole length of the leading-in wires was of platinum, but this is unnecessary and the practice was soon discontinued, owing to the high price of the metal. Substitutes for platinum for the leading-in wires have been brought out from time to time, but none of them have displaced it as yet.

13. The Bulb.—The style of bulb used to enclose the filament is familiar to almost everybody. Different shapes are in use, but by far the most common is the pear-shaped bulb shown in Fig. 1. Bulbs should not be made too small, because, as the lamp burns, the filament gradually undergoes disintegration and small particles of carbon are thrown off and deposited on the globe. This causes the well-known blackening of the lamp, and if the bulb is very small the blackening is aggravated, because the surface is smaller and the deposit, for that reason, more dense.

14. Exhaustion.—Fig. 5 shows a lamp after the stem carrying the filament and the leading-in wires have been sealed into the bottom. The lamp is now ready to be exhausted. In order to accomplish this, the bulb is first *tubulated*, i. e., a small glass tube with a narrow neck at *a* is sealed into the top of the bulb.

Numerous methods have been devised for the exhaustion of lamps. Ordinary mechanical air pumps, those that exhaust the air by the operation of a plunger in conjunction with valves, are not capable of producing a sufficiently high degree of exhaustion. Mercurial air pumps were formerly used for the purpose, but have been superseded by the so-called chemical method, which is very much quicker. In this process a finely constructed mechanical air pump is

used to exhaust the greater part of the air and the remaining oxygen is then removed by introducing a chemical that will combine with it and render it incapable of oxidizing the filament. In the pump used for this purpose the valves and piston work in heavy oil, which forms a seal and permits a rather high degree of exhaustion to be obtained. A small quantity of red phosphorus is painted in the "tubulation" before the lamp is connected to the pump. A few seconds suffice to obtain a fairly good vacuum and current is sent through the lamp. The filament is burned at a very high temperature, thus driving off air from the filament, carbon paste, and inside surface of the bulb. A bluish mist fills the lamp, and when this appears a gas flame is applied to the part of the tubulation painted with the red phosphorus, thus converting some of it into active phosphorus, which combines with the remaining oxygen in the bulb forming phosphoric anhydride—a solid. The instant this combination takes place the blue mist vanishes and the operator at once "seals off" the bulb by heating the contraction *a*, Fig. 5, in the glass tube, thus forming the tip on the lamp. The vacuum is tested by holding the lamp by the bulb and touching the terminal wires to one terminal of an induction coil. If the vacuum is perfect, no glow will be observed in the bulb; if the vacuum is poor, a bluish glow will appear.

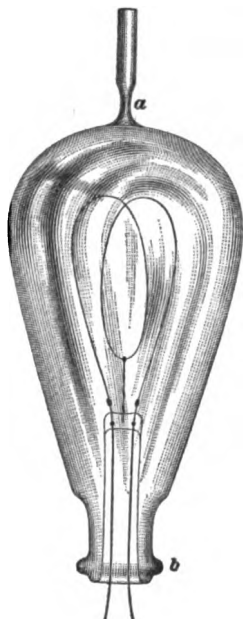

FIG. 5

15. Bases.—After the lamp has been exhausted, it is complete with the exception of the base *N*, Fig. 1, with which it must be provided in order that it may be readily attached to the socket. These bases are usually made of brass and porcelain, the lamp being held in them by a setting of plaster of Paris or cement.

In Fig. 5, the lower part of the lamp is made of such shape that the base will be held securely when the plaster of Paris is put in place. The rib *b* prevents the base from pulling off. The base must, of course, provide two terminals for the leads from the filament, these terminals being arranged so that when the lamp is placed in the socket contact will be made with two corresponding terminals. There are three different bases commonly used in America; these are the *Edison*; the *Thomson-Houston*, or *T. H.*, as it is more commonly called; and the *Westinghouse*, or *Sawyer-Man*.

Fig. 6 (*a*) shows the *Edison* base, of which there are more in use than all the others put together. One end of the filament is attached to the outer shell *t'*, which is provided with a coarse screw thread. The other terminal is

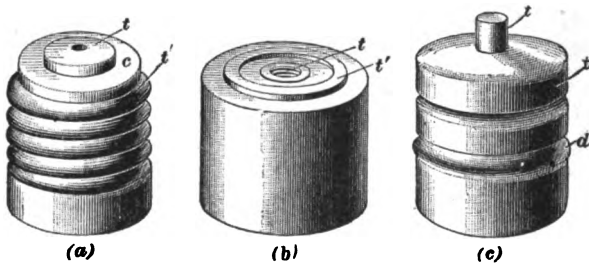

FIG. 6

connected to the projecting centerpiece *t*, the two brass pieces being separated by means of a porcelain piece *c*. When the lamp is screwed into the socket, the screw shell makes one connection and the centerpiece the other. Fig. 7 shows a lamp screwed into an ordinary Edison key socket.

Fig. 6 (*b*) shows the *T. H.* base, so called because it was brought out by the Thomson-Houston Company. In this base, one terminal is connected to a brass centerpiece *t* in which a hole is drilled and tapped. The other terminal is connected to the brass ring *t'*. This base has the advantage that the outer shell, if one is used, is in no way connected to the circuit, and there is therefore less danger of receiving a shock by touching the lamp; it has been, and

still is, used to a considerable extent, though it is gradually going out of use, as it is more expensive to make than the Edison base. It works loose in the socket a little more easily than the Edison base when the lamp is subjected to vibration. When placed in the socket, terminal *t* screws on a projecting stud, thus making one connection; the other connection is made by the ring *t'* coming into contact with a corresponding ring or terminal in the socket. The later types of T. H. base are made of porcelain with a brass center-piece and outside ring, as described above.

Fig. 6 (c) shows the **Westinghouse** or **Sawyer-Man base**, as it is sometimes called, because it was originally brought out by The Sawyer-Man Company. This base is similar in some respects to the Edison, but the outer shell is not threaded; the lamp is pushed into the socket, the outer shell slipping into a split bushing that is provided with an annular groove. The rib *d* slips into this groove when the lamp is in position and prevents the lamp slipping out. The other connection is

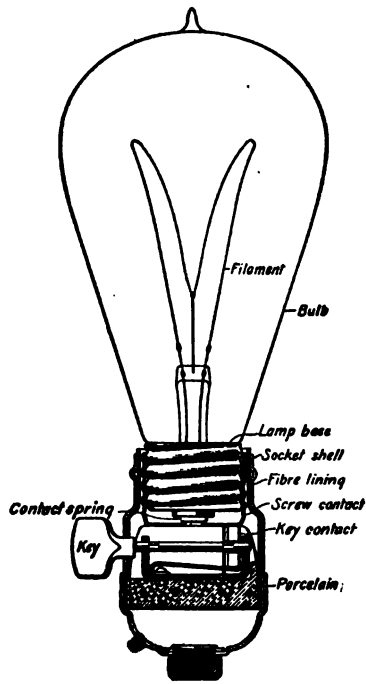

FIG. 7

made by the projecting pin *t* coming into contact with a spring in the socket. This base has the fault that it sometimes allows the lamp to drop out of the socket if the split bushing does not grip the rib *d* properly. It also makes comparatively poor contacts, which become worse with use.

16. When incandescent lamps were first brought into use on a commercial scale, each different maker had his

own style of lamp base, and the result was that over a dozen different types were in use. The number has, however, been gradually reduced until the three mentioned above probably include over 99 per cent. of all the bases in use in America. The chances are that in a few years the Edison base will have replaced the others, because, taking everything into consideration, it is the best base of the three. Even plants that are equipped with sockets of other makes are fitting them with adapters so that they may be able to use Edison base lamps.



FIG. 8

Fig. 8 shows an adapter for changing T. H. sockets to take lamps with the Edison base.

MEASUREMENTS AND LAMP CALCULATIONS

LIGHT MEASUREMENTS

17. Incandescent lamps are usually designated by their candlepower. For example, a lamp is spoken of as giving 16 candlepower when it produces an intensity of light equal to that produced by 16 standard candles.

The unit of light intensity commonly used is a spermaceti candle of standard dimensions. Standard candles are .9 inch in diameter at the base, .8 inch in diameter at the top, and 10 inches long; they burn 120 grains of spermaceti and wick combined, per hour. Six candles weigh 1 pound. The candle is not a very satisfactory standard, as it is subject to considerable variation, and other standards have been brought out to replace the candle in practical work. Various kinds of gas and oil lamps have been used for this purpose, which, although less liable to fluctuations than the candle, have not yet superseded it.

18. The **Methven screen** is a convenient standard that has been largely used. It consists of an Argand gas burner provided with a screen that cuts off all the light from the

flame except a small portion that is allowed to come through a thin-edged standard opening in the screen. The size of the opening is .233 inch wide and 1 inch long. The height of the flame is 3 inches and the screen is placed $1\frac{1}{2}$ inches from the axis of the flame. The light given by a standard of this kind will vary considerably with the quality of the gas used, and while it may not be reliable as an absolute standard, it makes a very good working standard after its candlepower is known by comparing it with a standard candle. A slit of the above size should emit about 2 candlepower.

19. One of the best light standards is the **amyl acetate, or Hefner, unit**. This lamp consists of a small reservoir provided with a wick tube of standard size. The lamp burns amyl acetate and the flame is adjusted until its tip is 40 millimeters above the top of the wick tube. This standard is very reliable and is subject to little variation, but it has the disadvantage of giving a light of reddish tinge. The Hefner unit is not quite as large a unit of light as the English candle, the relation being 1 candle = 1.136 Hefner units.

20. For photometric tests connected with electric-light stations, neither the candle nor the amyl acetate lamp is used as a working standard. The general practice is to standardize either an incandescent lamp or an oil lamp by comparing it with a standardized lamp such as can be obtained from lamp manufacturers and which is known to give a certain number of candlepower when operated at a specified voltage. A secondary standard of this kind is very much easier to work with and cheaper to operate than either a standard candle or amyl acetate lamp. In order to determine the candlepower of an incandescent lamp, there must be some means of comparing the intensity of illumination produced by the lamp with that produced by the standard. An instrument for doing this is called a **photometer**.

21. **Law of the Photometer.**—Suppose a candle is placed at *A*, Fig. 9, and a screen *B* held at a distance of, say, 2 feet from it. The screens are here shown bent so as

to represent portions of spherical surfaces with A at the center. Consider the portion $abcd$ of the screen B . The intensity of illumination on the area $abcd$ will be a certain amount. Now, suppose the screen to be moved back to the position C , 4 feet from A . The total amount of light that fell on the area $abcd$ will now be distributed over the area $a'b'c'd'$. The area $a'b'c'd'$ is four times that of $abcd$, because Am is twice Af and, consequently, mh is twice fg , or $b'c'$ is twice bc . The total quantity of light falling on the two surfaces is the same, and since the area of $a'b'c'd'$ is four times that of $abcd$, it follows that the light per unit

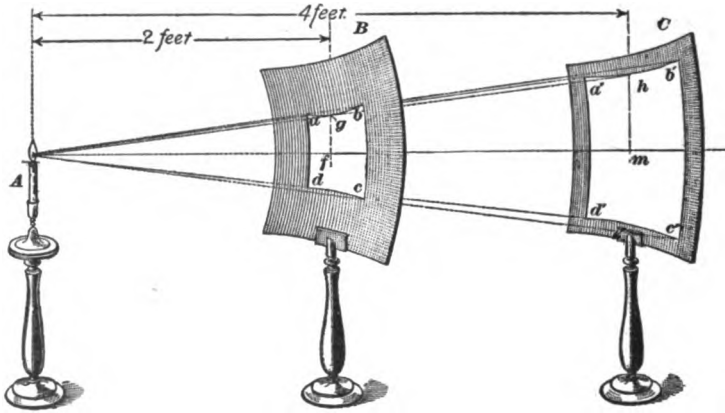

FIG. 9

area or the intensity of illumination on $a'b'c'd'$ is only one-quarter that on $abcd$. Doubling the distance of the screen from the source has cut down the intensity of illumination to one-fourth its former value. If the distance Am were three times as great as Af , the intensity of illumination would be one-ninth that on $abcd$. This law may then be stated as follows:

The intensity of illumination produced by a source of light on any object varies inversely as the square of the distance of the object from the source.

If x is the illumination produced, B the candlepower of the source of light, and d the distance, then

$$x = \frac{B}{d^2} \quad (1)$$

22. Elementary Photometer.—Suppose that the brightness of two sources of light, such, for example, as a candle and an incandescent lamp, are to be compared. If the candle *A* and the lamp *B* are placed in a dark room, so that there will be no other light to interfere, and a screen *C* is placed between them, as shown in Fig. 10, one side of the screen will be illuminated by the candle and the other by the lamp. If the candle and lamp are exactly of the same brightness, the two sides of the screen will be equally illuminated when placed midway between the sources

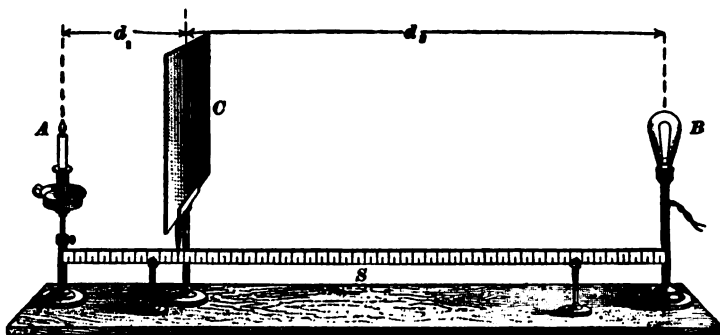

FIG. 10

of light; and if the screen is mounted so that it can be slid along between the lights, a point can always be found where the screen will be equally illuminated on both sides. In the present case, the screen would have to be moved nearer the candle than the lamp, because the candle is not so bright as the lamp. Suppose that the screen has been adjusted so that the illuminations are equal on each side, and that the distances d_1 and d_2 have been read off by means of the scale *S*, d_1 being the distance from the screen to the standard candle and d_2 the distance from the screen to the light that is being measured.

Let x_1 be the illumination produced on one side, x_2 that on the other, and B_1 and B_2 the candlepowers of the

standard and the light being measured, respectively. Then, from formula 1, $x_1 = \frac{B_1}{d_1^2}$, and $x_2 = \frac{B_2}{d_2^2}$, but, since the illuminations on the two sides are equal, $\frac{B_1}{d_1^2} = \frac{B_2}{d_2^2}$.

Now, the candlepower B_1 of the standard is supposed to be known, and since the distances are also known, the candlepower B_2 of the lamp being measured can at once be calculated. For this purpose, it is more convenient to have the last equation in the form

$$B_2 = B_1 \frac{d_1^2}{d_2^2} \quad (2)$$

23. The arrangement shown in Fig. 10 is a simple form of photometer, and formula 2 expresses the relation between the candlepower of the standard and that of the lamp being measured. This may be written in the form of a rule, as follows:

Rule.—*The candlepower of the lamp being tested on a photometer is found by multiplying the candlepower of the standard by the quotient obtained by dividing the square of the distance of the lamp from the screen by the square of the distance of the standard from the screen.*

EXAMPLE.—Suppose, in Fig. 10, that A is a standard candle giving 1 candlepower and that B is an incandescent lamp. The screen is moved until a point is found where the two sides are equally illuminated. The reading on the scale then shows that the distance from the standard is 20 inches. The total distance between the lamps is 100 inches. What is the candlepower of B ?

SOLUTION.—If the total length of the photometer is 100 in., the distance from the lamp to the screen must be $100 - 20 = 80$ in. The candlepower of the standard is 1; hence, substituting in formula 2,

$$B_2 = 1 \times \frac{80^2}{20^2} = 16 \text{ c. p. Ans.}$$

24. Bunsen Photometer.—The Bunsen photometer has been more largely used than any other. It is very simple and is capable of giving good results if used properly. The arrangement of the different parts is essentially the same as that shown in Fig. 10, but the distinguishing feature lies

in the style of screen used. It would be a difficult matter to tell when a simple screen like that shown in Fig. 10 is illuminated equally on both sides, and to overcome this difficulty Professor Bunsen devised the screen shown in Fig. 11. It is made by taking a piece of good quality of white paper and making a grease spot in its center, as indicated by the star in Fig. 11. If such a screen is held so that the front side is more strongly illuminated than the back, the grease spot will appear dark on the white ground of the

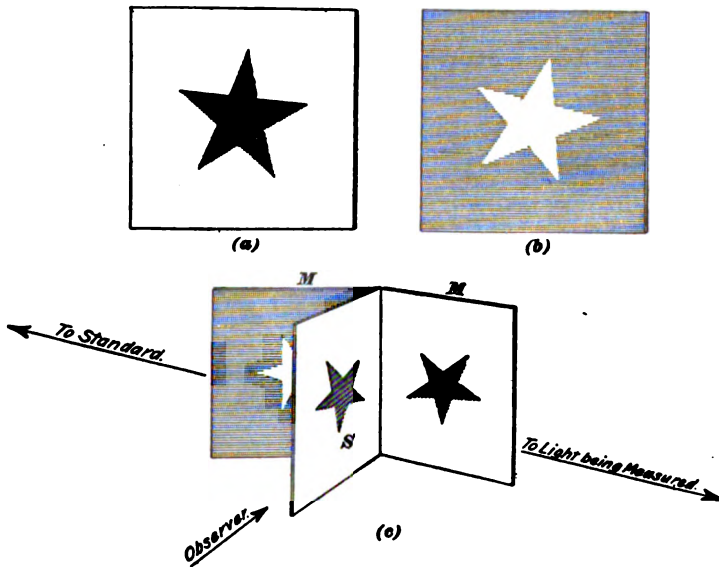

FIG. 11

paper, as shown in (a). If, however, the screen is more brightly illuminated on the back side, as, for example, if it is held between the eye and a window, the grease spot will appear light on a dark ground, as shown in (b). If such a screen is mounted in place of the screen C in Fig. 10, and arranged so that both sides can be seen at once, the grease spot will disappear almost entirely when the two sides of the screen are equally illuminated. In order to facilitate the observation of the screen, it is usually arranged

with two mirrors mounted at a slight angle to it, as shown at M, M in (*c*). S is the screen with the grease spot, and the observer looks at the reflection of the two sides of the screen in the mirrors instead of the screen itself. The screen and the mirrors are mounted in a box, which is open at the ends to admit the light from the sources and which is also provided with an opening in the front to enable the observer to see the reflections of the screen.

25. Fig. 12 shows the arrangement of the parts of a simple photometer of the Bunsen type designed by Elmer G. Willyoung for use in connection with lighting stations. A , the standard—in this case an incandescent lamp of accurately known candlepower—and B , the light to be measured; D is the bar on which the carriage containing the screen slides; the part D is usually spoken of as the **photometer bar**. E is the carriage containing the Bunsen screen. The motor F is used to spin the lamp B while measurements are being made; the reason for doing this will be explained later. G and H are two adjustable resistances for keeping the voltage applied to the lamps at the proper value.

26. Fig. 13 shows a Deshler-McAllister photometer—a simple instrument that has been quite largely used in lighting stations for testing the light-giving qualities of the lamps they are using. The principal difference between this instrument and the one previously described is that an oil lamp A is used as a working standard instead of an incandescent lamp. The bar is also provided with a scale reading directly in candlepower, though the Willyoung instrument could also be provided with a direct-reading scale, if desired. One objection to using an incandescent lamp as a light standard is that its voltage must be constantly watched and kept at the proper amount. It is largely to get around this difficulty that the oil lamp is used. This is an ordinary lamp provided with a double wick and an adjustable screen S , by means of which the upper and lower ragged edges of the flame are cut off. K, K are standard incandescent lamps that have been accurately calibrated at the lamp factory and

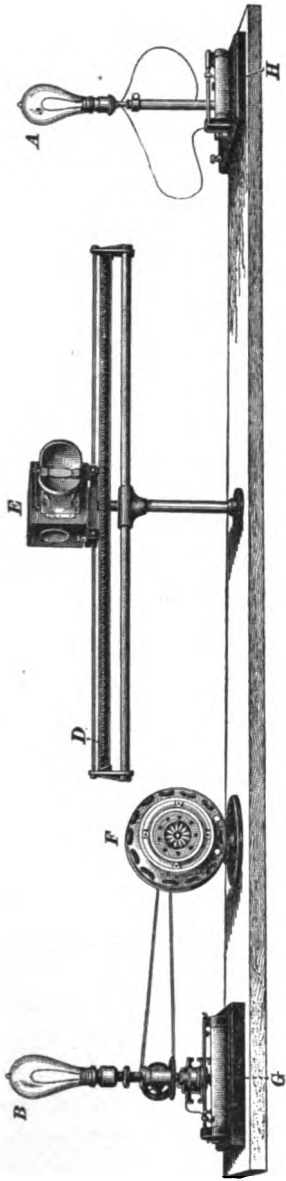

FIG. 12

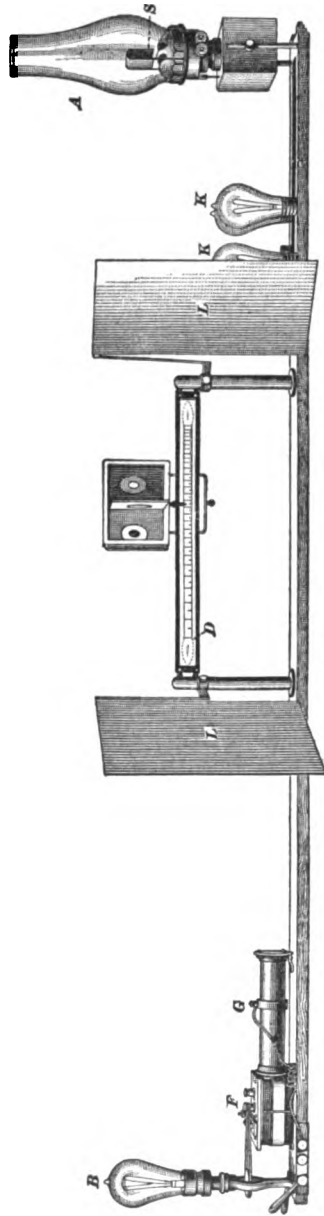

FIG. 13

of which the candlepower, at the voltage marked on them, is known. Each of these standard lamps, in succession, is placed at *B* and the pointer of the carriage set at the point on the bar corresponding to the candlepower marked on the lamp. The voltage at the lamp is then adjusted by means of the rheostat *G* until it corresponds exactly with that marked. When this has been done, the screen *S* in front of the flame of *A* is adjusted until the grease spot is balanced. The lamp *A* is then of the same candlepower as the standard and may be used for the measurement of other lamps, since after it is once adjusted it is not likely to change, though it should be checked up now and then to make sure that it does not do so. The object in having a number of standard lamps *K, K* instead of one only is to have a check against any errors that might be caused by changes in the lamps. Screens *L, L* are provided to cut off the light from the observer's eyes and a motor *F* is used to rotate the lamp. These station photometers are not expensive, and if properly used are of great value in detecting poor lamps.

27. After a person has become accustomed to the photometer, good results can be obtained provided the following conditions are fulfilled:

1. The lights, both the standard and the light being measured, should be steady.
2. The standard and the light being measured should be of approximately the same color.
3. The brightness of the light being measured and that of the standard should not differ to an extreme degree; for example, good results could not be expected if an attempt were made to compare an arc lamp with a candle.

Most ordinary photometer bars are fitted with a scale divided into equal divisions, as shown in Fig. 10, so that the distances may be read off and the candlepower calculated from these distances and the known candlepower of the standard. If the standard used is always of the same value, it is evident that the bar might be graduated to read directly in candlepower, as in the photometer shown in Fig. 13.

Where many lamps are to be tested, this can usually be done, as the same standard can be used all the time and readings taken rapidly from the bar as soon as the setting of the screen is made. Many modifications of the photometer have been made, but the above will give a general idea of the principles involved and of some of the forms especially useful in connection with electric-light stations.

LIGHT DISTRIBUTION

28. Mean Horizontal Candlepower.—If an incandescent lamp is set on a photometer and its candlepower measured, it will be found that different values for the candlepower are obtained, depending on the position of the lamp and the shape of the filament. For example, in Fig. 14 the brightness of the lamp in the different horizontal directions 1, 2, 3, 4, etc. would not be the same. The candlepower given out in the different horizontal directions along any line, such as those shown in Fig. 14, is known as the **horizontal candlepower** for that position. The mean or

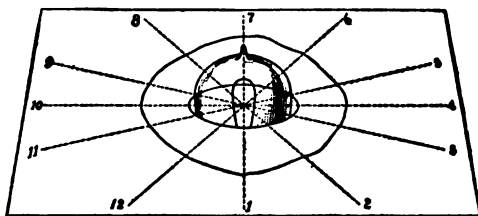

FIG. 14

average horizontal candlepower is the average value of these different readings and is frequently obtained by taking the reading from the lamp while it is rapidly revolved about its vertical axis. The photometers just described are arranged so that the lamp can be revolved at the rate of about 180 revolutions per minute, thus giving the average, or mean, horizontal candlepower. The horizontal candlepower does not vary greatly in different directions with lamps as now constructed. This is shown by the irregular curve, Fig. 14. The distance of the points on this curve from

the center represents the candlepower in the direction of the radius from that point, and if the candlepower were the same in all directions, the curve would become a circle.

29. Vertical Distribution.—Fig. 15 shows the readings for the candlepower obtained in a vertical plane with the filament in the position shown. Viewed from position 1, the candlepower is practically zero, because the light is almost completely cut off by the base of the lamp. At points 2 and 4 it is a maximum, because viewed from these points the maximum amount of the filament is seen. At point 3 the candlepower again drops off, because here the filament is seen end on. The curve of horizontal distribu-

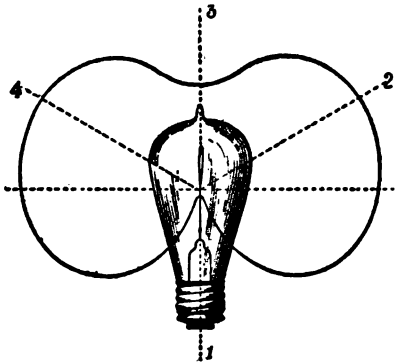

FIG. 15

tion gives an idea as to how the lamp throws light in a horizontal plane, and the curve of vertical distribution shows how the lamp behaves as to throwing the light up or down. In speaking of the candlepower of an incandescent lamp, the mean horizontal candlepower is usually meant, and this is most readily obtained by spinning

the lamp as described above. In many cases, however, it is customary to measure the candlepower in one direction only, and the error in doing so is not usually very great, because filaments are nearly always twisted and the candlepower does not vary greatly when the lamp is viewed from different directions. In case the lamp is not revolved when measurements are being taken, it should be adjusted with the plane of its filament at such an angle to the photometer bar as will give the mean candlepower. For example, in Fig. 16, suppose that AB represents the axis of the bar and that we are looking down on the top of the lamp. The line CD will indicate the relative position of

the plane of the filament. The angle α at which the filament should be inclined will depend on the style of filament used. For plain loop filaments it should be about 60° and for spiral filaments 30° .

30. Mean Spherical Candlepower.—If a lamp is hung so that it can be viewed from any direction, it is clear that if viewed from any number of different points a corresponding number of different values for the candlepower will be obtained. If several readings are taken at regular intervals and averaged, the **mean spherical candlepower** of the lamp will be obtained. In other words, the mean spherical candlepower represents that intensity of illumination to which the irregular illumination of the lamp would be equivalent if it were an average candlepower given

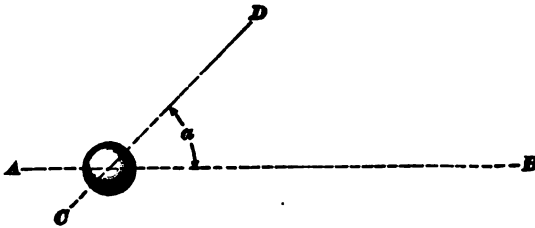

FIG. 16

out uniformly *in all directions*. The mean hemispherical candlepower is the average of the candlepowers taken over a hemisphere. When a lamp is provided with a shade or a reflector, nearly all the light is thrown down and the mean candlepower for the lower hemisphere is made greater than the mean spherical candlepower for the lamp without a reflector. In connection with commercial measurements on incandescent lamps, the mean spherical candlepower is not used to any great extent. It is used more in connection with arc lamps. One arc lamp may give a widely different spherical distribution from another, and in comparing such lamps the mean spherical candlepower forms the fairest basis of comparison. Incandescent lamps are made in a variety of sizes, the most common candlepowers being

4, 8, 10, 16, 20, 32, 50, and 100. The 16-candlepower lamp is the one most generally used. Small lamps of $\frac{1}{4}$, 1, and 2 candlepower are also used for decorative and advertising purposes.

PROPERTIES OF INCANDESCENT LAMPS

31. Temperature.—The temperature at which the filament of a lamp is worked may be anywhere from $1,800^{\circ}$ to $1,950^{\circ}$ C. The hotter the filament, the greater is its light-giving power per watt consumed. Of course, it is desirable to operate a lamp so that it will give a large amount of light per watt, provided this can be done without injuring the lamp. At a temperature of about $1,900^{\circ}$, an ordinary lamp will give about $\frac{1}{2}$ candlepower per watt; a 16-candlepower lamp would at this rate take 48 watts, or 3 watts per candle. At a temperature of $1,800^{\circ}$, the same lamp might give about $\frac{1}{4}$ candlepower per watt and thus require 64 watts for its operation. Although it is thus advantageous, as far as power consumption goes, to work the lamp at a high temperature, it is found that if the temperature is pushed too high, the life of the lamp is greatly shortened. On the other hand, if the lamp is worked at a very low temperature, it gives a small amount of light compared with the power consumed, and although its life may be long, it is not satisfactory as a light-giving source.

32. Efficiency.—When the efficiency of an incandescent lamp or arc lamp is spoken of, the power consumption per candlepower is meant. For example, if an incandescent lamp required 3.5 watts for each mean horizontal candlepower, its efficiency would be 3.5, or it would be spoken of as a 3.5-watt lamp. This is not a very satisfactory method of expressing efficiency, because, according to this, the larger the power consumption per candlepower, the greater is the efficiency; while in point of fact just the reverse is the case. A much better way to give the efficiency would be to express it as so many candlepower per watt, and in some cases it is expressed this way. Evidently, the greater the number of

candlepower per watt consumed, the greater is the efficiency. At present, however, efficiency is nearly always expressed as so many watts per candle. The power consumption per candlepower varies considerably. If the filament is worked at a high temperature, 1 candlepower may be obtained for every 2.75 watts expended, or even less, but such lamps are apt to have a short life and, in any event, require very steady voltage regulation. In ordinary work, lamps give about .3 candlepower per watt, i. e., they require about 3.33 watts per candlepower. This is a fair value for the power consumption of an ordinary lamp. A lamp may take as low as 3 or 3.1 watts per candlepower when first installed, but its light-giving properties fall off after it has been in operation for a time and the power consumption may run up as high as 3.8 or even 4 watts per candle. From 3.3 to 3.5 watts per candlepower is therefore a fair average. High-voltage lamps (220 volt) have a somewhat lower efficiency ranging from 4 to 4.2 watts per candlepower.

33. Connections for Testing.—When testing lamps, a careful record should be kept of the length of time they have burned, also of the voltage and current. With this data at hand, together, of course, with the readings of candlepower as given by the photometer, the efficiency of the lamp at any time during the test may be at once determined. Accurate instruments must be used, and their scales should be so divided that the ammeter or mil-ammeter may be read to $\frac{1}{1000}$ ampere and the voltmeter to $\frac{1}{10}$ volt. A variable resistance should also be inserted in series with the lamp so that the voltage across the lamp terminals may be kept nearly constant.

34. Fig. 17 shows an arrangement of connections for lamp testing. Switch 1 short-circuits the current coil of the wattmeter and switch 2, the ammeter. The adjustable resistance allows the pressure to be maintained at the rated voltage of the lamp under test. In Fig. 17, a wattmeter is shown in addition to the ammeter and voltmeter, though it is not essential because the watts can be easily calculated from the

voltage and current readings. A good ammeter and voltmeter are to be preferred to a wattmeter for this kind of work, as the results are more likely to be accurate. Direct current should, if possible, be used for all testing, as alternating-current instruments are more likely to lead to inaccurate results. Current supplied from a direct-current dynamo running at constant speed may be used, but it is more satisfactory to use a storage battery as the source of supply, as the current from it is perfectly steady. Readings of candlepower, current, and voltage should be taken as nearly simultaneously as possible. When the

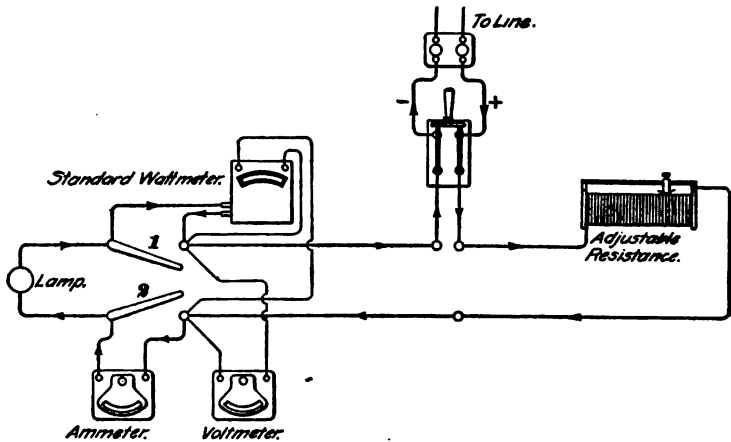

FIG. 17

standard is an incandescent lamp, it is advisable to supply both the standard and the lamp under test from the *same circuit*. Any fluctuations in voltage will then affect both lamps and their relative candlepower will be almost unaffected. The results will, therefore, be much more accurate than if the two lamps were run from separate sources of current.

35. Lamp Estimates.—With an average power consumption of 3.3 watts per candlepower, a 16-candlepower lamp will require $16 \times 3.3 = 52.8$ watts. The current that the lamp will require will depend on the voltage at which it

is operated. The current in any case can be obtained by the following formula:

$$I = \frac{CP \times W}{E} \quad (3)$$

in which CP = candlepower;

W = watts per candlepower;

E = voltage across the lamp terminals.

EXAMPLE.—A 32-candlepower lamp requires 3.5 watts per candlepower and is designed to operate at a pressure of 110 volts. What will be the current taken by the lamp and what will be the resistance of the lamp when hot?

SOLUTION.—From formula 3,

$$\text{current} = \frac{32 \times 3.5}{110} = 1.02 \text{ amperes, nearly. Ans.}$$

From Ohm's law, $I = \frac{E}{R}$, or $R = \frac{E}{I}$; hence,

$$\text{resistance} = \frac{110}{1.02} = 107.8 \text{ ohms. Ans.}$$

NOTE.—The value of the resistance of an incandescent lamp obtained by dividing the E. M. F. by the current gives the hot resistance. The resistance of carbon decreases as the temperature increases, until a certain point is reached beyond which the resistance remains nearly constant. Since the temperature is high in an incandescent lamp, the cold resistance is very much higher than the hot; it may be almost double the hot resistance. In practical work, we are not, as a rule, concerned directly with the cold resistance of the lamps, and when the resistance is spoken of, the hot resistance is meant. A 16-candlepower, 110-volt lamp has a hot resistance in the neighborhood of 220 ohms.

Small incandescent lamps require a larger number of watts per candlepower than large ones. For example, a 4-candlepower lamp requires in the neighborhood of 20 watts; 6-candlepower, 25 watts; 8-candlepower, 32 watts; and 10-candlepower, 37 watts. In general, then, the substitution of a small lamp for a larger one will result in a saving in power, but not in direct proportion. For example, if an 8-candlepower lamp were substituted for a 16-candlepower, the power consumption might be reduced from about 52.8 watts to 32 watts.

36. Allowing for loss in the line, it will probably require about 60 watts at the dynamo terminals for every

16-candlepower lamp operated. Hence, if the output of the dynamo, in kilowatts, is known, the number of 16-candlepower lamps that it is capable of operating may be obtained approximately, by the following formula:

$$\text{Number of 16-candlepower lamps} = \frac{1,000 \times KW}{60} \quad (4)$$

in which KW is the capacity of the dynamo in kilowatts.

EXAMPLE.—About how many 16-candlepower lamps should a 12-kilowatt dynamo be capable of operating?

$$\text{SOLUTION.}—\text{Number of lamps} = \frac{1,000 \times 12}{60} = 200. \quad \text{Ans.}$$

Sometimes the output of the dynamo is given in volts and amperes instead of in kilowatts. In such cases, the output in watts is easily obtained by multiplying the volts by the amperes, and the number of 16-candlepower lamps that the dynamo can operate may then be obtained by dividing by 60, as before.

EXAMPLE.—A dynamo is capable of delivering an output of 70 amperes at a pressure of 115 volts. About how many 16-candlepower lamps can it run?

SOLUTION.—The output in watts will be $115 \times 70 = 8,050$, and since each lamp requires about 60 watts, the capacity of the machine will be $\frac{8,050}{60} = 134$ lamps. Ans.

NOTE.—When the capacity of a dynamo is given as so many lamps, 16-candlepower lamps are always meant. If 32-candlepower lamps are operated, each 32-candlepower lamp should be counted as the equivalent of two of 16 candlepower.

37. The number of indicated horsepower required at the steam engine to operate a given number of lamps will depend on the amount of power lost in the dynamo and engine. The approximate rule given above supposes that 60 watts are required at the terminals of the dynamo for each lamp operated. There will be some loss in the dynamo and in the engine, so that the indicated power at the cylinder of the engine must be more than 60 watts per lamp. Just what this indicated power must be will depend on the combined efficiency of the engine and dynamo, and this will,

in turn, depend on the size and type of engine and dynamo. Generally speaking, ten 16-candlepower lamps can be operated per indicated horsepower; this number is exceeded somewhat with large engines and dynamos, but, on the other hand, with poor apparatus the lamps per indicated horsepower may fall below the number given.

EXAMPLE.—An isolated plant is to be installed for operating 350 16-candlepower lamps: (a) What should be the indicated horsepower of the engine? (b) What should be the approximate capacity of the dynamo in kilowatts?

SOLUTION.—(a) Allowing 10 lamps per indicated horsepower, the horsepower of the engine would have to be $\frac{350}{10} = 35$.

(b) Allowing 60 watts at the dynamo terminals per lamp, the output in watts would be $350 \times 60 = 21,000$, or 21 kilowatts. Ans.

38. Life.—The length of time that an incandescent lamp will burn before giving out is very uncertain and depends on a number of different things. Sometimes there may be defects in the manufacture that will cause a lamp to burn out in a very short time, though systematic testing at the factory has resulted greatly in the reduction of the number of such lamps that reach the consumer. Lamps are often run at a higher voltage than they should be, and although this makes them give a good light for the time being, it shortens their life greatly. Raising the pressure 1 or 2 volts above the proper amount on a 110-volt lamp may shorten its life as much as 15 to 25 per cent. On the other hand, it does not pay the central station to run the voltage low, because, although the lamps may last longer, they will not give a good light and will give rise to dissatisfaction on the part of the customers. It is always best to run the lamps as nearly as possible at the voltage for which they are designed, and to run the plant so that the regulation will be good, i. e., so that the voltage at the lamps will be nearly constant, no matter how the number of lamps in use may vary. It has been found, experimentally, that the life of a lamp varies approximately as the fifth power of the efficiency expressed in watts per candle. Thus, if L_1 is the life when

burned at an efficiency of W_1 and L_1 , the life when burned at an efficiency of W_2 ,

$$\frac{L_1}{L_2} = \frac{W_1^3}{W_2^3}$$

or
$$L_2 = \frac{L_1 W_2^3}{W_1^3} \quad (5)$$

EXAMPLE.—If a lamp has a life of 800 hours when burned at a normal efficiency of 3.1 watts per candle, what will its life be when burned at an efficiency of 3.4 watts per candle?

SOLUTION.— $W_1 = 3.1$; $W_2 = 3.4$; $L_1 = 800$; hence, from formula 5,

$$L_2 = \frac{800 \times 3.4^3}{3.1^3} = 1,270 \text{ hr., approximately. Ans.}$$

The slight increase in the watts per candle (from 3.1 to 3.4) means that the filament is worked at a lower temperature and there is consequently a large increase in the life of the lamp, though the light is not obtained as economically so far as the cost of power is concerned.

39. Assuming that the voltage is kept constant, a lamp will gradually fall off in brilliancy after it has been burned for some time, and after a certain point is reached it becomes so uneconomical that it pays better to replace it by a new one rather than attempt to run it until it burns out. The length of time during which it pays to burn a lamp is difficult to decide. Lamps will frequently burn over 2,000 hours before they give out, but after they have burned from 500 to 700 hours their candlepower has fallen off to such an extent that it will probably pay to replace them. Many large central stations make it a rule to replace lamps when they have fallen off to 80 per cent. of their original candlepower. For example, a 16-candlepower lamp would be discarded when it had fallen off to 12.8 candlepower.

40. The falling off in candlepower is generally attributed to a disintegration of the carbon. The filament gradually increases in resistance on account of small particles of carbon being thrown off; this increase in resistance results in a decrease in current and, consequently, in a decrease in candlepower. Moreover, the small particles of carbon

are deposited on the inside of the globe, thus producing the well-known blackening effect and further reducing the illuminating power of the lamp. Lamps have been very much improved of late years as regards this falling off in candlepower. The two curves, Fig. 18, given by Mr. F. W. Willcox,* illustrate the improvement in this respect, the upper curve being for a modern lamp and the lower for an old-style lamp. Both lamps start out with the same candlepower, and the lines show the percentage of

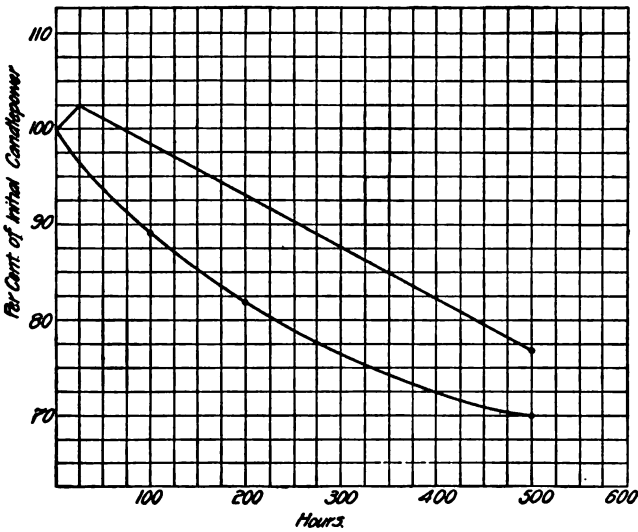

FIG. 18

the initial candlepower after the lamps have been burning for different intervals of time. There is a steady decline in the candlepower of the old lamp from the time it starts burning, and at the end of 500 hours it is only giving 70 per cent. of the light it gave at the start. The candlepower of the other lamp, on the contrary, increases slightly during the first 25 hours, and at the end of 75 hours has returned to its original candlepower. It then falls off in candlepower, but

*Journal of Franklin Institute, Vol. CXLVIII.

at the end of 500 hours is still giving about 77 per cent. of the original amount.

41. Voltages.—The voltage of an incandescent lamp is the pressure that must be maintained between its terminals in order that the resultant current shall cause the lamp to give its rated candlepower. By far the greater number of incandescent lamps in use are designed for voltages anywhere between the limits of 100 and 125 volts. For example, 100, 104, 110 are common values. When alternating current was first introduced, it admitted the use of low voltages at the lamps, because the current could be transmitted at high pressure and then transformed to low pressure. At that time, it was more difficult to make durable and efficient lamps for 100 or 110 volts than for lower voltages, and a pressure of 50 or 52 volts for the lamps became common. This pressure is no longer used on new installations, because there is now no difficulty in making lamps for the higher voltages. A pressure of 80 volts has been customary for marine work, but in modern installations 110 to 125 volts is used. Of late years, it has become possible to make lamps for 220 to 250 volts, and a number of plants using lamps of this voltage are in successful operation.

In connection with lamp voltages, it may be interesting to note that in the process of manufacture it is impossible to make all the lamps come out at the voltage aimed at. For example, if a lot of 110-volt lamps were to be made up, a great many of them would come out at 108, 109, 111, or thereabouts. It is often a good plan, therefore, for a station to operate at an odd voltage of, say, 107 or 111 rather than at 110, as the chances are that if lamps are ordered for the odd voltages they will be obtained, whereas, if ordered for the even 110 volts, it is probable that 108-volt or 109-volt lamps marked 110 will be supplied, because it would be practically impossible to supply all the lamps of exactly 110 volts without especially selecting them.

42. General Remarks.—Incandescent lamps are made for a wide range of voltage and candlepower. The power

consumption per candlepower also varies through wide limits. High-efficiency lamps, in general, will have a short life unless the voltage regulation is very good; hence, high-efficiency lamps should not be used in places where the regulation is poor. In order to determine the current that any lamp will take, its power consumption per candle must be known and the current may then be calculated. When making wiring estimates, or in any case where the approximate current only is needed, the following values of the current required per lamp may be used:

TABLE I

Candle-power	Voltage	Current Amperes	Candle-power	Voltage	Current Amperes
10	110	.36	16	52	1.00
16	110	.50	32	52	2.00
32	110	1.00	16	220	.30
10	52	.75			

43. Heating.—A 16-candlepower, 64-watt incandescent lamp gives off about 220 British thermal units of heat per hour. A British thermal unit is equivalent to the amount of heat that is required to raise 1 pound of water from 62° F. to 63° F. Incandescent lamps give off from 5 to 10 per cent. of the amount of heat emitted by ordinary bat-wing gas burners of corresponding candlepower.

44. Illumination by Incandescent Lamps.—In wiring for incandescent lamps, it is necessary to locate the lights so that the best illumination will be obtained. In factory lighting, the lamps are so placed that they will be as near as possible to the workmen, whether at the machine or vise.

For the interior of stores, general illumination is required. Show windows should be lighted by reflected light only, because exposed light striking the eye will cause the effect of the general arrangement to be lost to the observer. In

picture galleries, this same idea should be carried out. House lighting is more for effect than general illumination.

In theater lighting, where the scenic effects depend entirely on a careful adjustment of light intensities, experience is the only guide.

Among other points to be observed in placing lights is the color of the surrounding walls. Dull walls will reflect only about 20 per cent. of the light thrown on them, while a clean, white surface will reflect 80 per cent. The height of the room also reduces the effectiveness of a given light intensity.

The unit used for expressing the degree of illumination produced by any source of light is the foot-candle, or the degree of illumination produced by 1 standard candle at a distance of 1 foot from the object to be illuminated. An illumination of 1 foot-candle is a good light to read by and the illuminations met with in practice usually vary from $\frac{1}{2}$ to 2 or 3 foot-candles. Since the illumination decreases as the square of the distance, a 16-candlepower lamp at a distance of 1 foot from an object would produce an illumination of 16 foot-candles, at a distance of 2 feet the illumination would be 4 foot-candles, and at a distance of 4 feet, it would be 1 foot-candle; or, if B = candlepower of source and D = distance in feet from object, then

$$\text{illumination (foot-candles)} = \frac{B}{D^2} \quad (6)$$

The illuminating value of different lights is about as follows:

TABLE II

Light	Foot-Candles
Ordinary moonlight025
Street lighted by gas030
Stage of theater	2.9 to 3.8
Diffused daylight	10.0 to 40.0

A clear idea of these various intensities is easily gained by comparison, remembering that 1 foot-candle furnishes a good light to read by. On account of the great influence of the color of walls, height of ceilings, etc., it is impossible to give other than very approximate figures for the amount of light required for illuminating a given room. For rooms requiring ordinary illumination and having ceilings about 10 feet high, about .25 to .29 candlepower per square foot should be sufficient. For rooms with high ceilings .45 to .5 candlepower per square foot should be allowed, and for very brilliant lighting in ball rooms or similar places, the allowance may be as high as 1 candlepower per square foot. Of course, these figures are for cases where the whole room is to be generally illuminated; when the light is used locally, as at desks or reading tables, it may not be necessary to have the room generally illuminated, and the allowance per square foot might be much less than that indicated by the above figures.

EXAMPLES FOR PRACTICE

1. Allowing for loss in the lines, about how many 16-candlepower lamps can a 300 kilowatt dynamo operate? Ans. 5,000 lamps
2. What will be the illumination, in foot-candles, produced by a 32-candlepower lamp placed 9 feet from the object illuminated? Ans. .395 foot-candle
3. How much current, approximately, would be required for the operation of 300 220-volt lamps? Ans. 90 amperes
4. In testing a lamp on a photometer bar having 1,000 divisions, a balance was obtained with the screen 300 divisions from the standard. If the standard were 16 candlepower, what was the candlepower of the lamp under test? Ans. 87.1 candlepower

RECENT TYPES OF INCANDESCENT LAMP

45. Within the last few years much experimenting has been done in order to produce an incandescent lamp more efficient than the ordinary lamp employing a carbon filament. The investigation has been mainly along two lines; namely, to produce a successful lamp employing material other than carbon for the light-giving filament, and to produce a lamp

in which a gas or vapor is brought to a high state of incandescence. The *Nernst* lamp represents a successful type in which the glower or light-giving portion is not of carbon. So far, lighting by vacuum tubes or by means of incandescent gas has not been used to any great extent, though much experimenting has been done, and it is possible that some such system may ultimately prove practicable.

46. Efficiency of Light-Giving Sources.—Any source of light may be considered as giving out two kinds of radiation—luminous radiations and obscure radiations. The energy that is expended in the luminous source sets up vibrations in the ether, and those vibrations that have a wave length lying between .000360 millimeter and .000810 millimeter are capable of affecting the eye and producing the sensation known as light. All vibrations lying above or below these limits are useless as far as producing light is concerned. For example, all heat radiations (of long wave length) represent so much waste energy. If we call A the total radiation from a light-giving source, B the amount of luminous radiation, and C the non-luminous or obscure radiation, then, $A = B + C$, and the ratio $\frac{B}{A}$ is the optical effi-

ciency of the light-giving source, because it is the ratio of the radiation that is useful in producing light, to the total radiation. The efficiency of ordinary light-giving sources as measured by this standard is very low. For example, the optical efficiency of an oil lamp is not more than 3 per cent.; that of an ordinary gas burner about 4 per cent.; and that of an incandescent lamp 5 to 6 per cent., depending on the temperature at which the filament is worked. The arc lamp has a considerably higher efficiency; it may run as high as 18 per cent. or more when measured in the direction in which the lamp throws its maximum illumination, but the average efficiency is not more than 10 per cent.

There is room for a great deal of improvement in the efficiency of our light-giving sources, and efforts to effect such improvement have been along the lines mentioned

above. Contradictory as the statement may seem, it is nevertheless true that some of the most efficient lamps are those in which the highest temperatures are attained. In order to get an efficient lamp, the greatest possible amount of light must be produced with the smallest possible accompaniment of heat. In lamps operated at a high temperature, the proportion of light to heat, and hence the efficiency, is greater than in lamps where the temperature is lower, and the effort has therefore been to produce incandescent lamps in which the glowing material could be maintained at a higher temperature than is possible with a carbon-filament lamp. The temperature of the carbon points of an arc lamp is over twice that of the filament of an ordinary incandescent lamp, and the arc lamp is over twice as efficient. An incandescent lamp worked at high voltage gives more candlepower per watt than when worked at normal voltage, but the filament soon burns out because it is unable to stand the high temperature. Some of the lamps that have been brought out and in which a higher temperature is attained than in the carbon-filament lamp will be considered briefly.

THE NERNST LAMP

47. Operation.—The Nernst lamp has now been in commercial use for some time, and has shown that it can be depended on as a reliable and efficient source of light. The light-giving portion or glower in this lamp consists of a small stick or rod made of the rare oxides, such as oxides of thorium, zirconium, yttrium, etc. This glower is a non-conductor when cold, but when heated to a temperature of about 700° C., it conducts current and is soon brought up to a very high temperature by the passage of the current. In order to start the lamp, therefore, some means must be provided for heating the glower up to the conducting temperature. This heating is necessary only during the interval of starting, and after the current has been started the heating device is cut out of service.

In order to make the operation of the lamp stable, it is

necessary to insert a resistance in series with the glower. If the current increases by a slight amount, there is a considerable reduction in the glower resistance, and this in turn would allow a further increase in current, which would soon lead to fusing or softening of the glower if the resistance in series were not used to prevent it. The resistance is so constructed that any slight increase in current causes a large increase in the temperature of the resistance wire, thus increasing the value of the resistance. The result is that

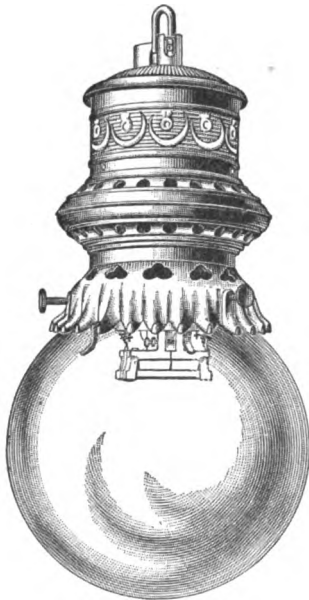

FIG. 19

the rise in current due to the lowering of the resistance of the glower is checked, and the lamp rendered stable in its action. The voltage of the circuit should not vary more than 5 per cent. from normal and the glower should be selected with reference to the actual voltage on which it is used. Nernst lamps, or in fact any other incandescent lamp, will not give good service on systems where the voltage regulation is poor.

48. Description.—The Nernst lamp, as at present constructed, consists of the following essential parts: (1) the glower; (2) the resistance, or ballast, as it is termed by the manufacturers; (3) the heating device for starting the lamp; (4) the cut-out device for cutting the heating coils out of circuit after the lamp has been started. The lamps, as constructed by the Nernst Lamp Company, are made in a large variety of sizes and styles. Some are intended for outdoor, and others for indoor, use, but the difference between the outdoor and indoor types lies principally in the style of casing used to protect the parts. They are also made for a

wide range in candlepower. A 50-candlepower glower is used as a unit, and lamps of larger candlepower are made by increasing the number of glowers instead of using a single glower of larger dimensions. The lamps are made with one, two, three, four, or six glowers, giving candlepowers of approximately 50, 110, 175, 250, and 400, and are operated on alternating-current circuits using 100 to 120 volts or 200 to 240 volts. A 110-volt glower takes, approximately, .8 ampere, while a 220-volt glower takes .4 ampere. Only the smaller lamps are made to operate on 100 to 120 volts, as more satisfactory service is obtained from the 220-volt lamps.

Figs. 19 and 20 show the general construction of a 220-volt, two-glower lamp. As shown in Fig. 19, the enclosing globe surrounds the glowers and protects them from air-currents. The glowers are made of oxides, so that it is not necessary to mount

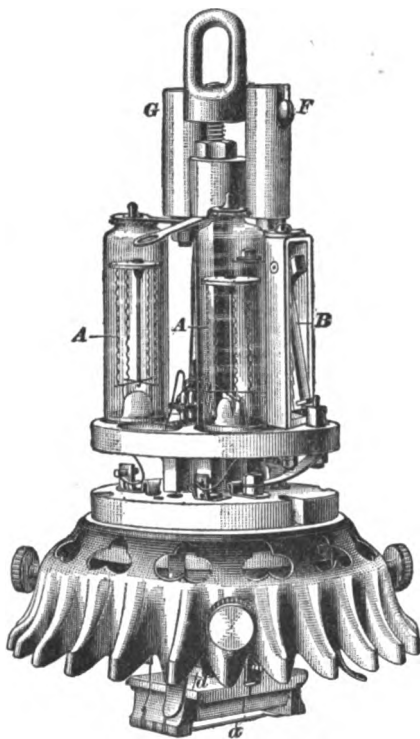

FIG. 20

them in a vacuum like the filament of an ordinary incandescent lamp. In Fig. 20, one of the glowers is shown at *a*. The heater tubes are immediately above the glowers, and both glowers and heaters are supported in a porcelain holder *d*, which can be readily detached from the main part of the lamp whenever it is necessary to replace glowers or heaters. The auxiliary parts of the lamp are

protected by the removable casing. One of the armatures of the cut-out is shown at *B*; *G* and *F* are the lamp terminals.

49. The Glowlers.—Fig. 21 shows a pair of glowers and heater tubes. When mounted in the lamp the glowers *a, a* are from $\frac{1}{16}$ to $\frac{3}{32}$ inch below the heater tubes *b, b*, and about $\frac{5}{32}$ inch apart from center to center. The size of the glowers and heaters, as shown in Fig. 21, is about the same as used on the standard 220-volt lamp. The glower is about .025 inch in diameter and $1\frac{1}{2}$ inches long. It is provided with platinum terminal wires *c, c* attached to copper wires

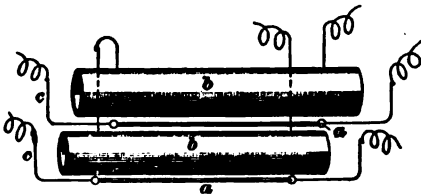

FIG. 21

that terminate in small, tapered aluminum plugs that allow connections to be made or broken easily. The platinum terminals are attached to small beads of platinum embedded in each end of the glower. By making the connection in this manner, any shrinkage of the glower causes the connection to become tighter and therefore does not impair the contact. The life of a glower will average from 600 to 800 hours, provided the voltage regulation is such that the increase in voltage above normal does not exceed 5 per cent. In placing glowers in the holders, care must be taken to allow a small amount of end play; otherwise, the expansion and contraction may result in breakage.

50. Heater Tubes and Holder.—Fig. 22 shows the glower and heater tubes mounted in their porcelain holder. The holder, together with the base on which it is mounted, can be pulled away from the main part of the lamp. The heater coil consists of a porcelain tube with fine platinum wire wound on its surface and covered with a protecting paste that serves to shield the wire from the intense heat of the glower and also furnish a white surface that will reflect the light downwards. The heater tubes *b*, Fig. 22, are held in the porcelain holder *d*, which is attached to the porcelain

base d' that holds brass pieces f to which the glowers are connected by means of the aluminum plugs. The terminals of the heater tubes connect to the prongs h, h' by way of the brass piece g , which also serves as a support for the holder d , being attached thereto by the cotter pin o . Prongs l, m , and n form the terminals of the glowers, and when the holder is pushed up into place the prongs make connection with contacts in the upper part of the lamp. The parts of the holder d that face the glowers are painted with a white paste. After the lamp has been in operation for some time, black oxide of platinum from the glower terminals deposits on the holder, thus blackening the surface and interfering with the reflection of the light.

By cleaning up the old paste occasionally and giving the holder a new coat, a good reflecting surface is maintained. The heater coils last about 200 hours when used continuously, but as they are used only for 20 to 30 seconds each time

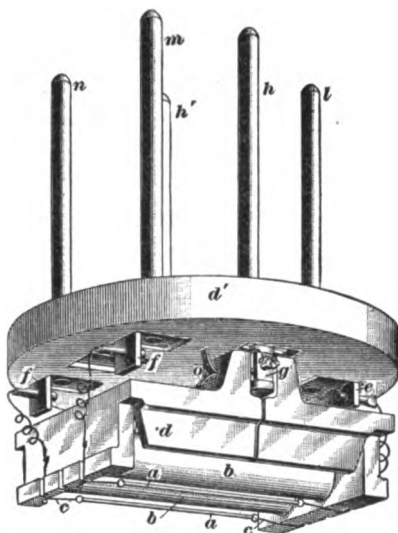

FIG. 2

the lamp is started, the life of a heater corresponds to a very large number of lamp hours.

51. The steadying resistance, or **ballast**, is made of pure iron wire mounted in an inert gas such as nitrogen. In Fig. 20, the ballasts for each glower are shown at A, A , the fine iron wire being mounted in sealed glass tubes. The temperature of a wire so mounted responds quickly to changes in current, and iron wire increases in resistance very rapidly with increase in temperature. An increase of

10 per cent. in the current passing through one of these ballasts will cause as much as 150 per cent. increase in resistance. A small amount of resistance is therefore sufficient to insure stable operation, and the efficiency of the lamp as a whole is higher than if an ordinary resistance were used. By mounting the wire as described, all danger from

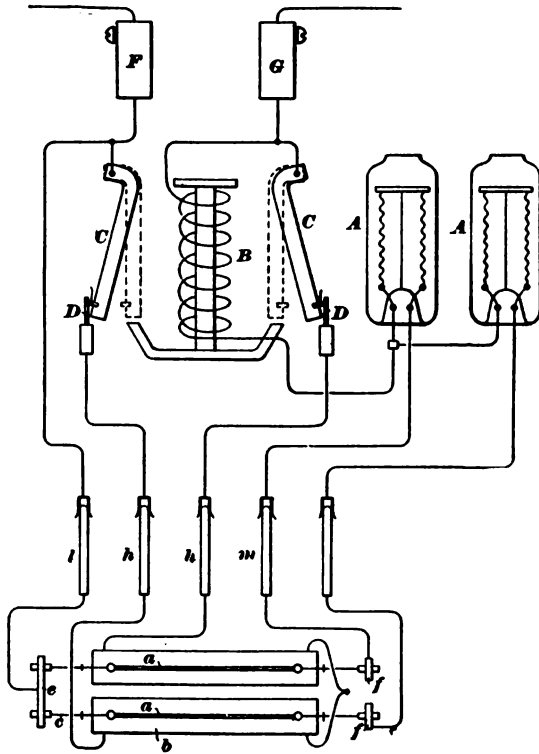

FIG. 28

oxidation is removed, and the ballasts will last a long time, provided the voltage regulation is good.

52. The cut-out consists of an electromagnet connected in series with the glowers and arranged so that when current passes through them it will attract two armatures (one of which is shown at *B*, Fig. 20) and open the circuit through

the heater coils. Each armature is suspended from its upper end, and when the coil is energized, the armatures swing in and open the circuit through the heater coils. There are two armatures and sets of contacts in this lamp, so that the heater circuit is opened in two places. The armatures are suspended loosely from a single point of support to avoid humming caused by the alternating current in the coil. So far, Nernst lamps have been used mostly on alternating current, because direct current appears to decompose the glower and make it short lived. However, considerable advance has been made in the production of glowers for direct current, and doubtless such lamps will soon be available. The wire of the cut-out coil is bedded in cement because it must stand a temperature of about 110° C. It must

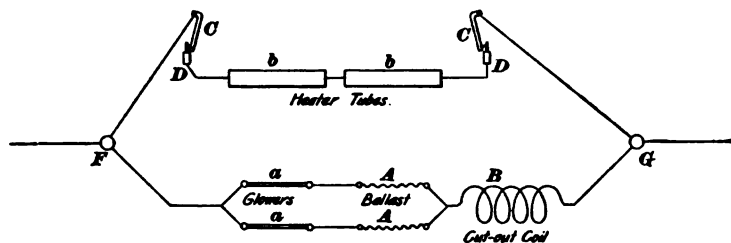

FIG. 24

be remembered that the glower is worked at a high temperature, so that the working parts of the lamp are necessarily subjected to considerable heat.

53. Connections.—Fig. 23 shows the connections of a two-glower lamp, and Fig. 24 shows the same connections in a simplified form in order to bring out the heater and glower circuits more distinctly. The glowers *a, a* are connected in parallel, and in series with each is a ballast *A*. *B* is the cut-out coil, which operates the armatures *C, C* and draws the contacts away from the contact pins *D, D*, thus opening the heater circuit in two places. When the lamp is not in use, coil *B* is not energized and *C* and *D* are in contact. When, therefore, current is turned on, it takes the path through the heaters *b, b*, and the glowers *a, a* are heated

until they are able to conduct current; this usually takes from 20 to 30 seconds. As soon as current passes through the glowers, coil *B* is energized and the circuit through the heaters is broken at *D, D*. Nernst lamps are installed in practically the same manner as incandescent lamps; that is, they are operated in parallel on constant-potential circuits. Ballasts and glowers must be selected with reference to the actual average voltage of the circuit; failure to do this will result in numerous burn-outs. The lamps must be hung in a vertical position; otherwise, the cut-out will fail to operate. The smaller sizes of lamp are made to screw into a socket like an ordinary incandescent lamp, but the larger sizes are constructed as shown in Figs. 19 and 20, and are suspended and connected up in much the same way as arc lamps. A recent lamp, designed to compete with the ordinary 16-candlepower incandescent lamp, gives 25 candlepower. It consists of the same essential parts as the lamps just described, but the arrangement of glower and heating coil is different. The latter is made in the shape of a comparatively large open spiral and surrounds the glower, which is placed inside the spiral. The glower and heating coil are mounted together as a unit, and when a glower burns out, both are renewed. This type of holder was designed to simplify the maintenance of the lamp and is intended more especially for use in isolated localities.

54. Efficiency.—The chief advantages of the Nernst lamp are its high efficiency, the natural color of the light, useful downward distribution, steadiness, and high power factor. The lamp takes approximately half the power expenditure per candlepower required by the ordinary incandescent lamp. The power required in the Nernst lamp is from 1.75 to 2 watts per mean hemispherical candlepower. The high efficiency of the Nernst lamp is due to the fact that the glower is worked at a high temperature, and also to the fact that the substances of which the glower is composed possess the properties of selective radiation to a high degree, i. e., they emit a large number of radiations that are capable of producing

the sensation of light. The color of the light approximates closely to that of daylight, and hence is desirable for store or art-gallery illumination, where the correct determination of color is of importance. As an offset to these advantages, the Nernst lamp, in comparison with the incandescent, is somewhat complicated, and high in first cost, though it must be remembered that the parts to be renewed can be replaced at slight cost after the lamp is once purchased, because allowance is made for the scrap platinum in the burned-out parts. The slowness of starting is also a disadvantage for some kinds of illumination, particularly in theaters, or in any other place where it is desired to switch lamps on and off frequently.

CRAWFORD-VOELKER LAMP

55. The Crawford-Voelker lamp is another type in which the light-giving filament is not composed of carbon. This lamp, in its general construction, is similar to the ordinary incandescent lamp. The filament is mounted in an exhausted globe and no special provision need be made for starting, because the filament is a conductor when cold. The filament is made of carbide of titanium, formed by combining carbon and oxide of titanium in the electric furnace. This substance makes a tough, durable filament that will stand a much higher temperature than the ordinary carbon filament. So far, the lamp has not been used commercially to any extent, but tests on it appear to indicate that it has a considerably better efficiency than the ordinary lamp. Tests have shown an efficiency of 2.53 watts per candlepower at the start, 2.84 watts at the end of 500 hours, and 3.35 watts at the end of 1,000 hours. Still later tests have shown power consumptions ranging from 1.68 to 2.16 watts per candlepower. It is also claimed that this filament does not produce blackening of the bulb found in lamps using a carbon filament.

OSMIUM LAMP

56. Another type of incandescent lamp that shows a higher efficiency than the carbon-filament lamp is that in which the filament is made of the rare metal osmium. This lamp has not yet been used commercially, but tests made on it show that it takes but little over half the power for the same amount of light as the carbon-filament lamp. Osmium lamps maintain their candlepower well and have a longer life than the carbon-filament lamp. The high price of osmium prevents the commercial use of the lamp, and another drawback is that, owing to the comparatively low resistance of the metal, it is difficult to make lamps for operation on the usual pressures of 110 or 220 volts.

INCANDESCENT LIGHTING

(PART 2)

SYSTEMS OF DISTRIBUTION

1. In considering the different systems commonly used for supplying electrical energy to the lamps, the local distribution by means of the wiring in buildings will not be described, as that part of the subject belongs properly to interior wiring. Current for electric lighting is distributed from the station to the point of utilization in the same manner as for power transmission; in fact, in the majority of cases the electric energy transmitted is used both for lighting and power purposes. The following brief descriptions of the more important distributing systems are intended to point out how the methods already described are applied to electric-lighting work.

In most cases, the current required for the operation of incandescent lamps is distributed at a constant potential; i. e., the aim is to keep the pressure at the station such that the pressure at the lamps will remain constant, no matter what the load may be. If the pressure at the lamps is not maintained uniform within narrow limits, the service will be poor, the life of the lamps short, and the complaints from customers numerous. Where the lamps are run on a constant-potential system, the current transmitted over the lines increases with the load, because every light turned on means just so much more current to be supplied. The consequence is that the drop in the line increases with the load, and in order that the pressure at the lamps shall be maintained constant instead of falling off on account of this drop, the pressure at the dynamo or station must be raised slightly.

For notice of copyright, see page immediately following the title page

In any event, no matter what means may be adopted for distributing the current, the aim should be to provide the lamps with a uniform pressure and to see that this pressure is kept uniform, no matter how the number of lamps operated may vary. The distribution should also be designed to accomplish this object with the least possible expense; i. e., the distributing lines should be laid out so as to secure the desired results with the smallest possible amount of copper and loss of energy.

METHODS OF CONNECTING LAMPS

2. Lamps in Parallel.—In the great majority of cases

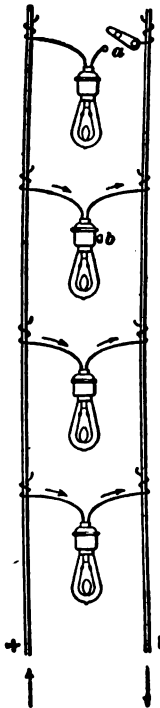

FIG. 1

incandescent lamps are connected in **parallel**, as shown in Fig. 1. In this case, the pressure between the two lines must be kept at a constant value, otherwise the current flowing through the lamps will vary. Since the resistance of a lamp cannot change, unless the temperature of the filament changes, the current that will flow through any lamp depends on but two things—the pressure between the lines and the resistance of the lamp. The current in each lamp is equal to the pressure between the mains divided by the resistance of the lamp. So long as the pressure is kept constant, the turning off or on of any lamp does not affect the others, but the current in the mains will increase when lamps are turned on and decrease when they are turned off. Incandescent lamps are connected in this way, because the arrangement is extremely simple; each lamp is independent of the others, and the pressure between the lines is low.

3. Lamps in Series.—Lamps are occasionally connected in **series**, as shown in Fig. 2. This arrangement is used principally for street lighting; it is seldom used for interior work.

In this case, the same current flows through all the lamps; hence, their filaments must be of the same current-carrying capacity. If it is desired to have some lamps of higher candlepower than others, their filaments must be made longer. The pressure across the terminals of any lamp can be found by multiplying the resistance of the lamp by the current flowing. Also, since the lamps are connected in series, the total pressure required to force the current through the circuit will be the sum of the pressures required for the separate lamps. For example, suppose that there are ten lamps, each requiring a pressure of 20 volts and a current of $3\frac{1}{2}$ amperes; also, five lamps, each requiring a current of $3\frac{1}{2}$ amperes and a pressure of 40 volts. The total pressure required for the circuit, neglecting the loss in

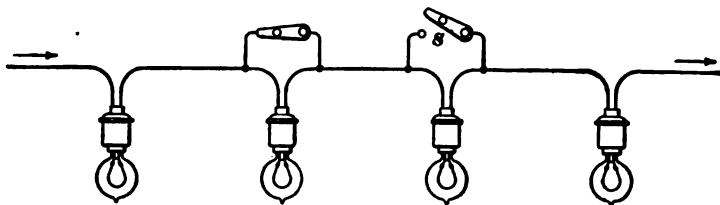

FIG. 2

the line, will be $20 \times 10 + 5 \times 40 = 400$ volts. In this system, the line current is small; hence, it is well adapted for street incandescent lighting, where the area to be covered is large. It should be noted that the current must be maintained at the value for which the lamps are designed. This means that the pressure between the ends of the line must be raised as more lamps are added to the circuit, because the resistance is increased. Also, the pressure must be lowered when lamps are cut out, otherwise the current will increase and burn out the remaining lamps. In the series system, the current is constant and the pressure varies; in the parallel system, the pressure is constant and the current varies as the number of lamps in use is increased or decreased. Another point to be noted is that means must be provided for maintaining the circuit around the lamps, in

case they should burn out; otherwise, the breaking of one lamp will put out all the lights on the circuit. The method by which this is accomplished will be described when this system is taken up in detail. It will also be noted that if the number of lamps operated is large, the pressure applied to the circuit must be correspondingly high; this introduces an element of danger and is one reason why series lighting is not used for interior work. Lamps in series may be cut out

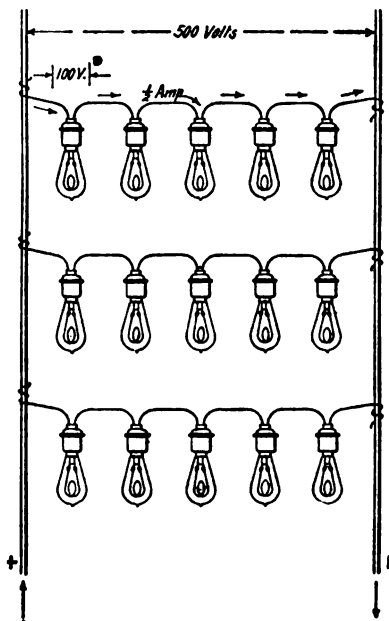

FIG. 3

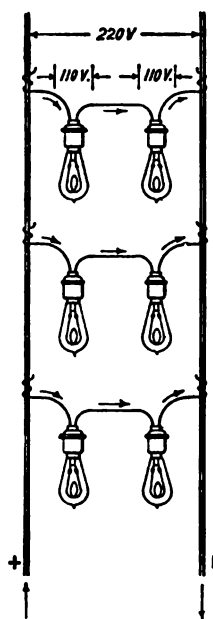

FIG. 4

of circuit by short-circuiting them, as indicated by switch *S*, Fig. 2; whereas, in the parallel system they must be cut out by opening the circuit through the lamp by means of a switch in series with it. This switch may be a separate device *a*, Fig. 1, or it may be in the lamp socket and worked by a key *b*.

4. Lamps in Multiple Series.—This method, sometimes called **parallel series**, is a combination of the two

preceding and is used in a number of special cases. Perhaps its widest use is in connection with the lighting of electric street cars, but it is also used in mine lighting work, where lights are operated from the haulage system.

Suppose, for example, that lamps are to be operated on mains between which a constant pressure of 500 volts is maintained, as on a street railway. Lamps cannot be obtained for 500 volts and a single 100-volt lamp will be burned out instantly if it is connected across the mains, but five 100-volt lamps may be connected in series, as in Fig. 3. With this arrangement, the current through the series of five lamps will be about $\frac{1}{5}$ ampere and the pressure across each lamp 100 volts. Any number of such series of five lamps may be connected across the mains. If one light goes out, it puts out the other four in the same circuit with it, but, if any lamp is cut out, by short-circuiting it, the voltage on the other four lamps becomes higher than they can stand, because the pressure between the mains is constant, and cutting out the drop through one lamp simply throws that much more pressure on the others.

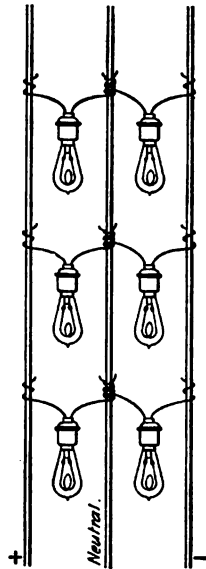

FIG. 5

Fig. 4 shows a multiple-series arrangement with two lamps in series—a scheme of connection that is sometimes used for operating lamps on 220-volt power circuits, for example, in mine-haulage plants. By adding the middle, or neutral, wire to Fig. 4, the three-wire system, Fig. 5, so extensively used for distribution in large cities, is obtained. The multiple-series system, as in Fig. 4, is not used for general interior lighting work. It is used, however, for decorative lighting where a number of lamps of low candlepower are connected in series across the low-potential mains.

DIRECT-CURRENT, CONSTANT-POTENTIAL SYSTEM

5. Simple Two-Wire System.—This method of distribution is very largely used for small, isolated plants, or any installation where the power is transmitted a short distance only. The lamps are usually operated at 110 or 220 volts and the current is supplied by compound-wound dynamos. Fig. 6 shows a single dynamo *G* operating lamps on the simple two-wire system. Two main wires *A, A* run from the dynamo (the various switches and measuring instruments being here omitted for the sake of clearness)

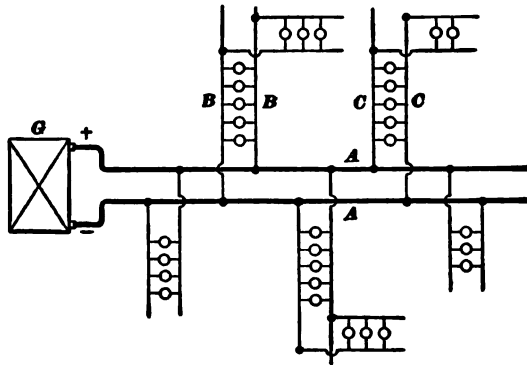

FIG. 6

and the lamps are either connected directly across this pair of mains or are connected across branch mains, as shown at *B, B* and *C, C*. This arrangement answers very well for small plants, where only a small number of lamps are operated and where they are not scattered very widely.

6. Feeders and Mains.—If the lamps are scattered over a considerable area, it is best to run out feeders *A, B*, Fig. 7, to what are known as **centers of distribution**, as at *C* and *D*, and at these points attach mains *E, F* to the feeders. The centers of distribution should be selected so as to lie near the points where the bulk of the light is used. No lights are attached to the feeders; they simply convey

current from the station to the center of distribution, which becomes, as it were, a kind of substation. By this method, a considerable drop can be allowed in the feeders without causing any trouble at the lights. For example, suppose that 110-volt lamps are to be operated and that a drop of 15 volts is allowable between the dynamo and the last lamp on the line. The feeders might be calculated for, say, a drop of 13 volts. This large drop will allow comparatively small feeders to be used and will not be injurious to the lamps,

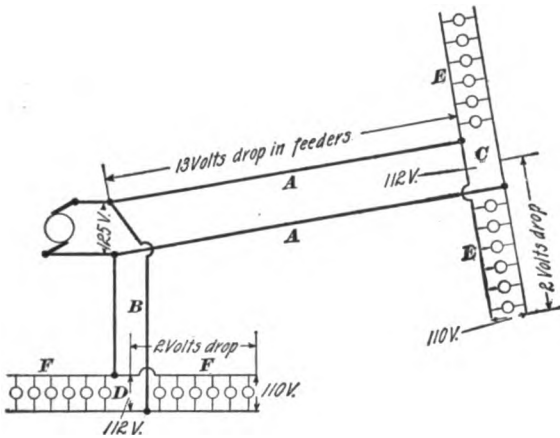

FIG. 7

because the pressure at the point *C* will be maintained at 112 volts, and the variation in pressure along the lamp mains will be but 2 volts.

7. The arrangement just described is known as the **feeder-and-main system**; its advantages may be summed up briefly as follows:

1. It allows the use of a large drop in the feeders carrying the current to the point where it is distributed, thus permitting the use of comparatively small conductors and thereby cutting down the expense.
2. It allows this large drop without introducing large variations in the voltage obtained at the lamps.

3. It allows the district lighted to be divided into sections, each supplied by its own feeder, and thus admits of each section being controlled independently from the station.

8. **Three-Wire System.**—The simple two-wire system, even if operated on the feeder-and-main plan, requires altogether too much copper to admit of very extended use. For moderate distances, the **three-wire system**, Fig. 8, is used. A large amount of lighting is carried out on this plan in New York, Philadelphia, and other large cities. It is not confined to direct current alone, but is also largely used with alternating current.

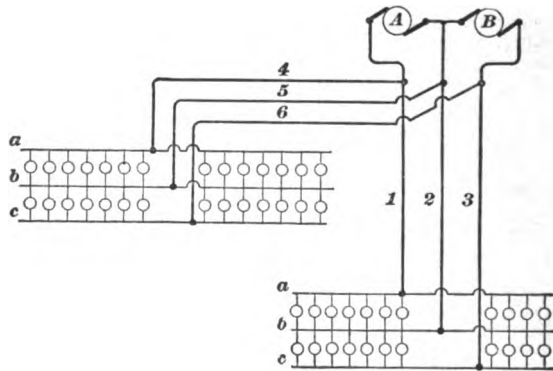

FIG. 8

The two dynamos *A* and *B* are connected in series and supply current through the feeders 1, 2, 3, etc. to the different centers of distribution, where the mains *a*, *b*, *c* are attached. This arrangement effects a considerable saving in copper over the two-wire system; the pressure commonly used is 110 volts on each side of the circuit, or 220 volts between the outside wires. In some recent plants, 220-volt lamps are used, thus requiring 440 volts between the outside wires.

9. **Special Three-Wire Systems.**—The ordinary three-wire system has the disadvantage of requiring two dynamos. If the load were absolutely balanced, one 220-volt dynamo would be sufficient, but in most cases an accurate balance

cannot be obtained. A number of systems have been devised whereby a large 220-volt dynamo can be operated on the two outside wires and the unequal distribution of the load taken up by a balancing arrangement of small capacity compared with that of the dynamo.

10. Fig. 9 shows a system where the unbalancing in the load is taken care of by means of a storage battery, which is connected as shown. The middle point of the battery is connected to the line and the 220-volt dynamo is connected to the outside wires; if a larger current is needed on one side of the battery than on the other, the extra current is

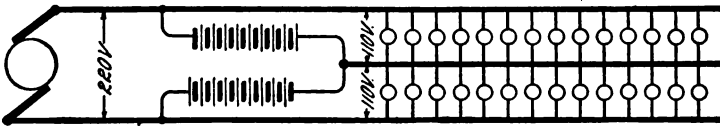

FIG. 9

supplied from the battery. It is not, however, generally advisable to use a battery for maintaining the balance continuously, because the cells become unevenly discharged. When batteries are used on three-wire systems, they are usually connected across the outside lines and a switch provided to connect their middle point with the neutral, so that they can be used for balancing in case of necessity.

11. Fig. 10 shows a three-wire system fed by a 220-volt dynamo *A* in conjunction with a motor-dynamo *aa'*. This motor-dynamo is sometimes called a **balancing set** or

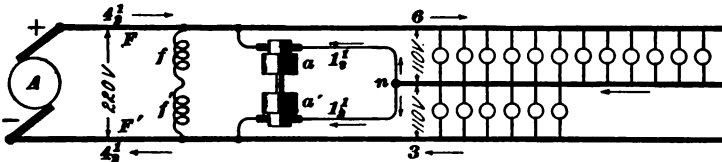

FIG. 10

balancer. The armatures *a*, *a'* are mounted on the same shaft and connected in series, the mid-point *n* being connected to the neutral wire. The fields of the two machines are

connected across the mains, as shown at $f f'$. When one side of the system is more heavily loaded than the other, the machine on the heavily loaded side runs as a dynamo and helps to supply current to that side, while the machine on the lightly loaded side absorbs power and runs as a motor, thus equalizing the load. Take, for example, the special case shown in Fig. 10, where there are twelve lamps on one side and six on the other, or eighteen lamps, in all, supplied from the 220-volt machine A . Allowing 55 watts per lamp, this gives 55×18 watts and, hence, $\frac{55 \times 18}{220} = 4\frac{1}{2}$ amperes. The

current flowing out on F and back on F' must, therefore, be $4\frac{1}{2}$ amperes. The upper side requires 6 amperes and the lower side 3, because there are twelve lamps in parallel in the one case and six in the other. There are, then, 3 amperes coming back through the neutral, of which $1\frac{1}{2}$ flow through a' , running it as a motor and generating $1\frac{1}{2}$ amperes in a . This is added to the $4\frac{1}{2}$ in line F , thus making the six required for the upper side. If the lower side should become more heavily loaded than the upper, the current in the neutral wire would be in the opposite direction and the action of a and a' would be reversed; that is, a would act as the motor and a' as the dynamo.

The motor-dynamo, or balancer, is not necessarily placed in the station; it may be placed at a point near the center of distribution, thus requiring only two feeders F and F' to be run back to the station. In this illustration, the losses in the balancing set have been neglected. As a matter of fact, machine A will furnish more than $4\frac{1}{2}$ amperes in order to make up for the losses in a, a' and supply the lamps as well.

Fig. 11 shows the connections for a balancing set more in detail, (a) being the elementary connections and (b) the complete diagram indicating the various instruments. A and B are the armatures of the balancer and C the armature of the main generator; d and e are field rheostats in the shunt fields, and f the field rheostat of the generator. In order to start the set, it is necessary to provide a starting rheostat at g , so that one of the machines can be started as a

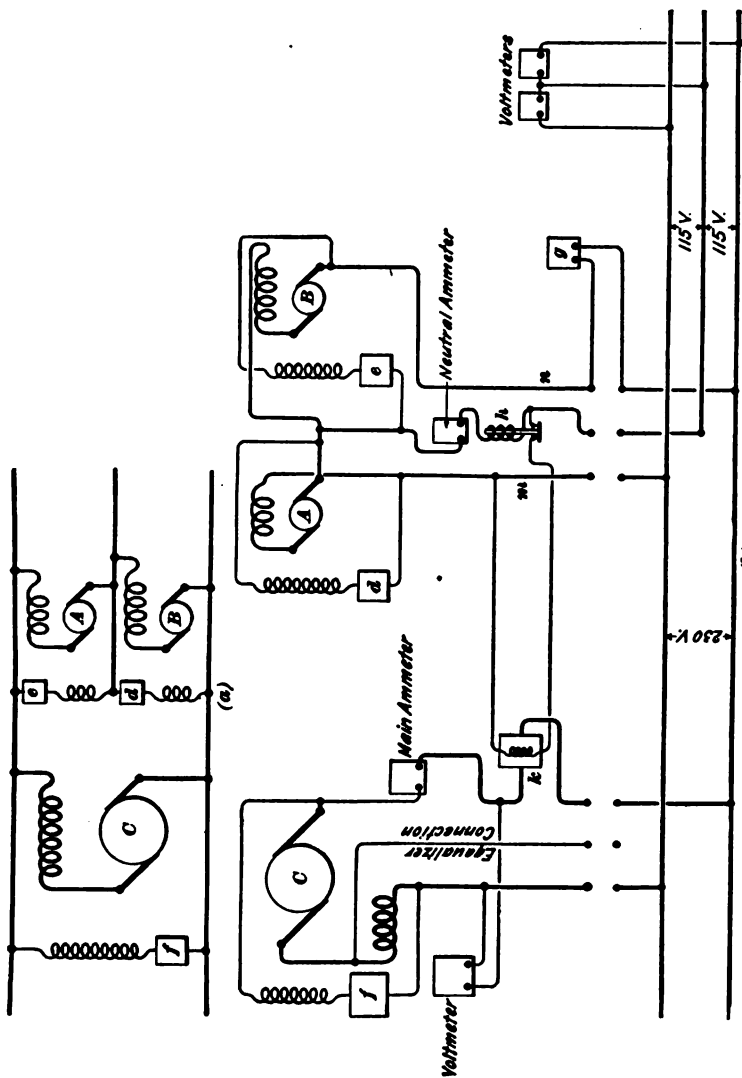

Fig. 11

direct-current motor. Voltmeters and ammeters should be provided as shown, the former indicating the voltages of the main machine and the pressure on the two sides of the three-wire circuit, and the latter indicating the current output of the main machine and the current in the neutral. The reading of the neutral ammeter shows the amount of current handled by the balancer. A trip coil k is placed in the neutral wire leading to the balancer, so that if the current becomes excessive, a circuit is closed through the trip coil of the circuit-breaker k , thus cutting off the main generator. If an overload on the balancer were taken care of by placing a circuit-breaker at m or n , damage would result, for if a short circuit should occur on either side of the system, the circuit-breaker on that side would at once fly out, and since the main machine would still be connected, an excessive voltage would be thrown on the lamps. In most large stations operating on the three-wire system, the amount of unbalancing is usually small compared with the total load carried, so that the capacity of the balancing arrangement is, as a rule, small compared with that of the main dynamo. Balancing sets are now generally used in preference to the old method employing two main dynamos connected in series.

12. Voltage Regulation.—In stations where a large number of lamps are operated, it is usually necessary to have several distinct feeders running to the different districts to be lighted or supplied with power. Some of these feeders may be long, others quite short. In order, therefore, to keep the cross-section of the long feeders within a reasonable size, a larger drop must be allowed in them than in the short feeders. It is necessary, then, to have some means of supplying the long-distance feeders with a higher pressure than those supplying the near-by districts. Of course, the voltage on the short feeders might be cut down by inserting resistance in series with them, as has been done in some cases, but this method is wasteful of power and is not to be recommended.

13. An excellent method, where separate dynamos are available, is to use separate machines for supplying the long-distance feeders, and run them at a higher voltage than those supplying the short feeders. When only one dynamo or set of dynamos is at hand for operating the whole system, the best plan is to run the machines at the pressure suitable for the short feeders, and use a *booster* to raise the voltage on the other feeders. Fig. 12 indicates the arrangement

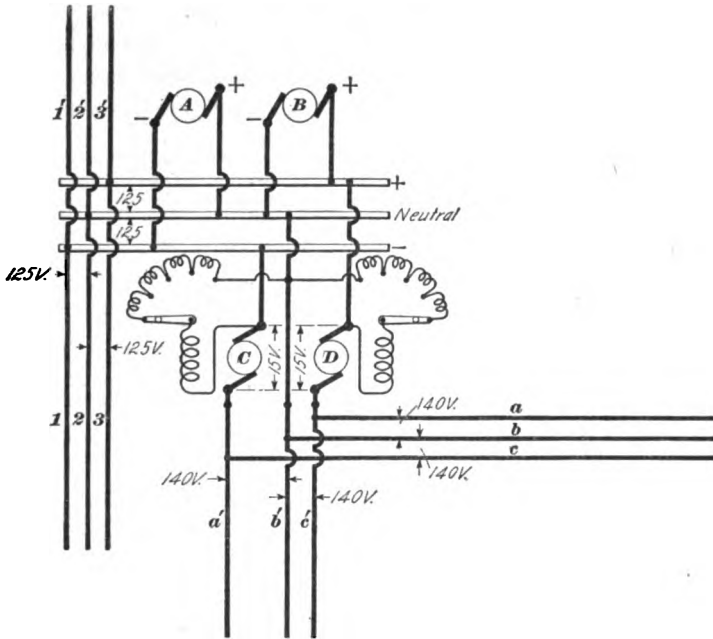

FIG. 12

referred to. The plan shown is for the three-wire system, though the same scheme may be used on a two-wire system and is, in fact, used considerably with electric railways. *A* and *B* are two dynamos operating on the three-wire system and supplying current directly to the short feeders 1, 2, 3, and 1', 2', 3'. Feeders *a*, *b*, *c* and *a'*, *b'*, *c'* run to outlying points and, therefore, must be supplied with a higher pressure than the other feeders. Suppose, for example, that each dynamo

generates 125 volts and that the long-distance feeders require 140 volts between the outside and neutral wires; 15 volts must, therefore, be added to each dynamo voltage. This is accomplished by the boosters *C, D*, which are connected as shown.

The **boosters** are small dynamos driven either by a steam engine or, more frequently, by an electric motor. The fields are separately excited from the mains and the armatures are connected in series with each of the outside wires. The armatures must be capable of carrying all the current used on the long-distance feeders and be able to generate a pressure equal to that by which the voltage is to be raised. For example, in this case the booster armatures would generate the extra 15 volts required and thus give 140 volts on the feeders *a, b, c* and *a', b', c'*. By varying the field rheostat of the boosters, the voltage on the feeders may be adjusted.

14. Five-Wire and Seven-Wire Systems.—The three-wire system has been extended so as to make use of higher potentials by employing four dynamos in series and three neutral wires. This allows the use of 440 to 500 volts between the outside wires and permits a still larger area to be covered than by the three-wire system. **Seven-wire systems** with six dynamos in series have also been used, and the **five-wire system** has been successfully applied on the continent of Europe. Five-wire and seven-wire systems have met with little favor in America, the practice being to use alternating-current methods of distribution if pressures higher than those given by the 110–220-volt or 220–440-volt three-wire systems are required. The use of three-wire systems with 220-volt lamps and 440 volts across the outside wires is gradually extending, because the higher pressure allows larger areas to be supplied and effects a saving in copper over the 110–220-volt system.

DIRECT-CURRENT, CONSTANT-CURRENT SYSTEM

15. The direct-current, constant-current system is very seldom used for incandescent-lighting work. It was employed to some extent in the early days of electric lighting when a few incandescent lights were operated in series with direct-current arc lamps. In such systems, the current used was a direct one, furnished usually by a machine of the Thomson-Houston, or Brush, type, and was maintained at a constant value by automatically varying the E. M. F. There were many objections to operating incandescent lamps in this way and the system was never used to any great extent.

ALTERNATING-CURRENT, CONSTANT-POTENTIAL SYSTEM

16. Alternating current at constant potential finds wide application for incandescent lighting, because this method allows lights to be operated over large areas with a comparatively small loss and a small expenditure for copper. The distribution may be carried out by means of the single-phase, two-phase, or three-phase system. If the current were intended for operating lights only, the single-phase scheme would be used, as it is simpler than either the two-phase or three-phase arrangements. Most modern lighting plants, however, are equipped so that they can operate motors as well as lights, and, hence, it is customary to install polyphase systems rather than single-phase.

17. **Single-Phase System.**—When alternating current first came into use for electric lighting, a simple alternator was used to supply current at a constant pressure. This was transmitted over the line, and at the various points where it was utilized transformers were installed to step-down the voltage to an amount suitable for the lamps. Each customer usually had his own transformer. If the system were small, only a single pair of lines or feeders was run from the station; in case the area lighted was large, a number of feeders supplying different sections was used. The

pressures first used were 1,000 volts on the primary mains and 50 or 52 volts on the secondary. As the construction of alternators, transformers, and lamps was brought to a higher stage of perfection, the pressures were increased to 2,000 volts primary and 100 to 110 volts secondary. The frequency used in the early plants was usually from 125 to 133 cycles per second; in later plants, 60 cycles has become common practice.

The great advantage of this system over the direct current lies, of course, in the use of the high pressure for transmitting the current. The introduction of alternating

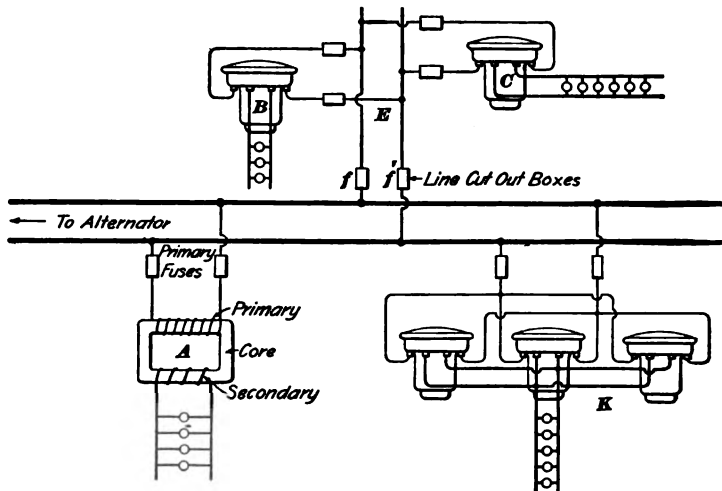

FIG. 13

current rendered possible the lighting of many places that could not afford the expense of installation that would be necessary if direct current were used. It also rendered water-powers available that were located at some distance from the centers to be lighted.

18. It was formerly customary to install small transformers for each customer, as shown at *A, B, C*, Fig. 13, and if a large amount of current were required at any point, a number of transformers were connected in parallel, as

shown at *K*. This was necessary because transformers were not then made in large sizes. On account of the objections to running a number of small transformers it is much better to make use of a system of secondary mains supplying a number of customers and to feed these secondary mains from a few large transformers, as shown in Fig. 14. In this case, the primary mains *A*, *B*, running from the station, feed the large transformers *T*, *T*. The distributing secondary mains are usually arranged on the three-wire system, as indicated at *C*, thus allowing a considerable area to be supplied from

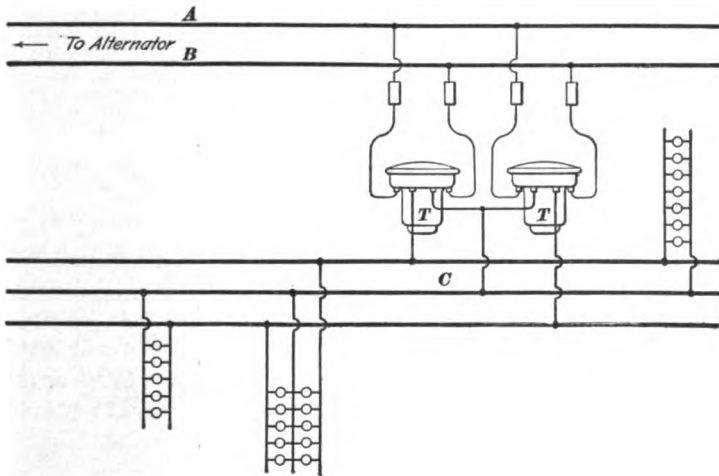

FIG. 14

one pair of transformers. The current may, however, be distributed by secondary two-wire mains if the lights are close at hand. Scattered customers must, of course, be supplied by individual transformers, as in Fig. 13. The use of secondary mains greatly reduces the number of transformers to be kept in repair and otherwise looked after; it also effects a considerable saving in power, owing to the higher efficiency of the large transformers. Where branch lines *E*, Fig. 13, are taken off the main feeders, main line cut-out boxes *f*, *f'* should be installed as indicated. The secondary-main arrangement can generally be used to advantage for

furnishing light to the business part of a town, while in the residence part it is frequently necessary to use individual transformers on account of the customers being scattered. These remarks apply also to lighting systems using two-phase or three-phase distribution.

19. Polyphase Systems.—Polyphase systems of distribution are used extensively for electric lighting, but, so far as the lighting is concerned, they have little if any advantage over the single-phase system. The chief reason for their use is to permit the operation of alternating-current motors from the same system as the lights. The three-phase system also has the advantage of reducing the amount of copper required in the lines—an advantage of considerable importance when the current has to be transmitted for a long

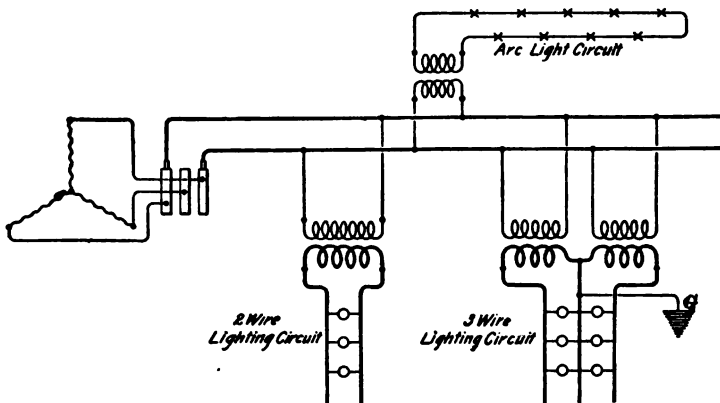

FIG. 15

distance. The regular two-phase and three-phase systems have been described, but a few special methods of operating lights from polyphase machines may be mentioned here. When alternators were first installed in lighting stations, they were of the single-phase type, because polyphase motors had not at that time come into use and the current was employed for lighting exclusively. When alternators are now installed, it is usually desirable to put in a machine

that can operate either lights or motors, and the operation of polyphase machines on single-phase circuits therefore becomes a consideration of importance.

If the various lighting circuits are arranged so that the load on the different phases can be approximately balanced, there is no reason why a two-phase or a three-phase alternator cannot be used to operate them. A three-phase alternator can be operated as a single-phase machine, as shown in Fig. 15, in case the load cannot be divided between the different phases. When so operated, it can, if necessary, be run in parallel with other single-phase machines. A three-phase alternator, when run as a single-phase machine, as shown in Fig. 15, will carry about 75 per cent. of its rated output. For example, suppose that a three-phase alternator has a capacity of 200 kilowatts at 2,300 volts. Its current output will be $I = \frac{200,000}{2,300 \times 1.732} = 50.2$ amperes.

If the same alternator were operated single-phase, its output would be about $.75 \times 200 = 150$ kilowatts and the current output would be $\frac{150,000}{2,300} = 65.2$ amperes; that is, with approximately the same increase in temperature of the armature, the alternator would deliver 50.2 amperes in each of three lines when run three-phase, or 65.2 amperes when run single-phase. For a given output, a three-phase alternator is somewhat smaller than a single-phase machine, because the armature winding space is utilized to better advantage. Consequently, a three-phase alternator, capable of giving a single-phase output of a given number of kilowatts, costs about the same as a single-phase machine of the same output. When installing new machinery in a lighting station that has hitherto been operated altogether by single-phase machines, it is frequently advisable to install three-phase alternators, even if they are operated single-phase for the time being, because, in case occasion should arise for the operation of motors, the three-phase current will then be available. When three-phase alternators are intended for single-phase operation, they are usually provided with a **Y**-connected winding.

20. If all three phases of the alternator are used, the outgoing feeders should be connected across different phases, as shown in Fig. 16, so that the load will be, at least, approximately balanced. If the loads are not balanced, there will be more or less inequality in the voltages on the different feeders, but by a judicious arrangement of the feeders and the loads thereon, a fairly good balance should be possible in the majority of cases. Of course, the amount of

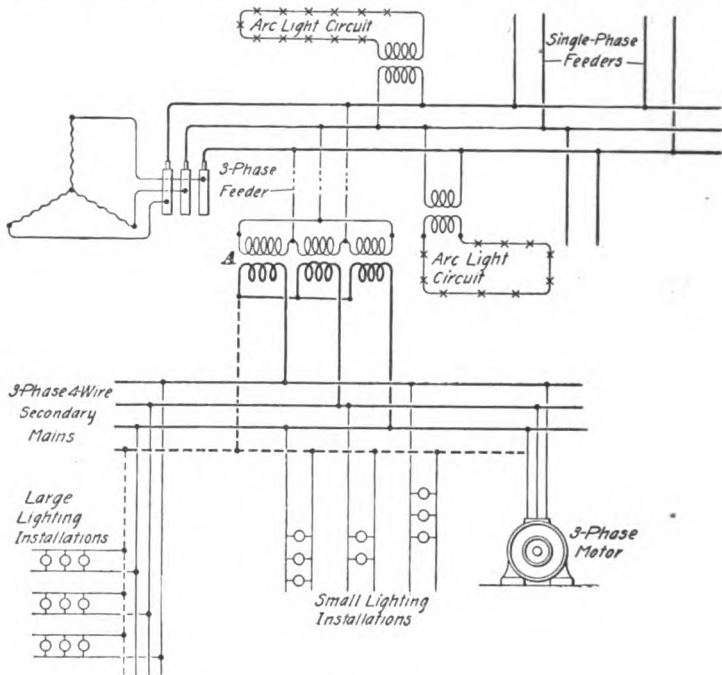

FIG. 16

the inequality in voltage on the different phases due to inequality of load will depend considerably on the design of the alternator. If the armature is of low inductance, the falling off in voltage with increase in load will be comparatively small; in other words, the inherent regulation will be good and unbalancing of load will not cause serious unbalancing of voltage. In the majority of cases, the unbalancing

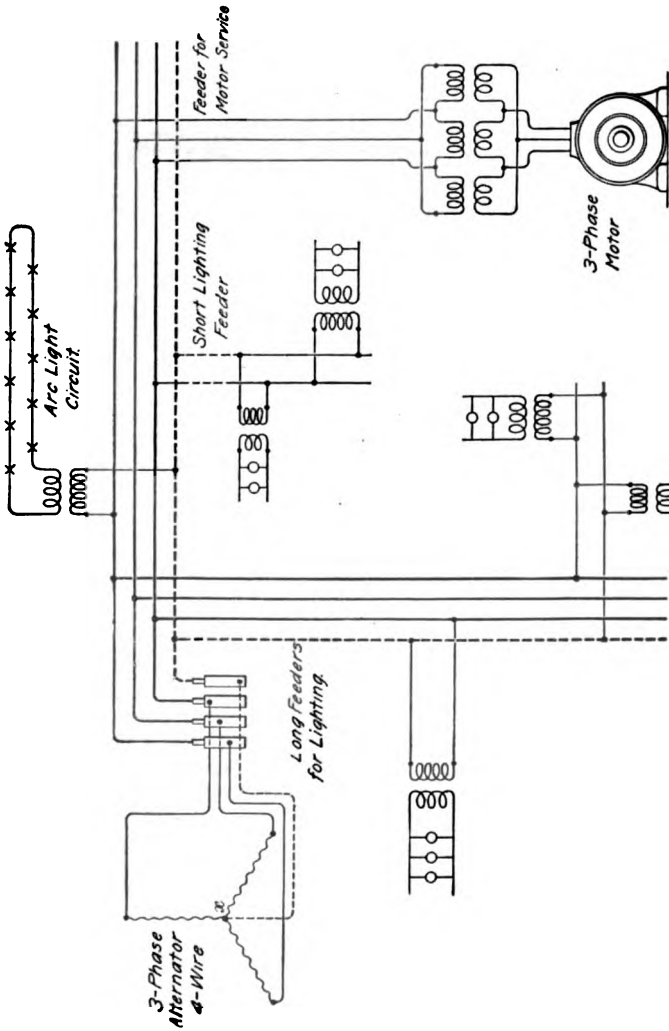

Fig. 17

that may arise can be compensated for by means of feeder potential regulators. In most stations where a number of feeders run out to points varying in distance from the station, these regulators are provided anyway, in order that the voltage supplied to the lamps may be under control.

In some cases where lights are operated from a three-phase alternator, the four-wire three-phase system is used. This is shown in Fig. 16. The secondaries of the transformers *A* are \mathbf{Y} -connected and are wound to give the voltage required by the lamps. The fourth wire is brought from the common connection of the \mathbf{Y} winding, and the various single-phase circuits are connected between the fourth wire and the other three as shown. In this case the feeder running from the station is three-phase and the lamps are fed from the four-wire secondary mains. The voltage between any pair of the three mains connected to the terminals of the \mathbf{Y} winding would be $E \times \sqrt{3}$, where E is the lamp voltage. Since these mains are three-phase, induction motors can be operated from them; if 126-volt lamps were used, standard 220-volt motors could be run from the same mains.

Fig. 17 shows a lighting system in which the three-phase alternator is provided with a fourth collector ring connected to the common junction of the winding; a fourth bus-bar is connected to this ring. This fourth wire acts as a common return, and the single-phase feeders can be connected across any one of the three armature windings. For supplying lights to distant points, long four-wire feeders may be run out, and the lights or motors in the district supplied at the end of the feeders can be divided so as to secure an approximately balanced load. The action of the four-wire three-phase system is somewhat similar to the ordinary three-wire direct-current system.

21. Mixed Systems.—In many large cities, extensive installations on the Edison three-wire system have been made in the past for the operation of both lights and direct-current motors. These were supplied from stations

located as close as possible to the distribution centers. As the area to be supplied spread, and as alternating current became more extensively used for power-transmission work, these companies adopted the plan of supplying the existing direct-current systems with power from substations supplied with alternating current from one central station, or perhaps from a distant water-power plant.

Fig. 18 shows the scheme referred to. Alternating current is transmitted from the central station at *A*, usually by means of the three-phase system, to the substations *B* or *C*, where it is stepped-down by means of transformers *T, T, T*. The current may then be sent through rotary converters *R, R* and fed into a three-wire system, as shown, or it may be fed to an alternating-current motor *M* that is coupled to direct-current machines *O, O*. Sometimes arc lights are also supplied from these substations by coupling alternating-current motors to arc-light dynamos.

A large amount of lighting is carried out, especially in cities, by using the plan just described. Fig. 19 shows a motor-generator set used for transforming from three-phase alternating to three-wire direct current. The three-phase synchronous motor *A* receives current from transformers after it has been stepped-down from the high-tension line that transmits it from the central station. The motor drives the two direct-current dynamos *B* and *C*, which are connected in series and supply current to the three-wire system.

For electric-lighting work, the use of a synchronous motor driving direct-current generators gives better results than rotary converters, because the former arrangement maintains a steadier voltage on the direct-current side, a feature of great importance in connection with incandescent lighting. If the voltage supplied to the alternating-current side of a rotary converter varies, the direct-current voltage will also vary. Consequently, all the bad effects of drop in the alternating-current transmission line are felt on the direct-current side, and therefore cause fluctuations in the lamps. If, however, synchronous motors are used to drive separate direct-current machines, the speed of the motor will

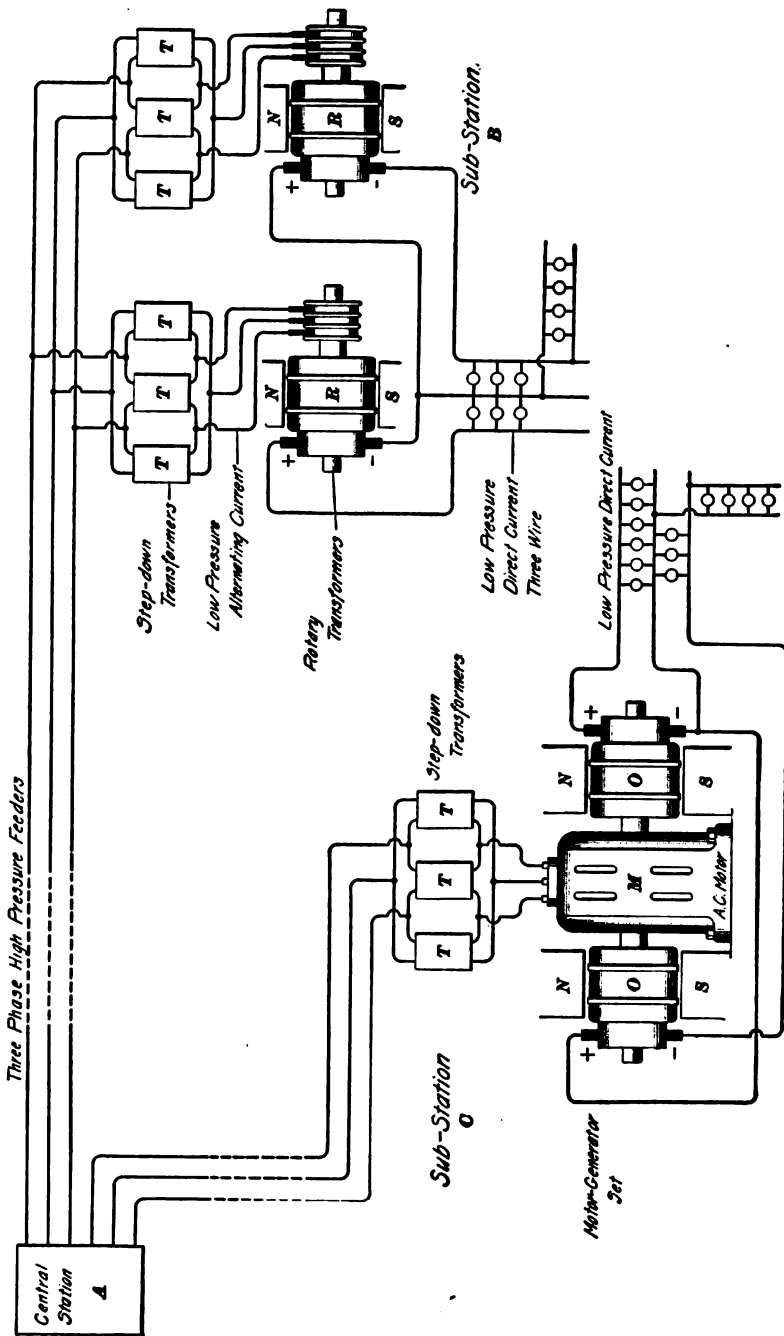

FIG. 18

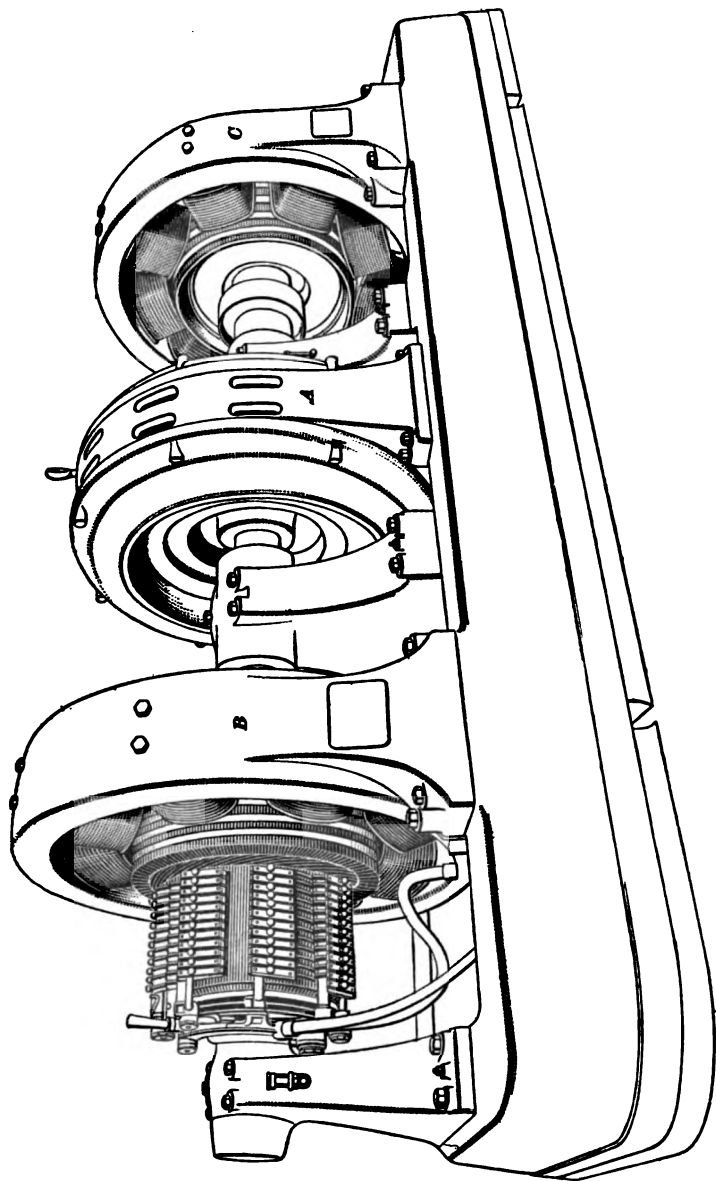

FIG. 19

be constant so long as the speed of the distant dynamo is constant, no matter what may be the fluctuations in the voltage delivered, because the motor is bound to run in synchronism; the direct-current machines will therefore deliver a steady voltage, because of the constant speed. For similar reasons, synchronous motors are better than induction motors for this work, the latter giving variable speed and lower power factor.

22. The use of constant-potential alternating current of the two-phase or three-phase variety allows a great flexibility in the kind of apparatus operated from one station. If it is necessary to have direct current for any purpose, the transformation is easily effected. In general, where rotary converters or alternating-current motors are used, it is desirable to have a low frequency, say, about 25 or 40. On the other hand, the frequency should not be below 30 or 40 cycles per second if the current is to be used for incandescent lighting. A high frequency calls for less expensive transformers, and between all these requirements, which are more or less conflicting, a frequency of 60 has been very generally adopted for systems where the current is used both for light and power.

23. **Frequency Changers.**—In some cases, the conditions may be such that the greater part of the current on an alternating system is utilized at low frequency for general power purposes or for the operation of rotary converters. However, part of the current may be required for lighting work, for which a higher frequency is desirable. For example, the frequency generally used might be 25 cycles per second, whereas, the frequency required for alternating-current arc lamps should not be below 50 cycles per second. To change from one frequency to another, **frequency changers** are used. Thus, a low-frequency synchronous or induction motor can be coupled to a higher frequency alternator. Synchronous motors are generally used in preference to induction motors for this purpose. The Stanley inductor alternator in slightly modified form can

be used as a frequency changer. This machine is double, having two sets of revolving polar projections and two armature windings. One side of the machine can, therefore, be provided with a different number of poles and a different winding from the other. For example, one side might have half as many poles as the other and operate as a synchronous motor; the other side will then operate as an alternator and the machine will constitute a frequency changer, changing from one frequency to twice that frequency. By winding the two sides of a frequency changer for different voltages, the machine can, if necessary, be used to transform the voltage at the same time that the frequency is changed.

PROTECTION OF SECONDARY CIRCUITS

24. Alternating current is used for lighting work because it allows a high pressure for transmitting the current from the station. It is necessary, however, to use a low pressure for operating the lamps, because it is practically impossible to devise a system of house wiring that is safe under high pressure, and, moreover, incandescent lamps cannot be constructed for high pressure. On alternating-current lighting systems, therefore, the pressure on the line is much higher than that supplied to the consumer; for example, the line pressure may be 2,000 volts and the lamp pressure 100 volts. On this account it is very important that the secondary winding should never come in contact with the primary, because the presence of the high voltage on the secondary wiring is dangerous. A number of deaths from shock can be traced to this cause; in fact, this element of danger was at one time advanced as an argument against the use of alternating current for lighting purposes.

In Fig. 20, let P represent the primary coil of a transformer connected to high-tension mains and S the secondary coil connected to the house wiring that supplies the lamps l, l . Suppose that the insulation between the primary and secondary coils breaks down at the point a ; also, suppose that there is a partial ground on one of the primary lines e and that a person

standing on the ground, or in connection with anything that can conduct current to the ground, touches one of the wires *b*, say, by touching an exposed lamp base or lamp socket. A path through the person's body is at once established and the high-tension current is free to flow, as indicated by the arrows. The shock resulting from such a current has proved fatal in many cases. There is almost always more or less of a ground on high-tension lines, because it is practically

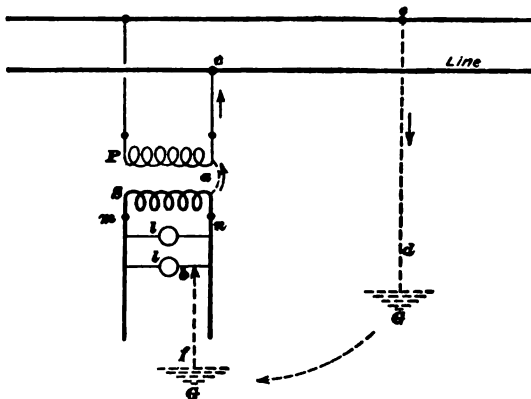

FIG. 20

impossible to maintain perfect insulation where wires are strung in the air and make contact with trees. A ground between primary and secondary, therefore, results in a very dangerous condition, the more so because there is nothing to indicate that such a condition exists until some accident happens. The same condition will arise in case the primary wires in any way become crossed with the secondary wires leading from the transformer.

25. Breakdowns between primary and secondary may be due to defective insulation, or they may be caused by a high-potential discharge, such as a stroke of lightning. The insulation in the older styles of transformer was by no means as good as that now employed; it gradually became decomposed under the long-continued heating, in many cases being affected so that it had very little mechanical strength and thus provided insulation of a very poor order. Any

abnormal rise in voltage was almost sure to break down the insulation of such transformers, and the breakdown was usually followed by a burn-out. In modern transformers, the working temperature is kept down by careful design and efficient ventilation. Much attention has been paid to the character of the insulation, and the use of oil, together with the better insulation, has resulted in a great reduction in the number of breakdowns due to lightning or other causes. No transformer should be put into service that cannot stand a high-potential breakdown test between its primary and secondary. For example, an ordinary 2,000-volt lighting transformer should stand a test of at least 6,000 volts between primary and secondary; some manufacturers give a test of 10,000 volts. In Fig. 20, if the secondary were permanently connected to the ground, as at *fb*, a person touching either side of the secondary could never receive a shock greater than that due to the secondary voltage.

In order to prevent accidents, a number of protective devices have been invented to ground the secondary automatically whenever a breakdown occurs, or whenever the pressure between the secondary wiring and the ground becomes abnormally high. These devices are not used very extensively; yet, while they may not always be reliable in their action, they render the system safer.

26. Thomson Protective Devices.—Fig. 21 shows a protective device invented by Prof. Elihu Thomson. It consists of copper shields *c, c* placed between the primary and secondary coils in such a manner that any connection between the coils must take place through the shield, which is connected to the ground. If, therefore, a breakdown takes place between primary and secondary, the latter becomes grounded and thus protects the secondary system.

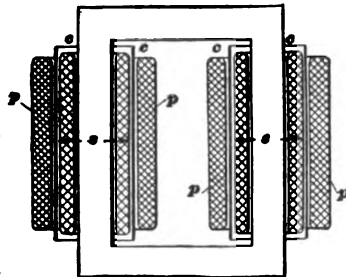

FIG. 21

The ground shield is not, however, a positive protection under all conditions and is now seldom used. A short circuit may burn a hole through the shield, or the primary- and secondary-coil terminals may touch each other outside

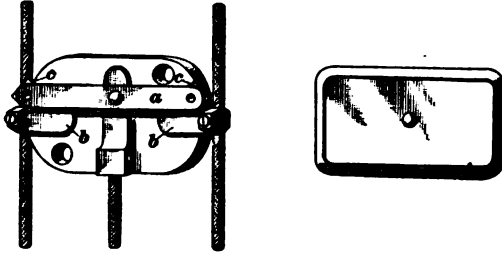

FIG. 22

the shield. Moreover, the ground shield makes the transformer more difficult to construct and insulate properly. If ground shields are used, they must not form a complete circuit around the transformer core, otherwise they will act as a short-circuited secondary and heavy currents will be induced in them.

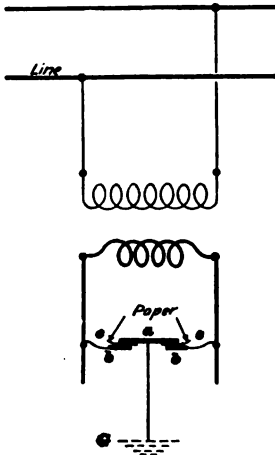

FIG. 23

27. Figs. 22 and 23 show another Thomson protective device. Its operation will be understood by referring to Fig. 23. The plate *a* is connected to the ground and plates *b, b* are connected to the secondary lines. Plates *a* and *b* are separated from each other by pieces of thin prepared paper *c, c* that are easily able to stand the normal secondary voltage. If, however, the primary and secondary become connected, or if the secondary voltage in any way becomes excessive, either one or both of the

films *c, c* break down, thus grounding the secondary. If both films break down at the same time, the secondary will be short-circuited and will cause the primary fuses to blow, thus cutting off the transformer. As far as the automatic

grounding of the secondary is concerned, it would be sufficient to provide but one protective film on one side of the secondary, but it is usual to provide two, because one may fail to work.

28. Permanent Grounding of Secondary.—The most effective way of overcoming the danger due to crosses between primary and secondary is to ground the secondary permanently. It is true that there are objections to grounding, and it is a practice that has not been generally followed. Many station managers are not in favor of it for the following reasons: If the secondary is permanently grounded, another ground will establish a short circuit and cause an interruption of the service, whereas, with an ungrounded secondary, two grounds are necessary to give rise to a short circuit. The grounding of one part always makes the tendency greater for a ground to develop at some other part and thus increases the fire-risk due to leakage current to ground on the secondary wiring. It is claimed by those opposed to this practice that the ground connection invites trouble from lightning. The Fire Underwriters at one time would not permit grounding because of the additional fire-risk introduced, but it is now permitted, so that there is no objection to the practice so far as fire-insurance is concerned. If the secondary wiring is not good enough to withstand the additional strain put on it because of grounding the system, it is time that the wiring was remodeled. It is safe to say that this objection carries little weight if the wiring is put up in accordance with the Underwriters' requirements. The weak point in most secondary systems is not in the wiring proper, but at the fixtures and outlets. There is no question but that the permanent grounding of the secondary renders the system safer so far as danger to life is concerned, and if a company does not make a practice of grounding, it should at least take the precaution of testing the insulating properties of the transformers at regular intervals as well as before they are put into service. This does not necessarily mean that the

transformers must be taken down; they can be subjected to a high-potential test by means of a small portable testing transformer.

In case transformers supplying a two-wire secondary system are grounded, the ground connection is made from

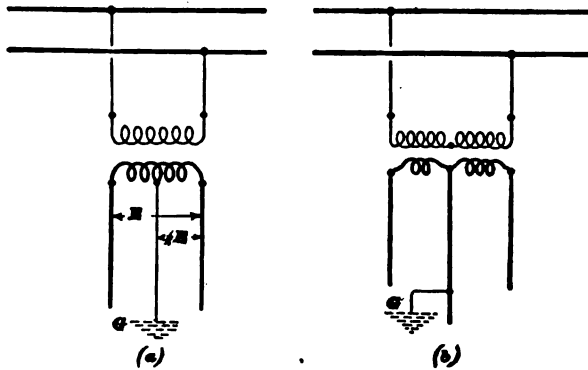

FIG. 24

the middle point of the secondary coil, as shown in Fig. 24 (a). This reduces the strain on the secondary insulation to half what it would be if either secondary line were grounded. If the secondary system is three-wire, as in Fig. 24 (b), the neutral or middle wire is grounded.

GROUNDING OF NEUTRAL ON THREE-WIRE DIRECT-CURRENT SYSTEM

29. The grounding of the neutral wire of three-wire, secondary, alternating-current systems protects the secondary from high-tension primary currents, and therefore is desirable on the score of safety. There has been a great deal of discussion as to the advisability of grounding the neutral on low-pressure, direct-current, three-wire systems. The argument as to safety from shock does not apply here with the force that it does with alternating-current secondary systems fed from high-tension primary lines. In direct-current three-wire systems, the pressure between the outside wires is seldom over 450 volts, and in most cases it does not

exceed 250 volts, neither of which is high enough to be, under ordinary conditions, dangerous to life. If the neutral wire is grounded permanently, the maximum pressure that can exist between either of the outside wires and the ground is one-half the voltage between the outside wires; whereas, if the neutral is not grounded, the pressure existing between one outside wire and the ground would be equal to the full pressure between the outside wires in case a ground developed on the other outside wire. This fact has been advanced as an argument in favor of grounding of the neutral, but it is evident that it does not carry the same weight with direct-current systems as with alternating, because with the latter the voltage between the lines and ground may, under certain circumstances, become as high as that on the primary, while with the former it can never be greater than the voltage between the outside lines.

It has also been claimed that by grounding the neutral, the earth helps the conductor to carry the current, and thus improves the voltage regulation, particularly on unbalanced loads when the current in the neutral is considerable. This, however, is a doubtful advantage because, if large currents are allowed to flow through the ground or through neighboring pipes, electrolytic action will set in wherever current flows from the pipes or other conductors into the moist earth, thus causing corrosion. When the neutral wire is grounded, a ground on either of the other wires will lead to a short circuit, whereas with an ungrounded neutral two grounds are necessary. On small systems, where a ground can be readily located and cleared before another ground develops, it is not customary to ground the neutral. It must be remembered that when the neutral is grounded, the maximum pressure that can exist between the outside wires and the ground is limited to one-half the voltage between outside wires; hence, the pressure that may be acting on defective insulation to start a leak to ground can never be as great as if the neutral were not grounded. At the same time, a permanent ground on the neutral invites grounds on other parts, and for a long time the Fire

Underwriters would not allow the neutral to be grounded; grounding is now permitted by their rules.

If a three-wire system is carrying an unbalanced load of lamps, and if the fuse in the neutral blows, it is evident that the lamps on the lightly loaded side will receive an excessive voltage, and are apt to be burnt out. On this account, the neutral is often not fused at all; or if it is, a heavier fuse is used than on either of the outside wires.

If fuses are used on the neutral branches as well as on the outside wires, the risk of blowing neutral fuses is reduced if the neutral is grounded. Suppose, for example, that the neutral is not permanently grounded and that a ground occurs on the positive main feeder; suppose, also, that a ground occurs on a branch neutral line. The fuse on the branch neutral will blow because it is much smaller than the fuse protecting the main feeder, and the result will be a burn-out of lamps. If, however, the neutral is grounded at the dynamo, a ground on either positive or negative will blow one of the outside fuses and no danger to the lamps can result.

On large three-wire systems, where an extended network is supplied through underground cables or Edison underground tubes, the neutral is generally grounded, as the advantages of grounding outweigh the disadvantages; for small systems or for isolated plants it is better on the whole to keep the neutral insulated.

ALTERNATING-CURRENT, CONSTANT-CURRENT SYSTEM

GENERAL DESCRIPTION

30. The **alternating-current, constant-current system** is used for series incandescent street lighting and is well adapted for suburban districts or residence streets in cities that are so shaded by trees as to make arc lighting difficult. It is also an excellent system for street lighting in small towns and villages, because it can be operated from the same generating outfit used for constant-potential

interior lighting and the cost of the street-lighting outfit is smaller than would be required for arc lighting. Moreover, it requires very little work to keep the lamps in running order, as compared with arc lamps, and street lighting can often be carried out by this system where arc lighting would not pay. Of course, street incandescent lamps could be operated from constant-potential transformers in the usual manner, but this class of lighting is usually so scattered that parallel distribution at low pressure is out of the question. The series arrangement uses a small current at high pressure and hence requires but a small amount of line wire.

Series incandescent circuits are operated from the regular constant-potential alternators. For example, in Fig. 25, *A*

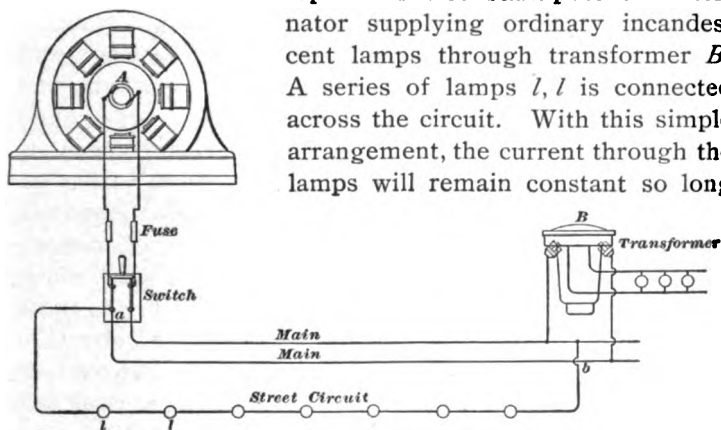

FIG. 25

represents a constant-potential alternator supplying ordinary incandescent lamps through transformer *B*. A series of lamps *l, l* is connected across the circuit. With this simple arrangement, the current through the lamps will remain constant so long as no lamps burn out. If one or more lamps burn out, the current will increase because the voltage generated by *A* remains constant and the reduction in the number of lamps lowers the resistance of the circuit. Each lamp must be provided with a device of some kind that will automatically maintain the circuit around a lamp in case it burns out, otherwise the whole series of lamps will be extinguished. The number of lamps on the circuit is fixed by the line voltage and the voltage per lamp. Thus, if 20-volt lamps

were used on a 1,000-volt system, there would necessarily be fifty lamps in each series circuit, neglecting the volts lost in the line. In order to operate series circuits successfully, means must be provided for varying the voltage applied to the circuits so that the current can be maintained at a constant value within narrow limits irrespective of the number of lamps in operation. The variation in voltage should also be such as to admit of considerable range in the number of lamps operated on a circuit, because in many cases the lamps required on a given circuit might not be large enough to take up the full voltage of the alternator.

LAMPS

31. The lamps used for series circuits are similar to ordinary multiple lamps except that the filament is heavier. In the past, $3\frac{1}{2}$ - or $5\frac{1}{2}$ -ampere lamps having an efficiency of 3.5 or 4 watts per candlepower have been used, depending on

the length of the circuits and the available voltage. In later installations, the tendency is to use higher voltage lamps taking a smaller current of about 1.75 amperes. These lamps are cheaper than those designed for the larger currents, thus making the cost for renewals less and decreasing the line loss. In the Westinghouse system, which is described later, ordinary

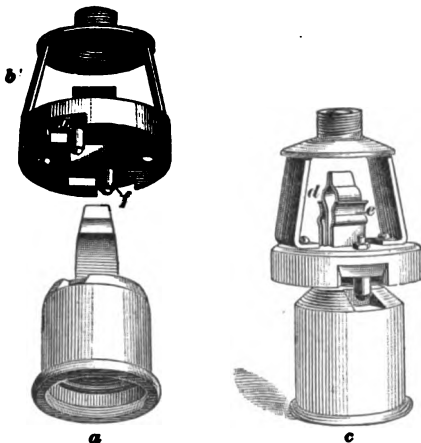

FIG. 28

50-volt or 100-volt lamps are used. The line must be strong enough to withstand storms, hence the wire cannot be made less than No. 6 or 8 B. & S., and the use of lower current lamps does not effect any saving in the cost of the line.

To maintain the continuity of the circuit around burned-out lamps, a film cut-out is very commonly used. This consists of a thin piece of paper held between springs connected to the terminals of the lamp. As long as the lamp is burning, the pressure to which the film is subjected is equal to the drop through the lamp, but if the lamp burns out, the circuit is momentarily interrupted, and the pressure existing between the two sides of the film rises for an instant to full line pressure. The excessive pressure punctures the paper, thus allowing the springs to touch and maintain the circuit around the lamp. In the older types of lamp, the film cut-out was placed in the lamp base. In later outfits, the film cut-out is

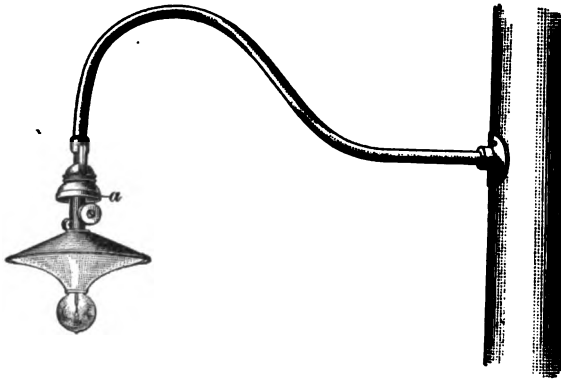

FIG. 27

placed in a special socket, Fig. 26, so that the lamp base is the same as on an ordinary lamp. The lamp screws into the socket *a*, the projecting part of which carries two brass contact springs between which the film cut-out is placed. The receptacle *b* is attached to the supporting bracket and the line wires connect to terminals at *f, g* to which are attached contact springs *d, e*, shown in *c*, which also serve to hold the socket when it is pushed into place. When a socket is pulled out in order to replace a film cut-out, springs *d, e* touch each other before the socket is entirely removed, thus preventing the circuit from being broken. Fig. 27 shows the lamp bracket complete with its reflector. Since the pressure

on these circuits is high, it is necessary to provide thorough insulation from ground. A triple-petticoat, 10,000-volt insulator is, therefore, inserted between the lamp receptacle and the gooseneck, as indicated at *a*.

CURRENT REGULATORS

32. Lamp-Board Regulator.—Many different devices have been used for maintaining the current on series incandescent circuits at a constant value. The first method was to insert a few lamps in series with each circuit in the station and have a switch arranged so that as many of these lamps as desired could be cut into circuit. An ammeter was also included and whenever the current increased because of a lamp going out on the line, the station attendant cut in a lamp in the station to take its place and bring the current back to normal value. This was a very inefficient method of regulation and if the attendant were not prompt to notice the increase in current, the lamps on the circuit might be subjected to an excessive voltage for some time, thereby shortening their life.

33. C R Regulator.—The C R Regulator of the General Electric Company consists of an autotransformer with secondary taps brought out to a multipoint switch whereby the pressure of the secondary of the transformer can be added to or subtracted from the voltage of the lines. This regulator gives a wide range of regulation and is very efficient, but it is not automatic and has been superseded by other methods by which the current is automatically maintained at the correct value. It is very important that the current on series incandescent circuits shall never exceed the allowable amount, even for short intervals. This can easily happen if the regulator does not operate automatically or if it is not capable of maintaining constant current throughout a very wide variation in the number of lamps on the circuit. For example, two grounds might occur on a circuit and thus cut out a large number of lamps throwing an excessive current on the remaining lamps unless the regulator acted promptly.

34. Reactance-Coil Regulator.—To secure automatic regulation, a special type of reactance coil has been used in some cases; Fig. 28 (a) illustrates the principal features of the arrangement. The constant-potential alternator *a* supplies current to the mains across which the lamp circuit is connected in series with a reactance coil *c*. The coil is suspended from a sector *d* and is counterbalanced by weights *e*. Any tendency for the current to increase causes the coil to be drawn down over laminated core *b*, thus increasing the reactance of the coil and keeping down the current to normal value. A properly designed coil will maintain the current

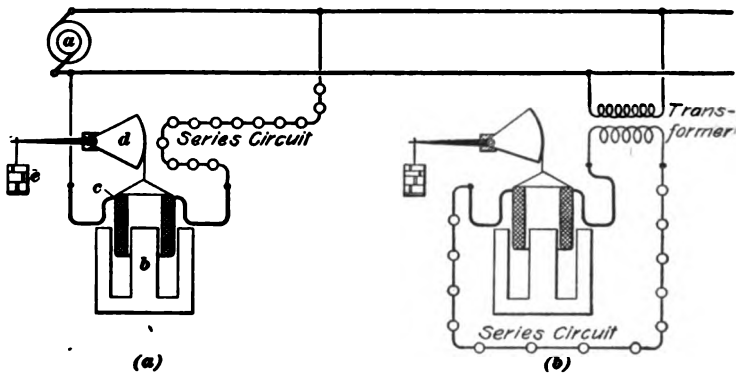

FIG. 28

constant within narrow limits, and as it operates automatically, the danger of straining the lamps by the application of an excessive voltage is reduced to a minimum. An objection to the arrangement shown in (a) is that the series circuit is in electrical connection with the alternator and a ground on the circuit grounds the main distribution system.

A series circuit is usually long and grounds are quite liable to occur, hence, it is a good plan to have it completely separated from the main system by inserting a transformer, as in Fig. 28 (b). It should be particularly noted that with an automatic regulator it is not necessary to place the regulator in the station. It may be placed out on the line and connected to the primary mains at whatever

point may be most convenient, thus effecting a considerable saving in line wire and a corresponding reduction in line losses. In some cases the regulators have been placed in boxes mounted on poles.

35. Constant-Current Transformer.—The most recent development in the line of regulating devices for series alternating circuits is the **constant-current transformer**. This combines, in one device, the advantages of the automatic reactance coil and insulating transformer, and is somewhat cheaper and more efficient than the latter combination shown in Fig. 28 (b). Fig. 29 shows the main features of the General Electric constant-current transformer system. The transformer has two flat coils—a primary b that is fixed and a secondary c that is suspended from e and counterbalanced by weight f .

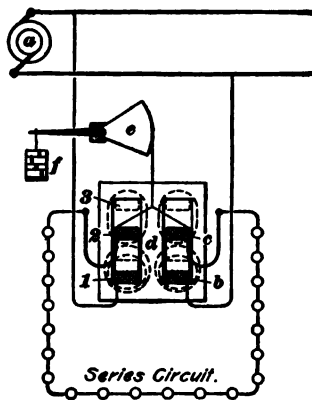

FIG. 29

Coil c slides up or down over the laminated core d and when it occupies the position 1 , where it rests on the primary b , the secondary furnishes its maximum E. M. F. and operates the maximum number of lamps. The counterweight is adjusted to balance the weight of the movable coil less the electrical repulsion that exists between the two coils when current is flowing.

If the secondary is in position 1 and a number of lamps are cut out, the repulsive action increases because of the momentary increase in current and the secondary moves up to some such position as 2 , where the current is restored to normal value by a corresponding reduction in the secondary E. M. F. The secondary E. M. F. decreases as coil c moves up from b , because of the magnetic leakage that takes place between the coils, as indicated by the dotted lines; the greater the separation of the coils, the greater is the leakage and the less is the secondary E. M. F. When the secondary

occupies position 3 (position corresponding to short circuit), the E. M. F. applied to the series circuit is very low. This device can be made to give very close regulation, but it is advisable, if the transformer is operated at less than half load, to block the coils so that, before the circuit is plugged in, they are about an inch farther apart than the normal

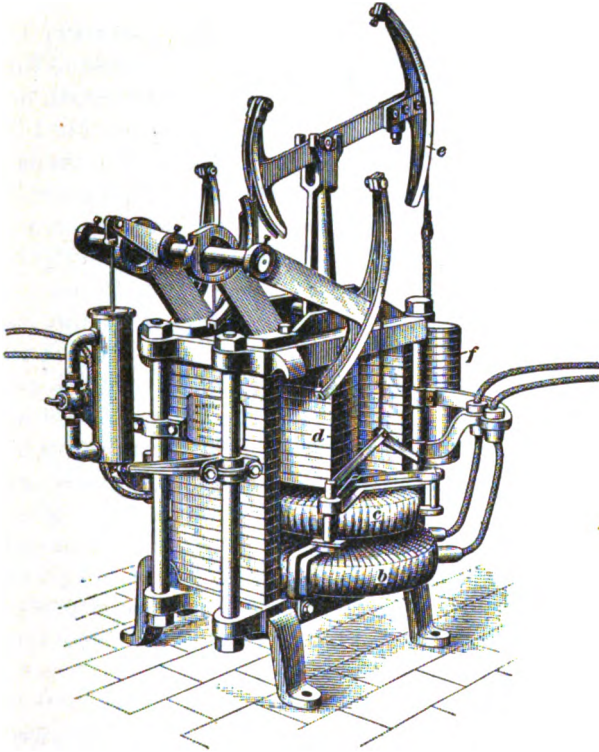

FIG. 30

operating position. This prevents an abnormal current during the short interval required for the movable coil to adjust itself and avoids strain on the lamps.

Fig. 30 shows an 8.8-kilowatt constant-current transformer in which the coils, core, etc. are lettered to correspond with Fig. 29; *g* is a dashpot provided with a by-pass and close-fitting piston. By means of the by-pass, the steadying action

of the dashpot can be adjusted. The levers connected to the counterweight and dashpot are suspended on knife edges and by reducing the counterweight the secondary current

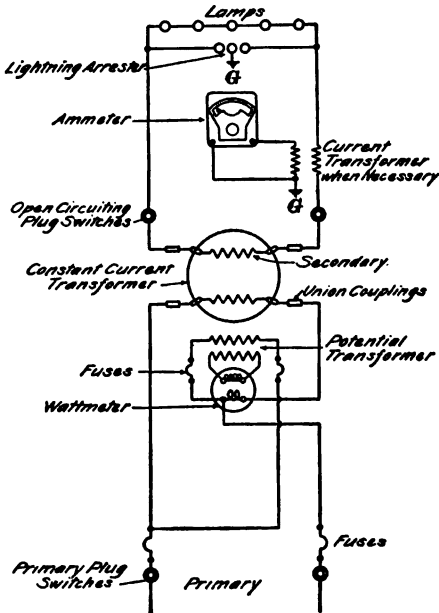

FIG. 31

is increased and vice versa, so that the secondary current can be adjusted within limits. The primary coil is usually wound for 1,100 or 2,200 volts and the secondary for 1.75, 3.5, 5.5, or 7.5 amperes, depending on the character of the circuit, and each transformer or set of transformers is connected to the line and alternator through a small switchboard.

Fig. 31 shows the connections for a transformer switchboard supplying a single circuit; it is equipped with a recording wattmeter, potential transformer, plug switches, ammeter, and lightning arrester. With primary pressures less than 2,500 volts, it is not necessary to use a current transformer with the ammeter.

Fig. 31 shows the connections for a transformer switchboard supplying a single circuit; it is equipped with

36. The series incandescent street-lighting devices used by the Westinghouse Company are considerably different from those described, in regard to the method of compensating for burned-out lamps. Ordinary 50-volt or 100-volt lamps are used; for example, on a 1,000-volt circuit, twenty 50-volt or ten 100-volt lamps would be connected in series. The operation of the Westinghouse device will be understood by referring to Fig. 32. *L, L, L* represent a series of ten 100-volt lamps connected across the 1,000-volt

mains M . Across the terminals of each lamp, a coil c wound on a laminated iron core d is connected so that the coil is in shunt with the lamp under ordinary working conditions. As long as the lamp is unbroken, only a very small current passes through the shunt coil; just enough current will flow to magnetize the coil sufficiently to generate a counter E. M. F. of 100 volts. When the lamp burns out, the whole current passes through the shunt coil, or *shunt box*, as it is often called, and as the iron in the core is worked at a point near saturation, the counter E. M. F. rises but slightly over 100 volts, although the current through the coil is very much greater than it was before the lamp broke. The coil, therefore, takes the place of the lamp and introduces into the

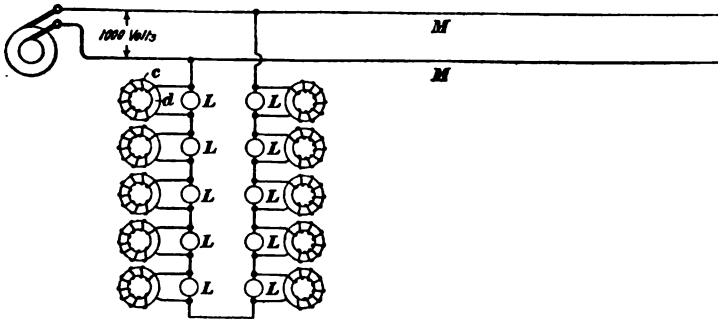

FIG. 32

circuit a counter E. M. F. of slightly over 100 volts to take the place of the lamp. The current remains about the same and the life of the remaining lamps is not endangered. If as many as four or five lamps are out at once, the remaining lamps become somewhat dim on account of the fact that each shunt coil introduces a little higher counter E. M. F. than the amount of the drop through the lamp that it replaces. This arrangement does not, therefore, maintain an absolutely constant current.

Like the arrangement shown in Fig. 28 (*a*) this system has the disadvantage of direct electrical connection between the series circuits and the main system, but this can be avoided by separating the two by means of a transformer.

LINE CALCULATIONS

TWO-WIRE AND THREE-WIRE DIRECT-CURRENT SYSTEMS

37. The methods for calculating the size of wire required to transmit a given current over a given distance with a certain allowable drop are the same as those used for the calculation of power-transmission lines, though sometimes the formulas are put in a slightly different form so as to be more directly applicable to the subject of electric lighting.

The formula that is most generally applicable is the following:

$$A = \frac{21.6 DI}{e} \quad (1)$$

where A = required area of cross-section of wire, in circular mils;

D = distance, in feet (one way), to point where current is distributed;

I = current, in amperes, transmitted;

e = drop, in volts.

In making line calculations in connection with electric lighting, some judgment must be exercised in choosing the value of the distance D . This is not the distance to the first lamp supplied nor the distance to the farthest lamp, but the distance to the center of distribution; in other words, the distance to the point at which we might imagine all the lamps to be grouped. The product of the distance D to the center of distribution and the current I is often spoken of as the ampere-feet of the circuit; hence, we may write the rule as follows:

Rule.—*The area, in circular mils, required for a two-wire circuit is found by multiplying the ampere-feet by 21.6 and dividing by the drop, in volts.*

38. Center of Distribution.—The distance D to the center of distribution will be best understood by taking a few cases illustrating the point. Consider a number of

lamps *l, l*, Fig. 33, arranged as shown and fed by the dynamo *A*. The distance from the dynamo to the first lamp is 1,000 feet, and the lamps are spaced out over a distance of 100 feet. The whole of the current would have to be transmitted through the first 1,000 feet, but from that point it would gradually fall off. We may then take the

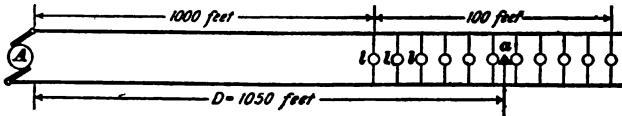

FIG. 33

point *a* as the center of distribution, because the load is about equally distributed on each side of this point, and the distance *D* used in the formula would be 1,050 feet.

Take the case shown in Fig. 34, where the lamps are spaced evenly all the way along the line. In this case, the center of distribution *a* may be taken as the middle, and

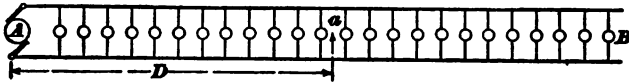

FIG. 34

hence the distance *D* is only one-half the length of the line from *A* to *B*. The exact location of the center of distribution becomes more difficult to determine when the load is unevenly spaced or distributed, but in most cases it can be located close enough for practical purposes by laying out the system and noting carefully the loads on the different circuits.

39. Current Estimation.—The current can be readily determined when the nature of the load is known. The general practice is to allow $\frac{1}{2}$ ampere for each 16-candlepower lamp and 1 ampere for a 32-candlepower lamp on 110-volt circuits. Some prefer to make calculations for lighting circuits by using *lamp-feet* instead of ampere-feet. The number of **lamp-feet** is the product of the number of 16-candlepower lamps to be supplied and the distance to the center of distribution. When this term is used, it

always implies the use of 16-candlepower lamps; if any 32-candlepower lamps are operated, each lamp must be counted as two 16-candlepower, etc. If lamp-feet are used, the formula becomes

$$A = \frac{10.8 D N}{e} \quad (2)$$

where A = area, in circular mils;

D = distance, in feet, one way to center of distribution;

N = number of lamps (expressed in terms of 16-candlepower lamps);

e = drop, in volts.

Rule.—*To determine the area of cross-section for a two-wire 110-volt circuit, multiply the lamp-feet by 10.8 and divide by the drop, in volts.*

40. This rule is here given because it is frequently used. Formula 1 is, however, much to be preferred, because formula 2 assumes that each lamp takes $\frac{1}{2}$ ampere, and this may not always be the case. Formula 1 is applicable to any case because the current is used in it, and this current is determined from a knowledge of the devices to be operated.

EXAMPLE 1.—A dynamo A , Fig. 33, delivers current at 110 volts to fifty lamps distributed about a as a center. The drop must not exceed 10 volts. Find the size of wire required.

SOLUTION.—The distance to the center of distribution is here 1,050 feet, as already explained. The current will be 25 amperes, because each lamp will take $\frac{1}{2}$ ampere. Using formula 1,

$$A = \frac{21.6 \times 1,050 \times 25}{10} = 56,700 \text{ cir. mils. Ans.}$$

A No. 3 B. & S. wire would likely be used.

EXAMPLE 2.—A dynamo A , Fig. 35, supplies current through the feeders b , c to the feeding-in point a . From this point lamps are supplied by means of the mains d , e and f , g . The number of 16-candlepower lamps and the various distances are shown in the figure. The total drop in voltage from the dynamo to the last lamp must not exceed 15 volts, of which 13 volts is to be in the feeders and 2 volts in the mains; required: (a) the cross-section and gauge number of the

It will be noticed in this example that although the mains carry a smaller current over a shorter distance than the feeders, they work out about the same size. This is because of the large drop allowed in the feeders compared with that in the mains.

EXAMPLE 3.—Fig. 36 shows a three-wire distributing system. The dynamos *A*, *B* supply current through feeders to the junction box *J*. From this point mains are carried to the buildings where light is to be supplied. The conductors marked mains are sometimes called sub-feeders, because they are really branches of the main feeder and no branches are taken off between the junction box and the end of these lines. The total drop from the dynamo to the lamps is not to exceed 10 per cent. of the lamp voltage, and the pressure at the lamps is to be

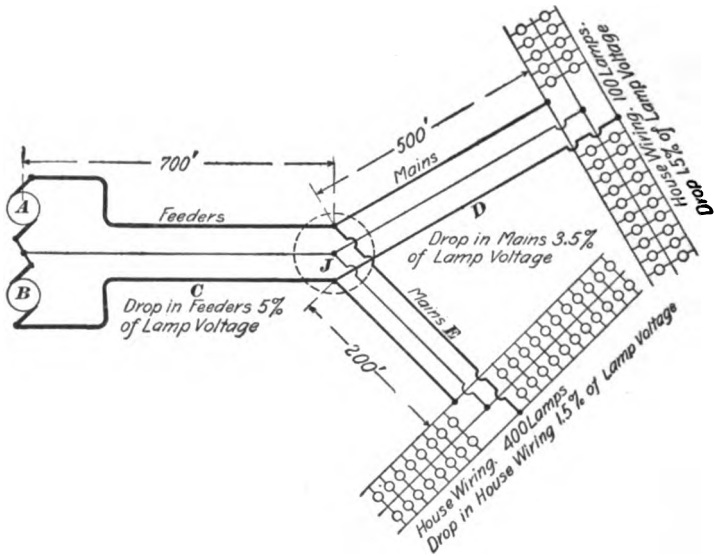

FIG. 36

110 volts. (a) Calculate the size of the feeders *C*. (b) Calculate the size of the mains *D*. (c) Calculate the size of the mains *E*. The calculation of the size of wires required for the house wiring will not be taken up here, as it belongs to interior wiring, and we are only concerned for the present with the outside distributing wires. The pressure at the dynamo will be $110 + (110 \times .1) = 121$ volts. Of the total drop of 10 per cent., 1.5 per cent. will be allowed in the house wiring, 3.5 per cent. in the mains, and the remaining 5 per cent. in the feeders, as indicated in the figure.

SOLUTION.—In calculating the size of the conductors, the system may be considered as a two-wire system, the pressure between the two outside wires at the lamps being $2 \times 110 = 220$ volts and at the dynamo $2 \times 121 = 242$ volts. A neutral wire one-half the size of the outside wires should be amply sufficient. The total current supplied may be obtained as follows:

(a) Each pair of lamps on a 220-volt three-wire system requires $\frac{1}{2}$ ampere; hence, current in line D will be $\frac{14^2}{2} = 25$ amperes. Current in E will be $\frac{42^2}{2} = 100$ amperes. Total current in the feeders C will be 125 amperes. The total drop between the outside wires is $242 - 220 = 22$ volts. The drop in the main feeders is to be 5 per cent. of the lamp voltage, or $220 \times .05 = 11$, or 5.5 volts on each side. The distance to the center of distribution is 700 feet; hence,

$$A = \frac{21.6 \times 700 \times 125}{11} = 171,818 \text{ cir. mils. Ans.}$$

This would call for a No. 000 B. & S. wire for the outside wires from the dynamo up to the point J . The neutral wire could be made about No. 1.

(b) The drop in mains D or E will be $220 \times .035 = 7.7$ volts. The area of mains D will be

$$A = \frac{21.6 \times 500 \times 25}{7.7} = 35,065 \text{ cir. mils. Ans.}$$

This would require a No. 5 wire, and a No. 8 or 9 would be sufficient for the neutral.

(c) The area of mains E will be

$$A = \frac{21.6 \times 200 \times 100}{7.7} = 56,104 \text{ cir. mils, nearly. Ans.}$$

A No. 3 B. & S. wire would probably be used for the outside wires and a No. 6 for the neutral.

CALCULATIONS FOR ALTERNATING-CURRENT LINES

41. A load that consists wholly of lamps possesses very little self-induction, and for ordinary lighting systems, where the distances are short, it is usual to make the calculations for lines carrying alternating current in the same way as was described for the direct-current system. This assumes the power factor to be 1, which is not exactly true. If greater accuracy is required, formulas taking into consideration the power factor should be used. After the primary current has been determined and the distance to the center of distribution is known, the size of the primary line wire can be worked out. The power supplied over the line must be slightly greater than that supplied to the lamps, on account of the loss in the transformers. This loss

will depend, of course, on the efficiency of the transformer; some of the older styles had a low efficiency, but very little power is wasted in transformers of modern make. Table I gives the average efficiency at full load, as attained by good transformers.

TABLE I
EFFICIENCY OF TRANSFORMERS

Output Watts	Efficiency Per Cent.	Output Watts	Efficiency Per Cent.
1,000	94.8	7,000	96.80
2,000	95.7	8,000	96.85
3,000	96.2	9,000	96.90
4,000	96.4	10,000	96.95
5,000	96.6	15,000	97.20
6,000	96.7		

42. In order to illustrate the calculation of primary mains, consider the case shown in Fig. 37.

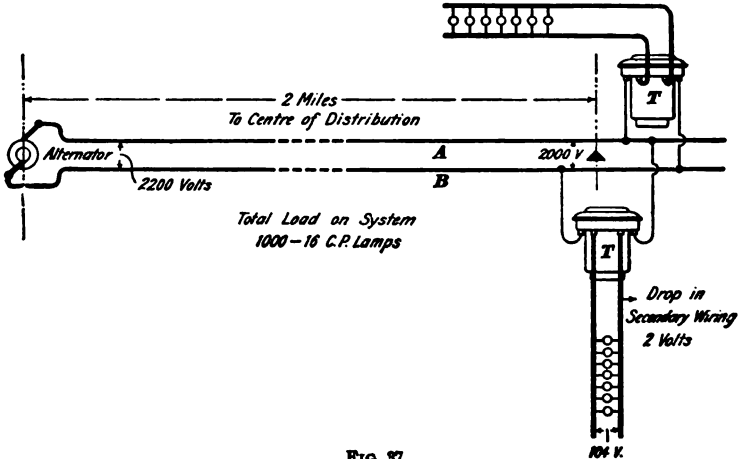

FIG. 37

EXAMPLE.—Current is supplied to the transformers *T* by means of the primary mains *A*, *B*. The pressure at the lamps is to be 104 volts and one thousand 16-candlepower lamps are to be operated from the secondaries. The pressure at the transformer is to be 2,000 volts at

full load and the drop in the primary mains 200 volts, thus making the voltage at the alternator 2,200 volts at full load. The loss in the secondary wiring at full load must not exceed 2 volts, and the lamps require 3.5 watts per candlepower. The average efficiency of the transformers may be taken at 96 per cent. Required the cross-section of the primary wires, assuming the power factor to be 1.

SOLUTION.—Each lamp requires $16 \times 3.5 = 56$ watts, and one thousand lamps will require 56,000 watts in the secondary circuit at the lamps. The total secondary current will be $\frac{56,000}{220} = 254.5$ amperes, and since there is a drop of 2 volts in the secondary wiring, the number of watts lost will be 254.5×2 , and the total watts delivered by the secondary must be $56,000 + 254.5 \times 2 = 57,077$, nearly. The watts delivered to the primaries would be $\frac{57,077}{.96} = 59,455$, and since the primary voltage of the transformers is 2,000, the primary current will be $\frac{59,455}{2,000} = 29.73$ amperes, nearly. Having determined the primary current, we can now calculate the size of the line. The distance in this case is 2 mi., or 10,560 ft., and the drop 200 volts. Using formula 1 and considering the problem the same as for a direct-current circuit,

$$A = \frac{21.6 \times 10,560 \times 29.73}{200} = 33,906, \text{ approximately. Ans.}$$

This would call for a No. 5 B. & S. wire.

43. For rough calculations of the primary current on 1,000-volt and 2,000-volt primary mains, the following allowance per lamp may be used:

TABLE II
CURRENT ALLOWANCE PER LAMP

Candlepower of Lamp	1,000 Volts Primary Pressure Current per Lamp	2,000 Volts Primary Pressure Current per Lamp
10	.035	.0175
16	.050	.0250
32	.100	.0500
50	.150	.0750

For example, if eight hundred 16-candlepower lamps were operated on a 2,000-volt circuit, the primary current would be about $800 \times .025 = 20$ amperes. This, of course, does not give the current exactly, because to obtain this the

efficiency of the transformers and the lamps should be known, but it affords a ready means of getting at the current approximately when preliminary calculations are being made. In many cases, the more refined calculations would not change the size of the wire in any event, because the wire selected must be taken as one of the standard sizes, and this in most cases is not the same as the calculated size.

44. In case the lamps are operated on two-phase or three-phase systems, the watts to be supplied by the alternator can easily be obtained when the watts per lamp and the efficiency of the transformers are known. After the watts have been determined, the formulas given in connection with the subject of electric transmission may be used to calculate the size of the wire.

TRANSFORMER TESTING

45. In an ordinary lighting system, current is supplied from the station to a comparatively large number of scattered transformers, and as a general rule the greater number of these are loaded for a few hours only. At the same time the pressure is maintained throughout the 24 hours, and while the loss in each individual transformer may be small, yet the total loss on the system may be quite large. Suppose that the all-day efficiency of the transformers on a given system is 90 per cent., the efficiency of the primary transmission lines 95 per cent., and the efficiency of the secondary lines also 95 per cent.; the total efficiency from the station switchboard to the lamps will then be $.90 \times .95 \times .95 = .812$, or 81.2 per cent. Assuming that the customers pay by meter and that all their meters register correctly, for every 100 kilowatt-hours delivered from the station, only 81.2 kilowatt-hours would bring in returns to the company. In many stations the percentage returned is considerably lower than this, on account of slow-running meters, inefficient transformers, or other causes.

The transformer constitutes an important element in the efficiency of an alternating-current lighting system, and

while it is true that efficiency is not the only point to be aimed at, there is no doubt that many systems have been greatly improved and put on a better paying basis by a careful weeding out of small and inefficient transformers. Of course it is equally, if not more, desirable that the transformers shall be reliable in operation, because immunity from breakdowns is of even greater importance than good efficiency. New transformers of reliable make will usually be satisfactory as regards efficiency and insulation, but these qualities may not be permanent. The long-continued heating of the iron core may appreciably increase the hysteresis loss, this effect being known as *aging*. Also, the heating may affect the insulation. In order to determine the condition of a transformer, certain tests are necessary; a few of the more important tests as recommended by the General Electric Company are here described briefly.

46. Insulation Test.—The insulation of a transformer should be tested at three points: between primary coil and core or case, between secondary coil and core or case, and

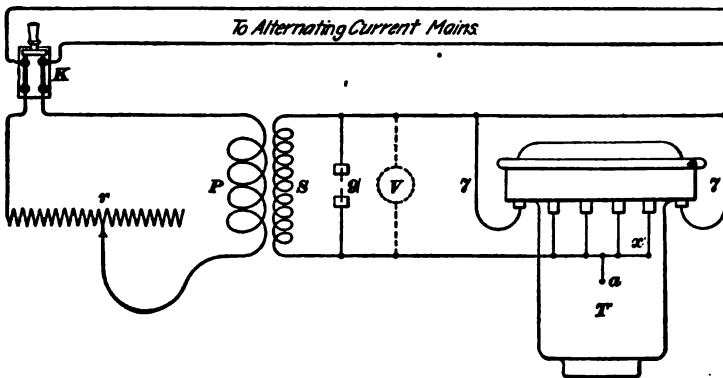

FIG. 38

between primary and secondary. Measurements of insulation resistance by means of a Wheatstone bridge are of no use whatever for a test on transformers. Measurements thus made with low-potential direct current might show a high

insulation resistance, and the insulation might yet be incapable of standing even the normal working pressure. Insulation tests are therefore made with high-potential alternating current.

Fig. 38 shows the general scheme of connections for a high-potential test as applied to testing the insulation of a transformer. The high pressure is usually obtained from a special high-potential step-up transformer, though if this is not available, a number of ordinary transformers may be used with their fine-wire coils connected in series, so as to give the high pressure desired. The main switch K is connected to the primary coil P through an adjustable resistance r that enables the high pressure generated in the secondary S to be regulated. The ends $7, 7$ of the primary coil of the transformer under test are connected together and to one end of S . The ends x of the secondary coils are also connected together, grounded on the case at a , and connected to the other terminal of S . It is important that the various terminals of the coils be connected as indicated; otherwise, some parts of the winding will be subjected to greater strains than others. When the switch K is thrown in, the high E. M. F. generated in S tends to break down the insulation between the primary and secondary coils of T . The applied pressure should be at least three times the primary pressure at which the transformer is designed to work; i. e., a 2,000-volt transformer should stand a pressure of at least 6,000 volts between its primary and secondary coils.

In order to determine the applied voltage, a spark gap g between needle points, or a high-reading electrostatic voltmeter V , may be used. It has been found by experiment that the voltage required to jump between needle points in air increases almost in direct proportion to the length of the gap, until about 30,000 volts is reached; 30,000 volts (alternating) will jump about $1\frac{1}{2}$ inches in air between bright needle points; 15,000 volts will jump about $\frac{3}{4}$ inch; 10,000 volts, $\frac{1}{2}$ inch; and so on. A curve showing the relation between sparking distance and voltage has been given in a previous Section. By setting the points, say, $\frac{1}{2}$ inch apart and then raising

the voltage, by cutting out r , until a spark jumps across, it is known that the pressure applied to the transformer is about 10,000 volts. If needle points are used, they should be renewed after every discharge; otherwise, they become corroded and give inaccurate results.

In applying high-potential tests, care must be taken not to strain and injure the insulation permanently. It is all well enough to apply a test that will indicate to a certainty that the insulation will be capable of standing the strain put on it in service, but if the test is made unnecessarily severe, good apparatus may be permanently injured. High-potential tests should not, therefore, be long continued—a few seconds is sufficient to show whether the insulation is defective or not; a longer application will only serve to injure good insulation. High-potential tests should be made when the apparatus is hot, because then the insulation is weaker than when cold, and any weak spots will be more likely to show themselves; besides, the transformer is warm when used under actual operating conditions.

47. Measurement of Core Loss.—The core losses of a transformer are practically constant at all loads, because the magnetic density remains nearly constant. The core losses determine the amount of power that the transformer takes from the line when the secondary is not loaded, and on lighting systems it is particularly important that these losses shall not be excessive, because there are long intervals when the transformers are not loaded, and an excessive core loss will have a great effect on the all-day efficiency. The measurement of the core loss is most conveniently made by applying a voltage to the secondary circuit and leaving the primary open. This allows lower voltages and larger currents to be used than if the test were made on the primary. If the primary were connected to the mains, as in the regular operation of the transformer, it would be difficult to get instruments of suitable range. The connections are shown in Fig. 39; a is an ammeter; b , a voltmeter; and c , a wattmeter. An adjustable resistance d

is connected in series with the secondary, so that the applied voltage can be varied as desired. Simultaneous readings of the three instruments are taken, and, in addition, the speed of the alternator should be recorded so that the frequency of the current can be estimated. When the voltage across the secondary has been adjusted to the normal voltage of the secondary, the ammeter indicates the exciting current, which is usually from 2 to 5 per cent. of the full-load

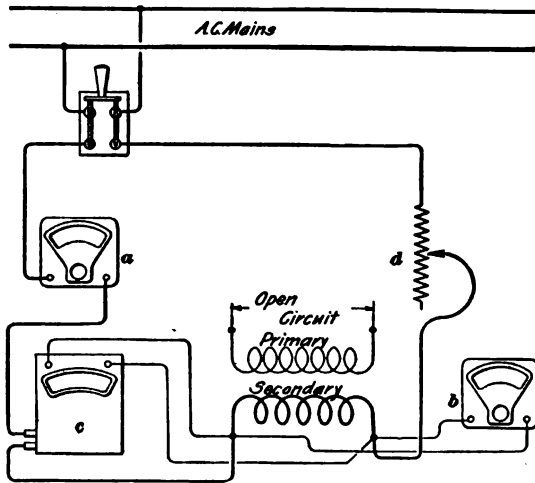

FIG. 39

current, and is the same percentage no matter whether the primary or secondary is considered. In this test the exciting current supplied to the secondary is measured; the current that the primary will take is the secondary current divided by the ratio of transformation. The wattmeter *c* indicates the core loss in watts, and the ratio of the wattmeter reading to the product of the voltmeter and ammeter readings gives the power factor of the transformer at no load.

48. Measurement of Primary and Secondary Resistance.—In order to estimate the I^2R losses in a transformer when it is fully loaded, the resistances of the primary and secondary coils must be known. These resistances can be

measured by means of a Wheatstone bridge, but it is usually more convenient and accurate to use the drop-of-potential method if instruments of suitable range are at hand. This method has been described in connection with the general subject of resistance measurements, and consists in sending a steady current of known value through the coil to be measured and noting the drop in potential indicated by a voltmeter connected to the coil terminals. Knowing the values of E and I , the resistance R at once follows from Ohm's law.

Fig. 40 shows the connections for measuring the resistance of a transformer primary. The current can be varied by

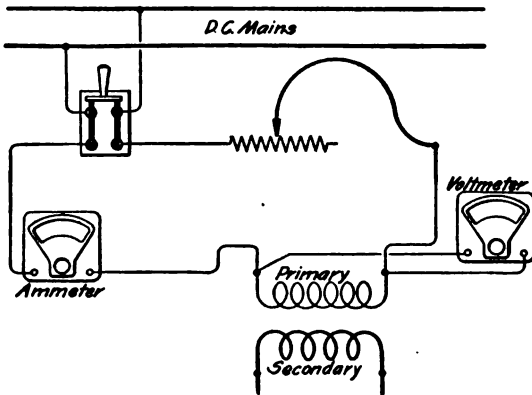

FIG. 40

means of the adjustable resistance, and a number of readings of voltage should be taken for different values of the current and the resistance calculated therefrom. The average of these results should then be taken.

In making resistance tests, the coil should be at a uniform temperature throughout. The best way to make sure of this is to keep the transformer in a room of uniform temperature for several hours before the test is made. Also, care must be taken that the current sent through the coil will not be sufficiently great to raise its temperature appreciably during the time the measurement is being made.

All resistance measurements should be reduced to a standard room temperature of 25° C.* (77° F.) in order that measurements made at different room temperatures may be readily compared. The resistance R at 25° C. may be obtained from the observed resistance R' at T° by means of the formula

$$R' = R (1 + .004 t) \quad (3)$$

or

$$R = \frac{R'}{1 + .004 t} \quad (4)$$

where

$$t = T^\circ - 25$$

When the resistances are known, the copper losses in primary and secondary for any given load are easily calculated.

49. Measurement of Impedance and Copper Losses.—This test, Fig. 41, not only enables the impedance of the transformer to be calculated, but it also gives a fairly

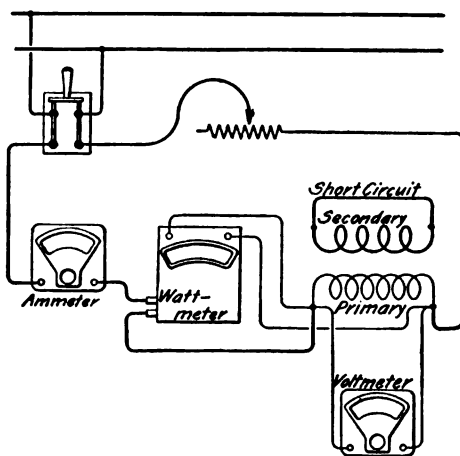

FIG. 41

close idea as to the total copper losses. The impedance of a transformer varies but little with the load, and it represents the combined effect of the resistance and reactance of the primary and secondary coils in preventing the flow of the current. The effect of the impedance is usually expressed by stating the number

of volts that must be impressed on the primary in order to set up full-load current in both coils, the secondary being short-circuited. Since the secondary is short-circuited, it follows that the applied volts are expended in overcoming

*Recommendation of Committee on Standardization, American Institute of Electrical Engineers.

the impedance, and the number of volts that must be applied to set up full-load current with short-circuited secondary is known as the *impedance volts* of the transformer. With short-circuited secondary it requires but a small applied voltage (from 2 to 8 per cent.) to set up full-load current; consequently, the magnetic density in the core is very low and the core losses are almost negligible. If, therefore, a wattmeter be inserted, as shown in Fig. 41, its indication may be taken as practically equal to the full-load copper loss of the transformer. The variable resistance is adjusted until the ammeter indicates full-load current in the primary. The number of volts necessary to overcome the impedance is indicated by the voltmeter, so that the value of the impedance $\sqrt{R^2 + (2\pi nL)^2}$ in ohms is obtained by dividing the voltage by the current. With a 2,000-volt transformer, the impedance voltage might be anywhere from 40 to 160 volts, so that a source of alternating current at fairly low pressure is needed for this test.

50. Load Test.—Transformers should be given a run under full load in order to note the heating effect. The simplest way is to load the secondary with a bank of lamps or some other convenient form of resistance and adjust the load until the transformer supplies its rated secondary current. The temperature of various parts, such as core, case, outside of coils, etc., should be measured by means of thermometers; if oil is used, a thermometer should be immersed in it. The test should be continued until the thermometers indicate that a constant temperature has been attained. This method of testing is quite satisfactory where there is plenty of power available or where the transformers to be tested are small.

A method of making a heat test that is particularly applicable where a number of transformers of the same voltage and capacity are to be tested is shown in Fig. 42. This is sometimes known as the *motor-generator method*, because it is analogous to the method of loading two generators by coupling the machines together and running one as a motor

and the other as a generator. It is possible to fully load two transformers by taking from an outside source only sufficient power to supply the losses. The transformers are tested in pairs; the secondaries are connected in parallel and are supplied from a circuit *A* at the normal voltage and frequency and the current in each secondary therefore induces normal voltage in each primary. The primary coils are connected in series in such a way that their voltages oppose each other.

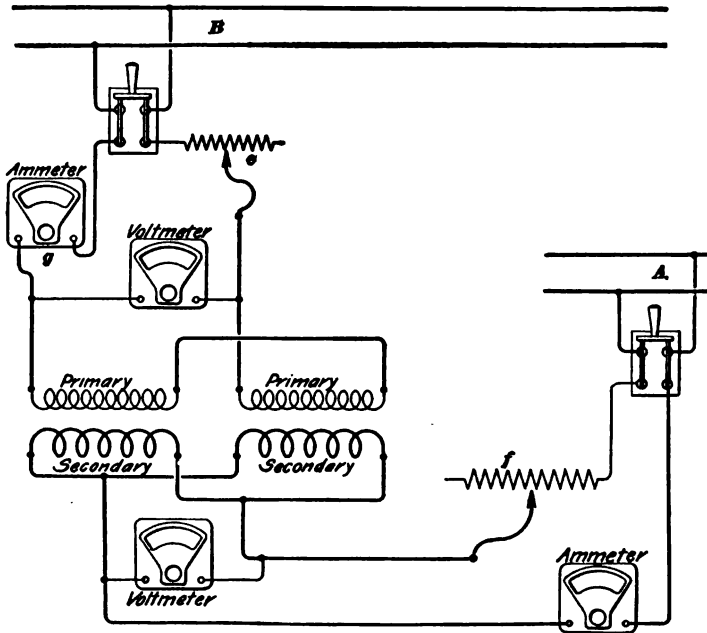

FIG. 42

A circuit *B* is attached to the primary terminals, and, while there is full voltage in each primary coil, the voltage at the terminals of circuit *B* is zero because the two primaries are opposed to each other. If, now, a voltage is impressed by circuit *B*, it is evident that current will be set up in the coils independently of the voltage at the primary and secondary terminals of each transformer. Each transformer is practically short-circuited through the other, and twice the impedance

voltage applied by circuit *B* will cause full-load current to flow in the coils of both transformers. Each transformer will therefore run at full load, although the energy supplied from the outside is equal to the losses only. Circuit *A* supplies the exciting current and core loss; circuit *B* supplies the copper losses. Both the supply circuits may be from the same alternator, or two independent sources may be used, provided that the frequency is the same for each. If both circuits are from the same source, transformers will be necessary to obtain the proper voltages at *A* and *B*. Rheostats should be inserted at *e* and *f*, so that the voltages applied to the primary and secondary may be adjusted until ammeter *g* indicates full-load current in the primaries.

51. Regulation.—One of the most important features to be considered in the selection of transformers for lighting work is the **regulation**. If the voltage drops excessively with increase of load, or on the other hand, rises by a like amount when the load is thrown off, the service will not only be poor, but the life of the lamps may be materially shortened. The regulation of a transformer may be defined as the ratio of the rise of secondary-terminal voltage from full load to no load, to the secondary-terminal voltage at full load. The regulation can be tested by connecting the transformer to a full load of lamps and then gradually removing the load, at the same time seeing that the primary voltage and frequency are maintained constant. It is usually expressed as a percentage of the full-load secondary voltage. The regulation varies with the nature of the load; with a given transformer the change in voltage will be greater for an inductive load than for a non-inductive. The regulation is therefore always given for non-inductive load unless otherwise stated. For well-designed transformers the regulation may be from 2.5 per cent. for small transformers to 1.25 per cent. or slightly lower for large ones. If the design of a transformer is such that there is considerable magnetic leakage between the primary and secondary coils, the regulation will be poor.

STORAGE BATTERIES IN LIGHTING STATIONS

52. Storage batteries are much used in connection with both two-wire and three-wire direct-current distributing systems, being placed either in the station or near a center of distribution. When used in substations, they help to maintain a uniform voltage at the lamps, and also relieve the feeders during intervals of heavy load. In isolated plants, where a load of lights and a fluctuating motor load has to be supplied from the same dynamo, a storage battery in conjunction with a constant-current booster can be used to advantage to maintain a uniform load on the generating equipment, and a constant voltage at the lamps regardless of the fluctuating current supplied to the motors. Batteries may also be used in connection with three-wire systems to compensate for unbalancing, but as a general rule it is not advisable to use them in this way on account of the cells becoming unevenly discharged. Where a three-wire system is to be operated from a single dynamo, it is better to use a motor-generator balancing set to provide for inequalities in load on the two sides of the system. The various methods of operating storage batteries and the connections for battery boosters have been explained in a previous Section, so that further explanation is here unnecessary.

ARC LIGHTING

(PART 1)

THE ARC

OPEN ARCS

1. General Features.—If two carbon rods attached to the terminals of a dynamo, as shown in Fig. 1, are first touched together and then drawn apart a short distance, say about $\frac{1}{8}$ inch, current will flow between the points, the carbons will become heated to an exceedingly high temperature, and an electric arc will be formed between the carbon points. The arc is so called because the electric flame between the electrodes does not pass straight across but is more or less bow-shaped. An arc can be formed between any pair of conducting terminals—for example, between two copper or iron rods—but in this case

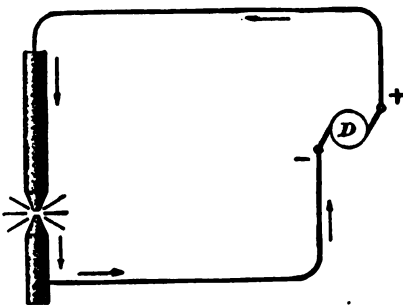

FIG. 1

the metals are rapidly melted away. In practice, therefore, the choice of electrode materials is limited. In nearly every case the electrodes are in the form of carbon rods, though many experiments have been made with other substances and it is possible that some of these may yet prove successful. For example, in the so-called magnetite arc lamp one electrode is made of magnetic oxide of iron and the other of

For notice of copyright, see page immediately following the title page

copper. In some forms of arc lamp for locomotive headlights, an upper positive carbon with a lower negative electrode of copper has been used, but we will confine our attention for the present to the ordinary type of lamp with both electrodes of carbon.

After the carbons have been separated for a time, they appear as shown in Fig. 2. This represents an open arc, or an arc formed in the open air as distinguished from one that is formed in a confined space where very little oxygen is present. The flame, or arc, consists of incandescent carbon vapor that conducts the current across from point to point. The vapor acts in the same way as a wire carrying a current, and if a magnet is brought near, the arc will be forced to one side. If the magnet is strong enough, the arc will be stretched out until it is broken. Also, the arc itself, under ordinary working conditions, will be surrounded by a magnetic field, and it is, no doubt, this field that causes the arc to assume the bow shape. The flame keeps shifting around the points as the carbons burn away.

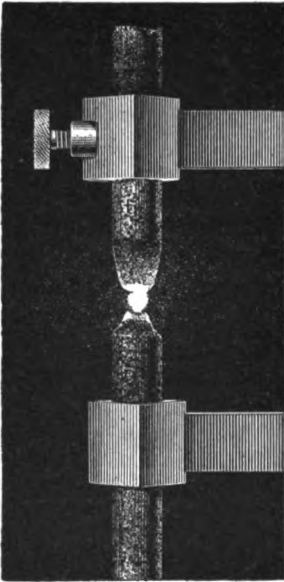

FIG. 2

2. Direction of Current.

The shape of the carbon points depends on the direction in which the current flows. In Fig. 2, the top carbon is positive and the current flows from the top to the bottom, as is nearly always the case with direct-current lamps. Fig. 3 shows a section of the carbons; it will be noticed that the upper, or positive, one becomes hollowed out slightly, as shown at *a*, while the lower one becomes pointed. The hollow *a* is called the *crater*, and is the seat of the greater part of the light given out by the arc. The carbon becomes volatilized at the crater, and

the vapor conducts the current from one carbon to the other. Although the temperature of the negative carbon is high, it is not nearly so high as that of the vapor, and hence the latter is condensed on the negative tip, forming the point, or else is thrown off. Only a portion of the vapor is so condensed; part of it combines with the oxygen of the surrounding air and the burning carbon monoxide may be seen surrounding the arc as an envelope of bluish flame, similar to that which appears over the coal in an ordinary coal stove. With direct current, the positive carbon wastes away approximately twice as fast as the negative, as it is maintained at a much higher temperature. In the ordinary arc lamp using carbon electrodes, the greater part of the light is given off from the incandescent carbon points; the arc itself gives comparatively little light. In some of the lamps recently brought out, for example the magnetite lamp, the light is given off almost wholly from the arc and comparatively little is emitted from the electrodes.

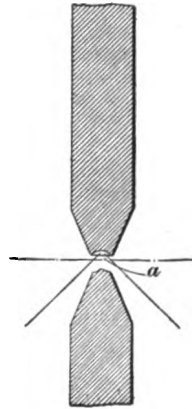

FIG. 3

3. Temperature of the Arc.—The temperature of the electric arc is the highest that has yet been produced. The exact temperature is difficult to determine, but it is estimated to be about $3,500^{\circ}$ C. The carbon in the crater is vaporized; hence, the temperature attained must be that of the boiling point of carbon. Some idea as to what this means may be obtained when it is known that a temperature between $1,700^{\circ}$ and $1,800^{\circ}$ C. is sufficient to melt platinum, the most difficult of all metals to fuse. This high temperature is utilized in electric furnaces. An increase in the current does not increase the temperature, but it does increase the size of the crater and hence the total amount of light given out. If very powerful lamps are required, large carbons and heavy currents are used to get a large crater as, for example, in lamps used for searchlights. For ordinary commercial

street lighting, the carbons are usually $\frac{1}{4}$ to $\frac{1}{2}$ inch in diameter, though sometimes larger carbons are used to make the lamps burn longer.

4. Voltage of the Arc.—If the voltage across the terminals of an ordinary open-arc lamp is measured, it will be found that it usually lies between 40 and 50 volts, depending on the length of the arc; 45 volts may be taken as a fair average. This total voltage may be considered as made up of three parts: (a) That necessary to overcome the resistance of the carbons and the parts of the lamp mechanism through which the current has to flow; (b) that necessary to overcome the resistance of the carbon vapor between the electrodes; (c) that which multiplied by the current represents the energy necessary to volatilize the carbon.

The E. M. F. necessary to overcome the resistance of the carbons and lamp mechanism is not very large; in most lamps it will not be more than 5 or 6 volts, of which 3 to 3.5 volts may represent the drop in the carbons while the balance is in the mechanism and various contact resistances. The E. M. F. necessary to overcome the resistance of the arc proper is also small, but depends to a certain extent on the length of the arc. In most cases it will not be more than 5 or 6 volts. Since the voltage across the lamp is, say, 45 volts and the combined drop due to the resistance of the carbons, lamp mechanism, and arc proper is approximately 10 volts, it follows that the balance (about 35 volts) multiplied by the current represents the number of watts expended in bringing the carbon up to the boiling point and causing it to volatilize. This voltage is often spoken of as the counter E. M. F. of the arc, but this term is not so commonly used as it once was. Quite a large amount of energy must be expended to bring the carbon up to the boiling point, and it is now generally admitted that the large balance of voltage required over and above that necessary to overcome the various resistances is a consequence of the power necessary to volatilize the carbon. The above values of the voltage are fair average values for open-arc lamps operated with

direct current, but they may vary somewhat with different makes of lamp. The actual voltage across the arc is continually varying when the lamp is in operation, but in a well-adjusted lamp it should not vary through wide limits.

5. Current.—Ordinary direct-current, open-arc lamps are usually operated with current ranging from 6 to 10 amperes. Very common values for the current are 6.6 amperes for lamps giving 1,200 nominal candlepower and 9.6 amperes for those giving 2,000 nominal candlepower. The exact value of the current is different in lamps of various makes, but whatever it may be, it is essential that it be maintained at a constant value if the lamps are to work properly. If the current becomes larger than that for which the lamps are designed, they will overheat, the carbons will flame badly, and the service will be generally unsatisfactory. Open-arc lamps may also be operated with alternating current, but they are not so satisfactory as those using direct current either as regards light-giving properties or general performance. In the case of the alternating-current open arc, both carbons become pointed or have very small craters, so that the light is thrown upwards much more than with the direct-current lamp. Also, since the current flows alternately in opposite directions, the rate of consumption of the two carbons is more nearly equal.

ENCLOSED ARCS

6. General Description.—Within a comparatively recent date *enclosed arcs* have superseded open arcs in practically all new work, and in many old installations the open arcs have been replaced by the enclosed type. The **enclosed arc** differs from the open arc in that it is surrounded by a small globe that practically excludes the air. Fig. 4 shows one arrangement of carbons and enclosing globe; *g* is the globe, which is from 5 to 6 inches long and about 3 inches in diameter. Some inner globes have their lower end closed, the bottom carbon being placed in a holder suspended from the cap that covers the globe. The more common

arrangement, however, is to have the globe open at both top and bottom with the lower carbon holder supported from below. The top and bottom edges of the globe are ground true so as to make a tight joint.

In Fig. 4, the globe is held between a circular spring

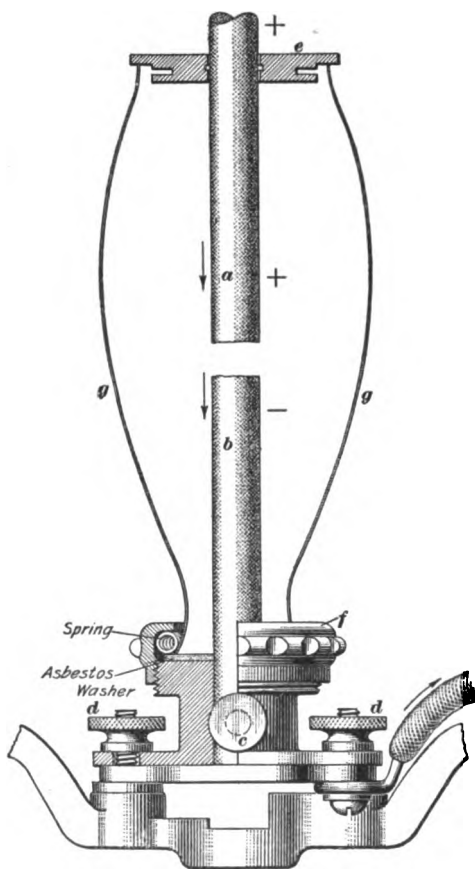

FIG. 4

and a thick asbestos washer, which allow a certain freedom of movement under expansion and contraction and thus avoid breakage. The lower carbon *b* is clamped by means of screw *c* and the whole lower globe can be easily removed from the lamp by loosening screws *d, d*. The top of the globe is covered by the *gas cap e*, which consists of an iron casting faced off smooth so as to form a close fit with the top edge of the globe. The cap is not fastened to the globe in any way, but is free to move about a little and thus adjust itself to any slight eccentricity of the upper carbon. The hole

through which the carbon slides is slightly larger than the carbon in order to allow the latter to slide freely. Since the top of the glass and the lower surface of the plate are ground plane, little air can get in between them, and the only

place where much air can enter the bulb is at the hole in the center of the top plate, through the small space between the carbon and the plate itself. In the plate shown, there is an annular groove around the carbon where it passes through the cap. This leaves less surface for the carbon to rub against and affords a space in which eddies are formed by the hot air passing up, thus further tending to keep out the cold air. The rate at which the carbons are consumed depends considerably on the construction or condition of the gas cap. If the cap allows much air to enter, the consumption will be rapid.

Fig. 5 shows a style of cap used by the General Electric Company; it consists of two parts—a cover *a* and a lower casting *b*. In the casting is a spiral groove *c* that connects with the inner part of the globe by means of holes *d* and with the outer air by the opening *e* at the side. After the

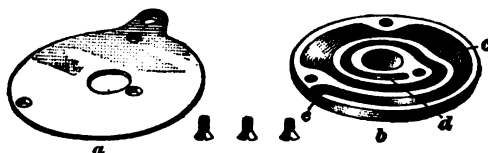

FIG. 5

lamp has been in operation for a short time, the spiral recess becomes filled with gases similar to those in the globe and a movement of the carbons, instead of drawing in fresh air, draws in a mixture similar to that already in the globe. Also, a slight decrease in the temperature of the atmosphere in the globe; with a plain cap, fresh air would be drawn in, but the spiral duct acts as a gas reservoir and tends to keep the atmosphere in the globe more uniform, thus resulting in a longer life for the carbons. The arrangement of gas cap and methods of mounting the enclosing globe vary considerably with different makes of lamp.

As soon as the carbons of an enclosed-arc lamp are drawn apart an arc is formed, as in the open lamp, but the oxygen in the globe is soon burned out and the gases present become rarefied, because the heat of the arc causes them to

expand and pass out. The globe is not air-tight, so that there is always a small amount of oxygen present, but not enough, however, to cause the rapid combustion that takes place in the open arc. The arc practically burns in a hot atmosphere of nitrogen, carbon monoxide, carbon dioxide, and a small amount of oxygen. The oxygen present is just about sufficient to combine with what carbon is thrown off and prevent its being deposited on the glass. If a lamp is in good condition, it will burn from 80 to 150 hours, depending on the design, without renewing the carbons. The bulb in time becomes coated with a light-colored deposit, sometimes mixed with a little carbon, which comes principally from impurities such as silicon; this deposit does not cut off the light to any great extent if it is not allowed to become too thick. If the current is excessive the globes will become blackened or even melted. It is not usually advisable to burn these lamps more than 120 hours, as the deposit becomes so thick as to cut off a considerable amount of light.

7. Consumption of Carbons.—One of the most striking features of the enclosed-arc lamp is the slow consumption of the carbons; this is, of course, due to the absence of oxygen in the enclosing chamber. With the ordinary open arc, the positive carbon is burned at the rate of about $1\frac{1}{2}$ inches per hour, but in an enclosed-arc lamp the consumption varies from .05 to .08 inch per hour. Enclosed-arc lamps may, therefore, be made to burn a long time without trimming; some have even been made to burn as long as 200 hours. This is one of the features that has led to the extensive introduction of this type of lamp. As in the open arc, the negative carbon of the direct-current enclosed arc burns about half as fast as the positive carbon; with alternating current, the consumption is more nearly equal.

The rate at which the carbons are consumed and the sensitiveness of the arc to slight changes in current or voltage depend very largely on the amount of air present in the enclosing globe. If the voltage, current, or frequency on a line is not steady, it is often better to work with a less

sensitive arc even if the life of the carbons is reduced somewhat. A gas cap that gives good results on one system may not work so well on another, but a few trials will indicate the best style of gas cap to use.

8. Voltage and Current.—If the carbons of an open arc are pulled apart a distance more than sufficient to give from 40 to 45 volts across the arc, they will flame badly. On the other hand, the enclosed-arc lamp is operated with a long arc (about $\frac{3}{8}$ inch for a voltage of 70 to 80 across the arc) and it burns steadily without flaming. If a short arc is used in the enclosed arc, it is found that soot or carbon is deposited to such an extent that the lamp becomes useless; long arcs are therefore essential in these lamps. This allows them to be operated at a high voltage, and the best results are usually obtained with 70 to 80 volts across the arc. They usually operate with a smaller current than the open-arc lamps, some of them taking as low as $2\frac{1}{2}$ to 3 amperes. Enclosed-arc lamps have also been built to operate on 220-volt circuits. These burn with a very long arc and are not quite as efficient as the ordinary 110-volt lamps, to which the above figures refer. A 220-volt lamp will take from 140 to 145 volts across the arc.

9. Character of Enclosed Arc.

Fig. 6 gives a general idea of the appearance of a direct-current enclosed arc; this figure should be compared with Fig. 2. In the enclosed arc, the carbons are separated by a wide gap, but the principal difference is that they do not take on the pointed shape; the ends of the carbons remain nearly flat and the arc keeps continually shifting around over the ends. The flat shape of the ends is, no doubt, due largely to this tendency of the arc to shift around. The light given out is soft and tinged with violet rays, having much less of the dazzling appearance so well known in connection with the open arc. In the alternating-current enclosed arc, the lower

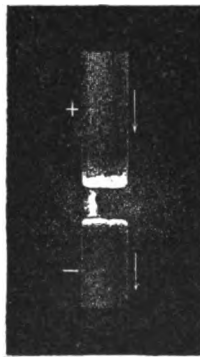

FIG. 6

and upper carbons are of about the same temperature and the light is thrown up more than with the direct-current arc. The carbons have, however, the flat-ended appearance and the arc shifts around even more than the direct-current enclosed arc. In open arcs, the carbons are close together and a shifting of the arc from one side to the other causes very pronounced changes in the intensity of the light. In the enclosed-arc lamp, the shifting of the arc also causes changes in the illumination, but not to nearly so great an extent as in the open arc. The arc is so much longer that the carbons do not obstruct the light nearly so much when the arc shifts to one side or the other; the illumination is therefore more steady and uniform than that from an open arc.

10. Open Versus Enclosed Arcs.—The enclosed-arc lamp has proved superior to the open arc because of the following advantages: (*a*) It gives a softer, steadier, and more uniformly distributed light; (*b*) it burns very much longer without retrimming, thus effecting a saving in the cost of carbons and in the cost of labor for trimming; (*c*) it operates with a higher arc voltage and smaller current, thus making it more suitable for parallel operation on ordinary constant-potential lighting circuits; (*d*) for interior illumination, it involves less fire-risk when two globes are used—the inner enclosing globe and the ordinary outer globe. Against these advantages must be placed the extra cost of the enclosing globes, breakage of globes, and cost of keeping inner globes clean. Enclosed-arc lamps require a higher grade of carbon than open arcs, but allowing for this there is a saving of \$8 to \$10 per lamp per year over the cost of operating the old-style, open-arc lamps. The open arc was never much of a success with alternating current; it produced a loud hum and was very unsteady. With the enclosed arc, quite satisfactory results can be obtained with alternating current, so much so, in fact, that alternating current is supplanting direct current for arc lighting, particularly for street lighting or in places where the lamps are much scattered. The mechanism

has been designed so that little noise is possible, and the enclosing of the arc prevents the humming of the arc itself from being loud enough to be objectional. However, while the alternating-current, enclosed-arc lamp is much superior to the alternating-current, open-arc lamp, it can hardly be said that it is capable of giving quite as good all-around service as the direct-current, enclosed-arc lamp.

ARC-LIGHT CARBONS

11. Arrangement of Carbons.—In nearly all the lamps used for ordinary purposes, the carbons are arranged vertically, one above the other, as shown in Fig. 2. When so arranged, the top carbon should always be the positive one when direct current is used, otherwise the crater will be formed in the bottom carbon and most of the light will be thrown up instead of down. When lamps are first connected up, they should be allowed to burn for a short time; if the crater makes its appearance in the bottom carbon, the connections to the lamp terminals should be reversed. Of course, with alternating current it makes no difference how the lamp is connected in circuit, as the current is continually reversing and both carbons burn alike. It is an easy matter to tell when a direct-current lamp is correctly connected. Allow the lamp to burn for a short time, then switch it off and see which carbon remains bright the longer. The positive carbon is much hotter than the negative, hence the negative carbon is the one that becomes dull first.

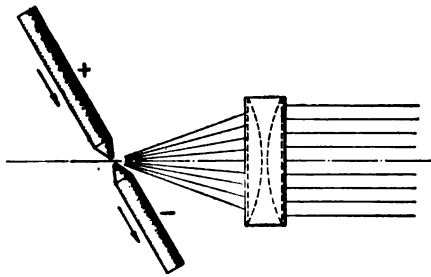

FIG. 7

For use in stereopticons and other projection apparatus, the carbons are often inclined at an angle, as shown in Fig. 7. This allows more of the light from the crater to

reach the lenses. In searchlights, a similar arrangement is used, only the carbons are often slanted the other way and the light is reflected from a parabolic reflector or Mangin mirror, as shown in Fig. 8,

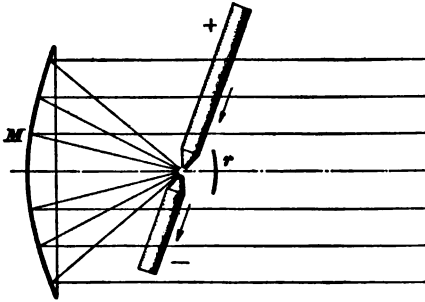

FIG. 8

which shows the arc placed at the focus of a parabolic reflector *M*. The rays of light on striking the mirror are reflected out parallel to each other, and as they are thus kept bunched together the light may be made to penetrate long distances. A small concave reflector *r* is usually placed to throw the rays of the arc that would ordinarily pass outwards, back toward the main reflector.

A parabolic, ground-glass, silvered mirror is used in the United States Navy, but for ordinary commercial work the *Mangin mirror* is used, as it is cheaper and easier to make.

It is a glass mirror having two spherical surfaces *A*, *B* of different radii, as shown in Fig. 9. The back surface *A* is silvered and the rays are reflected from it. As the glass is thicker near the edges than in the middle, the rays are there bent or refracted more than they are at the center, and by making the mirror of the proper dimensions it can be made to reflect the rays in a horizontal direction and give practically the same effect as the parabolic mirror.

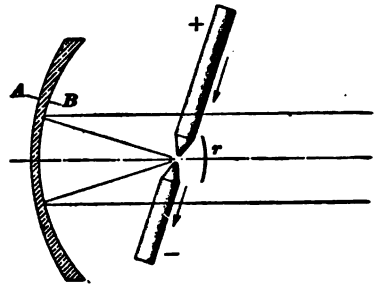

FIG. 9

Fig. 10 shows another arrangement of carbons used in searchlights. In this case the positive carbon is larger than the negative, and both carbons are arranged horizontally. The crater, therefore, points directly at the mirror. This is

the arrangement now most extensively used in America both for naval and commercial work.

In all cases where arc lamps are used in connection with mirrors or lenses for projection work, it is essential that the arc be kept in the focus of the mirror or lens. The lamps must therefore be arranged to move the carbons toward each other, as they are consumed, in such a way that the position of the arc will not be changed; a lamp that does this is

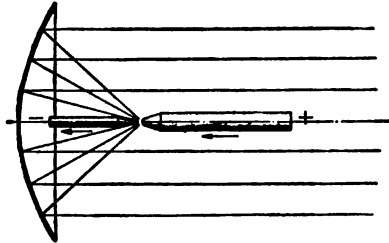

FIG. 10

known as a *focusing lamp*. For ordinary lighting, it is not essential that the arc be kept in one place, so the lower carbon is nearly always fixed and the arc maintained by allowing the upper one to move downwards as the carbon is consumed.

Fig. 11 shows a rather peculiar arrangement that is used for stereopticon lamps. Here the carbons are arranged at

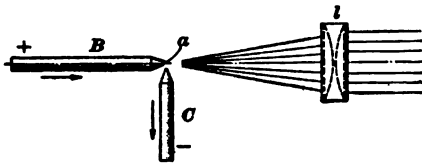

FIG. 11

right angles to each other. The lamp mechanism moves *B* in a horizontal direction and *C* upwards as they burn away, so that the arc is always maintained in

the same position at *a*. The position of *C* keeps it from interfering with the lens *l*, and allows the greater part of the crater in the end of *B* to be exposed.

12. Composition of Carbons.—Carbons used for ordinary open-arc lamps in America are composed principally of petroleum coke. This is made from the residue left from the distillation of petroleum. It is ground up and mixed with a binding material, such as tar, or a similar substance, and is then molded into rods. Sometimes the rods are made in molds under a heavy pressure, but more frequently they

are made by forcing the material through dies. The rods are then gradually dried and afterwards baked or fired at a high temperature. Gas-retort carbon has also been used for the manufacture of arc-light carbons, the exact composition used varying with different makers.

For enclosed-arc lamps, a very much finer quality of carbon is required than for the open-arc lamp. If the carbons used in these lamps are at all impure, the impurities become volatilized and are deposited on the inner globe. Enclosed-arc carbons are therefore made principally of lampblack, which is practically pure carbon, and are considerably more expensive than the ordinary carbons made from petroleum coke. They must be straight and of uniform diameter, otherwise they will not pass through the cap of the enclosing globe properly.



FIG. 12

Fig. 12 shows a *cored carbon*, so called from the core *a* running through it. A small hole in the center of the carbon is filled with a much softer material than the surrounding part. The soft core volatilizes more easily than the rest of the carbon and produces a supply of vapor that increases the stability of the arc and keeps it from shifting around so much. Cored carbons are particularly useful for alternating-current lamps, in which the arc is liable to be unsteady and flickering. The cored carbon reduces the voltage corresponding to a given length of arc, or with a given voltage it allows a longer arc than would be practicable with solid carbons. Some makers use cored carbons for both the positive and the negative electrodes of alternating-current lamps, while others use them for the positive electrode only. Cored carbons are used more particularly with alternating-current lamps, as the plain carbons usually give satisfactory service with direct current. Searchlights are almost wholly operated by direct current and the positive carbon is generally cored, as it is important to keep the arc in one place as closely as possible.

Whatever kind of carbon may be used, it is essential that it be as pure and as uniform in quality as possible. If many

impurities are present, they may interfere seriously with the quality of the light. Of course, impurities are especially bad in the case of the enclosed arc on account of the deposit caused on the inner globe, but even in the open arc they are objectionable because they volatilize at a much lower temperature than the carbon and thus tend to lower the temperature and light-giving properties of the arc. Hard spots in the carbon will cause uneven burning and carbons that are too soft are apt to flame badly. Hard spots will also give rise to hissing. Carbons used for open-arc lamps are usually electroplated with a thin coating of copper. This increases their conductivity and makes them burn more uniformly and last longer.

PHOTOMETRY OF THE ARC LAMP

LIGHT DISTRIBUTION

13. The light given out by an incandescent lamp is fairly uniform, assuming, of course, that the lamp has no shade on it. On the other hand, the light given out by an arc lamp with a clear globe varies greatly in different directions. Since the manner in which an arc lamp distributes its light is of the greatest importance, it will be well to examine the peculiarities of some of the more important types. It will not be necessary here to go into the methods of measuring the light intensity, which is usually done by means of a Bunsen or similar photometer, with the arc lamp so arranged that its candlepower may be measured in any direction. It is a rather difficult matter to measure the candlepower of an arc lamp, because the arc is continually shifting. Special photometers have been devised for the purpose, one of which, designed by Prof. C. P. Matthews, has a number of mirrors arranged around the lamp so that the light given out in various directions is reflected along the photometer bar. The setting of the screen thus gives a measure of the mean spherical candlepower.

14. Before going into the subject of light distribution, a few points in regard to globes may not be out of order.

Ordinary open-arc lamps used for street lighting are generally provided with clear globes; clean globes cut off from 6 to 10 per cent. of the light, and if dirty will cut off more. Sometimes opal globes are used, especially if the lamp is used for interior work; these soften the light and do away with the sharp shadows that are always present with a clear globe. In other words, an opal globe alters the distribution of the light considerably and avoids the deep shadows underneath the lamp. At the same time a globe of this kind cuts off from 30 to 40 per cent. of the light; in fact, if the globe is very milky it may easily cut off 50 or 60 per cent. In the

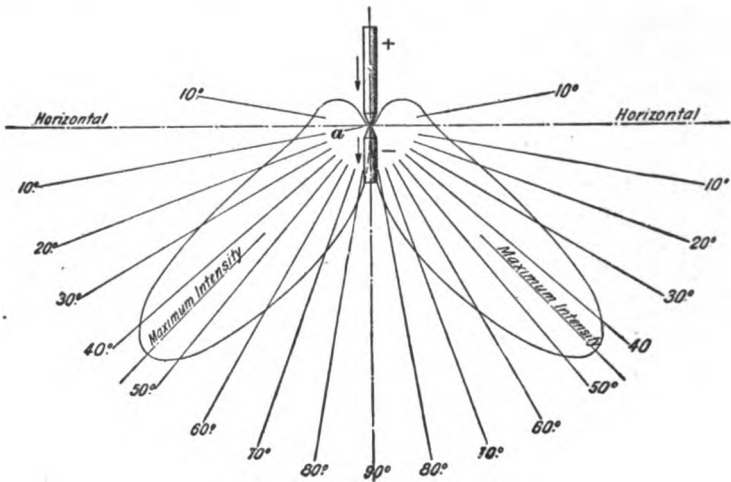

FIG. 13

case of the enclosed-arc lamp, there is in addition to the outer globe the inner globe, and hence the amount of light cut off is somewhat increased. Reflectors are used much more largely with the alternating-current arc lamp than with the direct current, because the former tends to throw its light to a greater extent above the horizontal, and by using the reflector this light can be thrown downwards and utilized.

15. Direct-Current, Open-Arc Lamps.—The distribution of light from an ordinary open-arc lamp is about as shown in Fig. 13. This represents the variation in the

intensity at different angles above and below the horizontal line passing through the arc that is located at *a*. The distance from *a*, measured along the radius at any given angle, is proportional to the candlepower of the lamp when viewed from that position. For example, the light reaches its greatest intensity at a point about 45° below the horizontal and then rapidly diminishes on both sides of this point. Directly above or below the arc there is, of course, little or no light, as the arc is obscured by the frame of the lamp and the carbons themselves. The open arc throws out comparatively little light in the horizontal direction, and the quantity of light thrown upwards is small. It is thus seen that the plain open-arc lamp using a direct current, without any reflector and with simply a clear-glass globe, gives a good distribution of light for street lighting, because, on account of the formation of the crater in

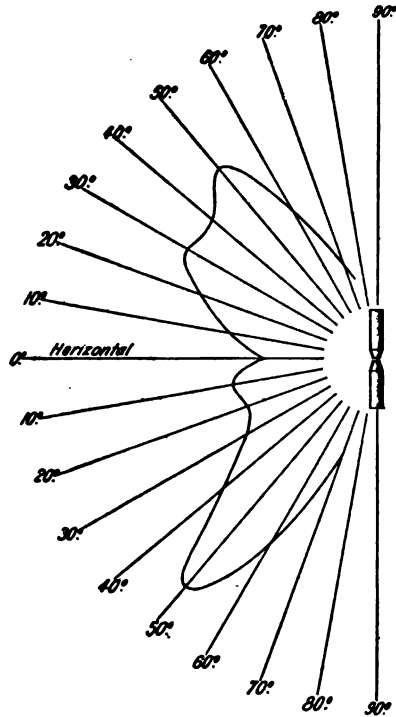

FIG. 14

the upper carbon, it throws the bulk of its light downwards at an angle of about 45°, where it is most needed. This is one of the reasons why the direct-current, open-arc lamp proved so successful for street lighting. If the deep shadows directly under the lamp are objectionable, they can be softened by using a clear globe with the lower half ground.

16. Alternating-Current, Open-Arc Lamps.—The distribution from an alternating-current, open-arc lamp is not

of much practical importance because these lamps are seldom used. It is, however, instructive to compare it with Fig. 13. Fig. 14 shows the general distribution from an alternating-current, open-arc lamp, as determined by Uppenborn. A great deal of the light is thrown above the horizontal; this is because the two carbon points are alternately positive and negative, so that both become heated

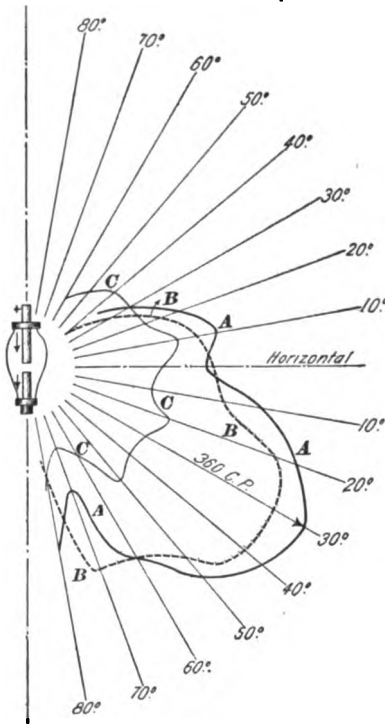

FIG. 15

to nearly an equal amount. Such a lamp, to be effective for street lighting, should be provided with a reflector to throw the light down where it is wanted. The curves shown in Figs. 13 and 14 represent average distributions. It must be remembered that the arc always shifts around more or less, and hence the shape of the distribution is constantly changing. The curves will, however, illustrate the marked difference in the light distribution of the alternating-current, open-arc lamp as compared with the direct-current, open-arc lamp.

17. Direct-Current, Enclosed-Arc Lamps.

Curve *A* shows the distribution when the lamp is provided with an opalescent inner globe only; there is no large outer globe. This curve should be compared with that shown in Fig. 13 for the open arc. With the enclosed arc, the light is of fairly high intensity through a considerable angle below the horizontal. In this case, the maximum value is approximately 360 candle-power and occurs about 30° below the horizontal. This is considerably less than the intensity given by an open arc at about 40° to 45° below the horizontal, but the light from the latter falls off very rapidly on each side of the maximum point, whereas in the enclosed arc it is fairly well maintained through a considerable angle. Curve *B* shows the distribution when the lamp is provided with a clear outer globe in addition to the inner opalescent globe. The effect is to cut down the intensity as a whole slightly. Curve *C* shows the effect of using an outer opalescent globe; the effect is to make the light approximately uniform in all directions at the expense of cutting it down greatly.

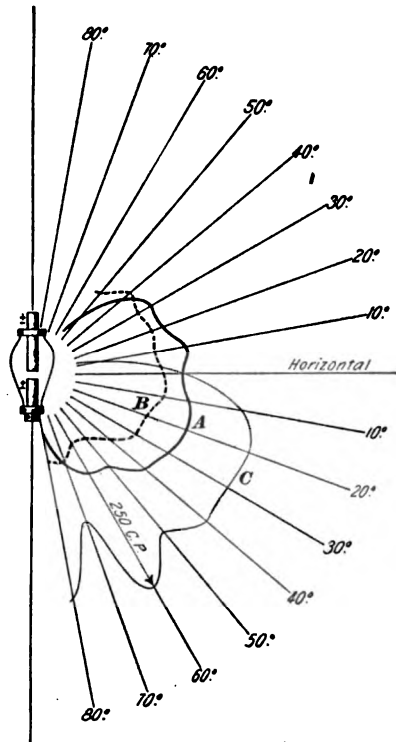

FIG. 16

The distribution of light from an enclosed-arc lamp is subject to considerable variation. It depends to some extent on the shape of the enclosing globe and also on the thickness of deposit on it. It also depends on the position of the arc in the enclosing globe.

18. Alternating-Current, Enclosed-Arc Lamps.

The direct-current lamp gives a better distribution for street lighting than the alternating-current, enclosed-arc lamp, and, on the whole, the latter is not quite as efficient as the direct-current lamp. If, however, full benefit is to be obtained from the light given by the alternating-current enclosed arc, a reflector of some kind must be used. This is shown by the curves in Fig. 16. Curve *A* represents the distribution from an alternating-current enclosed-arc lamp that has an opalescent inner globe and a clear outer globe. A large quantity of light is thrown above the horizontal, as in the alternating-current open-arc lamp. Curve *C* shows the distribution when the same lamp is provided with a reflector. The curves show how the light that would ordinarily be thrown upwards, and hence be of little or no use for street illumination, is made available. Thus equipped with a reflector, the alternating-current arc makes a better showing against the direct-current arc. The alternating-current lamp equipped with a reflector is rapidly finding favor as a street illuminant; though it may not be quite as efficient as the direct-current arc, its use in many cases so simplifies the outfit required at the station that the slight difference in the efficiency of the lamps is more than made up. This will be more apparent later when the various systems of supplying lamps with current are considered. In Fig. 16, curve *B* shows the distribution given by an alternating-current, enclosed-arc lamp when used with opalescent inner and outer globes.

CANDLEPOWER OF ARC LAMPS

19. The candlepower of an arc lamp is a rather indefinite quantity. In making comparisons between different lamps, the only way that is at all fair is to take the mean spherical candlepower; i. e., what their candlepower would be equivalent to if it were equal in all directions, instead of varying, as indicated by the curves just shown. In comparing incandescent lamps, it is usually sufficient to compare their mean horizontal candlepower as obtained by

spinning the lamp; but in the case of an arc lamp, the distribution is so irregular that the mean spherical candlepower must be taken.

In the early days of electric lighting, it was customary to speak of the ordinary open-arc lamp as giving 2,000 or 1,200 candlepower. The candlepower of these lamps was not nearly so high as this. It is barely possible that under exceptional conditions the light given out in the direction of maximum intensity might have reached these figures, but the average candlepower was nowhere near 2,000; about 375 to 450 would be nearer the mark. This old rating gave rise to a great deal of trouble, as customers were often told that the lamps should give 2,000 candlepower and that the lighting companies were not living up to their contracts. It has become customary, therefore, to specify arc lamps as taking so many watts instead of supplying a certain number of candlepower. This is generally more satisfactory, because the watts can be measured at any time, to see if the contract is being lived up to. The lamp formerly rated at 2,000 candlepower has thus come to mean one that is supplied with 450 watts; and a 1,200-candlepower lamp, one that is supplied with 300 watts. The ratings, 2,000 and 1,200 candlepower, should never have been applied to these lamps in the first place, as they have absolutely no meaning. As has been stated, the mean spherical candlepower of an ordinary direct-current open arc is generally somewhere between 375 and 450 candlepower. The mean spherical candlepower represented by curve *A*, Fig. 15, is about 223; curve *B*, 181; curve *C*, 155. For the alternating-current lamps, represented by Fig. 16, the mean spherical candlepower for curve *A* is about 140; for curve *B*, 114.

20. Power Consumption per Candlepower.—The number of watts that must be supplied to the terminals of an arc lamp per mean spherical candlepower will depend on the construction of the lamp and on the conditions under which it is used. For example, when direct-current lamps are operated on 110-volt circuits, it is necessary to have a

resistance in series to take up the voltage over and above the 80 volts required by the arc; and even if the line voltage were suited to that of the arc, a resistance would still be necessary to make the lamp regulate properly, as will be explained later. The waste in this resistance may amount to as much as 140 or 150 watts, and this lowers the general efficiency of the lamp. When lamps are operated in series, a resistance is not necessary and the waste in the lamp is less. An ordinary series, open-arc lamp requires about 1.2 watts per spherical candlepower. A direct-current enclosed arc requires about 1.8 watts per spherical candlepower, not counting the power lost in the resistance. If a resistance is used, as in the case of a lamp operated on 110-volt direct current, the power consumption per candlepower will be 2.3 to 2.4 watts. For example, the lamp represented by curve *A*, Fig. 15, took 4.9 amperes at 110 volts or 539 watts, of which 147 watts were wasted in the resistance and 392 watts taken up at the arc. The lamp gave about 223 mean spherical candlepower; hence, the total number of watts per candlepower was $\frac{539}{223} = 2.4$. Not counting the loss in the resistance, the watts per candlepower would be 1.8, nearly.

21. The alternating-current, enclosed-arc lamp requires about 2.4 watts per spherical candlepower, not counting the energy lost in the lamp mechanism. If an alternating-current lamp is run from constant-potential mains, the excess voltage can be taken up by a reactance, or choke coil, which wastes much less energy than a resistance. The energy wasted in the mechanism of a constant-potential, alternating-current arc lamp will not be more than half that of the direct-current lamp using a resistance. If the power lost in the mechanism is included in both cases, the alternating current constant-potential enclosed arc will require 2.45 watts, as against 2.3 watts required by the direct-current arc. If a shade is used on the alternating-current arc, the power consumption per candlepower delivered below the horizontal becomes much less; but in comparing the different lamps,

they should all be taken as nearly under the same conditions as possible.

These figures are intended to give a general idea as to the efficiency and illuminating power of the various kinds of lamps, and represent average conditions, but lamps may be found that will vary considerably from the above. If the enclosed-arc lamp taking 450 watts is compared with an open-arc lamp taking the same amount of power, it will be found that the open-arc lamp will give a somewhat brighter illumination on the street. Notwithstanding this fact, the public, as a rule, does not object to the enclosed arc being substituted for the open, because the light is much steadier and softer and the shadows are not so deep. The preceding figures relating to arc lamps are here collected in Table I for convenient reference. Table II gives data regarding the power consumption of the different types of a well-known make of enclosed-arc lamp. By the efficiency of the various lamps as given in this table is meant the ratio of the watts utilized at the arc to the watts supplied at the lamp terminals. The direct-current lamp, run in series on constant-current circuits, has the highest efficiency because there is very little resistance in series with the arc. The efficiency of constant-potential lamps is lower, because of the power lost in the resistance or reactance that is inserted in series with the arc.

22. Illumination.—The number of arc lamps required to illuminate a given space varies greatly, so that it is difficult to give any definite figures on this subject. Enclosed-arc lamps are now largely used for the interior illumination of mills and factories. The light from these lamps is steady and agreeable, and if they are provided with light opal globes or reflectors, a very even illumination can be obtained. In textile mills, the illumination must be very good; hence, more lamps are needed per unit of floor area than would be required, for example, in a foundry. Table III, given by the General Electric Company, shows the approximate number of watts required at lamp terminals for first-class illumination.

TABLE I
POWER CONSUMPTION OF ARC LAMPS

Type of Lamp	Total Watts Consumed	Watts Consumed in Resistance or Choke Coil	Watts at Arc	Mean Spherical Candlepower	Total Watts per Mean Spherical Candlepower	Watts at Arc per Mean Spherical Candlepower
Series open arc, 2,000 nominal candlepower, about 9.6 amperes at 50 volts	460-480		450	375	1.3	1.2
Direct-current enclosed arc, 110 volts 4.9 amperes, opalescent inner globe, no outer	539	147	392	223	2.4	1.8
Same, with opalescent inner and clear outer globes	539	147	392	181	2.9	2.1
Same, with opalescent inner and outer globes	539	147	392	155	3.5	2.5
Alternating-current enclosed arc, 110 volts, opalescent inner and clear outer globes	416	74	342	140	2.9	2.4
Same, with opalescent inner and outer globes	416	74	342	114	3.6	3.0

TABLE II
DATA ON ENCLOSED-ARC LAMPS

	Alternating-Current Lamps											
	Constant-Current Series Lamps						Constant-Potential Multiple Lamps					
	60 Cycles (Standard)		7.5		6.6		133 Cycles		60 Cycles		133 Cycles	
Current in amperes	6.6	7	7.5	7	6.6	7	7.5	7	4	6	4	6
Terminal volts	78	77	76	80	83	80	79	100	104	100	104	104
Arc volts	72	72	72	72	72	72	72	70	74	72	72	75
Terminal watts	435	460	490	430	455	455	485	260	405	270	405	405
Arc watts	395	420	450	385	410	410	440	227	365	230	360	360
Watts lost	40	40	40	45	45	45	45	33	40	40	40	45
Power factor846	.865	.861	.813	.785	.813	.819	.650	.649	.675	.649	.649
Efficiency908	.913	.918	.923	.895	.923	.908	.873	.902	.852	.852	.889

	Direct-Current Lamps					
	Constant-Current Series Lamps (Standard)			Constant-Potential Multiple Lamps		
	Two in Series on 220 Volts		Five in Series on 550 Volts		Multiple Series	
Current in amperes	6.8	3.5	5	2.5	5	8.58
Terminal volts	72	110	110	220	110	110
Arc volts	70	80	80	145	80	80
Terminal watts	489	385	550	550	550	550
Arc watts	469	280	400	303	472	472
Watts lost	20	105	150	177	78	78
Efficiency959	.727	.727	.66	.858	.858

NOTE.—Series alternating-current, constant-current lamps can be adapted to currents from 4 to 7.5 amperes and frequencies from 40 to 140 cycles by changing the magnet windings. The series constant-current, direct-current lamps can be adapted to currents from 4 to 10 amperes by changing windings.

TABLE III
WATTS PER SQUARE FOOT FOR INTERIOR ARC LIGHTING

Building	Watts per Square Foot Average Conditions	Watts per Square Foot Variation
Machine shops, high roofs, no belts	.75	.50 to 1.00
Machine shops, low roofs, belts, and other obstructions	1.00	.75 to 1.25
Hardware and shoe stores75	.50 to 1.00
Department stores, light material, bric-à-brac, etc.	1.00	.75 to 1.25
Mill lighting, plain white goods . .	1.10	.90 to 1.30
Mill lighting, colored goods, high looms	1.30	1.10 to 1.50
General office, no incandescents . .	1.50	1.25 to 1.75
Drafting rooms	1.75	1.50 to 2.00

METHODS OF DISTRIBUTION

SERIES DISTRIBUTION

23. Most of the arc lamps used for scattered street-lighting work are connected in series. For example, in Fig. 17, *A* represents a direct-current arc-light dynamo in the station and *l, l, l* arc lamps situated at different points on the street; *l, l'* represent the terminals of the lamps, which are marked + and - to distinguish them from each other. The current flows through the lamps in the direction indicated by the arrows; the + terminal should in each case connect to the upper carbon and the negative terminal to the lower. If one of the lamps *B* should be connected in the circuit backwards, as shown, the current would enter at the lower carbon and the lamp would burn upside down; in such a case the terminals should be changed so that the current will enter at the top carbon, as in the other lamps.

In a simple series circuit, the current through all the lamps will be the same unless there is a leakage to ground and across to the other line, as indicated, for example, by the dotted path *a-b*. There will be little leakage if the line is in proper condition, so that it may be generally assumed that the current through each lamp is the same.

The current in the circuit must be kept constant; i. e., the number of amperes must be kept the same no matter how many lamps are in use. If there were ten lamps in operation, each requiring 45 volts pressure, the dynamo would have to generate 450 volts. Suppose that three of the lamps are cut out by short-circuiting them—lamps in a

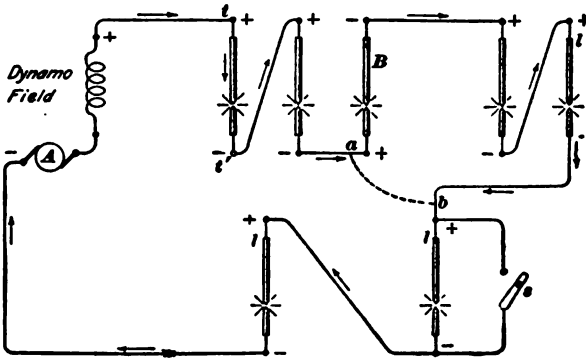

FIG. 17

series circuit must always be cut out by short-circuiting, otherwise the circuit will be broken. In practice, each lamp is provided with a switch, as indicated at *s*, which is used to cut out the lamp by allowing the current to flow past it. If the voltage remains the same, the current will increase, because the resistance of the circuit has been decreased; if the current is increased, the lamps will perform badly and perhaps be damaged. In order to keep the current the same, the voltage should be reduced to $7 \times 45 = 315$ volts, when the lights are cut out. This is done by providing the dynamo with an automatic regulator. In case the lamps are operated in series by means of alternating current, a

special transformer or regulator of some kind is used to keep the current constant.

The series system of distribution is very widely used for street lighting, and is, in fact, about the only system that can be used economically where the lights are scattered. As the same current flows through all the lamps, the system is operated by using a small current (usually from 6 to 10 amperes) at a high pressure. This calls for a small line wire (usually about No. 6 or No. 8 B. & S.), and thus requires a comparatively small expenditure for copper.

24. Arrangement of Series Circuits.—If a simple series circuit is operated, as shown in Fig. 17, the voltage generated by the dynamo or other source of current will be the voltage per lamp multiplied by the number of lamps plus the voltage drop in the line. If the number of lamps operated is large, the voltage required becomes very high. Thus, in order to operate 75 enclosed-arc lights, the machine must generate, roughly, 6,000 volts, allowing 80 volts per lamp so as to include the drop in the line. Up to within a comparatively recent date, this was considered about as many lamps as could be operated from one machine, because of the difficulties of construction and operation at higher voltages. The result was that a station operating a large number of lights had to be equipped with a number of comparatively small machines, which were, at best, not very efficient. To overcome this, the so called *multicircuit machines* were brought out, which are capable of operating 125 to 150 lights. The construction of arc dynamos has also been perfected to such an extent that machines are now built capable of operating 150 lights on a single circuit.

25. Multicircuit Series Machines.—There are two kinds of multicircuit machines; namely, those in which there are two or more circuits in series and those in which there are two or more circuits in parallel. The later styles of Brush machine are examples of the first kind; the new type of Western Electric machine is an example of the second. The newer and larger style of Brush machine is of the

multipolar type, but is similar in principle to the old two-pole machine. The principal difference is in the arrangement of the circuit connections.

Suppose that *A* and *B* represent two of the commutators of a Brush machine which in the older machines were connected in series, as shown in Fig. 18 (*a*), across a single circuit. The voltage between the terminals of the circuit 1-2 is equal to the sum of the voltages generated in the sections of the armature *A* and *B*. Suppose, however, that two series of lamps are arranged as shown in Fig. 18 (*b*). Here the same number of lamps are connected in series as before, but they are divided into two circuits 1-2 and 3-4, and the pressure between points 1, 2 is one-half what it was before, because there are only one-half as many lamps connected between 1, 2 as there were in the previous case.

The whole object of this arrangement is to allow a large number of lamps to be operated in series without introducing extremely high pressures on the line and dynamo. This may, perhaps, be more clearly understood by taking the example shown in Fig. 19. It would not

be necessary to use a multicircuit arrangement for as small a number of lights as ten, but it will serve to illustrate the point. If it is assumed that open-arc lamps are used and 50 volts allowed per lamp, so as to include the line drop, 500 volts will be required for operating the single circuit in Fig. 19 (*a*). The fall, or drop, in pressure from the + to

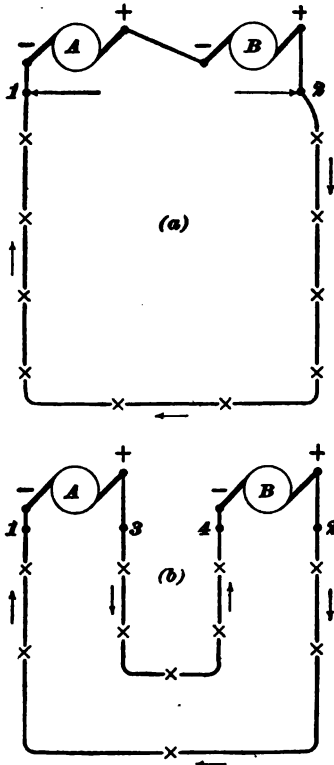

FIG. 18

the - terminal of the machine can, therefore, be represented as indicated in Fig. 19 (a). Each section of the armature generates 250 volts, and as these are connected directly in series, there are 500 volts across the circuit.

Suppose, now, that the ten lamps are connected as in Fig. 19 (b). Take the point 1 as a starting point and assume that it is at zero potential. The armature section *A* raises the pressure to 250 volts, so that there is a difference in pressure of 250 volts between points 3 and 1. The current

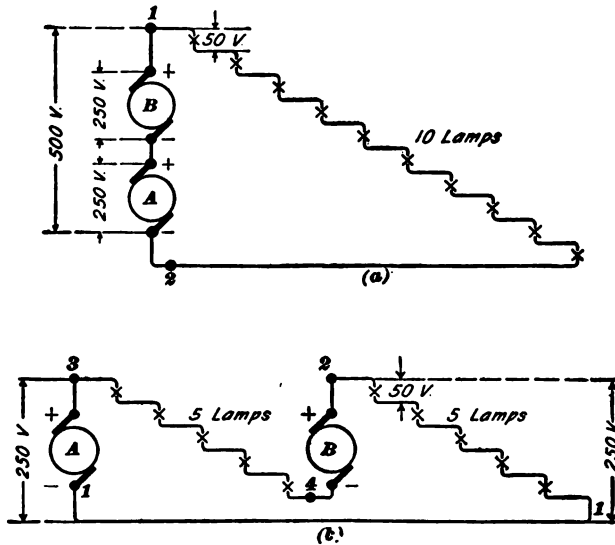

FIG. 19

then passes through the circuit 3-4 containing five lamps, and the pressure drops off as indicated. Armature *B* again raises the pressure 250 volts, so as to operate the five lamps in circuit 2-1.

It is thus seen that the multicircuit arrangement shown in (b) operates the same number of lights as in (a), and the maximum pressure between the terminals of the dynamo or between the terminals of either of the circuits is one-half that in the single-circuit scheme of operation. This description has been given with reference to dynamos, but the same

multicircuit plan can be used with transformers supplying series alternating-current lamps. The transformer has a secondary consisting of two or more coils connected in exactly the same manner as described for the armature windings.

Since, in the multicircuit arrangement, as used on the Brush machines, the several circuits are in series with each other, the current must be the same in all and only one regulator is necessary on the dynamo. Where two independent circuits are operated in parallel from the same machine, the voltage applied to each of the circuits must be capable of independent regulation. For this reason, the Western Electric multicircuit machines are provided with two independent regulators, one for each circuit. Some of the larger Brush machines are arranged so as to operate four circuits, though any of these dynamos may be operated as ordinary single-circuit machines if desired.

PARALLEL DISTRIBUTION

26. When arc lamps were first introduced, **parallel distribution** was not very common, but now a large number of lamps are operated in parallel on constant-potential circuits, both direct and alternating. The increased use of enclosed-arc lamps for store and factory illumination is largely responsible for this. Such places were usually equipped with low-pressure, constant-potential plants for incandescent lighting, and series arc lamps for interior work are more or less objectionable on account of the high pressures necessary for their operation. The series arc lamp is, however, used for interior illumination in some large concerns where a large number of lights must be operated. Enclosed-arc lamps are operated in parallel by connecting them directly across the line, as indicated in Fig. 20. Each lamp is here provided with a double-pole switch and cut-out or branch block carrying fuses for protection in case a short circuit occurs in the lamp. Most lamps have a switch mounted on them, and it is only necessary to provide a separate switch, as shown, when control of the lamp from a distant point is desired. Of course, the switch

is arranged to open the circuit through the lamp, and not short-circuit it, as when cutting out a series lamp. Fig. 21 shows the lamps connected to an ordinary 110-volt, direct-current system. By using lamps with a slightly different mechanism, they may be operated from the secondary of a transformer, as shown in Fig. 22.

27. When arc lamps are operated from constant-potential direct-current mains, it is necessary, for two reasons, to connect a resistance, Fig. 20, in series with the arc. In the first place, the lamps will not regulate well without it, and

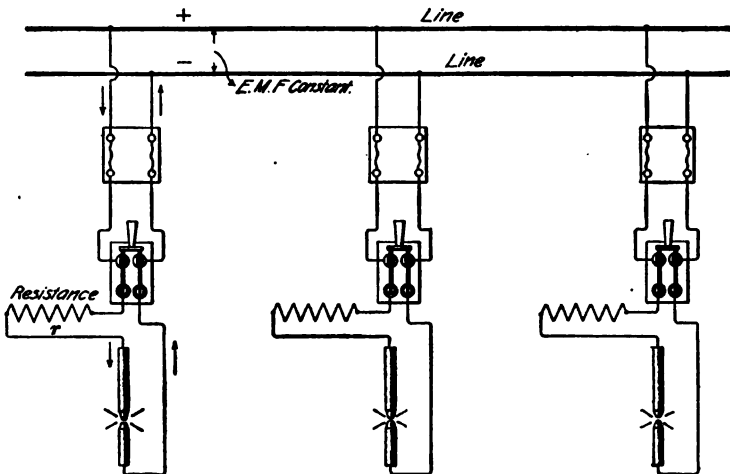

FIG. 20

in the second place, the voltages used on constant-potential circuits are usually considerably higher than the voltage required by a single arc lamp, so that the excess voltage must be taken up in a resistance. If an arc lamp is connected directly to constant-potential mains, without the intervention of any resistance, its action is unstable. If the current flowing through an arc increases, the resistance of the arc decreases, because the increased current causes the cross-section of the arc to increase. On the other hand, if the current decreases, the resistance of the arc increases. The consequence is that if the constant voltage of the mains

is just equal to that required by the arc and if the current through the arc, for any reason, decreases a little, the resistance offered by the arc at once increases, thus causing a further decrease of current and increase of resistance, with the result that the arc goes out. On the other hand, an increase of current results in a decrease of resistance, and this causes a still further increase of current. The operation of the lamp is therefore unstable, and the arc will not remain constant for any length of time.

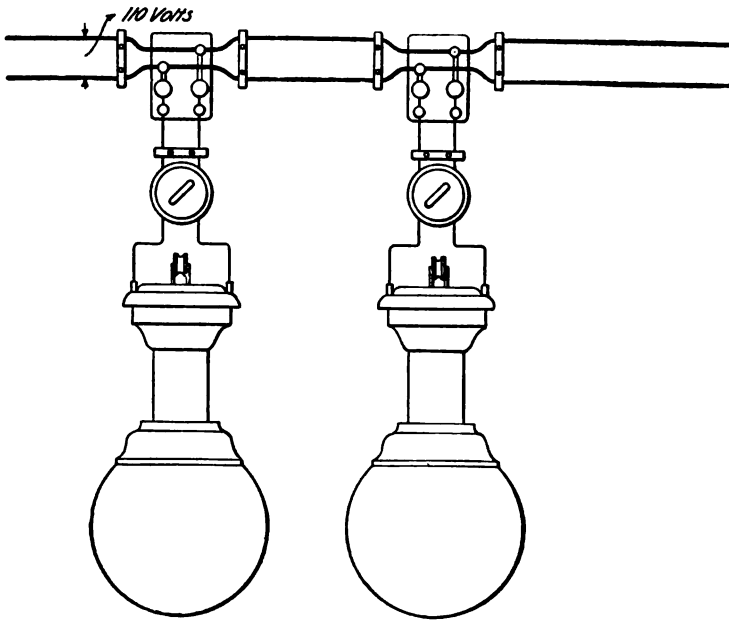

FIG. 21

Now, if a line voltage somewhat higher than that required by the lamp is used and enough resistance inserted to give a drop through the resistance sufficient to bring the arc voltage to the correct amount when the normal current is flowing, the lamp will become stable in its action. For, suppose the current decreases a little; the drop through the resistance will decrease and, since the line voltage is constant, the voltage across the arc will be increased, thus compensating for the

increased arc resistance. Also, if the current increases, the drop through the resistance at once increases and the voltage across the arc is lowered. In alternating-current lamps, a *reactance*, or *choke coil* takes the place of the resistance; this consists of a coil of wire wound on an iron core. When the

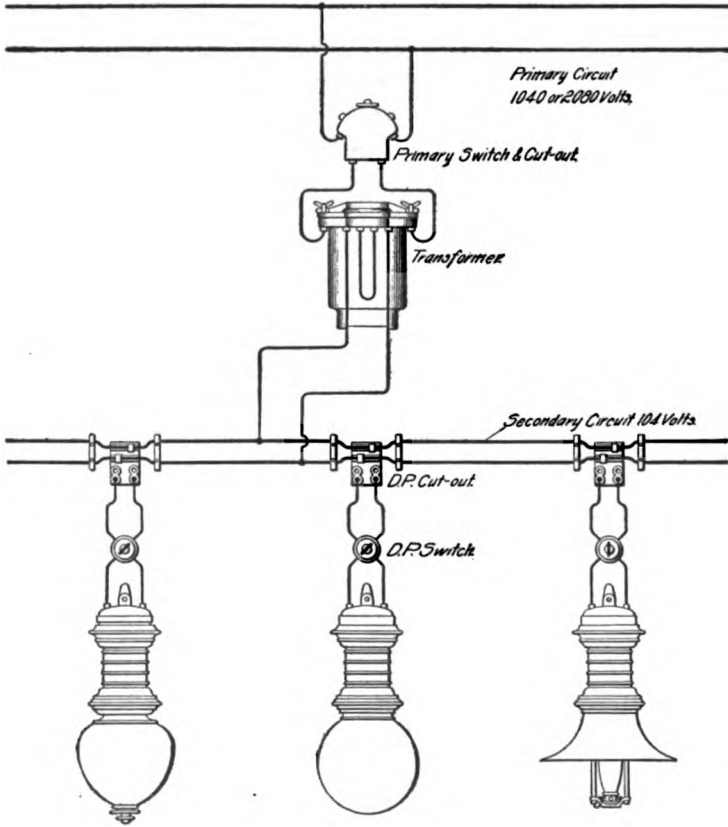

FIG. 22

alternating current passes through the coil, the changing magnetism set up generates a counter E. M. F. in the coil. The choke coil wastes less energy than the resistance, but, of course, it cannot be used with a direct-current lamp, as the direct current is not capable of setting up the alternating magnetism necessary to generate the counter E. M. F. The

resistance or choke coil, as the case may be, is generally mounted in the top of the lamp and is arranged so that it will be ventilated, in order to insure cool running.

28. 220-Volt, Enclosed-Arc Lamps.—Enclosed-arc lamps for operation in parallel across 220-volt mains are built, but they are not quite as efficient or satisfactory as the 110-volt lamp. They operate with about $2\frac{1}{2}$ amperes and take 140 volts at the arc. Another type of 220-volt lamp consists of two 110-volt lamps combined in one; that is, there are two sets of carbons and two arcs connected in series. Still another plan is to use two lamps in series across the circuit.

29. Enclosed-Arc Lamps on 550-Volt Circuits. It is very often desirable to operate enclosed-arc lamps on 550-volt railway circuits for the illumination of car barns, street-railway parks, etc. The special types of lamp made for this purpose are generally operated, five in series, across the circuit so that each lamp receives, approximately, 110 volts. Each lamp is usually provided with a resistance in conjunction with an automatic cut-out, so that in case a lamp is cut-out of circuit the remaining lamps will not get an excessive current and will burn uninterruptedly.

ARC LAMPS

30. The different makes and types of arc lamps in commercial use are so numerous that it is impossible to give a complete list of them here. This is, however, not necessary, because many of the types differ only in mechanical details and involve no new principles. Complete instructions concerning the different makes are furnished by the manufacturers, and all that is necessary is to point out the features peculiar to lamps adapted to the various kinds of service.

No matter what type of lamp is used, it must be arranged so that the carbons will be kept the proper distance apart. In a few special cases, as for example, in some searchlights

or projection lamps, this is accomplished by hand, but in all commercial lighting work the lamp must be provided with a mechanism that will feed the carbons together as they are consumed. In most cases, the lower carbon is fixed and the top one is fed down in such a way as to keep the arc of the proper length. When the upper carbon is released by the lamp mechanism, it is fed down by the attraction of gravity. Gravity is therefore the propelling force in most lamps, and the whole lamp mechanism is essentially a device first to separate the carbons and start the arc and then to release the carbon and allow it to feed down at the proper time. The mechanism generally consists of a clutch or clockwork controlled by electromagnets, the current in which depends on the condition of the arc that releases the clutch or clockwork, thus allowing the carbon to feed down whenever the arc exceeds the length for which the mechanism is set. The mechanism must also be arranged so that the lamp will regulate without affecting other lamps on the circuit. This is comparatively easy to accomplish in the case of lamps operated in parallel, because the pressure across the mains is constant, and each lamp is independent of the others. In the case of the series lamp, however, the current that flows through one lamp also flows through all the others, and each lamp must be arranged so as to feed when necessary, no matter what may be the condition of the others.

CONSTANT-POTENTIAL LAMPS

31. The regulation of constant-potential lamps is usually brought about by an electromagnet or solenoid connected directly in series with the arc, and designed to operate either a clutch or clockwork mechanism so as to feed the carbon when required. For example, take the simple arrangement shown in Fig. 23. This is not intended to illustrate any particular make of lamp, but simply to bring out some of the points connected with the operation of constant-potential lamps in general. By far the greater number

of lamps in use employ a clutch rather than a clockwork feed. In Fig. 23, t, t' are the lamp terminals connected across a constant-potential circuit; r is the resistance inserted to take up the surplus voltage and to make the action of the lamp stable; S is a solenoid connected directly in series with r and arranged to draw up core c when current passes; d is the clutch, which is here shown simply as a washer with a hole a little larger than the rod e , to which the upper carbon is attached; f is a stop against which d strikes when the core c lowers a sufficient amount; g is the top (positive)

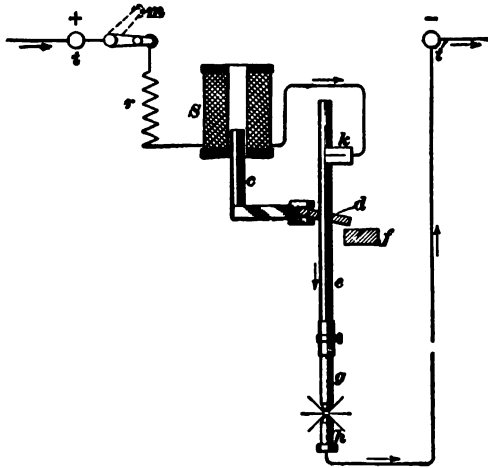

FIG. 23

carbon and h is the lower (negative). The current enters at t , passes through r and S to the brush k , which makes a sliding contact with the carbon rod e . From e , it passes to the top carbon g , thence to the lower h , and out at t' . This is supposed to be a direct-current lamp; hence, the current should flow as shown, so as to bring the crater in the upper carbon. With an alternating-current lamp, it would, of course, make no difference how the lamp was connected.

When the current is off, d comes down against f and the latter is tilted so that e slides through until g strikes h . As soon as the current is turned on by closing switch m , the core c is at once drawn up to the full limit for which the

lamp is adjusted. As soon as c moves up, d tilts, as shown in the figure, and grips e thus raising g and striking or starting the arc. As the carbons burn, the arc gradually becomes longer, and consequently the resistance of the lamp as a whole increases. One fact that must not be lost sight of is that this lamp is connected in parallel across a constant-potential circuit; hence, as the arc lengthens the current through the lamp is bound to decrease, no matter what current the other lamps on the same circuit may be taking. The result is that as the arc gets longer, S becomes weaker because of the smaller current and c lowers a little. When c has moved a short distance, d comes in contact with f , and as c drops still farther, d is tipped a little and allows rod e to slide through. As soon as the carbons come nearer together, the current at once increases, c is pulled up, and the rod is held until the current becomes small enough to allow it to feed again. In this way the carbon is fed down a little at a time, and the feeding is brought about by the decrease of the current due to the increase in the length of the arc.

SERIES ARC LAMPS

32. The regulation of series arc lamps and the mechanism necessary for their operation present a different problem. In the first place, when the lamps are run in series, the current is always maintained at a constant value, or it should be if the regulator on the circuit works properly. Hence, a series magnet alone is not able to do the regulating, because its pull remains the same no matter what may be the condition of the arc. Again, there must be some device in the series lamp that will preserve the continuity of the circuit in case a carbon breaks, falls out, or the circuit through the lamp becomes broken in any way. If such a device is not provided, an open circuit in the lamp will result in all the lights on the circuit going out. This device is called a *cut-out*.

Although the current through the arc remains constant in a series system, the voltage across the arc increases as its

length increases, and this increased voltage is made to bring about the regulation. Suppose that the simple lamp shown in Fig. 23 is modified by extending the core c downwards and adding another coil S' , as shown in Fig. 24; the starting resistance r can also be omitted, as this is to be a series lamp, and there will be no excess voltage to be taken up. The current is maintained at a constant value and resistance is not necessary to insure stability of operation. The second coil S' is wound with a large number of turns of fine wire, so that when it is connected in shunt across the arc,

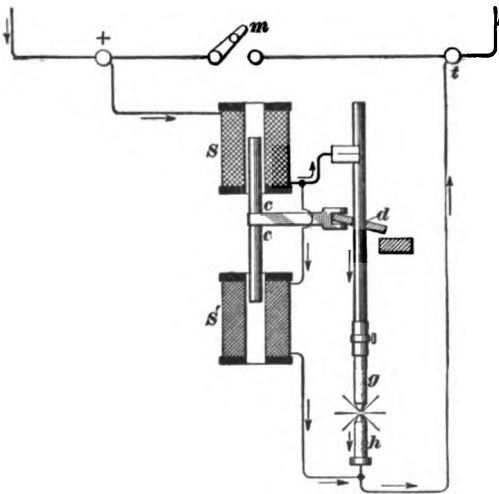

FIG. 24

as shown, only a small current will flow through it. The coils S , S' pull c in opposite directions, and c will always take up a position where the two pulls are balanced. The action of the lamp is as follows: When the current is off, carbons g , h are in contact. Switch m is connected across the terminals, and in order to put out the lamp, m is closed. When the lamp is thrown into circuit, the main current passes between g and h , but since the carbons are in contact there will be little or no drop in potential between them, and hence, practically no current will pass through the shunt coil S' . Coil S pulls up the plunger, and in so doing lifts the upper

carbon and starts the arc. The instant, however, that the carbons g and h separate, current flows through S' , because there is then considerable difference of potential between g and h . The result is that as the carbons are separated, the downward pull of S' becomes stronger until it finally balances the upward pull of S , when the arc remains stationary. As the carbons burn away, the arc becomes longer; hence, its resistance increases and the voltage across the arc increases. The pull of S does not change, because the main current is maintained constant by the dynamo. The pull of S' keeps increasing as the carbons burn away, and c is gradually pulled down until the lamp feeds. As soon as g feeds down the pull of S' decreases, because the arc shortens; hence, the position of c becomes again balanced, and so on, the plunger c moving back and forth through a small range between the coils. By properly adjusting the clutch, such a lamp may be made to keep the arc at the proper length within very close limits.

33. The essential features of the above lamp should be carefully noted, because most series lamps depend for their operation on the use of two coils. One of these, the series coil, carries the main current, and is opposed by the shunt coil, which carries a current depending on the length of the arc. The current in the shunt coil depends only on the length of the arc in each individual lamp and is independent of the condition of the other lamps. A lamp of this kind is known as a *differential lamp*, because the position of the core c depends on the difference in the pulls between S and S' . The simple series lamp shown in Fig. 24 is not provided with an automatic cut-out, but the action of this device will be explained later when some of the different types of lamp are described. In some makes of lamp, the coarse-wire and fine-wire coils are both wound on the same spools, and instead of using solenoids with a core that is drawn into them, the coils are provided with a fixed iron core and arranged so as to attract an armature that releases the clutch or clockwork mechanism, as the case may be.

34. Some series arc lamps are of the so-called *shunt* type. The series coil in these lamps is used only to strike the arc and it does not act in opposition to the shunt coil. The feeding is brought about by the shunt coil only, acting against a spring. The old Thomson-Houston open-arc lamp described later is of the shunt type, whereas the old Brush open-arc lamp is a good example of the differential class where the series coils and shunt coils are wound on the same cores.

EXAMPLES OF ARC LAMPS

CONSTANT-CURRENT, OPEN-ARC, SERIES LAMPS

35. Open-arc lamps, using carbon electrodes, are now seldom used in America for new work and in many cases they are being removed and replaced by lamps of the enclosed-arc type. There are, however, quite a large number of these lamps still in use, and a short description of the two most common types will be given here. If the operation of these lamps is thoroughly understood, the operation of enclosed-arc lamps will be easily grasped, because the principles involved are the same in both.

36. Brush Arc Lamp.—Fig. 25 shows the connections for a Brush double-arc lamp intended for operation on a constant-current series circuit. Two carbons are provided in order that the lamp may burn all night without retrimming. The lamp is of the differential type, *SS* being the series coils and *S'S'* the shunt coils wound on iron cores *l, m*. In the lamp these coils are wound one on top of the other, but they are shown side by side in Fig. 25 for the sake of clearness. *P* and *N* are the positive and negative terminals. The poles of the regulating magnet are at *l, m*; *o* is an armature that moves up and down with the rocker *R* hinged at the points *p, p*. The clutches are not shown in Fig. 25, but their operation will be described later. The positive carbons *e, e* are attached to the carbon rods *u, v*. When no current is flowing through the lamp, the armature *o*

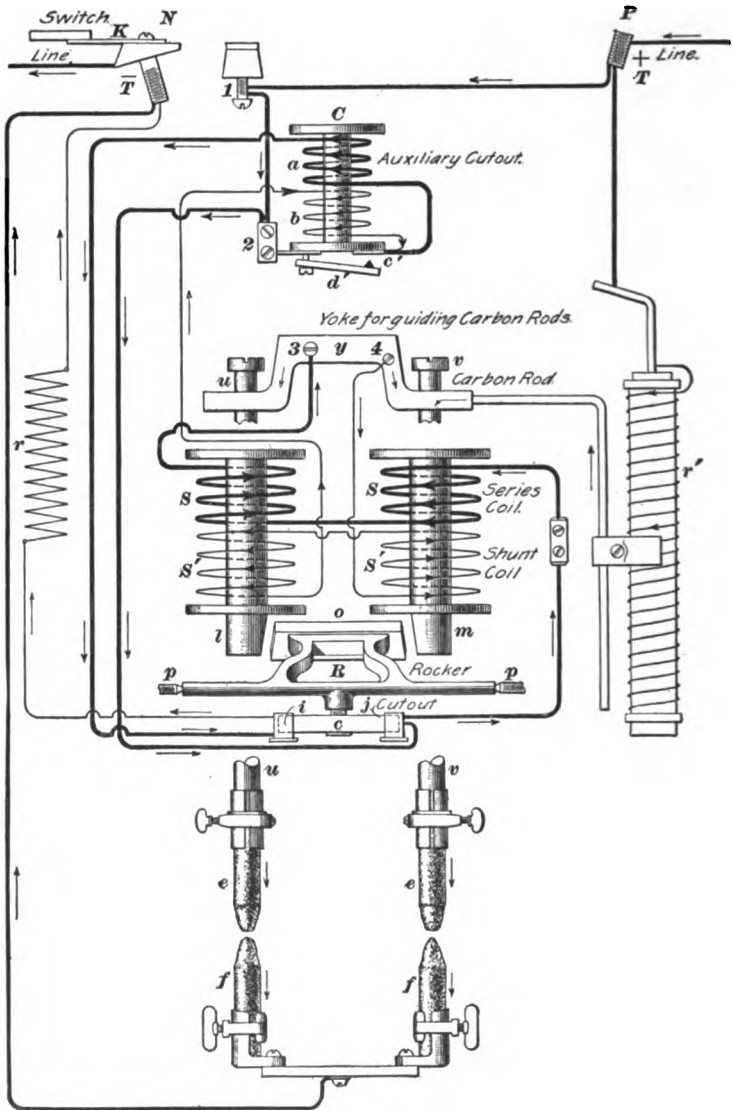

FIG. 25

and the rocker R are in the lowest position, and the strip c comes in contact with the terminals i, j , thus cutting out the lamp and allowing the current to take the path $P-1-2-j-i-r-N$. C is an auxiliary cut-out provided to cut out the lamp whenever the pressure across the arc exceeds 70 volts. It consists of a magnet provided with two windings a and b , connected as shown, and a pivoted armature d' that makes contact at c' when the magnet acts. A small amount of adjustable resistance r' is in shunt with the series magnet S . By regulating this resistance, the pull of the series magnet can be adjusted; r is a small starting resistance connected in series with the cut-out c .

37. First suppose that the lamp is connected in circuit but is short-circuited by the switch blade K on top of the lamp being placed on contact 1 . Under these conditions no current flows through the mechanism, the armature will be down, the carbons in contact, and piece c will connect i and j . Now, suppose switch K to be opened; the current will then take two paths as follows: $P-r'-y-u-c-f-N$ and $P-1-2-j-i-r-N$. However, since S, S are connected in shunt with r' , a portion of the current will flow through the series coils, taking the path $1-2-j-S-S-y$, and the armature will be lifted, thus separating the carbons and establishing the arc. As soon as the armature is raised, contact c leaves the terminals i, j and the current passing through r is interrupted, with the exception of the small current that passes through the fine-wire coils S', S' . The clutch has now lifted the carbons and the lamp is in operation. One end of the fine-wire coil connects to the upper carbon, as indicated at 4 , and the shunt current takes the path $4-S'-S'-b-c'-a-i-r-N$; thus, the coils S', S' and b are in series and are connected in shunt with the arc. Coils a and b tend to raise the armature d' , but the current flowing under normal conditions is not sufficient to actually raise it. It should be noticed that the current circulates around S', S' in a direction opposite to that in S, S .

As the carbons burn away and the arc becomes longer, the current through the shunt coil increases, thus making

the poles of the controlling magnet weaker and allowing the armature and rocker to drop gradually until the clutch releases and allows the carbon rod to slide down a little.

38. Fig. 26 shows the clutch used in this lamp. The piece *a* rises and falls with the rocker; when it is raised, piece *b* is clamped against the carbon rod by means of the small lever *d*, and the movement of the armature lifts the whole rod. When *a* descends, because of the magnets becoming weaker, the whole clutch and rod move down

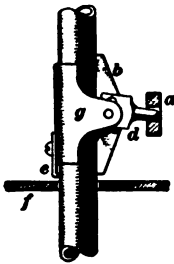

FIG. 26

until the piece *c* strikes the plate *f*; *g* then remains stationary, while *a* moves down a little farther, thus moving the small lever *d* and unlocking the clutch.

39. Suppose that a carbon rod sticks in some way and fails to feed properly. The arc gradually becomes longer and the voltage across it increases until the current in the shunt circuit becomes much larger than the normal amount; this causes the armature *d'* of the auxiliary cut-out *C* to be drawn up and contact made at *c'*. The current then takes the path $P-1-2-d'-c'-a-i-r-N$; the series coils and shunt coils are both cut out, but the current flowing through *a* holds up *d'*. The cutting out of the main coils causes the rocker to drop and *c* comes into contact with *i* and *j*, thus cutting out the auxiliary cut-out. If the dropping of the rocker frame makes the carbons come together, part of the current will pass through the series coils by the path $2-j-S-S-3-u-e-f-N$, because in the other path there is the resistance *r*, and the lamp will start up again. If starting resistance *r* were not used, the path $2-j-c-i-N$ would be of low resistance compared with $2-j-S-S-3-u-e-f-N$, and the lamp would not relight. If the carbon becomes broken or falls out, a large current will, for an instant, pass through the fine-wire coils; hence, *d'* will at once rise and cut out the lamp. Of course, in this case, *c* will come into contact with *i* and *j* and remain there, because the carbons cannot come into contact again and allow the lamp to relight. If no cut-out were provided, there

would not only be danger of a break in the circuit, due to the carbons being broken or failing to feed, but in addition the shunt coils would be burned out because the whole current would, under these circumstances, pass through them.

40. One of the clutches is adjusted so that it will grip the carbon rod a little before the other when the rocker is raised. This starts the arc on that pair of carbons and they continue to burn until the upper carbon has fed down to the limit fixed by the adjustment of the lamp. When this occurs the arc becomes long enough to let the rocker down sufficiently far to operate the second clutch and start the feeding of the second carbon.

41. Thomson-Houston (T. H.) Lamp.—The Thomson-Houston lamp differs considerably from the differential lamp just described. The series coil is used only to start the arc, and when the lamp is in operation under normal conditions, no current flows through the coil. The regulation is effected by means of the shunt coil alone, and when the lamp is not burning the carbons are separated instead of being together, as is the case with most lamps. Fig. 27 shows the connections and general arrangement of the essential parts. *A* and *B* are the + and – terminals; *EE* is the carbon rod carrying the upper carbon *m*; the lower carbon *n* is supported by the lamp frame, not shown in the figure; *R* is a rocker frame pivoted at *x* and carrying an iron armature *O*. This latter has two holes in it, through which the conical pole pieces of the magnet project when the armature is pulled down. When the lamp is not in operation, the frame is held at its highest position by the adjustable spring *P*; the movements of the rocker are steadied by the dashpot *C*; *s* is one of the series coils wound over the shunt coils *M* of which there are two side by side. The small coil *H*, called the starting coil, is in series with the carbons and its office is to cut the series coil *s* into or out of action. It is provided with a movable armature *K*, on which is mounted the insulated contact *f* tipped with silver; *e* is another silver-tipped contact connected to the point *c*. When no current flows

through H , e and f are in contact; p and r are the cut-out contacts, the action of which will be described later. L is the clutch and its action is very similar to the one just described for the Brush lamp.

42. In Fig. 27, the clutch L and frame R are up and the carbons are drawn a short distance apart. In order that the

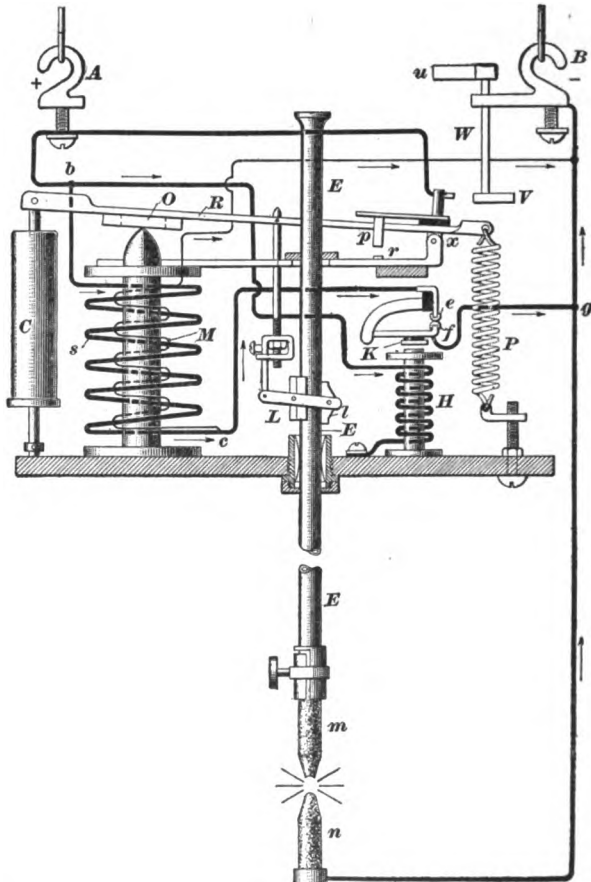

FIG. 27

lamp may be started, m must be lowered so as to touch n , as follows: At the instant that the current is turned on, e and f

are in contact, because no current is flowing through H ; hence, as soon as the current passes, it takes the path $A-b$ through the series coil $s-c-e-f-g-B$. Practically, no current will go from c through the shunt coil to B , because of the high resistance of this path compared with the other. As soon as the current passes through s , the rocker is pulled down and the clutch is released, bringing the carbons into contact and allowing part of the current to take the path $A-b-H-E-m-n-B$. As soon as current passes through H , the armature K is attracted, thus separating e and f and cutting off the current through the series coil s with the exception of the small current through the shunt coil M . The rocker rises and carries with it the upper carbon, thus separating the carbons and starting the arc. As soon, however, as the carbons are separated, there is considerable difference of potential across the arc; hence, the shunt coil M takes its normal current and holds the rocker at the proper point to give the length of the arc for which the lamp is adjusted. It is thus seen that the series coil is cut out after the arc has been started.

The lamp is now burning, and as the arc grows longer the pull of the shunt coil increases and the rocker is gradually pulled down until the shoe l of the clutch comes against the stop, and any further movement causes the rod E to slide down a little. The pull due to the shunt coil decreases with the shortened arc, and the rocker rises to its normal position. The feeding is thus brought about by the action of the shunt magnet working against the spring P .

43. If the carbons should stick and fail to feed, the arc will gradually grow longer until the pull exerted by the shunt magnet will be sufficient to bring the cut-out contact p down against r . The current will then take the path $A-p-r-E-m-n-g-B$ in preference to passing through H ; K will rise and bring e and f in contact. The current will then take the path $A-b-s-c-e-f-g-B$; the series coil will hold down the armature and the lamp will be cut out unless the movement of the rocker releases the rod and allows the carbon to

feed, in which case the lamp will continue to burn and rocker R will rise again, thus separating p and r . If a carbon falls out, the current through the shunt will suddenly increase and the current through H will be interrupted, R will be pulled down, and K will rise, the final result being that the lamp is cut out.

44. When the lamp is to be switched out, switch W is used. This takes the form of a cam V operated by the lever u . When the handle is turned to one side, the cam comes against the casting that carries the upper cut-out contact, and thus establishes a short circuit from terminal to terminal. Most series lamps of the types just described take about 9.6 amperes for the 2,000-nominal-candlepower size and 6.6 amperes for the 1,200-candlepower size. The pressure across the arc is from 40 to 50 volts and the carbons are generally $\frac{1}{16}$ inch, $\frac{1}{8}$ inch, $\frac{3}{16}$ inch, or $\frac{1}{4}$ inch in diameter.

CONSTANT-CURRENT, ENCLOSED-ARC, SERIES LAMPS

45. **Voltage Required by Enclosed-Arc, Series Lamps.**—As stated, the enclosed arc is much longer than the open arc; the lamps, therefore, take a rather small current and the voltage across the arc is high. This is a decided advantage where lamps are operated in parallel on constant-potential systems, where the pressure is nearly always higher than that actually required by the lamp and the excess voltage has to be taken up by a resistance or choke coil. When, however, it comes to operating lamps in series, the high voltage across the arc becomes, to a certain extent, a disadvantage. It means that for a given number of lamps operated on a circuit, the pressure at the terminals of the circuit must be higher for enclosed arcs than for open arcs. This makes it difficult to operate a large number of lamps from one machine, but by using the multicircuit arrangement the pressure applied to each circuit can be kept down. It must be remembered, however, that where these high voltages are used the line insulation must be thoroughly good, and attempts to use these pressures on old lines having

poor insulation have resulted in continual trouble, to say nothing of the danger involved.

46. Alternating-Current, Enclosed-Arc, Series Lamps.—Enclosed arcs are often operated in series by constant current on alternating-current systems; i. e., the alternating current through the series of lamps is maintained at a constant value. The lamps used do not differ essentially from those for constant direct-current circuits, except that all magnet cores and armatures are laminated to prevent heating due to eddy currents, and the mechanism is designed so as to avoid disagreeable humming. The methods for supplying current to alternating-current series lamps and the arrangements for maintaining the current at constant value will be taken up when the subject of station apparatus is considered.

47. Current.—Enclosed-arc series lamps are ordinarily operated at about 6.6 amperes, and the voltage per lamp is from 70 to 78 volts, depending on the length of arc for which the lamp is adjusted. These lamps have also been built for a current as large as 8 amperes, with a correspondingly lower voltage, but the values given are the ones commonly met with.

48. Enclosed-Arc Lamp Construction.—The mechanism of an enclosed-arc lamp generally contains the same essential features as the corresponding open-arc, but in most cases the arrangement is simpler. The open-arc lamp must be fed frequently, because the carbons burn at a comparatively rapid rate and the clutch or other feeding mechanism must be accurately adjusted and kept in good condition if the lamp is to burn steadily. For this reason, the upper carbon of an open-arc lamp is attached to a carbon rod on which the clutch operates, and which is, or should be, kept in a clean, polished condition. The current is generally carried to the top carbon by means of a copper brush pressing against the rod. In the enclosed-arc lamp, the operation of feeding takes place at comparatively long intervals, and the feeding mechanism does not need to be so delicately adjusted. It is,

therefore, common practice to have the clutch operate directly on the carbon and to dispense entirely with the carbon rod. Such lamps are said to have a *carbon feed*. The doing away with the carbon rod makes the construction simpler and cheaper, besides allowing the lamp to be made shorter than is usual where a carbon rod is used. On account of the long

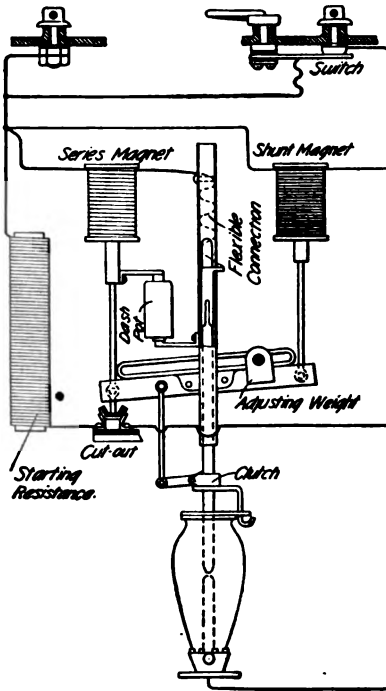

FIG. 28

arc common to enclosed-arc lamps, their mechanism must be arranged so that it will have a long pick-up; i. e., when the lamp starts up the mechanism must be such as to pull the carbons a considerable distance apart. In the case of series lamps, an automatic cut-out must, of course, be provided. In some of the latest types of enclosed-arc lamps, the series regulating coil is made of copper strip wound on edge and insulated with sheet mica between the turns. A coil so constructed radiates the heat readily and is more substantial than one wound in the usual way with cotton-covered wire.

In taking up the subject of enclosed-arc lamps, we will confine our attention to two or three typical examples that will serve to bring out the essential points relating to their construction and operation. The number of different makes of enclosed-arc lamp is very large, but they differ from each other principally in details of construction. The principles of operation are about the same in all of them, and the following are not selected because they operate any

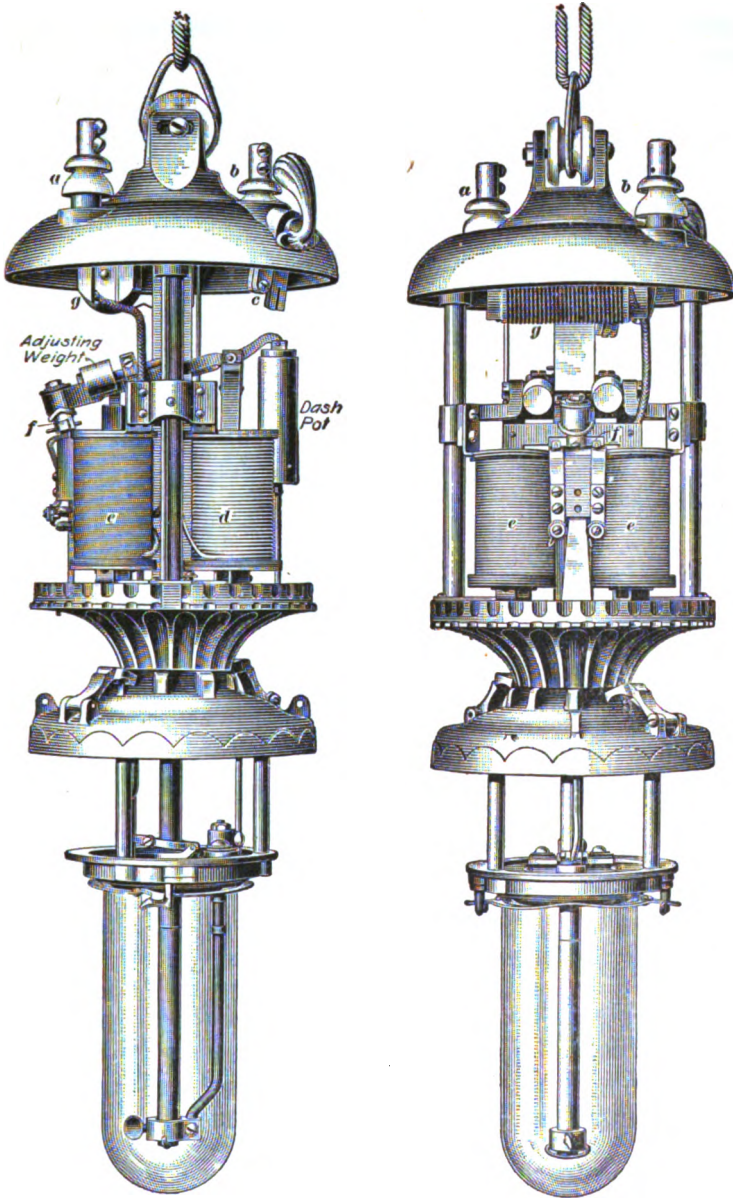

FIG. 29

better than several others, but because they will serve to bring out the points aimed at.

49. General Electric Lamp for Constant Alternating Current.—Fig. 28 shows the general arrangement of a General Electric lamp designed for operation on a constant alternating-current circuit.

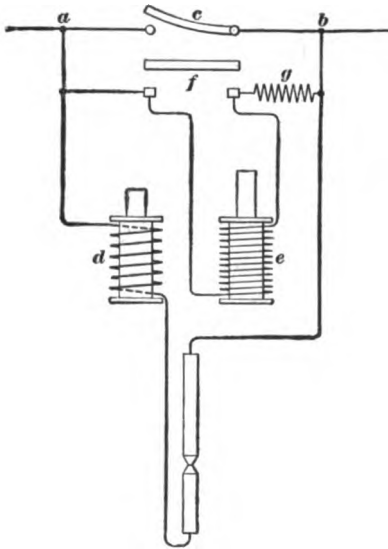

FIG. 30

There are two series coils and two shunt coils; only one of each shows in the figure since the two coils are in line. Each pair of coils has a U-shaped, laminated-iron core attached to either end of a rocker to which the clutch is attached. Current is carried to the upper carbon by means of a flexible cable that folds up in the carbon tube and the voltage at which the arc operates is adjusted by an adjustable weight on the rocker. A starting resistance and cut-out are provided, the operation of which is practically

the same as described for the Brush lamp. The lamp is of the differential type, the series coils and shunt coils working against each other through the rocker-arm. As in practically all enclosed-arc lamps, a dashpot is provided to steady the movements of the mechanism.

50. Western Electric Lamp.—Fig. 29 shows two views of the Western Electric series arc lamp for constant alternating current and Fig. 30 is a diagram of connections. The lamp is of the differential type. The terminals are at *a* and *b*; *c* is the short-circuiting switch; *d*, the series coils; and *e*, the shunt coils. A U-shaped, laminated core works up and down in each pair of coils and the arc is adjusted by

weights attached to the rocker so that they can be screwed in and out. In this lamp, the enclosing globe is closed at the bottom and the lower carbon is supported from the top. An automatic cut-out is provided at f and the starting resistance is located at g .

Enclosed-arc series lamps for constant direct current are much the same in construction as the alternating-current lamps. In direct-current lamps, it is not essential to have the magnet cores laminated. All alternating-current lamps have some inductance, hence their power factor is less than unity (see Table II). The fact that alternating-current arc lamps constitute an inductive load is to a certain extent a disadvantage, but the use of alternating current for arc lighting presents enough advantages to more than outweigh the disadvantages of an inductive load. The arc itself is non-inductive, but there is always a certain unavoidable amount of inductance in the magnet windings.

CONSTANT-POTENTIAL, DIRECT-CURRENT LAMPS

51. The mechanism of the **constant-potential, enclosed-arc lamp** is, as a rule, very simple. The feeding is controlled by a magnet connected in series and there is no need of a cut-out. The lamp should, however, be connected to the circuit through fuses, so that it will at once be disconnected in case of a short circuit anywhere in the mechanism. The series controlling magnet is usually arranged so that it attracts a core or plunger against the action of gravity.

52. General Electric Lamp.—Fig. 31 (*a*) shows a General Electric constant-potential, direct-current lamp with the casing removed. The magnets M are in series and arranged so as to pull up the plunger p to which the clutch rod is attached; the movements are dampened by means of the dashpot d . R is the resistance wound on a porcelain cylinder and connected in series; by varying R , the voltage at the arc can be adjusted. Fig. 31 (*b*) shows the connections which are very simple. Switch W cuts out the lamp by opening the circuit through it, not by short-circuiting it, as

in the case of constant-current lamps. Current enters at *P* and flows through the resistance and series coils to the upper carbon, thence to the lower carbon to *N*. This pulls up the core and separates the carbons. As they burn away, the current becomes weaker and *p* gradually lowers until the clutch is

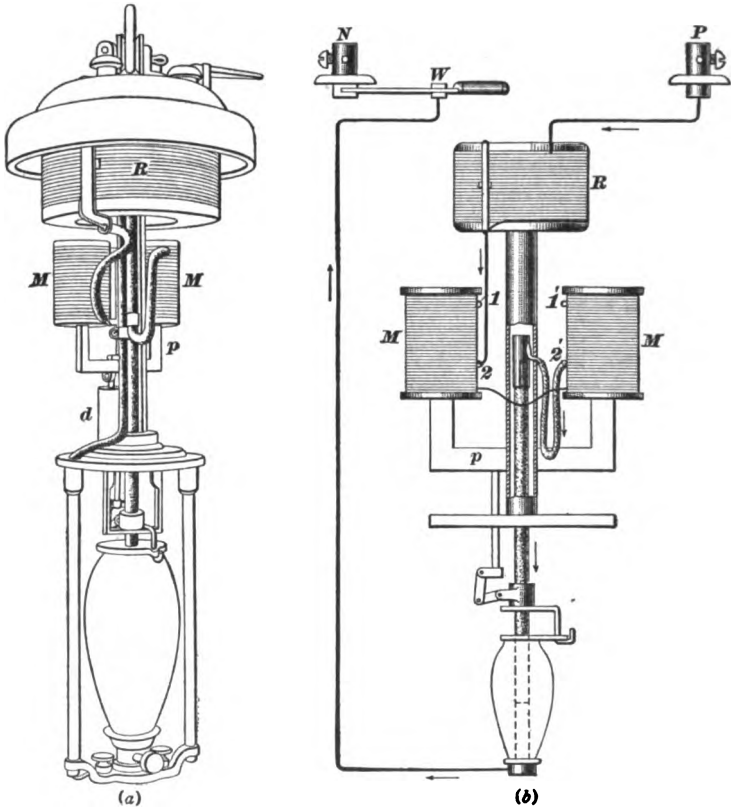

FIG. 31

released and the lamp feeds. The resistance is provided with a sliding contact, so that the lamp can be adjusted for pressures varying from 100 to 120 volts. The series coils are provided with two connections *1*, *1'* and *2*, *2'*, so that the lamp can be made to operate at $4\frac{1}{2}$ to 5 amperes or $3\frac{1}{4}$ to 4 amperes. When the larger current is used, the connections are as shown

in the figure, because fewer turns are then needed to operate the plunger. Solid carbons $\frac{1}{4}$ inch in diameter are generally used, and the voltage at the arc is about 80, leaving 20 to 40 volts to be taken up in the resistance. With $\frac{1}{4}$ -inch carbons, the lamp will burn 130 to 150 hours without retrimming.

Fig. 32 (a) is a view of a later type of General Electric lamp and (b) shows the connections. Corresponding parts in Figs. 31 and 32 are lettered alike. The distinguishing

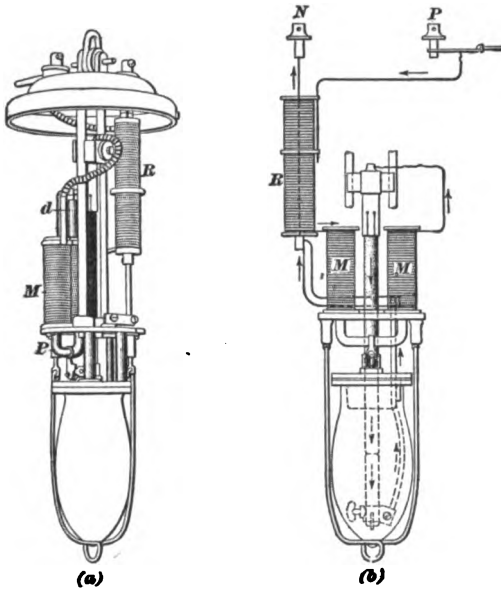

FIG. 32

feature of this lamp is that both the regulating and resistance coils are made of bare metal strip wound on edge with the turns separated by insulating material that is practically unaffected by heat. This construction makes very substantial coils and the heat is conducted from the inner part and radiated from the outside surface much more readily than with coils wound with cotton-insulated wire.

53. Western Electric Lamp.—Fig. 33 shows the connections for a Western Electric constant-potential lamp.

Current enters at the positive terminal and passes through switch *a*, upper carbon *b*, lower carbon *c*, coil *d*, adjustable connection *e*, coil *f*, adjustable resistance *g*, and out at the negative terminal. The arc voltage is adjusted by varying

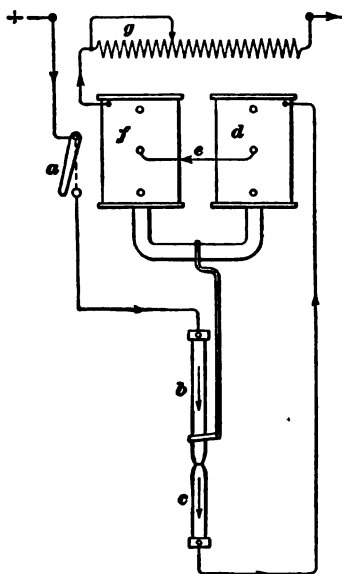

FIG. 33

the resistance *g*, and the number of active turns in the regulating coils can be changed by moving the cross-wire *e* to the upper or lower pair of coil terminals.

CONSTANT-POTENTIAL, ALTERNATING-CURRENT LAMPS

54. Fig. 34 shows the arrangement of a **constant-potential, alternating-current lamp**. The principal distinguishing feature of the alternating-current lamp is the use of the reactance, or choke, coil *L* in place of the resistance. This consists of a laminated-iron core *a* on which coils *b* are wound. The coils are connected in series and the ends 1, 2, 3, 4,

etc. left so that the wire *A* can be connected at different points. This allows the lamp to be adjusted for a considerable range of voltage and frequency. The reactance coil sets up a counter E. M. F., and thus introduces an apparent resistance into the circuit, which counterbalances the excess voltage and makes the lamp stable in its operation. The reactance coil is more economical than a resistance, but it and the series magnets introduce self-induction into the circuit. The frequency should not be below 60 cycles per second for satisfactory operation. This lamp will operate anywhere from 60 to 140 cycles; it takes about 72 volts at the arc and burns from 80 to 100 hours. The upper carbon is cored and the lower carbon solid.

MULTIPLE-SERIES, ENCLOSED-ARC LAMP

55. Fig. 35 shows a Western Electric constant-potential lamp, five of which are operated in series on 550-volt, direct-current railway circuits. It is a differential lamp provided

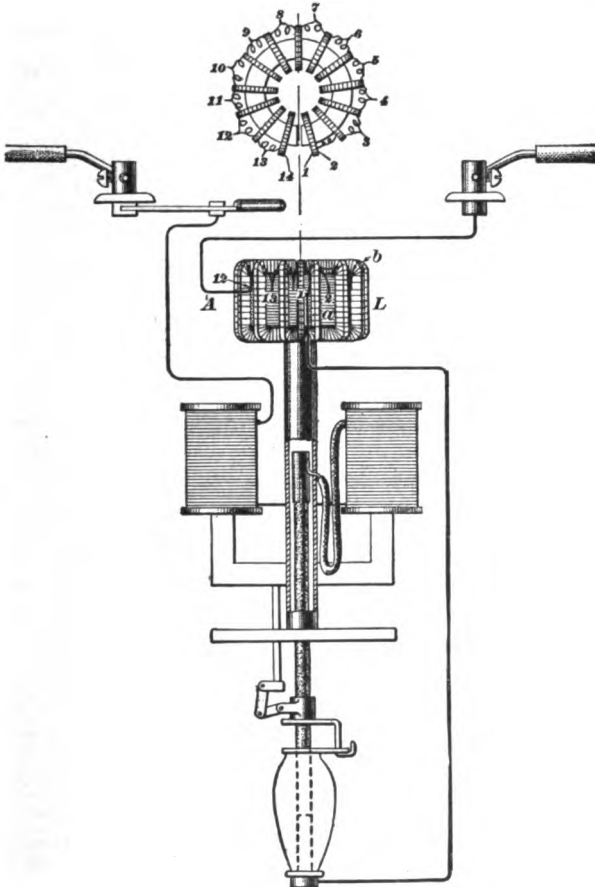

FIG. 34

with an automatic cut-out at *a*. When the lamp cuts out, the current passes through both resistances r and r_1 . Resistance r is not in circuit during the regular operation of the lamp,

but when the cut-out operates this resistance takes the place of the arc and prevents the other four lamps in the series from an excessive flow of current. The resistance r_1 is in

shunt with the series coil and is used to regulate the pull exerted by the coil.

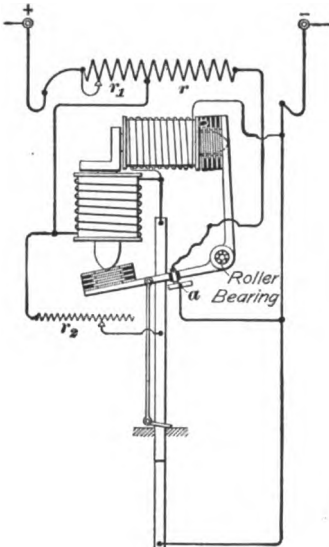

FIG. 35

FLAMING ARC LAMPS

56. Bremer Lamp.—In the ordinary arc lamp using carbon electrodes, very little light is given off from the arc itself. The bulk of the light comes from the highly heated carbon points and in direct-current lamps the crater formed in the positive carbon is the source of most of the light. The large amount of light emitted is due to the high temperature attained by the carbon points. Many attempts have

been made to produce arc lamps in which the light is given off from the arc itself, the electrodes being worked at a comparatively low temperature, thus securing a high efficiency and long life. In the **Bremer lamp** certain non-conducting metallic salts, as, for example, calcium fluoride, are incorporated in the positive carbon and are given off as vapor when the lamp is in operation, thus causing the arc to give off a large amount of light of a reddish-yellow color. Lamps of this type have been experimented with for some time but have not as yet been commercially adopted to any great extent.

57. Magnetite Arc Lamp.—The magnetite arc lamp developed by Mr. C. P. Steinmetz is a type of direct-current lamp where the light is given off from the arc. In this lamp, the electrodes give no light at all but the arc is long

and brilliant, emitting a light that is nearly white in color. The electrode that is consumed consists for the most part of magnetite or black oxide of iron. The magnetite in the form of powder is compressed in a thin iron tube and has a certain quantity of titanium compounds mixed with it to increase the steadiness of the arc and improve its brilliancy. The magnetite stick is about 8 inches in length and $\frac{1}{2}$ or $\frac{5}{8}$ inch diameter. An 8-inch electrode will burn 150 to 200 hours without difficulty. The magnetite constitutes the negative electrode of the lamp and is arranged below the positive electrode, which consists of a copper segment that is not burned away during the action of the lamp. The copper block conducts the heat away so rapidly that it does not become hot enough to melt.

When the lamp is in operation the magnetite vapor between the electrodes is highly incandescent and the arc, which is from $\frac{3}{4}$ to $1\frac{1}{2}$ inch in length, emits a brilliant light. A chimney that passes up through the lamp has its lower opening directly above the arc so that the particles, or fine smoke, given off from the magnetite stick can pass up through the chimney and out at the top of the lamp. Outside of this chimney and the copper segment used for the positive electrode, the construction of the lamp is very similar to that of an ordinary enclosed-arc lamp. The arc is, however, not enclosed; the electrode material is already an oxide, hence there is no need of providing an enclosing globe to prevent access of air and consequent oxidation. The lamp operates on 4 amperes at 80 volts, or takes 320 watts, and it is claimed gives a greater illumination than an ordinary enclosed-arc lamp consuming 460 watts. These lamps have, however, not been used commercially to a sufficient extent to enable a fair comparison, under all conditions of service, to be made.

SPECIAL APPLICATIONS OF ARC LAMPS

58. Arc lamps are extensively used for stage illumination in theaters, for photoengraving work, blueprinting, searchlights, or, in fact, any work where a strong light is necessary. For most of this work, the ordinary styles of arc lamps are not suitable, because such lamps are not of the focusing type. For projection work, it is necessary to keep the arc in a fixed position; in some cases this is accomplished

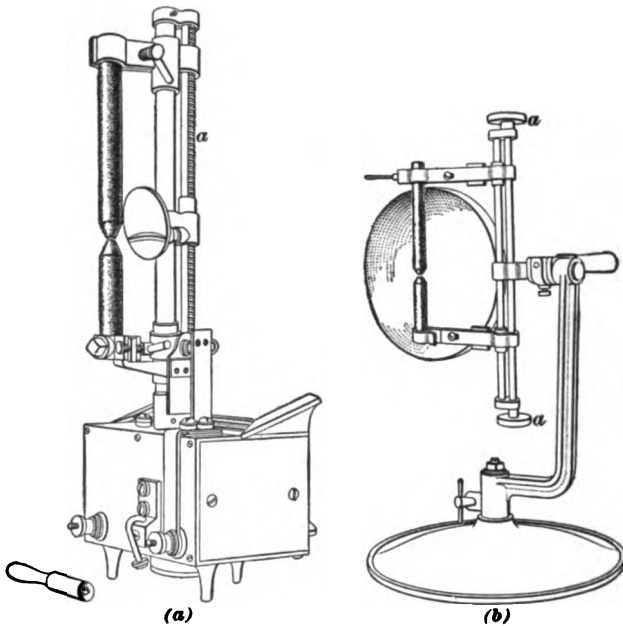

FIG. 36

by hand feeding, while in others the feeding is automatic. Fig. 36 (a) shows an automatic focusing lamp and (b) a hand-feed focusing lamp. The lamp (a) is usually mounted on a stand and provided with accessories to suit it for whatever kind of work it is used. It is designed for 20 amperes and is operated on direct-current circuits of 75 to 125 volts. The hand-feed lamp shown in (b) also operates normally at

20 amperes, but by using larger carbons, currents up to 50 amperes may be employed. The hand-feed lamp may also be operated with alternating current, but the alternating current is not very satisfactory for use in projection work. The hum caused by the arc is often very annoying, and moreover the arc is continually shifting around. In both lamps shown in Fig. 36, the carbons are fed together by screws and the rate of movement is adjusted so that the arc always remains stationary. If a lamp is to be used for short intervals only, the hand feed will be found quite satisfactory, because it is simple, cheap, and not liable to get out of order. If, however, the lamp is to be used for long runs, it is better to have an automatic feed. The lamp in Fig. 36 (*a*) is fed by the screw *a*, which is rotated by means of the lamp mechanism contained in the case below. In (*b*), the carbons are regulated by turning the knobs *a*, *a*.

59. When these lamps are run on a regular 110-volt circuit, a rheostat must be inserted in series with them in order to take up the excess voltage. The rheostat should be capable of carrying the current required by the lamp without undue heating, and should have enough resistance to give a maximum drop of about 70 to 80 volts when used on 110-volt circuits. About 20 to 30 volts of this drop should be adjustable, so that the current taken by the arc can be kept at the proper amount. For example, a lamp taking 20 amperes should have about $3\frac{1}{2}$ ohms in the rheostat, and at least 1 ohm of this should be split up into 10 or 15 sections and connected to a regular rheostat switch so that a good adjustment can be obtained. A 10-ampere lamp will require about 7 ohms in the rheostat, and 2 or 3 ohms of this should be adjustable.

SEARCHLIGHTS

60. A searchlight is designed to concentrate the rays emitted from the crater of the positive carbon and project them so that they will be parallel to each other. A beam of light that does not spread out will illuminate objects at great

distances, because the intensity of such a beam does not fall off with the square of the distance as does the light from an ordinary source. In fact, if all the rays were exactly parallel and the mirrors perfect and if there were no absorption of light by the atmosphere, the intensity of the beam would not diminish at all. As a matter of fact, it does diminish to an extent that depends very largely on the condition of the atmosphere.

61. Searchlight Lamp.—Fig. 37 shows a type of lamp used both for commercial and naval searchlights. In this lamp the carbons are horizontal, the positive carbon being larger than the negative and pointing directly at the mirror. The lamp has a ratchet feed and is provided with two magnets—a series magnet that serves to strike or start the arc and a shunt magnet that works the ratchet feed.

Referring to Fig. 37, the shunt magnet is shown at *G* and the series magnet at *K*. *P* is the positive carbon and *N* the negative. *M* is a small switch for cutting off the current from the shunt coil when it is desired to feed the lamp by hand. The lamp may be fed by hand by slipping on a crank-wrench at *R*. Screw *D* feeds the negative carbon and *E* the positive, the two screws being geared together at *J*. Current is led into the lamp by means of two sliding contacts *A*, one of which is shown in the figure, the other being directly behind *A* on the other side of the lamp. *H* is the armature of the shunt magnet and *F* the pawl-and-ratchet mechanism by which screw *E* is turned. The lamp for a 30-inch projector takes from 75 to 90 amperes, and for an 18-inch projector from 25 to 35 amperes. The working current varies with the size of the lamp and also with the size of the carbons used. The voltage required at the lamp is usually from 45 to 49 volts and the feed will frequently operate when a pressure of 50 volts is reached.

62. The method of operating the lamp is as follows: The carbons are adjusted by the crank-wrench to a separating distance of about $\frac{1}{2}$ inch. The switch *M* is then closed. The main switch is closed next, and as no current can pass

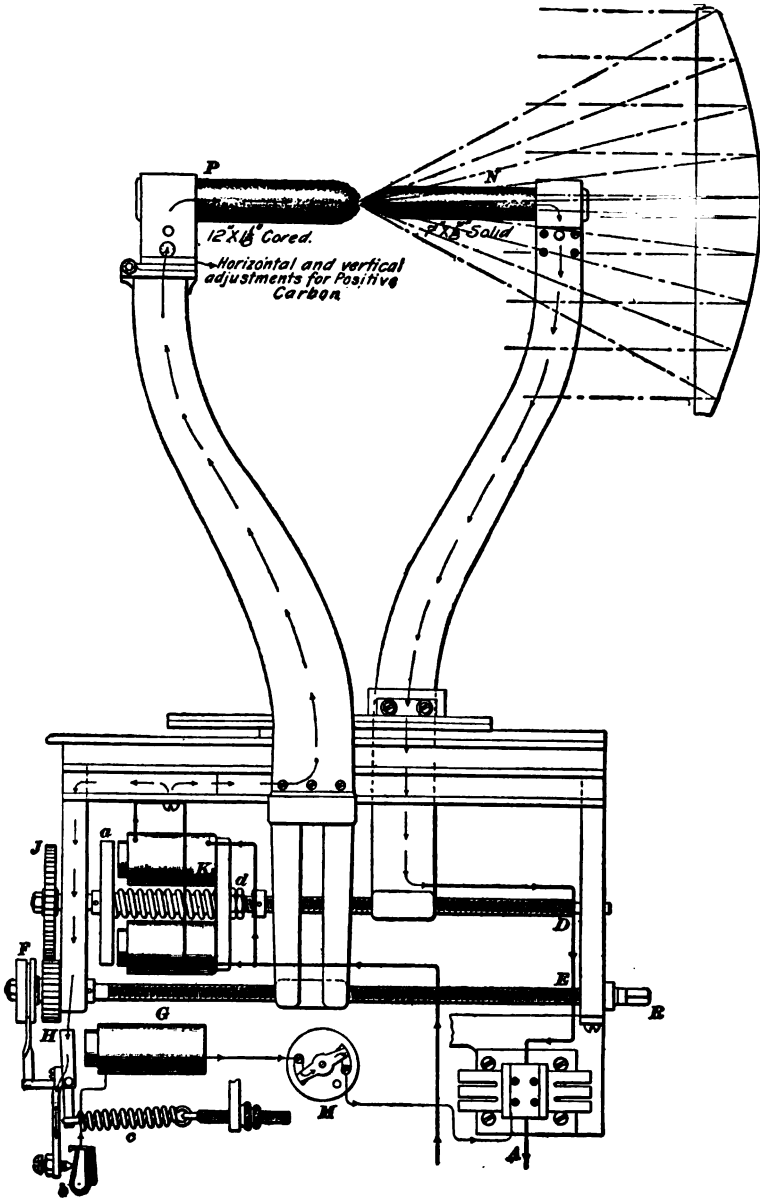

46B-18

between the carbons, the voltage between them, and hence the voltage across the shunt magnet G , must be equal to the full-line voltage; armature H is therefore attracted and the current through the shunt circuit is broken by the contact device b and the armature falls back again making contact. The armature H , therefore, vibrates rapidly and works a pawl that shoves the ratchet F around and feeds the carbons together. The screws are geared together, so that screw D revolves one-half as fast as E . As soon as the ratchet feed brings the carbons into contact, a heavy current flows for a short interval and the series coils K pull back the armature a and thus start the arc. As the carbons burn away, the voltage across G increases until the ratchet feed operates and moves the carbons a little nearer together. The point of feeding can be adjusted by means of the spring c and the length of the arc by means of nuts d . The positive carbon holder is provided with vertical and horizontal adjustments, so that it can be accurately lined up.

CARE AND ADJUSTMENT OF ARC LAMPS

63. General Remarks.—If an arc lamp is kept clean, and if the current and voltage at which it is operated are maintained at the values for which it is designed, it will give little trouble. This assumes, of course, that the lamp is substantially made. The older styles of open-arc, series lamps were usually heavily built and, as a rule, gave good service.

64. Trimming.—Most open-arc, series lamps are provided with a carbon rod on which the clutch operates. If this rod is dirty or greasy, the clutch will not work properly and the lamp will give poor service. When trimming the lamp, the rods should never be pushed up when they are in a dirty condition.

Dirt on the rod is apt to cause pitting, due to the burning action of the current where it passes into the rod from the contact spring or bushing. If the rods are at all dirty, they should be rubbed down with a piece of worn crocus cloth. When trimming the lamp, care should be taken to see that

the carbons are of the proper length. Lack of care in this particular is often responsible for burned carbon rods and carbon holders. The carbons should be placed so that they are vertically in line with each other, and the upper carbon must have enough vertical play to allow the lamp to pick up its arc.

65. Adjustments.—The principal points to look out for in adjusting an arc lamp are to see that the arc burns at the proper length and that the carbon is fed down smoothly without any hissing or flickering. For an ordinary 1,200 nominal candlepower, open-arc lamp, the arc should be about $\frac{3}{4}$ inch in length; for a 2,000-candlepower, from $\frac{1}{4}$ inch to $\frac{3}{4}$ inch. The exact length will depend somewhat on the quality of the carbons. If the arc is too short, it is liable to hiss, or if the current is too large, hissing is apt to result. An arc that is too long will flame badly and the lamp will take more voltage than it should. Poor quality of carbons will also cause flaming or hissing. The length of arc and the feeding point can be regulated by proper adjustment of the clutch. Directions for adjusting each particular make of lamp are furnished by the makers, but as a rule such adjustments are easily learned by an inspection of the lamp itself. In some cases the clutch and rod may become so worn that they must be replaced before a satisfactory operation can be obtained.

A good method to follow in adjusting lamps is to connect an ammeter in series and a voltmeter across the terminals of the lamp. First see that the dynamo is maintaining the proper current in the circuit. If it is not doing so, the regulator should be adjusted until it does. The lamp should be hung in some place where it will not be exposed to drafts of air, because such drafts may cause the arc to hiss or flame even if it is properly adjusted. A rack should be provided for supporting the lamps at such a height that the mechanism may be easily inspected. By watching the fluctuations of the voltmeter as the lamp burns, a good idea may be formed as to the smoothness with which the lamp feeds.

A recording voltmeter is very convenient for this work, as the lamp may be left to itself for some time, and the voltmeter will draw a chart indicating the variations in voltage during the test.

66. Burned-Out Coils.—The controlling coils of series arc lamps are frequently burned out and have to be rewound. Burn-outs may arise from a number of different causes. Lightning is frequently responsible for them, as it breaks down the insulation of the lamp or punctures the insulation between the layers of the winding. One of the most frequent causes of burned-out shunt spools is a defective cut-out. If the carbons stick and the cut-out fails to work, the arc grows so long that the current in the shunt coils becomes excessive, and they are sure to be burned out. The cut-out contacts should be kept in good condition, and if burned or oxidized, they should be carefully cleaned. Neglect to look after the cut-out part of the lamp will surely result in the rewinding of shunt spools, and as these are wound with fine wire they are a comparatively expensive part to repair. In some lamps, the action of the cut-out depends on the movement of the rocker; hence, it is important to see that the frame moves freely. If the lamp is improperly adjusted so that it burns with an abnormally long arc, the current through the shunt will be greater than it should be. This will cause the coils to overheat, and while it may not result in a burn-out at once, it is very apt to lead to it in time by causing deterioration of the insulation and consequent short-circuiting between layers. A similar result may be caused by the line current being above the normal, and in this case the series coils would also be affected. Generally, however, the series coils will stand a reasonable overload without greatly overheating. Series lamps should cut out promptly, if the upper carbon is pushed up while they are burning. If they do not do so, there is something wrong with the cut-out and the trouble should be remedied before the lamp is sent out.

67. Most of the above also holds true with regard to series enclosed arcs. There is even more danger of the

carbon sticking and failing to feed properly in these lamps than in the open arcs, because the carbon must pass through the cap of the enclosing globe, and if the carbon has not been gauged beforehand, a slight unevenness may cause it to stick. It is therefore important to see that the cut-out is kept in good condition and that there are no uneven places on the carbons when they are put in the lamp.

68. Trimming Enclosed-Arc Lamps.—Generally speaking, it is necessary to clean the enclosing globe every time the lamp is trimmed. If it is allowed to go longer without cleaning, it becomes covered with such a thick deposit that a considerable part of the light is cut off. This cleaning can be done to much better advantage at the station than at the point where the lamp is installed, so that the lower globes are brought back to the station for retrimming and are there washed by means of special appliances for the purpose. When the trimmer goes out, he takes a clean lot of globes, provided with lower carbons, and replaces the old ones. Care should be taken to see that the carbons used are of the proper length because a small length of carbon in an enclosed-arc lamp corresponds to several hours' burning. The upper carbons are purchased in the desired length, but the lower carbons are very often made up of the part left over from the top carbon. These pieces will vary in length, and they should be cut to gauge before being placed in the bottom holders. The upper carbons should all be gauged to make sure that they will pass through the cap freely. For a $\frac{1}{4}$ -inch carbon, the maximum allowable diameter is about .52 inch and the minimum diameter .5 inch. If the carbon is smaller than the allowable amount, there will be too much air admitted to the enclosing globe and the arc will flame badly. Only the best quality of carbons should be used in enclosed-arc lamps, otherwise the enclosing globe will become thickly covered with deposit. Attention should be paid to the gas caps of enclosed-arc lamps and also to the joint between the globe and the bottom carbon holder.

69. Since most enclosed-arc lamps have a carbon feed, it is necessary to see that the carbons are smooth, because rough spots will interfere with the operation of the clutch. If necessary, rough spots should be smoothed down with sandpaper. Constant-potential lamps have no cut-out to give trouble, but they have a resistance coil that fully counterbalances the cut-out in this respect. If the carbons stick and fail to feed, the lamp goes out; but if the lamp does not pick up properly, the carbons being in contact, the resistance offered by the arc will be absent and a current much larger than the normal will flow. If the fusible cut-out in series with the lamp does not operate, the resistance will be very liable to overheat and burn out. There is also danger of the insulation on the series controlling magnet being damaged. It is a common occurrence to find constant-potential lamps that have been designed and adjusted for 104 to 110 volts running on circuits where the voltage is as high as 125 or 130. Of course, under these circumstances the lamp takes a current larger than it should, and it must not be forgotten that the heating effect in the resistance coil and other parts of the lamp increases as the square of the current. A comparatively slight increase in the current will, therefore, result in quite a large increase in the heat developed. An abnormal current is also liable to melt the enclosing globe. Of course, many of the burn-outs on these lamps may be traced to faulty design or construction, but at the same time it is quite true that many good lamps give trouble either because the voltage is too high or because the lamp has not been properly adjusted to suit the voltage on which it is to operate.

ARC LIGHTING

(PART 2)

LINE WORK FOR ARC LIGHTING

SERIES SYSTEMS

1. Size of Wire.—Since most outside lighting work is done on the series system, and the current is usually not greater than 9.6 amperes with open arcs or 6.8 amperes with enclosed arcs, the line wire does not need to be large. Generally, such lines are of No. 6 B. & S. double- or triple-braided weather-proof wire. Triple-braid wire of this size weighs about 585 pounds per mile; double-braid about 510 pounds. Its resistance per mile is approximately 2.08 to 2.12 ohms. Sometimes No. 8 wire is used for arc lines, but while it is large enough to carry the current, it does not make as substantial a job as the No. 6. The difference in first cost between the two sizes is not great and, as a general rule, it will pay to put up the larger wire, especially in localities where sleet storms are common.

Since the current is small, series arc lines may be run long distances without giving an excessive loss. For example, with 9.6 amperes, the drop per mile of wire is about $2.08 \times 9.6 = 19.97$ volts, and with smaller current it is correspondingly less. Series arc circuits often extend for miles, but the extension of the line simply cuts down the pressure available for the lamps, so that a given dynamo is not capable of operating quite as many lamps on a long circuit as on a short one.

For notice of copyright, see page immediately following the title page

2. Laying Out Arc Circuits.—Generally, there is not a great deal of choice as to the laying out of an arc circuit for street lighting, as it is determined almost altogether by the location of the lamps. At the same time, wire and labor can often be saved by laying out a plan of the streets to be lighted and then arranging the circuits so that the line will pass through one lamp after another with as little doubling back on itself as possible.

When laying out the line, it is a good plan, where possible, to connect the terminals of a loop in the circuit to a switch so that, in case of trouble, the loop can be short-circuited and the remaining lamps on the circuit continued in operation. Fig. 1 illustrates this; l, l, l represent arc lamps connected on

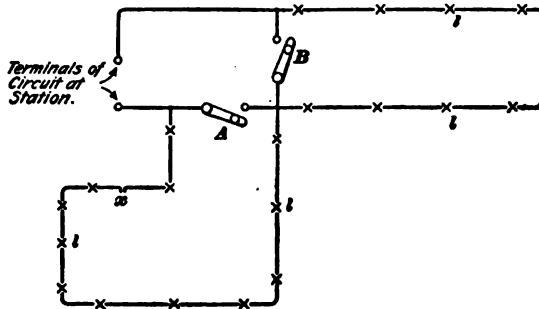

FIG. 1

a street circuit, as shown. By putting in switches at points A, B , the loops in the circuit may be cut out. For example, if a break occurs at x , switch A can be closed and the rest of the lamps kept going while the break is being located. A few switches arranged in this way are also of great assistance in locating breaks. In Fig. 1, plain short-circuiting switches are indicated in order to bring out the method and to simplify the figure. In practice, a switch should be used that will provide a path around the loop and at the same time disconnect the loop entirely from the remainder of the circuit, so that it may be worked on and the fault located without danger to the linemen. These cut-out switches are usually mounted on a pole or at any other point where they will be accessible.

3. It is preferable to have separate lines for operating the commercial lights and street lights, because lamps used in places of business usually have to be started earlier and extinguished earlier than those used on the streets; moreover, it may be necessary to run store lights for a short period in the morning, when no street lights are needed. Besides, the long-exposed street circuits are always subject to breaks or other troubles that may interfere with the regularity of the service.

No matter how carefully street arc-light circuits are laid out in the first place with a view to economizing copper, they soon become very irregular if the number of lights is increased. Lights are looped in here and there, and the result is that the general layout of the circuits assumes an appearance very different from what was originally intended.

LINE CONSTRUCTION

4. **Line construction** for arc lighting is generally carried out by stringing the lines on poles, though in some cities the distribution is effected by means of well-insulated, lead-covered cables placed underground. In all construction work connected with series arc circuits, the point must not be lost sight of that the pressure across the terminals of these circuits is very high and that there is always a strong tendency for grounds to develop. A large size of deep-groove, double-petticoat insulator should be used and the wires kept clear of trees. Great care should be taken when wires are run near metal awnings at the entrance to stores, as this is a place where grounds are apt to occur and where, in a number of cases, they have resulted in fatal accidents. The necessity for high insulation and careful work in connection with arc lines is even greater than it was when about fifty lights on a circuit was a common average; now the number of lights per circuit is often over one hundred, and if the lines are not kept in good condition there is sure to be trouble. All fittings used about the lamps themselves should be such as to give high insulation.

5. Height of Lamps.—Arc lamps for street lighting are nearly always placed at street intersections. When the blocks are long, they are also placed in the middle of the block. The older method was to use a comparatively small number of lamps hung high above the street, but it is now considered better practice to hang the lamps lower and to use more of them if necessary. This is especially the case when the streets are shaded by trees. Where the space to be illuminated is open, the lamps may be hung fairly high, say, 30 to 40 feet above the ground; but when the streets are at all shaded, a height of 20 to 25 feet is to be preferred.

6. Methods of Hanging Lamps.—There are, in general, three methods of hanging lamps: (*a*) By mounting on pole tops; (*b*) by suspending from mast arms or pole fixtures projecting from a side pole; (*c*) by suspending from the middle of a span wire so that they will hang over the center of the street.

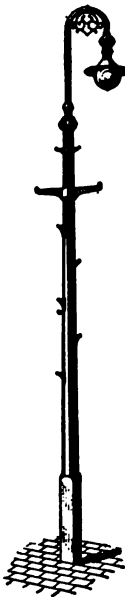

FIG. 2

When the lamps are mounted on pole tops, they are fixed permanently, no provision being made for lowering them when they are trimmed. The pole must, therefore, be provided with pole steps, so that the trimmer can climb up to the lamp. This method of mounting makes the work of trimming hard, and it is therefore not used nearly so much as other methods, which allow the lamp to be lowered. The pole-top mounting has a few advantages, among which is the absence of rope and pulleys, also the line wires when once connected up are not moved, as they are every time a lamp is raised or lowered. The raising and lowering of lamps is a frequent source of breaks in the line wire due to the slight bending and unbending that the wire is subjected to. These advantages are, however, more than offset by the difficulty of trimming if the lamps are mounted high above the street. Fig. 2 shows an ornamental style of pole-top mounting. In this case, the lamp

is only about 20 feet above the street, and as it is used with enclosed arcs, which are trimmed about once in a week or ten days, the climbing up to the lamp is not as much of an objection as with the old-style open arcs that required daily trimming.

7. Fig. 3 illustrates a typical **mast-arm suspension**. The lamp is raised and lowered by means of a rope and pulleys, and is provided with a small hood to protect the top from the weather. The lamp is suspended from the rope by the intervening cross-arm *a* and insulator *b*. A cross-arm and insulator of this kind should be provided in

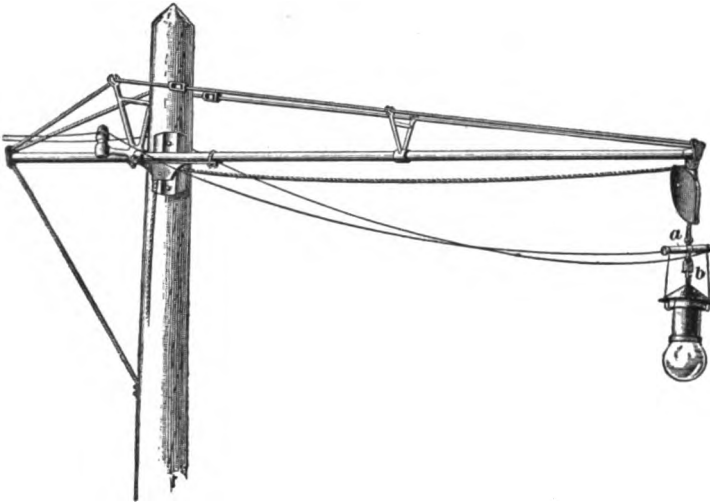

FIG. 3

order to secure good insulation between the lamp and the pole fixture and also to keep the line wires spread apart.

Since the introduction of high-voltage enclosed arcs and the operation of a large number of lamps per circuit, it is essential that each lamp be provided with a suspension that will give high insulation. The old-style, plain, wooden crosspiece with a porcelain knob at each end is not sufficient. Fig. 4 shows a Cutter pole fixture of small size used considerably for street lighting with enclosed arcs. It supports the lamp about 3 feet from the pole.

8. The **span-wire suspension** is illustrated in Fig. 5. It is the best form to use when it is desired to bring the lamp over the center of the street. A pulley is placed at the center and another on the side pole and the poles are

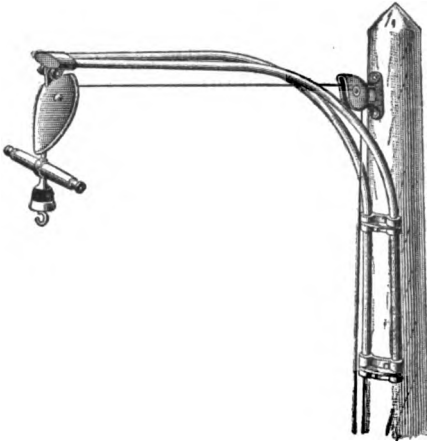

FIG. 4

usually set at diagonally opposite corners of the street intersection. The span or suspension wire is usually of $\frac{1}{8}$ -inch or $\frac{3}{8}$ -inch galvanized steel and the side poles about 30 to 35 feet high with a 6-inch top. This method of suspension, of course, involves the use of two poles and for this reason the mast-arm suspension is often preferred. The chances are that for lighting a given town or

city a combination of the three methods may be desirable, the style of suspension being chosen that is best adapted for the particular location of the light.

9. **Arc-Lamp Pulleys.**—Pulleys used for suspending arc lamps have received a great deal of attention from those especially interested in arc-lamp specialties. The ordinary style of pulley is not well adapted for this kind of work. An **arc-lamp pulley** should always be provided with a hood to prevent its being clogged by sleet. It is also desirable that the pulley from which the lamp is hung be of such a design that it will hold the lamp from dropping in case the rope breaks or becomes unfastened in any way. In Fig. 5, a lamp-supporting pulley is indicated at *A* and a swivel-pole pulley at *B*. Both are of the sleet-proof kind. A number of different lamp-supporting pulleys are now manufactured. In most of them either a catch or projections are arranged inside the pulley casing to hold the lamp when it is raised and

relieve the rope of all strain. When the lamp is to be lowered, it is first pulled up a little. This unlocks the pulley and allows the lamp to be lowered. The use of self-locking pulleys also helps to make the operation of trimming more rapid.

10. Rope.—The rope used for raising and lowering the lamps is an important item on a large system and should be carefully selected. Practice varies greatly as to the kind of rope used. Formerly, manila rope was used almost exclusively, but the tendency is now toward a solid braided cotton rope or a flexible wire rope. When cotton is used for this purpose, it is provided with a wax finish that keeps the rain from soaking into and rotting it. The rope is usually $\frac{3}{8}$ inch in diameter, though $\frac{1}{2}$ -inch is sometimes used with heavy

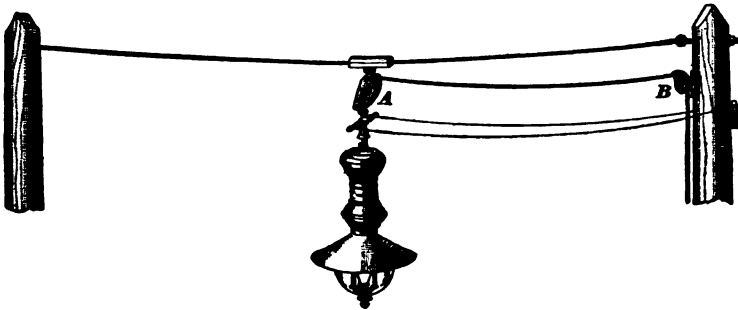

FIG. 5

lamps. If wire rope is used, it is usually the so-called tinned *sash cord*, which is a rope made up of a hemp center surrounded by tinned steel wire. It was formerly the practice to coil up enough surplus rope on the pole at each lamp to allow the lamp to be lowered to the ground. It is now customary to end the rope in such a way that another rope may be hooked on to it and the lamp lowered. This extra rope, known as a **trimmer's rope**, is from 20 to 30 feet long and is provided with a snap hook at one end and a number of rings near the other, the latter being spaced so as to suit the varying heights at which the lamps may be hung. The end of the rope on the pole may be fastened by means of special pole padlocks, made for the purpose.

11. Cut-Out Switches.—The rules of the Fire Underwriters require that wherever constant-current arc wires enter a building, an approved double-contact service switch shall be installed, so that the current can be cut off at any time. These switches must be substantially made, must be mounted on incombustible bases, and must be placed where they may be easily reached by policemen and firemen. They must have good contacts, be quick in action, and show clearly whether the current is on or off.

Fig. 6 shows the Wood arc cut-out, a style that has been extensively used and which will serve to illustrate the opera-

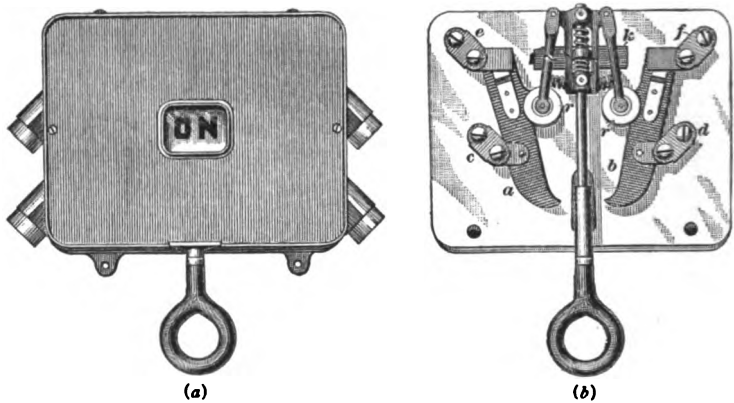

FIG. 6

tion of cut-out switches in general. The parts here shown are mounted in a waterproof cast-iron box with an opening past which an indicator moves to show when the current is on or off.

Two blades *a*, *b*, Fig. 6 (*b*), are attached to the line terminals *c*, *d*, as shown. The house terminals are connected to the posts *e*, *f*. When the handle is pushed up, the porcelain rollers *r*, *r* press the blades into the clips on terminals *e*, *f* and thus connect the line with the lamps. When the lever is pulled down, the rollers bear on the lower part of the blades, causing them to leave the clips on the posts *e*, *f* and swing over so as to rest on the casting *k*, thus cutting out the lamps and allowing the current to flow directly across

from one blade to the other and disconnecting the house wires entirely from the line. The springs shown in the figure make the action quick and positive.

12. Cut-Outs on Arc Lamps.—Nearly all arc lamps are provided with a simple short-circuiting switch by means of which the lamp can be cut out. This switch does not, however, disconnect the lamp entirely from the circuit, and it is always dangerous to work on a lamp under such circumstances when standing on the ground, because there is liable to be a ground, on some part of the line, that provides a path for the current through the person working on the lamp. Since the introduction of constant-current circuits operating a large number of lights, the danger from shock has materially increased, and lamps are now frequently equipped

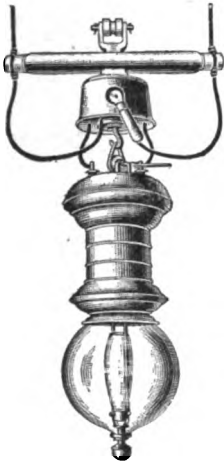

FIG. 7

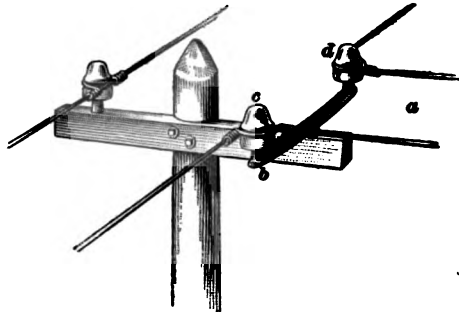

FIG. 8

with absolute cut-out switches that are separate from the lamp and that will cut out the lamp and disconnect it entirely from the circuit. Fig. 7 shows a series arc lamp equipped with a separate cut-out switch of this kind.

13. Looping in Lamps on Series Circuits.—When a lamp is looped in on a series circuit out of doors, it is not necessary to provide a cut-out switch at the point where it is cut into the line, though switches are sometimes placed at the lamp itself. Fig. 8 shows one method of looping in on a series circuit. An arm *b*, provided with insulators *c*, *d*, is

mounted as shown. The loop *a* runs to the lamp or, in case the circuit is carried into a building, runs to the cut-out.

When a circuit is to be looped in between poles, the break

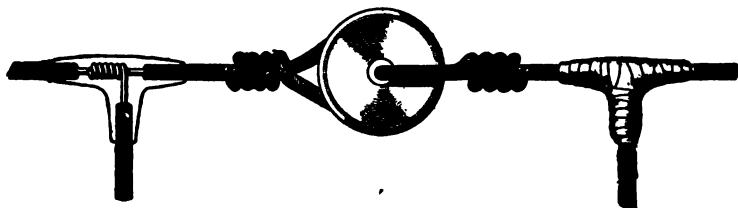

FIG. 9

may be made by using a single porcelain insulator, as shown in Fig. 9, or if higher insulation is required between the terminals of the break, two insulators connected by a short

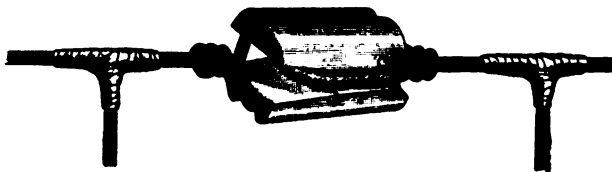

FIG. 10

length of wire may be used. Fig. 10 shows another method of accomplishing the same result by using a special porcelain insulator.

TESTING ARC-LIGHT LINES

14. Since street arc-lighting circuits are generally long, considerably exposed, and of comparatively small wire, they always give more or less trouble on account of grounds, breaks, and crosses. *Breaks* are of quite frequent occurrence, especially during heavy wind or sleet storms, and very often cannot be detected by a mere inspection of the line. The wire may be broken though the insulation holds the ends together, so that, to all appearances, the line is intact. Breaks are especially liable to occur at the point where the line loops from the pole to the lamps.

Grounds are most likely to occur around the fronts of stores where the wires are run in proximity to iron awnings

or fittings. Also, where the lines run through trees, there will always be more or less of a ground, especially in wet weather. In this case, however, the trouble would be more correctly termed a *leak*, as it is due to defective insulation and does not constitute a direct connection to ground, as would happen, for example, if one of the lines came into contact with an iron pole or a gas or water pipe.

Crosses are caused by one line coming into contact with another, and, under ordinary conditions, should not occur frequently if the line is well constructed. Of course, heavy storms, especially sleet storms, may cause a great deal of trouble on arc lines, but we are now speaking of the troubles that are liable to occur under ordinary working conditions.

All arc lines should be tested at intervals during the day to see if any faults have developed, so that they can be looked up and remedied, if possible, before it comes time to start up in the evening. This may be done in various ways, but in many cases grounds and breaks are located by the use of an ordinary magneto-bell. This bell requires no battery for its operation and is able to ring through a long length of line; moreover, it is easily carried around from place to place.

15. Locating Breaks.—Series arc circuits should be frequently tested for breaks by connecting a magneto to the terminals of the circuit, at the station, and ringing it up. If the bell fails to ring, it shows that the circuit is broken somewhere and the break should be looked up at once. If the circuit is arranged in loops that can be cut out by means of switches on the poles, the first thing to be done is to cut out the loops in succession until a ring is obtained. This will show in which loop the break is, and the fault can then be further located, as described later; or, in many cases, it may be found by a simple inspection. In general, however, the problem will be to locate a break on a simple series circuit, such as that shown in Fig. 11. The irregular outline represents a circuit, or portion of a circuit, of which a, b are the terminals; l, l , etc. represent the lamps. It is found by ringing up between a, b that there is a break on

the circuit indicated at the point x , though its location is not known as yet. First connect a and b together and ground them, as shown by the dotted lines. Then go to point c , as near the middle of the circuit as possible, and open the circuit by lowering a lamp and removing the wires, or in any other way that may be convenient. Attach one terminal of the testing magneto to ground, by connecting it with a hydrant or other ground connection that may be at hand, and the other terminal to one end of the circuit d ; ring up, and if the bell rings, it shows that the portion of the circuit from d around to the station is all right and that the break is in the other half. Close the circuit at c and move on to a

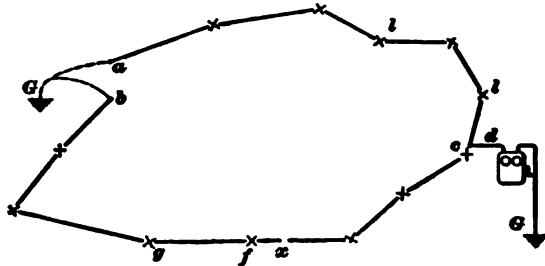

FIG. 11

place f , about half way between c and the station. The circuit is here opened and the magneto-bell connected as before. If a ring is obtained when the bell is connected to the left-hand end of the line, it shows that the stretch of circuit $f-g-b$ is intact; while, if the bell does not ring when connected to the right-hand side, it shows that the break is between f and c , because the previous test showed that the part $d-l-l-a$ was all right. In this way, by making a few tests, the stretch of circuit in which the break occurs can be located within narrow limits, and the break itself can then usually be found by a careful inspection.

16. Locating Grounds.—When a line becomes grounded at any point x , as indicated in Fig. 12, the ground may be located by using a magneto, in which case the ends of the line a, b at the station are left open, instead of being

grounded, as when testing for breaks. The line is then opened about the middle point *c* and each side rung up, one terminal of the magneto being connected to the ground. The side on which a ring is obtained is the one

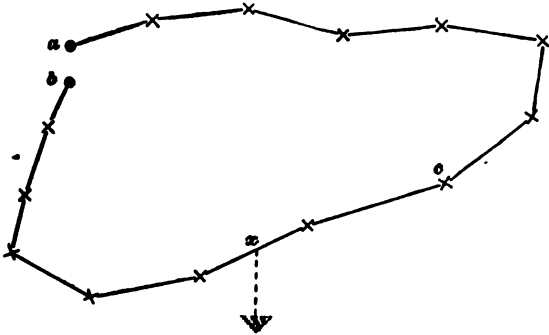

FIG. 12

on which the ground exists. The half on which the ground is located is then opened at its middle point, and in this way the part of the line that is grounded is soon located within narrow limits.

17. Locating Grounds by Means of Voltmeter.—If a high-reading voltmeter is available, it can be used for locating grounds on an arc circuit, as indicated in Fig. 13.

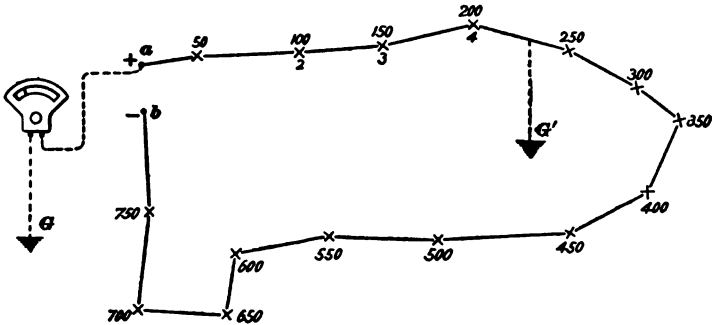

FIG. 13

The dynamo is here omitted, but it is supposed to be operating the circuit connected to its terminals *a*, *b*.

In this case, there are, say, fifteen lamps operated on the

circuit. The total pressure generated by the dynamo is, say, $15 \times 50 = 750$ volts, allowing 50 volts per lamp. The difference of potential between the negative side of lamp 1 and $a+$ is 50 volts, between the negative side of 2 and $a+$, 100 volts, and so on, as shown in the figure. If one terminal of the voltmeter is connected to $a+$ and the other to ground, a reading will be obtained whenever there is a ground on the line. Suppose, for example, that there is a ground at G' ; the voltmeter will then be connected across four lamps and will give a reading of about 200 volts. The voltmeter reading, therefore, indicates how far the ground is out on the line. If, for example, a reading of about 100 volts is obtained, it is known that the ground is somewhere between the second and third lamps.

18. Differential Method of Locating Grounds.

This method consists in balancing the drop through an artificial line against the drop through the portion of the circuit from the station to the point where the ground exists; it will be understood by referring to Fig. 14.

The terminals of the circuit are indicated at a, b , and, for the sake of illustration, ten lamps are shown. The total pressure generated by the dynamo will be about 500 volts, and the drop in pressure between $a+$ and different points on the circuit will increase as the lamps are passed, as shown by the numbers 50, 100, etc. The testing apparatus consists of a number of equal resistances 1, 2, 3, 4, etc. connected in series, with terminals brought out to a switch, as indicated. These resistances should be fairly high, say about 50 ohms each. Ordinary 52-volt incandescent lamps will answer. A detector galvanometer C is connected to the switch blade and to the ground. One end x of the resistance is connected to $a+$. The other end of the circuit $-b$ is connected at the point z , so that the number of resistances will correspond to the number of lamps on the circuit to be tested. The switch arm is then moved to the right until the galvanometer deflection comes to zero. In this case, the deflection will be zero when the arm is at the

point y between resistances 6 and 7. The fall of pressure from $a+$ through the artificial circuit corresponds to the fall in pressure from $a+$ around the arc circuit; hence, when a point is reached where the drop in pressure from $a+$ around to the ground is equal to the drop in the artificial

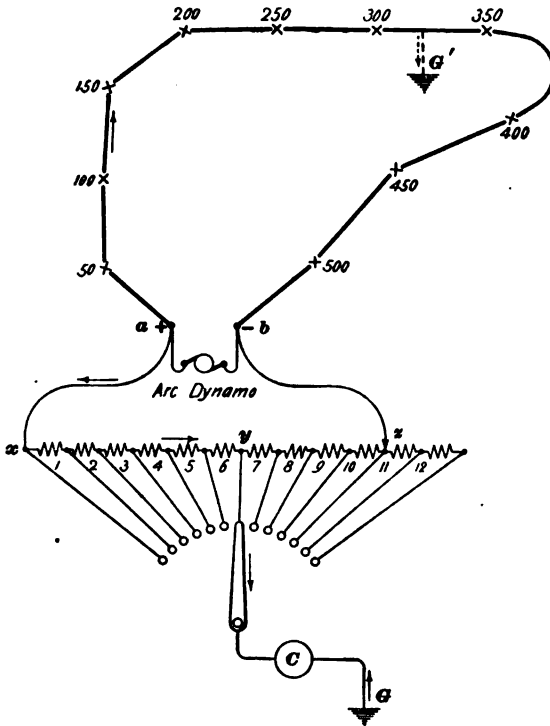

FIG. 14

line, the two pressures counterbalance each other, as indicated by the arrows, and no current flows through the galvanometer. As soon as the point corresponding to that where the ground exists is passed on the switch, the galvanometer will reverse its deflection.

LIGHTNING PROTECTION FOR ARC CIRCUITS

19. Series arc-light circuits are very likely to bring in lightning discharges to a station, because they cover such large areas and are usually much exposed. They should, therefore, be well protected by lightning arresters. The arresters used on arc circuits differ little, if any, from those used on other circuits. Care must, of course, be taken in

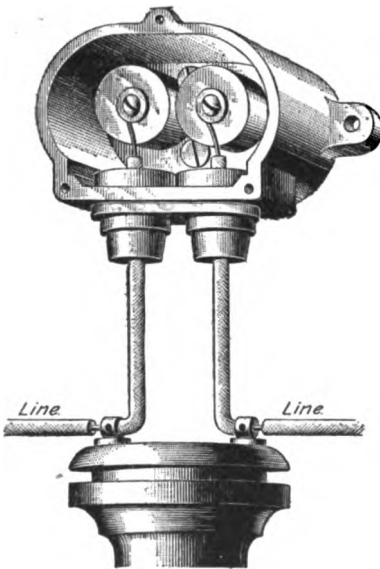

FIG. 15

selecting an arrester to see that it is adapted to the voltage of the circuit and also to the kind of current; i. e., direct or alternating. Many of the older types, which were quite satisfactory on circuits operating as high as 60 to 75 lamps, are not suitable for high-voltage circuits operating 125 to 150 lamps. If the older types of arrester are to be operated on such circuits, two of them should be connected in series. Each side of every arc-light circuit should be equipped with an arrester at or near the point where the wires enter the station. The

arresters may be mounted back of the arc-light switchboard or on a special rack placed near the point where the wires enter the building.

20. **Lightning Arrester for Arc Lamps.**—Although lightning may not get into the station, it sometimes punctures the insulation of the lamps out on the line and is responsible for many burned-out coils. In order to prevent this, small arresters, or spark gaps, may be connected across the terminals of the lamp. Fig. 15 shows a simple arrester

for this purpose. It consists of two brass cylinders with a small gap between them, and when a discharge comes along the line, it jumps between the cylinders and thus passes along to the regular lightning arresters, which carry it to ground. The lightning will jump the gap in preference to passing through the lamp because of the reactance of the regulating coils in the lamp.

ARC-LIGHT DYNAMOS

DIRECT-CURRENT MACHINES

MACHINES FOR CONSTANT-CURRENT DISTRIBUTION

21. In the early days of arc lighting, the lamps were nearly always operated in series by direct current supplied from constant-current dynamos designed specially for this class of work. In later years, the use of constant-potential lamps has become so great that constant-current, arc-light dynamos do not occupy nearly so prominent a place in lighting stations as they did. Constant alternating-current generators are now seldom installed; if constant alternating current is required for the operation of series lamps, it is obtained from regular constant-potential alternators by the use of constant-current transformers or automatic reactance coils, in the same way as in series incandescent lighting.

Constant direct-current arc machines are always series-wound and may have armatures of the open-circuit or closed-circuit type. These machines generate a small current at high voltage; hence, a shunt winding for the field is out of the question because of the exceedingly large amount of fine wire that would be required for it.

22. Constant-current, arc-light dynamos are, in many respects, a decided contrast to the constant-potential, direct-current machines used for low-pressure lighting or street-railway work. In the first place, arc machines must generate

a comparatively small current (from 6 to 10 amperes), but the maximum pressure that they are called on to deliver at full load is very high. Moreover, they must be constructed so as to keep the current at the required amount through a wide range in the number of lamps operated. Constant-potential dynamos do just the opposite. They maintain the pressure (usually from 110 to 600 volts) at a constant or nearly constant value and the current varies with the load. A constant-potential machine can be made self-regulating by providing it with a compound field winding. In order, however, to make a direct-current machine regulate for constant current, it is necessary to provide it with an electromechanical regulator of some kind that will adjust the voltage with changes in load, so as to keep the current constant.

23. For convenience, constant-current arc machines may be divided into two general classes: (*a*) those with open-coil armatures and (*b*) those with closed-coil armatures. Of machines with open-coil armatures, the most prominent examples are the Thomson-Houston (T. H.) and the Brush. Large numbers of these machines have been installed in the past and their principles of operation have already been described. The Thomson-Houston machine is not now regularly manufactured; neither is the old two-pole type of Brush machine. The Brush multipolar machine, which is illustrated later, may be taken as typical of the modern constant, direct-current, arc-light dynamo with open-circuit type of armature. Machines having closed-circuit armatures are represented by the Wood (Fort Wayne) and Western Electric makes. Both of these machines have armatures of the ring type. On constant direct-current machines, it is necessary to have an automatic regulator that will change the voltage with change in load so as to keep the current constant. In some cases, the regulation is accomplished by shifting the brushes; in others, the brushes are shifted and at the same time the ampere-turns on the field are varied, either by cutting some of the field turns in or out or by varying an adjustable resistance shunted across the field winding.

24. Brush Arc Dynamo.—The later style of Brush arc dynamo is shown in Fig. 16. These machines are much larger than the old bipolar type and have a higher efficiency. The armature *M* is of the ring, open-circuit type, and its general construction is the same as that of the older-style armature with a number of improvements in the mechanical

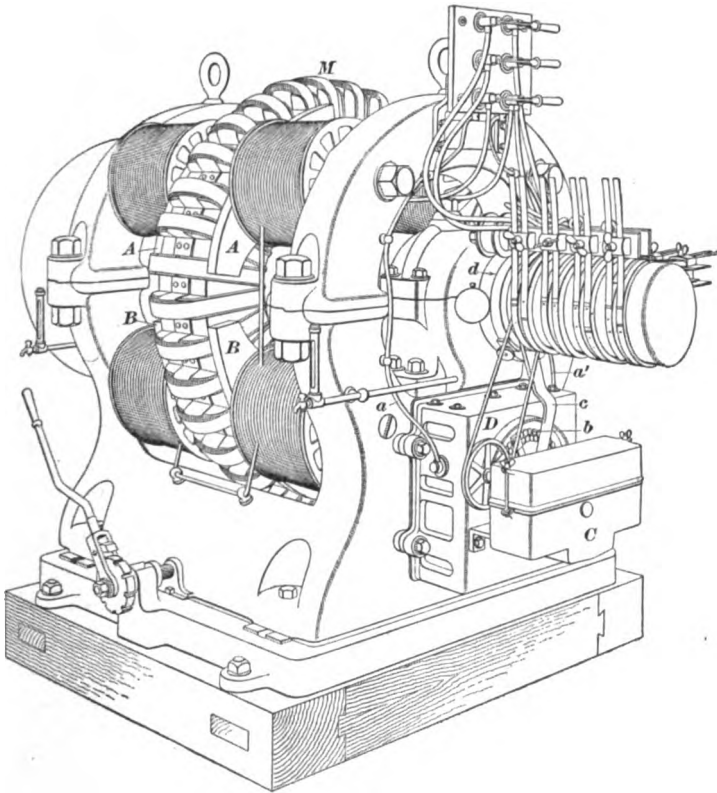

FIG. 16

details and method of insulation. The connections are also slightly different in order to adapt the armature to a four-pole field. Instead of connecting diametrically opposite coils in series, as in a two-pole machine, four coils situated one-quarter of a circumference from one another are connected

in series and the terminals brought out to the commutator segments.

The field is the same, in some respects, as that on the old machine, but there are four poles on each side of the armature instead of two. On each side, the poles are alternately north and south, but poles directly opposite each other are of the same polarity. For example, in Fig. 16, poles A, A are alike and of one polarity, while B, B are also alike but of polarity opposite to A, A .

The other chief point of difference between the new-style and old-style Brush machines lies in the regulator. The old regulator was entirely separate from the dynamo, but in the later machines the regulator is mounted on the dynamo. It varies the amount of the resistance shunted across the field, and also shifts the brushes around the commutator. The regulator, Fig. 16, is in the box C ; rheostat D is connected in shunt across the terminals of the field by means of the wires a, a' , and is divided into a number of steps, connections to which are made by an arm moving over the contacts b . This arm is shifted by the regulator and at the same time the brushes are tipped by means of the rocker-arm c attached to the brush-holder yoke d .

25. The Regulator.—Two types of regulator have been brought out for multipolar Brush machines. The first type used magnetic clutches to move the rheostat arm. The one now made is shown in Fig. 17. It is thrown into or out of action by an encased magnet m connected in series with the lamps. Magnet m does not move the rheostat arm a , but simply controls a valve that admits oil, under pressure, to either side of a vane or piston that swings around in the closed chamber b . The oil pressure necessary to operate the piston is maintained by means of a small rotary pump c driven by a belt from the dynamo shaft running on pulley d . The lower case is filled with oil to a point a little below the rheostat-arm shaft. Oil is drawn from the lower part of the box and discharged through the valve, which moves up and down in a small valve chamber. When the current is at its

normal value, the valve occupies a central position and the ports are arranged so that oil circulates through the valve chamber without moving the rotary piston or vane attached

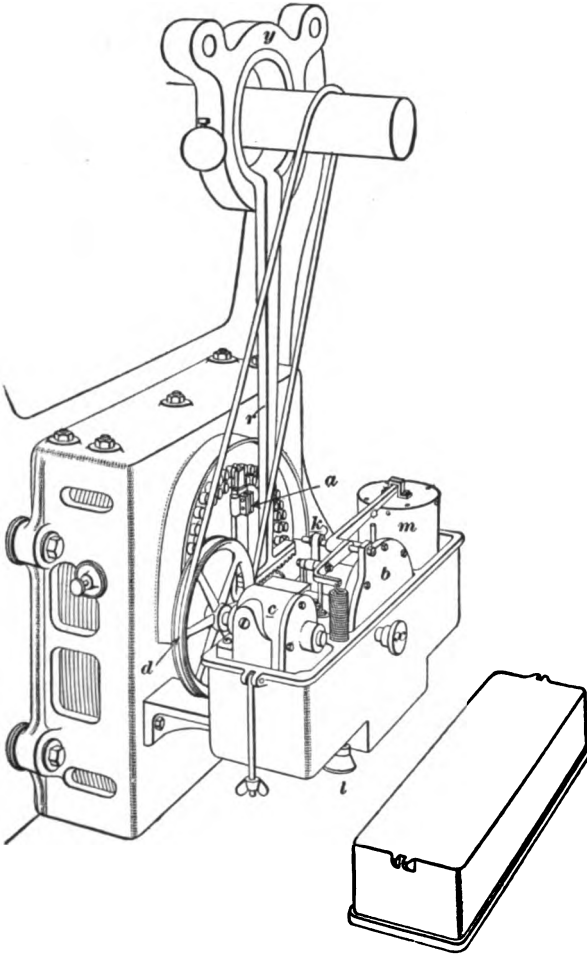

FIG. 17

to the rheostat arm. One end of the lever, pivoted at *k*, Fig. 17, is attached to the valve, and the other end to the armature of magnet *m*. If the current becomes weaker

than normal, m rises and the valve lowers, thus admitting oil to one side of the rotary piston in casing b . If the current becomes stronger than normal, the armature lowers, raises the valve, and turns the rheostat arm in the opposite direction.

26. In addition to moving the rheostat, the regulator tips the brushes by means of an arm extending from the rocker and carrying a toothed arc that engages with a small spur wheel on the shaft carrying the rheostat arm. By this movement the brushes are adjusted with the changes in load so as to keep the spark at the brushes about $\frac{3}{8}$ inch long on short circuit and $\frac{1}{2}$ inch long on full load. This controller will hold the current at its correct value with very little variation either way.

CLOSED-COIL MACHINES

27. The Wood arc dynamo, Fig. 18, has a simple, closed-coil ring armature and a commutator divided into a large number of segments so as to keep the voltage between segments low and prevent undue sparking. The controlling magnet m of the regulator is connected in series with the line and operates the lever n . The brushes are moved by means of a small, double friction clutch that is contained in the casing shown at a . When the lever is pulled up beyond the normal position, the clutch moves the brushes forwards by means of the gears b, e, d , thus lowering the current. If the current becomes too weak, the lever moves down and the clutch moves the brushes back, thus increasing the current. These dynamos operate on a single circuit and are made as large as 150-lights capacity.

28. The Western Electric machines also have closed-coil armatures; the larger sizes are of the four-pole type and have two pairs of brushes. They are provided with two regulators and supply two circuits in parallel; each of the regulators controls one pair of brushes. This is a somewhat different multiple-circuit arrangement from that of the Brush machine, in which the two loops or circuits are in series

and the current is bound to be the same in each. When the circuits are in parallel, each must have a regulator of its own, but under no circumstances can the pressure obtained

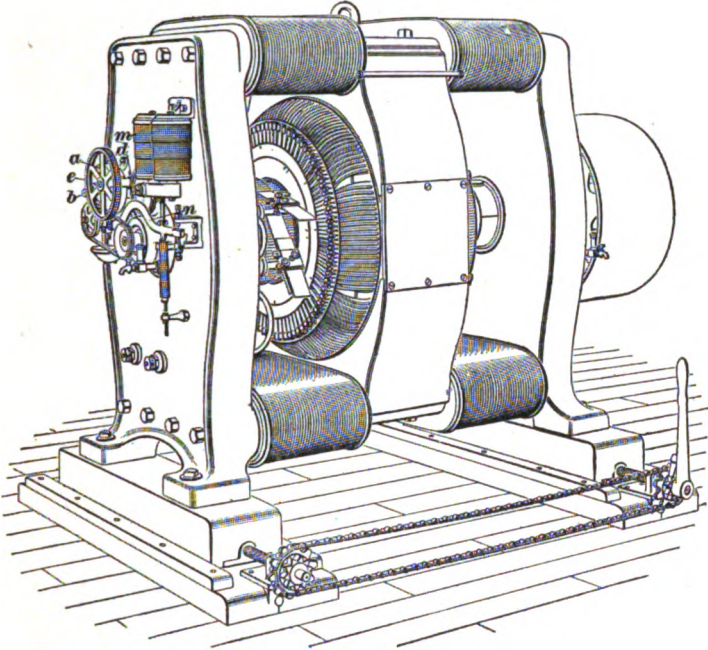

FIG. 18

exceed that which is ordinarily applied to one circuit; i. e., half the pressure that the machine would have to generate if all the lamps were connected in series.

REVERSAL OF POLARITY

29. Sometimes the polarity of arc machines becomes reversed. This is usually due either to lightning, wrong plugging at the switchboard, or the circuit from the machine coming into contact with some other circuit. When the polarity is reversed, the lamps operated by the machine will burn "upside down"; i. e., the lower, or short, carbons will be positive and will burn twice as fast as the upper.

If the current is allowed to flow in the wrong direction for any great length of time, the bottom carbon holders will be destroyed. It is important, therefore, to see that trouble of this kind is remedied as soon as possible. As far as the lamps are concerned, the trouble can be overcome by simply reversing the plug connections at the switchboard, but the polarity of the dynamo should be righted at the first opportunity. This may be done as follows: Connect the brushes together by a piece of wire so that the armatures will be short-circuited and hence will allow current to pass through the fields without running the machine as a motor. Then connect the positive pole of another machine to the negative pole of the machine to be fixed and allow the current to flow for a few moments. If another machine is not available, a number of cells of battery may be used. This will reverse the polarity and bring the machine back to its former condition. After this is done, the short-circuiting loop may be removed from the brushes. Do not attempt to reverse the polarity while the machine is running.

RUNNING ARC MACHINES IN SERIES

30. Sometimes conditions may arise where it is necessary to run two arc machines in series in order to supply the lamps on a given circuit, because the number of lights to be operated may exceed the capacity of any one of the available machines. The two machines are connected in series by connecting the positive terminal of one to the negative terminal of the other, in just the same way as cells are connected together when their E. M. F.'s are to be added. When arc machines are run in this way there is often trouble due to the current seesawing or hunting. The current, instead of remaining steady, surges up and down. This is caused by the unstable action of the regulators on the two machines; both try to do the regulating at once and the result is an unstable condition of affairs. Under such circumstances it is best to throw one regulator out of action and make the machine generate its full-load voltage

by blocking the regulator or setting the brushes at their position of maximum E. M. F. This machine will then generate a constant E. M. F., and whatever changes are necessary will be taken care of by the regulator on the other machine.

ALTERNATING-CURRENT, ARC-LIGHT DYNAMOS

31. Constant-Current Alternators.—The operation of arc lights in series from constant-current alternators is not common, for though such alternators have been built they are used to but a limited extent. Unless used with step-up transformers, they have the same disadvantage as direct constant-current machines; i. e., in order to operate a large number of lamps they must generate a very high pressure.

32. Although it is quite possible to operate alternating-current arc lamps in series from constant-current alternators, the present practice is to generate the current by constant-potential alternators and then to supply it to the series circuits either directly, by means of special constant-current transformers, or through a regulator of some kind that will vary the E. M. F. applied to the circuit as the load varies. The advantage of this plan is that it allows series arc lamps to be operated from the same alternators that are used to operate incandescent lamps, thus simplifying the station equipment. Also, one large alternator operating at a moderate pressure can be made to operate a large number of series lamps by running a number of circuits all fed in parallel from the same dynamo and each circuit provided with an independent regulator or transformer to keep the current in that circuit constant.

OPERATION OF SERIES ARC LAMPS FROM CONSTANT-POTENTIAL ALTERNATORS

33. Operation Directly From Machine.—Suppose that alternator *A*, Fig. 19, generates current at a constant pressure of 2,000 volts. If enclosed-arc lamps are used, each lamp will take about 80 volts and about twenty-five

lamps can be connected in series across the line, as indicated. This is similar to the method described for operating incandescent street lamps in series. With this scheme of connection it is necessary to provide each lamp with a cut-out of some kind that will insert a resistance or reactance in

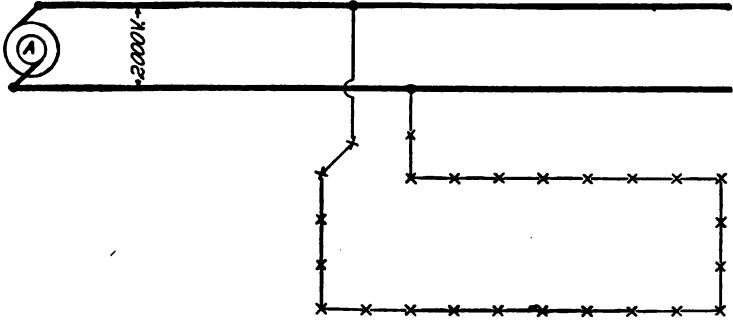

FIG. 19

the circuit whenever a lamp is extinguished; otherwise, the current will increase, for it must be remembered that the pressure applied to the circuit is constant no matter how many lamps may be in operation.

34. Use of Adjustable Transformer.—The operation of lamps direct from the machine is only possible when the number of lights on the circuit is suited to the voltage of the dynamo. This is generally not the case, and the above arrangement is therefore of limited application and has been used in comparatively few cases. Instead of supplying the lamps directly from the machine, a considerable range of applied E. M. F. can be obtained by using a constant-potential transformer with its secondary coil split into a number of sections. Each lamp is provided with a reactance coil, as before, but the use of the transformer admits of a considerable range in the number of lamps that may be operated on a circuit; that is, the combined voltage necessary for the lamps may be considerably different from that generated by the alternator. This arrangement does not, however, provide automatic regulation and is therefore undesirable.

35. Operation From Constant-Current Transformers.—A method now largely used for the operation of series alternating-current lamps from constant-potential alternators is that in which a special transformer is used to transform from constant potential to constant current. This system is practically the same as that described for the operation of series incandescent lamps by means of a constant-current transformer.

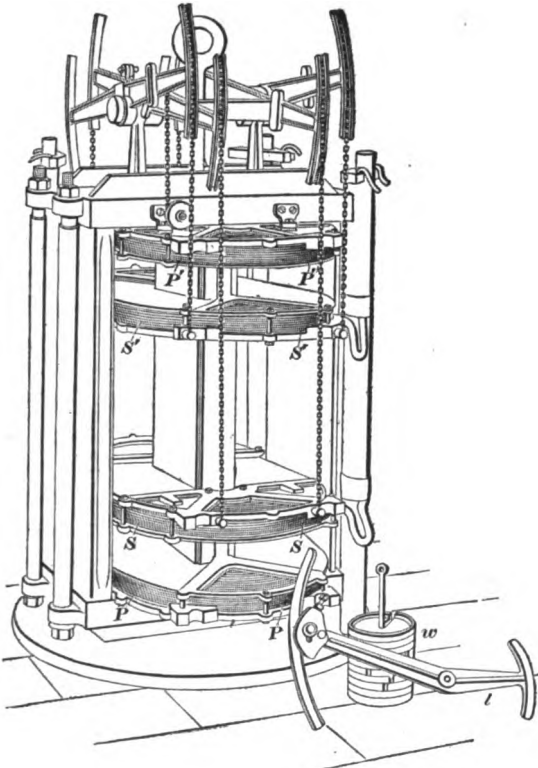

FIG. 20

Fig. 20 shows one of the larger sizes of General Electric constant-current transformer with the case removed. There are two fixed primary coils PP and $P'P'$ and two movable secondaries SS and $S'S'$. The two secondaries are

counterbalanced against each other by means of the levers, sectors, and chains shown in the figure, so that when the load is light both coils occupy a position near the center, and when it is heavy they both move toward the end coils. The weight w required to counterbalance the repulsion effect is carried by a small auxiliary lever l that projects through the top of the case. The two secondary coils can be connected in series to feed a single circuit, or they can be connected to two circuits, as in the multicircuit Brush dynamo.

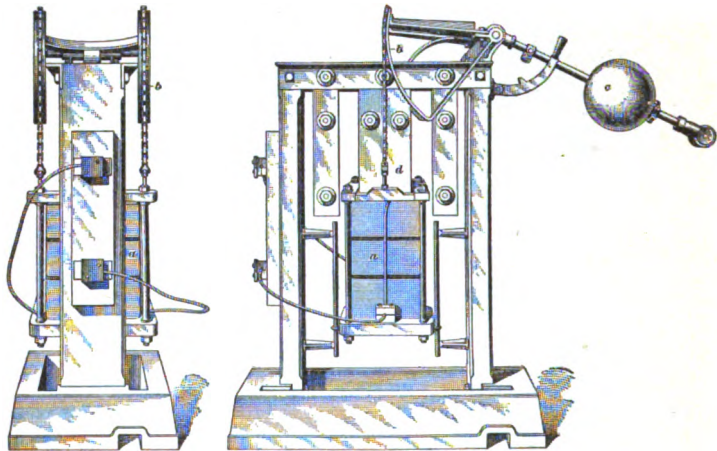

FIG. 21

36. Constant-current transformers can be placed either in the station or in a substation at a convenient point near where the lamps are to be supplied. In some instances they have been placed in substations and equipped with automatic time switches that cut them out in the morning as soon as the lights are no longer needed. At light loads, a system of this kind has a poor power factor; but if worked at nearly full load, the power factor is about .8, or about as good as the power factor of a load of induction motors. The low power factor has been urged as an objection against systems of this kind; and while it undoubtedly is an objection, it must not be forgotten that the doing away with arc-light dynamos and running all the lights, both arc

and incandescent, from the same machine is an advantage that goes far to outweigh the disadvantages of a low power factor.

37. Regulation by Means of Variable Reactance.

Balanced reactance coils are also used for the operation of series arc lamps from constant-potential mains in the same manner as described for series incandescent circuits. Fig. 21 shows a regulating coil made by the Western Electric Company. The coil *a*, which is partially counterbalanced by

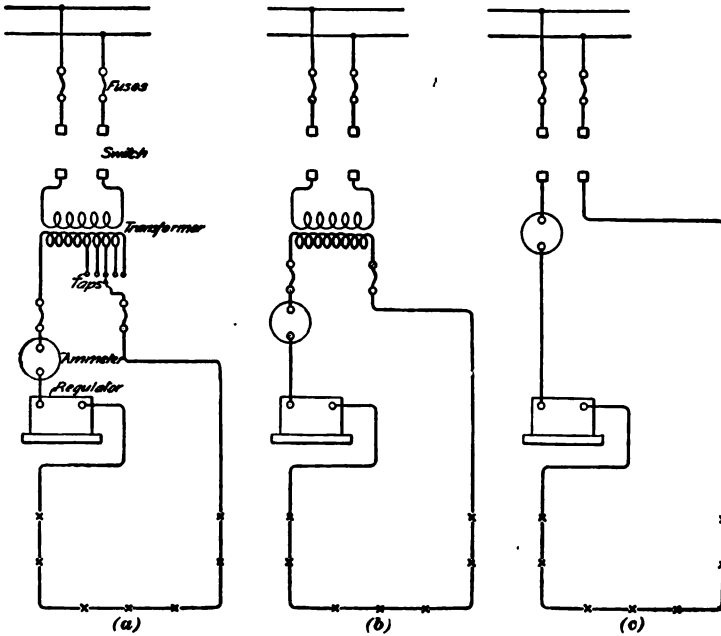

FIG. 22

weight *c*, is so suspended from a sector *b* as to slide up or down over the central part of the \square -shaped laminated core. Any increase in current causes the coil to be drawn up, thus increasing the reactance of the circuit and maintaining the current at constant value.

Fig. 22 shows different methods of supplying the arc circuit from constant-potential mains. The most desirable

arrangement is shown in (a), where the arc circuit is supplied from the secondary of a main transformer that is provided with a number of taps so that the transformer voltage can be adjusted to suit approximately the number of lamps to be operated. This requires but little voltage to be taken up in the reactance coil under normal full-load conditions and therefore secures a better power factor than if the lamps were operated as in (b). In this case the secondary of the transformer is not adjustable, and if the voltage required by the lamps is much less than that furnished by the transformer considerable voltage must be taken up in the reactance coil. The voltage across the terminals of the reactance coil is out of phase with the main secondary voltage; hence, the greater the voltage taken up by the regulator, the lower will be the power factor. In (c), the arc circuit, with its regulator in series, is attached directly to the mains. This is not as desirable an arrangement as (a) or (b), because a ground on the arc circuit grounds the main circuit also, as pointed out in connection with the operation of series incandescent lamps.

38. Economy Coils.—Sometimes it is desired to operate alternating-current arc lamps from 220-volt or 440-volt circuits. Lamps have been built to operate directly on 220 volts but they are not as satisfactory or as efficient as low-voltage (100–120-volt) lamps. A satisfactory method

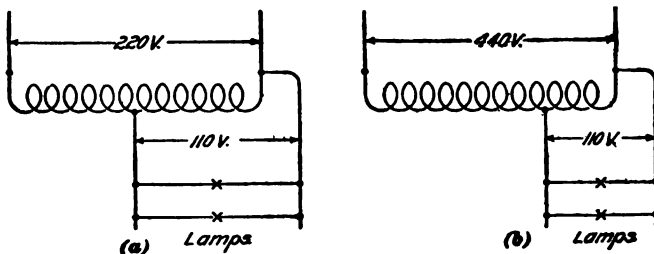

FIG. 23

of operating low-voltage lamps on these moderately high-voltage circuits is by means of **economy coils**, or **auto-transformers**, shown in Fig. 23. The economy coil is wound on a laminated iron core in the same way as the coil

of an autotransformer, and a tap is brought out at the middle point, as in (a), if the coil is used to transform from 220 to 110 volts; if used on 440 volts, the secondary is connected so as to include one-quarter of the total number of turns on the coil.

39. Balancing Coils.—Sometimes these coils are used as shown in Fig. 24, where they split up the voltage as indicated. Thus, in (a), a 220-volt, two-wire system is changed to a three-wire system with 110 volts on each side. If one side becomes more heavily loaded than the other, the current on the heavily loaded side flows through the neutral to the coil on that side. The transformer action between the coils maintains an approximately constant voltage on the two sides no matter whether the load is balanced or not. An autotransformer used in this manner is often called a **balancing coil**. In (b), the same principle is followed out

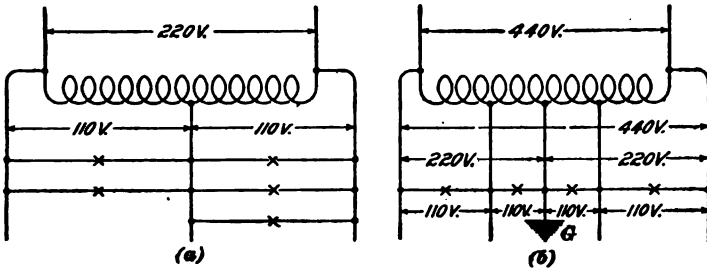

FIG. 24

except that a five-wire system is supplied from the coil. The middle wire is usually grounded so that the pressure that may exist between any wire and the ground can never exceed half the voltage between the outside lines. An arrangement similar to that shown in diagram (b) is often very useful in installations where alternating current is distributed at 400 to 500 volts for power purposes, as for example in large manufactories, and where it is desired to have several lower voltages for the operation of arc and incandescent lamps or for use in starting motors. The balancing coil has to be large enough to handle the unbalanced current only, and

hence is much smaller than a regular transformer capable of transforming the whole of the power supplied to the secondary circuit. Balancing coils, or autotransformers, should not be used where there is a very great difference between the primary and secondary pressures. Under ordinary conditions, if the primary pressure is over 500 volts it is safer and better to use a regular two-coil transformer.

ARC-LIGHT SWITCHBOARDS

GENERAL CONSIDERATIONS

40. Arc-light switchboards bear little resemblance to those used for constant-potential incandescent lighting. In most stations of any size, there are several arc machines, or if alternating current is used, several arc-light transformers and several circuits. It is desirable to have the switchboard arranged so that any machine or transformer can be connected to any circuit and so that a circuit can be transferred from one source of supply to another while in operation, or, if necessary, so that circuits can be operated in series. An arrangement of switches to accomplish this would be exceedingly complicated, and arc-light boards are therefore of the plug variety. The various connections are made by inserting plugs into receptacles, the circuit being completed on older boards by flexible cables and on later types by the plug itself.

41. Operating Circuits in Series.—Quite frequently, when the number of lamps on one circuit is insufficient to load up a dynamo or transformer, two or more circuits are connected in series at the switchboard. With direct-current boards, the terminals of the circuits should be marked + and - on the switchboard, the + side being that at which the current leaves the station and the - side that at which it returns. In connecting direct-current circuits in series, the - end of one circuit should be connected to the + end of the other, as indicated in Fig. 25. If two - ends are

connected, the current will flow through the second circuit in the wrong direction and the lamps will burn "upside down."

The switchboard is usually equipped with an ammeter, which will indicate when the current is flowing in the proper direction. Some of these ammeters, for example, the Weston, will not give a deflection over the scale unless the current

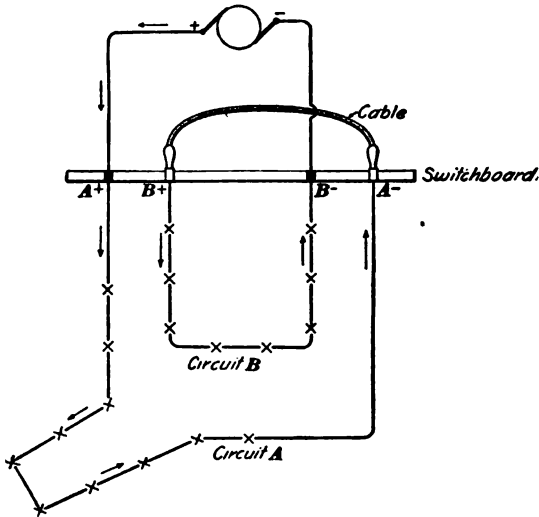

FIG. 25

flows in at the + terminal. Others have an indicating attachment that shows whether or not the current is flowing the wrong way. It goes almost without saying that series arc circuits are never connected in parallel. If this were done, the current would split between the circuits and the lamps would not operate properly.

CONSTRUCTION AND OPERATION OF ARC SWITCHBOARDS

42. Simple Board With Cables.—Fig. 26 illustrates about the simplest possible type of board equipped with an ammeter and terminals for two machines and four circuits. These terminals take the form of sockets or spring jacks mounted on the board, and connections are made between

the various receptacles by means of heavily insulated, flexible cables provided with a plug at each end. Each terminal is double, and those for the dynamos are arranged in the lower row and marked $+A$, $-A$, $+B$, $-B$, each dynamo being distinguished by its letter A or B . The terminals of the four line circuits are arranged in two rows in the upper part of the board and are marked $+1$, -1 , $+2$, -2 , $+3$, -3 , $+4$, -4 , each circuit being distinguished by its number 1 , 2 , 3 , or 4 . The ammeter AM is mounted in the center of the board and is provided with terminals $+$ and $-$. The board itself is usually made of a good quality of marble.

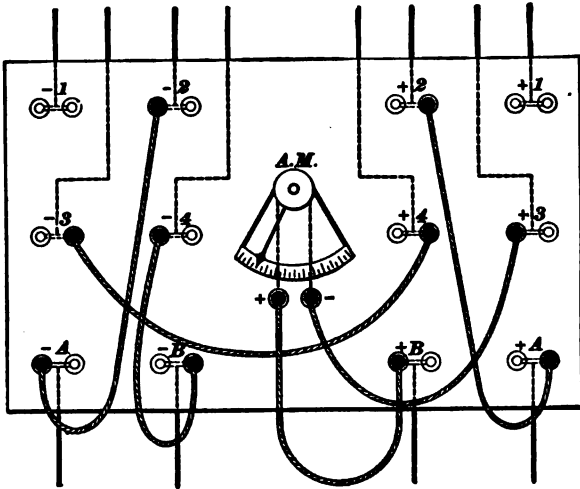

FIG. 26

Slate is not a good material for arc boards, as it is liable to contain metallic veins. It must be remembered that the pressure between the terminals of an arc machine at full load is very high, hence the switchboard terminals must be well insulated. On most boards, the terminals are not even allowed to come in contact with the marble, but are insulated from it by means of hard-rubber bushings, the marble serving merely as a support and not depended on for insulation.

The operation of plugging in circuits or dynamos always appears confusing when explained on paper. It is, however,

comparatively easy to follow out on the board itself, where one can handle the cables or plugs and make the required connections for himself. A little practice during the day-time, when the circuits are not in use, will soon enable one to become so familiar with the method of operation that all necessary changes can be made quickly and with certainty.

In making changes on an arc board, it must be distinctly borne in mind that a circuit carrying current should not be broken in order to cut in or out line circuits containing lamps. If the circuit is opened, the effect is to increase the resistance of the circuit by a large amount, and the voltage will rise greatly. Besides causing a long, vicious arc at the switchboard and perhaps injuring the attendant, it is very hard on the insulation of the dynamo or transformer. If a dynamo or circuit is to be cut out, it should first be short-circuited. Arc machines and constant-current transformers are not injured by short-circuiting as constant-potential apparatus would be, because as soon as they are short-circuited the voltage generated drops to a very small amount. In Fig. 26 each terminal is made double, so that transfers can be made without opening the circuit.

In Fig. 26 circuit 1 is "dead," because its terminals are not connected to anything. Circuit 2 is on dynamo *A*, the path of the current being $+A- +2- -2- -A$. Circuits 3 and 4 are in series with each other on dynamo *B*, and the ammeter is also in series in this circuit. The path of the current is $+B$, through the ammeter to $+3- -3- +4- -4- -B$.

43. Suppose it is desired to connect the ammeter in circuit 2. To disconnect it from circuits 3 and 4, it is first short-circuited by plugging in a cable across the terminals $+B$ and $+3$. The two plugs on the cables leading to the ammeter may then be withdrawn from $+3$ and $+B$, and the circuit will not be opened. The plugs removed from $+B$ and $+3$ may then be inserted at $+A$ and $+2$, respectively, thus shunting the ammeter across the cable $+A +2$. The cable $+A +2$ is then removed and the current supplied to circuit 2 passes through the ammeter.

44. Again, with the connections as shown in Fig. 26, suppose that it is desired to connect circuit 1 in series with circuit 2 without shutting down either the dynamo or circuit 2. The first step will be to connect terminal -1 with terminal $+2$, then terminal $+A$ with terminal $+1$. The cable directly connecting terminal $+A$ and $+2$ may now be removed without opening the circuit at any point and at the same time throwing the two circuits 1 and 2 in series.

45. **Brush Plug and Spring Jack.**—In case cables are used for making the connections, it is necessary to have the plugs thoroughly insulated so that there will be no chance for the switchboard attendant to make accidental contact with any of the terminals on the board during the process of plugging. No live metal work of any kind should be allowed on the face of the board. Moreover, the plugs should be constructed so that in case a circuit is opened by their withdrawal, the consequent arcing will not cause damage.

Fig. 27 illustrates the style of plug used on boards for large Brush machines. A is the marble panel and b the

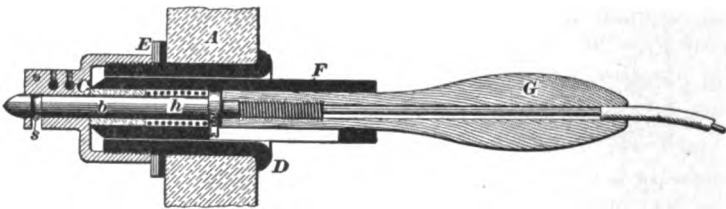

FIG. 27

metal plug, or contact, attached to the cable as shown. C is a cup-shaped casting to which the line is connected and into which b slides and is held by the spring clip s , so as to make a good contact. C screws on to the end of the hard-rubber bushing D and is separated from the marble by the insulating washer E . F is a hard-rubber sleeve, or tube, and G a maple handle; h is a spiral spring that causes the sleeve F to slide over the contact piece b when the plug is pulled out, so that by the time the plug is pulled entirely out of the board, the contact b is completely covered and there is no danger of

the attendant coming into contact with it. When a plug is inserted, the nose of the sleeve *F* comes against casting *C*, and as the plug is pushed on in, contact *b* passes through the hole in *C* and is held by the spring *s*. These jacks are usually mounted in pairs connected together, so that transfers can be made without opening the circuit.

46. Western Electric Plug and Jack.—Fig. 28 shows a jack and plug used by the Western Electric Company. It consists of a main jack *A* and two smaller jacks *B, B*, which are used in making transfers. The springs *a, b, b* hold the

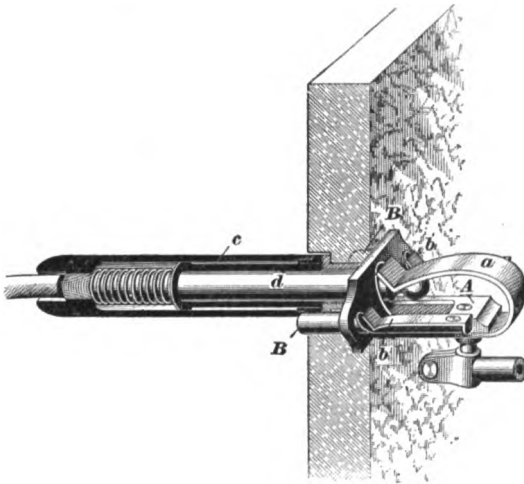

FIG. 28

plugs in place by engaging the groove on the end of the plug. This plug also has a hard-rubber sleeve *c* that slides over the metallic terminal *d* as soon as the plug is pulled out. The general arrangement of the plug and jack will be apparent without further explanation.

47. Board Without Cables.—Fig. 29 illustrates the principle of one of the earlier types of board made by the General Electric Company, in which cables are almost wholly dispensed with. This is accomplished by means of two groups of contacts arranged in two parallel planes a little

distance apart. The contacts in the front group are divided into pairs of horizontal rows, each pair being connected to the terminals of one of the dynamos. The contacts on the back group are divided into pairs of vertical rows, each pair being connected to one of the circuits. The contacts, which are in the form of bushings, are directly opposite each other and the connection between any dynamo and any circuit is made by a long brass plug that is pushed through the outside contact to the inside. In Fig. 29, the dynamo terminals are lettered $A+$, $A-$, etc., and the circuit terminals $1+$, $1-$,

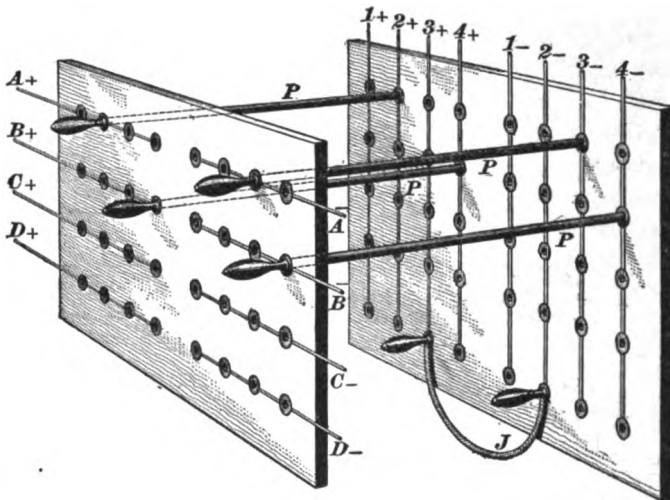

FIG. 29

as in the preceding case. The back, or *circuit*, board is provided with an extra row of contacts at the bottom, by means of which circuits may be connected in series, using for the purpose cables having suitable terminals, similar to those used for connections in the form of board first described. For the arrangement of plugs shown in Fig. 29, the path of the current is as follows: $A+ - 2+ - 2- - J - 3+ - 3- - A-$. Circuits 2 and 3 are in series on dynamo A . Also circuit 4 is on B because $B+$ and $B-$ are plugged through to $4+$ and $4-$. Circuit 1 is dead. By using a cable with short plugs

that only reach through the front bushings, dynamos may be connected in series, if necessary.

In Fig. 29 the sets of bushings are shown separated much farther than they are on the actual board, in order to make the figure clear. On the actual board the back contacts are carried on vertical copper straps that are attached to the front board. Fig. 30 shows the general appearance of one of these boards and indicates the location of the positive and negative terminals of the dynamos and circuits. Fig. 31

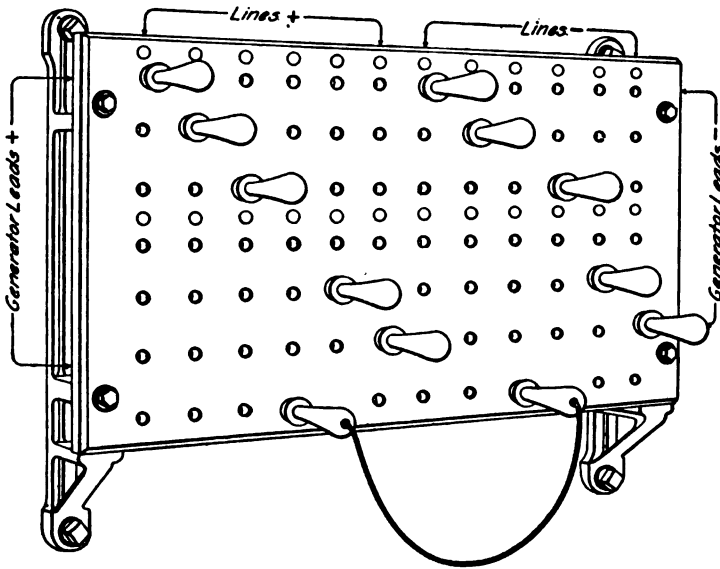

FIG. 30

gives an idea as to the method of mounting the bushings and is self-explanatory. Bushings *b* are used for connecting circuits in series.

48. Carrier-Bus Board.—This is a later type of board made by the General Electric Company; it is somewhat similar to the one last described, but is constructed in the form of panels and arranged so that more dynamos or circuits can be added at any time by adding more panels to the existing board. Transfers of circuits from one dynamo to another

are effected by means of bus-bars running across the back of the board, and no cables are required. The general arrangement of the board will be understood by referring to Fig. 32. In view (c), the lower terminals *b, c, d, e, f, g* are connected to the machines *A, B,* and *C*. The terminals at

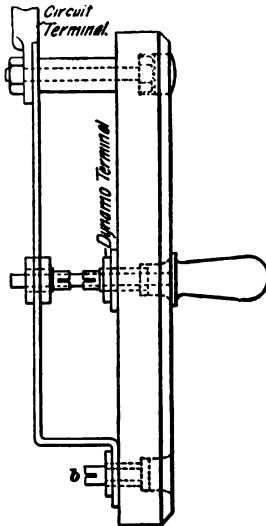

FIG. 31

the top connect to the circuits *1', 2',* and *3'*. The crosspieces *3, 4, 5, 7, 8,* and *9* run across the back of the board and can be connected to similar crosspieces on the next panel by means of the connection strips *3'', 4'', 5'',* etc. and plugs inserted in the side sockets *m, m*. An ammeter jack is connected in each side of each circuit, the ammeter being connected by inserting a plug at any one of the upper row of jacks *b, c, d,* etc. in view (a). It is desirable to have the ammeter arranged so that it can be cut in on either side of a circuit because it facilitates testing for grounds. A leakage of current from the dynamo to ground and thence back

to the other side of the machine through a ground somewhere out on the circuit will cause a reading of the ammeter, when connected in one side of the circuit, different from that obtained in the other side.

49. Figs. 33 and 34 show the style of plug switch and plug used. All conducting parts are insulated from the supporting panel by means of porcelain insulators; the back contacts are held out from the board by porcelain pillars; and the whole construction is such as to give a high degree of insulation. When the plug is inserted, connection is made between the front and rear contact bushings or thimbles, and when a plug is withdrawn, the arcing takes place within the fiber tube, Fig. 33; a long break in a confined space is thus secured and the arc suppressed.

50. The ammeter jack for connecting the ammeter in circuit is shown in Fig. 35; Fig. 36 shows the special plug used with the jack. In Fig. 35, *a* and *b* are two small bus-

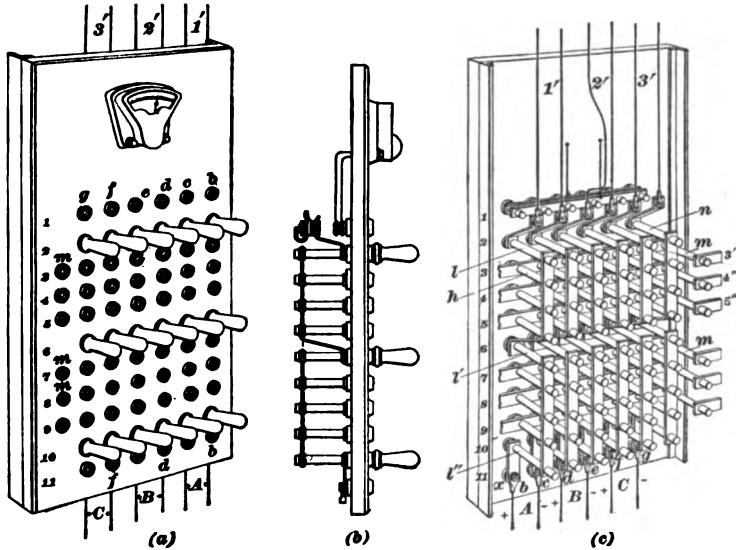

FIG. 32

bars, insulated from each other and connected to the terminals of the ammeter, that run across the back of the board

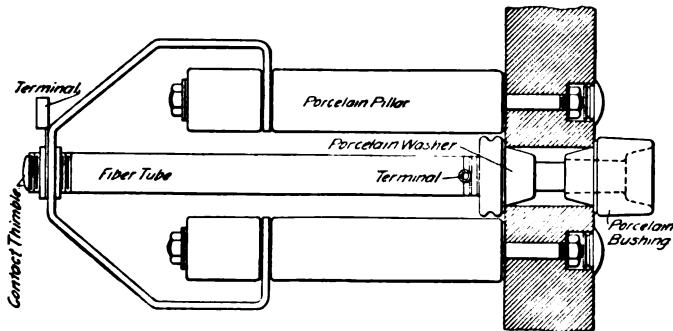

FIG. 33

and have contact bushings in line with the plug receptacles *b, c, d*, etc., Fig. 32 (*a*). Mounted directly back of each

receptacle and in line with it is the jack, consisting of a contact bushing *c*, Fig. 35, contact spring *d*, and terminal *e*. When the plug is not in place, spring *d* makes contact with bushing *c* and the current passes from *f* to *c* and thence to the

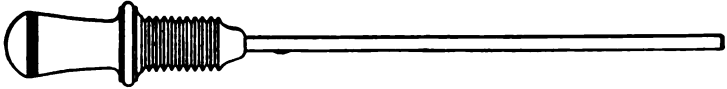

FIG. 34

circuit. The plug, Fig. 36, has three contacts *a*, *b*, *c*; *b* and *c* are parts of the same brass rod, but sleeve *a* is insulated. When the plug is inserted, point *c* pushes spring *d* out from the contact bushing *c*, Fig. 35, and at the same time

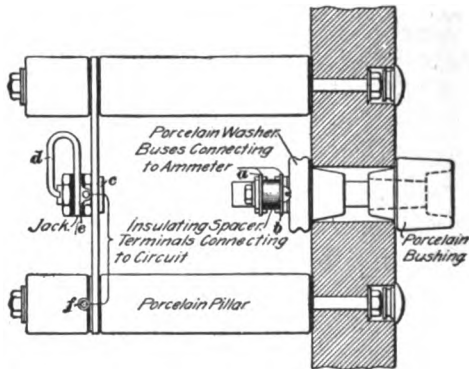

FIG. 35

part *b* of the plug makes contact with the sleeve in bus-bar *b*. Sleeve *a* on the plug connects bushing *c*, Fig. 35, with bus-bar *a*. Thus, when the plug is inserted, current entering at *f* takes the path *f*-bushing *c*-sleeve *a* on plug-bus-bar

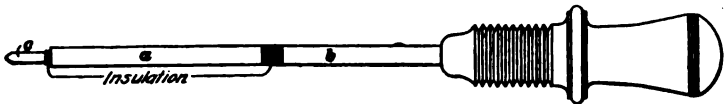

FIG. 36

a-ammeter-bus-bar *b*-contact *b* on plug-tip *c* on plug-spring *d*-terminal *e*-circuit. When the plug is withdrawn, spring *d* makes contact with *c* before the circuit through the ammeter is broken, thus preserving the continuity of the circuit.

51. The method of using the board will be understood by referring to Figs. 32 (c), 37, and 38. There are three breaks l, l', l'' , Fig. 32 (c), in each vertical strip between a dynamo terminal and a corresponding circuit terminal. When, therefore, these breaks are plugged across, as indicated by the three rows of plugs in Fig. 32 (a), dynamo A is operating circuit $1'$; dynamo B , circuit $2'$; dynamo C , circuit $3'$. This will be apparent by referring to Fig. 37. The vertical lines here represent the vertical bars, in which the breaks are indicated by open spaces. The black dots represent the plugs, and

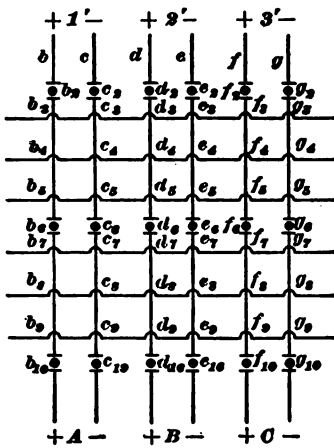

FIG. 37

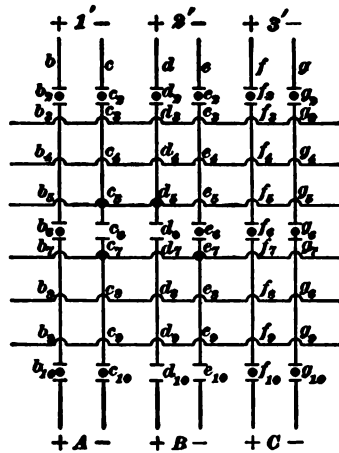

FIG. 38

are supposed to connect the two terminals between which they are inserted. Fig. 32 represents the ordinary condition of running, where the cross-bars are not in use.

52. Suppose it is desired to shut down machine B and run circuits $1'$ and $2'$ in series on machine A . Insert plugs at c_1, d_1, c_7 , and d_7 , and remove plugs c_2 and d_2 . This leaves two circuits and two machines in series. Short-circuit machine B by inserting a plug at e_1 , and cut out machine B by removing plugs d_{10} and e_{10} . Then take out plug d_7 , and the board will be as indicated in Fig. 38. The path of the current will now be $A + -b_{10} - b_7 - b_1 - 1' +$ through circuit $1' - 1' - -c_2 - c_1 - d_7 - d_1 - 2' +$ through circuit $2' - 2' - -e_1 - e_7 - e_{10} - c_7 - c_{10} - A -$;

thus, circuits 1' and 2' are in series on dynamo *A*. Although the combinations on these boards are not so easy to follow out from a diagram, the manipulation of even a large board is something that is soon learned when one has the board actually before him. In order to distinguish between the various plug switches and thus reduce the liability of making mistakes, all open-circuiting, bus-disconnecting, and ammeter-jack receptacles are provided with brown porcelain bushings. All bus-transfer receptacles have blue porcelain bushings and are indicated by the black rings in Fig. 32 (a).

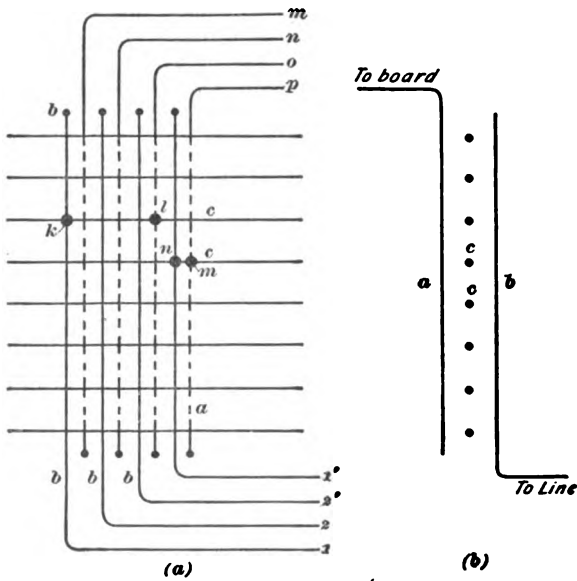

FIG. 39

53. Transfer Boards.—It is highly important that all arc-line wires brought into the station should be run as straight and free from crossings as possible. A number of fires have resulted from the numerous crossings and the general maze of wires to be found in some of the older stations, especially at the point or in the tower where the wires enter the building. These crossings were generally made in order to bring the wires to the switchboard in the

correct order for connecting up. In some stations, in addition to the switchboard, a transfer board is provided to enable the lines running to the switchboard to be connected to any of the lines running out of the station. By using a transfer board, the wires coming into the station may be brought in in any order that may be most convenient, and they may be run straight to the board without crossings. They may then be sorted out and connected to any desired circuit terminals on the switchboard by using the transfer board. The transfer board is also very useful for changing the terminals of a circuit from one part of the board to another, as it enables it to be done without disturbing the connections at the switchboard terminals themselves.

The general arrangement of the transfer board will be understood by referring to Fig. 39. A number of bare No. 4 or 6 B. & S. wires *a b* are stretched vertically, 5 or 6 inches apart, on a substantial framework. In Fig. 39 (a) they have been shown a little to one side of each other in order not to confuse the connections. Between these, a corresponding number of horizontal wires *c* are stretched. One set of vertical wires *a* runs directly to the circuit terminals on the switchboard and the other set *b* connects to the line wires.

The horizontal wires are used for connecting across from any line to any switchboard lead. For example, suppose *1* and *1'* are the circuit terminals that are to be connected

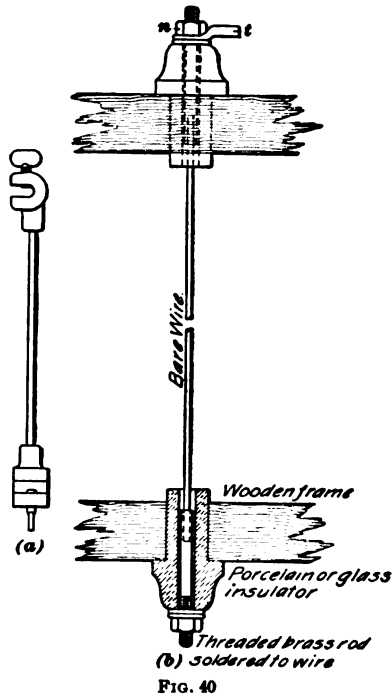

to switchboard leads o, p . By connecting to the cross-wire, as shown at k, l , line 1 is connected to o , and by connecting as shown at m, n , line $1'$ is connected to p . By this arrangement, therefore, the line and switchboard connections can be transferred in any way desired. The actual number of wires used in any case will, of course, depend on the number of circuits to be accommodated. The connections between vertical and horizontal wires are usually made by means of a clamp connector, somewhat similar to that shown in Fig. 40 (*a*). Different methods are used for stretching the wires on the frame, but they should always be mounted so that they will be thoroughly insulated. On this account the wire should be passed through porcelain or glass insulators at each end, as indicated in Fig. 40 (*b*). The wires are stretched tightly by screwing up on the nut n and the line wire attaches to terminal l .

SWITCHBOARDS FOR ALTERNATING-CURRENT SERIES SYSTEMS

54. General Electric Switchboard.—When series alternating-current arc lamps are operated from constant-potential alternators, either through constant-current transformers or otherwise, it is usual to provide a small switchboard for each transformer or regulator; that is, the various devices necessary for the control or protection of the transformer or regulator and the circuits supplied from it, are grouped together and the board is frequently placed near the transformer that it controls.

Fig. 41 shows front and rear views of a General Electric board of this kind designed for a 35-light transformer supplying current to a single series arc circuit. The board is equipped with an ammeter a , plugs b, b for breaking each side of the arc circuit, a plug receptacle c for short-circuiting the arc circuit or secondary of the constant-current transformer, two plugs d, d for disconnecting the primary of the transformer from the alternator, and a Thomson recording wattmeter e for measuring the total watt-hours supplied. The ammeter a is supplied with current from a current

transformer *f* mounted on the back of the board so that the instrument is thoroughly insulated from the high-pressure arc circuit. The potential transformer *g* steps down the primary pressure for the potential coil of the wattmeter, and the case *h* contains the non-inductive protective resistance

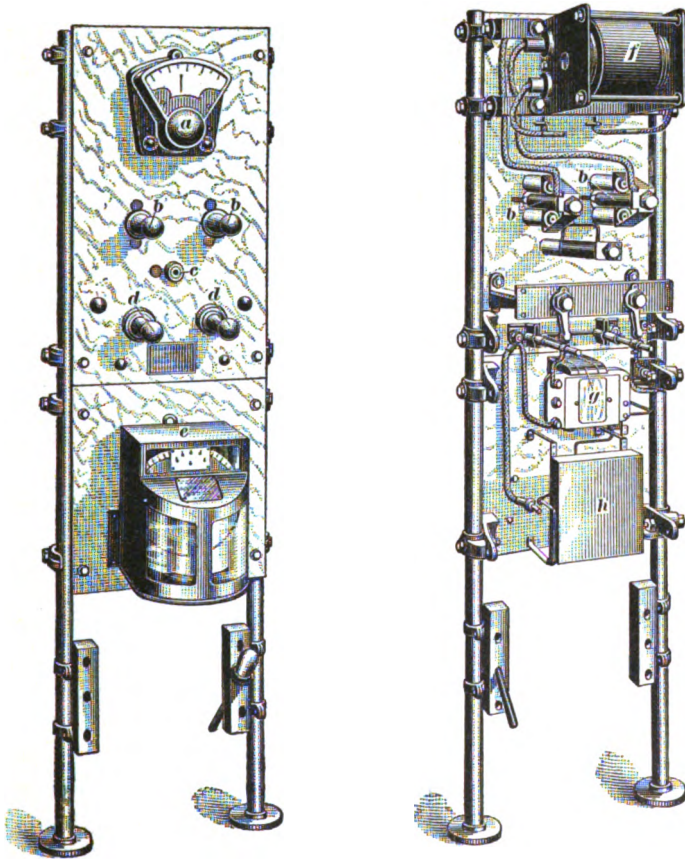

FIG. 41

in series with the potential circuit of the wattmeter. The plug switches *a, a* are connected to the primary of the transformer through high-tension enclosed fuses that protect the transformer from overload. Plug switches *b, b*

are thoroughly insulated by being mounted on porcelain insulators as shown. Fig. 42 shows the connections for this switchboard. The corresponding parts in Figs. 41 and 42 are lettered alike so that further explanation is unnecessary.

55. Fig. 43 shows the connections for a similar board used with a transformer of 100-lights capacity supplying two circuits on the multicircuit plan. The transformer is

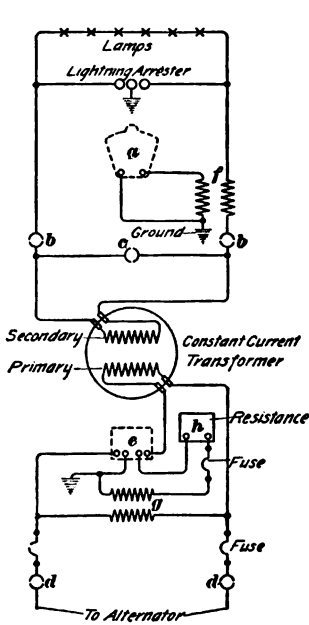

FIG. 42

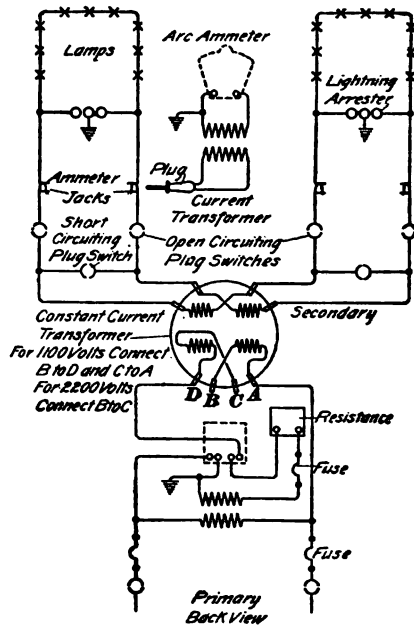

FIG. 43

provided with two secondary coils, which are connected in series through the two lighting circuits. The primary is also provided with two windings so that they can be connected in parallel for 1,100 volts or in series for 2,200 volts. The plugs for each circuit are arranged as in Fig. 42, but only one ammeter is provided, the primary of the constant-current transformer being connected to an ammeter plug that can be inserted in suitable jacks, without

opening the lamp circuit, and thereby made to indicate the current in either circuit.

56. The ammeter jack used on this board is shown in Fig. 44. The ammeter is connected to the plug by means of a twin cable, one end of which is connected to sleeve *b* and the other to contact *c*; *b* and *c* are, of course,

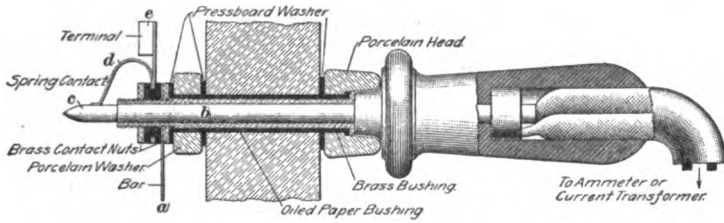

FIG. 44

insulated from each other. When the plug is inserted, *b* is in contact with *a*, and *c* with *d* and *e*, thus cutting the ammeter into circuit. When the plug is withdrawn, spring *d* makes contact with the bushing to which *a* is connected, thus maintaining the circuit.

Fig. 45 shows the construction of the plug switches. The plug is a straight brass rod with a well-insulated handle and,

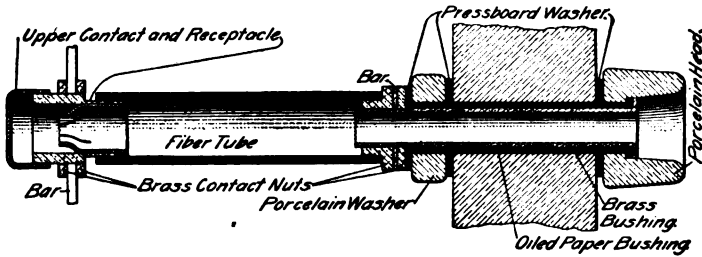

FIG. 45

when inserted, makes connection between the front and rear bushings. When the plug is withdrawn, the arcing takes place within the fiber tube and is smothered out.

57. **Western Electric Switchboard.**—Fig. 46 shows a switch used by the Western Electric Company on alternating-current arc switchboards. It is of the plunger

type, each side of the circuit being broken when the handle is pushed in. The arc is broken within the porcelain cylinders so that there is little chance for it to hold over and burn the contacts.

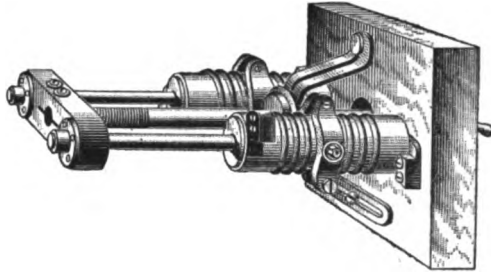

FIG. 46

Fig. 47 shows front and rear views of the small switch-board panel used with each of the transformers supplying series circuits. It is equipped with a tubular switch *a*, operated by handle *b*, and fuses *c*, *d* enclosed in porcelain

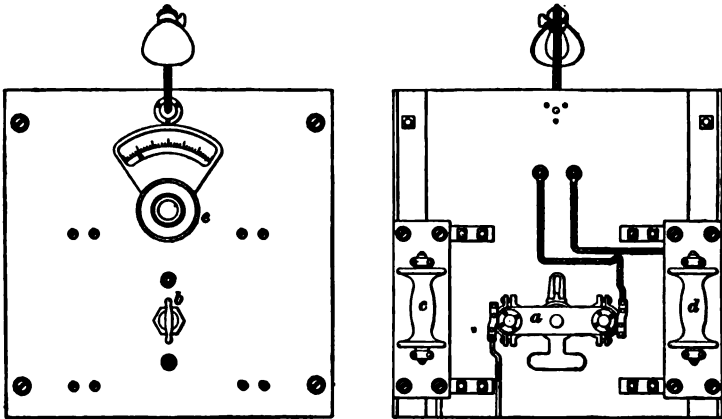

FIG. 47

handles so that they can be easily removed for renewal. The ammeter *e* is connected directly in the circuit, but for very high pressure circuits it would be advisable to operate the ammeter from the secondary of a series transformer.

Fig. 48 shows one arrangement of an arc switchboard together with the transformers and regulators through which the alternating current is supplied from the machines to the circuits. The switchboard is mounted in a gallery and

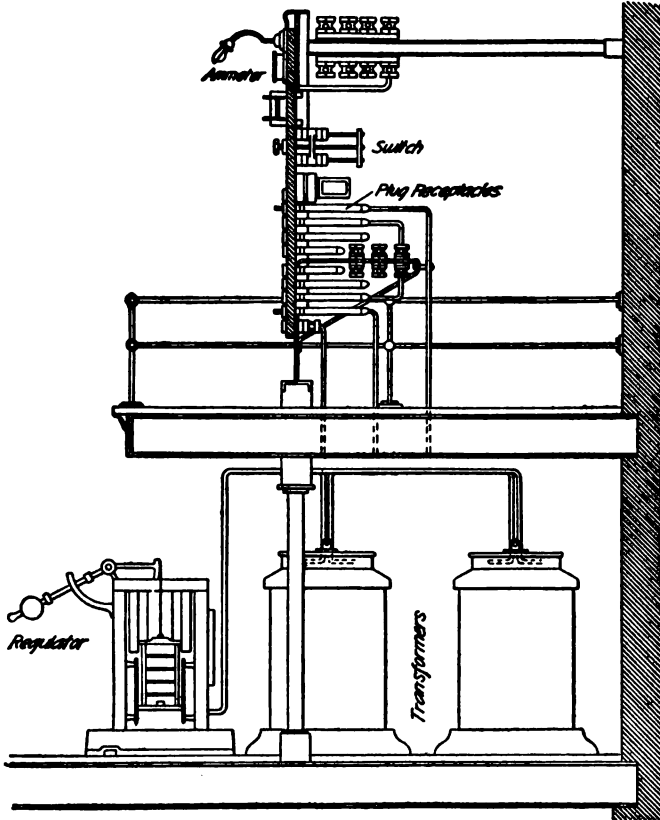

FIG. 48

the transformers and regulators are placed underneath, as shown. This plan of mounting the board in a gallery is used quite largely in large city stations or in other places where space is limited.

INTERIOR WIRING

(PART 1)

PRELIMINARY CONSIDERATIONS

1. The subject of interior wiring involves a study of the various methods for supplying electric current to devices, such as lamps, motors, etc., used in buildings; also, the methods for operating bells, burglar alarms, and other minor appliances operated by electricity.

In electric wiring, the ultimate object is the conveying of the electricity to the lamp, bell, motor, or other device that is to be operated. But this must be done in a proper manner; otherwise danger, unsatisfactory operation, and waste are sure to result.

2. Four things should be considered in every electric installation: (*a*) safety, (*b*) satisfactory operation, (*c*) convenience and neatness, and (*d*) economy. The first is by far the most important. Therefore, the electrical worker should understand, first of all, what are the sources of danger in the use of electric currents and then what precautions are necessary and what conditions must be complied with to avoid these dangers. When he thoroughly understands these things, he should learn how to make his work satisfactory in other respects and profitable to himself.

The same causes that, under certain conditions, make electricity dangerous to life also make it a source of fire hazard. There are also conditions under which an electric current may cause fire, although it may not be directly

For notice of copyright, see page immediately following the title page

dangerous to life. In discussing the precautions necessary to avoid any chance of fire from an electrical cause, the student will learn how to avoid danger to life as well, so that it is unnecessary to discuss that subject by itself.

FIRES CAUSED BY ELECTRIC WIRING

3. The so-called "electrical fires," or fires that are caused by the presence of electric wires or apparatus within a building, can be divided into three classes, as follows:

1. Fires caused by poor work or improper materials.
2. Fires caused by overloading the apparatus or wire with a higher voltage or with more current than it was designed to carry.
3. Fires caused by lightning striking the outside lines or by the crossing of circuits that should never come into contact with one another.

A good job of interior wiring overcomes all danger due to the first two of these sources of hazard and most of the danger due to the third, but not all, for accidents sometimes occur outside of the buildings, against the results of which the present accepted devices for the protection of inside circuits are not sufficient. The failure of a lighting company to use proper lightning arresters and transformers or to insulate the outside wires thoroughly may cause trouble within a building in which the wiring is properly done.

THE NATIONAL ELECTRICAL CODE

4. When electric lights first came into general use, the insurance companies discovered that there were many fires of electrical origin, because the wiring was of very inferior workmanship. The various associations of underwriters, therefore, formulated rules in accordance with which they required that all wiring be done or they would not insure buildings containing it. In the course of time, these various rules of local associations were reduced to a uniform code, and finally, in 1898, they became known as the **National Electrical Code** and received the indorsement of practically

all the inspection bureaus throughout the United States, besides that of the following organizations: the American Institute of Architects, the American Institute of Electrical Engineers, the American Society of Mechanical Engineers, the American Street Railway Association, the Factory Mutual Fire Insurance Companies, the National Association of Fire Engineers, the National Board of Fire Underwriters, the National Electric Light Association, the Underwriters' National Electric Association.

A few cities have rules of their own that differ slightly from this code, but the differences are not vital. Any person doing work in any city where there is municipal legislation governing his work should investigate the laws of that particular place before undertaking to lay out work for himself. Every wireman should be supplied with a copy of the latest edition of the National Electrical Code and do work in compliance with those rules, whether additional laws exist or not. Copies of the code and of all other information published by the Underwriters' Association for the sake of reducing the fire hazard can be obtained by writing to the laboratories of the National Board of Fire Underwriters at Chicago or by applying at the nearest Underwriters' Inspection Bureau. The rules are revised by conventions as often as changes in the electrical art make such revision necessary.

5. Fittings That May Be Used.—In addition to this code of rules, the National Board of Underwriters publishes twice each year a list of approved fittings for use in connection with the code. This list contains the names of articles that have been found entirely satisfactory, together with the names of the manufacturers. It does not contain a list of *all* fittings that will pass inspection, and many good articles are not listed in its pages.

EXAMPLES OF ELECTRICAL FIRES

6. That the student may properly understand the nature of the fire hazard due to the presence of electric circuits, before studying the various preventives, the following typical examples of electrical fires are briefly described. These are reports

of actual fires and burn-outs taken from the Quarterly Fire Reports of the National Board of Fire Underwriters.

1. Loose connection on series incandescent circuit in show window. Arc ignited insulating covering of wire and fire spread to surrounding inflammable material. Four sprinkler heads opened and extinguished the fire. Contents of window destroyed.

2. Socket-shell burn-out in show window of millinery store. Short circuit caused by metallic shell of socket on window fixture establishing connection between projecting strands of flexible fixture wire.

3. Paraffin-covered wire used for pendants for drop lights. Wiring installed on a motor circuit, after inspection, by occupant of building who wished to secure light. Short circuit ignited paraffin covering and whole place burned up.

4. Short circuit or ground on constant-potential lighting circuit, where mains ran unprotected through damp woodwork in a brewery. The arc thus formed ignited insulating covering of the wire and fire communicated to woodwork of frame building.

5. Short circuit in flexible cord in show window burned out the window.

6. Heating effect of incandescent lamp. A 16-candle-power incandescent lamp on a 52-volt circuit was left lying on a coat in a newspaper office. About 4 hours after the lights were turned on the coat was discovered smouldering, and on being moved burst into flame.

7. Revolving wheel of incandescent lamps in show window covered with handkerchiefs burned out the window either by sparking at the commutator or from heating effect of the lamps.

8. Sparks from an arc lamp dropped on a table underneath that was covered with open boxes of shirt waists. The table and contents destroyed, otherwise no considerable damage.

9. Flexible lamp cord wound around a gas fixture having a soft-rubber insulating joint. The current grounded through the joint and the arc ignited the escaping gas.

10. Overheating of No. 14 B. & S. wires due to partial short circuit, caused by moisture, through porous crockery knobs on which wires were mounted. The fuses, which were too large, did not melt for some time and the burning insulation of the wires set fire to combustible material near, causing a loss of \$15,000.

11. A fuse block, improperly constructed and placed in close proximity to woodwork, held an arc after a short circuit long enough to set fire to the woodwork.

12. Main feed-wires placed in an elevator shaft were short-circuited by a breakdown of their insulation. A heavy arc was established that set fire to building.

13. Overheating of resistance coil of arc lamp that was improperly insulated and too near adjacent woodwork set fire to building.

14. Short circuit of No. 14 wires installed, contrary to rules, in molding in a place exposed to moisture. The fire was stubborn and burned fitfully between floors and was not extinguished before a loss of \$2,000 had been sustained.

15. Fire in public institution. Building wired throughout with weather-proof wire run through joists without bushings, both wires of the circuit being brought through one hole at lamp outlet without separation. Short circuit occurred in attic that quickly set fire to dry timbers.

16. An Edison plug cut-out was improperly used to protect a 5-horsepower motor operating at a difference of potential of 220 volts. Fuse in blowing failed to open circuit, thus maintaining an arc that set fire to building.

17. Circuit controlling an electric flat iron was left turned on, becoming overheated and setting fire to the table. Circuit had no signal lamp or other indicating device recommended for such equipment.

18. Overheating of mechanism in a 2,000-candlepower series arc lamp, the metal casing of which did not fit, set fire to the ceiling. The store was closed, but the lamp had been left burning until the circuit was shut off. This fire illustrates the advisability of cutting all current out of buildings when the same are unoccupied.

19. A fire occurred in show window, caused by a bath towel falling from support on to a lighted incandescent lamp in bottom of window; the towel becoming ignited set fire to the contents of window and damaged some of the stock in store.

20. Lightning entered building over badly installed watchman circuit. No protective devices at entrance to building. Wires badly insulated; fastened by staples. Heat of wires set fire to joists of building.

21. Ground of 110-volt circuit on gas pipe in attic. Arc burned $\frac{1}{4}$ -inch hole in pipe and set fire to escaping gas.

22. Fire in basement of building caused by accumulation of sodium salt on back of three-wire molding run on brick wall. Trouble occurred at a point where a nail had been driven through molding into wall.

23. Short circuit in fixture canopy ignited ceiling above fixture. Fire also occurred at same moment in cabinet at center of distribution. It was found on inspection that the branch cut-out contained copper wire.

24. An ignorant workman installed a lighting circuit in lead-covered cable, fastening same to iron ceiling with staples. Breakdown of insulation of cable set fire to ceiling, when it was found that no main switch had been installed and current could not, therefore, be cut off.

25. Switch on electric-light circuit was mounted in dry-goods store at a point where draperies came in contact with it. Flash from same ignited draperies and fire spread rapidly to millinery and other inflammable material.

26. Breakdown of insulation on wires of lighting circuit in a fine residence set fire to woodwork inside partitions. Fire occurred at night, and owing to delay in sending in alarm and the distance from fire-department headquarters, fire was not extinguished until a heavy loss had been sustained.

27. Electric-light wire sagged and made contact with telephone wire running to cable box. Box and cable connections completely destroyed.

28. Burglar-alarm, electric-bell, and electric-light wires came together inside the partitions of a residence. The

insulation on the wires was ignited and fire followed up the partitions. Owing probably to lack of oxygen, fire did not break out of partitions, but spread so generally over the house inside that much damage had to be done before it could be extinguished.

29. Circuits were run in circular loom tubing immediately over a steel ceiling. Where the tubing came through the ceiling for a loop, the sharp edges of the ceiling cut through the same, short-circuiting the wires. Arc ignited the insulation of the wires, fire following same up under the ceiling.

30. Fire in livery stable due to blowing of fuse in uncovered cut-out into straw. Fire spread so rapidly that it was impossible for the department to control it.

31. Fire in basement of hotel caused by water leaking and running down the blades of a switch on 500-volt circuit.

32. Serious burn-out of a fire-alarm system by cross on 500-volt feed-wires of an electric railroad. Nine fire-alarm boxes, a tapper, and an indicator were burned out, the repeater also being partially destroyed. Fire was also started in the residence of the chief of the fire department, but was promptly extinguished. It was found on inspection that the instruments were protected by fuses that were much too short.

7. Figs. 1 to 6 illustrate some characteristic burn-outs; they have been drawn from photographs of burn-outs that have actually occurred.

Fig. 1 shows a gas pipe that was melted by an arc caused by a heavy current-carrying circuit crossing a signal circuit that was connected to the pipe. The connection to the pipe was poor and unsoldered.

Fig. 2 shows joints made with No. 10 wire on a circuit designed to carry 200 amperes. The use of such a poor joint gave rise to heating that resulted in the burning out of the wire.

Fig. 3 shows a fixture canopy with a hole melted through it, caused by a fixture cut-out inside the canopy becoming short-circuited.

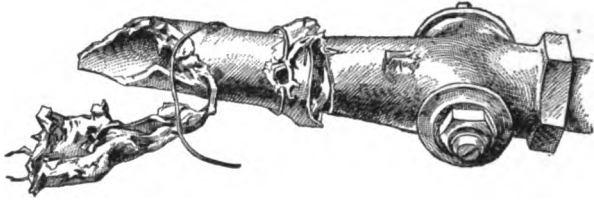

FIG. 1

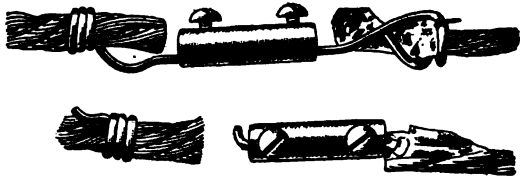

FIG. 2

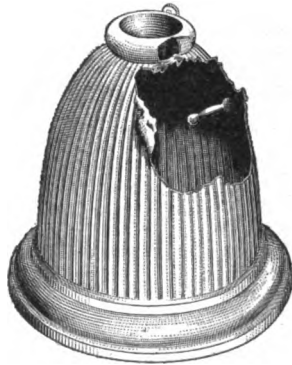

FIG. 3

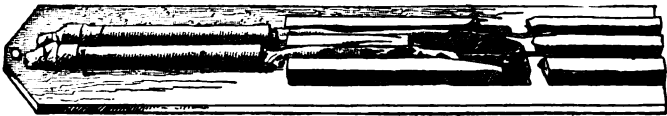

FIG. 4

Fig. 4 shows a burn-out caused by a short circuit between weather-proof wires used in molding. Wire with weather-proof insulation only should never be used in molding, and its use in molding is prohibited by the Underwriters.

Figs. 5 and 6 show burn-outs caused by short circuits in cut-outs. The burn-out in Fig. 5 was due to defective design,

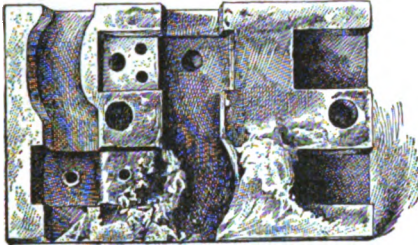

FIG. 5

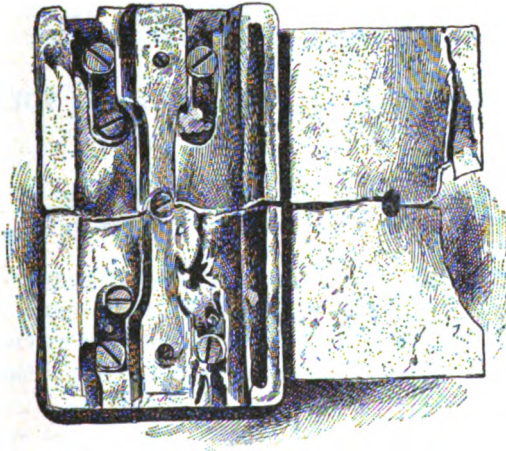

FIG. 6

the two sides of the circuit being brought so close together that when a fuse melted the arc held over and destroyed the cut-out.

In Fig. 6 the cut-out was placed horizontally. When the fuse melted, the metal ran down and established connection between the lines, thus resulting in a short circuit.

GENERAL RULES

8. In wiring for electric lights and power, there are certain rules that apply equally to all systems and voltages; these will be our first study. In what follows, rules and explanatory notes taken from the National Electrical Code are indented in order that they may be distinguished from the explanations and other matter. In most localities these rules have the force of laws. Many of the National Code rules deal with the construction of the various fittings used for interior wiring; these concern the manufacturers of the fittings rather than the workmen who install them. Most of the rules here given relate to the installation of appliances. Fittings given in the lists issued by the National Board of Fire Underwriters comply with their rules.

GENERAL RULES—ALL SYSTEMS AND VOLTAGES

Wires—

- a.* Must not be of smaller size than No. 14 B. & S., except in fixtures and flexible cords.

This is because wires of smaller size are likely to break or become loose, so that the work does not remain mechanically secure, and because a small wire is much more likely to be overloaded by connecting a few additional lamps to it than is a larger wire.

- b.* Tie-wires must have an insulation equal to that of the conductors they confine.

- c.* Must be so spliced or joined as to be both mechanically and electrically secure without solder; they must then be soldered to insure preservation, and the joint covered with an insulation equal to that on the conductors.

Stranded wires must be soldered before being fastened under clamps or binding screws, and

whether stranded or solid, when they have a conductivity greater than No. 8 B. & S. gauge, they must be soldered into lugs for all terminal connections.

All joints must be soldered, even if made with some form of patent splicing device. This ruling applies to joints and splices in all classes of wiring covered by these rules.

9. Whenever it is possible to avoid making joints, it is advisable to do so; but where joints are necessary, great care must be taken to do the soldering well, and to leave no corrosive acid on the wire.



FIG. 7

There are several soldering compounds now on the market that will tin the wire well enough to make a good joint and yet leave no acid on it. Soldering flux in the form of sticks is more convenient than liquid soldering fluid.



FIG. 8

Soldering Fluid.—

The following formula for soldering fluid is suggested:

Saturated solution of zinc chloride	5 parts
Alcohol	4 parts
Glycerine	1 part

10. Joints.—Figs. 7, 8, and 9 illustrate joints in common use.

In removing the insulation from the wires where joints or connections are necessary, and in scraping the wire to clean it before making the joint, great care must be exercised not to cut into the wire and lessen its cross-section and consequently, its carrying capacity. Especial care must be taken in handling

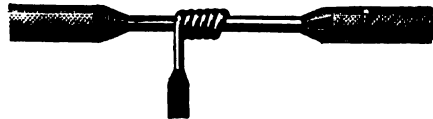
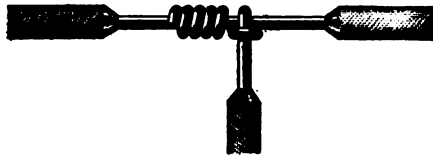

FIG. 9

fixture wires, which are small and easily cut or broken. A comparatively small nick in a copper wire will make it break easily.

In recovering the wire with insulating tape, a sufficient amount of tape must be used to afford ample protection. When rubber-covered wires are spliced or joined, two kinds of tape must be used, the first of pure rubber softened by a volatile oil, and the second of cloth saturated with a moisture-proof adhesive material.

11. Rules Relating to Wires (Continued).—

d. Must be separated from contact with walls, floors, timbers, or partitions through which they may pass by non-combustible, non-absorptive insulating tubes, such as glass or porcelain.

Bushings must be long enough to bush the entire length of the hole in one continuous piece, or else the hole must first be bushed by a continuous waterproof tube. This tube may be a conductor, such as iron pipe, but in that case an insulating bushing must be pushed into each end of it far enough to keep the wire absolutely out of contact with the pipe.

e. Must be kept free from contact with gas, water, or other metallic piping, or any other conductors or conducting material that they may cross, by some continuous and firmly fixed non-conductor, creating a separation of at least 1 inch. Deviations from this rule may sometimes be allowed by special permission.

When one wire crosses another wire, the best and usual means of separating them is by means of a porcelain tube on one of them. The tube should be prevented from moving out of place, either by a cleat at each end or by taping it securely to the wire.

The same method may be adopted where wires pass close to iron pipes, beams, etc., or, where the wires are above the pipes, as is generally the case, ample protection can frequently be secured by supporting the wires with a porcelain cleat placed as nearly above the pipe as possible.

f. Must be so placed in wet places that an air space will be left between conductors and pipes in crossing, and the former must be run in such a way that they cannot come in contact with the pipe accidentally. Wires should be run over, rather

than under, pipes on which moisture is likely to gather or which, by leaking, might cause trouble on a circuit.

g. The installation of electrical conductors in wooden molding or when supported on insulators in elevator shafts will not be approved, but conductors may be installed in such shafts if incased in approved metal conduits.

Underground Conductors—

a. Must be protected, when brought into a building, against moisture and mechanical injury, and all combustible material must be kept removed from the immediate vicinity.

b. Must not be so arranged as to shunt the current through a building around any catch box.

This refers to catch boxes in the street, from which the wires should run to the buildings, and not from street to building, building to building, and back again into the street, around one or more catch boxes, thus shunting whatever protective devices there may be in the catch boxes.

c. Where underground service enters building through tubes, the tubes shall be tightly closed at outlets with asphaltum or other non-conductor, to prevent gases from entering the building through such channels.

d. No underground service from a subway to a building shall supply more than one building except by written permission from the Inspection Department having jurisdiction.

12. Carrying Capacities of Wires.—As every wire carrying an electric current is somewhat heated, it is necessary to know how much current can safely be carried by a wire of a given size. Table I supplies this information.

Table of Carrying Capacity of Wires.—

The accompanying table (Table I), showing the allowable carrying capacity of wires and cables of 98 per cent. conductivity, according to the standard adopted by the American Institute of Electrical

TABLE I
CARRYING CAPACITY OF INSULATED WIRES

B. & S. Gauge	Rubber-Cov- ered Wires Amperes	Weather-Proof Wires Amperes	Circular Mils (Approximate)
18	3	5	1,624
16	6	8	2,583
14	12	16	4,107
12	17	23	6,530
10	24	32	10,380
8	33	46	16,510
6	46	65	26,250
5	54	77	33,100
4	65	92	41,740
3	76	110	52,630
2	90	131	66,370
1	107	156	83,690
0	127	185	105,500
00	150	220	133,100
000	177	262	167,800
0000	210	312	211,600
	200	300	200,000
	270	400	300,000
	330	500	400,000
	390	590	500,000
	450	680	600,000
	500	760	700,000
	550	840	800,000
	600	920	900,000
	650	1,000	1,000,000
	690	1,080	1,100,000
	730	1,150	1,200,000
	770	1,220	1,300,000
	810	1,290	1,400,000
	850	1,360	1,500,000
	890	1,430	1,600,000
	930	1,490	1,700,000
	970	1,550	1,800,000
	1,010	1,610	1,900,000
	1,050	1,670	2,000,000

Engineers, must be followed in placing interior conductors.

For insulated aluminum wire the safe carrying capacity is 84 per cent. of that given in the table for copper wire with the same kind of insulation.

The lower limit is specified for rubber-covered wires to prevent gradual deterioration of the high insulation by the heat of the wires, but not from fear of igniting the insulation. The question of drop is not taken into consideration in the above table.

The carrying capacity of Nos. 16 and 18 B. & S. gauge wire is given, but no wire smaller than No. 14 is to be used, except as allowed for fixture work and flexible cord.

13. Wire Gauges.—It sometimes happens that wires of scant size are sold to the unwary. A workman constantly using wires of various sizes soon learns to gauge the size of wires by his eye, but it is better to use a wire gauge frequently to avoid mistakes. A wire of given size should just enter the slot intended for that size in the style of gauge shown in Fig. 10. Gauges in the form of a vernier caliper, measuring the diameter of the wire in thousandths

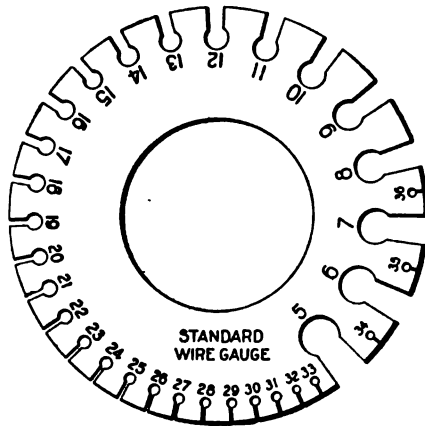

FIG. 10

of an inch, or mils,* are usually more accurate. Table II, giving the diameter in mils and cross-sectional area in

*Diameters of wires are usually expressed in mils or thousandths of an inch and cross-sectional areas in circular mils. 1 mil = $\frac{1}{1000}$ inch = .001 inch. 1 circular mil is equal to the area of a circle of which the diameter is 1 mil and cross-sectional areas of wires are designated by the number of circular mils contained in their area. The circular mil is a more convenient unit than the square inch in which to express the areas of round wires since the number of circular mils bears a simple relation to the diameter in mils. If the diameter d is expressed in mils, then the number of circular mils cross-section is d^2 . Thus, a No. 0000 wire, Table II, has a diameter of 460 mils, or .460 inch, and its area in circular mils is $460^2 = 211,600$. 1 square inch = 1,273,240 circular mils.

circular mils for the B. & S. sizes commonly used in interior-wiring work, is here inserted for convenient reference. The number of circular mils cross-section as given in this table is more accurate than in Table I, but the areas as given in Table I are close enough for all practical calculations.

TABLE II

DIMENSIONS OF BARE COPPER WIRE B. & S. GAUGE

Gauge Number	Diameter Mils	Area Circular Mils	Gauge Number	Diameter Mils	Area Circular Mils
0000	460.0	211,600.0	8	128.5	16,509.0
000	409.6	167,805.0	9	114.4	13,094.0
00	364.8	133,079.4	10	101.9	10,381.0
0	324.9	105,534.5	11	90.7	8,234.0
1	289.3	83,694.2	12	80.8	6,529.9
2	257.6	66,373.0	13	72.0	5,178.4
3	229.4	52,634.0	14	64.1	4,106.8
4	204.3	41,742.0	15	57.1	3,256.7
5	181.9	33,102.0	16	50.8	2,582.9
6	162.0	26,250.5	17	45.3	2,048.2
7	144.3	20,816.0	18	40.3	1,624.3

WIRING FOR LOW-POTENTIAL SYSTEMS

14. Definition of Low-Potential System.—

LOW-POTENTIAL SYSTEMS

550 Volts or Less

Any circuit attached to any machine or combination of machines that develops a difference of potential between any two wires of over 10 volts and less than 550 volts shall be considered as a low-potential circuit and as coming under this class, unless an approved transforming device is used that cuts the difference of potential down to 10 volts or less. The primary circuit not to exceed a potential of 3,500 volts.

Before pressure is raised above 300 volts on any previously existing system of wiring, the whole must be strictly brought up to all of the requirements of the rules at date.

Until recently, low-potential systems were limited to 300 volts or under, but the limit has been raised to 550. However, 550 volts cannot be applied to old systems unless the above rule is complied with. Low-potential systems are usually constant-potential systems also; that is, the potential or pressure between the terminals of the machine or at some definite points on the line is almost uniform. Only constant-potential systems will be considered under this heading.

A few general rules apply to the various kinds of work under these systems. They are as follows:

15. General Rules.—

Wires—

a. Must be so arranged that under no circumstances shall there be a difference of potential of over 300 volts between any bare metal in any distributing switch, cut-out cabinet, or equivalent center of distribution.

b. Must not be laid in plaster, cement, or similar finish and must never be fastened with staples.

c. Must not be fished for any great distance, and only in places where the inspector can satisfy himself that the rules have been complied with.

d. Twin wires must never be used, except in conduits or where flexible conductors are necessary.

e. Must be protected on side walls from mechanical injury. When crossing floor timbers in cellars or in rooms where they might be exposed to injury, wires must be attached by their insulating supports to the under side of a wooden strip not less than $\frac{1}{2}$ inch in thickness and not less than 3 inches in width. Instead of the running boards, guard strips on each side of and close to the wires will be accepted. These strips to be not less than $\frac{1}{2}$ inch in thickness, and at least as high as the insulators.

Suitable protection on side walls may be secured by a substantial boxing, retaining an air space of 1 inch around the

conductors, closed at the top (the wires passing through bushed holes), and extending not less than 5 feet from the floor; or by an iron-armored or metal-sheathed insulating conduit sufficiently strong to withstand the strain to which it will be subjected, and with the ends protected by the lining or by special insulated bushings, so as to prevent the possibility of cutting the wire insulation; or by plain metal pipe, lined with approved flexible tubing, which must extend from the insulator next below the pipe to the one next above it.

If metal conduits or iron pipes are used to protect wires carrying alternating currents, the two or more wires of each circuit *must* be placed in the same conduit as troublesome induction effects and heating of the pipe might otherwise result. And the insulation of each wire must be reinforced by approved flexible tubing extending from the insulator next below the pipe to the one next above it. This should also be done in direct-current wiring if there is any possibility of alternating current ever being used on the system.

For high-voltage work, or in damp places, the wooden boxing may be preferable, because of the precautions that would be necessary to secure proper insulation if the pipe were used. With these exceptions, however, iron pipe is considered preferable to the wooden boxing, and its use is strongly urged. It is especially suitable for the protection of wires near belts, pulleys, etc.

f. When run in unfinished attics, or in proximity to water tanks or pipes, will be considered as exposed to moisture.

16. The reason for the first part of (*b*) is that plaster and cement are likely to corrode the insulation on the wire and cause it finally to break. If the plaster is damp, leakage takes place, the wire is gradually dissolved by electrolysis, and finally it becomes so thin it cannot carry its current without excessive heating and, perhaps, not without melting. While there are many places where wires embedded in plaster have been used for years without serious trouble, because of the dryness of the buildings where they are in use, trouble may develop at any time and the practice is always a dangerous one.

The second part of (*b*) is inserted as a direct prohibition against running electric-light wires as bell wires are usually put up. Staples not only do not insulate the wire, but are likely to cut into the insulating covering already on it. Rule (*c*) is to prevent the location of wires where it is impossible to know that they are properly supported and insulated.

17. The suggestions regarding the protection of wires on side walls or other places where they are liable to be damaged, should be carefully noted. In interior wiring, one of the chief sources of risk is the currents that may flow from the wiring to ground if the insulation becomes defective. The danger from leakage currents either from wire to wire or from wires to ground is fully as great if not greater than that from overloaded wires or from actual short circuits between wires.

SYSTEMS OF DISTRIBUTION FOR INTERIOR WIRING

18. The voltages in common use on low-potential systems are: For direct currents, 110 and 220; for alternating currents, 104 to 110. These are used on both two-wire and three-wire systems. Many lighting companies allow for various amounts of drop at different points on their lines and install lamps of different voltages, as, for instance, 108-volt lamps near the generator and 100-volt lamps at the extreme end of the line, with lamps of intermediate voltages at intermediate points. But the lamps used in any one building are usually all of the same voltage.

19. **The Two-Wire System.**—This is the simplest plan of wiring and the one in most general use. Fig. 11 shows in diagram its essential features. The diagram of connections is the same for all voltages and for alternating or

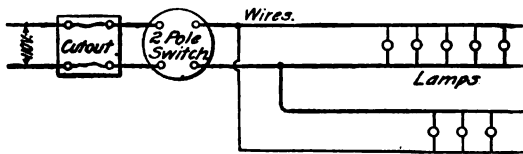

FIG. 11

direct currents; but the fittings, such as lamps, sockets, cut-outs, and switches, and the sizes of wire used will be very different. The fittings and the proper sizes of wire to be used will be discussed later.

20. The Edison Three-Wire System.—This system comes next in importance and extent of use; it also is used with various voltages and with direct or alternating currents. Usually the pressures are 110 volts between either outer wire and the middle or **neutral** wire and 220 volts between the outer wires. Fig. 12 shows the diagram of connections. This system is also sometimes installed with 220 volts between the neutral and outer wires and 440 volts between the outside wires.

Referring to the diagram, Fig. 12, observe the following: When the currents in the two outside wires are equal in amount, no current passes over the neutral wire; but when

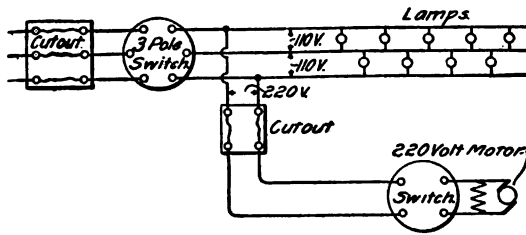

FIG. 12

the currents are not equal, that is, when more lamps or motors are on one side of the neutral wire than on the other, the "difference current" flows on the middle wire.

21. The advantage of this system is that with lamps of any given voltage it is possible to save in the amount of wire required. In the outside lines of the lighting company is where the greatest saving is effected, because the neutral wire is there much smaller than the outer ones, and three wires are used instead of four, which would have to be run if the generators were operated independently. In interior wiring, the saving is not so great, because the neutral wire must be large enough to carry the current in case all the load is turned off one side of the circuit, as would be the case if the fuse on one side should blow and that on the other side did not, and because in small installations, where unbalancing is likely to occur, three-wire mains must be large to reduce this trouble to a minimum.

22. The three-wire system also has some disadvantages. Its most objectionable feature is that if any one line is opened, as by the blowing of a fuse on one line only, the system is unbalanced and a voltage different from that intended for the apparatus is thrown on the lines, unless the line loss is very small indeed. If it is the middle wire that opens, the whole 220 volts may be thrown on 110-volt apparatus, if the system is much unbalanced. For this reason, some Edison companies refuse to place cut-outs on the neutral wire; but the main switch should in all cases open all three lines. Another weakness of the three-wire system is the fact that there is more danger in 220 volts than in 110, and a shock received from a 220-volt circuit may be very severe. The wiring is somewhat more complicated, but owing to the saving in line materials,

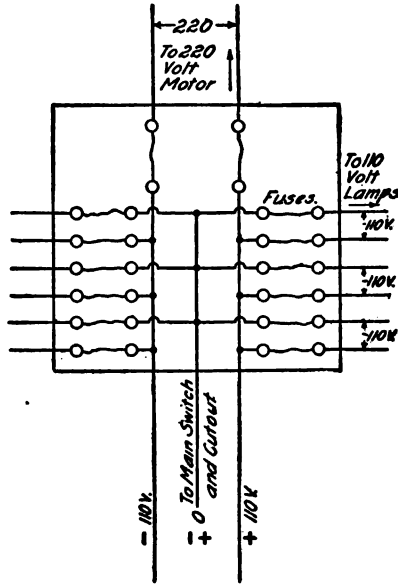

FIG. 13

the Edison three-wire system has been introduced to a very great extent and still meets with much favor in new installations, besides extending the network of its wires from existing stations. Lately it has had a new competitor in the 220-volt two-wire system, which has grown in popularity with the perfecting of the 220-volt incandescent lamp.

23. It is the usual practice to run the three wires no farther within the building than to the centers of distribution, and from these centers to use the two-wire system, dividing the circuits as equally as possible on the two sides of the three-wire circuit, as shown in Fig. 13. By this

means, the branch lines are fused on both sides and amply protected against excessive currents, though not against high voltage. If the neutral wire within the building is protected by a fuse as large as that in either of the main wires, the danger of that line opening is very small.

24. A method of running wires on the two-wire plan that is sometimes confused with the three-wire system is illustrated in Fig. 14. In this method the middle wire carries the whole current, while each outside wire carries the current necessary for the lights on its side. This method effects no saving of copper; in fact, it often requires more than the two-wire system would, because the three wires must generally be of the same size, as explained under the subject of cut-out protection. The object of the arrangement is solely to make it possible to turn off a number of the lights without running four wires. The Underwriters will not permit it with more than 660 watts on a side.

25. House wiring should consist of two distinct portions: the **distribution circuits**, which run from the lamps to a **center of distribution** and which should always be two-wire circuits, and the **mains**, which run from the outside lines to the distribution center and which must conform to the requirements of the particular system to be used. If

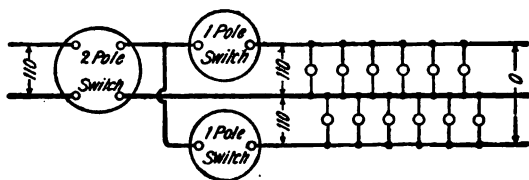

FIG. 14

mains must be installed before it is known what system is to supply current, it will be sufficient to run four wires of the size required were the lamps to be divided equally between two separate two-wire systems. This will make it possible to connect to any system operating at the voltage for which the wiring calculations are made.

SWITCHES AND CUT-OUTS

26. There are certain devices for the protection of constant-potential systems that are necessary no matter what voltage is used. Should anything happen to damage the wiring, it is necessary that the wires be disconnected from the source of supply of current with the least possible delay. The devices for this purpose that are operated by hand are called **switches**. Those that work automatically are called **automatic cut-outs**. These latter are of two kinds—**fuses and circuit-breakers**.

Both a switch and an automatic cut-out must be placed at or near the place where wires enter a building. They must also be placed at various other points on the wiring.

27. The object of the cut-out is to protect the wires and the devices connected to them from damage due to the presence of too much current from any cause whatever. The ordinary cut-out consists of a porcelain base that carries suitable terminals for holding a piece of fusible wire, or fuse, which melts and opens the circuit whenever the current becomes excessive. Not only must the cut-out protect the lines when there is trouble, but it must be so placed that it can be reached to replace the fuse or reset the circuit-breaker when the trouble is remedied. It must also be arranged so that the blowing of a fuse or the opening of a circuit-breaker cannot do any damage.

28. Switches are designed to disconnect the lines from the source of electricity, not only when there is trouble, but when convenience requires, as in turning off lights, starting and stopping motors.

Circuit-breakers are not as commonly used in interior-wiring work as are fusible cut-outs. They are automatic switches controlled by an electromagnet and are made in a number of different styles. Whenever the current exceeds

that for which the circuit-breaker is adjusted, the electro-magnet attracts its armature and releases the switch, thus opening the circuit.

The following rules regarding these devices must be observed in all cases:

Switches, Cut-Outs, Circuit-Breakers, Etc.—

a. Must, whenever called for, unless otherwise provided, be so arranged that the cut-outs will protect, and the opening of the switch or circuit-breaker will disconnect, all the wires; that is, in a two-wire system the two wires, and in a three-wire system the three wires, must be protected by the cut-out and disconnected by the operation of the switch or circuit-breaker.

b. Must not be placed in the immediate vicinity of easily ignitable stuff or where exposed to inflammable gases or dust or to flyings of combustible material.

In starch and candy factories, grain elevators, flouring mills, and buildings used for woodworking or other purposes that would cause the fittings to be exposed to dust and flyings of inflammable material, the cut-outs and switches should be placed in approved cabinets outside of the dust rooms. If, however, it is necessary to locate them in the dust rooms, the cabinets must be dust-proof and must be provided with self-closing doors.

c. Must, when exposed to dampness, either be enclosed in a waterproof box or mounted on porcelain knobs.

d. Time switches must be enclosed in an iron box, or cabinet lined with fire-resisting material.

If an iron box is used, the minimum thickness of the iron must be .128 inch (No. 8 B. & S. gauge).

If cabinet is used, it must be lined with marble or slate at least $\frac{3}{8}$ inch thick, or with iron not less than .128 inch thick. Box or cabinet must be so constructed that when switch operates, blade shall clear the door by at least 1 inch.

Automatic Cut-Outs (Fuses and Circuit-Breakers)

Excepting on main switchboards, or where otherwise subject to expert supervision, circuit-breakers will not be accepted unless fuses are also provided.

a. Must be placed on all service wires, either overhead or underground, as near as possible to the

point where they enter the building and inside the walls, and arranged to cut off the entire current from the building.

Where the required switch is inside the building, the cut-out required by this section must be placed so as to protect it.

In risks having private plants, the yard wires running from building to building are not generally considered as service wires, so that cut-outs would not be required where the wires enter buildings, provided that the next fuse back is small enough to properly protect the wires inside the building in question.

b. Must be placed at every point where a change is made in the size of wire (unless the cut-out in the larger wire will protect the smaller).

29. The object of a fusible cut-out is to protect the wire; therefore, it must be placed so that all the current that flows through the wire to be protected will also pass through the cut-out. The fuse is proportioned so that its carrying capacity will not exceed the carrying capacity of the wire, as given in Table I; hence, if an excessive current flows, the fuse will melt and open the circuit before the wire becomes overheated. If a branch wire, say No. 14, were connected to a main, say No. 10, and if no cut-out were placed at the junction, it is plain that, since the fuse in the No. 10 wire has a carrying capacity in excess of that allowed for No. 14, a short circuit or overload on the branch line might cause overheating of the No. 14 wire. Very often, however, the fuse in the larger wire is of such size that it protects the smaller wire, in which case it is not necessary to place a fuse at the junction point. For example, take the case where No. 14 wire at a fixture outlet is attached to the fixture wiring. The wire in the fixture is usually No. 16 or No. 18 in order that it may pass between the gas pipe and the outer shell, but the fuse in the cut-out or on the panel board at the distributing center is proportioned in accordance with the carrying capacity of the fixture wire instead of the No. 14 wire running from the panel board or cut-out to the fixture; hence, in this case the fuse in the larger wire protects the smaller wire and a cut-out in the

fixture canopy where the fixture wire attaches to the No. 14 lines is unnecessary; in fact, fixture cut-outs are prohibited by rule (c) given below.

c. Must be in plain sight or enclosed in an approved cabinet and readily accessible. They must not be placed in the canopies or shells of fixtures.

The ordinary porcelain link-fuse cut-out will not be approved. Link fuses may be used only when mounted on approved slate or marble bases and must be enclosed in dust-tight, fireproof cabinets, except on switchboards located well away from combustible material, as in the ordinary engine and dynamo room where these conditions will be maintained.

30. Rule (c) is important. It prohibits the use of the small cut-outs that were formerly placed in the canopies of fixtures in order to protect the fixture wiring. These cut-outs gave a great deal of trouble and introduced a fire risk that more than offset any advantage they might have had. It has been found safer and more satisfactory, therefore, to omit them and let the fuse in the cut-out on the branch main leading to the fixture afford the protection, as explained under rule (b).

It should also be noted that this rule prohibits the use of the ordinary porcelain link-fuse cut-outs that were, until recently, very largely used for the protection of circuits. The link fuse consists of a piece of fuse wire or strip provided with copper terminals, the fuse wire or strip being exposed to the air. These fuses were held between suitable terminals mounted on a porcelain base. The use of link fuses is still permitted when they are mounted on slate or marble distributing boards and placed in fireproof cabinets, but the link-fuse porcelain cut-out is no longer permitted and it is now necessary to use enclosed fuses instead. Enclosed fuses and link fuses will be described in detail when fittings are taken up.

d. Must be so placed that no set of incandescent lamps requiring more than 660 watts, whether grouped on one fixture or on several fixtures, or

pendants, will be dependent on one cut-out. Special permission may be given in writing by the Inspection Department having jurisdiction for departure from this rule in the case of large chandeliers, stage borders, and illuminated signs.

The above rule shall also apply to motors when more than one is dependent on a single cut-out.

The idea is to have a small fuse to protect the lamp socket and the small wire used for fixtures, pendants, etc. It also lessens the chances of extinguishing a large number of lights if a short circuit occurs.

On open work in large mills, approved link-fused rosettes may be used at a voltage of not over 125, and approved enclosed-fused rosettes at a voltage of not over 250, the fuse in the rosettes not to exceed 3 amperes, and a fuse of over 25 amperes must not be used in the branch circuit.

All branches, or taps, from a three-wire Edison system must be run as two-wire circuits.

31. Rule (*d*) is very important because it limits the number of lamps that may be operated on any one circuit. On 110-volt circuits, 660 watts is equivalent to not more than twelve 16-candlepower lamps; on 220-volt circuits not more than ten 16-candlepower lamps. It is best not to exceed ten lamps to a circuit except in the special cases mentioned in the rule. The fused rosettes referred to under rule (*d*) are small porcelain cut-outs from which the lamps are suspended. It should be particularly noted that these rosettes are not allowed on pressures higher than 125 volts unless they are provided with enclosed fuses.

Rule (*d*) also applies to motors when more than one motor is dependent on a single cut-out. This refers particularly to fan motors, as most motors for power purposes will be over 660 watts capacity and each motor will therefore require a branch circuit and cut-out of its own.

e. The rated capacity of fuses must not exceed the allowable carrying capacity of the wire. Circuit-breakers must not be set more than 30 per cent. above the allowable carrying capacity of the wire, unless a fusible cut-out is also installed in the circuit.

This is very important. A fuse block not properly fused is of no use whatever. Irresponsible parties sometimes place fuses much too large to protect the wire and which

would destroy the cut-out if they should ever blow, besides doing other damage. Sometimes, also, fuse blocks are found having copper wire where the fuses should be; of course, they are of no use with such connections. The common custom of fusing with wire much larger than that allowable is one of the reasons for the prohibition of link-fuse porcelain-base cut-outs. The bases used with enclosed fuses are not easily fused with any wire that may be convenient because the terminals are not suited to a wire fuse. Note that rule (e) fixes the maximum size of fuse to be used on any circuit by the carrying capacity of the wire protected and not by the current required for operating the devices used on the circuit. For example, the carrying capacity of a No. 14 rubber-covered wire is 12 amperes and the rated capacity of the fuse used on a No. 14 circuit could be as high as 12 amperes without breaking the rule, though there might only be ten 110-volt lamps on the circuit requiring a current of about 5 amperes for their operation.

Cut-outs should always be installed in a location where they can be easily reached for the replacement of fuses. This is a point too often neglected in the laying out of interior wiring, particularly for small houses where regular distributing panel boards are not used.

When arc lamps are operated on constant-potential circuits, each lamp must be provided with a cut-out and the branch conductors leading from the mains to the lamps should have a carrying capacity about 50 per cent. in excess of the normal current in order to allow for the increased current required when the lamp is started or when the carbons become stuck. If each lamp is not fed by a separate branch circuit running from a panel board or fuse cabinet, it is necessary to locate an enclosed-fuse cut-out at the point where the wires leave the mains for a lamp.

32. Circuit-breakers may be set so as to work with greater accuracy than fuses; they respond more quickly to sudden overloads, for fuses require a little time to get hot enough to melt. For this reason, circuit-breakers may

be set for higher currents than fuses. If they are not so set, they will give trouble by opening the circuit on momentary overloads that would not be sufficient to melt the fuses. Circuit-breakers are usually installed to protect machines, such as motors and dynamos; they are not used for the protection of the branch distribution circuits in buildings because the rules require that they shall only be used in such places where they will at all times be under expert supervision.

33. Rules Relating to Switches.—

Switches—

a. Must be placed on all service wires, either overhead or underground, in a readily accessible place, as near as possible to the point where the wires enter the building, and arranged to cut off the entire current.

Service cut-out and switch must be arranged to cut off current from all devices, including meters.

In risks having private plants, the yard wires running from building to building are not generally considered as service wires, so that switches would not be required in each building if there are other switches conveniently located on the mains or if the generators are near at hand.

b. Must always be placed in dry, accessible places and be grouped as far as possible. Knife switches must be so placed that gravity will tend to open rather than close them.

When possible, switches should be so wired that blades will be "dead" when switch is open.

If knife switches are used in rooms where combustible flyings would be likely to accumulate around them, they should be enclosed in dust-tight cabinets. Even in rooms where there is no combustible material it is better to put all knife switches in cabinets, in order to lessen the danger of accidental short circuits being made across their exposed metal parts by careless workmen.

Up to 250 volts and 30 amperes, approved indicating snap switches are advised in preference to knife switches on lighting circuits about the workrooms.

c. Must not be single-pole when the circuits that they control supply devices that require over 660 watts of energy or when the difference of potential is over 300 volts.

This rule (*c*) is important, because it restricts so severely the number of lamps that may be controlled by a single-pole switch.

d. Where flush switches are used, whether with conduit systems or not, the switches must be enclosed in boxes constructed of or lined with fire-resisting material. No push buttons for bells, gas-lighting circuits, or the like shall be placed in the same wall plate with switches controlling electric-light or power wiring.

This requires an approved box in addition to the porcelain enclosure of the switch.

e. Where possible, at all switch or fixture outlets, a $\frac{1}{2}$ -inch block must be fastened between studs or floor timbers, flush with the back of lathing, to hold tubes and to support switches or fixtures. When this cannot be done, wooden base blocks not less than $\frac{1}{2}$ inch in thickness, securely screwed to the lathing, must be provided for switches and also for fixtures that are not attached to gas pipes or conduit tubing.

34. Construction of Cut-Outs, Circuit-Breakers, Etc.—The rules that have just been given relate to the location and installation of cut-outs, circuit-breakers, switches, etc. In addition to these rules there are a large number of Underwriters' rules that relate to the construction of these devices, but for the most part these concern the manufacturer rather than the wireman. A few only of the more important of these rules will be given here as a general guide to the wireman.

Cut-Outs and Circuit-Breakers—

a. Must be supported on bases of non-combustible, non-absorptive, insulating material.

b. Cut-outs must be of plug or cartridge type, when not arranged in approved cabinets, so as to obviate any danger of the melted fuse metal coming in contact with any substance that might be ignited thereby.

c. Cut-outs must operate successfully on short circuits, under the most severe conditions with which they are liable to meet in practice, at 25 per cent. above their rated voltage, and with fuses rated at 50 per cent. above the current for which the cut-out is designed.

d. Circuit-breakers must operate successfully on short circuits, under the most severe conditions with which they are liable to meet in practice, when set at 50 per cent. above the current, and with a voltage 25 per cent. above that for which they are designed.

e. Must be plainly marked, where it will always be visible, with the name of the maker and the current and voltage for which the device is designed.

Snap Switches.—

a. Current-carrying parts must be mounted on non-combustible, non-absorptive, insulating bases, such as slate or porcelain, and the holes for supporting screws should be countersunk not less than $\frac{1}{8}$ inch; in no case must there be less than $\frac{3}{4}$ inch space between supporting screws and current-carrying parts.

Subbases, of non-combustible, non-absorptive insulating material, that will separate the wires at least $\frac{1}{2}$ inch from the surface wired over should be furnished for all snap switches used in exposed knob or cleat work.

b. Covers made of conducting material, except face plates for flush switches, must be lined on their sides and top with insulating, tough, and tenacious material at least $\frac{1}{4}$ inch in thickness, firmly secured, so that it will not fall out with ordinary handling. Side lining should extend slightly beyond the lower edge of the cover.

c. The handle, button, or any exposed part must not be in electrical connection with the circuit.

Switches that indicate, upon inspection, whether the current be "on" or "off" are recommended.

Some of the common styles of switches and cut-outs will be described later when the methods of wiring are taken up.

OPEN WORK IN DRY PLACES

35. Open work is generally used in factories, warehouses, mills, and other places where there is no objection to having the wires in plain sight, or in old buildings, where the expense of concealed work overbalances the objectionable appearance in the mind of the owner. It is the cheapest kind of construction and very often the safest. This method of wiring will be explained by means of simple examples.

SIMPLE EXAMPLE OF FACTORY WIRING

36. Consider a factory, such as a long machine shop, where there is but one floor to be wired for 110-volt enclosed-arc lamps and incandescent lamps on the so-called tree system; that is, with but one set of mains or feeder wires leaving the dynamo and with other lines branching from these mains to the points where lamps are required.

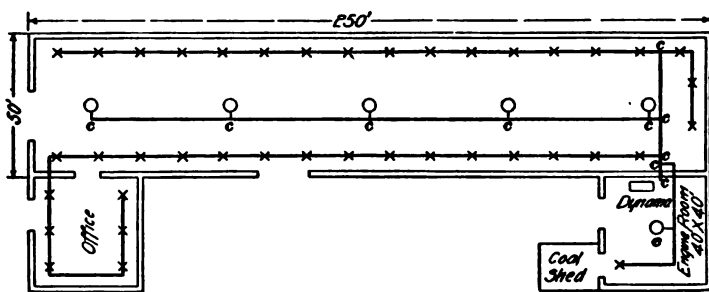

FIG. 15

Let Fig. 15 represent the outlines of such a factory, in which incandescent lamps are to be hung on lamp cord at the points marked \times and enclosed-arc lamps are to be placed where the marks \circ are shown. After finding the cheapest way in which this factory can be wired in order to satisfy

the Underwriters, we will see what modifications can be made to better the light, improve the system, and make it more convenient and economical in operation.

37. Assume that each 16-candlepower incandescent lamp requires 55 watts; some good lamps take less power, but it is not safe to count on less. Also assume that each enclosed arc is to take 5 amperes while burning and 12 amperes to start on. There are 40 incandescent lamps and 6 arc lamps to be wired.

$$55 \text{ (watts)} \div 110 \text{ (volts)} = .5 \text{ (ampere per lamp)}$$

$$40 \times .5 = 20 \text{ (amperes for incandescent lamps)}$$

$$6 \times 5 = 30 \text{ (amperes for arc lamps)}$$

$$\text{Total amperes} = \underline{50}$$

which must be carried on the mains for a short distance at least.

Referring to Table I, we see that the smallest wire that will carry 50 amperes with safety is No. 6 weather-proof.

38. Rules Relating to Wires for Open Work.—For open work in dry places we have in addition to the general rules relating to wires, the following special rules regarding wires used in open work:

Wires—

a. Must have an approved rubber or “slow-burning” weather-proof insulation.

b. Must be rigidly supported on non-combustible, non-absorptive insulators that will separate the wires from each other and from the surface wired over in accordance with the following table:

Voltage	Distance From Surface Inch	Distance Between Wires Inches
0 to 300	$\frac{1}{2}$	$2\frac{1}{2}$
300 to 500	1	4

Rigid supporting requires under ordinary conditions, where wiring along flat surfaces, supports at least every $4\frac{1}{2}$ feet. If the wires are liable to be disturbed, the distance between supports should be shortened. In buildings of mill construction, mains of No. 8 B. & S. wire or over, where not liable to be disturbed, may be separated about 4 inches and run from timber to timber, not breaking around, and may be supported at each timber only.

This rule will not be interpreted to forbid the placing of the neutral of a three-wire system in the center of a three-wire cleat, provided the outside wires are separated $2\frac{1}{4}$ inches.

39. Rubber-covered wire used for interior-wiring work consists of a tinned copper wire with a covering of rubber with an outer braiding of cotton soaked in preservative compound. For voltages up to 600 and for sizes of wire from No. 15 to No. 0000 the thickness of insulation varies from $\frac{3}{16}$ inch to $\frac{5}{16}$ inch, being thinner on the smaller sizes of wire.

40. Slow-burning weather-proof wire is less expensive than rubber-covered and is good enough for open work in dry places where the wire is in contact with insulating supports only, as in the case with the example of factory wiring now under consideration. This wire is provided with two coatings, one of which is fireproof in character and the other weather-proof. Most of this wire was formerly made with weather-proof braid on the outside, but the Underwriters now require the fireproof braid to be placed on the outside, and the compound with which it is treated slicked down so that the wire will have a hard, dense finish. The Underwriters lay down specifications to which the various kinds of wire must conform. Wire obtained from almost any reputable manufacturer meets the requirements, so it will not be necessary to give the specifications here.

Owing to the fact that ordinary weather-proof wire and fireproof and weather-proof are much cheaper than rubber-covered, there is a tendency on the part of the unscrupulous contractors to use these wires in places where rubber-covered wire only should be used. They are not allowable for concealed work or for open work where dampness is present. Fireproof and weather-proof wire is not so liable to burn as the old weather-proof, which had but one or more braidings

soaked in weather-proof compound, and it is able to repel the ordinary amount of moisture found indoors. It is not suitable for outside line work. In general, fireproof and weather-proof wire can be used only in those cases where the insulating supports on which the wire is mounted are depended on for insulation, the covering being regarded simply as a precaution against accidental contact with other wires or any other objects. With rubber-insulated wire, the covering may in some cases be depended on altogether for the requisite insulation, as, for example, where the wires constituting the two sides of a circuit are drawn through a system of pipes or conduits.

41. Determination of Sizes of Wire According to Current Capacity.—Observing the location of the lamps as shown in the diagram, Fig. 15, it is seen that on each side of the building and down the center they are arranged in straight lines. Therefore, it will be easier to run the wires along these lines and to fasten the rosettes (small porcelain fittings from which the lamps are suspended) directly to them, rather than put in short branch lines and run the principal wires in any other way. The wires will therefore be as shown in the sketch, where each line is supposed to represent a pair of wires put up on knobs or cleats.

Eighteen incandescent lamps are on one line, twenty-one on another, five arc lamps on a third, and one arc lamp and one incandescent lamp on a fourth. Referring again to Table I, we find that these lines will require wires of the following sizes: Twenty-one incandescent lamps (10.5 amperes), No. 14 wire; eighteen incandescent lamps (9 amperes), No. 14 wire; five arc lamps (25 amperes), No. 10 wire; one arc lamp and one incandescent lamp (5.5 amperes), No. 14 wire.

42. Location of Cut-Outs.—Since not more than 660 watts can be dependent on one cut-out, if we lay out the wiring as stated thus far it will be necessary to have fuses in all the rosettes and also a separate cut-out *c* at each arc lamp. There must also be a cut-out at the point where

each branch line joins the mains. The small wires running from the cut-outs to the arc lamps may be No. 14, which is large enough to carry the starting current of 12 amperes continually, if necessary. The main switch and cut-out should be located near the dynamo in the engine room. The wiring as now laid out, if put up properly, will comply with all the Underwriters' rules, but it will not necessarily give satisfaction; it will merely be safe. But before entering on the matter of how to improve the plan of the wiring, we will consider some of the fittings and methods of work that should be used on an installation of this kind.



FIG. 19

FITTINGS USED FOR EXPOSED WIRING

43. Open work must always be put up as though there were no insulation whatever on the wires themselves. The wires must be supported on insulators so as not to come

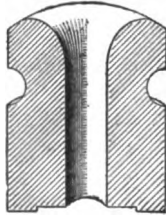

FIG. 16



FIG. 17

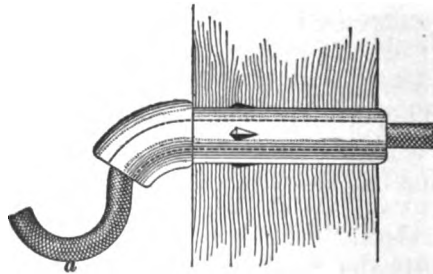

FIG. 18

into contact with any woodwork, pipes, or any other thing except insulating supports.

44. Fittings for Supporting Wire.—Some varieties of porcelain fittings suitable for this kind of work are shown in Figs. 16 to 25, inclusive. Fittings quite different in design may be used if they comply with the rules.

Fig. 16 shows an ordinary porcelain knob, in section; these are made in various sizes, and the size used will depend somewhat on the size of wire to be accommodated.

Fig. 17 shows the common, 4-inch, porcelain tube used where wires are run through joists. Fig. 18 is the style of tube used where wires are brought through window frames from the outside. The end is curved downwards to prevent water running in, and the *drip loop a* is formed to allow the water to drip off. A similar tube, only longer, is used for bringing wires in through brick or stone walls. Fig. 19 is a long, straight, porcelain tube used for passing through walls or floors.

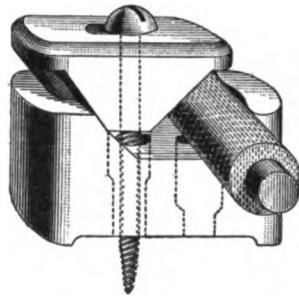

FIG. 20

Note that the head *a* is some distance from the end, so that when the tube is used for carrying wires through floors the exposed part of the wire will be above the floor.

Fig. 20 is a single-wire cleat, used mostly for supporting fairly large wires. Fig. 21 shows a two-wire cleat designed to

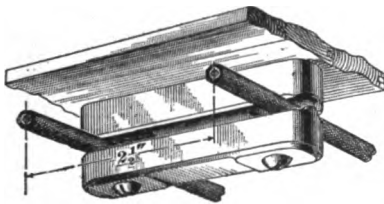

FIG. 21

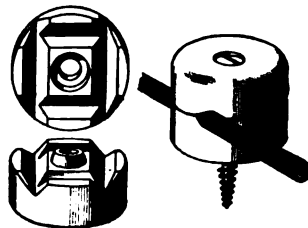

FIG. 22

support the wires $2\frac{1}{2}$ inches apart, in order to conform with the Underwriters' requirements. Many other cleats are made, but they are much the same in general construction. It is always best to put up cleats and knobs with screws, as a

better job is done than when nails are used; nails are, however, sometimes used, a leather washer being placed between the nail head and the porcelain, to prevent the latter from being cracked. Fig. 22 is a knob cleat used for supporting

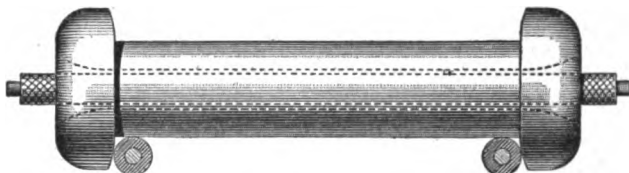

FIG. 22

single wires where something neater than the ordinary knob is desired. It does away with the necessity of a tie-wire and is provided with four different sized grooves so that it

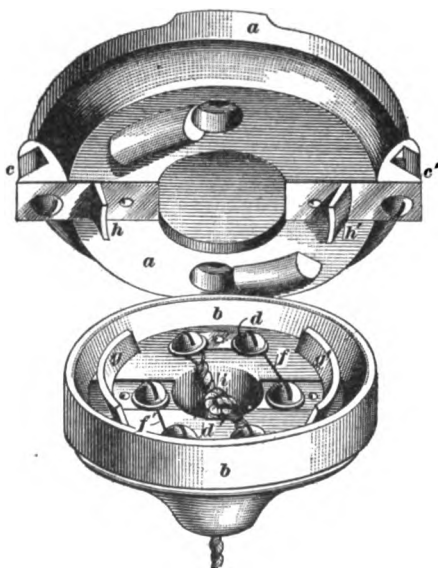

FIG. 24

will accommodate wires of various thicknesses. Fig. 23 shows a double-headed tube used when wires cross each other. Porcelain tubes should always be used where crossings of this kind occur. The tube shown in Fig. 17 is frequently used for this purpose; but if this is done, the end without a head should be taped to the wire to prevent the tube sliding along.

Fig. 24 shows a fused rosette or ceiling cut-out made in two parts,

a and *b*. Part *a* is screwed to the ceiling and the lamp is hung from the cap *b*. The lines are attached to the terminals *c, c'* and the lamp cord to *d, d'*; *f, f'* are the small fuses. When the cover *b* is attached to *a* by a twisting movement, terminals *g, g'* lock with *h, h'* and make the

connection from the mains to the lamp. The cord should be knotted at *i* so that the pull will not come on the connections *d*, *d'*. Rosettes with link fuses, as shown in Fig. 24, must not be used on pressures over 125 volts or for more than 3 amperes. They must not be located where inflammable flyings or dust will accumulate on them and the next fuses back of them must not be of over 25 amperes capacity, as the rosettes cannot safely break large currents. Fused rosettes are not advised where drop cords can be properly protected by line cut-outs. With the layout shown in Fig. 15, it will be necessary to use fused rosettes for the incandescent lamps. Cut-outs of the plug or cartridge type would be necessary for the arc lamps because the current for each lamp exceeds the maximum of 3 amperes allowed for the rosettes.

45. For such work as is now being considered, the principal porcelain articles required are the cleat, the rosette, and the cut-out, all of which are made in several forms. The selection of such fittings must be made with reference to the work in hand.

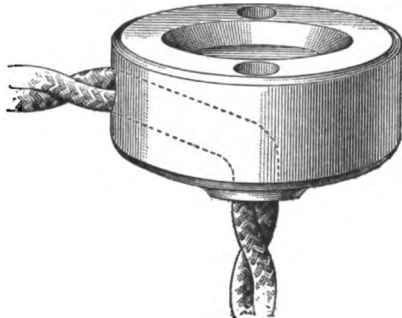

FIG. 25

If the wires are placed high out of reach and the distance between the points of support is considerable, they should be separated a foot or more and fastened to knobs. Where passing through walls or partitions, the wires should be protected by porcelain bushings.

If a lamp is needed not more than 3 feet from the direct line of the wires, it can be hung where required by means of a **ceiling button**, Fig. 25; but lamp cord must not be used to run lamps in this way more than 2 or 3 feet from the rosette.

46. **Flexible Lamp Cord.**—In selecting lamp cord for this kind of work and in securing good sockets, too much

care cannot be taken, for trouble occurs more frequently in lamp cord and sockets than in any other part of the wiring, if these articles are not of the highest grade. There is much temptation to use lamp cord for purposes other than those for which it is designed. The rules regarding it are given here, and special attention is directed to them:

Flexible Cord—

- a.* Must have an approved insulation and covering.
- b.* Must not be used where the difference of potential between the two wires is over 300 volts.
- c.* Must not be used as a support for clusters.
- d.* Must not be used except for pendants, wiring of fixtures, and portable lamps or motors, and portable heating apparatus.

The practice of making the pendants unnecessarily long and then looping them up with cord adjusters is strongly advised against. It offers a temptation to carry about lamps that are intended to hang freely in the air, and the cord adjusters wear off the insulation very rapidly.

For all portable work, including those pendants that are liable to be moved about sufficiently to come in contact with surrounding objects, flexible wires and cables especially designed to withstand this severe service are on the market and should be used.

The standard socket is threaded for $\frac{1}{8}$ -inch pipe, and if it is properly bushed, the reenforced flexible cord will not go into it; but this style of cord may be used with sockets threaded for $\frac{3}{8}$ -inch pipe and provided with substantial bushings. The cable is to be supported, independent of the overhead circuit, by a single cleat, and the two conductors then separated and soldered to the overhead wires.

The bulb of an incandescent lamp frequently becomes hot enough to ignite paper, cotton, and similar readily ignitable materials, and in order to prevent it from coming in contact with such materials, as well as to protect it from breakage, every portable lamp should be surrounded with a substantial wire guard.

- e.* Must not be used in show windows.
- f.* Must be protected by insulating bushings where the cord enters the socket.
- g.* Must be so suspended that the entire weight of the socket and lamp will be borne by knots under the bushing in the socket, and above the point where the cord comes through the ceiling block or rosette, in order that the strain may be taken from the joints and binding screws.

47. In selecting flexible cord for any given job of wiring, the class of work for which the cord is to be used must be kept in view.

The following rule specifies the kind of insulated cord that must be used with portable apparatus.

For portable lamps, small motors, etc.:

a. Flexible cord for portable use must meet all the requirements for flexible cord for pendant lamps both as to construction and thickness of insulation, and in addition must have a tough braided cover over the whole. There must also be an extra layer of rubber between the outer cover and the flexible cord, and in most places the outer cover must be saturated with a moisture-proof compound thoroughly slicked down. In offices, dwellings, or in similar places where appearance is an essential feature, a silk braid may be substituted for the weather-proof braid.

48. Lamp Bases.—The style of lamp socket used in a given job of wiring will depend on the kind of lamp base used on the system. A large number of different styles of lamp bases have been brought out, but the number has gradually been cut down until the three types shown in

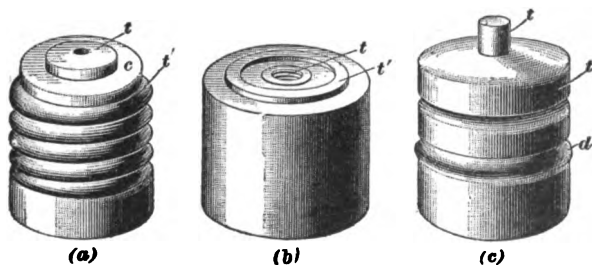

Fig. 26 cover practically all the lamps in use in the United States; these are the Edison (*a*), the Thomson-Houston (*b*), and the Sawyer-Man, or Westinghouse (*c*). Of these three, the Edison base is the most popular and is rapidly superseding the other two. In each case, the terminals of the

socket are marked *t, t'*. When the lamp is placed in the socket, these make connection with corresponding terminals, thus connecting the circuit with the lamp.

49. Lamp Sockets and Receptacles.—A large variety of lamp sockets are manufactured, but they are all much the same in general design. Some of these are provided with

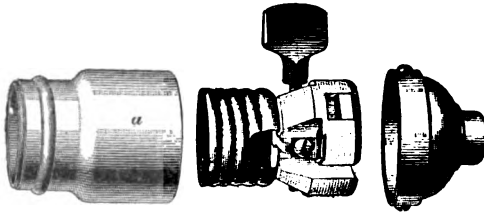

FIG. 27



FIG. 28

keys for turning the light off or on; others are keyless—the light being controlled by a separate switch. The main thing to look out for in selecting sockets is to see that they are substantial; one of the most common sources of trouble on incandescent-lighting circuits is flimsy sockets that are continually getting out of order. Fig. 27 shows a typical

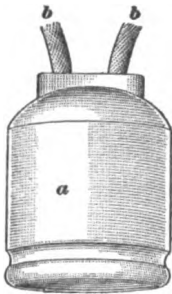
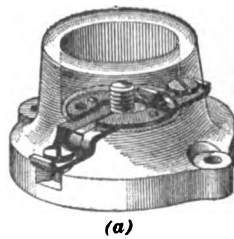
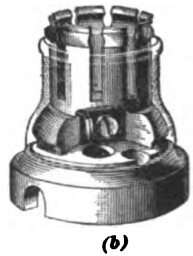

FIG. 29



(a)



(b)

FIG. 30

key socket for an Edison base lamp. Sockets should be so constructed that the shell *a* will be insulated from the wires. The rubber or composition bushing shown in Fig. 28 must be used to protect the cord where it passes through the shell. Ordinary key sockets are suitable for work with incandescent lamps not exceeding 32 candlepower.

Fig. 29 shows a waterproof, keyless socket for an Edison base. The shell *a* is of porcelain and the wires *b, b* are attached directly to the mains. Sockets of this type are required by the Underwriters whenever wiring is done in damp places, such as breweries, dye houses, etc.

Fig. 30 (*a*) and (*b*) shows two styles of keyless receptacles. That shown in Fig. 30 (*a*) is almost entirely of porcelain and is designed for a lamp having a Thomson-Houston (T. H.) base. That shown in Fig. 30 (*b*) is provided with a porcelain base and a brass shell, the terminals being designed to take a Sawyer-Man, or Westinghouse, base.

CURRENT REQUIRED FOR LAMPS

50. In making wiring calculations, it is necessary to know the current taken by the lamps. This varies somewhat with different makes and can be calculated exactly if the watts per candlepower are known. For ordinary calculations, it will be found convenient to use the current given

TABLE III
POWER CONSUMPTION OF INCANDESCENT LAMPS

Candlepower	Voltage	Current Amperes	Watts
8	110	.27	30
10	110	.32	35
16	110	.50	55
16	52	1.00	52
16	220	.30	66
32	110	1.00	110

in Table III. The current taken by enclosed arc lamps varies with the make and size of lamp. About 5 amperes is a fair average for constant-potential enclosed arcs, though in some cases lamps may be designed for 6 amperes, while in others where a long arc is used, the current may be as low as 4 amperes.

FUSES

51. Link Fuses.—Fig. 31 shows an ordinary link fuse consisting of a fusible wire or strip *c* (generally made of a mixture of lead and tin) provided with copper terminals *a*, *b*. The terminals are necessary in order to provide good contact between the fuse and the fuse-block terminals; and, also, to prevent damage to the soft fuse wire from the clamping screws.



FIG. 31

Link fuses are gradually going out of use; they are not as reliable as enclosed fuses of the plug or cartridge types and are no longer allowed except in rosettes where the current must not exceed 3 amperes, or on panel boards that are mounted in fireproof cabinets. Even on panel boards, the best practice is to use enclosed fuses in preference to those of the link type even though the

or cartridge types and are no longer allowed except in rosettes where the current must not exceed 3 amperes, or on panel boards that are mounted in fireproof cabinets. Even on panel boards, the best practice is to use enclosed fuses in preference to those of the link type even though the

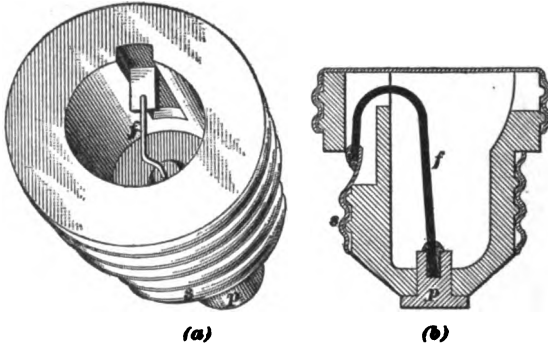

FIG. 32

latter are not prohibited. For all fuses mounted on porcelain bases and used outside of cabinets, the enclosed type must now be used.

52. Enclosed Fuses.—The oldest type of enclosed fuse is the Edison plug, Fig. 32. They are used on 125-volt circuits and are made for currents from 3 amperes to 30 amperes. They are also allowable on three-wire circuits with grounded neutral where the pressure between the outside wires does

not exceed 250 volts. The fuse *f*, Fig. 32, is mounted in a porcelain holder and attached to the screw terminal *s* and the contact *p*; the holder is provided with a brass cap with an opening covered with mica or with a plain cap without mica.

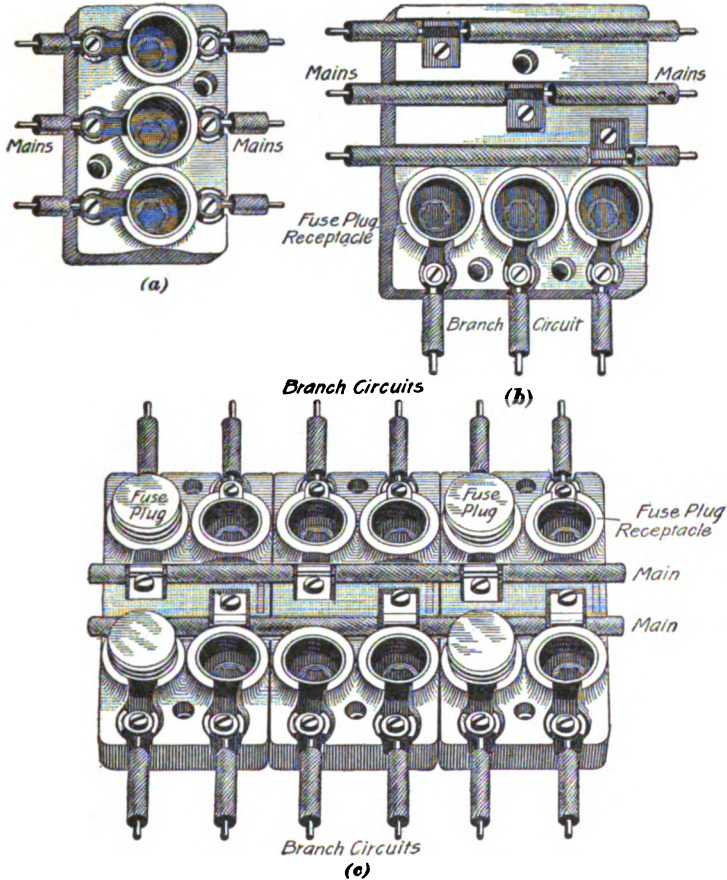

FIG. 33

These plugs screw into the receptacles on the fuse block, and whenever a fuse blows, a new plug is inserted.

Fig. 33 (a) shows a three-wire main block and (b) a three-wire branch block; (c) shows three two-wire double

branch blocks grouped together to form a distributing center. The advantages of this type of fuse are that it is enclosed and that it gives good contact between the fuse and the fuse-block terminals.

53. Most enclosed fuses are of the so-called **cartridge type**, shown in Fig. 34. The enclosed fuse consists essentially of an insulating tube provided with metal ends *b, b* that fit into clips *c, c* when the tube is placed in position. The fuse wire (which is often made of zinc or aluminum) passes through this tube and is surrounded with a non-conducting material that will flux with the molten metal and effectually suppress the arc. One objection that has been

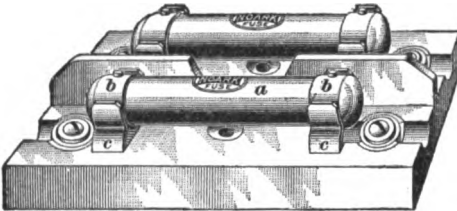

FIG. 34

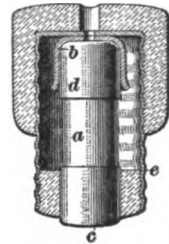

FIG. 35

urged against enclosed fuses, outside of their higher cost as compared with link fuses, is the difficulty in telling whether a fuse has blown or not since it is enclosed and cannot be seen. In the type of fuse shown in Fig. 34 this difficulty is overcome by shunting the main fuse by a small wire that runs under a label on the cartridge. When the main fuse blows, the small wire at once melts and makes a mark on the label.

Fig. 35 shows an adaptation of the cartridge type of fuse to the Edison plug. Cut-outs already installed for use with Edison plug fuses can thus be made to serve for cartridge fuses and can be used for pressures as high as 250 volts. The small cartridge fuse *a* is pushed through the hole in the bottom of the plug and is held by the clip *b* so that when the plug is screwed in place the current passes through the fuse by way of the contacts *c, d, e*. When a fuse blows, it is

necessary to replace the cartridge only and not the whole plug as with the Edison plug fuse.

54. The chief advantages of enclosed fuses are that they are more reliable than link fuses and prevent arcing. The fuse wire is not exposed to air-currents and it is impossible for it to come in contact with substances other than those for which the fuse was originally designed and adjusted. Manufacturers of enclosed fuses make arrangements for refilling the cartridges, so that the expense of using these fuses is not as great as their first cost would indicate.

55. Rating of Fuses.—Every fuse must be marked with the rated current that it is designed to carry and also the voltage of the circuit for which it is intended. The rated current is not the current at which the fuse will open the circuit. According to the National Code, fuses must be constructed so that with the surrounding air at a temperature of 75° F. they will carry indefinitely a current 10 per cent. greater than that at which they are rated, and at a current 25 per cent. greater than the rating, they will open the circuit without reaching a temperature that will injure the fuse tube or terminals of the fuse block.

WIRING FOR A UNIFORM DROP

56. In the method of wiring illustrated in Fig. 15, the lamp on the extreme end of the line in the office is much farther from the dynamo than the first lamp on that line. Owing to the resistance of the wire, the distant lamp will not burn as brilliantly as the nearer one; therefore, it is desirable to have a system of wiring on which the lamps will all glow with equal brightness. Also, it is not desirable, in many cases, to have a rosette with a fuse at each lamp, as this means many small fuses, and many very small fuses, besides causing more trouble, are not as reliable as a few larger ones. Fig. 36 represents the factory wired so as to avoid these two undesirable conditions. Where joints are made without changing the size of the wire, no cut-outs are

required. In these wiring diagrams but one line is drawn to represent the two wires that must be installed.

In the wiring diagram shown in Fig. 36, there being less than 660 watts on any branch circuit, fuses may be omitted from the rosettes (or fuseless rosettes installed). Fuses of a proper size to protect the lamp cord must be placed in the cut-outs, that is, 6-ampere fuses if No. 16 cord is used. In

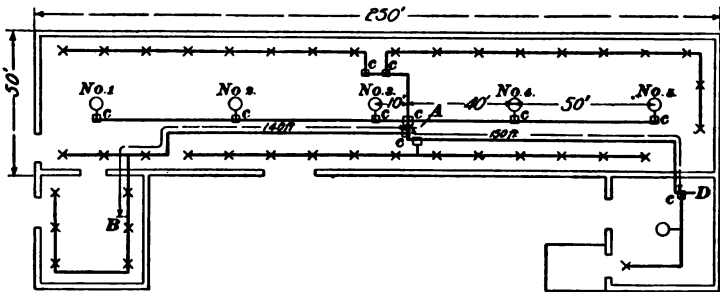

FIG. 36

such an installation, No. 18 lamp cord cannot be used without fused rosettes, unless not more than six lamps are placed on a branch circuit, because a 3-ampere fuse is required to protect No. 18 wire, and if placed in a cut-out, it will not allow current to pass for more than six 110-volt lamps. The sizes of wires permitted by the insurance rules will be the same as in the first case studied.

57. We will now take up the subject of line calculations with reference to loss of power, or drop in potential. Table IV gives the resistance of pure copper wire at 75° F. (24° C.), which is the temperature at which wiring calculations are usually made. The conductivity of commercial copper wire is from 98 to 99.5 per cent. of that of pure copper.

In ordinary interior wiring, the variations in resistance due to changes in temperature are usually disregarded, although they must be taken into account in the design of most kinds of electrical apparatus where they affect the regulation very much, as, for instance, in the field coils on

TABLE IV
RESISTANCE OF PURE COPPER WIRE

Number B. & S.	Resistance at 75° F.		
	Ohms per 1,000 Feet	Ohms per Mile	Feet per Ohm
0000	.04893	.25835	20,440.
000	.06170	.32577	16,210.
00	.07780	.41079	12,850.
0	.09811	.51802	10,190.
1	.1237	.65314	8,083.
2	.1560	.82368	6,410.
3	.1967	1.0386	5,084.
4	.2480	1.3094	4,031.
5	.3128	1.6516	3,197.
6	.3944	2.0825	2,535.
7	.4973	2.6258	2,011.
8	.6271	3.3111	1,595.
9	.7908	4.1753	1,265.
10	.9972	5.2657	1,003.
11	1.257	6.6369	795.3
12	1.586	8.3741	630.7
13	1.999	10.555	500.1
14	2.526	13.311	396.6
15	3.179	16.785	314.5
16	4.009	21.168	249.4
17	5.055	26.691	197.8
18	6.374	33.655	156.9
19	8.038	42.441	124.4
20	10.14	53.539	98.66
21	12.78	67.479	78.24
22	16.12	85.114	62.05
23	20.32	107.29	49.21
24	25.63	135.53	39.02
25	32.31	170.59	30.95
26	40.75	215.16	24.54
27	51.38	271.29	19.46
28	64.79	342.09	15.43
29	81.70	431.37	12.24
30	103.0	543.84	9.707
31	129.9	685.87	7.698
32	163.8	864.87	6.105
33	206.6	1,090.8	4.841
34	260.5	1,375.5	3.839
35	328.4	1,734.0	3.045
36	414.2	2,187.0	2.414
37	522.2	2,757.3	1.915
38	658.5	3,476.8	1.519
39	830.4	4,384.5	1.204
40	1,047.	5,528.2	.955

a generator. The greatest variation in temperature at all likely to occur, and that will occur but rarely and only in open work, is about 100° F. This will correspond to a change in resistance of about 21 per cent.

The resistances of wires smaller than No. 18 are of no use in practical wiring, but are given for reference, as small wires are used in many pieces of mechanism, such as fan motors, resistance boxes, etc., with which wiremen have to deal, and also in bell and annunciator work.

58. The efficiency of a system of electric wiring is low if the percentage of power that is consumed in heating the wires instead of being conveyed to the lamps or other transforming devices is large. This loss of power (in watts) is equal to the volts *drop* in the line multiplied by the *current* in *amperes*. Wiring specifications usually call for so many volts drop or not more than a certain percentage of drop on the line between the lamps and the center of distribution and between the center of distribution and the point where the wires enter the building or where the dynamo is located.

CALCULATION OF LINE LOSSES DUE TO RESISTANCE

59. We will now calculate the drop on the wires in the factory shown in Fig. 36, using the smallest wires permitted by the Underwriters. The distance from the dynamo *D* to point *A*, which is the average distance that the current travels on the No. 6 wire, is 150 feet (allowing for risers to a ceiling 15 feet high). As there must be two wires, the total length of wire is 300 feet or .3 thousand feet.

The resistance of 1,000 feet of No. 6 wire (Table IV) is .3944 ohm; therefore, the resistance of 300 feet of No. 6 wire is $.3 \times .3944 = .11832$ ohm. This line carries 50 amperes. By Ohm's law, the drop is given by the following relation: Drop in line (volts) = current in line \times resistance of line; hence, drop = $50 \times .118 = 5.9$ volts.

The line from *A* to *B* carries current for nine lamps, or 4.5 amperes. Its distance is 140 feet and the resistance of the No. 14 wire is 2.526 ohms per 1,000 feet; hence,

drop = $4.5 \times \frac{2 \times 140}{1,000} \times 2.526 = 3.18$ volts drop on the branch line of No. 14 wire.

The total drop from *D* to *B* will then be $5.9 + 3.18 = 9.08$ volts. This is 8.25 per cent. of 110 volts, altogether too much for such a plant as we have been considering.

The reason why such a large loss must not be permitted, in addition to the simple matter of economy of power, is that such a large falling off in voltage will greatly reduce the brightness of the lamps and poor service will result. The cost of power alone, however, is usually a sufficient reason to prohibit such great losses in the wiring.

60. The plant we are considering requires 50 amperes at 110 volts, or 5,500 watts. This, if furnished by a lighting company, will cost between 10 and 20 cents a kilowatt-hour, at the rates ordinarily charged. That will be from \$.55 to \$1.10 an hour for light. 8.3 per cent. of this is 4.565 cents to 9.13 cents an hour. If the lights are used an average of 2 hours a day 300 days a year, this will amount to from \$27.39 to \$54.78 a year. Even if the loss were only one-fourth as great, the saving in the cost of light in a year would more than pay for the additional cost of wire.

It is usual to specify a 2-per-cent. drop for such installations as this when the current is to be purchased at fairly high prices, and a 3-per-cent. to 5-per-cent. drop where the current is produced cheaply, as by a dynamo on the premises. Not more than a 5-per-cent. drop should be permitted on short distances, even where very cheap work is desired. This would be accomplished in this case by using No. 4 wire for the feeders and No. 12 for the branch lines. The student may calculate the loss exactly by the use of Table IV.

61. Drop in Arc-Light Wiring.—The loss on the arc lines using No. 10 wire from the point *A* is found as follows. The resistance of No. 10 wire is about 1 ohm per 1,000 feet.

$$\text{Drop from } A \text{ to lamp No. } 3 = 15 (\text{amperes}) \times \frac{2 \times 10 (\text{feet}) \times 1}{1,000} = .3 \text{ volt}$$

$$\text{Drop from lamp No. } 2 \text{ to lamp No. } 3 = 10 \times \frac{2 \times 50 \times 1}{1,000} = 1 \text{ volt}$$

$$\text{Drop from lamp No. } 1 \text{ to lamp No. } 2 = 5 \times \frac{2 \times 50 \times 1}{1,000} = .5 \text{ volt}$$

$$\text{Drop from lamp No. } 4 \text{ to lamp No. } 5 = .5 \text{ volt}$$

$$\text{Drop from } A \text{ to lamp No. } 4 = 10 \times \frac{2 \times 40 \times 1}{1,000} = .8$$

$$\text{Total drop to lamp No. } 1 = .3 + 1 + .5 = 1.8 \text{ volts}$$

$$\text{Total drop to lamp No. } 2 = .3 + 1 = 1.3 \text{ volts}$$

$$\text{Total drop to lamp No. } 3 = .3 \text{ volt}$$

$$\text{Total drop to lamp No. } 4 = .8 \text{ volt}$$

$$\text{Total drop to lamp No. } 5 = .8 + .5 = 1.3 \text{ volts}$$

These slight variations can be permitted on the arc lamps without inconvenience.

62. Size of Wire for Arc Lights.—It should be noted that No. 10 wire is the smallest permitted on this line if the line is protected by but one cut-out. But if the line is divided into two parts, one for lamps Nos. 1, 2, and 3 and one for lamps Nos. 4 and 5, with separate cut-outs for each of these lines, smaller wires may be used, so far as the Underwriters' rules are concerned. Fig. 37 shows the sizes permitted (a) with a single branch block and (b) with a double branch block.

The wires that have their sizes designated by odd numbers from No. 7 up are not usually manufactured and cannot be purchased except on special order. Therefore, work must be done without using Nos. 7, 9, 11, and 13. The resistances of these sizes, however, are given in the table, as these wires are extensively used in the manufacture of electrical machinery. In tables given later, the above sizes are not given, although in a number of cases they would come nearer the calculated size. In interior wiring it does not, as a rule, pay to be too saving in regard to the sizes of wire, and the nuisance of carrying a large number of sizes of wire in stock more than counterbalances any slight gain there

might be in the copper used on a given job. For this reason, the above odd sizes are not generally used. Moreover, the

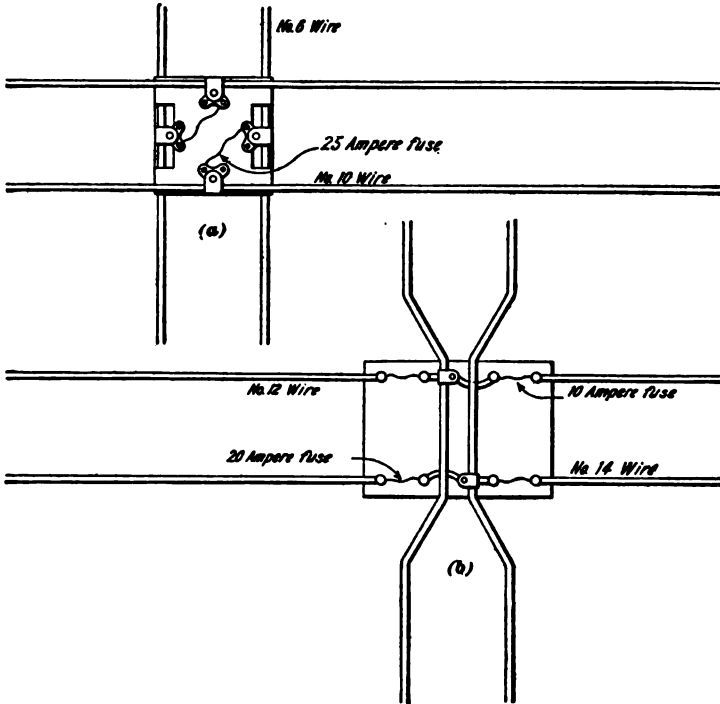

FIG. 37

tendency is always to add more lights to a system, and it is best to be liberal when installing the wire.

CALCULATION OF THE PROPER SIZE OF WIRE FOR A GIVEN LOSS

63. Wiring for 110 Volts, 2 Per Cent. Drop.—We will now calculate the sizes of wires required in the building wired according to Fig. 36 for a loss of 2 per cent. (2 per cent. of 110 = 2.2 volts).

This calculation will be made with a view to making the drop uniform along all the lines; that is, we will make the

volts drop per foot of line as nearly equal as possible in feeders and branches. The proper value of volts drop per foot is found by allowing the desired drop to the most distant group of lamps in the system and distributing this drop uniformly along the lines to the generator.

The average distance from the dynamo to the most distant group of lamps B is $150 + 140 = 290$ feet. This requires 580 lineal feet of wire, or .58 thousand feet, there being two lines. $\frac{2.2 \text{ (volts)}}{.58} = 3.8$ volts per 1,000 feet. 3.8 (volts)

$\div 50 \text{ (amperes)} = .076$ ohm per 1,000 feet for mains. The nearest wire to this is No. 00, with .078 ohm per 1,000 feet. Using this, the loss on the mains will be $.3 \times .078 \times 50 = 1.17$ volts, leaving $2.2 - 1.17 = 1.03$ volts to be lost in the branch line. The length of the branch is 140 feet (280 or .28 thousand feet double distance) and the drop per 1,000 feet is $\frac{1.03}{.28} = 3.68$ volts. The current in the branch

is 4.5 amperes; hence, the allowable resistance per 1,000 feet is $\frac{3.68}{4.5} = .82$ ohm. This would call for a No. 9 wire. In

Art. 59 the sizes were No. 6 for the mains and No. 14 for the branch under consideration; consequently, to reduce the drop from 9.08 volts to 2.2 volts these sizes must be increased to No. 00 and No. 9, respectively.

64. Wiring for 220 Volts, 3 Per Cent. Drop.—As a further exercise in calculating the required sizes of wires in terms of resistances per 1,000 feet, let us ascertain the proper sizes of wire to equip the factory with 220-volt lamps, allowing 3 per cent. loss.

As 220-volt lamps are not as efficient as 110-volt lamps, allow 60 watts per 16-candlepower lamp and 3 amperes per enclosed-arc lamp. The circuits for incandescent lamps carry approximately equal loads and are of about the same length, so that it will be sufficient to calculate the size of wire for one circuit only. $10 \text{ (lamps)} \times 60 \text{ (watts per lamp)} \div 220 \text{ (volts)} = 2.73$ amperes.

$$\begin{aligned} 4 \times 2.73 &= 10.92 \text{ amperes for incandescent lamps} \\ 5 \times 3.00 &= 15.00 \text{ amperes for arc lamps} \\ &25.92 \text{ amperes total current} \end{aligned}$$

$$3 \text{ per cent. of } 220 \text{ volts is } 6.6 \text{ volts. } \frac{6.6}{.58} = 11.38 \text{ volts lost}$$

$$\text{per } 1,000 \text{ feet; } \frac{11.38}{25.9} = .44 \text{ ohm per } 1,000 \text{ feet for the mains.}$$

The wire with resistance nearest this is No. 6, with .394 ohm per 1,000 feet. Using this size, we have a loss on the mains of $.3 \times .394 \times 25.9 = 3.07$ volts, leaving 3.53 volts to be lost on branch lines.

The size of these branch lines will, therefore, be found as follows: $\frac{3.53}{.28} =$ volts drop per 1,000 feet in branch lines and

$$\frac{3.53}{.28} \div 2.73 = 4.62 \text{ ohms per } 1,000 \text{ feet.}$$

Table IV gives 4.009 ohms per 1,000 feet for No. 16 wire, which is smaller than the Underwriters will permit. No. 14 must be used, even though it is larger than necessary as far as the drop is concerned. The loss on the branch line will then be $.28 \times 2.526 \times 2.73 = 1.93$ volts, leaving $6.60 - 1.93 = 4.67$ volts to be lost in the mains, instead of 3.07, as previously calculated. $\frac{4.67}{.3} \div 25.9 = .6$ ohm per 1,000 feet in feeders. No. 8 wire has .627 ohm per 1,000 feet and is nearest the required size.

In 220-volt wiring, where the distances within the building are short, the wireman will usually find that the minimum sizes of wires specified by the Underwriters are large enough to carry the current with less than 2 per cent. loss. In small dwellings wired on the closet system of distribution with 220-volt circuits, it will not be necessary to pay any attention whatever to the drop on inside lines.

65. Center of Distribution.—In making calculations relating to wiring, the distance to be taken is the *average distance* through which the current supplied can be considered as flowing. For example, take a case like that

shown in Fig. 38, where a circuit is run from a distributing point *A* to a number of lamps *B*. For the first 100 feet no lamps are connected; we then have, say twelve lamps spread out over 50 feet at the end. In calculating the drop on such a circuit, it is evident that the full length should not be taken, because the whole of the current does not flow through all the line. The current keeps decreasing as each lamp is passed. The center of distribution for the lamps will, therefore, be at *C* and the average length of wire through which the 6 amperes is carried is $2 \times 125 = 250$ feet. If the lights were bunched at the end of the line, the distance to the center

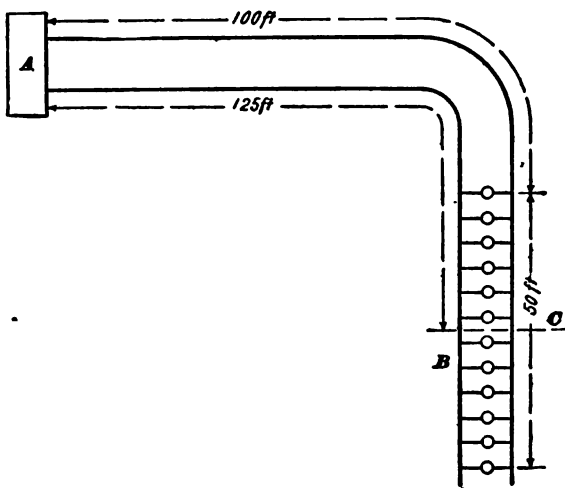

FIG. 38

of distribution would be the same as the length of the line, and the length of wire through which the 6 amperes would flow would be $2 \times 150 = 300$ feet. If the lights were spaced uniformly throughout the whole length of the line, the average distance would be $\frac{1}{2} \times 150 = 75$ feet and the average length of wire used in making calculations for drop would be 150 feet. By laying out a plan of the wiring, the average distance over which the current is transmitted can usually be determined without much trouble and close enough for practical purposes.

66. Selection of Fittings for 220-Volt Wiring.—In 220-volt wiring, great care must be taken in the selection of fittings. Cut-outs, sockets, and switches designed for 110-volt working and not improved during recent years so as to comply with the more severe requirements of the present day must not be used on higher voltages. Keyless sockets should be used for 220-volt work and the lamps controlled by switches; no rosettes with link fuses should be installed, fuses being placed in approved cut-outs, one of which should be provided for each ten lamps or less. If proper precautions are taken to procure good cut-outs, sockets, and switches, there is no especial difficulty to be encountered in 220-volt work, though the lamps are not as efficient as can be procured for lower voltages.

Fig. 39 (a) and (b) shows two cut-outs designed especially for 220-volt work. The construction is such as to secure higher insulation and less liability to arcing than with the ordinary 110-volt fittings. Fig. 39 (a) is a three-wire branch block shown without the fuses in place. Fig. 39 (b) is a three-wire main block with the fuses *f* in their proper position. These fuses are of the enclosed type and are held by clips *g, g*, (a).

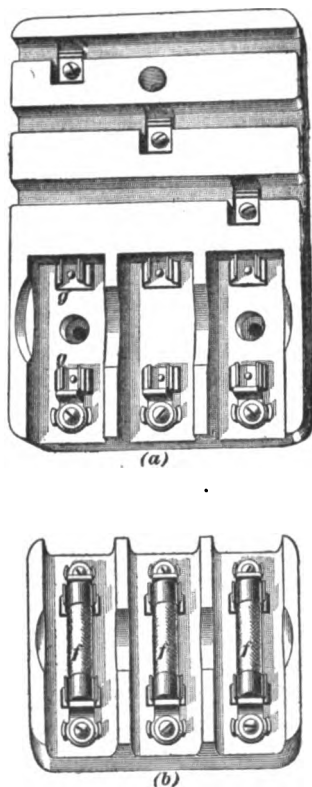

FIG. 39

Plug fuses of the cartridge type, Fig. 35, can be used on 220-volt circuits with the cut-outs mounted open. Cut-outs should be provided with barriers or porcelain partitions between the fuses, Fig. 39, so as to prevent arcing between the terminals and accidental short circuits in case any

conductor happens to fall across the cut-out. Open link fuses on 220-volt circuits are only allowable when used on enclosed slate or marble tablet boards.

67. Size of Wire for Three-Wire System.—If it is desired to wire the shop that we have been considering for 110-volt lamps on the Edison three-wire system, the sizes of the main wires required will be the same as for the 220-volt two-wire system, and a third, or neutral, wire must be installed. This is usually placed between the other two; if the wires are put on cleats, three-wire cleats may be used. The neutral wire must not be smaller than will be required for the safe carrying capacity for the current of all the lamps on one side of the circuit. In this case, that current is 25 amperes and the wire must not be smaller than No. 10; it should be larger to prevent unbalancing when lamps are turned off.

68. Unbalancing of Three-Wire System.—The unbalancing of a three-wire system with the three wires of equal size is illustrated in Fig. 40 (a) and (b). When the system is balanced, as in (a), there are 3 amperes in the

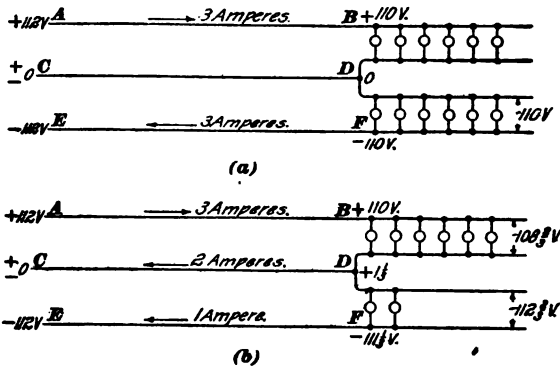

FIG. 40

outside wires and no current in the neutral. Taking the pressure between A and C or C and E as 112 volts, and between B and D or D and F as 110 volts, there is a drop of 2 volts

in AB and one of 2 volts in EF . The resistance AB , CD , and EF must, therefore, be $\frac{2}{3}$ ohm, in order to give a drop of 2 volts with a current of 3 amperes. If the load becomes unbalanced, as in (*b*), there will be a current of 3 amperes in AB , as before, 2 amperes in CD , and 1 ampere in EF . The drop in AB will be $\frac{2}{3} \times 3 = 2$ volts; in CD , $\frac{2}{3} \times 2 = 1\frac{1}{3}$ volts; in EF , $\frac{2}{3} \times 1 = \frac{2}{3}$ volt. The total drop in the two outside wires will now be $2 + \frac{2}{3} = 2\frac{2}{3}$ volts, and hence the pressure between the outside wires at the end of the line must be $224 - 2\frac{2}{3} = 221\frac{1}{3}$ volts. Taking the upper side of the circuit, we have 3 amperes flowing out through AB and 2 amperes flowing back through CD ; the drop on this side must, therefore, be $2 + 1\frac{1}{3} = 3\frac{1}{3}$ volts and the pressure between B and D must be $112 - 3\frac{1}{3} = 108\frac{2}{3}$ volts. The pressure between B and F is $221\frac{1}{3}$ volts; hence, the pressure between D and F must be $221\frac{1}{3} - 108\frac{2}{3} = 112\frac{2}{3}$. The result of the uneven load is, therefore, that the voltage rises in the lightly loaded side and falls on the side having a heavy load. If the neutral wire were smaller, this unbalancing would be greater.

The branch lines of a three-wire system being simple two-wire circuits, they must be calculated for the proper current and drop in the same way as ordinary two-wire circuits.

INTERIOR WIRING

(PART 2)

UNIFORM DROP IN FEEDER LINES

CALCULATING SIZES OF WIRE REQUIRED

1. In installations where there are many sets of feeders running to various departments, it is usual to allow a certain loss in the feeders and a certain other loss in the distribution wires. The drops in all feeders are made equal, and the dynamo is operated at a higher voltage than the lamps will stand, with the intention of losing a definite amount before the lamps are reached. It is important that the voltage at the lamps should never exceed that for which they are intended.

2. Fig. 1 represents a plant, such as a wagon works or furniture factory; only the outlines of the buildings are indicated. The dynamo and switchboard are located at *D* in the engine room. The various centers of distribution are to be at or near the centers of the various floors, and a separate pair of feeders is to be run to each distribution center. Where elevator shafts are convenient, they are used to run risers to the upper floors. In the case illustrated there are fourteen pairs of feeder wires, each pair being represented by one line in the figure.

A 115-volt dynamo and 110-volt lamps are to be used. A loss of 2 volts is to be allowed in the distribution wires and

For notice of copyright, see page immediately following the title page

a loss of 3 volts in the feeders, irrespective of their length. The figure shows the plan of the feeders on one floor only; the small round dots indicate risers.

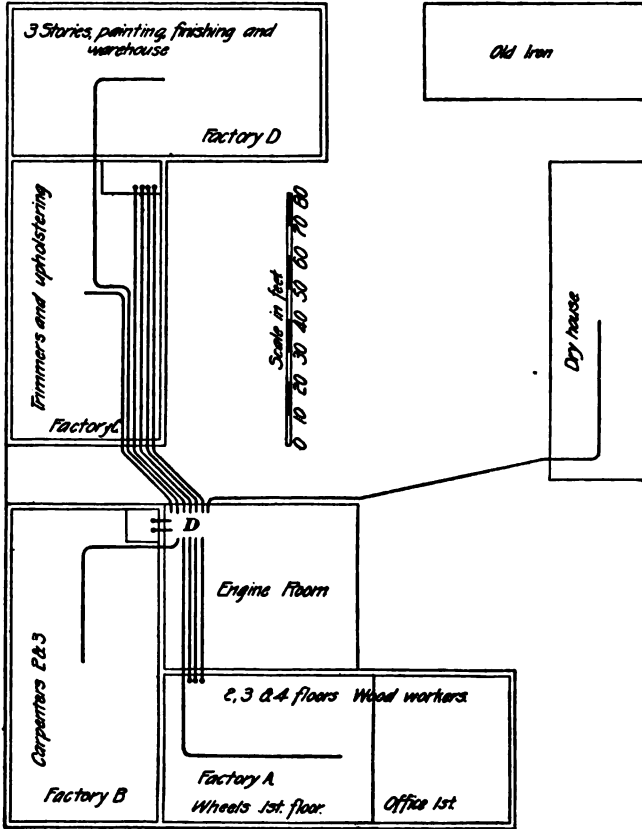

FIG. 1

We will calculate the feeders on one floor only.

	LAMPS	AMPERES	DISTANCE FEET	LENGTH OF WIRE FEET
Shop A,	50	25	130	260 (.26 thousand)
Shop B,	40	20	75	150 (.15 thousand)
Shop C,	40	20	85	170 (.17 thousand)
Shop D,	40	20	175	350 (.35 thousand)

The resistance per 1,000 feet of these feeders required to give a drop of 3 volts and the nearest sizes of wires obtainable, are calculated as follows:

$$\text{Shop } A, \frac{3}{25 \times .26} = .461, \text{ No. 6 has .395 ohm per 1,000 feet}$$

$$\text{Shop } B, \frac{3}{20 \times .15} = 1.000, \text{ No. 10 has .999 ohm per 1,000 feet}$$

$$\text{Shop } C, \frac{3}{20 \times .17} = .882, \text{ No. 10 has .999 ohm per 1,000 feet}$$

$$\text{Shop } D, \frac{3}{20 \times .35} = .429, \text{ No. 6 has .395 ohm per 1,000 feet}$$

This method of calculating required sizes of wires can be applied to any kind of wiring for any practical purpose; but to avoid the necessity of figuring out each case, wiring tables have been prepared by which the proper size can be determined without calculation.

CALCULATION OF WIRE SIZES IN TERMS OF RESISTANCE PER 1,000 FEET

3. Calculations based on resistance per 1,000 feet may be put in the shape of a formula, as follows:

$$r_m = \frac{1,000e}{2DI} \quad (1)$$

in which r_m = resistance of 1,000 feet of wire to be used;

e = drop, in volts;

D = distance, in feet;

I = current, in amperes.

For example, to carry 10 amperes 600 feet ($600 \times 2 = 1,200$ feet of wire) with 3 volts drop, the resistance per 1,000 feet will be $r_m = \frac{1,000 \times 3}{2 \times 600 \times 10} = .25$ ohm per 1,000 feet. No. 4 wire has about this resistance, as may be seen by consulting a wire table.

4. **Wiring Table Giving Distances for Drop of 1 Volt.**—In Table I, distances in feet are given in the top

TABLE I

Distances in Feet, for Loss of 1 Volt

Amperes	Size of Soft-Copper Wire, in B. & S. Gauge																	
	20	25	30	35	40	45	50	60	70	80	90	100	120	140	160	180	200	
1																		
1.5																		
2																		
3																		
4																		
5																		
6																		
7																		
8																		
9																		
10	14	14	12	12	12	12	12	12	12	12	12	12	12	12	12	12	12	12
12	14	12	12	12	12	12	12	12	12	12	12	12	12	12	12	12	12	12
14	12	12	12	12	12	12	12	12	12	12	12	12	12	12	12	12	12	12
16	12	12	12	12	12	12	12	12	12	12	12	12	12	12	12	12	12	12
18	10	10	10	10	10	10	10	10	10	10	10	10	10	10	10	10	10	10
20	10	10	10	10	10	10	10	10	10	10	10	10	10	10	10	10	10	10
25	10	8	8	8	8	8	8	8	8	8	8	8	8	8	8	8	8	8
30	8	8	8	8	8	8	8	8	8	8	8	8	8	8	8	8	8	8
35	8	8	8	8	8	8	8	8	8	8	8	8	8	8	8	8	8	8
40	8	8	8	8	8	8	8	8	8	8	8	8	8	8	8	8	8	8
45	8	8	8	8	8	8	8	8	8	8	8	8	8	8	8	8	8	8
50	8	8	8	8	8	8	8	8	8	8	8	8	8	8	8	8	8	8
55	8	8	8	8	8	8	8	8	8	8	8	8	8	8	8	8	8	8
60	8	8	8	8	8	8	8	8	8	8	8	8	8	8	8	8	8	8
65	8	8	8	8	8	8	8	8	8	8	8	8	8	8	8	8	8	8
70	8	8	8	8	8	8	8	8	8	8	8	8	8	8	8	8	8	8
75	8	8	8	8	8	8	8	8	8	8	8	8	8	8	8	8	8	8
80	8	8	8	8	8	8	8	8	8	8	8	8	8	8	8	8	8	8
85	8	8	8	8	8	8	8	8	8	8	8	8	8	8	8	8	8	8
90	8	8	8	8	8	8	8	8	8	8	8	8	8	8	8	8	8	8
100	8	8	8	8	8	8	8	8	8	8	8	8	8	8	8	8	8	8

horizontal line. Beneath these distances are columns containing numbers that designate the proper size of wire to use to obtain a drop of 1 volt when the wire carries the current given in the corresponding line in the left-hand column.

If it is desired, for example, to find the size of wire necessary to get a loss of not more than 1 volt with 20 amperes, and a distance of 140 feet (i. e., two wires, 140 feet long), we look under 140 and to the right of 20 and find the figure 2. No. 2 wire will be required. If it is desired to find the wire required for a loss of 2 volts with 20 amperes and a distance of 140 feet, we may divide the distance by the loss in volts and use the table as before; i. e., under 70 and to the right of 20 is found 5. No. 5 is the proper wire. Or, we may use the distance given and divide the current by the number of volts; i. e., under 140 and to the right of 10 is found 5. The table is sufficiently accurate for all practical purposes, but where very great exactness is desired, it is better to calculate the lines. For the smaller sizes in this table, the nearest even sizes of wire above No. 6 are given because the odd sizes are not ordinarily used.

CALCULATION OF WIRES IN TERMS OF CIRCULAR MILS

5. In the Underwriters' table of safe carrying capacities, the wires are listed both by number (B. & S. gauge) and by circular mils. Cables having no B. & S. gauge number are listed by circular mils only. Large cables of any desired cross-section in circular mils are made by all the leading manufacturers of insulated wires.

It is often more convenient to calculate the size of wires or cables in terms of circular mils than in terms of resistance per 1,000 feet; and calculations in terms of circular mils are applicable to wires or cables of any size or shape.

A round wire 1 mil in diameter has a cross-section of 1 circular mil. A copper wire 1 mil ($\frac{1}{1000}$ inch) in diameter and 1 foot long (1 mil-foot) has a resistance of 10.8 ohms; or, *1 mil-foot of copper has 10.8 ohms resistance at 75° F.*

A wire 2 mils in diameter has a section of 4 circular mils (sometimes abbreviated C. M. or cir. mils); 3 mils in diameter, 9 circular mils; 4 mils, 16 circular mils; 5 mils, 25 circular mils; x mils, x^2 circular mils. *The circular mils cross-section of any round wire is equal to the square of its diameter in mils.* The circular mils of any conductor of other shape is equal to its area in *square mils* multiplied by 1.273 or divided by .7854. For instance, the circular mils of No. 0000 wire (diam. = 460 mils) = $460^2 = 211,600$ circular mils, while a bar of copper $\frac{1}{4}$ inch by $\frac{1}{2}$ inch (250 mils by 500 mils) has a section of $250 \times 500 = 125,000$ square mils, or $250 \times 500 \times 1.273 = 159,125$ circular mils.

6. If the length, in feet, of a wire is known and also its area, in circular mils, the resistance may at once be determined by the formula

$$R = \frac{10.8 L}{\text{cir. mils}} \quad (2)$$

In this formula, L must be the total length of wire in feet.

Also, since the drop e in a circuit is equal to the current $I \times$ resistance R , we have

$$\text{drop } e = \frac{10.8 LI}{\text{cir. mils}} \quad (3)$$

or if the drop is given and we are required to find the size of wire to give this drop, we may put formula 3 in the form

$$\text{circular mils} = \frac{10.8 LI}{e} \quad (4)$$

In these formulas, L is the total length of the circuit, i. e., the distance to the lamps and back again. If the distance to the lamps, one way, is called D , we may put formula 4 in the form

$$\text{circular mils} = \frac{21.6 DI}{e} \quad (5)$$

This last formula will generally be found as useful as any that can be given for interior-wiring calculations. It will be well to commit it to memory, because one does not always have a wiring table at hand when calculations are to

be made and, besides, calculations have often to be made that are beyond the range of the tables. It can be applied to any two-wire system or to the three-wire system, as illustrated by the following examples:

EXAMPLE 1.—By means of formula 5, calculate the size of wire necessary to supply eighty 16-candlepower lamps situated at a distance of 200 feet from the center of distribution. The allowable drop is to be 3 volts.

SOLUTION.—We have $D = 200$ and $e = 3$. Each 16-c. p. lamp will take about $\frac{1}{2}$ ampere; hence, $I = 40$.

$$\text{cir. mils} = \frac{21.6 \times 200 \times 40}{3} = 57,600$$

or between No. 2 and No. 3 B. & S. No. 2 wire would likely be used. Ans.

EXAMPLE 2.—Calculate the size of wire necessary to supply one hundred lamps on a 110-220-volt three-wire system. The distance from the center of distribution to the lamps is 250 feet and the drop on each side of the system is not to exceed 3 volts. The lights are supposed to be balanced, fifty lamps on each side.

SOLUTION.—The simplest method of solving this problem is to treat it as if it were a two-wire system and use formula 5. Each pair of lamps will take $\frac{1}{2}$ ampere; hence, the current in the outside wires, when all the lamps are burning, will be $\frac{1}{2} \times 50 = 25$ amperes instead of $\frac{1}{2} \times 100 = 50$ amperes, as it would have been if a two-wire system had been used. The allowable drop on each side of the circuit is 3 volts; hence, the total drop in the outside wires will be 6 volts. We have, then,

$$\text{cir. mils} = \frac{21.6 \times 250 \times 25}{6} = 22,500$$

A No. 6 wire will be large enough and also would likely be installed for the neutral. Ans.

The same method may be used for a 220-440-volt three-wire system, except that in estimating the current, allow about .3 ampere for each pair of lamps instead of .5 ampere, as in the previous case.

7. Estimation of Current Required by Lamps.—As mentioned, it is customary in estimating the current taken by lamps to allow about $\frac{1}{2}$ ampere for each 110-volt 16-candlepower lamp, and others according to the values given. The most accurate way, however, is to figure the current from

the total watts supplied and the known voltage. For a two-wire system the current is as follows:

$$\text{Current} = \frac{\text{number of lamps} \times \text{watts per lamp}}{\text{voltage at lamps}} \quad (6)$$

For a balanced three-wire system

$$\text{Current} = \frac{\text{number of lamps} \times \text{watts per lamp}}{\text{voltage between outside wires at lamps}} \quad (7)$$

These formulas are general and apply to lamps of any efficiency.

CALCULATIONS FOR ALTERNATING CURRENT

8. For ordinary two- or three-wire work with alternating current, calculations may be made in the same way as for direct current. When wiring is done in conduit, the two wires must be run in the same conduit, otherwise inductive effects will greatly reduce the voltage at the lamps. With ordinary open wiring, the induced counter E. M. F. is not usually large enough to produce any noticeable effects, especially when the load consists wholly of lamps. When lamps are operated on two-phase or three-phase alternating-current systems, the different circuits are connected to different phases so as to balance the load, and as far as interior wiring is concerned, the lighting circuits are single-phase and are calculated in the same way as ordinary two-wire circuits.

OTHER FORMS OF WIRING TABLES

9. Before leaving the subject of wire calculations, attention is called to the fact that there are methods of arranging wiring tables other than that given in Table I, for it is easy to produce several arrangements of the same matter. The table that one is most accustomed to use seems the simplest. Tables calculated for incandescent lamps, instead of for amperes, are useless for general work and should not be used for calculating wiring for lamps, unless it is known that the efficiency of the lamps on which the table is based is the same as that of the lamps to be used.

Table II is very convenient because it gives the distance exactly corresponding to the required drop. To use it, divide

TABLE II

Amperes

	1	2	3	4	5	6	7	8	9	10	12	15	18	20	25	30	35	40	45	55	65	75	85	95	100	
18	75.2	37.6	25.1	18.8	15.0																					
16	120.0	60.0	40.0	30.0	24.0	20.0																				
14	190.0	95.0	63.3	47.5	38.0	31.7	27.1	23.8	21.1	19.0	15.8	12.7														
12	302.0	151.0	101.0	75.5	60.4	50.3	43.1	37.7	33.6	30.2	25.2	20.2	16.8	15.1												
10	480.0	240.0	160.0	120.0	96.0	80.0	68.6	60.0	53.3	48.0	40.0	32.0	26.7	24.0	19.2	16.0	13.7									
8	764.0	382.0	255.0	191.0	153.0	127.0	109.0	95.5	84.9	76.4	63.7	51.0	42.5	38.3	30.6	25.5	21.8	19.1	17.0							
6	1,215.0	607.0	405.0	304.0	243.0	202.0	174.0	152.0	135.0	121.0	101.0	81.0	67.5	60.8	48.6	40.5	34.7	30.4	27.0	22.1						
5	1,533.0	766.0	511.0	383.0	307.0	255.0	219.0	192.0	170.0	153.0	128.0	102.0	85.0	76.6	61.3	51.1	43.8	38.4	34.1	27.8	23.6	20.4				
4	1,933.0	966.0	644.0	483.0	387.0	322.0	276.0	242.0	215.0	193.0	161.0	129.0	107.0	96.7	77.3	64.4	55.1	48.3	43.0	35.1	29.7	25.8	22.7			
3	2,437.0	1,219.0	812.0	609.0	487.0	406.0	348.0	305.0	271.0	244.0	203.0	162.0	135.0	122.0	97.4	81.1	69.6	60.0	54.0	44.3	37.5	32.5	28.7	25.7	24.4	
2			1,024.0	768.0	615.0	512.0	439.0	384.0	341.0	307.0	257.0	205.0	171.0	154.0	123.0	102.0	87.9	76.9	68.3	55.9	47.3	41.0	36.2	32.4	30.7	
1			1,291.0	969.0	775.0	646.0	554.0	484.0	431.0	387.0	323.0	258.0	215.0	194.0	155.0	129.0	111.0	96.9	86.0	70.3	59.6	51.7	45.6	40.8	38.7	
0				1,222.0	978.0	815.0	698.0	611.0	543.0	489.0	407.0	326.0	272.0	245.0	195.0	163.0	140.0	122.0	109.0	88.7	75.2	65.1	57.5	51.4	48.9	
00					1,232.0	1,027.0	880.0	770.0	685.0	616.0	513.0	410.0	342.0	308.0	246.0	205.0	176.0	154.0	137.0	112.0	94.8	82.0	73.5	64.8	61.6	
000						1,295.0	1,110.0	971.0	863.0	777.0	648.0	518.0	432.0	388.0	311.0	259.0	222.0	194.0	173.0	141.0	119.0	104.0	91.4	81.7	77.7	
0000							1,400.0	1,225.0	1,089.0	980.0	817.0	653.0	544.0	490.0	392.0	326.0	280.0	245.0	218.0	178.0	151.0	131.0	115.0	103.0	98.0	

Size of Wire, in A. S. Gauge

the number of amperes transmitted by the number of volts drop desired. Find the nearest number to this result in the line of amperes; below this find the distance, in feet, most nearly corresponding to the given distance; to the left of this, in the column of wire sizes, is given the number of the required wire.

For example, to find the size of wire to transmit 15 amperes 140 feet with 3 volts loss, divide 15 by 3 and find the quotient 5 in the line of amperes. In the column below, we find the nearest distance 153, and to the left of this the size of wire required, No. 8.

10. Probably the most convenient of all methods of calculation, after one is accustomed to using it, is the graphic method, in which amperes and distances are laid off at right angles to one another, and the wires corresponding to different values of these quantities, for a loss of 1 volt, are represented by curved lines. Figs. 2 and 3 are diagrams of this kind. Notice that every wire curve is dotted for a short distance for currents larger than the maximum allowed by the Underwriters' rules for that size of wire. In determining the size of wire from these diagrams, do not use the dotted portions of the curves. If a point should come near one of the dotted sections, use the next larger size of wire.

To use such a diagram, find the point where the lines representing amperes and given distance intersect, and take the wire indicated by the wire line nearest this point. Unless the wire line is very close, take the larger wire of the two lines on each side of the intersection point.

For example, to find the wire required for 7 volts loss in a distance of 125 feet, with 21 amperes, divide 21 by 7, which gives 3; the line of 3 amperes intersects the line of 125 feet about midway between the lines representing No. 10 and No. 12 wire; hence, the larger size of wire, No. 10, would be used.

11. In calculating the sizes of wires for 52-, 104-, 220-, or 250-volt work, or for any intermediate voltage, it must be borne in mind that lamps burning on lower voltages than 110 take more current, and those burning on higher voltages take less current. An ampere per lamp for 52-volt lamps,

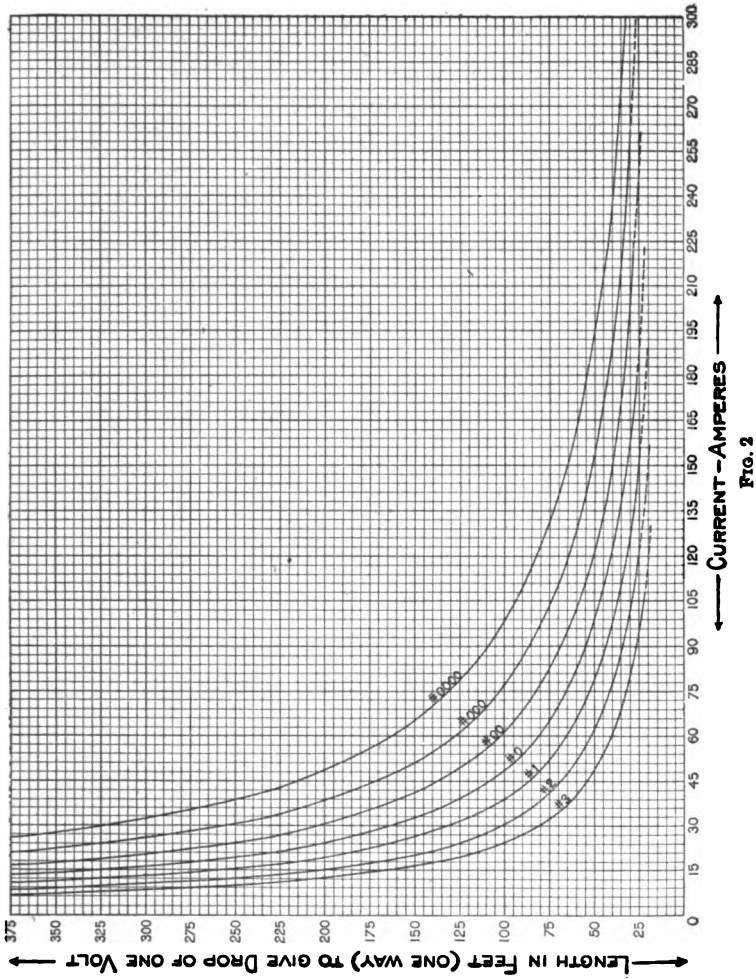

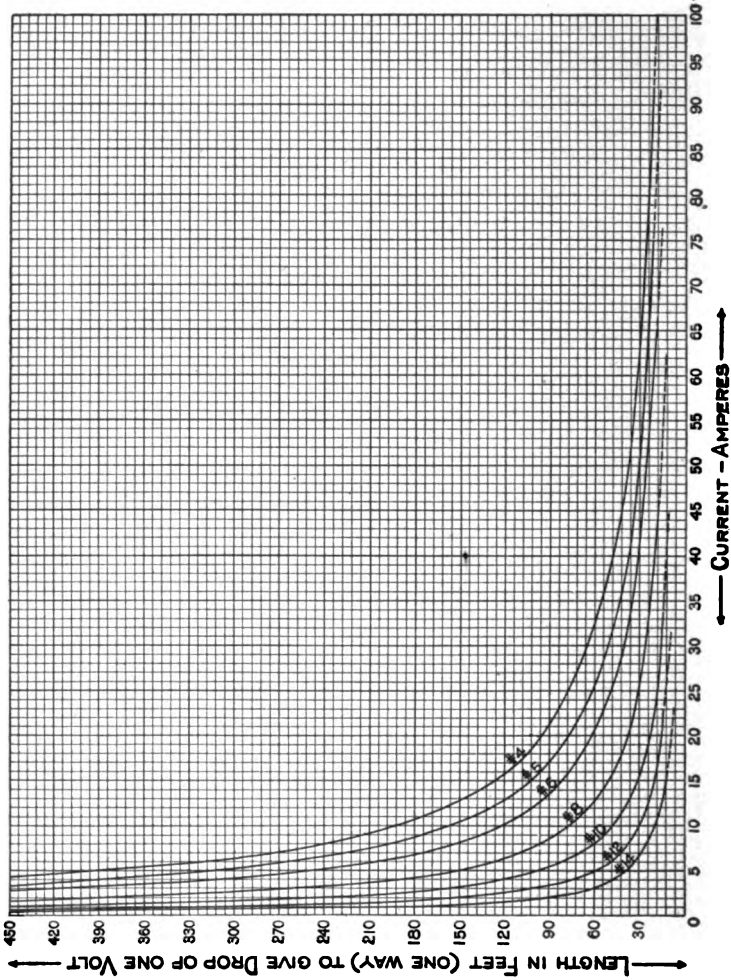

FIG. 3

$\frac{1}{4}$ ampere per lamp for 104- or 110-volt lamps, and .3 ampere per lamp for 220-volt lamps is a safe basis for calculations where good lamps are used. Also, it must be remembered that "per cent. drop" and "volts drop" are very different things, as set down in Table III.

The figures given in the table represent the actual drop, in volts, for the line voltage at the top of each column, with the percentages of drop given in the left-hand column. For example, a drop of 5 per cent. on a voltage of 150 would give 7.5 volts.

TABLE III

Per Cent. Drop	Line Voltages					
	52	104	110	150	220	250
1	.52	1.04	1.1	1.5	2.2	2.5
2	1.04	2.08	2.2	3.0	4.4	5.0
3	1.56	3.12	3.3	4.5	6.6	7.5
5	2.60	5.20	5.5	7.5	11.0	12.5
7	3.64	7.28	7.7	10.5	15.4	17.5
10	5.20	10.40	11.0	15.0	22.0	25.0
15	7.80	15.60	16.5	22.5	33.0	37.5

FUSE PROTECTION FOR CONDUCTORS IN PARALLEL

12. It is sometimes desirable to run two or more small wires in parallel, instead of one large wire or cable, for convenience in handling the wires, to obtain a certain carrying capacity with the use of less copper, to use material that happens to be at hand, or for other reasons. When two or more wires are run thus and are connected together at their ends, separate fuses must be placed in series with each wire, and not one fuse for all the wires in parallel.

Fig. 4 (a) and (b) illustrates the correct and the incorrect methods of connecting such cables. Multiple conductors of this kind may sometimes be used to advantage in overhauling or remodeling old work, where the wires originally installed are too small, and in wiring an old building by the

use of molding, where large wires cannot be handled without defacing the walls.

For convenience in comparing the conductivities of wires, Table IV is given. As an illustration, it is seen from the table that instead of a single No. 2 wire we might use a No. 4 and a No. 6; two No. 5; four No. 8; etc. Of course, nothing smaller than No. 14 can be used for interior wiring.

The conductivity is directly proportional to the total cross-section of all the conductors in parallel, and the total resistance is inversely proportional to the total cross-section.

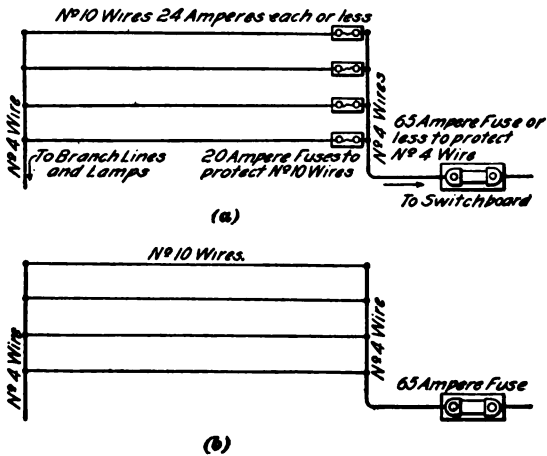

FIG. 4

13. Circuits of several wires in parallel are sometimes run where a large drop in voltage is not objectionable, but where a single wire small enough to produce that drop will not carry the current safely. Two or more small wires will safely carry more current than one large wire of equivalent cross-section, because two small wires have a greater surface area from which the heat can escape than has one wire of twice the cross-section. For instance, suppose that it is desired to run wires in molding to secure a drop of 4 volts with 65 amperes over a distance of 100 feet. Calculating the required size of wire by means of Table II, we see that No. 5 will give the required drop. But No. 5 rubber-covered

TABLE IV
EQUIVALENT CROSS-SECTION OF WIRES

Number of Wire, B. & S. Gauge	Equivalent Cross-Section, in Terms of Smaller Wires																	
	00 + 1	2—0	4—3	8—6	16—9	32—12	64—15	128—18	1 + 2	2 + 3	3 + 4	4 + 5	5 + 6	6 + 7	7 + 8	8 + 9	9 + 10	10 + 11
0000																		
000	0 + 2	2—1	4—4	8—7	16—10	32—13	64—16	128—19										
00	1 + 3	2—2	4—5	8—8	16—11	32—14	64—17	128—20										
0	2 + 4	2—3	4—6	8—9	16—12	32—15	64—18											
1	3 + 5	2—4	4—7	8—10	16—13	32—16	64—19											
2	4 + 6	2—5	4—8	8—11	16—14	32—17	64—20											
3	5 + 7	2—6	4—9	8—12	16—15	32—18												
4	6 + 8	2—7	4—10	8—13	16—16	32—19												
5	7 + 9	2—8	4—11	8—14	16—17	32—20												
6	8 + 10	2—9	4—12	8—15	16—18													
8	10 + 12	2—11	4—14	8—17	16—20													
10	12 + 14	2—13	4—16	8—19														
12	14 + 16	2—15	4—18	8—20														
14	16 + 18	2—17	4—20															
16	18 + 20	2—19																

wire will safely carry only 54 amperes, while 65 amperes is to be transmitted. By using two No. 8 wires, which are equivalent in cross-section to one No. 5, we can safely carry the current with the specified drop. If the current were still greater, we could use one No. 8 and two No. 10 wires with about the same results. However, such arrangements to secure a drop are only used in emergencies or under special conditions, and are usually only temporary expedients.

14. Calculation of Wires in Parallel.—If a number of wires are to be used in parallel to do the work of a single large wire, i. e., to carry a certain current a given distance with a specified drop, the combined cross-section of the smaller wires must equal the cross-section that the large wire would have. Suppose, for example, that a wireman at a distance from a supply house has on hand a large amount of No. 12 wire, but no larger wire, and that he desires to carry a current of 40 amperes, 150 feet (one way) with 3 volts loss. How many No. 12 wires should be connected in parallel to secure the result? Using formula 5, $I = 40$, $D = 150$, and $e = 3$; hence, circular mils = $\frac{21.6 \times 150 \times 40}{3} = 43,200$.

The cross-section of No. 12 wire is 6,530 circular mils, approximately; hence, to make up a cross-section of 43,200 circular mils, $\frac{43,200}{6,530} = 6.6$ No. 12 wires in parallel would be required. In this case, therefore, it would be necessary to use seven No. 12 wires, as this is the whole number nearest to 6.6.

Take another example. In an old building, wired with too much drop, it is desired to reenforce the mains so as to reduce the drop to 2 volts. A circuit of No. 8 wire carrying 20 amperes a distance of 150 feet is to be reenforced. What size of wire should be used?

The cross-section necessary to carry 20 amperes, 150 feet with a drop of 2 volts is, from formula 5,

$$\text{circular mils} = \frac{21.6 \times 150 \times 20}{2} = 32,400$$

No. 8 wire has a cross-section of 16,510 circular mils; hence, the cross-section to be added is $32,400 - 16,510 = 15,890$. Another No. 8 wire (16,510 circular mils) connected in parallel with the No. 8 wire already installed, will give slightly more than the required cross-section and would therefore be used.

EXAMPLES FOR PRACTICE

1. Determine, by means of formula 5, the size of wire required to carry 30 amperes a distance of 150 feet (one way) with a drop of 3 volts. Ans. No. 5 B. & S.
2. If a circuit 200 feet long (single distance) carries 25 amperes and is of No. 6 B. & S. wire, what will be the drop in volts? Ans. 4.1 volts
3. If a circuit of No. 10 B. & S. wire carries 20 amperes a distance of 200 feet (single distance) what size of wire must be connected in parallel with the existing wire to limit the drop to 2 volts? Ans. No. 5 B. & S.
4. A current of 40 amperes is to be carried 300 feet (single distance) with a drop of 3 volts. Assuming that No. 10 B. & S. is the only size of wire available, how many wires must be connected in parallel to carry the current with the specified drop? Ans. 8 wires

WIRING IN DAMP PLACES

15. Where wiring is done in damp places, special precautions must be taken and special rules observed. The following Underwriters' rules apply to this work:

Wires—

In damp places, or buildings especially liable to moisture, or acid, or other fumes liable to injure the wires or their insulation:

- a. Must have an approved insulating covering.

For protection against water, rubber insulation must be used. For protection against corrosive vapors, either weather-proof or rubber insulation must be used.

- b. Must be rigidly supported on non-combustible, non-absorptive insulators that separate the wire at least 1 inch from the surface wired over, and wires must be kept apart at least $2\frac{1}{2}$ inches for voltages up to 300 and 4 inches for higher voltages.

Rigid supporting requires under ordinary conditions, where wiring over flat surfaces, supports at least every $4\frac{1}{2}$ feet. If the wires are liable to be disturbed, the distance

between supports should be shortened. In buildings of mill construction, mains of No. 8 B. & S. gauge wire or over, where not liable to be disturbed, may be separated about 6 inches, and run from timber to timber, not breaking around, and may be supported at each timber only.

Sockets—

a. In rooms where inflammable gases may exist, the incandescent lamp and socket must be enclosed in a vapor-tight globe and supported on a pipe hanger, wired with approved rubber-covered wire soldered directly to the circuit.

b. In damp or wet places or over specially inflammable stuff, waterproof sockets must be used.

Waterproof sockets should be hung by separate *stranded*, rubber-covered wires, not smaller than No. 14 B. & S. gauge, which should preferably be twisted together when the pendant is over 3 feet long. These wires should be soldered direct to the circuit wires, but supported independently of them.

Fig. 5 shows a waterproof globe for use where inflam-

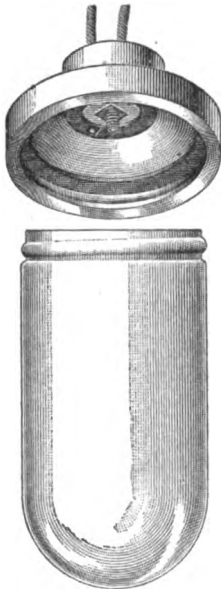

FIG. 5

and cause short circuits.

mable gases may exist. In wiring damp cellars, it is especially desirable to have the lamps divided among several small circuits, so that the blowing of a fuse will not put out many lamps. In such work, rosettes should never be used, but the drop wires should be soldered to, but not supported by, the line wires, and the joints should be thoroughly wrapped with insulating tape. The cut-outs should be placed outside the cellars, in a dry place, if possible, otherwise they should be placed in waterproof boxes. It should be noted that, in damp places, particular attention must be paid to the character of the insulation. There must be a clear air space around the wires so that there will be no chance for moisture to accumulate

CONCEALED WIRING

16. **Concealed wiring** is usually installed according to one or more of the following methods: *concealed knob and tube, conduit, and molding*. Concealed knob-and-tube work has been used in the past more than either of the other methods; it is the cheapest of the three and is quite safe if properly installed. The local rules governing wiring in some of the larger cities have recently prohibited this class of work, but it is allowed by the Underwriters' rules. Conduit work is expensive and the knob-and-tube plan affords a means of concealing wires at comparatively small cost and, while it is unquestionably not as safe or as permanent as the conduit method, there is no reason why it should not be safe and satisfactory if the work is done as it should be. It is much used for dwelling houses or similar places where the cost must be kept down. Conduit wiring involves the installation of a complete piping system in addition to the wiring system so that the cost becomes very great. It represents the best method of wiring and is now used on all important work where the highest degree of safety and permanence is required. It is the only class of wiring to be considered for fireproof office buildings, hotels, or similar structures. The use of molding work is confined almost entirely to old buildings where the wires cannot be concealed and where it is necessary to run them in woodwork to match the woodwork in the rooms. Very often concealed knob-and-tube work can be combined with conduit work to advantage, flexible conduits being very useful where wires must be fished for short distances or where they have to be run in places where there is not room enough for supporting them on porcelain insulators. The concealed knob-and-tube method does not afford the wiring mechanical protection, and consequently is not suited to places where the conductors are liable to be disturbed or come in contact

with other objects. However, in non-fireproof buildings where the wires can be run between the joists there is little danger of their being disturbed, and wires well supported on knobs have amply high insulation. The class of work to be used in any given case will depend on the character of the building to be wired, the allowable cost, and on the local regulations, if any, governing the wiring of buildings.

CONCEALED KNOB-AND-TUBE WORK

17. The most common way of concealing wires in non-fireproof buildings is to run them through the joists between the floors and ceilings

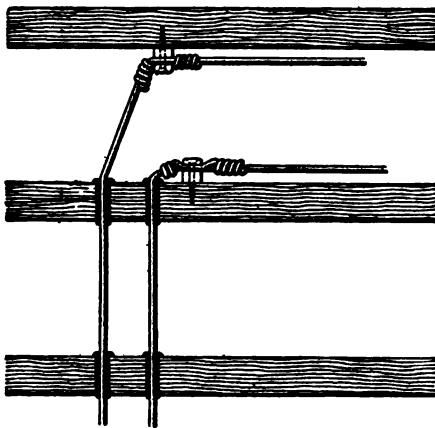

FIG. 6

and through studding partitions, and to insulate them by means of porcelain knobs and tubes, as shown in Fig. 6. The holes should not be closer together than is allowed by the Underwriters' rules, and the tubes should fit tightly in the holes. When the holes are not horizontal, but are bored from above or below obliquely, the tubes should be put in with their heads on the high side, so that they cannot fall or slide out; and when tubes are placed so that there is any strain on them, their heads must be so placed that the tubes cannot slip. Holes should be bored of such a size that the tubes can be inserted by driving lightly. Do not make the holes too small or there will be danger of breaking the tubes. Holes must be bored sufficiently far away from

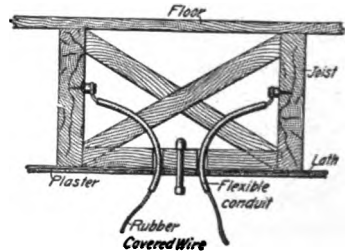

FIG. 7

the floors and ceilings to be out of reach of nails that may be driven into the joists after the work is concealed. Bushings must be long enough to reach all the way through the joists, with $\frac{1}{2}$ -inch projection.

18. Where wires come through the plaster to outlets or cut-outs, they must be protected by flexible insulating tubes

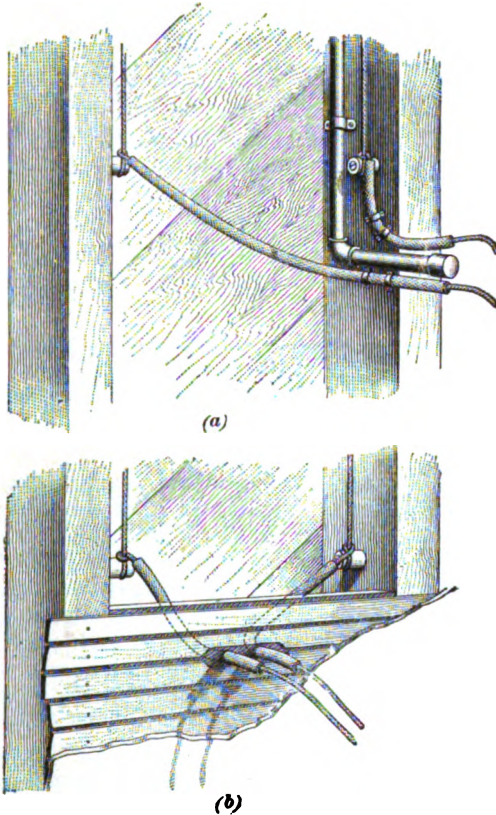

FIG 8

that will preclude all possibility of contact between the wires and other objects. Careless work is often done at outlets, with the result that a job that is otherwise well put up will show poor insulation. The same outlets are very often used

both for gas and electricity, and if the wires are not well protected where brought out, a ground on the gas-pipe may result.

Fig. 7 shows the method of bringing out a ceiling outlet with knob-and-tube work. The flexible conduit used to protect the wires projects as far as, or slightly beyond, the end of the pipe and runs back as far as the porcelain support next to the outlet. Fig. 8 (a) and (b) shows two methods of bringing out side-wall outlets, (a) being a combination gas and electric outlet and (b) a plain electric outlet. The latter shows a board nailed across between the studs to support the fixture. In both cases the flexible conduit extends back to the insulators, as required by rule (d).

19. For running wires parallel to joists, knobs are generally used because they make it possible to keep the wires well separated. The following rules apply to this kind of work:

Wires—

For concealed knob-and-tube work:

a. Must have an approved rubber insulating covering.

b. Must be rigidly supported on non-combustible, non-absorptive insulators that separate the wire at least 1 inch from the surface wired over, and must be kept at least 5 inches apart, and, when possible, should be run singly on separate timbers or studding. Must be separated from contact with the walls, floor timbers, and partitions through which they may pass by non-combustible, non-absorptive insulating tubes, such as glass or porcelain.

Rigid supporting requires under ordinary conditions, where wiring along flat surfaces, supports at least every $4\frac{1}{2}$ feet. If the wires are liable to be disturbed, the distance between supports should be shortened.

c. When, in a concealed knob-and-tube system, it is impracticable to place any circuit on non-combustible supports of glass or porcelain, approved metal conduit, or approved armored cable must be used except that if the difference of potential

between the wires is not over 300 volts, and if the wires are not exposed to moisture, they may be fished on the loop system if separately incased throughout in continuous lengths of approved flexible tubing.

In general, when conduit of any kind is used in connection with concealed knob-and-tube work, it must be installed in accordance with the rules governing the use of conduit as given later. In most interior wiring for lighting work, the pressure between any pair of wires will not exceed 300 volts, so that in cases where it is necessary to pass wires through spaces where porcelain supports cannot be used on account of lack of space or because they must be run through some place that is inaccessible, it is allowable to fish the wires through provided they are separately incased in flexible tubing. The loop system referred to in rule (c) is explained in connection with conduit wiring. It should be particularly



FIG. 9

noted that wires must not be run through flexible tubing in cases where dampness is present. The armored cable referred to in rule (c) would seldom be required in connection with knob-and-tube work in a new building where everything is accessible; but in an old building where there are objections to tearing up floors to insert wires, it may often be used to advantage, particularly if the wires are liable to be exposed to mechanical injury.

Fig. 9 shows an *armored twin cable*; the wire is rubber-covered and over the heavy insulation is wound a steel strip that interlocks so as to form a continuous protection. It is possible to use armored cable for the complete wiring of a building, in which case outlet boxes, etc. are provided as in conduit wiring, described later. The conduit system is, however, preferable because the wires can be withdrawn. Where armored cable is used in damp places it must have a lead

sheath between the insulation and the armor. Protected flexible cord, of the same style, is a very convenient article to use in wiring offices, banks, etc., where small conductors must be carried behind desks or fastened to iron or cabinet work, and in many other places where ordinary cords will not do and will not be permitted.

The following rule governs the arrangement of the wire at outlets when it is run on the concealed knob-and-tube plan:

d. Must at all outlets, except where conduit is used, be protected by approved flexible insulating tubing, extending in continuous lengths from the last porcelain support to at least 1 inch beyond the outlet. In case of combination fixtures, the tubes must extend at least flush with the outer end of the gas cap.

It should be particularly noted that in concealed knob-and-tube work, or in fact in any kind of concealed wiring, the wire must be rubber-covered. Weather-proof or fireproof and weather-proof wires are prohibited for concealed work. The calculations for concealed wiring are the same as for open work; but it must be remembered that rubber-covered wires are not allowed to carry as much current as weather-proof wires, as shown by the Underwriters' table of carrying capacities.

20. Use of Cabinets and Panel Boards.—For concealed work, the closet, or cabinet, system of distribution is now universally used. In it the mains are run to *cabinets* or *panel boards* set in the wall, and the lines running to the lamps are distributed from these. Many styles of these panel boards are manufactured, and the kind used will depend largely on the size and allowable cost of the installation. For the cheaper class of work, the cut-outs may be grouped together and placed in a cabinet formed in the wall. This cabinet should be neatly lined with $\frac{1}{8}$ -inch asbestos secured in place by tacks and shellaced. Where the wires pass into and out of the sides or bottom, they should be bushed with porcelain tubes. A neat glass or asbestos-lined door should be provided. A cabinet made in this way is

inexpensive and safe, though slate- or marble-lined cabinets are much better and their use is strongly recommended. Slate- or marble-lined cabinets should always be provided with a job of conduit wiring.

Fig. 10 will give an idea as to the essential parts of a panel board. In this case, the wires are run in conduits. The box is mounted in the wall and consists of two compartments, the inner compartment containing the panel board, and the outer one, or *gutter*, as it is sometimes called. All boxes are not provided with this gutter, but the best ones are, as it gives a convenient space in which to arrange the wires in case they should not come to the box in the best order for connecting up. The box is made of slate or marble slabs. The trim around the door covers the gutter; it should be put up with screws so that it may be removed if necessary.

The mains usually pass through the panels vertically and are con-

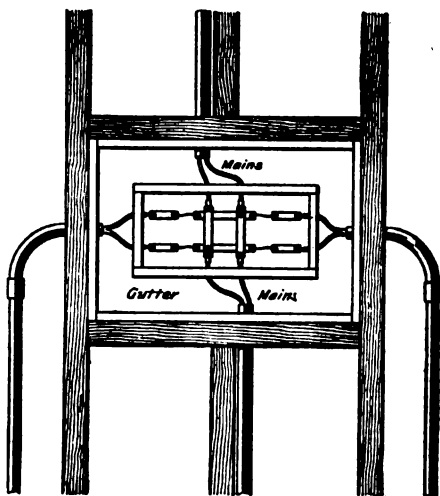

FIG. 10

nected to bars from which the various lamp circuits branch out sidewise. Fuses are inserted in each side of each circuit, and switches are also provided in some cases, though sometimes the panel board carries fuses only in case the switches are located near the lamps rather than at the center of distribution represented by the fuse cabinet.

Fig. 11 shows a panel board equipped with double-pole knife switches *a* and enclosed fuses *b*. Eighteen branch circuits are accommodated and the three-wire vertical mains are attached to the copper bars *c, c, c*; the mains enter at the bottom, being conducted to the board through the large

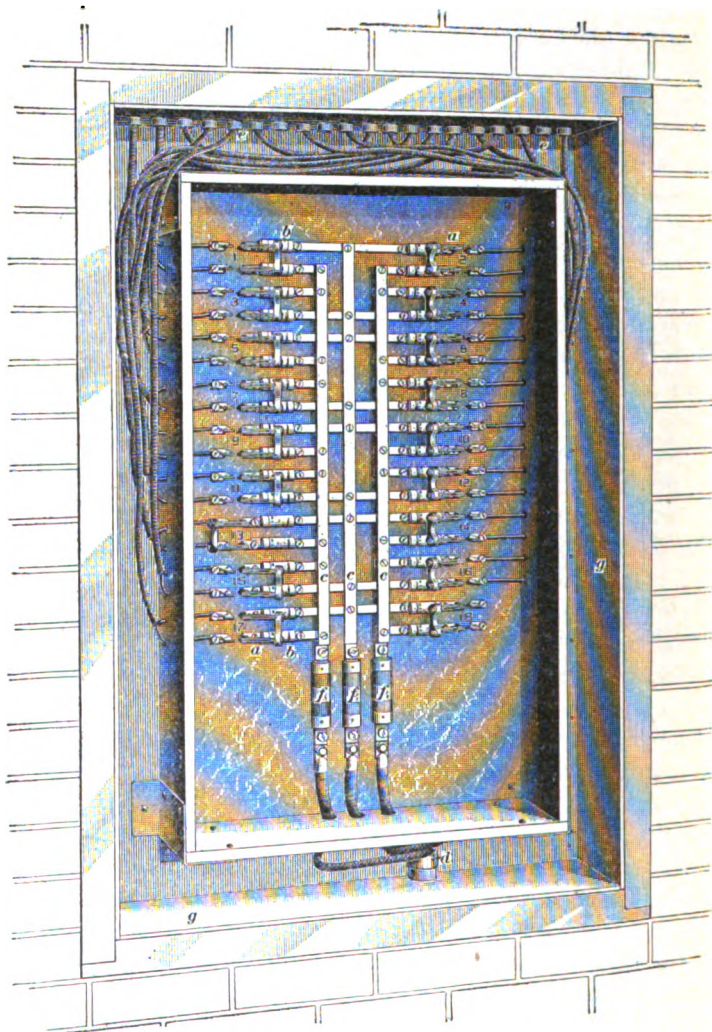

FIG. 11

conduit *d* that projects a short distance into the gutter, or distribution compartment. The casing and door are removed in order to show the method of bringing the wires around to the various switches. The outgoing circuits are carried through the conduits *e* that enter at the top, each conduit containing a twin wire. The panel board constitutes the back of the cabinet and the sides and ends are of $\frac{1}{8}$ -inch slate. The main fuses are of the enclosed type and are

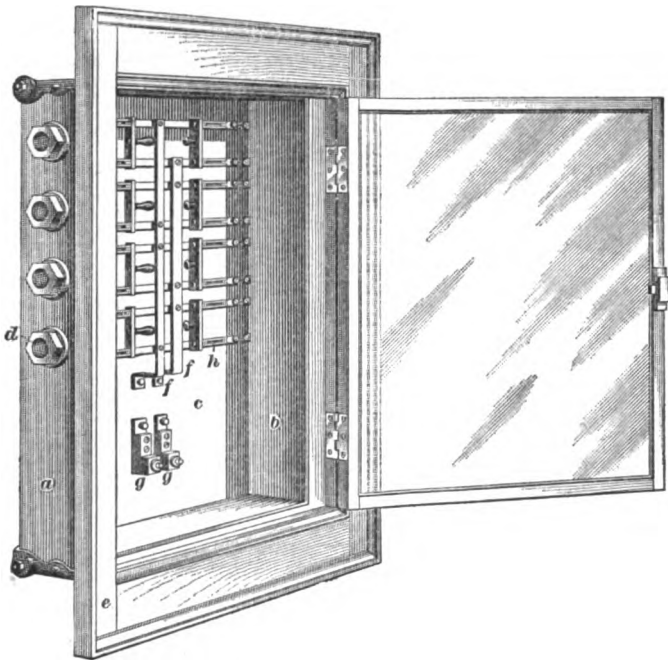
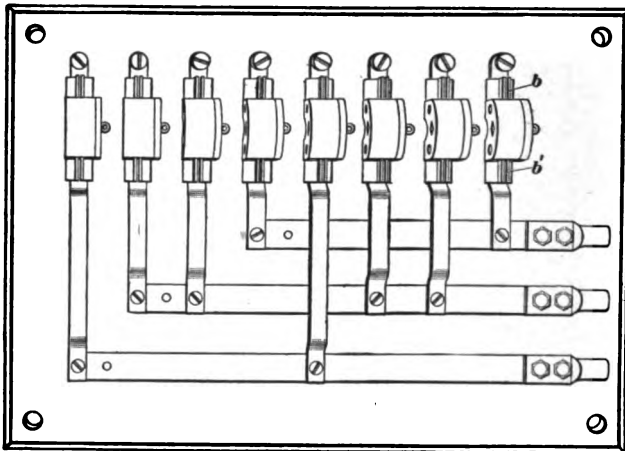

FIG. 12

shown at *f*. The lining *g* of the gutter is of $\frac{1}{8}$ -inch enameled iron or $\frac{1}{4}$ -inch slate or marble. With knob-and-tube work the gutter may be lined with $\frac{1}{8}$ -inch asbestos firmly tacked in place, though it is always better to use slate or marble lining.

21. Instead of building a box of slate or marble pieces, iron or steel boxes lined with slate or marble are much used. Fig. 12 shows a cabinet of this kind ready to be set

into the wall and connected up. It is made of a sheet-steel box *a*, whose sides and top are lined inside with $\frac{1}{4}$ -inch slate slabs *b*. The panel board *c* constitutes the back of the box. In the figure the openings *d* for the branch circuits are arranged to take conduits. The two-wire vertical mains are connected to terminals *g, g* and, through the main fuses, to the bars *f, f*. Each branch circuit is provided with fuse terminals and a knife switch *h*.



(a)

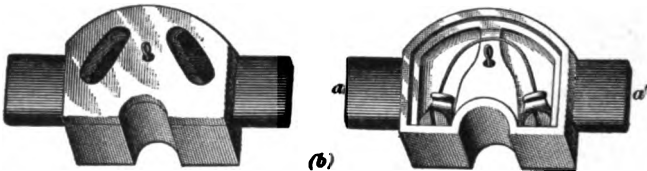

(b)

FIG. 18

Fig. 13 (a) shows a style of panel board that uses a special kind of fuse holder which serves the purpose of a switch when it is desired to disconnect any circuit. Panel boards using combination fuse holders have been adopted quite largely, for they have one advantage in that the holder may be entirely removed from the board when the fuse is being replaced, or a reserve holder may be put in instead of the one

removed. Fig. 13 (b) shows one of these holders. It is held in place by the clips *b, b'*, shown in (a), that receive the blades *a, a'*. Link fuses are here used; they are allowable because the fuse holder is used in a fireproof cabinet and not in an open cut-out. Fig. 14 shows a plain two-wire board for four branch circuits; it is equipped with Edison fuse plugs and has no switches. The foregoing will give a general idea as to the construction of these boards. They are made in all sorts of combinations and, in fact, are usually made to order for any given job. In large wiring systems, the design of the

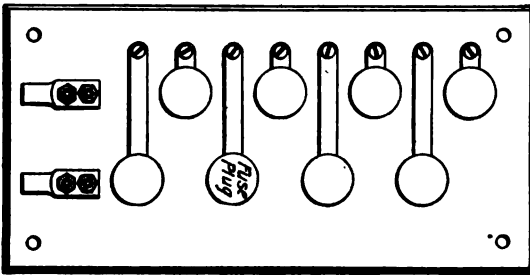

FIG. 14

cut-out closets, or cabinets, is a matter of great importance, and the location of these closets is equally important; they should be placed in a position where they can be readily reached.

Cabinets must be provided with a substantial door; if glass is used it must not be less than $\frac{3}{8}$ inch thick nor more than 1 foot wide. At least 2 inches clear space must be allowed between the fuses and the glass. The door must close against a rabbet, so as to be dust-tight, and bushings through which the wire enters must fit the box tightly. Wires should completely fill the holes in the bushings; if necessary, the wire should be built up with tape so as to keep out dust.

WIRING A DWELLING HOUSE

22. In laying out the wiring for a dwelling house, the first thing to do is to locate the cut-out cabinets. In many dwelling houses, only one cabinet may be necessary, but in houses designed to be occupied by more than one tenant, a cut-out cabinet should be installed for each

tenant. In large houses, it is often convenient to have a cut-out cabinet on each floor, with vertical mains running through them from the top to the bottom of the house. If only one distributing point is used, it should be either in the cellar or attic and risers should run to the different floors. If it is known that the wires are to enter the building in the cellar, the distributing center should be located there; if the wires enter in the attic, the distributing point should be located there. This assumes that vertical risers are run from the distributing center to feed the various floors. In case a single pair of vertical mains is used with the circuits branching off on each floor, the mains may be run from the top to the bottom of the house and the current supplied from either end.

No matter what arrangement is adopted for distributing the current, the distributing centers, or cut-out cabinets, should be in or near a partition that is located so as to make the running of risers easy. They should also be as near the center of the building as possible and on an inside wall, so as to guard against dampness.

23. Figs. 15 and 16 show two floors of a typical dwelling. The distributing points are located in the hallway near the center of the house, because such location is central and easy to get at. The various branch circuits on the plans are indicated by single lines, although each line represents two wires. The wiring is supposed to be done on the ordinary concealed knob-and-tube system and no circuit carries more than ten lights. Switches are placed on the side walls, as shown at *s*. The switch for controlling the hall lights should be placed at some convenient point near the door, so that the lights may be turned on when entering the building. It is sometimes convenient to have another switch at the head of the stairs for controlling the hall light, so that the light may be turned on or off from either above or below. This requires the use of three-point switches, the necessary connections for which will be explained later. In the plans, double-pole switches are indicated; single-pole switches,

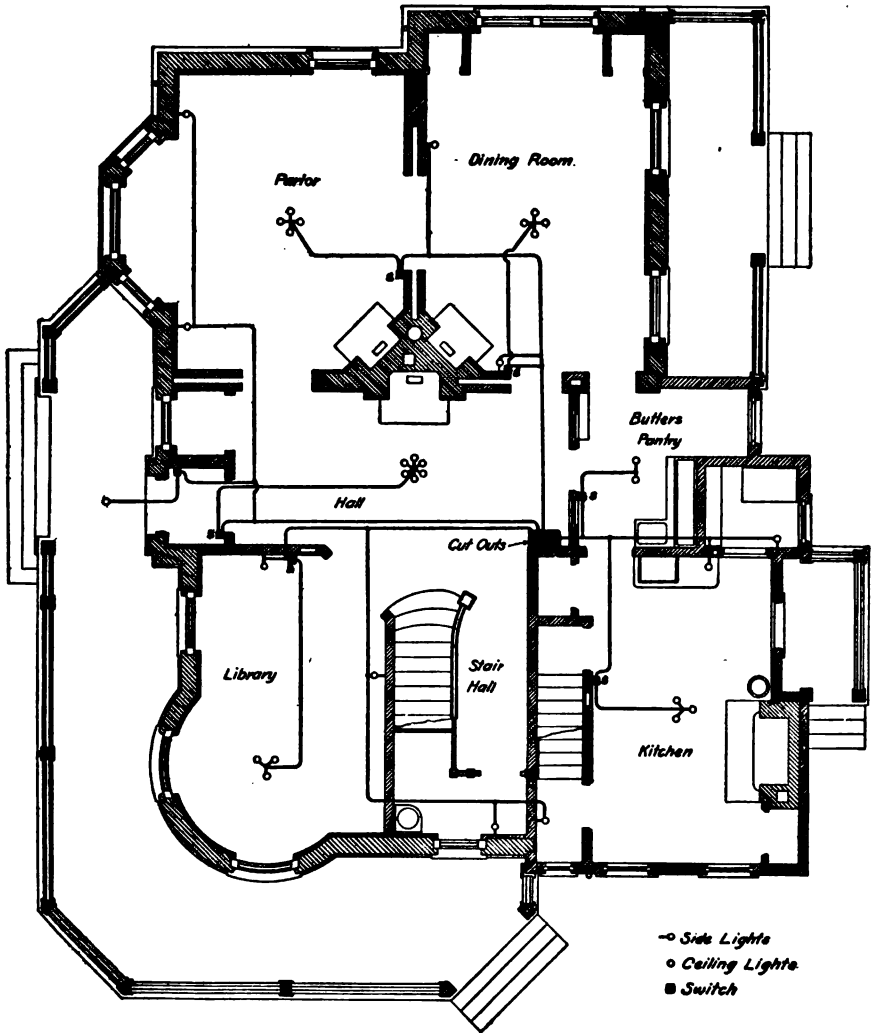

FIG. 15

which are cheaper to install, may, however, be used when not over 660 watts are controlled.

24. Laying Out Circuits.—In laying out the various branch circuits, the first thing to do is to locate the lights on the plan and then group these lights for the different circuits, so that there will not be more than ten or twelve lights on each one. After this is done the lines may be marked; in doing this, due regard should be given to the direction in which the joists run, so that the wire may be put in with as little boring and cutting as possible. Run parallel to the beams wherever it can be done, even if it does take a little more wire. The best time to wire the building is after the floorbeams and studding are in place, but before any lathing or plastering has been done. In Fig. 15, four circuits are provided, all terminating in the cut-out cabinet in the hall, where they are attached to the vertical mains. For the second floor, Fig. 16, three circuits are sufficient. No. 14 wire is used for all these circuits. It will be found that No. 14 wire (the smallest that the Underwriters allow) is large enough for any of the branch circuits met with in ordinary house-wiring work. The number of lights per circuit is small and the distances short, so that No. 14 will carry the current with but a small drop in voltage.

25. The Mains.—If vertical mains are used, the current that they will carry will be less at one end than at the other, because current is taken off at the different floors. It is usually advisable, however, to make the mains the same size all through an ordinary house, because it costs but little more and enables the current to be supplied from either end. In large buildings, where it would not pay to do this, it is customary to install a number of risers feeding different sections of the building and running to a common distributing point, usually located in the basement. The mains must, of course, be designed to carry the current in accordance with the Underwriters' requirements or to limit the drop to the allowable amount if the wire required by the Underwriters will give too much drop. Suppose that the

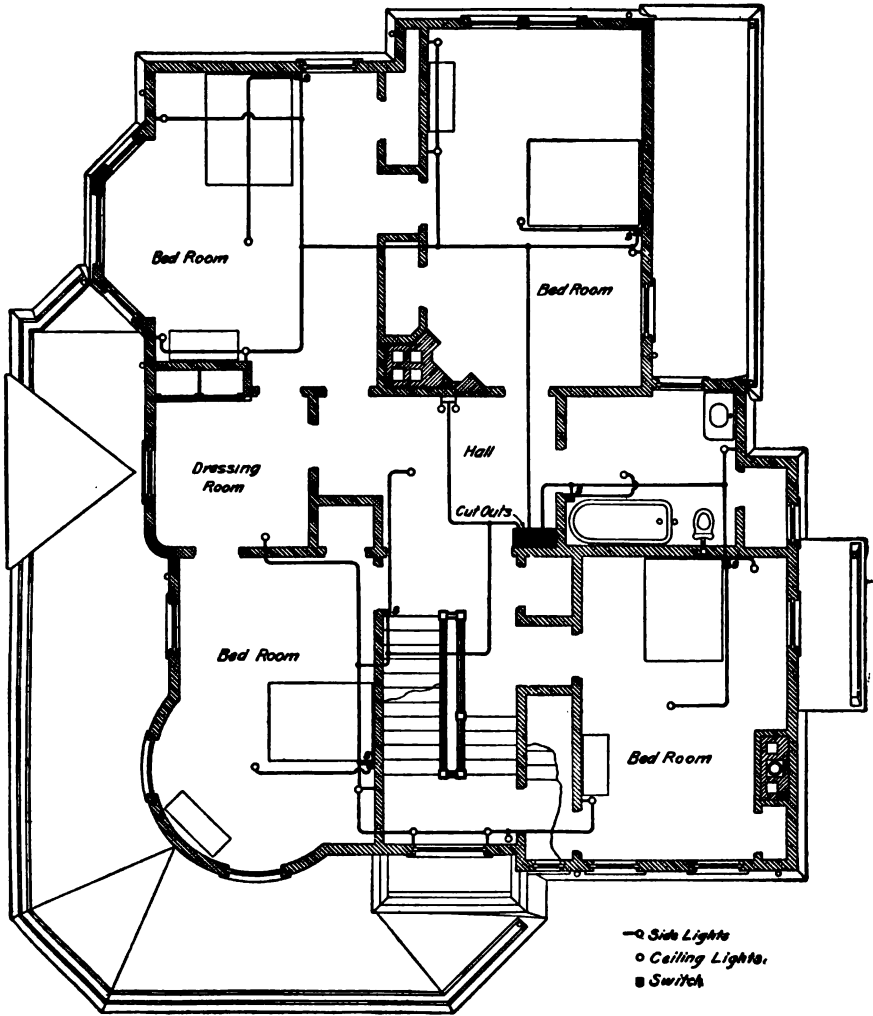

FIG. 16

house under consideration has a total of 60 lamps. The current in the mains will then be 30 amperes, and at least a No. 8 wire will be required to satisfy the Underwriters' requirements.

By referring to Table II, it is found that No. 8 wire will carry 30 amperes a distance of 25.5 feet with a drop of 1 volt. For a building of this kind, the drop from the point where the current enters the building to the lamps should not exceed 2 to 2.5 volts. The drop in the branch circuits is very small, but it would be advisable to put in No. 6 mains, as the difference in first cost will be but little. It is the usual practice to make the mains of liberal cross-section. For a house of this size No. 4 would often be used, although it does not need to be as large as this so far as drop is concerned.

26. Main Switch, Cut-Out, and Meter.—At a convenient point near the place where the wires enter the building, a main cut-out and switch must be placed, as required by the Underwriters. The cut-out should be placed nearest the point of entry, the switch next to it, and the meter last. Never permit the meter to be installed between the switch and the cut-out, as in that case it may register a small amount each day, even if the switch is open. If a knife-blade switch is used at the entrance to the building, it should be placed so that when opened it will not tend to fall closed of its own accord. It is also advisable to place it in an asbestos-lined box provided with a lined door.

The best arrangement of the wires for the meter will depend to some extent on the type of meter used. In a great many cases, however, the wires enter the left-hand side of the meter and pass out at the right. Fig. 17 represents a typical arrangement of main fuses, switch, and meter.

Most recording electric meters consist of a small electric motor, the revolving part of which turns on jeweled bearings and is connected to a train of gears and dials. The motor is governed by means of retarding devices, so that it runs at a speed accurately proportional to the load. Some

meters read in ampere-hours, but most of those now installed read in watt-hours and are provided with two coils, one of which is connected in series with the circuit, like an ammeter, and the other across the circuit, like a voltmeter. The current in the first is, therefore, equal to the current supplied, and the current in the second is proportional to the voltage. The force tending to drive the motor is, therefore, proportional to the product of the amperes and volts, i. e., to the watts. The small third wire running into the meter, Fig. 17, is to supply current to the potential coil. With ampere-hour meters, a series coil only is used, and the speed of the meter is proportional to the current and not to the watts.

The voltage of a lighting system is, however, practically constant, so that the watt-hours may be obtained by multiplying the ampere-hours by the voltage without serious

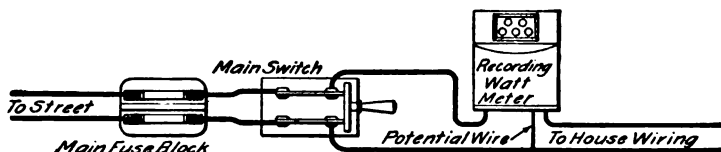

FIG. 17

error. Reliable meters are made for all voltages and systems and for alternating or direct currents. They are accurate to within 98 per cent. on ordinary loads, but are liable to be out as much as 5 per cent. on small loads, and most meters will take a very small load without turning at all. However, they are seldom operated under such conditions.

27. In new buildings, it is often not known what system of electric lighting will be used when the wiring is finished. Owners also desire quite frequently to be able to avail themselves of any advantage in price that may be brought about by competition between different systems. It is therefore desirable that each new house shall be wired in such a manner that light may be secured from any system in use; that is, from 110- or 220-volt two- or three-wire systems.

The following typical specifications cover all the main points necessary for such a piece of work in an ordinary dwelling house.

Other details, such as the location of additional switches, the use of particular kinds of cut-outs, etc., may be added to these specifications if desired. The specifications cover only the concealed work.

Specifications for Concealed Electric-Light Wiring

For 110- or 220-Volt Systems

Distribution Cabinet	<p>A distribution cabinet is to be located on some inside wall; in a readily accessible place, on the second floor or the attic, as near the center of the building as possible.</p>
Circuits	<p>The cabinet must be lined with slate $\frac{1}{4}$ inch thick and fitted with a door covered on the inside with slate $\frac{1}{4}$ inch thick.</p>
Fuses	<p>From this cabinet separate circuits must be run to the outlets in such a manner that not more than ten 16-candlepower incandescent lamps shall be placed on any circuit. Whenever the number of lamps is not marked on the plans or otherwise specified as greater than here required, pendants shall be considered as intended to carry four lamps each and brackets one lamp each.</p>
Wires	<p>All fuses must be located on a panel board placed in the distribution cabinet. The panel boards must be of slate at least $\frac{3}{4}$ inch thick and be provided with terminals designed for enclosed fuses. Both sides of all lines must be fused and the fuses must be of a type suitable for use on 220 volts and capable of interrupting the arc due to a 220-volt short circuit.</p>
	<p>All circuits running from the distribution center must be of No. 14 B. & S., or larger,</p>

rubber-covered copper wire of a make accepted by the National Board of Fire Underwriters.

Mains

From the distribution cabinet to the attic, and also to the basement, a pair of mains must be run, the size of which will depend on the total number of lights in the house, as follows:

- 17 lamps, or less . . . No. 14 or larger
- 18 to 24 lamps, or less . . . No. 12 or larger
- 25 to 33 lamps, or less . . . No. 10 or larger
- 34 to 46 lamps, or less . . . No. 8 or larger
- 47 to 65 lamps, or less . . . No. 6 or larger

If the house contains more than sixty-five lamps, it is advisable to have more than one distribution center and pair of mains.

Extra Wire

A third wire, two sizes smaller than these mains, must also be run from the attic to the basement, through the distribution cabinet, to make possible the use of the three-wire system.

Manner of Fastening Wires

Wires running parallel to joists must be fastened on porcelain knobs, placed on different timbers, and kept as far apart as possible. In passing through joists, floors, and other wood-work, the holes must be bushed with porcelain tubes, which must extend at least $\frac{1}{4}$ inch through the wood and be so arranged that their weight will tend to keep them in place rather than to cause them to slip out.

Space Between Wires

All wires must be kept at least 5 inches away from one another, from gas or water pipes, iron beams, bell or annunciator wires, speaking tubes, furnace pipes, and other conducting materials, except at the distribution cabinet and fixture outlets. Where wires cannot be kept this far apart they must be run in conduits.

Outlets

Flexible insulating conduits must be used at outlets. Special care must be taken to insulate from the gas pipe at outlets.

Running
Along Brick
or Stone
Walls

Main-Line
Cut-Out and
Fuse

Inspection,
Certificate,
and
Payment

Brick and stone walls must be avoided wherever possible. Wherever wires pass along them, they must be incased in approved conduits.

There must be supplied and installed by the contractor a main-line cut-out and a quick-break switch, both double-pole, to be located in the attic at the end of the feeder lines. These devices must be approved by the Underwriters as capable of breaking the current for the total number of lamps wired, at either 110 or 220 volts. Knife switches, if used, must be so connected that they open downwards and the blades must be "dead" when the switch is open, and must be mounted in an asbestos or slate-lined box provided with a similarly lined door.

The contractor must notify the Underwriters' Association of the progress of his work in time to have a thorough inspection made (2 days before work is concealed at least). He must secure a certificate from that Association stating that the work is suitable for use on 110- or 220-volt service, two- or three-wire systems, before any payments shall be made to him.

SWITCHES

28. Switches located at various points on the walls of rooms are a great convenience and should be installed on all first-class jobs of any magnitude. The single-pole snap switch (for not more than 660 watts) is the simplest and cheapest. It opens one side of the circuit only. Next in frequency of its use is the double-pole snap switch for larger chandeliers or groups of lights. In addition to these, there are a number of special uses of switches to allow lamps to be controlled from two or more points.

29. Control of Lamps From Two Points.—Fig. 18 (a) and (b) shows a switching arrangement for controlling

the light or group of lights L from two points A and B . This scheme is used principally in halls where it is desired to control the light from either up or down stairs. It requires two three-point switches S, S' , which are here shown as simple lever switches. There are a number of different makes of switches for this purpose, but the principle of all is the same, though the mechanical details may differ. By comparing the diagrams with whatever make of switch he may have to install, the wireman should have no

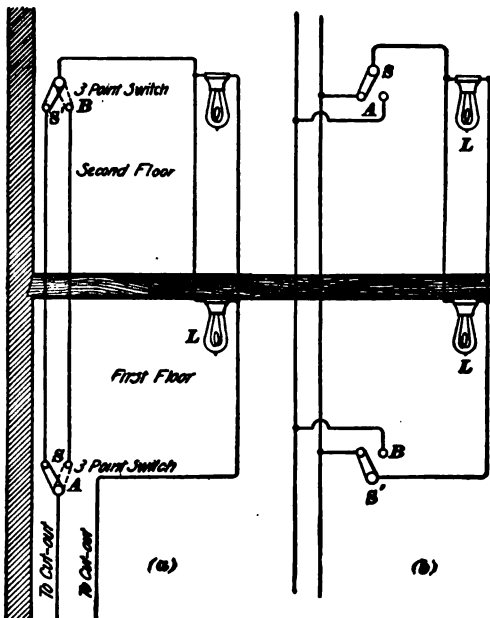

FIG. 18

difficulty in getting the connections correct. By examining the connections, it is seen that the lamps L may be lighted or extinguished from either point. Either method of connection (a) or (b) may be used, and the one that will be most convenient in any given case will depend to some extent on the general layout of the wiring.

A modification of this arrangement is shown in Fig. 19 (a) and (b). In this case, one of the three-way switches is

replaced by a three-way socket. By using a three-way socket on the fixture in connection with a three-way switch on the side wall, a lamp may be turned on or off either at the socket or at the switch. Both schemes of connection (a) and (b) accomplish the same result, and the one that is most convenient in any case will depend considerably on the location of the supply mains.

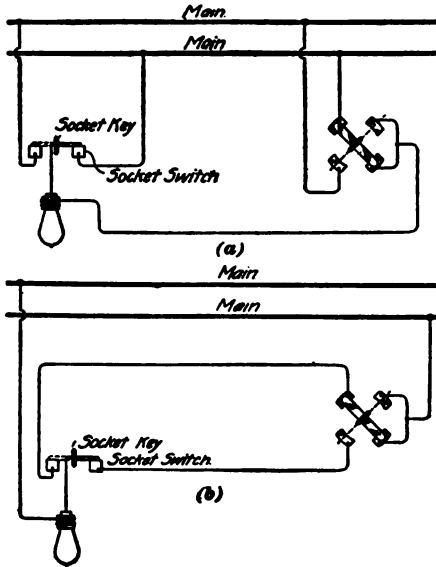

FIG. 19

to control lights from three stations, as indicated in Fig. 20, it is necessary to use two three-point switches *A*, *C* for the end stations and a four-point switch *B* for the middle station. When *B* is in the position shown,

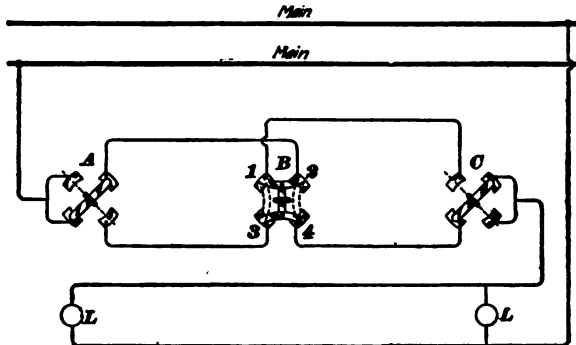

FIG. 20

points 1 and 2 and points 3 and 4 are connected together. When the switch is turned, these connections are broken and

points 1 and 3, 2 and 4 are connected. By tracing out the path of the current, the student will see that the lights may be turned on and off from any station independently of the position of the switches at the other stations. By cutting in a four-point switch for each additional station this scheme can be extended to any number of stations desired, and is often used for stairways in apartment houses.

31. Electroliter Switches.—These switches usually have three or four points and are used in connection with electroliters to enable a part or the whole of the lights to be operated as desired; sometimes they are mounted in the electroliter itself. They are made in a variety of forms and the connections necessary are, as a rule, easily understood by an examination of the switch that it is proposed to use.

32. Snap Switches.—Fig. 21 shows a typical single-pole snap switch; the same type of switch is made double-pole; also, three-point and four-point for the control of lamps from two or more stations. The wires come through the porcelain base of the switch and are held in posts *a b*, which

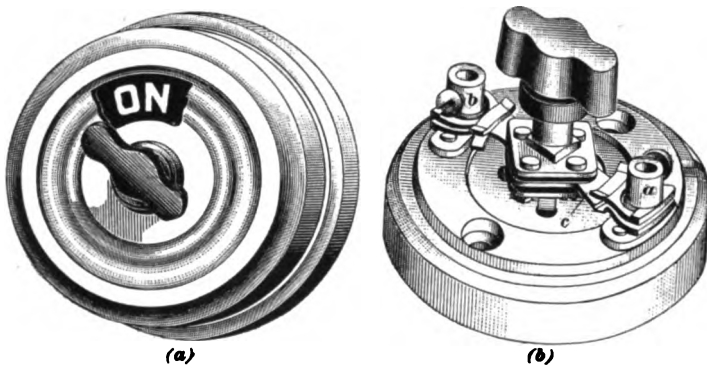

FIG. 21

also carry the switch contacts. When the switch is closed, the rotary cross-piece *c* makes connection between posts *a b*, thus closing the circuit. A double-pole switch has two pieces *c* and four contact posts. It is desirable to have snap switches provided with an indicating dial, as shown in Fig. 21 (a),

unless the position of the switch handle shows clearly whether the switch is "on" or "off." Indicators are specially useful when a number of switches are mounted together. Snap switches are comparatively inexpensive but they project from the wall and do not make as neat a job as flush switches, which set into boxes placed in the wall. With conduit wiring, flush switches are nearly always used and, even with concealed knob-and-tube wiring they are used on jobs where a neat appearance is desired.

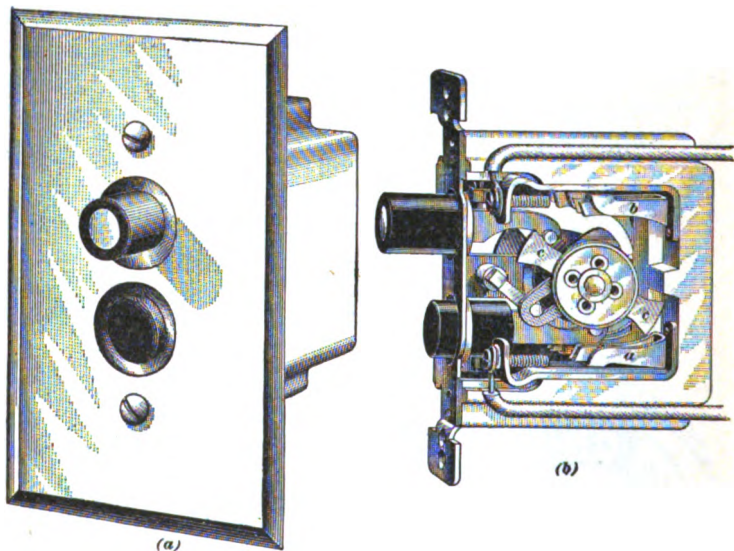

FIG. 22

Fig. 22 (a) shows the general appearance of a flush switch of the push-button type. The mechanism (b) is double pole and when the light button is pushed in, cross-piece *cc* swings around and makes contact between clips *a* and *b*. In order to prevent arcing at the contacts, all switches are constructed so that they will open or close with a quick positive motion.

When switches are mounted flush, an iron box must be provided in which to place them. This box may be either of cast iron or stamped steel and must completely enclose

the switch, thus providing a protection in addition to the usual porcelain base that carries the switch mechanism.

Fig. 23 shows a stamped-steel switch box. The cover, which carries the switch, is attached to the box by means of screws passing through slotted holes. This allows the switch to be placed square even though the box may have been mounted slightly crooked or displaced slightly during the installation of the wires. Steel boxes can be obtained with any combination of inlet holes so that they can be suited to wires coming in from any direction. In many cases the boxes are made so that pieces of metal can be knocked out, thus making holes wherever desired. There should be no holes in the boxes other than those used for bringing in the conduits.

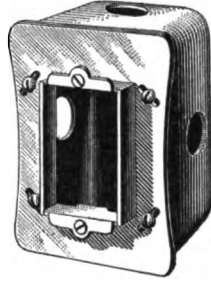

FIG. 23

FIXTURES

33. The selection of suitable fixtures and the proper wiring of them are important matters. The wireman should not be satisfied to put up any fixtures that may be furnished. He should examine them and test them himself. The following rules should be observed:

Fixtures—

a. Must, when supported from the gas piping or any grounded metal work of a building, be insulated from such piping or metal work by means of approved insulating joints placed as closely as possible to the ceiling.

Gas outlet pipes must be protected above the insulating joint by approved insulating tubing, and where outlet tubes are used they must be of sufficient length to extend below the insulating joint, and must be so secured that they will not be pushed back when the canopy is put in place.

Where canopies are placed against plaster walls or ceilings in fireproof buildings, or against metal walls or ceilings or plaster walls or ceilings on metallic lathing in any class of buildings, they must be thoroughly and permanently insulated from such walls or ceilings.

b. Must have all burrs, or fins, removed before the conductors are drawn into the fixture.

c. Must be tested for contacts between conductors and fixture, for short circuits, and for ground connections before it is connected to its supply conductors.

34. Rule (*c*) is important. In wiring up fixtures, it is an easy matter for the fixture wire to become grounded on the shell and all fixtures should be thoroughly tested with a magneto before they are connected to the circuit. It is much easier to locate the faults before the fixtures are put up than it is after. In connecting fixtures to the line wires, all joints should be soldered and thoroughly taped so that there will be no danger of grounding or short-circuiting when the canopy is pushed in place. Particular attention should be given to the connecting of the lamp sockets; this is a part of the fixture wiring that is often slighted and causes many short circuits and grounds. Great care should be taken to see that the sockets are good, and also that they are strong enough to bear the weight of shades. Faulty sockets are more likely to cause trouble on fixtures than on drop cords, for the socket itself is always grounded on the fixture, and if either wire becomes grounded on the socket shell, it is in consequence grounded on the fixture.

INSULATING JOINTS

35. The insulating joint is the most important electrical fitting used in fixture work; joints are made for all possible combinations. Fig. 24 shows a very good style; piece *a*

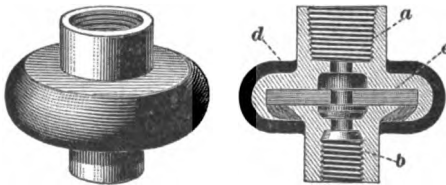

FIG. 24

screws on to the gas pipe and *b* to the fixture. The parts are separated by insulating material *e*, and the outside of the joint is covered with molded insulation *d*. The gas pipe above the joint must be covered by an insulating tube, as required by rule (*a*),

Art. 33, and after the outlet wires have been soldered to the fixture wires the joints should be carefully taped and the wire bunched in below the insulating joint so as not to interfere with the canopy. In connecting insulating joints to the gas pipe, red lead or white lead should not be used; asphaltum or some similar insulating compound is preferable. Insulating joints should be tested before being used and canopy insulators should be installed as required by rule (a). In ordinary dwelling houses, where the ceilings are plastered on wood lath, or in other non-fireproof buildings where there is no metal work about the ceilings or walls, it is not necessary to use canopy insulators. The canopy is the brass cup-shaped piece used at the top of fixtures to cover the joint. It is in contact with the fixture; hence, it is important that it be insulated from metal ceilings, or else all the benefits derived from an insulating joint will be lost. Fig. 25 shows a canopy insulator, which is simply an insulating ring placed between the canopy and the ceiling.

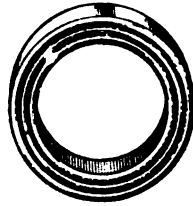
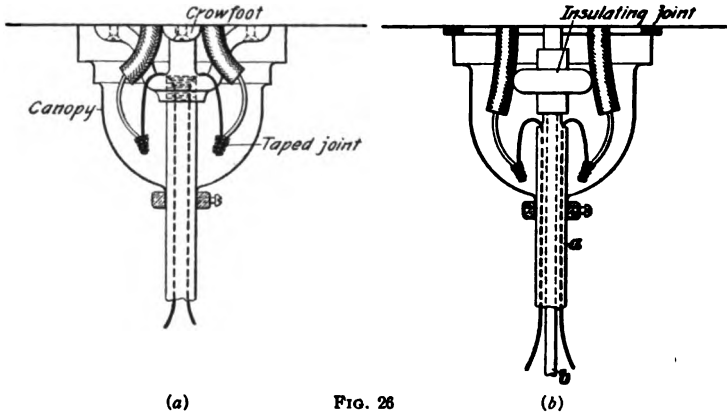

FIG. 25

36. The E. M. F. between the wires used on electric fixtures must never exceed 300 volts and the wires must not be smaller than No. 18 B. & S. gauge. If wires are secured to the outside of fixtures, as is sometimes the case when old gas fixtures are fitted with electric light, they must be fastened so that there will be no danger of the insulation being damaged by the pressure of the fastenings or by the motion of the fixture. The wire used for fixtures must be rubber-covered, and may be solid or stranded. Special wire is made for this purpose.

Fixtures should be firmly fastened in place. Combination fixtures are supported by the gas pipe but plain electric fixtures are generally fastened by screwing them into a wall or ceiling plate, or crowfoot. This method is satisfactory if a solid wood backing is provided and the fixture is not very heavy. In the case of heavy electroliers, the pipe should extend through the ceiling and be firmly fastened to the

joists or other secure support. In case outlet boxes are used, as with conduit work, the gas pipe extends through the box and carries the fixture if a combination fixture is used. For plain electric fixtures, the outlet boxes are provided



(a)

FIG. 26

(b)

with a threaded projection, which holds the fixture, the outlet box serving as a base or crowfoot. Fig. 26 (a) shows the arrangement of a plain electric fixture and a combination

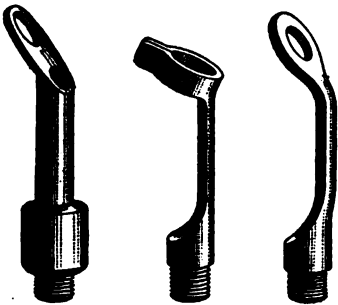

FIG. 27

fixture connected to outlets wired on the concealed knob-and-tube plan. The flexible tubing projects through the ceiling, as shown, and is connected to the fixture wires. In the combination fixture (b), the fixture wires are run between the outer shell *a* and the gas pipe *b*.

When old fixtures are to be wired, they must be taken down and supplied with insulating joints. Sockets may be attached to old gas fixtures by means of spars Fig. 27, that fasten to the fixtures at the gas burners.

LOCATION AND DISTRIBUTION OF LAMPS

37. The character of the lamps to be used and their location is a matter that must be determined in each case by the purpose for which the lamps are installed. For signs and decorative work, they are used solely to attract attention or to produce ornamentation. In interior lighting, their purpose is to illuminate other objects either close at hand, as with desk lamps, or at a somewhat greater distance. Where illumination is the sole requirement, the lamps should be placed where they cannot be seen, but where they will throw their light on the object to be illuminated, as on the stage of a theater. In general work, however, it is not possible to place the lamps in this manner, but they should be placed where they will not be too conspicuous. When they must be in view, the lamps should be surrounded by shades that will diffuse the light and take away the glare. Frosted globes are of assistance in many places, but it is better to have the light diffused by a shade. Shadows should be avoided as much as possible.

38. Chandeliers are usually relied on for general illumination. They should be hung high to get the best effects, and should never be as low as the level of the eye of a person standing. Borders or rows of lights placed on the ceiling near the walls give very good illumination without hurting the eyes. To get the best illumination with the smallest number of lamps, the walls and ceilings should be finished in light colors or in white and should be kept clean. It is cheaper to retint ceilings than to burn many lamps; this is especially true of stores, where much illumination is a necessity. Walls papered in dark colors and woodwork of dark, rich wood make it almost impossible to light a room brilliantly.

On account of the great influence of the color of walls, height of ceilings, etc. it is impossible to give other than very approximate figures for the amount of light required for illuminating a given room. For rooms requiring ordinary

illumination and having ceilings about 10 feet high, about .25 to .29 candlepower per square foot should be sufficient. For rooms with high ceilings .45 to .5 candlepower per square foot should be allowed, and for very brilliant lighting in ball-rooms or similar places, the allowance may be as high as 1 candlepower per square foot. Of course, these figures are for cases where the whole room is to be generally illuminated; when the light is used locally, as at desks or reading tables, it may not be necessary to have the room generally illuminated and the allowance per square foot might be much less than that indicated by the above figures.

CONDUIT WIRING

EARLY CONDUIT SYSTEMS

39. A number of years ago, before there were uniform rules governing the installation of wires to make them safe, it was a common practice to use, for electric lighting, wires wound with cotton thread saturated with paraffin. These wires were fastened with wooden cleats nailed against the walls and ceilings. Signal and bell wires are still sometimes put up in this way. The first step in the direction of improvement was limiting the number of incandescent lamps allowed on a given size of wire. The next was the substitution of "weather-proof" or "Underwriters'" wire for the paraffin-covered "office wire." Later came the porcelain cleat, which was not in general use before 1892.

The manner of installing wire in concealed work has undergone a similar evolution. At first wires were pulled through holes in the joists and installed without any protection other than their insulating covering; sometimes even two wires were pulled through the same hole, but this was not long tolerated. Progress came along two distinctly different lines: one that of insulating the wire by the use of knobs and tubes, as previously described; the other that of providing a continuous raceway, or conduit, for the conductors.

One of the first conduit systems and one that came into very extensive use, though it is not now allowed by the Underwriters, was that of the Interior Conduit and Insulating Company. It was made of paper wound in an ingenious manner, so as to form a tube, and coated with tar inside and out. These tubes were installed as a continuous race-way from outlet to outlet, and one or two wires, as happened to be most convenient, were pulled into each conduit.

These paper tubes were very brittle, and the system was improved by covering them with a thin shell of sheet brass. Then came the requirement that the conduit should never contain more than one wire. At one time, "brass-covered interior conduit work" was considered the best possible kind of construction.

An excellent tube that may be used in some places, though not approved as a conduit proper, is the flexible **Circular-Loom** tube. This is a woven tube treated with insulating material that makes it hold its shape. It has no metal covering, but is stronger than the brass-covered interior conduit and more convenient to use. It will be permitted under the present rules only in special cases, as it is not waterproof or nail-proof. It is very useful for fished work in connection with knob-and-tube wiring and also for protecting wires at outlets. This tube must not be used in places exposed to moisture.

APPROVED CONDUIT SYSTEMS

40. The conduits now approved by the Underwriters are iron pipes with or without insulating lining, and flexible armored conduit made of interlocked steel tape. They are divided into two classes—*lined* and *unlined*. When unlined conduits are used, an additional braided covering must be placed on the wire, the idea being that the extra braiding on the wire takes the place of the lining in the pipe.

Formerly, most conduits were lined, but it is now customary to use unlined conduit with wire having extra heavy braiding. Twin wire is generally used, the two wires being covered with a common outer braiding.

Fig. 28 shows a piece of iron-armored, lined conduit; *a* is the armor about $\frac{1}{8}$ inch thick, which is the same as ordinary gas pipe; *b* is the insulating lining, not less than $\frac{1}{32}$ inch thick and adhering to the outer pipe. Conduit, whether lined or unlined, is put up in the same manner as a good job



FIG. 28

of gas-fitting. In fact, unlined conduit is practically the same as gas pipe except that the interior surface is galvanized, enameled, or otherwise treated to make it smooth and to keep it from rusting. Great care should be taken at the joints to see that the pipe is reamed and that the ends come together, so as to form a smooth runway (free from burrs) for the wire. In many places the conduit may be bent and the use of an elbow, with its threaded joints, avoided. There are several devices on the market for bending conduit, but about as good a way as any to bend conduit is to get a good stout piece of spruce or hard pine and bore a hole in it a little larger than the conduit. The pipe is then passed through the hole and the bend easily worked in. Another improvised form of bender is made by securing a short piece of $1\frac{1}{2}$ -inch pipe into a $1\frac{1}{2}$ -inch T and clamping the piece of pipe in a vise. The conduit can then be passed through the T and bent to any desired shape. For iron-conduit wiring, the wireman should be provided with a regular outfit of pipe-fitter's tools.

41. Most conduit wiring is now carried out on the single-tube system, i. e., both wires or a twin wire are run in the same conduit. This plan requires less conduit and labor than the double-tube system and is, in fact, the only allowable arrangement when alternating currents are used. In the case of a large church, supposedly wired for 52 volts, 2 per cent. loss, the contractor ran the wires in separate pipes, with the result that when the current was turned on only 13 volts were obtained at the lamps. It is cheaper, as well as better, to use twin or concentric conductors in a single conduit, except for very large cables that are to carry direct currents.

42. Use of Outlet and Junction Boxes.—Since in any conduit system the primary object is to have the wires arranged so that they can be withdrawn, it is necessary, whenever a branch is taken off, to provide a **junction box** of some kind, because splices cannot be made at intervening points without interfering with the withdrawal of the wires. Conduit wiring is, therefore, done on the so-called loop

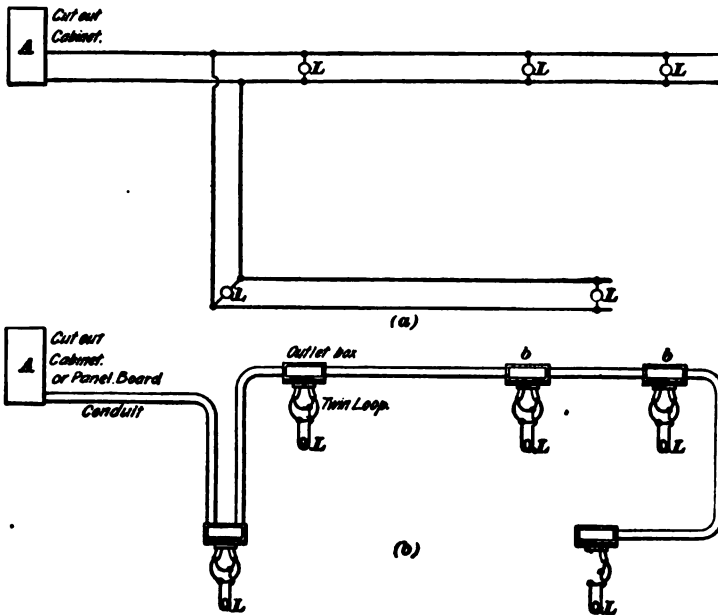

FIG. 29

system. This will be understood by referring to Fig. 29 (a) and (b); L, L, L, etc. are lamps on one circuit that is to be supplied from a panel board or distributing center located at A. In (a), the wiring is indicated as it might be done with the ordinary knob-and-tube system, using branches whenever they will reduce the labor and the amount of wire necessary; (b) shows the same lamps wired on the loop system, using outlet boxes b and looping out the twin wire at each lamp. No branches are taken off between outlet

boxes, and by disconnecting the wires running to the lamps, the main wires can be withdrawn.

The loop system using iron conduits is, of course, very much more expensive than the knob-and-tube system. It is, however, much more permanent in character and is the only style now used in the best class of buildings. The best method of running the conduit, so as to save bends and make the conduit as short as possible, must be left to the judgment of the wireman. In laying out such wiring, he must remember that the two wires are run together and that he cannot make short cuts with single wires, as in knob-and-tube work.

43. Conduits less than $\frac{1}{2}$ inch inside diameter are not allowable, and an outlet box must be provided at each outlet. When branch lines are taken off, a junction box must be provided. Junction boxes and outlet boxes are manufactured in a large variety of forms to accommodate conduits coming into them from different directions. Fig. 30 (a) shows a round cast-iron junction box. These boxes should be

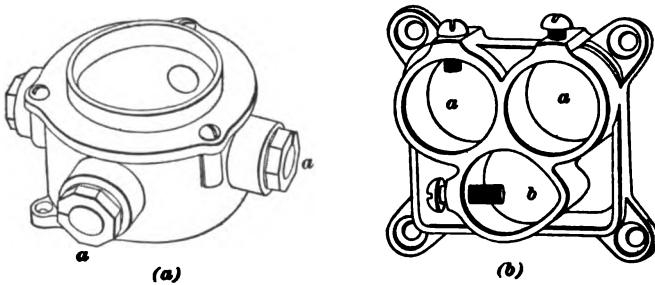

FIG. 30

mounted firmly in the wall and be placed so that the surface will come flush with the plastering. The split nuts *a, a* hold the conduit in place.

Fig. 30 (b) shows an outlet plate. The conduit is clamped in openings *a* and the gas pipe is clamped in *b*. Outlet plates must not be used unless it is impossible to install a regular outlet box. Outlet boxes used with lined conduit must also be lined and all boxes, whether lined or

unlined, must be enameled, galvanized, or otherwise treated inside and outside so as to prevent rust. Very convenient junction and outlet boxes are now made of stamped steel and are arranged so that one or more openings may be made in the side by taking out a small disk. Fig. 31 shows a box of this kind. The conduit enters the box and, projecting through it about $\frac{1}{2}$ inch, is held in place by an insulating cap *a* that screws over the end on the inner side. A check-nut *b* screws up against the outside of the box. Fig. 32 shows these fittings more in detail. Boxes of this type may be suited to different locations by simply knocking out or removing the disks whenever openings are needed. This avoids the necessity of carrying a large number of different boxes in stock. Outlet boxes may be obtained that are provided with special covers to accommodate almost any make of flush switch.

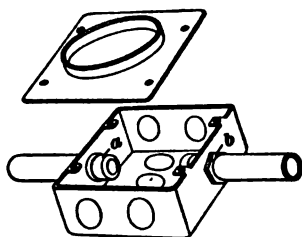

FIG. 31

When a change in the size of wire is made in a junction box, it is necessary to protect the smaller wire by a cut-out. Special cut-outs are made for mounting in junction boxes,

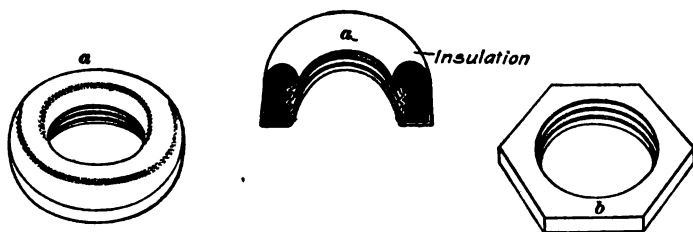

FIG. 32

but in most cases the wiring is laid out so that all fuses will be grouped on panel boards arranged in cut-out cabinets, each branch circuit running directly from the panel board to the lamps.

44. Fig. 33 shows one method of arranging a ceiling outlet for a combination fixture in a fireproof building

wired with iron-armored conduit. The floors are made of hollow tile placed between I beams. On top of the I beams wooden stringers are laid and the rough flooring is laid diagonally on these stringers. The finished floor is laid on top of the rough flooring. The gas pipes and electric conduit are laid in the space between the under side of the rough flooring and the top of the hollow tile. After the pipes and conduit have been laid, this space is filled with concrete. The conduit elbows and the gas pipe are brought down through the tile to the steel outlet box *a*. The ends of the conduit are provided with insulating nipples *b, b*, and the gas pipe *c*, where it passes through the box, is provided

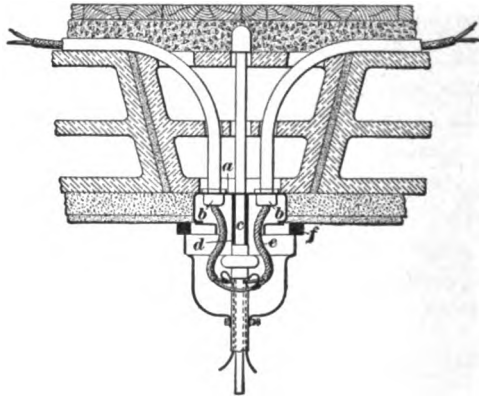

FIG. 33

with an insulating sleeve *d*. The wiring is on the loop system, the twin loop *e* being brought down from the conduit and the wires in it attached to the fixture wires as shown. The canopy is separated from the ceiling by the canopy insulator *f*. Of course the arrangement of outlets will differ considerably as to details, depending on the style of the outlet box used and the method of bringing down the conduit to the box. In general, the conduit should be brought down so as to necessitate as little cutting of the arch as possible; the outlet box should be well secured to the conduit, and the fixture must be firmly supported.

Fig. 34 shows an outlet for a fixture or bracket where the outlet box is mounted against a brick wall. In this case the outlet is for electric light only, and the fixture is supported by screwing it on to a threaded stud fastened to the back of the box. The outlet is wired on the loop system; hence, two conduits are necessary, one to bring the twin wire down and the other for the return. A double-pole wall switch would be wired in the same way, so far as the arrangement of outlet box and conduit is concerned, but the loops would, of course, be cut and the terminals attached to the switch. In some cases where outlet boxes are mounted on brick walls it may be necessary to cut out the brick so as to bring the outer edge of the box flush with the plaster, but generally the wooden strips, or furring, nailed on brick walls to take the lath will make sufficient depth between the surface of the plaster and the brick wall to take the outlet box. Outlet boxes should be secured in place by first drilling and plugging the brick and then fastening the box with screws or nails.

When laying out a job of conduit wiring, the first thing to do is to locate the distribution cabinets and then the various outlets for lamps, switches, etc., as specified on the architect's plans. Too much care cannot be taken in properly locating these boxes; when a building is in rough condition with nothing in place other than rough walls or partitions, it is an easy matter to make mistakes in locating outlets, with the result that when the rooms are finished the outlets are found to be out of place and can only be fixed by doing some of the work over again or possibly by having to install molding. All outlet boxes should be put in place before any conduit is run; the wireman can then see just where the outlets are located and can plan the work so as to use the minimum

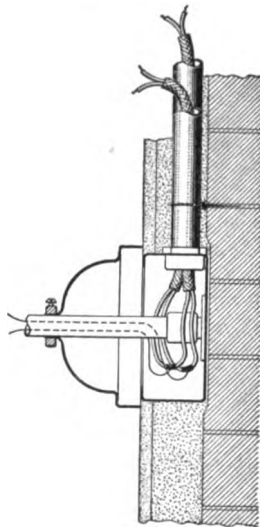

FIG. 34

amount of conduit and labor. Switch outlets should be placed about 4 feet 3 inches from the floor and side-bracket outlets about 6 feet. Firm supports should be provided for outlet boxes in all cases; on ordinary walls or ceilings boards should be nailed across between the joists or studding.

45. Wire Used in Conduits.—Single wire used in lined conduit is the same as rubber-covered wire used for other low-voltage work. If twin wire is used, each conductor must comply with the requirements for other low-voltage, rubber-covered wire, except that each wire may be taped instead of braided, and there must be a braided covering over the whole. For unlined conduits, the same requirements hold, and in addition the wire must be provided with an extra braiding at least $\frac{1}{8}$ inch thick.

46. The following are some of the more important rules relating to the installation of conduits:

Interior Conduits—

The object of a tube or conduit is to facilitate the insertion or extraction of the conductors, and to protect them from mechanical injury. Tubes or conduits are to be considered merely as raceways, and are not to be relied on for insulation between wire and wire or between the wire and the ground.

a. No conduit tube having an internal diameter of less than $\frac{5}{8}$ inch shall be used; measurement to be taken inside of metal conduits.

b. Must be continuous from one junction box to another or to fixtures, and the conduit tube must properly enter all fittings.

In case of underground service connections and main runs, this involves running each conduit continuously into a main cut-out cabinet or gutter surrounding the panel board, as the case may be.

c. Must be first installed as a complete conduit system, without the conductors.

d. Must be equipped at every outlet with an approved outlet box or plate.

Outlet plates must not be used where it is practicable to install outlet boxes.

In buildings already constructed where the conditions are such that neither outlet box nor plate can be installed, these

appliances may be omitted by permission of the Inspection Department having jurisdiction, provided that the conduit ends are bushed and secured.

c. Metal conduits, where they enter junction boxes and at all other outlets, etc., must be provided with approved bushings fitted so as to protect wire from abrasion, except when such protection is obtained by the use of approved nipples, properly fitted in boxes or devices.

f. Must have the metal of the conduit permanently and effectually grounded.

It is essential that the metal of conduit systems be joined so as to afford electrical conductivity sufficient to allow the largest fuse or circuit-breaker in the circuit to operate before a dangerous rise in temperature in the conduit system can occur. Conduits and gas pipes must be securely fastened in metal outlet boxes so as to secure good electrical connection. Where boxes used for centers of distribution do not afford good electrical connection, the conduits must be joined around them by suitable bond wires. Where sections of metal conduit are installed without being fastened to the metal structure of buildings or grounded metal piping, they must be bonded together and joined to a permanent and efficient ground connection.

g. Junction boxes must always be installed in such a manner as to be accessible.

h. All elbows or bends must be so made that the conduit or lining of same will not be injured. The radius of the curve of the inner edge of any elbow not to be less than $3\frac{1}{2}$ inches. Must have not more than the equivalent of four quarter bends from outlet to outlet, the bends at the outlets not being counted.

47. While a conduit system is considered merely as a system of raceways for the wires, if it is properly installed, all joints firmly made, and an efficient ground provided, it serves the purpose also of an additional protection. No ground can then occur anywhere in the concealed wiring in the building except on the conduit, and if that is grounded to the earth, it cannot do any damage. If two grounds should occur on opposite sides of the line, a "dead" short circuit would be formed through the walls of the iron pipe. This will blow the fuses on the lines affected, disconnecting them, but doing no other damage. In a job of conduit wiring,

the conduit is, of course, installed during the construction of the building before lathing and plastering are done. The wires are, however, not drawn in until all rough work on the building is completed [note rule (c)].

There has been much discussion as to what constitutes a permanent and effectual ground in such work. In small installations the ground should be of as great carrying capacity as the conductors within the conduit. In large plants this is not practicable. Where conduits pass from junction box to junction box, they should be well connected, electrically as well as mechanically, to the metal of the boxes, so that no part of the conduit system will be insulated from or in poor contact with the rest of the system. If good contact cannot be made between the pipe and box, the pipe should be carefully cleaned on each side and a copper-wire jumper connected around the box.

Screw joints between various lengths of pipe and between pipes and junction boxes and cut-out cabinet frames are to be preferred to all other kinds of joints, because they are more secure and afford better electrical contact. To secure them in an entire system, it is necessary to use a few right-hand and left-hand couplings or a few unions. Where unions are used, they should preferably be of brass, because brass gives

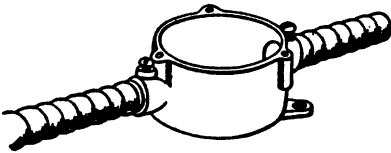

FIG. 35

better contact at the sliding joints than iron. In most cases, however, instead of a union or right-hand and left-hand coupling, the thread is cut well back on one piece, the coupling

screwed on and afterwards screwed back over the other piece.

But owing to the difficulty of installing screw joints in all places, and because other joints are easier to make and require less expensive fittings (though not so good), many systems have been designed in which other kinds of joints are relied on. Whatever system is used, the workman must not shirk the duty of making good pipe connections, which are as important as soldered joints on the wires.

48. **Flexible Armored Conduit.**—In order to avoid joints and make the conduit cheaper and easier to install, flexible armored conduits have been brought forward. Fig. 35 shows a piece of the Greenfield conduit and the

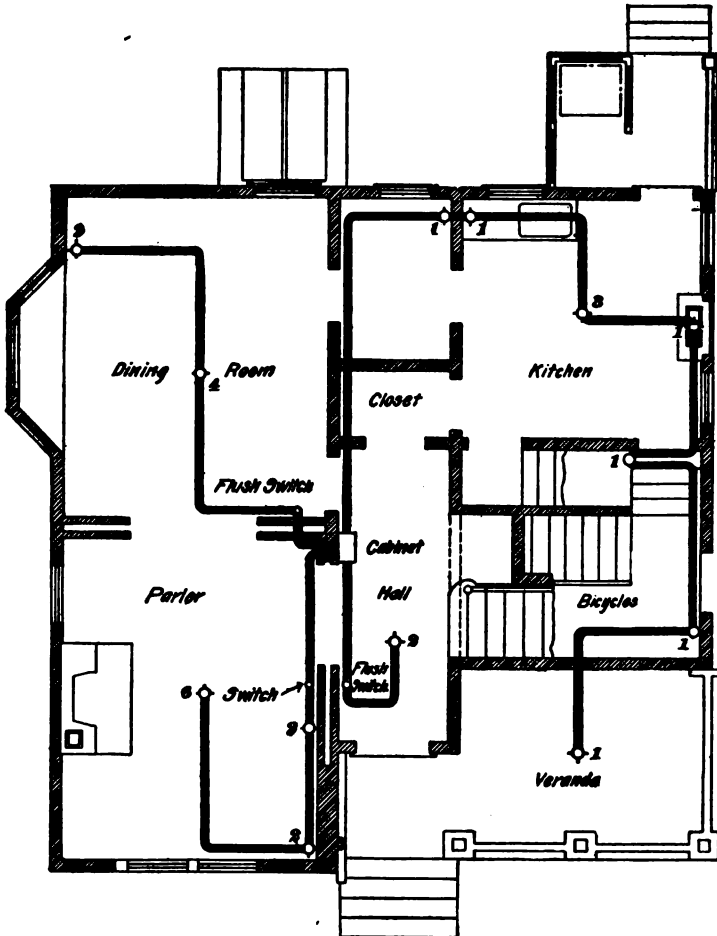

FIG. 35

method of connecting it to a junction box. This conduit is made of interlocked steel ribbon wound spirally. It affords a good protection to the wire against mechanical injury and

is easily installed, but it is not waterproof. It is, therefore, inferior to the iron conduit for damp places or where the conduit has to be laid in concrete.

49. Drawing Wires in Conduits.—When the wires are to be drawn into conduits, soapstone should be blown through first, as it makes the wire slide through more easily and take the ells better. A "snake" is first run through the tube and the wire pulled through by means of it. The *snake* usually consists of a steel ribbon about $\frac{1}{8}$ inch wide with a ball about $\frac{1}{4}$ inch diameter on the end. If the conduit has many turns, it is advisable to use a coiled spiral spring about $\frac{1}{4}$ inch diameter and 6 or 8 inches long with a ball on one end and the other end fastened securely to the steel ribbon. The end with the piece of spring is pushed in first and the spring passes around the turns easily.

Fig. 36 shows one floor of a dwelling house wired with conduit. The numbers on the various outlets indicate the number of lamps supplied. The wiring is carried out on the loop system, and it will be noticed that no branches are taken off between outlets. Four circuits are used in order that there may not be more than ten lamps on any one circuit.

WOODEN MOLDINGS

50. Wooden moldings are used for running wires over woodwork, on walls, door and window frames, and other places where they cannot otherwise be well concealed. Moldings put up on ceilings or walls should be arranged symmetrically, so as to disguise their purpose, even though it may be necessary to put up blank molding for this purpose. Work of this kind is confined almost exclusively to old buildings, and molding should not be used where it can be avoided. The following rules relate to moldings:

Wooden Moldings—

- a. Must have both outside and inside at least two coats of waterproof paint or be impregnated with a moisture repellent.

b. Must be made of two pieces, a backing and capping and must afford suitable protection from abrasion. Must be so constructed as to thoroughly incase the wire and provide a $\frac{1}{8}$ -inch tongue between the conductors and a solid backing that, under the grooves, shall not be less than $\frac{3}{8}$ inch in thickness.

It is recommended that only hardwood molding be used.

Wires—

For molding work:

Must have approved rubber-insulating covering.

Must never be placed in molding in concealed or damp places or where the difference of potential between any two wires in the same molding is over 300 volts.

51. Irresponsible parties sometimes run weather-proof wire in moldings. This practice is dangerous, for there is practically no insulation except that on the wire, if the molding becomes damp; in cleat and tube work there is an air space, and in conduit work an iron pipe, as an additional protection. Moreover, a wire with an air space or an iron jacket around it cannot do much damage even if it does become very hot; but a wire embedded in wood if overloaded excessively will char and possibly set fire to the wood,

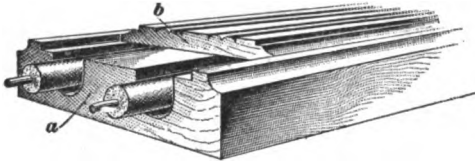

FIG. 37

because the heat cannot easily be dissipated. For these reasons molding work is now prohibited in some of the larger cities. Dampness is the greatest enemy of molding work.

However, where hardwood moldings and rubber-covered wires of sufficient size are used in places always dry, this kind of work is quite safe. Moldings are especially convenient in running border lights around the walls of rooms, and in wiring for temporary displays, and other work of a

semipermanent nature. They should not be run on brick walls where there is liability of moisture working through from the back. They are made in a variety of styles, some of which are ornamental and nicely finished to match the trimmings of the rooms in which they are used. Fig. 37 shows a typical two-wire molding that conforms to the Underwriters' requirements, since it has the backing *a* and capping *b*.

TESTS

52. After a job of wiring has been completed, tests should be made to see that all connections are correct and also that there are no grounds or crosses between the wires. All circuits should be tested before fixtures of any kind are put up, and each fixture should be tested carefully before it is

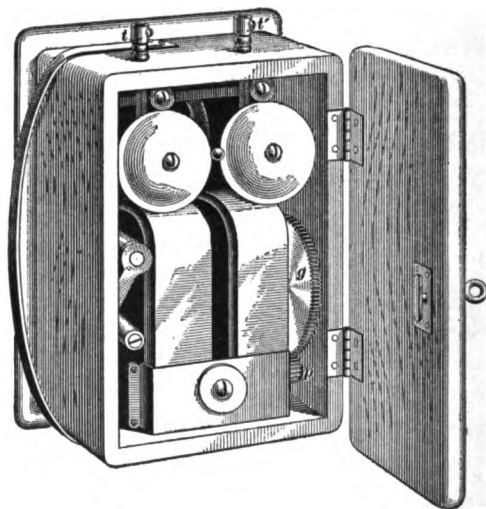

FIG. 38

put in place. Fixtures when received from the factory are not usually wired, and connecting the sockets, etc. must be done before they are put in place. If this is not carefully done, the fixture wire is apt to become grounded; hence, the necessity of testing out fixtures before they are put into

position. For most of this testing a **magneto-bell** is used. This is a small hand-power electric generator connected with a bell similar to the call bell on a telephone. In Fig. 38, *t, t'* are the terminals to which wires are attached in order to test any circuit; when a circuit is established between them the bell rings. These instruments are designed to ring the bell through resistances of 5,000 to 10,000 ohms, or more.

53. Each branch circuit should be tested by connecting its terminals at the panel board or cut-out with the magneto. The wires at all the outlets should be separated and the circuit rung up. If no ring is obtained, it shows that there is no cross between the wires. The wires coming out of each outlet should then be touched together in turn and also their corresponding switch outlets, if there are any, to see if the connections to the outlets are all right. After each outlet is rung up, its wires should be left separated. Each side of the circuit should then be tested for grounds. If it is a conduit system, one terminal of the magneto should be connected to the sheathing and the other to each side of the circuit in turn. If no ring is obtained on either side, it shows that the wire is clear of grounds. If a ring is obtained, the ends should be carefully examined, and if necessary the wire must be drawn out and examined. In knob-and-tube work the method of testing is practically the same, only in testing for grounds one side of the magneto may be connected to a gas or water pipe. Each fixture should be subjected to similar tests, and after all the fixtures are in place, the system as a whole should be tested.

54. Underwriters' Tests.—An insurance inspector usually tests each branch line with a magneto for continuity, short circuits, and grounds. He then usually counts up the number of lamps on each circuit and notes the sizes of wire used to see that no wire is overloaded when all the lamps are on. Concealed work must be inspected before the lath and plaster are put on, otherwise it will not be passed without special investigation; this means tearing up floors and walls, which is expensive to say the least.

In most installations, where the inspector has no reason to suspect that any faulty material has been used, he is able to satisfy himself by these tests and by examining the work with his eye; in fact, in many cases an ocular inspection is the only inspection made by the authorities, if they are satisfied that the contractor is honest and has made the other necessary tests.

55. Where more particular attention is given to a piece of work or where it is desired to learn whether an old installation or one not properly inspected at the time the work was done is up to the standard of safety, the insulation resistance is measured.

Insulation Resistance—

The wiring in any building must test free from grounds; i. e., the complete installation must have an insulation between conductors and between all conductors and the ground (not including attachments, sockets, receptacles, etc.) of not less than the following:

Up to 5 amperes	4,000,000 ohms
Up to 10 amperes	2,000,000 ohms
Up to 25 amperes	800,000 ohms
Up to 50 amperes	400,000 ohms
Up to 100 amperes	200,000 ohms
Up to 200 amperes	100,000 ohms
Up to 400 amperes	50,000 ohms
Up to 800 amperes	25,000 ohms
Up to 1,600 amperes	12,500 ohms

All cut-outs and safety devices should be in place when the above test is made.

Where lamp sockets, receptacles, and electroliers, etc. are connected, one-half of the above will be required.

Where lamps or other devices are suspected of taking more current than they should or where the load on any line is, for any reason, in doubt, the current should be measured with an ammeter.

MEASUREMENT OF DROP, IN VOLTS

56. If the current can be turned on in order to make a test of the drop in voltage, the best way is to use a voltmeter and determine the actual drop on each line at full load. With an ordinary voltmeter, the best method is to have two pairs of test cords and plugs connected to a double-pole double-throw switch. One pair of test cords should run to the distribution center; the other should run to the fixture to which the drop is to be determined. The switch should be so connected to the voltmeter that a reading of the voltage at the end of one pair of cords can be taken one instant and that at the end of the other pair of cords the next. The difference is the drop, in volts, on that line. All of the lamps should be turned on while the measurements are being taken, and several sets of readings should be made, because currents supplied from central stations suffer variations in voltage.

MARINE WORK

57. Wiring on board ships is subjected to some special conditions and therefore requires special treatment. The first important condition not usually met with on land is the motion of the ship, which makes it necessary to avoid all forms of construction where chafing or breaking might take place. The second important peculiarity is the constant dampness of the atmosphere. For these and other reasons a separate code has been prepared for marine work, from which the following rules are selected. They embody the chief points in which marine work differs from other work.

Wires—

a. Must be supported in approved molding or conduit except at switchboards and for portables.

Special permission may be given for deviation from this rule in dynamo rooms.

b. Must have no single wire larger than No. 12 B. & S. Wires to be stranded when greater carrying capacity is required. No single solid wire

smaller than No. 14 B. & S. except in fixture wiring to be used.

Stranded wires must be soldered before being fastened under clamps or binding screws, and when they have a conductivity greater than No. 10 B. & S. copper wire, they must be soldered into lugs.

c. Splices or taps in conductors must be avoided as far as possible. Where it is necessary to make them, they must be so spliced or joined as to be both mechanically and electrically secure without solder. They must then be soldered, to insure preservation, covered with an insulating compound equal to the insulation of the wire, and further protected by a waterproof tape. The joint must then be coated or painted with a waterproof compound.

Wires for Molding Work—

a. Must have an approved insulating covering.

The insulation for conductors, to be approved, must be at least $\frac{1}{8}$ inch in thickness and covered with a substantial waterproof and flame-proof braid.

The physical characteristics shall not be affected by any change in temperature up to 200° F. After 2 weeks' submersion in salt water at 70° F., it must show an insulation resistance of 100 megohms per mile after 3 minutes' electrification with 550 volts.

b. Must have, when passing through water-tight bulkheads and through all decks, a metallic stuffing tube lined with hard rubber. In case of deck tubes, they shall be boxed near deck to prevent mechanical injury.

c. Must be bushed with hard-rubber tubing $\frac{1}{8}$ inch in thickness when passing through beams and non-water-tight bulkheads.

Wires for Conduit Work—

a. Must have an approved insulating covering.

The insulation for conductors for use in lined conduits, to be approved, must be at least $\frac{1}{8}$ inch in thickness and be covered with a substantial waterproof and flame-proof braid. The physical characteristics shall not be affected by any change in temperature up to 200° F.

After 2 weeks' submersion in salt water at 70° F., it must show an insulation resistance of 100 megohms per mile after 3 minutes' electrification with 550 volts.

For unlined metal conduits, conductors must conform to the specifications given for lined conduits,

and in addition have a second outer fibrous covering at least $\frac{1}{32}$ inch in thickness and sufficiently tenacious to withstand the abrasion of being drawn through the metal conduit.

b. Must not be drawn in until the mechanical work on the conduit is completed and the same is in place.

c. When run through coal bunkers, boiler rooms, and where they are exposed to severe mechanical injury, must be incased in approved conduit.

TABLE V

TABLE OF CAPACITY OF WIRES FOR MARINE WORK

B. & S. G.	Area. Actual Circular Mills	Number of Strands	Size of Strands B. & S. G.	Amperes
19	1,288			
18	1,624			3
17	2,048			
16	2,583			6
15	3,257			
14	4,107			12
12	6,530			17
	9,016	7	19	21
	11,368	7	18	25
	14,336	7	17	30
	18,081	7	16	35
	22,799	7	15	40
	30,856	19	18	50
	38,912	19	17	60
	49,077	19	16	70
	60,088	37	18	85
	75,776	37	17	100
	99,064	61	18	120
	124,928	61	17	145
	157,563	61	16	170
	198,677	61	15	200
	250,527	61	14	235
	296,387	91	15	270
	373,737	91	14	320
	413,639	127	15	340

Portable Conductors—

Must be made of two stranded conductors, each having a carrying capacity equivalent to not less than No. 14 B. & S. wire, and each covered with an approved insulation and covering.

Where not exposed to moisture or severe mechanical injury, each stranded conductor must have a solid insulation

at least $\frac{1}{8}$ inch in thickness and must show an insulation resistance between conductors and between either conductor and the ground of at least 50 megohms per mile after 2 weeks' submersion in water at 70° F., and be protected by a slow-burning, tough-braided, outer covering.

Where exposed to moisture and mechanical injury—as for use on decks, holds, and firerooms—each stranded conductor shall have a solid insulation, to be approved, of at least $\frac{1}{8}$ inch in thickness and be protected by a tough braid. The two conductors shall then be stranded together, using a jute filling. The whole shall then be covered with a layer of flax, either woven or braided, at least $\frac{1}{8}$ inch in thickness, and treated with a non-inflammable, waterproof compound. After 1 week's submersion in water at 70° F., it must show an insulation between the two conductors or between either conductor and the ground of 50 megohms per mile.

Wooden moldings must be constructed according to the requirements for ordinary interior-wiring work and in addition must conform to the following rules:

- a.* Where molding is run over rivets, beams, etc., a backing strip must first be put up and the molding secured to this.
- b.* Capping must be secured by brass screws.

Cut-Outs—

- a.* Must be placed at every point where a change is made in the size of the wire (unless the cut-out in the larger wire will protect the smaller).
- b.* In places such as upper decks, holds, cargo spaces, and firerooms, a water-tight and fireproof cut-out may be used, connecting directly to mains when such cut-out supplies circuits requiring not more than 660 watts energy.
- c.* When placed anywhere except on switchboards and certain places, as cargo spaces, holds, firerooms, etc., where it is impossible to run from center of distribution, they shall be in a cabinet lined with fire-resisting material.
- d.* Except for motors, searchlights, and diving lamps, shall be so placed that no group of lamps requiring more than 660 watts shall ultimately be dependent on one cut-out.

Fixtures—

- a.* Shall be mounted on blocks made from well-seasoned lumber treated with two coats of white lead or shellac.

b. Where exposed to dampness, the lamp must be surrounded by a vapor-proof globe.

c. Where exposed to mechanical injury, the lamp must be surrounded by a globe protected by a stout wire guard.

d. Shall be wired with same grade of insulation as portable conductors that are not exposed to moisture or mechanical injury.

e. Ceiling fixtures over 2 feet in length must be provided with stay-chains.

WIRING ESTIMATES

58. It is difficult to lay down any reliable rules to be used in estimating the cost of a proposed wiring job. As when estimating in other lines of work, experience must largely be relied on. The prices of labor and material vary so widely in different sections of the country that any general rules might lead to very inaccurate results. Moreover, these prices are always fluctuating. One frequently sees statements to the effect that certain kinds of wiring can be done for so much per lamp or so much per outlet, but it is evident that while such figures might be fairly correct so far as the average of a large number of installations is concerned, they might be far from correct when applied to individual cases.

59. The only way in which to obtain a fairly close estimate of the cost of a given installation is to prepare plans and lay out the circuits, marking the size of the wire and the capacity of the various switches and cut-outs required. By laying out these plans, the amount of wire, conduit, and other material required may be arrived at quite closely. The number of switches, cut-outs, etc. can be counted up and their cost estimated. In measuring the length of the circuits, do not forget to take into account the wire and material necessary for running up and down walls to switches or outlets. Margin should be allowed for such material as tape, solder, etc. The labor item will depend largely on whether the building to be wired is an old one or one in the process of construction, also on the style of wiring used, so

that the labor item can only be determined from a careful inspection of the premises to be wired and experience on work of a similar class. An ordinary two-story dwelling house wired on the concealed knob-and-tube system will require about 6 days' labor of a man and helper. Some small houses will require less than this. Old houses require a much larger expenditure of labor, because there is liable to be considerable molding work to be done.

It is unsafe to assume a certain cost per outlet in figuring on a job of wiring unless one has been doing considerable work of a certain class. As a rough guide, however, it may be stated that ordinary dwellings wired on the concealed knob-and-tube plan will cost from \$2 to \$3 per outlet. This, of course, does not include the fixtures, but should cover the cost of snap switches and porcelain cut-outs. Ordinary exposed wiring can usually be run for \$1 to \$1.75 per drop, including rosettes, cord, and sockets, though, of course, very much depends on how closely the lights are grouped. It is evident that if the lamps are scattered very much, the cost of wire, porcelain fittings, and labor will be comparatively high, and this will increase the cost per drop. Wiring with iron-armored conduit is expensive, but it is substantial. For small installations, it will probably cost from \$5 to \$6 per outlet; in large installations, the cost will be somewhat less. It must be remembered that these figures are only approximate. The cost in different localities might vary widely from the above, and the only way to make a fairly close estimate is to lay out the circuits, make a list of the material needed, and estimate their cost and the probable labor required.

INTERIOR WIRING

(PART 3)

COMBINING SEVERAL WIRING SYSTEMS

STORE LIGHTING

1. A large electric-light installation generally requires many kinds of wiring, and there are usually special conditions that determine what kind of work is to be done in each locality. As an example, we will take the wiring system of a certain department store as it was actually put in.

After a careful study of the conditions existing, the managers of the store concluded that enclosed-arc lamps were best suited for the general illumination of their stores, and that incandescent lamps should be installed at desks, in closets and warerooms, and occasionally in show windows. Accordingly, the premises were wired for 250 enclosed-arc lamps and 500 incandescent lamps at 110 volts.

Separate feeder wires were run to the ten departments. Two dynamos were installed in the engine room in the sub-basement, one of which was capable of supplying current for one-third of the lamps and would be used when the load was light, while the other was capable of operating two-thirds of the lamps and some small motors. When the entire load was on, the two generators operated in parallel.

2. In order that light could be secured in case of a breakdown of the plant, service wires from the Edison three-wire system were brought into the basement and connected to the switchboard in such a manner that this current could

For notice of copyright, see page immediately following the title page

be used. The double-throw switches and connections necessary to change over from the two-wire to the three-wire system, where arc lamps are used, are shown in diagram in Fig. 1 (a). A special four-pole double-throw switch was installed. If there had been no arc lamps requiring the direction of the current to be constant, one three-pole double-throw

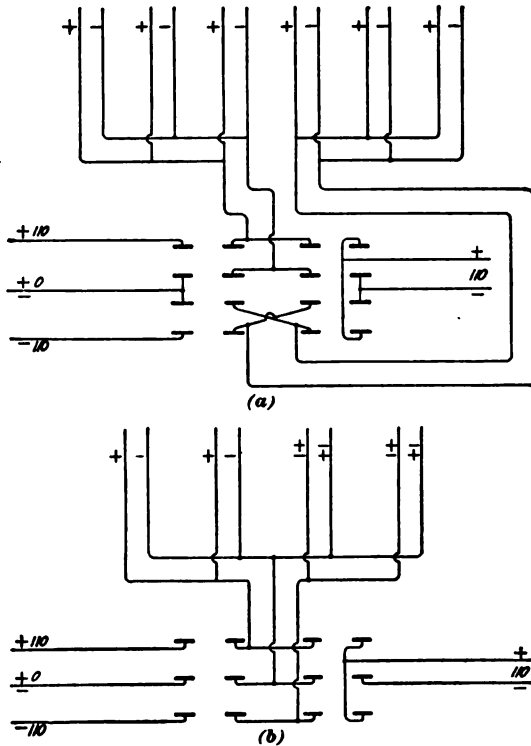

FIG. 1

switch, connected as in Fig. 1 (b), would have been sufficient. The use of the three-wire system in this case involved no saving in the lines, as that system extended only to the main switchboard, beyond which the two-wire system was used.

3. The large feeder cables were run from the engine room to the centers of distribution in each of the various

departments, in iron-armored conduits, one cable to a conduit. Cables and not wires were used, because heavy solid conductors cannot be drawn into conduits with bends in them. These conduits were put together with screw couplings and corner boxes of special design at each elbow, as the cables were very heavy. In the basement, the conduits were connected together by locknuts and a bus-bar, which was grounded to the water main back of the main valve on the automatic-sprinkler system by an iron rod, which was inserted in the water pipe like a tap. This afforded an excellent ground.

4. Cut-out cabinets were installed in each department. When in conspicuous places, they contained marble tablets on which were mounted lugs to receive fuses. Enclosed fuses were used and a switch was provided on the tablet for each circuit. The tablets were mounted in hardwood cabinets with plate-glass doors that opened by sliding downwards like a window sash. In less conspicuous places, the cabinets were provided with hinged wooden doors, were lined with asbestos, and provided with porcelain cut-outs of the enclosed-fuse type. For each enclosed-arc lamp, a separate branch line was run from the nearest cut-out cabinet. Large departments were provided with several cut-out cabinets connected to the same pair of feeders.

5. The branch lines were run in various ways; some of them were run in pipes, some in molding, and some were run open. Where placed in pipes, twin conductors were used and the lamps were hung from the pipe ends by means of an insulating joint. All branch pipes were connected together and to the feeder pipes at the cut-out cabinet in the same way as the feeder pipes were connected together in the basement.

6. A drop of 2 volts was allowed in the mains and a drop of 1 volt in the distributing wires for incandescent lamps. All distributing wires for the arc lamps were No. 14, and the resistances at the lamps were adjusted so as to secure 80 volts at the arc. From a distribution closet in one of the busiest departments, twin conductors of No. 14 wire were

run to the generator switchboard, in an iron pipe, and connected to a voltmeter on the switchboard. The terminals of these pressure wires in the closet were connected, with proper cut-out protection, to the terminals of the feeders. The dynamo tender was, therefore, able from the indications of the voltmeter to regulate his machines so as to maintain a constant potential of 110 volts at the cabinets.

7. The show windows were lighted by enclosed-arc lamps hung in the space above the goods displayed, but out of sight from the street. Only the outer globes projected below the dust-proof casing surrounding the window space. Thus, brilliant illumination was secured with very little glare and with great economy. The lamps were so arranged that they could be lifted out of the globes whenever it was necessary to trim them; but the globes were never removed, being cleaned while in place. This arrangement proved very effective and convenient. Additional circuits were run to various points for connecting incandescent lamps and special apparatus for holiday displays.

THEATER WIRING

8. The wiring of theaters and entertainment halls presents some peculiar features. All the lamps must be controlled from one point, usually on the right wing of the stage. Most of the lights on the stage are arranged in borders, or long rows, that contain several circuits of lamps of various colors, and are also usually provided with dimmers. Therefore, the stage switchboard of a large theater is quite a complicated affair compared with the distribution closets used in ordinary work.

In cases where there are a large number of borders of incandescent lamps, it is inconvenient to divide them into circuits of only 660 watts, and permission can usually be obtained from the Underwriters to place more lamps on such circuits if special care is taken.

9. Stage dimmers are of two kinds—*resistance boxes* and *reactive coils*. The latter are more economical, but can be

used with alternating currents only. Resistance boxes can be used with either direct or alternating current. Care must be taken to locate them where they can be kept cool by the circulation of fresh air. Reactive coils cut down the E. M. F. applied to the lamps by inserting a counter E. M. F. in the circuit. All kinds of stage dimmers must be thoroughly fireproof in construction and must be mounted on fireproof frames so that there will be no possibility of their setting fire to adjacent objects. Old-style resistance boxes were frequently provided with wooden casings, but this is no longer permitted. There are many reliable types of fireproof dimmers and they can be obtained for almost any desired range of current and voltage. In selecting dimmers of the resistance type, care should be taken to see that all sliding contacts are of ample capacity and substantially constructed.

Most of the dimmers in common use consist of a resistance split into a number of sections, so that the amount of resistance in series with the lamps may be varied. They are made in a number of different forms, some of them being arranged so that their operating handles interlock, allowing them to be operated singly or together in any desired combination. Dimmers are, of course, connected *in series* with the circuits that they are intended to control.

WIRING FOR SPECIAL PURPOSES

10. While in most work of a permanent character the closet or cabinet system of distribution, with very slight drop in the branch lines, is the proper system to adopt, there are special conditions that sometimes make it desirable to install wires for a very low price, for temporary or occasional use. In such installations, the efficiency is of comparatively little importance, but the proper regulation and uniform voltage at the lamps are as important as in permanent work.

11. Let us take a case, such as the installation of a thousand 8-candlepower lamps for decorative purposes around the cornices of a building at a fair, where the wires will be up for a few days or weeks only. All the lamps are to be

burned at the same time. In such a case, it may be economical to allow as much as 12.5 per cent. drop on the lines and use 100-volt lamps on 112.5-volt service. One pair of feeder lines will be run around the building, a distance of 1,000 feet. It is desired to have the drop such that there will be 100 volts at any point between the lines when 112.5 volts is applied at the terminals; this can only be accomplished by running the lines in opposite directions and having them change in size often enough to secure practically uniform drop per foot. Fig. 2 (a) illustrates such an arrange-

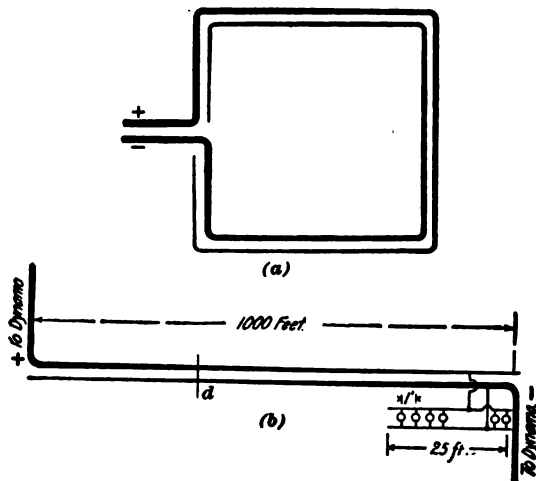

FIG. 2

ment, and (b) shows the same thing drawn in a straight line instead of a square. This is sometimes called the *anti-parallel* method of feeding.

12. There will be a lamp for every foot, and there will be required forty branches of No. 14 wire, with 25 lamps on each branch, as shown in Fig. 2 (b). Weatherproof wall receptacles will be used. The total length of wire in the mains is 2,000 feet. The length of wire to any given branch is 1,000 feet; hence, the rate of drop must be 12.5 volts per 1,000 feet. On account of the method of feeding from each end, it is easily seen in Fig. 2 (b) that

the length of wire through which the current flows to any point *d* must be 1,000 feet. The currents that various wires will carry with a drop of 12.5 volts are as follows:

SIZE OF WIRE	VOLTS DROP		RESISTANCE PER 1,000 FEET		AMPERES
No. 14	12.5	÷	2.521	=	4.96
No. 12	12.5	÷	1.586	=	7.88
No. 10	12.5	÷	.997	=	12.5
No. 8	12.5	÷	.627	=	19.9
No. 6	12.5	÷	.394	=	31.7
No. 5	12.5	÷	.313	=	39.9
No. 4	12.5	÷	.248	=	50.4

The amperes for larger wires can be found by consulting the tables in *Interior Wiring*, Part 2.

Since the lamps are to be 8 candlepower, there will be about 1 ampere for every four lamps, and consequently for every 4 feet of line (two wires). In making up a conductor to have nearly uniform drop, it will be necessary to compromise for all points that do not exactly correspond with the above-calculated current values. For instance, if No. 12 wire is joined to No. 14, it must be at a point where there is between 4.96 and 7.88 amperes. If lengths of wire are selected so that this joint will come half way between the points where the wires exactly correspond, it will be near enough. The results will then be as tabulated on the following page.

In this table the second column is obtained by dividing the volts drop (12.5) by the resistance per 1,000 feet of the various sizes of wire. The third column is found by taking the approximate value of the current multiplied by 4 because there is 1 ampere for every 4 feet of cornice. The fourth column is obtained by taking one-half the difference between the succeeding quantities in the third column and adding this difference to the quantity in the third column. For example, at a point 20 feet from the end, the current is 4.96 amperes and at a point 32 feet from the end it is 7.88 amperes. As stated above, lengths of wire will be selected so as to

bring the joints between the different sizes of wire midway between the points where the wires correspond. Hence, in the first case, if there is a current of 7.88 amperes 32 feet from the end and a current of 4.96 amperes 20 feet from the end, the joint will be $20 + \frac{32 - 20}{2} = 26$ feet from

the end and 26 feet of No. 14 wire will be required. Also, in the case of the No. 8 and No. 6 wires, there is a current of 19.9 amperes 80 feet from the end and 31.7 amperes 127 feet

Size of Wire	Amperes Giving 12.5 Volts per 1,000 Feet	Corresponding Distance From End of Line	Distance of End of Wire From End of Line	Length of Wire to Be Used
14	4.96	20	26	26
12	7.88	32	41	15
10	12.5	50	65	24
8	19.9	80	104	39
6	31.7	127	144	40
5	39.9	160	181	37
4	50.4	202	228	47
3	63.5	254	287	59
2	80.1	320	362	75
1	100.8	403	457	95
0	127.5	510	576	119
00	160.3	641	724	148
000	201.6	806	913	189
0000	255.1	1,020	1,000	87

from the end; hence, the joint between the two sizes will be $80 + \frac{127 - 80}{2} = 103.5$ feet from the end. In the table, the

nearest even number of feet is given, so that this is taken as 104. In the case of the 0000 wire, the distance from the end of the line corresponding to a drop of 12.5 volts works out 1,020 feet, though, of course, there will not be quite as large a current as 255.1 amperes because the line cannot be

longer than 1,000 feet. This quantity is, however, used in determining the distance (913 feet) of the end of the 000 wire from the end of the line. The distance of the end of the 0000 wire must, of course, be 1,000 feet because the cornice is 1,000 feet long. The lengths in the fifth column are obtained by subtracting the successive values of the fourth column, for example, $65 - 41 = 24$, $104 - 65 = 39$, etc.

13. Cut-outs will have to be installed as follows:

- 15 amperes, to protect Nos. 14, 12, and 10
- 25 amperes, to protect No. 8
- 65 amperes, to protect Nos. 6, 5, 4, and 3
- 130 amperes, to protect Nos. 2, 1, and 0
- 160 amperes, to protect No. 00
- 250 amperes, to protect Nos. 000 and 0000

This statement assumes that weather-proof wire is to be used. Fig. 3 is a diagram of a portion of the wiring in place, showing the connections of cut-outs.

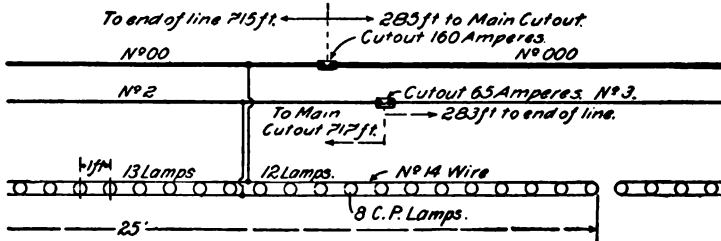

FIG. 3

14. Another method of wiring for temporary work is to put up wires on the feeder system just large enough to carry the current, and then calculate the drop and install lamps of the required voltage. This is a simple and very cheap method. In the case of the border lamps just considered, there would be eight pairs of feeders of No. 10 wire, with 125 lamps per feeder. If they are arranged as shown in Fig. 4, the lengths of these feeders and the drop on each may be, roughly, as follows, if each lamp required $\frac{1}{4}$ ampere. Current in each feeder is $\frac{1}{4} \times 125$ amperes, and No. 10 wire has a

resistance of about 1 ohm per 1,000 feet. The approximate lengths of the feeders will be as given below:

Two lines 425 feet (two wires) long, 26.6 volts drop

Two lines 300 feet (two wires) long, 18.8 volts drop

Two lines 175 feet (two wires) long, 10.9 volts drop

Two lines 50 feet (two wires) long, 3.1 volts drop

The resistance of 425 feet (.425 thousand feet) of No. 10 wire is, approximately, .425 ohm and the drop in the first case = $\frac{1}{4} \times .425 \times 2 = 26.6$. The others are found in a similar manner. In the distribution, about 1 volt would be lost. Consequently, if 125 volts is supplied, the lamps should have voltages of 97, 105, 113, and 121 if each lamp requires $\frac{1}{4}$ ampere.

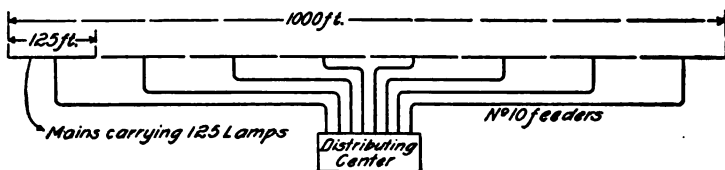

FIG. 4

15. There are many other methods or plans by which such a building could be wired for a large drop and still be furnished with uniform and steady light. These suggestions merely show how material may be saved. By making every installation a matter of special study, until he has thoroughly mastered every detail of the business, the wireman will discover many ways of economizing labor and material that cannot be brought to his attention in any other manner. Before using any unusual method, however, he should make certain that there is no objection on the part of the Underwriters or of the Fire Department to what he proposes to do.

HIGH-POTENTIAL SYSTEMS

16. The Underwriters' rules so far given apply to systems using 550 volts or less; for pressures over 550 volts, the following rules apply:

HIGH-POTENTIAL SYSTEMS

550 to 3,500 Volts

Any circuit attached to any machine or combination of machines which develops a difference of potential between any two wires of over 550 volts and less than 3,500 volts shall be considered as a high-potential circuit and as coming under that class, unless an approved transforming device is used which cuts the difference of potential down to 550 volts or less.

Wires—

- a. Must have an approved rubber insulating covering.
- b. Must be always in plain sight and never incased except where required by the Inspection Department having jurisdiction.
- c. Must be rigidly supported on glass or porcelain insulators, which raise the wire at least 1 inch from the surface wired over, and must be kept about 8 inches apart.
- d. Must be protected on side walls from mechanical injury by a substantial boxing, retaining an air space of 1 inch around the conductors, closed at the top (the wires passing through bushed holes) and extending not less than 7 feet from the floor. When crossing floor timbers in cellars or in rooms where they might be exposed to injury, wires must be attached by their insulating supports to the under side of a wooden strip not less than $\frac{1}{2}$ inch in thickness.

17. It is never advisable to bring high-potential wires into a building when it can be avoided. The danger to life, due to their presence, is greater than the fire hazard. An arc on a high-potential circuit carrying much current, once

started, will continue to burn even when the points between which it plays are separated several inches; and a lightning discharge can easily start such an arc. High-potential systems of over 550 volts are usually alternating. Series arc-lighting circuits are the only important direct-current high-potential circuits much used in the United States. With the exception of arc lamps, it is seldom necessary to bring any high-potential wires inside of buildings. Where alternating current is used, the line pressure is lowered by means of transformers, and it is never necessary to bring the high-pressure wires farther than the substations or transformer rooms.

18. Transformers.—The ordinary alternating-current transformer consists of two coils of wire wound on an iron core built up of thin sheets of iron. One of these coils, the *primary*, has a comparatively large number of turns and is connected to the high-pressure line. The other coil, the *secondary*, has a small number of turns and is connected to the lamps or other devices to be supplied with current. The high-pressure current flows through the primary and sets up an alternating magnetism through the secondary and induces an E. M. F. that is proportional to the ratio of the number of turns in the secondary coil to the number of turns in the primary. For example, if the primary had five hundred turns and the secondary fifty, the secondary voltage would be $\frac{50}{500}$, or $\frac{1}{10}$ the primary voltage, and if the primary were supplied at 1,000 volts, the secondary would deliver 100 volts. Special attention should be given to the following rules governing the installation of transformers. Cut-outs on primary circuits must be of some pattern especially designed and approved for the purpose; ordinary fuse blocks must not be used for high voltages.

19. Rules Relating to Transformer Installation.

Transformers—

- a.* Must not be placed inside of any building, excepting central stations, unless by special permission of the Inspection Department having jurisdiction.

b. Must not be attached to the outside walls of buildings, unless separated therefrom by substantial supports.

(When permitted inside buildings)

a. Must be located at a point as near as possible to that at which the primary wires enter the building.

b. Must be placed in an enclosure constructed of or lined with fire-resisting material; the enclosure to be used only for this purpose, and to be kept securely locked and access to the same allowed only to responsible persons.

c. Must be effectually insulated from the ground and the enclosure in which they are placed must be practically air-tight, except that it shall be thoroughly ventilated to the outdoor air, if possible, through a chimney or flue. There should be at least 6 inches of air space on all sides of the transformer.

20. The greatest danger to be feared in the use of transformers is the grounding of the primary on the secondary wires. This may occur either on account of a breakdown of the insulation under working conditions or because of lightning striking the primary wires. Efficient protection against lightning is an essential part of the out-of-door and central-station equipment.

WIRING FOR ARC LAMPS

21. Constant-Potential Arc Lamps.—The use of arc lamps in parallel on low-potential circuits has already been considered. Wiring for these lamps is done in practically the same way as for incandescent lamps, so that no special comment is necessary. The following special rules relate to arc lamps operated on low-pressure circuits:

Arc Lights on Low-Potential Circuits—

a. Must have a cut-out for each lamp or each series of lamps.

The branch conductors should have a carrying capacity about 50 per cent. in excess of the normal current required by the lamp to provide for heavy current, required when lamp is started or when carbons become stuck, without overfusing the wires.

b. Must only be furnished with such resistances or regulators as are enclosed in non-combustible material, such resistances being treated as sources of heat. Incandescent lamps must not be used for resistance devices.

c. Must be supplied with globes and protected by spark arresters and wire netting around globe, as in the case of series arc lights.

Outside arc lamps must be suspended at least 8 feet above sidewalks. Inside arc lamps must be placed out of reach or suitably protected.

22. Constant-Current Arc Lamps.—Arc lamps used for street lighting are nearly always run in series. With this arrangement the same current flows through all the lamps and must be maintained at a constant value by the generator, no matter how many lights may be in operation. The voltage generated by the dynamo therefore varies with the load and the current remains constant. This is just the reverse of the constant-potential system. It is easily seen that if the number of lamps is at all large, the pressure applied to the circuit has to be very high; hence, arc lamps connected to such a circuit must be treated as being on a high-pressure system and wired accordingly. Series arc lamps are also used for indoor illumination, though not as extensively as formerly.

23. In all constant-potential installations, protective devices are installed to open the circuit whenever the lines are overloaded or the apparatus does not operate properly. In constant-current working, the circuit must never be opened while the dynamo is running. The protective devices used on constant-potential working must, therefore, never be installed on constant-current circuits.

All series-arc apparatus is thrown out of circuit by shunting or short-circuiting the main circuit before opening the lines on which the apparatus is connected. The switch should be constructed so that the lamp will be disconnected from the line after it has been shunted and the switch should indicate clearly whether it is on or off. It should also be semi-automatic in its action; i. e., when the handle has been

thrown the blades should be so actuated by springs that they will move quickly and not stop between points and thus draw an arc. The constant-potential arc lamp has proved such a success that it has largely replaced the series lamp for interior lighting, thus doing away with the high-tension wiring, which at best was always a necessary evil.

24. The general method of installing series arc-lighting wires is similar to that used in other high-tension interior work. They must be very thoroughly protected against accidental contact with anything not intended to connect with them.

Rubber-covered wire mounted in plain sight on porcelain insulators must be used and an approved service switch must be placed where the wires enter the building so that the high-tension current can be completely cut off by firemen or policemen in case of fire in the building. The wires must be kept at least 8 inches apart. It must be remembered that there is always a strong tendency for grounds to develop on series arc-light circuits on account of the high pressure used. For this reason the Underwriters' rules are particularly exacting regarding the insulation of interior wiring for this class of work, and all fittings used must be carefully selected; for example, ordinary snap switches are not allowed. In case it is necessary to run the wires up side walls, they must be protected by a boxing that will leave a clear air space of 1 inch around the wires. This boxing must be closed at the top in order to keep out dirt and rubbish and the wires must be bushed with porcelain tubes where they pass through the top of the casing.

The current supplied to constant-current arc lamps seldom exceeds 9 or 10 amperes and often it is as low as 6.6 amperes. As far as mere carrying capacity is concerned, No. 14 wire will be large enough to satisfy the Underwriters' requirements; but the wire is frequently of the same size as that used by the lighting company for the outside lines, which must be as large as No. 6 or No. 8 B. & S. in order to secure sufficient mechanical strength and also in order to reduce the drop in the line.

25. The tendency is to connect more and more arc lamps on a series circuit. In the early days of electric lighting, arc machines were made to operate 1, 2, or 3 lamps. The number was increased to 30 or 50, and finally to 60, where the limit remained for a few years. But machines are now built to operate as many as 125 lamps on a single circuit, and are in quite general use, although the Underwriters prohibit the bringing of circuits of more than 3,500 volts (70 series arc lamps) within buildings. With 45 volts at the arc and 5 volts lost on the line for each lamp, we have on a 125-lamp machine a total potential difference of 6,250 volts. A shock received through the human body from such a circuit is almost sure to be fatal. Too much care cannot be taken not only to insulate the wires and locate them out of reach, but also to insulate the lamps. They should be hung from an approved form of hanger board or insulated supports, and not from hooks screwed into the ceiling.

26. Incandescent Lamps on Series Circuits.—The use of incandescent lamps connected in series for street lighting is quite extensive, but such lamps are rarely brought inside of buildings. When they are, the rules for other classes of high-potential work apply. Each lamp must be provided with an automatic cut-out and must be suspended from a hanger board by means of a rigid tube. Lamps must not be connected in series-parallel or parallel-series and under no circumstances should they be attached to gas fixtures.

Incandescent lamps used on series circuits must be provided with fittings designed for that purpose. The rule against series-parallel connections means that a connection such as twenty 110-volt lamps in parallel must not be placed in series with a 10-ampere arc-lighting system. The burning out of one or two incandescent lamps on such a system would throw too much current on the others, burn them out, and destroy the sockets. Many other reasons forbid such connections.

WIRING FOR ELECTRIC MOTORS

27. The wireman is frequently called on to connect up motors; these are nearly always operated at constant potential, and the wires are installed as for other wiring of this kind. They are usually operated on 110, 220, or 500 volts direct current or on similar voltages alternating current. Alternating-current motors are usually run on either the two- or three-phase system. Care should be taken to see that the interior wiring has sufficient capacity; to determine which, the current taken by the motor at full load should be known.

It is well to allow a liberal amount of current for small motors, because of their low efficiency. The efficiency of a large motor can be learned from the manufacturer; and high-grade high-priced machines are more efficient than cheap ones; this is a most important consideration to the purchaser. For the purposes of wiring, however, it is safe to figure 90 per cent. efficiency for motors over 10 horsepower in capacity, 85 per cent. for motors between 5 and 10 horsepower, 80 per cent. for motors between 2 and 5 horsepower, 75 per cent. for motors of 1 horsepower, and lower efficiencies for motors of smaller sizes. Alternating-current motors take somewhat more current for the same output than those operated on direct current. Table I gives the approximate value of the current in the lines for motors of various sizes and voltages. These figures will vary somewhat in individual cases, because the efficiency and other characteristics of motors vary considerably. The current taken by a motor at full load is usually given by the makers on the name plate of the machine. If it is not given, the table will serve as a guide in determining the size of wire to be used.

28. Motors should, whenever possible, be insulated from the ground by means of wooden base frames. This, however, can seldom be done when motors are mounted on machine tools or for similar work. The wiring must be carried out in the same way as required for lights. Where motors are mounted near or on machinery, special precautions

TABLE I
CURRENT REQUIRED BY MOTORS

Horsepower	Direct-Current Motors			Alternating-Current Motors											
	110 Volts	220 Volts	500 Volts	Single Phase			Two Phase (Four Wire)			Three Phase (Three Wire)					
				110 Volts	220 Volts	500 Volts	110 Volts	220 Volts	500 Volts	110 Volts	220 Volts	500 Volts			
1	9	4.5	2.0	14	7	3.1	6.4	3.2	1.4	7.4	3.7	1.6			
2	17	8.5	3.7	24	12	5.3	11	5.7	2.5	13	6.6	2.9			
3	26	13	5.6	34	17	7.5	16	8.1	3.5	19	9.3	4.1			
5	40	20	8.8	52	26	11	26	13	5.5	30	15	6.4			
7½	60	30	13	74	37	16	38	19	8.1	44	22	9.3			
10	76	38	17	94	47	21	44	22	10	50	25	12			
15	112	56	25				66	33	15	76	38	17			
20	150	75	33				88	44	19	102	51	22			
30	226	113	50				134	67	29	154	77	33			
40	302	151	66				178	89	39	204	107	45			
50	368	184	81				204	102	45	236	118	52			
75	552	276	122				308	154	68	356	178	77			
100	736	368	162				408	204	90	472	236	104			
150	1,110	555	244				616	308	135	710	355	156			
200	1,474	737	324				818	409	180	940	470	208			

must be taken to protect the wires by running them in pipe or flexible conduit. The branch circuits running from the mains to a motor should be designed to carry at least 25 per cent. more current than that for which the motor is rated, in order to allow for the large current at starting and for occasional overloads. A main switch must be provided that will open all wires leading from the mains to the motor unless the motor is less than $\frac{1}{2}$ horsepower and is operated on less than 300 volts, in which case a single-pole switch may be used. Each motor must also be provided with a cut-out, but if an automatic circuit-breaker that opens all the wires leading to the motor is used, the main switch and cut-out may be dispensed with and the automatic circuit-breaker made to serve both as switch and cut-out. A single-pole circuit-breaker cannot be used instead of the switch and cut-out; in any event it is advisable to equip motors with circuit-breakers, particularly if they are used to drive machinery likely to cause temporary overloads.

29. The switch and starting box should be located within sight of the motor and the starting box should be equipped with an automatic release attachment that will allow the rheostat arm to fly back to the off-position in case the power fails. Motors must not be run in series-parallel or parallel-series except on constant-potential systems, and then only by special permission.

The Underwriters' rules prohibit the operation of motors or lights from street-railway circuits, except in street cars, car barns, or railway power houses. The reason for this is that one side of a railway system is grounded to the rails, and the installation of motors or lights would always introduce more or less fire risk.

BELL WIRING

30. Electric bells, burglar alarms, and electric gas-lighting appliances bring in another class of wiring with which the wireman has to deal. If these appliances are put in properly, they may be a great convenience; if not, they are continually getting out of order and may prove to be a regular nuisance. This class of work is often slighted and put up in a cheap manner, but it will pay in the end to have it put up carefully. The bells and annunciators that show from what point the bell was rung are operated by primary batteries, which are of low voltage, and no fire hazard is introduced if the bell wires are kept well separated and insulated from electric light and power wires.

THE ELECTRIC BELL

31. The electric bell is a very simple piece of apparatus. Fig. 5 shows a skeleton bell, in which all the parts are visible. With the battery wires connected at the terminals t, t' , the course of the current is: From the terminal t to the adjustment screw s , which is tipped with platinum in order to prevent oxidation of the contact surface, through the spring l and the end p of the armature to the coils of the magnets m, m' , and out at the terminal t' . When no current is passing, the armature is held from the poles of the electromagnets, as in the position shown, but as soon as a battery circuit is closed and a current sent through the coils, the magnets become energized and attract the armature a , which swings about the pivot p , causing the hammer h to strike the bell. This movement breaks the circuit between s and l , and the iron cores being thereby demagnetized, the spring c draws the armature away, when the spring l again touches the screw s , completing the circuit. As long, then, as the battery current is free to flow, this vibration of

the armature and hammer will continue. The tension of the release spring c may be changed to suit the strength of the battery by means of the regulating screw r , which is provided with nuts on each side of the supporting pillar. The bell mechanism is usually enclosed to prevent entrance of dust or insects, which may interfere with the working of the bell by lodging on the contact points, thereby preventing the current from passing through the magnets.

32. The bell just described is of the common vibrating class. When a bell is required to give a single stroke each time the circuit is closed, that is, for each momentary flow of current, a slight difference in the connection of the ordinary bell is necessary. A wire is connected between the end of the magnet coil m and the terminal t , so that the circuit is simply from one terminal to the other through the coils. Hence, when a current passes through the coils, the armature is attracted and held, a single stroke being given to the bell; on interrupting the current, the armature is drawn back to its normal position by the spring c .

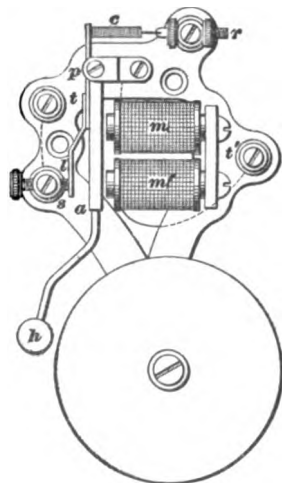

FIG. 5

33. The **buzzer**, shown in Fig. 6, is used in places where an electric bell would be undesirable, as in small, quiet rooms or on desks, and is constructed on the same principle as the bell except that the armature does not carry a hammer. In the illustration, the cover c is removed, showing the magnet coils m, m' and the armature a . An adjusting screw s is provided to regulate the stroke of the armature and the consequent intensity of sound. The wires from the push button and battery are secured at d and e , and on closing the circuit, the rapid vibration of the armature causes a humming or buzzing sound, whence the name.

Buzzers are generally used for signaling in places where a bell would make too much noise, as, for example, between the dining room and kitchen of a residence.

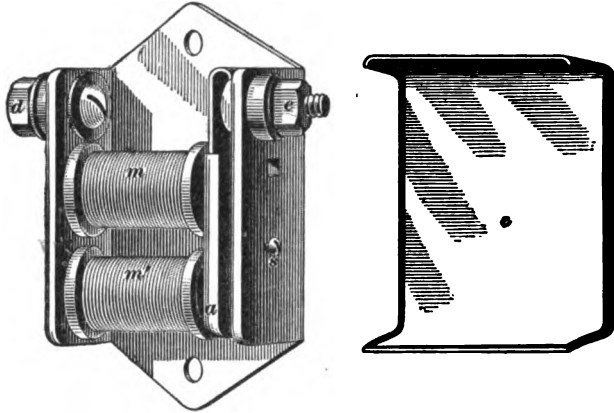

FIG. 6

34. The circuit-closing devices used on bellwork usually take the form of a push button. These are made in all sorts of styles. The very cheap wooden ones are seldom

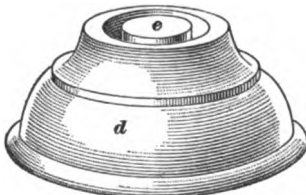
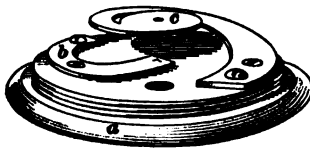

FIG. 7

satisfactory and bronze push buttons should be used where exposed to the weather. Fig. 7 shows the ordinary round push button. The wires enter through holes in the base and attach to springs *b* and *c*; the cover *d* screws on. When *e* is pushed, *b* and *c* come together, and complete the circuit.

One cell of any efficient type will ring a good bell over a short length of wire, but it is never advisable to rely on less than two cells, even in the smallest installations. When several cells are connected together to form a battery, the zinc of one must be joined to the carbon of the next and the free

terminals at the ends of the row of cells connected to the line wires.

35. Electric bells can be had of all sizes. Very cheap bells should not be used, as they require much battery power and soon get out of order. Trouble is usually found first at the contact points or the armature pivot. Contact points should be tipped with platinum or silver; platinum being much the better material for this purpose, as it never corrodes or tarnishes, but it is more expensive than silver, which is much used on cheap bells.

In an ordinary dwelling there are frequently three electric bells, one located at a convenient point in the rear hall with a push button at the front door; one in the kitchen with a push at the back door, and one, a buzzer, located in the kitchen with a push in the dining-room floor. These bells may all be operated by the same battery. The battery should be located in a cool place, but where it never is cold enough to freeze; preferably in the cellar, where the air is not so dry that the water in the cells evaporates rapidly. Cells should not be allowed to become dry. Water should be added from time to time so as to keep the level of the solution up to the proper height, which is usually marked on the glass jar.

BATTERIES

36. Many different types of cell are manufactured that are suitable for bellwork. Most of them are of the open-circuit type, which are intended to furnish current for short intervals only and will run down if used continuously. Crosses between the wires or grounds will often cause the cells to run down rapidly. Most of these cells will recover to a certain extent if allowed to stand for a while on open circuit, but they should never be allowed to become short-circuited if it is possible to avoid it.

The cells in ordinary use on bellwork have electrodes of zinc and carbon and contain a solution of sal ammoniac (ammonium chloride). Sometimes they also contain a

“depolarizing” agent, such as manganese dioxide. The effectiveness of a carbon-zinc cell depends largely on the materials of which the carbon element is made and the skill used in its manufacture. Burning the carbons too much or too little in the process of manufacture makes them inferior. Some manufacturers make inferior carbons and then treat them with sulphuric acid, to make them operate with vigor when first installed. Such cells soon become polarized, and in the course of a few weeks or months are very inferior, not because of the acid so much as because of the poor quality of the carbon. Dry cells are very convenient, but as a rule they do not last as long as wet cells. Sometimes they can be recharged by sending a current through them in a direction opposite to that in which they furnish current, but such recharging does not last long. When dry cells have run down, the cheapest and most satisfactory way in the end is to throw them away and get new ones. Suitable cells for bell operation are: Leclanché, Carbon Cylinder, Fuller Bichromate, Dry Cells, Gordon, and Edison-Lalande. The two last named are particularly useful on circuits where the insulation is poor and where there is, consequently, considerable leakage, as, for example, on signal circuits in mines.

37. In a few cases, as in certain burglar-alarm systems, the circuit is normally closed and the opening of the circuit interrupts the current. In these systems, the battery must be capable of furnishing current steadily; that is, it must be of the *closed-circuit type*. The *gravity cell* is a common closed-circuit type and is well adapted for work where a small steady current is desired; in fact, gravity cells will get out of order if allowed to stand for any great length of time on open circuit.

OPERATING BELLS FROM LIGHTING CIRCUITS

38. It is sometimes convenient to operate an electric bell from an incandescent lighting circuit. This may be done when direct current is used to operate the lamps, but if alternating current is used, an ordinary bell will work very

poorly, if at all. Of course, it is necessary to use a resistance in connection with the bell in order to limit the current; the amount of resistance will depend on the kind of bell used, because some require much more current than others. Incandescent lamps make a cheap and convenient form of resistance; Fig. 8 (a) shows a bell *a* and push button *b* in series with four lamps *l* across a 110-volt circuit. This is the simplest scheme of connection, but there is apt to be bad sparking at the contacts on the bell, because the voltage across the break rises to 110 volts at the instant the circuit

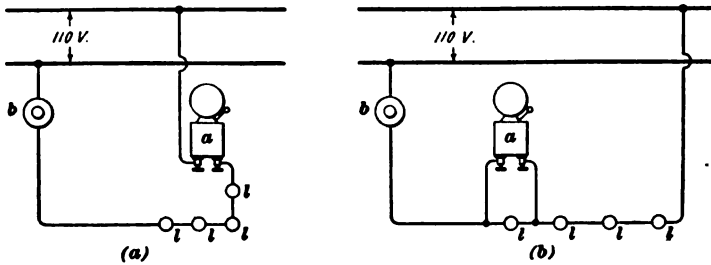

FIG. 8

is broken. View (b) shows the bell shunted across one of the lamps, in which case the voltage at the break is much smaller. The operation of bells from lighting circuits is not to be recommended and it will not be allowed by the Underwriters unless the whole of the bell wiring is installed in accordance with the wiring requirements for lighting circuits. Ordinary bell wiring put up with staples, etc. must *not* be connected to any source of pressure exceeding 10 volts, and it would be decidedly unsafe to connect it to a 110-volt circuit.

39. A better method of utilizing the lighting current for bell operation is through the medium of storage cells, as shown in Fig. 9. Two sets of cells *a, b* are connected to double-pole double-throw switches, as indicated. When both switches are thrown up, both sets of cells are charged from the lighting circuit. Normally, one set of cells will be charging while the other is in use, as indicated by the position of the switches in the figure. Of course, if the bell circuits are

such that they will not be used during certain hours each day, the cells can be charged during this interval and only one set will be needed. Storage cells are somewhat high in first cost as compared with ordinary primary cells, but one storage cell gives about twice the voltage of an ordinary sal-ammoniac cell, so that only half as many are required for

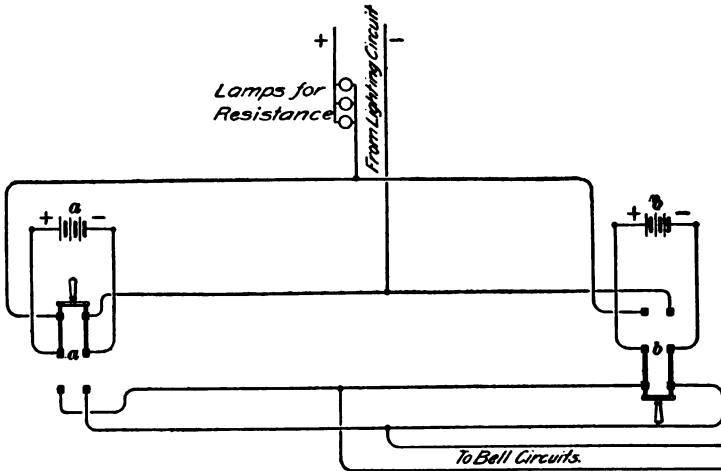

FIG. 9

a given voltage. In Fig. 9, lamps or some other form of resistance must be connected in series when charging the cells in order to limit the current. By using storage batteries, as shown in Fig. 9, the bell wiring is never connected to the lighting circuits and it does not need to conform to the Underwriters' requirements for light or power wiring.

ANNUNCIATORS

40. When a number of push buttons are installed, it is convenient to have an indicating device to show from which button the bell is rung. This instrument is called an **annunciator**. An ordinary house style is shown in Fig. 10. On the face are rows of small windows, before one of which an indicator appears when the bell rings, showing from which room the signal has been sent. A handle *h* at

the side is intended to be used to restore the indicators to their normal position when the call is answered. A view of the indicator itself is given in Fig. 11. A hinged arm *a* carries a card bearing the name or number of the room to which the drop is connected, and is held up in the position shown by a counter-balanced trip *t* in front of an electromagnet *m*. As soon as the current passes through the electromagnet, the trip is attracted and the indicator falls, being then visible from the outside through one of the openings in the front.

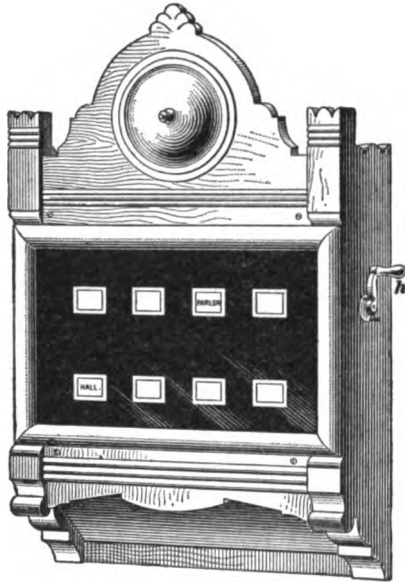

FIG. 10

41. The needle annunciator, Fig. 12, is a style much used in hotels and for elevators. The current on passing through the electromagnet of an indicator attracts a pivoted iron armature carrying a pointer *P* on the outside dial, causing it to set in an oblique position, in which it is held by a catch until released by pressing the knob *k* below the case. Annunciators can be obtained in almost any desired finish and for any number of drops. One type that has lately become very popular is the self-restoring annunciator.

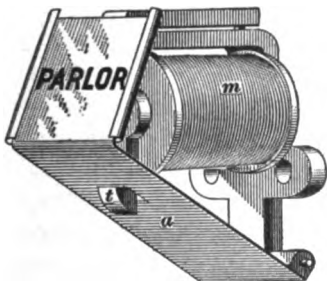

FIG. 11

the current on passing through the electromagnet of an indicator attracts a pivoted iron armature carrying a pointer *P* on the outside dial, causing it to set in an oblique position, in which it is held by a catch until released by pressing the knob *k* below the case. Annunciators can be obtained in almost any desired finish and for any number of drops. One type that has lately become very popular is the self-restoring annunciator.

In the ordinary instrument, the drops must always be put back after a call comes in; sometimes this is not done, and consequently one is at a loss to

know, when several are down, which button has been pushed. Self-restoring annunciators are constructed so that when a button is pushed its corresponding drop falls and remains down until the next call is sent in. This operates a magnet that moves the restoring device and resets the first drop. Self-restoring annunciators are somewhat more liable to get out of order than the simple kind and some of them require more battery power. They are, however, a great convenience, and are rapidly finding favor. They are wired up to the buttons in the same way as an ordinary annunciator, as the restoring device is wholly within the annunciator itself and therefore does not affect the outside connections.

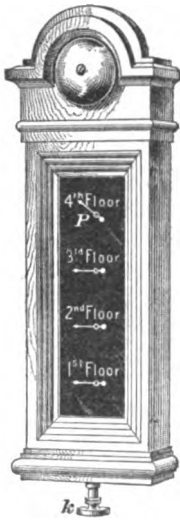

FIG. 12

RUNNING BELL WIRE

42. There are no regulations governing the insulation used on bell wire. That generally used is known as *annunciator wire* and is usually No. 16 or No. 18 B. & S. copper-covered, with two wrappings of cotton treated with paraffin. This wire is cheap, but it is not moisture-proof, and the insulation does not adhere very firmly to the wire. However, it will work satisfactorily if it is carefully put up and is run in a dry place. For good work, *weather-proof office wire* or rubber-covered wire should be used. The insulation on

the weather-proof wire is heavier than on the annunciator wire and adheres firmly; it is also damp-proof. If it is necessary to run bell wires where they will be exposed to considerable moisture, the best plan is to use rubber-covered wire.

The size of wire used is generally No. 16 or No. 18 B. & S. It will pay to use nothing smaller than No. 16, because the cost is very little more, the line resistance is thereby reduced, the batteries work to better advantage, and the line is mechanically stronger. For the main-battery wire in large installations, No. 14 may be used to advantage.

Bell wires are often stapled to woodwork, especially when bells are installed in old houses. If any stapling is done, care should be exercised not to drive the staples so hard that they cut through the insulation and break the wire. Do not fasten two wires down under the same bare staple; special staples, using a small saddle of leather between the wire and the top of the staple, are made for this work. When bell wires are run in new buildings, they may usually be run through holes in the beams, and they should be grouped together as much as possible. By doing this, the wires are run in an orderly manner and very little stapling is needed.

In the best class of work, bell wires are sometimes run in conduits, but no matter how they are run, all circuits should be carefully tested out after they are put up to make sure that there are no grounds, breaks, or crosses. See that all bell wires are kept well away from electric-light wires and that no push buttons are mounted in the same wall plate with electric-light switches.

BELL AND ANNUNCIATOR CIRCUITS

43. Fig. 13 shows a number of connections for simple bell circuits; for the operation of such circuits two or three cells will usually be sufficient. In (*a*), a single bell is operated from a single push button; (*b*) shows two bells operated in parallel from a single button; (*c*) shows two bells operated in series from a single button. When bells are operated in series, all but one of them should be made single stroke so that the interruption of the current will be performed by one bell only; otherwise, the bells will not work satisfactorily because one may open the circuit at the same instant that another tries to close it. View (*d*) shows one bell operated from either of two push buttons. Views (*e*) and (*f*) show two arrangements for ringing two bells from any one of three stations. Fig. 14 shows a plan of bell wiring suitable for a small dwelling where no annunciator is used.

Fig. 15 shows a method of controlling a bell from two stations by using two switches *a, b*. The bell can be rung

from either station independently of the position of the switch at the other station. Fig. 16 shows a method of controlling a bell from three stations. It is the same as Fig. 15 except that a four-point switch is cut in for the intermediate station. In one position, points 1, 2 and 3, 4 are connected, as shown, by the dotted lines. In the other position, points 1, 3 and 2, 4 are connected. The connections shown in Figs. 15 and 16 correspond to those used for

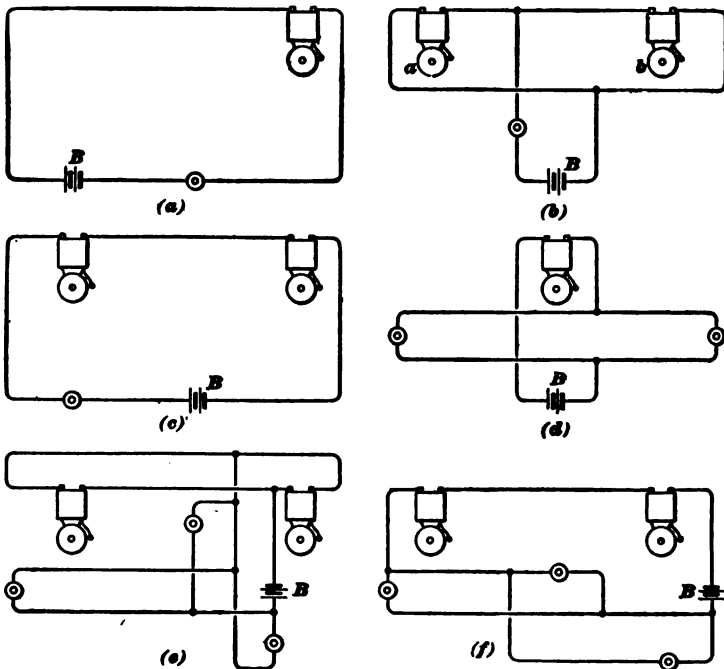

FIG. 13

the control of incandescent lamps from two or more points and by adding an additional four-point switch to Fig. 16 for each intermediate station the plan can be extended to any number of stations.

Placing bells in parallel requires a larger volume of current to be supplied than when they are in series, because the total current subdivides among all the bells. This calls

for a large battery and large wires. When the branch circuit containing one bell is very much longer, and hence of higher resistance than the branch containing another bell, the current will not divide equally between the two bells,

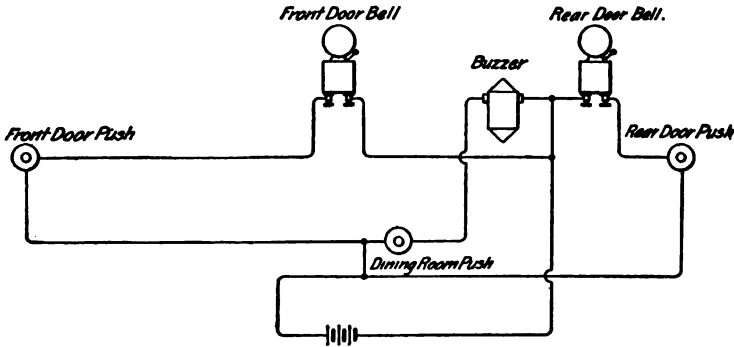

FIG. 14

and hence the parallel arrangement may not be satisfactory in such cases. Placing the bells in series requires an additional cell or two, but no larger wire is needed.

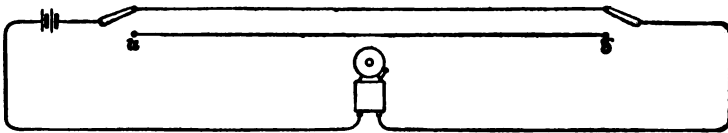

FIG. 15

44. Wiring for Simple Annunciator.—A wiring diagram for a simple annunciator system is shown in Fig. 17. The pushes 1, 2, 3, etc. are located at convenient points in

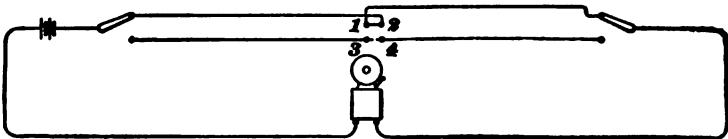

FIG. 16

the various rooms, one terminal being connected to the battery wire *b* and the other to the leading wire *l* communicating with the annunciator drop corresponding to that

room. The battery wire is run from one pole of the battery direct to one side of each of the pushes. The other side of each push is then connected to its drop on the annunciator. A battery of three or four Leclanché cells is placed at *B* in

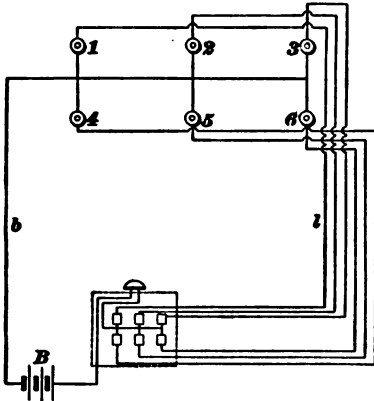

FIG. 17

any convenient location, but should not be set in a dark or inaccessible spot or be exposed to frost.

45. Wiring for Return-Call Annunciator.—One of the many methods for connecting return-call annunciators is shown in Fig. 18. It requires one leading wire from each station to the annunciator and two battery connections to each station,

as indicated by the branches from the heavy battery wires. The annunciator board is divided into two parts—the upper part having the bell and the numbered drops, and the lower the return-call push buttons. Each room is also provided with a double-contact push, such as is shown in Fig. 19. The tongue *t* makes connection normally with the upper contact *c*, but when pressure is put on the button *k* the tongue is forced against the lower contact *c'* and connection with the upper contact is broken. The return-call buttons on the lower part of the annunciator are of the same description. Assume, in Fig. 18, that the button in room 1 is pressed; current can then flow from the + side of the battery—annunciator bell—drop 1—upper contact of button 1'—tongue of button 1''—negative side of battery by way of lower contact on 1'' since this button is supposed to be pressed down. This rings the annunciator bell and operates drop 1. As soon as 1'' is released, the tongue makes contact with the upper point as indicated. To send the return, signal button on the annunciator 1' is pressed, thus allowing current to flow from positive side of battery—bell

1-tongue of button 1''-tongue of button 1'-negative side of battery, since button 1' is now pressed down. It will be noticed that a signal sent from a room to the office

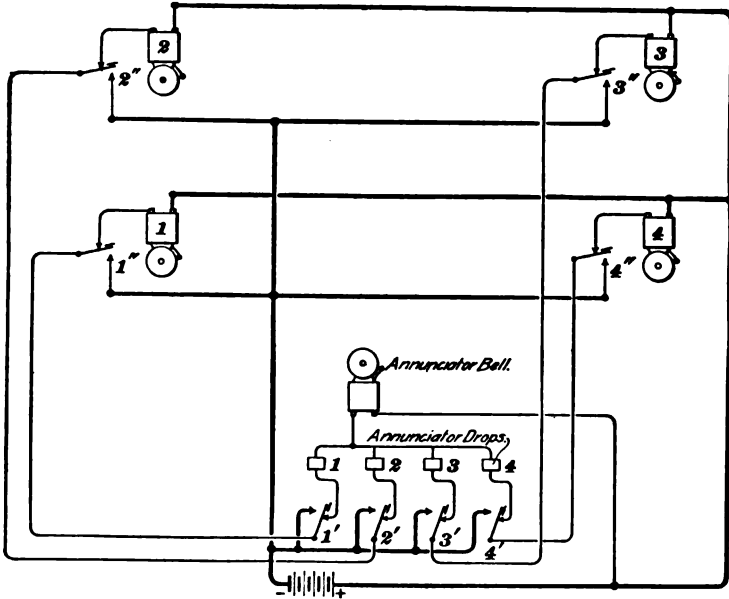

FIG. 18

does not ring the bell in the room but does operate the annunciator bell and drop. On the other hand, a call sent from the office operates the bell in the room but does not operate the annunciator bell or drop.

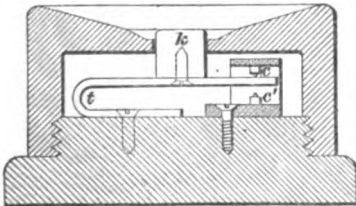

FIG. 19

46. Fig. 20 shows another method of wiring very similar to Fig. 18, except that two sets of cells are used. Battery *A* furnishes the current for sending signals from the rooms and *B* for sending signals to the rooms. The batteries must be connected with their polarities as shown, so that in case a push in one of the rooms and one at the annunciator

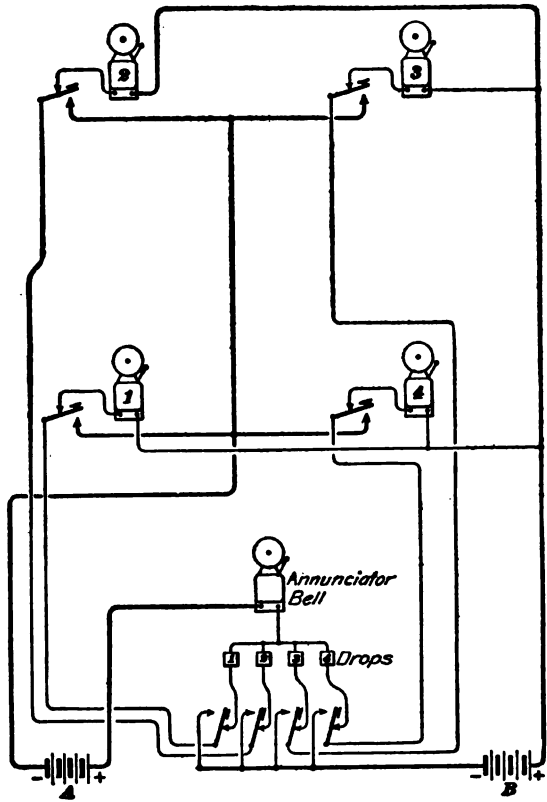

FIG. 20

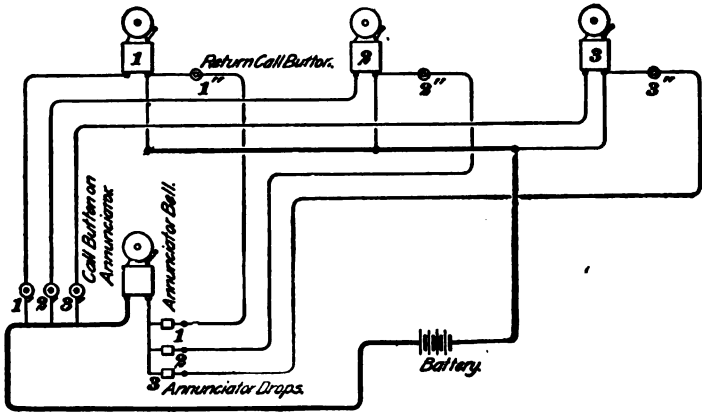

FIG. 21

should happen to be pressed at the same instant, the two sets of cells would oppose each other and would not cause all the drops and bells to operate. This scheme of connections is used with Holtzer-Cabot, and Partrick Carter and Williams annunciators, but those of either make can be connected as in Fig. 18 if desired. There is an advantage in having the cells separated into two groups because the sending signals in a certain installation may be more frequent than the return signals, or vice versa, and each set of cells can be kept in a condition suited to the work it has to do, independently of the other set.

47. Fig. 21 shows a third method of wiring a return-call annunciator. Here, there are two leading wires from each station to the office and only one battery wire is required. Ordinary push buttons are used. On account of the necessity of two leading wires for each station this plan would in most cases require somewhat more wire than that shown in Figs. 18 or 20.

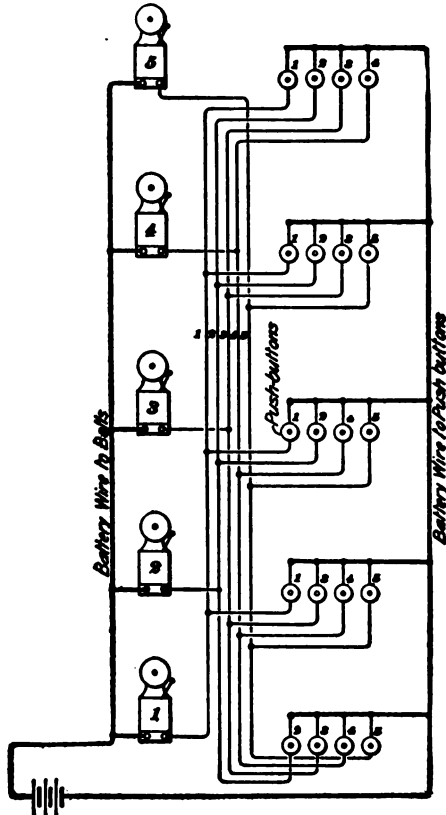

FIG. 22

On account of the necessity of two leading wires for each station this plan would in most cases require somewhat more wire than that shown in Figs. 18 or 20.

48. **Wiring for Speaking-Tube System.**—Fig. 22 shows a plan of wiring frequently used in connection with speaking tubes. There are five stations with a bell and four

push buttons at each. Any bell other than the one at the calling station can be rung by pressing the corresponding button, and the bell at any given station can be rung from any of the other four stations.

49. Bell Wiring for Flats.—Fig. 23 shows a plan of wiring for door bells in flats. Four push buttons are placed at the main-hall entrance. Each flat is also provided with a push button at its front door and a second push button at the rear door.

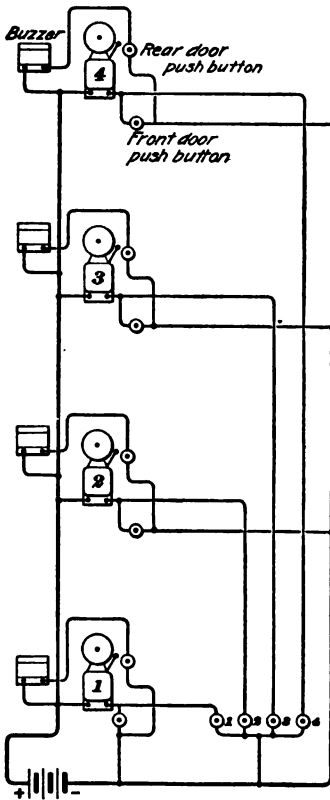

FIG. 23

Each flat is also provided with a push button at its front door and a second push button at the rear door. The rear-door button operates a buzzer so that a signal from it can be distinguished from a front-door signal.

50. Wiring for Fire-Alarm Gongs.—The wiring shown in Fig. 24 is suitable where fire-alarm gongs are installed. All the gongs ring when an alarm is sent from a station and an annunciator is placed at each station to indicate the point from which the alarm was sent in. If the switch at station 3, for example, is closed, all three gongs will ring and drop 3 on each annunciator will indicate the point from which the alarm is sent. The dotted lines indicate another method of installing the battery.

If connections *a, a, a* are omitted, batteries *b, b, b* placed at each station, and the main battery replaced by connection *c*, the system as a whole will be more reliable than if a single battery were used, because if one of the batteries fails it only cuts out of action the

corresponding bell and annunciator and the others continue to operate.

51. In installing annunciator systems, it is usual to run the battery wire, which is No. 14 or No. 16 annunciator wire, through the building at some central portion. If there are many rooms, it will be advisable to splice on a length of No. 18 wire to extend from the push in each room to the

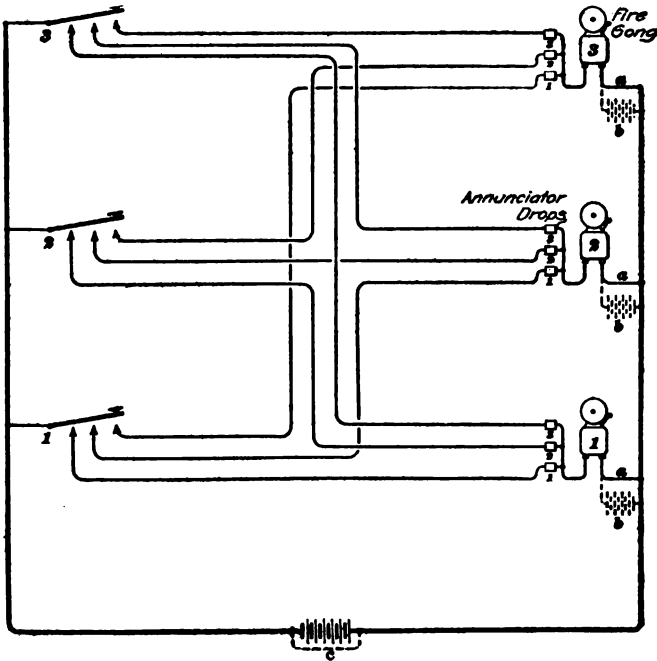

FIG. 24

battery wire. The connection from the other side of the push button to the annunciator, that is, the leading wire, should be No. 18. For the return-call system, a battery of four or five Leclanché cells is required.

All wires used in annunciator service should have distinguishing colors to prevent confusion. The battery wire may be blue, the return wire red, and the leading wires

white. This arrangement will greatly simplify the connections and reduce the liability of mistake.

52. Wiring for Elevator Annunciator.—The wiring for an elevator annunciator does not differ greatly from that of a simple annunciator; in fact, the scheme of connections is essentially the same. A battery wire *b*, Fig. 25, is run up the shaft and connected to each push button on the different floors. The return wires from each button are then carried

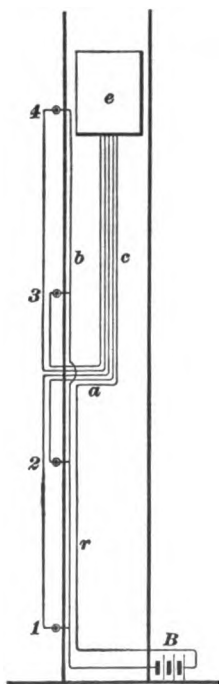

FIG. 25

to a point *a* at the middle of the shaft, where they should terminate in a small connection board, so that they may be readily disconnected from the wires in the cable running to the cage *e*. The wires running from the connection board to the cage are in the form of a flexible cable, which is made especially for this kind of work. This cable contains one more wire than there are push buttons, because it has to provide for the return wire *r*.

SPECIAL APPLIANCES

53. The Automatic Drop.—For special alarm purposes, it is sometimes desirable that the bell should continue to ring after the push is released. This is accomplished by the use of an **automatic drop**, which closes an extra, or shunt, circuit as soon as a current passes along the main circuit. Fig. 26 shows two views of an automatic drop, *A* being a side elevation and *B* a front view with the cover removed. There are three terminals on the baseboard; those marked *a* and *b* are connected to the ends of the magnet coil, the end at *b* being also connected to the frame *f*; terminal *c* makes connection to the spring contact *d*, which is insulated from the frame and all other wires. The bell circuit is

closed first through *a-b* by means of the push button; the armature *e* is at once attracted, thereby releasing the rod piece *g*, which falls by gravity and makes contact with the spring *d*, establishing a circuit between *b* and *c*, which short-circuits the push button and magnet coil of the drop.

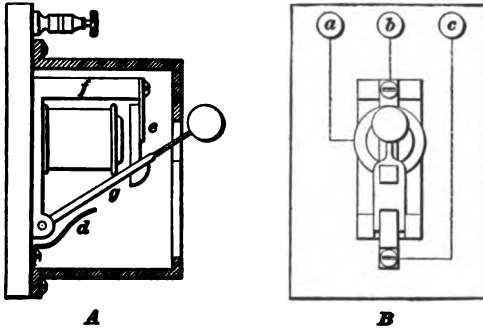

FIG. 26

54. The connections for the automatic drop are shown in Fig. 27. The circuit obtained, on pressing the push button *p*, is from the positive pole of the battery *B* through the push to the terminal *a* of the

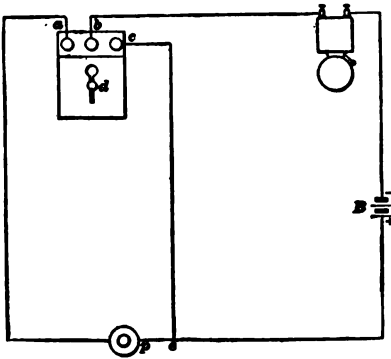

FIG. 27

drop, through the magnet coils to *b*, and then through the bell to the negative pole of the battery. As soon as *d* falls, the magnet coils are cut out, the current being diverted at *e*, and passes by way of the new contact from *c* to *b*, and thence through the bell and back to the battery.

Vibrating bells are sometimes made with a continuous ringing attachment that takes the place of the automatic drop. A small lever is mounted near the armature of the bell so that when the armature is attracted the lever is released by the movement of the armature and drops down, thus completing

the shunt circuit around the push button and allowing the bell to ring until the small lever has been restored to its normal position.

55. Two-Point Switch.—When two bells are arranged to ring from one push button, it is sometimes desirable to cut one of them out during some part of the day. For this purpose a small switch, Fig. 28, is used, by means of which one bell, when connected in series with the other, may be short-circuited. The wires are run to the back of the switch, one connection being to the lever arm at *a*, the other to the contact piece *b*.

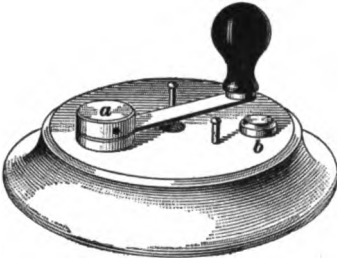

FIG. 28

56. Door Openers.—In apartment houses, banks, and other places it is often convenient to have the latch on a door arranged so that the door may be unlocked from some distant point. For this purpose door openers are used. These are made in a number of different styles, the mechanism differing with the different makes. In all of them, however, the unlocking is effected by means of an electromagnet, which is connected to the push and battery in the same way as an ordinary bell.

BURGLAR ALARMS

57. Automatic switches may be placed on windows and doors, in connection with alarm bells, to indicate when entrance into a building is being forced. There are three methods of installing these alarms—the open-circuit, the closed-circuit, and the combined open-and-closed circuit systems. In the **open-circuit system**, which is the one usually employed, the connections are similar to those of an ordinary electric-bell circuit, the automatic circuit-closing device being substituted for the push button. There are many different kinds of window springs made, one of which

is shown in Fig. 29. This is let into the window frame, the cam *c* alone projecting; when the window is raised, the cam is pressed in, revolving about the pin *p*, and makes contact with the spring *s*, which is insulated from the plate by a washer at the lower end and is normally prevented from touching the cam by an insulating wheel *w*. The wires from the bell and battery are connected to the plate and spring, respectively. The annunciator used is much the same as that employed for bellwork, but additional convenient attachments are usually placed on it, such as a device to keep the bell ringing until the annunciator is reset, a clock to connect and disconnect the system at certain hours, etc. The annunciator is usually equipped with a small button over each drop, which when pushed will complete the circuit and cause the drop to fall if there happens to be any door or window open. These are very useful for testing out to see if everything is closed. All these appliances belong to the annunciator itself and do not affect the general plan of wiring, which is carried out in the same way as for bell wiring.

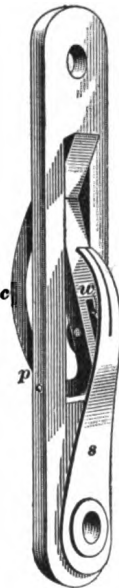

FIG. 29

58. Open-Circuit System.—In Fig. 30 is shown an ordinary annunciator, arranged to be used as a burglar alarm. During the day, when not in use, the switch *s* is placed on the intermediate, or open position, as shown. When closing the alarm for the night, a silent test is made by placing *s* first upon contact *a*, and closing the individual circuit switches *k*₁, *k*₂, one at a time; if any window or door on a circuit is open, the annunciator included in that circuit will allow its shutter to fall, but the bell will not ring. After all the windows, doors, and individual switches are closed, the switch *s* is placed upon contact *c*. If, during the night, any window or door, for instance in the hall, is opened, one of the contacts *e*, *e* in the hall circuit will be closed, and a current flowing through line *l* will cause the shutter of the annunciator *a*, to fall and the bell *v* to ring. With some

annunciators, the bell is arranged to ring continuously when once it is started. This may be done in various ways, one of which is indicated by the dotted lines in the figure, whereby a circuit through the bell v , resistance r , and battery B is closed when any shutter drops.

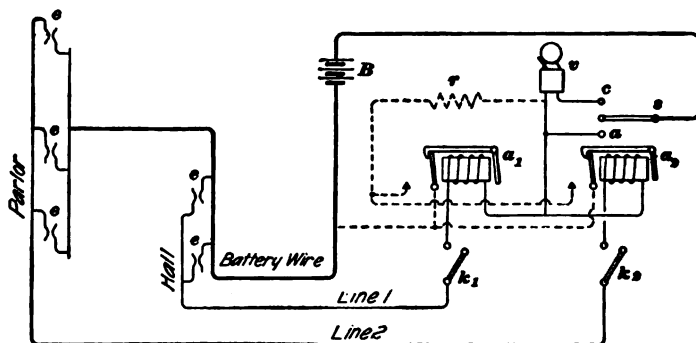

FIG. 30

59. Closed-Circuit System.—In Fig. 31 is shown a closed-circuit burglar-alarm system, so called because current normally flows through the various circuits, and the bell only rings when the circuit is opened. The current that flows normally through the various circuits from the

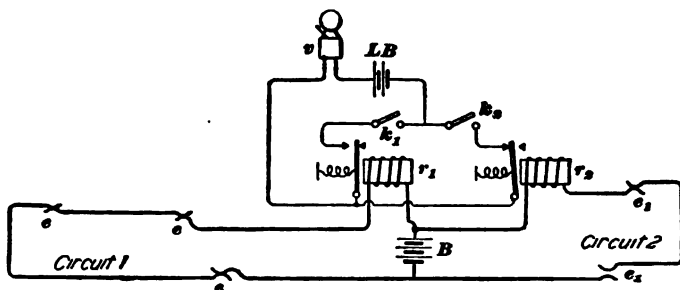

FIG. 31

battery B , energizes the relays r_1 , r_2 , and keeps the local bell circuit open. Should the circuit be opened by opening a door or window or by breaking a wire, as at e_1 , the relay r_2 will release its armature and thereby allow current from the local battery LB to ring the bell v , which will not stop until

the switch k , is opened, the relay circuit closed, or the battery LB gives out. In this system, the main battery B must be of the closed-circuit type because it has to furnish a small current continuously.

60. Open and Closed Circuit System.—Where a system is desired to give an alarm, whether the circuit is opened or closed at a window or door, or the wires broken or crossed at any point, the arrangement shown in Fig. 32 may be used. Two line wires are necessary; in line N are connected springs c, c, c normally closed, and between this wire and line M are connected springs o, o, o normally open. If the circuits are in good order, the alarm is set for the night by closing switch w and pushing the armature of the

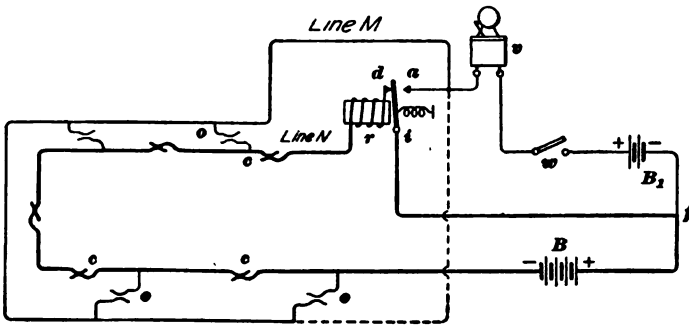

FIG. 32

relay r against the stop d , where it will be held by the current that flows from B through $f-i-d-r$ -line N . If the line N is opened at any spring c or broken at any point, r will release its armature and current from battery B_1 will ring the bell v until w is opened. If any spring o is closed, current flowing through $w-v$ -line M -any spring o -line N -battery B -battery B , will ring the bell. In this case, the two batteries are in series and must, therefore, be connected relatively as shown. The bell will also ring if lines M and N become crossed at any point. The dotted line is not necessary, but with it the system affords still better protection against tampering with the wires, for, if line M is broken anywhere,

either part into which it has thus been divided is still capable of sending in an alarm if crossed with line *N* at any point.

It is usual when connecting up burglar-alarm annunciators to group the windows or doors; i. e., the contacts on several doors or windows are connected in parallel and attached to one drop. To provide a drop for each door and window would require too large an annunciator and would cost too much for the ordinary run of work.

ELECTRIC GAS LIGHTING

BURNERS FOR PARALLEL SYSTEM

61. In the application of electricity to gas lighting, a spark is caused to pass between two conductors, placed near the burner, at the same time that the gas is turned on. In

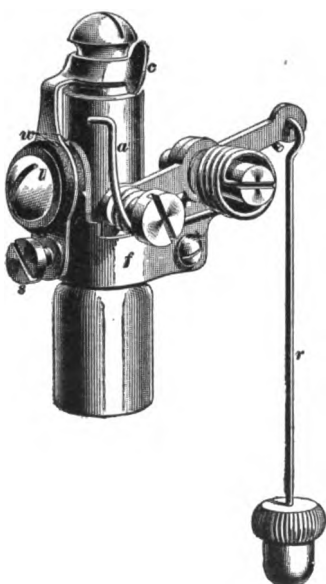

FIG. 33

the parallel system of lighting, each burner is independent of all the others, having direct connection between the battery wire and ground. Three styles of burner are used—the *pendant*, the *ratchet*, and the *automatic* burner.

62. The *pendant burner* is shown in Fig. 33. A well-insulated wire is brought to the burner and secured under the head of the screw *s*, thereby making connection to the stationary contact piece *c*, which is fastened by a screw *l* to frame *f* and insulated from it by washers *w*. On pulling pendant *r* downwards, spring *a* is drawn across *c*, and, on passing off at the upper side, the break causes a spark that, when the gas has been turned on, will ignite it.

63. The ratchet burner is very similar to the plain pendant, but is provided with a ratchet and pawl operated by a pendant, a downward pull turning on the gas at the same time that the spark is produced. A second pull extinguishes the gas.

64. The automatic burner is shown in Fig. 34 with the cover removed. Two wires must be provided, running from a double push button, one of them leading to the wire *a* and the other to *b*. The circuit from *a* is through the left-hand magnet coil *c* to the insulated band *d*, which has a projection *e* at one side. Upon this rests a metal rod *r*, bent at the upper end and terminating in a contact piece; at the lower end the rod is grounded by connection with the frame *f*. Each magnet coil has an armature *g* or *g'* with a projecting finger on the inner side. When current is sent through the magnet *c*, the armature *g* is raised and turns the gas valve *v* by striking one of the pins. At the same time the rod *r* is pushed

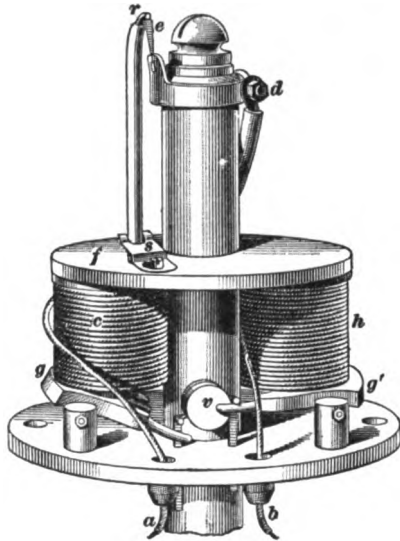

FIG. 34

up, thus breaking the circuit at a point where the gas is escaping and producing a spark that will ignite it. To provide for certain action, the sparking should continue longer than the instant of turning on the gas; this is effected by the use of a spring to restore the circuit. The rod is forced upwards against the spring *s*, but when the circuit is opened at the spark gap, the spring presses the rod and armature down again, and the circuit being thereby closed, a spark is again produced on opening. This continues as

long as the push button is pressed, the action being similar to that of an electric bell. The second coil k is grounded at the inner end, and when a current is sent through, the armature g' is raised, turning the valve and cutting off the supply of gas. Automatic burners are convenient where it is wished to light or extinguish a gas jet from some distant point, but they are not very safe because of their liability to leak gas. They are used principally in hallways where it is desired to light or extinguish the gas from any floor.

ARRANGEMENT OF LIGHTING APPARATUS

65. To light gas by electricity, a spark of considerable intensity must be produced. This can be done by means of batteries and induction coils or by an electrostatic discharger. For the parallel system used with the burners just described, a spark coil is employed to supply a good spark. Fig. 35 shows an ordinary spark coil which is made up of an iron core about $\frac{3}{4}$ inch in diameter and 8 inches long, built up out of soft-iron wire and wound with five or six layers of No. 18 magnet wire. The coil k is connected in



FIG. 35

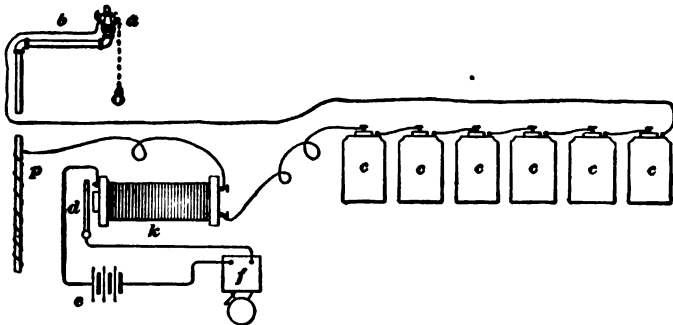

FIG. 36

series with the cells c , as indicated in Fig. 36. The battery should have at least six cells for satisfactory service. One end of the coil is connected to the gas pipe p . When the

pendant is pulled, the tip makes contact and a current is established through the circuit. When the circuit is broken, the self-induction of coil *k* causes a bright spark at the break. In case a ground occurred on the wiring, there would be a steady flow of current from the battery which would soon run it down. To give notice of such current leakage, the spark coil can be provided with an armature *d* that will be attracted by a steady flow of current in *k* and thus allow current from the local battery *e* to flow through bell *f*, giving a signal. The momentary current that flows in *k* whenever a burner is lighted would not usually flow long enough to

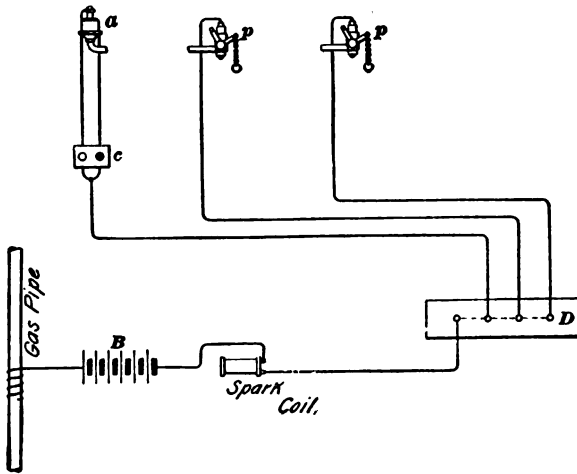

FIG. 37

attract *d*. In more expensive installations, separate wires are run for both sides of the circuit and the gas pipe is not used as one side.

66. The wires are usually run on the outside of the gas fixtures, but they may be concealed, if there is sufficient room, between the fixture shells and the gas pipe. It is advisable to use wire provided with good insulation, for grounds on the fixtures are liable to occur. Where fixtures are wired on the outside, the wires should be painted or made with the proper colored insulation, so as not to show;

but they must not be painted with bronze or metallic paint, which would penetrate the insulation and cause grounds, unless rubber-covered wire were used.

67. To make the location of grounds easy, it is advisable to run separate wires from a distributing point near the battery to each fixture or group of fixtures. The wires can be connected together at that point by means of a connecting board, at which any fixture can be disconnected. This makes the location and removal of grounds an easy matter. Fig. 37 shows the general arrangement of a system using both plain pendant and automatic burners. The distributing board is shown at *D*. The automatic burner is provided with a double push button *c*. When the dark button is pressed, the light is extinguished; when the light button is pushed, the gas is turned on and lighted.

The Underwriters' rules now prohibit the use of electric gas lighting on combination fixtures that are also equipped with electric light. There is too much danger of the gas-lighting wiring coming in contact with the electric-light wiring. Moreover, where there is electric light on a fixture there is little need for electric gas lighting because at best, the only excuse for electric gas lighting is that it makes gas nearly as convenient as electric light so far as turning the light on and off is concerned. Electric light has now replaced gas to such an extent in hotels, theaters, churches, and other public places, to say nothing of private houses, that electric gas lighting appliances are going out of use. These outfits are a continual source of annoyance, unless they are kept in good condition and they are specially liable to get out of order in private houses where they are not, as a rule, properly attended to.

APPARATUS FOR SERIES LIGHTING SYSTEM

68. The series, or flash, system of gas lighting is used in large halls, churches, theaters, etc., where many lights are installed in groups. A fixed spark gap is used at each burner, both of the points being insulated from each other and from the gas pipe, except the last point of a series, which is grounded. The style of burner used is shown in Fig. 38, in which *a* and *b* are the points of the spark gap. To complete the connection between consecutive burners, a fine bare copper wire, about No. 26 gauge, is stretched across, being secured through the small holes at the lower ends of the strips *a*, *b*. The body of the burner is made of some insulating substance, and a flange of mica *m* is added to give further protection. Since one circuit may consist of a number of burners, it will be seen that the E. M. F. must be very high to force a current across so much air space, and to insure success, the wiring must be installed with the greatest precaution. The wire should nowhere be nearer to the gas pipe than $1\frac{1}{4}$ inches; if, however, it is necessary to approach more closely, the wire

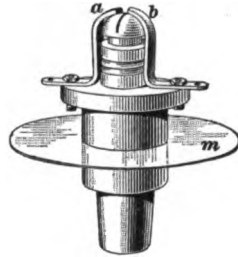

FIG. 38

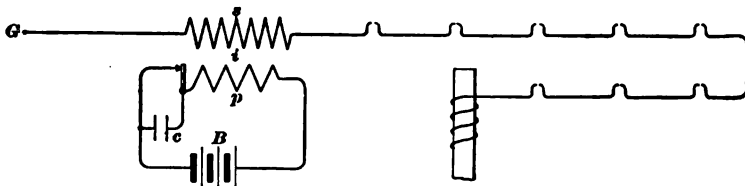

FIG. 39

should be enclosed in glass tubing. A coil giving a 1-inch spark can light a circuit of about 14 or 15 burners.

The apparatus required for this system of gas lighting consists of an induction coil *i*, Fig. 39, operated by a battery *B* and used with a condenser *c* across the spark gap of the primary *p*. The condenser cuts down the spark at the

circuit-breaker, for this spark would be very destructive in the case of a large coil. The fine-wire secondary *s* is grounded at *G*, and the other terminal is connected to the line wire passing to the burners.

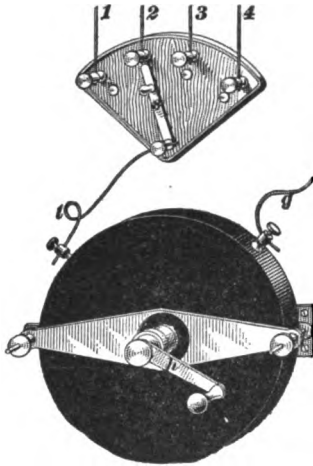

FIG. 40

the switch is moved from one contact to the next, lighting the gas on each circuit 1, 2, 3, 4 in rapid succession.

69. Frictional machines are also used in the series lighting system. These generate static electricity, and in many cases are more reliable than induction coils, as there is no battery to get out of order. One form of this machine is shown in Fig. 40. One of the terminals *l* is to be connected to the switch handle *s* and the other *g* to ground. The machine is rotated by means of the handle *h*, and

MODERN ELECTRIC-LIGHTING DEVICES

LUMINOUS EFFICIENCY

1. **Electric lamps** are devices for transforming electric energy into light. Most arc and incandescent lamps, however, radiate as light only a very small proportion of the energy supplied them; a large part of the energy is radiated as heat. Any source of light may be considered as giving out two kinds of radiation—luminous and obscure. The radiated energy sets up vibrations in the ether, and those vibrations which have a wave length lying between certain limits are capable of affecting the eye and producing the sensation known as light. All vibrations lying above or below these limits are useless so far as producing light is concerned. If A is called the total radiation from a light-giving source, B the amount of luminous radiation, and C the non-luminous, or obscure, radiation, then $A = B + C$, and the ratio $\frac{B}{A}$ is the **optical, or luminous, efficiency** of the light-giving source, because it is the ratio of the radiation that is useful in producing light to the total radiation. The efficiency of ordinary light-giving sources, as measured by this standard, is very low. For example, the luminous efficiency of ordinary incandescent lamps is only a fraction of 1 per cent. and that of the best arc lamps less than 10 per cent.

There is room for a great deal of improvement in the efficiency of light-giving sources, and efforts to effect such improvement have been made largely with a view to finding

Copyrighted by International Textbook Company. Entered at Stationers' Hall, London

an illuminant in which a higher temperature can be attained without injury to the material used. Generally, the higher the temperature of a light-giving source the higher is its luminous efficiency. All substances, however, do not have the same luminous efficiencies at equal temperatures; a lustrous, metallic surface radiates as light a larger proportion of its total radiated energy at a given luminous temperature than does a black surface, such as carbon, at the same temperature.

INCANDESCENT LAMPS

METALLIZED-FILAMENT LAMPS

2. The first incandescent lamps made were very crude indeed compared to those now in use. The principle on which the lamps operate—namely, the heating to incandescence of a body in a vacuum by passing an electric current through it—has not changed, but there have been many improvements in the processes of manufacture, especially in the method of producing the vacuum and in the methods of making the bodies, or filaments, to be heated. Better materials from which to make the filaments have been found, so that while the first lamps consumed a great deal of energy and gave off but little light, later ones have greatly reduced the energy consumption and increased the light output.

The ordinary carbon-filament incandescent lamps usually consume, when new, from 3.1 to 3.5 watts for each candle-power given off. If a larger current were forced through the filaments by increasing the pressure, the candlepower would increase much more than the consumption of energy; that is, the efficiency of the lamps would be increased. These lamps, however, are soon destroyed if run at too high temperature.

3. Preparation of Metallized Filaments.—Ordinary carbon filaments are made by squirting a solution of cellulose through a die and letting it fall in fine threads into wood alcohol, which hardens the cellulose. The fibers are then dried, shaped into the desired form for the lamp, placed in a

muffle, and heated to the highest temperature attainable with a gas flame. They are thereby carbonized and are then known as *base filaments*. After being prepared in this manner, they are hung in a chamber, from which the air is exhausted and a thin vapor of gasoline substituted, and are heated to incandescence by passing an electric current through them. A dense layer of carbon from the decomposing gasoline vapor forms on the filament. This process is called *treating*, or *flashing*, the filaments, after which they are ready for mounting in the lamps.

Although heating carbon filaments to a high temperature by passing a current through them injures or destroys them, it has been found that subjecting them to an excessively high temperature by the application of heat from an outside source causes them to undergo a change that greatly improves their characteristics for lamp filaments. In the new process, the filaments, in their basic form, are packed in a cylindrical carbon box, which is fed into the end of a carbon tube. To the ends of the tube are attached water-cooled copper clamps, by way of which a large electric current is sent through the tube after it has been buried in powdered carbon. The passage of the current through the resistance of the carbon tube raises the temperature inside the tube to between 3,000° and 3,700° C. The carbon tube as thus used is a form of *electric-resistance furnace*. After the filaments have been fired in this manner for a short time, they are cooled, treated in gasoline vapor, and again fired in the electric furnace. This process leaves the filaments covered with a shell of lustrous, steel-gray elastic carbon in an almost pure graphite form, and they are then ready for use in the lamps.

4. The ordinary carbon filament has a negative temperature coefficient; that is, its resistance decreases as its temperature increases, thus making it very sensitive to changes of voltage. Filaments that have been subjected to the intense heat of the electric furnace, as just described, have a positive temperature coefficient. The new filament also has a lower resistance than the older carbon filaments; in fact, when the

filaments are finally removed from the electric furnace their characteristics resemble more nearly those of metal than of carbon, hence the name **metallized filament**. The word *graphitized*, also sometimes used, more nearly describes the actual condition.

Metallized-filament incandescent lamps have the same general appearance as the ordinary incandescent lamp, except that they are made only in the larger sizes and some of the bulbs are tipless. The standard sizes consume 50, 100, 125, 187, and 250 watts, respectively, and give off approximately 1 candlepower for each 2.5 watts consumed. By the use of suitable reflectors the light can be thrown in any desired direction, so that the concentrated candlepower is much greater than 1 for each 2.5 watts.

5. Operation of Lamps.—The metallized filaments can be operated at a much higher temperature than the ordinary carbon filaments; they have also a more lustrous surface, offering better properties for radiating light. They can therefore be operated at a higher efficiency and can also be made to produce a whiter light, more nearly resembling sunlight. In spite of the higher efficiency, these lamps have a length of useful life about the same as that of the ordinary carbon-filament 3.1-watt lamp. Because of the lower resistance of the filament, lamps with metallized filaments are not at present made in as small units for standard voltages as are those having the ordinary carbon filaments.

6. The difference in the color of light given off by ordinary carbon filaments when burning under various conditions is approximately as follows:

COLOR OF LIGHT	WATTS PER CANDLEPOWER
Clear white	1.5
White, very faintly tinged with yellow	2 to 2.5
Yellowish white	3
Yellowish	3.5
Yellowish, tinged with orange	4
Orange yellow	4.5
Distinctly orange red	5

The clear white light, which most nearly resembles sunlight, is the most desirable; hence, the advantage of operating at high efficiency is twofold—increased economy and better light.

7. The objection to operating lamps with ordinary carbon filaments at a consumption per candlepower of less than from 3 to 3.5 watts may be seen from the following data of a 16-candlepower carbon-filament lamp. The figures in the first line are the watts per candlepower and those beneath, the corresponding useful life in hours. The less the consumption per candlepower the shorter the life.

2.0	2.5	3.0	3.5	4.0	4.5	5.0
28	132	412	1,000	2,005	3,570	6,125

8. The economy in using the higher efficiency metallized-filament lamps may be readily estimated. A 3.1-watt 16-candlepower carbon-filament lamp consumes in a useful life of 500 hours $3.1 \times 16 \times 500 = 24,800$ watt-hours, or 24.8 kilowatt-hours. A 2.5-watt 16-candlepower metallized-filament lamp consumes in the same time $2.5 \times 16 \times 500 = 20,000$ watt-hours, or 20 kilowatt-hours,—4.8 kilowatt-hours less than the carbon-filament lamp. At the prices usually charged for power for lighting purposes—from 10 to 15 cents per kilowatt-hour—from 50 to 75 cents is saved during the life of a lamp in the cost of power consumed for each 16 candlepower given off. However, the smallest metallized-filament lamp made consumes 50 watts and gives off 20 candlepower, so that instead of effecting a saving, the usual result of the improvement will be to obtain more light at practically the same cost as before.

METALLIC-FILAMENT LAMPS

9. In the effort to find a more efficient substitute for carbon for the filaments of incandescent lamps, much experimenting has been done with metals having a very high melting point. Certain rare metals, notably tantalum, osmium, and tungsten, have been found so well adapted for incandescent-lamp filaments that some surprising results

have been obtained. It is now possible to make metallic-filament lamps that can be operated at even higher efficiency than the graphitized-filament lamps, and that have a useful life fully equal to and in some cases exceeding that of the carbon lamps.

TANTALUM LAMPS

10. Tantalum.—The first metallic-filament lamp to come into commercial use was the **tantalum lamp**. Tantalum is a comparatively rare metal of which little was generally known until Doctor Von Bolton, a German investigator, found that it possesses very valuable characteristics for incandescent-lamp filaments. The metal is very heavy, having a specific gravity of 16.8; that is, a piece of tantalum is 16.8 times as heavy as an equal volume of water. As the specific gravity of lead is only 11.36, tantalum is nearly one and one-half times as heavy as lead. Tantalum is malleable and ductile; it can be hammered out into thin sheets, but being as hard as mild steel, the pounding must be severe; it can be rolled into very fine wire, which is stronger than steel. The melting point of tantalum is very high—nearly 2,300° C.—and, with the exception of hydrofluoric acid, no acid, even when boiling, will affect it. Tantalum also has very high electric resistance and expands but little when heated; its resistance increases as the metal is heated; that is, it has a positive temperature coefficient. However, the resistance of tantalum is lower than that of carbon; hence, tantalum lamp filaments are made longer than carbon filaments for the same voltage.

11. Supporting Tantalum Filaments.—The low resistance of the metal makes it necessary that tantalum filaments, in all except the very low voltage lamps, be very long. For example, the filament in a 22-candlepower 44-watt 110-volt tantalum lamp is 20 inches long and has a diameter of .0018 inch. In spite of the high specific gravity of tantalum and the great length of a lamp filament made of this metal, the extremely small diameter makes a

filament so light that it requires 20,000 of the 22-candlepower filaments to weigh 1 pound.

The length of the filament, together with the fact that it stretches when hot, makes its support in the bulb a somewhat difficult matter. The device generally adopted is shown in Fig. 1. A central glass rod bears two glass supporting rims, from which project laterally evenly spaced

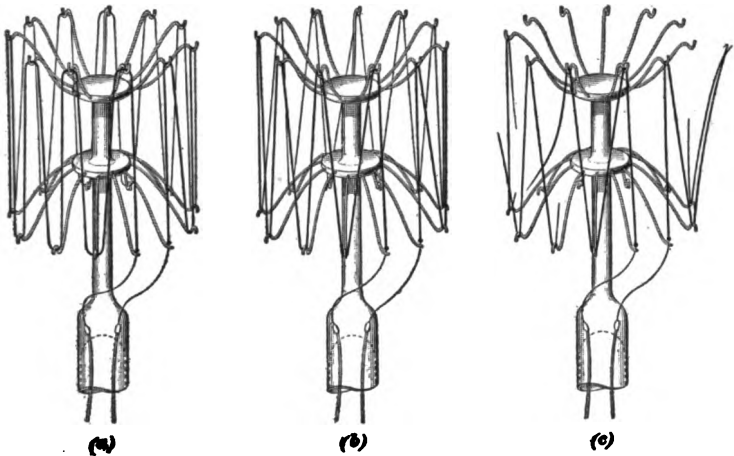

FIG. 1

arms made of nickel wire and having hooks at the ends over which the tantalum filament is wound. The ends of the filament are connected to the lamp socket by platinum leading-in wires. The upper support has eleven arms and the lower one twelve, each upper arm being in a vertical plane midway between the vertical planes of the two adjacent lower arms, so that the filament winds on in a zigzag fashion.

12. Characteristics of Tantalum Filaments.—The tantalum filament when new has a perfectly smooth cylindrical surface, but as it ages the surface presents a peculiar glistening appearance, which, under the microscope, appears rough and pitted. For the first few hours of service, the filament stretches and hangs loosely on its supports, but as it grows older it contracts until it is shorter than at first.

Fig. 1 (a) shows the appearance of a new filament, which is drawn in loose, easy curves over the hooks, while (b) shows the appearance of a filament after being in use for some time, the loops being drawn down to sharp-pointed angles. The filament finally breaks, but wherever the loose ends come in contact with some other portion of the filament they immediately weld fast and the lamp continues to burn, often with increased candlepower; the filament is shortened, owing to the cutting out of a portion of its length, and its resistance is thereby decreased, but, of course, this shortens the remaining life. Quite frequently, even after the filament has been broken several times, tantalum lamps continue to give good service for a time. Fig. 1 (c) shows the filament on one side of a lamp after it had broken three times and still continued to do good service. For the sake of clearness the filament connections on the back of the lamp are omitted.

While new tantalum wire is very strong, it loses much of its strength and becomes brittle after having served 200 or 300 hours as a lamp filament; hence, while new tantalum lamps may be handled as freely as carbon-filament lamps,

they should not be disturbed after having been in service a while. It also follows that they are not suitable for use where there is much vibration.

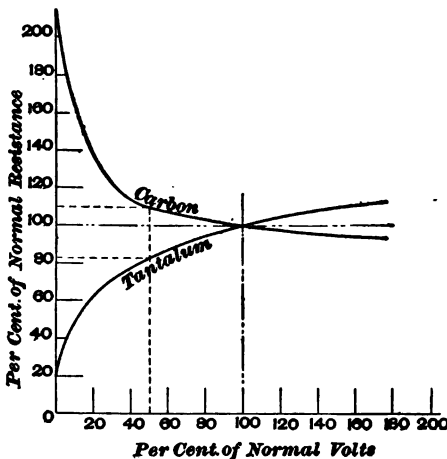

FIG. 2

13. The curves in Fig. 2 show the comparative resistance characteristics of carbon and tantalum filaments, assuming that the resistances are the same at 100 per cent. of normal

volts. When the voltage is zero, that is, when the filaments are cold, the resistance of the tantalum filament is only

20 per cent. of its value at normal voltage, while that of the carbon filament is about 225 per cent. As the volts are increased, thereby forcing a current through the filaments and heating them, the resistance of the tantalum filament increases, while that of the carbon filament decreases, as shown by the curves; for example, at 50 per cent. of normal voltage, the resistance of the tantalum filament is about 82 per cent. of normal, and that of the carbon filament about 108 per cent.

This resistance characteristic of the two filaments shows that a tantalum-filament lamp will take much the greater current at starting, that it will reach incandescence more quickly, and that it will be much less sensitive to slight variations of the supply voltage; for, as the volts increase, the resistance also increases, thus tending to keep the current through the filament more nearly constant.

14. Fig. 3 shows a complete 22-candlepower tantalum-filament lamp having a consumption of 44 watts, or 2 watts per candlepower, and an average life of about 700 hours. This lamp is now supplied by United States manufacturers for any voltage from 100 to 130. The bulb is very nearly the same size as that of the ordinary 16-candlepower carbon-filament lamp.

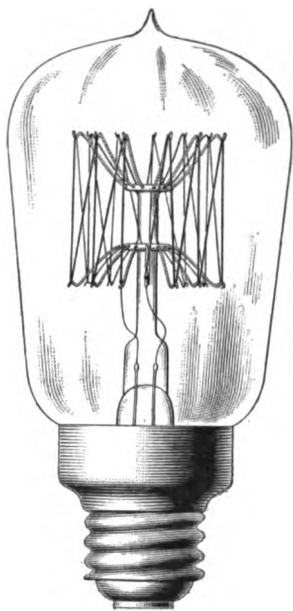

FIG. 3

15. Fig. 4 shows the results of comparative tests of several tantalum lamps and one carbon-filament lamp. Curves *a* and *b* show the increase of specific consumption with age; the values of the ordinates, in watts per candlepower, are given on the right-hand margin. The tantalum lamps consumed an average of 1.85 watts per candlepower

at the start, 2.2 watts at the end of 700 hours, and 2.6 watts at the end of 1,200 hours. The corresponding figures for the carbon-filament lamp were 3.3, 3.7, and 3.9 watts per candlepower.

Curves *c* and *d* show the decrease of candlepower with increasing age; the values of the ordinates are given on the left-hand margin. The tantalum lamps gave off about

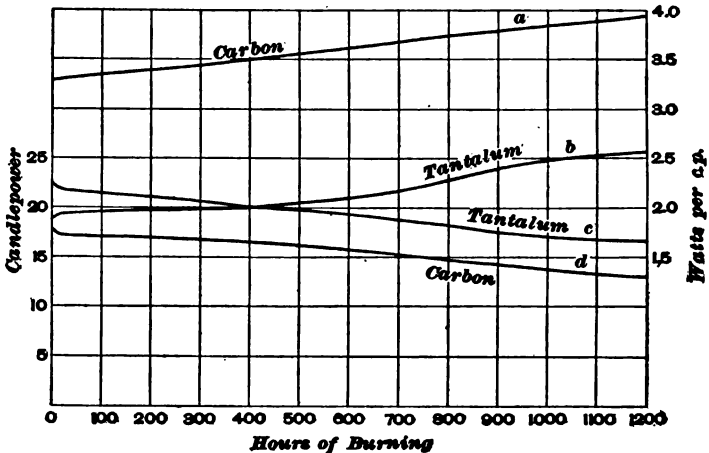

FIG. 4

22 candlepower at the start, dropped 20 per cent., or to 17.6 candlepower, in about 850 hours, and were still giving an average of nearly 17 candlepower at the end of 1,200 hours. The carbon lamp began with about 17 candlepower, burned over 900 hours before losing 20 per cent., and was giving about 13 candlepower at the end of 1,200 hours. This carbon lamp was evidently an exceptionally good one.

OSMIUM LAMPS

16. Lamps with filaments made of the very rare metal osmium are used to some extent in European countries, and if the claims made for them are substantiated in practice and their cost is not excessive, they will probably come into quite general use. The lamp was invented by Doctor Welsbach, of Vienna, the originator of the Welsbach gas mantle.

17. Preparation of Osmium Filaments.—Osmium has a specific gravity of 22.48, about twice that of lead; it also has a very high melting point, in fact it is almost infusible. This metal is malleable and ductile and possesses high electric resistance. Osmium lamp filaments, however, are not produced by drawing the pure metal into fine wire as is done with tantalum filaments. One process is to mix finely divided osmium into a thick paste and then, under heavy pressure, force this paste through dies, shaping the threads thus formed into loops and heating them in a vacuum. The threads then

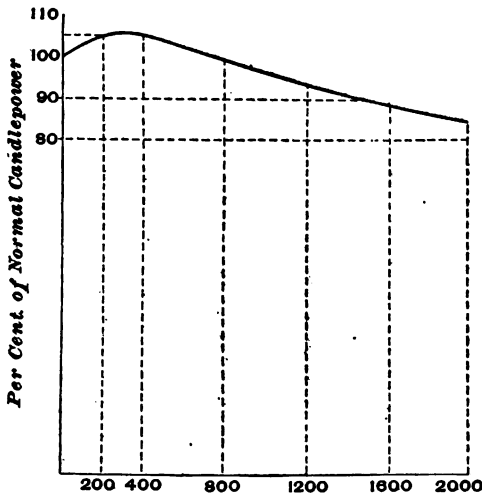

FIG. 5

consist of porous, rough osmium with a considerable percentage of carbon. To burn out the carbon, the filaments are next placed in an atmosphere containing steam and other gases and heated by passing an electric current through them. This is called *forming them*, and after this process they consist of pure porous osmium, in which condition they are mounted in the lamps.

18. Operation of Osmium Lamps.—After the lamps are put in service, the surface of the porous filaments becomes gradually more and more smooth, resulting in an increase of light during the first 200 or 300 hours. Fig. 5 shows the

variation of candlepower, with life, of a 44-volt 32-candlepower osmium lamp. Beginning at 100 per cent. (32 candlepower), the light increases until at the end of 250 hours it is about 105 per cent. (33.6 candlepower). From this point the candlepower gradually decreases, but at the end of 2,000 hours it has dropped only to about 85 per cent. of its original value.

It is not certain that all osmium lamps will have as long life as the one whose life curve is shown in Fig. 5, although the claim is made that with an initial consumption of 1.5 watts per candlepower some of the lamps burn even 5,000 hours without losing more than 20 per cent. of their original candlepower. Of twelve lamps tested in Vienna, the average life was 2,220 hours, the shortest being 1,793 and the longest 3,036 hours, respectively, and during this test only three of the lamps lost more than 10 per cent. of their original candlepower. The average consumption during life was from 1.8 to 2 watts per candlepower. The British General Electric Company guarantees their osmium lamps for a life of not less than 500 hours with a consumption of 1.5 watts per candlepower.

19. Osmium lamp filaments when incandescent become quite flexible, and if the lamp is in a horizontal or an inclined position, the filaments, unless well supported, tend to droop, or sag, under their own weight. Moreover, the filaments are somewhat more fragile than carbon filaments and are more likely to become damaged in transportation. They are made in long U-shaped loops, which are so anchored to a glass rod projecting into the bulb from the base that the lamps can be burned in any position. The filaments do not, however, become so brittle with use as the tantalum filaments, and are more suitable for use where there is vibration. In fact, osmium lamps have given satisfactory service in car lighting.

Osmium has a positive temperature coefficient; hence, osmium lamps are not sensitive to slight variations of voltage. In fact, they will stand a considerable increase above their normal voltage without serious injury. Osmium lamp filaments also weld together when broken, similar to tantalum filaments.

TUNGSTEN LAMPS

20. **Tungsten**, sometimes called *wolfram*, is one of the so-called rare metals, though it occurs more plentifully than either tantalum or osmium. Tungsten is steel gray in color, so hard that it will scratch glass, and very heavy (specific gravity 19.129). Like carbon, tungsten changes directly into vapor at a very high temperature (considerably higher than the corresponding temperature for carbon) without passing through a liquid state. Its specific resistance is lower than that of carbon; hence, tungsten lamp filaments must be very long and very thin, as is the case with all metallic filaments.

21. **Tungsten lamps** were first produced in Europe by German and Austrian inventors. The filaments are made by two or three methods and, in some types of lamps, consist of an alloy of osmium and tungsten. On account of the difficulty of properly supporting a long, slender filament, the lamps are not made in small sizes or for high voltages. The appearance of the tungsten lamp first placed on the American market is shown in Fig. 6. This lamp was invented by Dr. Alexander Just and Franz Hanaman, and is called the Just tungsten lamp; it is standardized at 40 hefner candlepower with a consumption of 40 watts at 100 to 120 volts, and has a useful life of 1,000 hours.

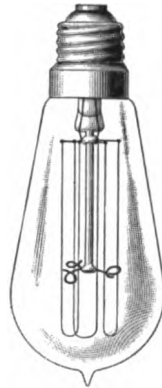

FIG. 6

22. **Operation of Tungsten Lamps.**—Well-authenticated tests made in public laboratories in Germany and Austria indicate that the performance of tungsten lamps, when compared with that of carbon-filament lamps, is remarkable. A useful life of from 1,500 to 2,000 hours at less than 1 watt per candlepower is indicated. Lamps working at .75 watt per candlepower have been run from 1,000 to 1,100 hours with a loss of only 3.5 per cent. of their light output, and for 1,600 hours with a loss of 20 per cent.

The curves in Fig. 7 shows the results of official tests

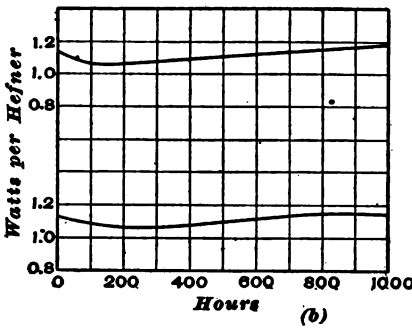
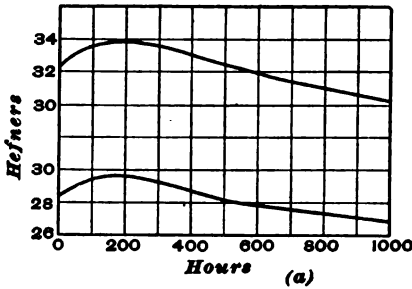

FIG. 7

made on the *osram lamp*, which has a filament consisting of an alloy of osmium and tungsten. The curves in (a) show the change of total candlepower of two lamps of about 28 and 32 hefner units, respectively, and those in (b) show the change in watts per hefner. The light output increases in each case during the first 200 hours, and the consumption per hefner decreases; the output then falls off gradually, but has fallen only 5 or 6 per cent. below the initial candlepower at the end of 1,000 hours. The specific consumption has

meanwhile risen to a little less than 1.2 watts per unit.

23. Tungsten lamps work equally well on either direct or alternating current and are not sensitive to changes of voltage; in fact, the voltage can be doubled without injuring the lamps. Some types of tungsten lamps can be used in any position and are not affected by vibration, unless it is very excessive. Table I shows the effect of gradually raising the voltage on a 17-candlepower 20-volt tungsten lamp. At the end of the test the lamp seemed uninjured.

The light from these lamps is exceedingly white and pleasant, but the lamps are so very brilliant that frosted bulbs or some form of shades are necessary. Owing to the greater abundance of tungsten as compared with other rare metals used for lamp filaments, and also because of their high

economy and long life, tungsten lamps are likely to come into more extensive use than the other metallic-filament lamps.

TABLE I
TUNGSTEN LAMP TESTS

Volts	Amperes	Candlepower	Watts per Candlepower
20.2	.970	17.1	1.138
25.8	1.140	56.9	.670
32.7	1.300	88	.484
34.5	1.340	110	.421
39.0	1.440	158	.355
40.6	1.475	185	.322

24. Normal Filament Temperatures.—Table II gives the approximate true temperatures of some incandescent lamps as determined by the United States Bureau of Standards, Washington, D. C.

TABLE II
NORMAL BURNING TEMPERATURES

Type of Lamp	Watts per Candlepower	Volts	Approximate True Temperature Degrees C.
Carbon	4	50	1,800
Carbon	3.5	118	1,850
Carbon	3.1	118	1,950
Tantalum . . .	2	110	2,000
Tungsten . . .	1	100	2,300

THE NERNST LAMP

25. In the incandescent lamps thus far considered the glowing body, or filament, is enclosed in a vacuum, because

in open air it would be oxidized, or burnt up, by the oxygen in the air. The Nernst lamp is properly called an incandescent lamp, because the light-giving portion is a solid body heated to incandescence by the passage of electric current. This lamp is the result of researches made by Dr. Walter Nernst, a German scientist. The distinguishing features of the lamp are its filament, or glower, the means for making the glower conductive, and the fact that the glower operates in the open air.

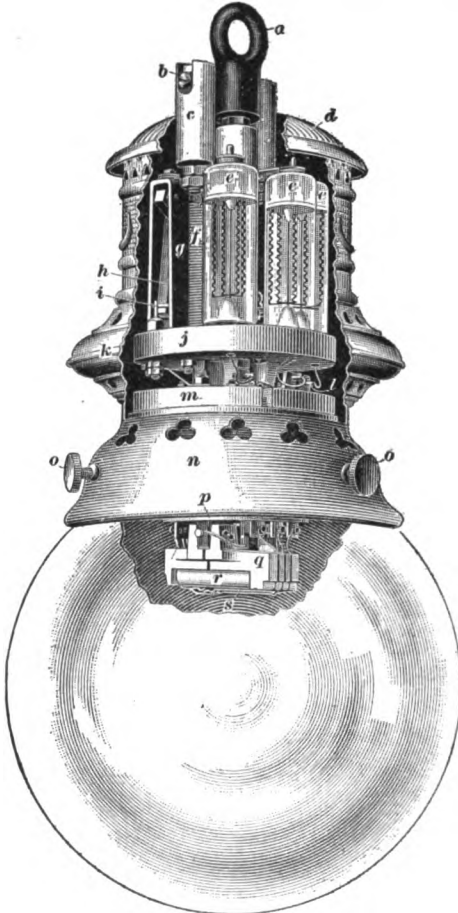

FIG. 8

(1) the *glower*, or light-giving portion; (2) the *heaters*, which raise the temperature of the glowers at starting until they become conductors; (3) the resistance, or *ballast*, as it is

termed by the manufacturers, which steadies the current through the lamp; and (4) the *cut-out device* for opening the circuit through the heaters after the lamp has been started. All these parts are compactly assembled and enclosed in a case having a suspension hook, or screw base, and an enclosing globe attached. Fig. 8 is a view of a medium-sized Nernst lamp, partly in section, showing the location of each part, as follows:

- | | |
|--|--|
| <i>a</i> , the suspension eye; | <i>k</i> , the lamp case, or housing; |
| <i>b</i> , a lamp terminal; | <i>l</i> , an aluminum plug; |
| <i>c</i> , the terminal porcelain; | <i>m</i> , the porcelain contact sleeve; |
| <i>d</i> , the iron cap covering the lamp; | <i>n</i> , the lamp petticoat; |
| <i>e</i> , ballast tubes; | <i>o</i> , globe-holding screws; |
| <i>f</i> , the cut-out coil; | <i>p</i> , the holder base; |
| <i>g</i> , an armature support; | <i>q</i> , the holder; |
| <i>h</i> , an armature; | <i>r</i> , a heater tube; |
| <i>i</i> , a silver contact stop; | <i>s</i> , a glower. |
| <i>j</i> , the ballast porcelain; | |

27. Nernst Glowlers.—The glowers, or light-giving portion of the Nernst lamp, are made by pressing through suitable dies a dough composed of an oxide of some of the rare metals, such as thorium, zirconium, yttrium, etc. The porcelain-like strings issuing from the dies are dried, cut into suitable lengths, and baked. Terminals are then attached by soldering wires to beads of platinum embedded in the ends of the glower. Embedding the platinum beads in

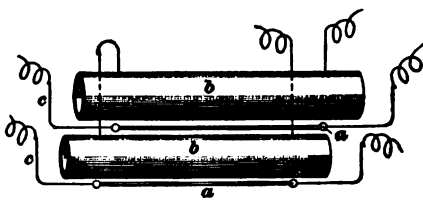

FIG. 9

the ends of the glower is found to be preferable to wrapping platinum wire around the ends, because as the glowers shrink in service the beads are gripped tightly, while the wire wrappings become loosened. The process of making the glowers was the most troublesome feature in developing

the lamp, and finding a suitable method of attaching the terminals was especially difficult.

Fig. 9 shows a pair of glowers *a* and their accompanying heater tubes *b*. Platinum terminal wires *c* are attached to the glowers, and to the ends of these wires are fastened short copper wires. The copper wires terminate in small, tapered aluminum plugs (not shown in this figure) suitable for insertion in receptacles on the porcelain base on which the heater tubes and glowers are mounted.

28. The glowers have an extremely high resistance when cold, or at ordinary temperatures, that is, they are insulators; but when warmed, the resistance decreases as the temperature rises until the glowers become good conductors at about 600° or 700° C. The curve in Fig. 10 shows the relation that exists between the temperature of a Nernst

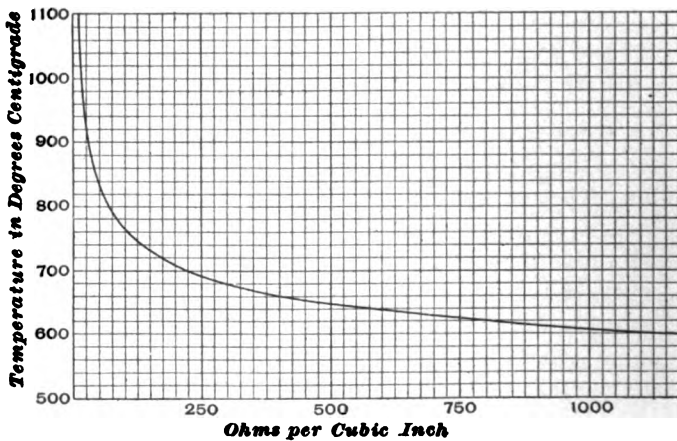

FIG. 10

glower and its specific resistance. At 600° C., the specific resistance is about 1,200 ohms per cubic inch, while at lower temperatures it is much greater. As the temperature rises above 600° C., the specific resistance lessens very rapidly, being about 225 ohms at 700° C. and decreasing to about 30 ohms at 900° C.

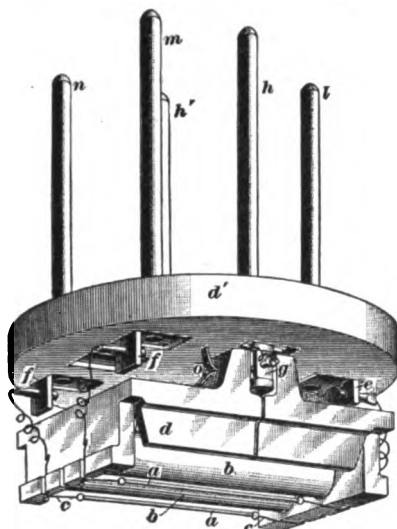

FIG. 11

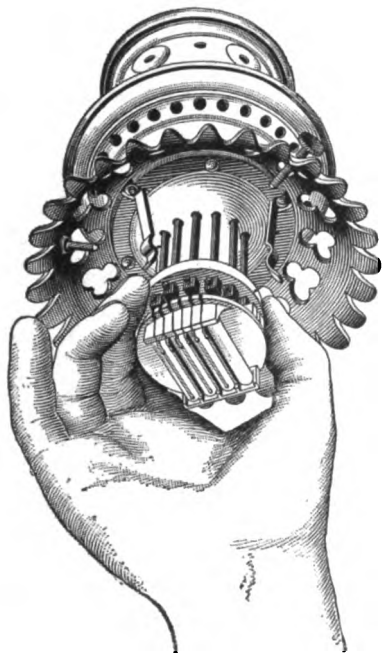

FIG. 12

46B-34

29. Nernst Heaters. Various devices have been tried for raising the temperature of the glowers to the point where they become conductors. In the United States, the plan now followed is to wind fine platinum wire over thin porcelain tubes, and then cover the wire with a cement paste that will withstand the intense heat of the glowers when in operation and that also affords a white surface to reflect the light downwards.

Fig. 11 shows the glowers *a* and the heaters *b* of a two-glow lamp mounted in their porcelain holder *d*, which is attached to the porcelain base *d'*. The glowers, located just beneath the heater tubes, are connected to the brass pieces *e, f* attached to the base. The terminals of the heater coils are connected by way of the brass pieces *g* (one on each side of the base) to the prongs *h, h'*. Prongs *l, m, and n* are connected with brass pieces *e, f*, thereby forming the terminals of the glowers. The holder is

secured to the base by cotter pins *a*, which are inserted through the brass pieces *g*. The portion of the holder facing the glowers is painted with a white enamel paste so that it will reflect light.

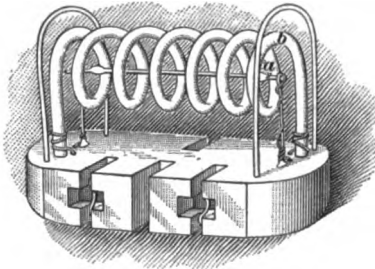

FIG. 13

Fig. 12 shows the method of inserting a holder, with its heaters and glowers, in a lamp. A six-glower unit with a suitable number of prongs is shown. The prongs enter receptacles with which they make the necessary connections.

The hand should not be allowed to touch the glowers or heater tubes.

30. The smallest Nernst lamp, which is made to compete with the ordinary incandescent lamp and is fitted with a base for screwing into a standard Edison socket, has one glower surrounded by a helical-formed heater made of the same materials as the heater tubes for the larger lamps. Fig. 13 shows the appearance of the glower *a* and the heater *b* mounted on a porcelain holder, and Fig. 14 shows a complete lamp. This lamp gives about the same light as three ordinary 16-candlepower carbon-filament lamps.



FIG. 14

31. Ballast for the Nernst Lamp.—The rapid decrease of the resistance of the glowers with increasing temperature would render the lamps very unstable were it not for the ballast. If the glowers were connected directly across the circuit, they might be adjusted to work all right with a perfectly steady pressure; but any slight increase of

pressure would increase the current through the glowers and thus increase their temperature. The resulting decrease of resistance would permit still greater current to flow, and the process would continue until the glowers became practically a short circuit across the line.

The ballast consists of pure iron wire mounted in glass tubes (*e*, Fig. 8) from which the air is exhausted, the space then being filled with an inert gas, such as nitrogen. The resistance of iron wire rises very rapidly as the temperature of the wire increases. An increase of 10 per cent. in the current passing through one of these ballasts will cause as much as 150 per cent. increase in resistance. A small amount of resistance is therefore sufficient to insure stable operation, and the efficiency of the lamp as a whole is higher than if an ordinary resistance were used. By mounting the wire as described, all danger from oxidation, or burning of the wire, is removed, and the ballasts will last a long time, provided the voltage regulation is good.

32. Nernst Cut-Out.—The cut-out consists of an electromagnet connected in series with the glowers and arranged so that when current passes through them it will attract two armatures, one of which is shown at *h*, Fig. 8, and open the circuit through the heater coils.

33. Connections for Nernst Lamp.—Fig. 15 (*a*) shows a diagram of the connections of a two-glower lamp, and (*b*) shows the same connections in a simplified form. When current is first turned on to the lamp, it passes alternately from the terminals *F*, *G* through the armatures *C*, *C*, silver contact points *D*, *D*, prongs *h*, *h'*, Fig. 15 (*a*), to the heater coils *b*, *b*. As soon as the temperature of the glowers has risen enough to make them conducting, current also passes from the lamp terminals to the glowers *a*, *a* by way of prong *l* on one side, and the magnet *B*, ballast tubes *A*, *A*, and prongs *m*, *n* on the other side. When the current through the magnet has become large enough, the armatures *C*, *C* are drawn in by the magnetic attraction to the dotted positions, thus opening the circuit through the heaters at two points *D*, *D*.

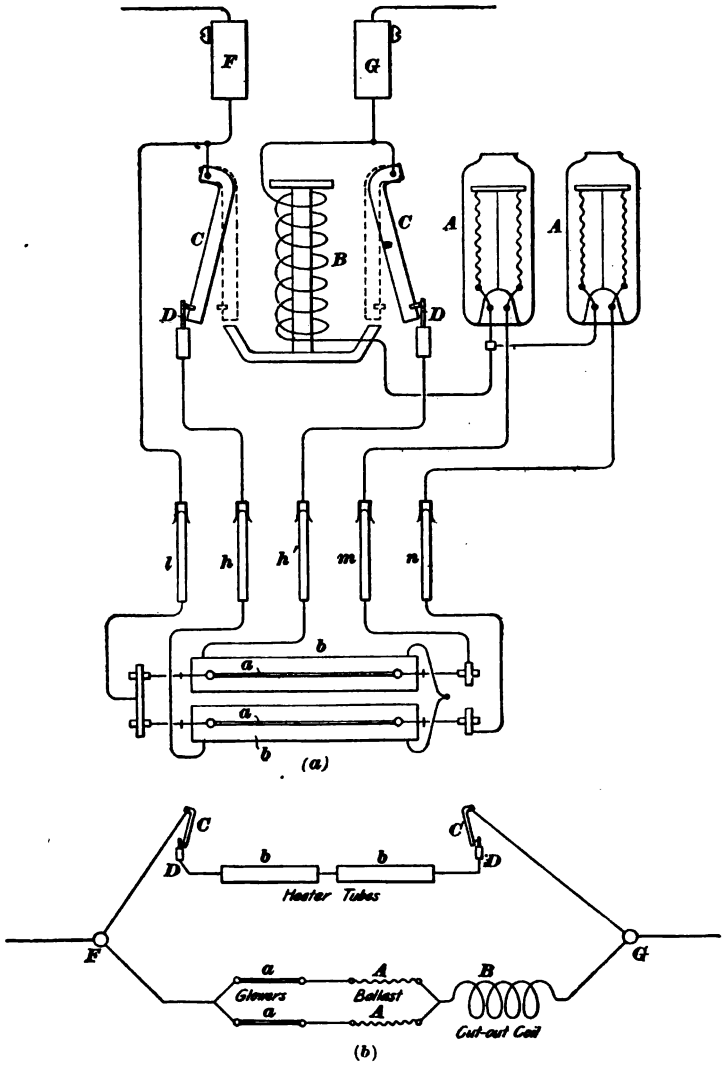

FIG. 1b

The armatures are suspended loosely from a single point, so that they swing outwards against the contact points when the magnet is not excited; the single loose suspension also prevents humming, which would otherwise be caused by the alternating current in the coil. The temperature inside the lamp when operating is about 110° C., and to protect the wire of the cut-out coil from the heat, it is covered with cement.

34. Characteristics of the Nernst Lamp.—In Fig. 16 is shown a curve that illustrates graphically the flow of

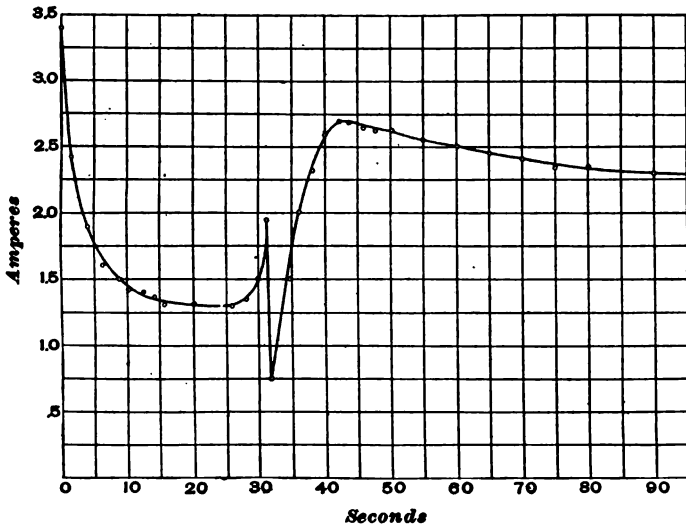

FIG. 16

current through a six-glower 220-volt lamp from the time it is switched on until the lamp is running steady on its normal current—about 2.3 amperes. When first switched on, nearly 3.5 amperes flows through the heater tubes. The resistance of the platinum wire on the heaters quickly rises and brings the current down to about 1.3 amperes, which continues until at the end of 26 seconds the glowers begin to take current. The total current then gradually rises until, after a little over 30 seconds, the current in the glowers reaches a value high enough to cut out the heaters, when the total current

through the lamp decreases abruptly by the amount that the heaters were taking. The current through the glowers continues to increase, until at the end of about 40 seconds all the glowers are burning full brilliancy and the resistance of the ballast has risen enough to prevent further rise of current. From this time on there is a slight rise in the resistance of the ballasts, lamp connections, etc., until the whole lamp has reached its maximum temperature and the current has fallen to its normal value.

35. Nernst lamps are made with one, two, three, four, or six glowers, giving hemispherical candlepowers of very nearly 35, 75, 125, 190, and 300, respectively. The efficiencies of the lamps steadily increase with the number of glowers, the approximate consumption of energy in the various sizes in the order named being, respectively, 2.4, 2.2, 2.1, 1.85, and 1.75 watts per hemispherical candlepower. This increase in efficiency is due largely to the fact that the several glowers tend to heat one another.

The high efficiency of the Nernst lamp may be ascribed to the high temperature at which the glowers work, and to their ability to radiate a large proportion of the energy supplied them as light. The color of the light approximates closely to that of daylight, and hence is desirable for store or art-gallery illumination, where the correct determination of color is of importance. As an offset to these advantages, the Nernst lamp, in comparison with the incandescent lamp, is somewhat complicated, and high in first cost, although the parts to be renewed can be replaced at slight cost after the lamp is once purchased, because allowance is made for the scrap platinum in the burned-out parts. The slowness of starting is also a disadvantage for some kinds of illumination, particularly in theaters, or in any other place where it is desired to switch lamps on and off frequently.

36. The lamps are made for 110 or 220 volts alternating current; the 110-volt lamps can be adjusted for any voltage from 100 to 120, and the 220-volt lamps for any voltage from 220 to 240. For best results the voltage must not be

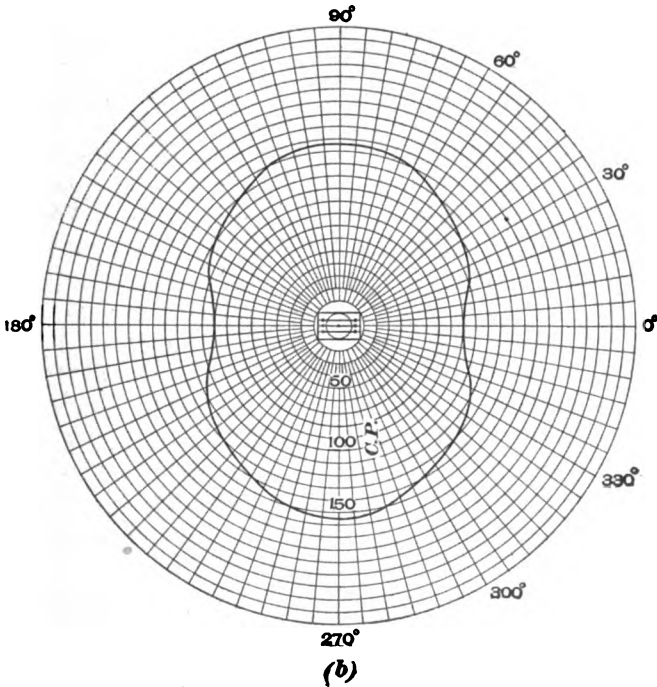
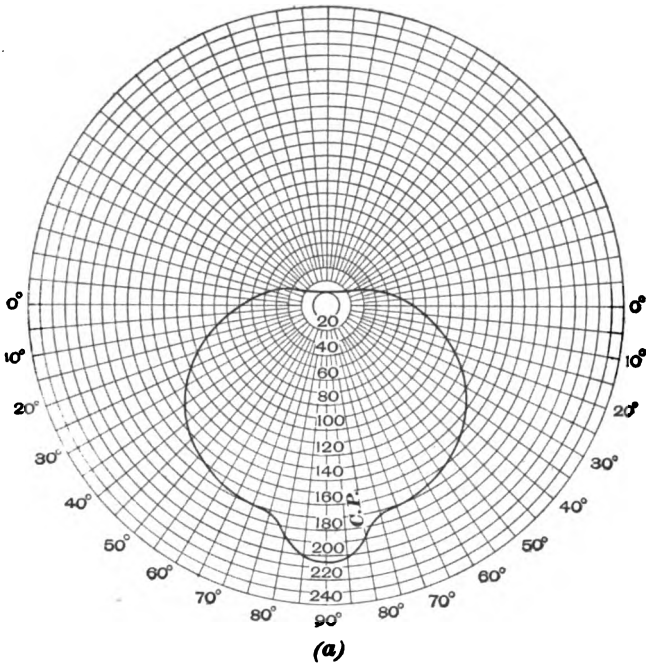

FIG. 17

permitted to vary more than 3 per cent. above or below that for which the lamp is adjusted. Each 110-volt glower takes approximately .8 ampere, and each 220-volt glower, approximately .4 ampere. More satisfactory service is obtained from the 220-volt lamps. A single-glower lamp for outdoor service on series-circuits is also made. This lamp is made both for 26 volts 6.6 amperes and for 23 volts 7.5 amperes. All sizes, except the low-voltage series-lamp, are made in two styles, for either indoor or outdoor service, the difference being almost entirely in the style of casing used to enclose the lamp.

37. Light Distribution.—Owing to the reflecting surfaces just above the glowers, nearly all the light from a Nernst lamp is given off in the lower hemisphere. The light is very evenly distributed below the lamp in the vertical plane, as shown by the heavy curved line in Fig. 17 (*a*), where the candlepower given off in various directions by a three-glower lamp is indicated by the numbers in the vertical column. There is a slight excess of light immediately below the lamp. Fig. 17 (*b*) shows the horizontal distribution about a three-glower lamp; the light given off parallel to the glowers is much less than that given off perpendicular to them.

38. Care of Nernst Lamps.—Nernst lamps should have regular and systematic attention while in operation. There should be kept on hand a supply of parts likely to be needed, such as glowers, heaters, holders, ballast, glass-ware, etc., the number of extra parts depending on the number of lamps in use. The attendant should have a suitable kit of tools, and regular, systematic visits should be made to each lamp. He should carry with him a supply of parts most likely to be needed, including a number of repaired holders, complete with heaters and glowers, and should inspect each lamp as follows:

1. Determine whether all heater tubes become red when the current is turned on; if not, the holder should be replaced with a new one. After the lamp has been in use some time, the holder and heater tubes become blackened by a deposit

of oxide of platinum from the glower terminals. This deposit should be scraped off or a new holder substituted, so as to keep the reflecting surface good.

2. Inspect lighted lamps with colored glass to determine condition of glowers.

3. Change holders in a six-glower lamp if two glowers are out; in a four-, three-, or two-glower lamp if one glower is out; and in a one-glower lamp if the glower does not light.

4. After replacing the holder, see that all glowers light up; if any does not, the corresponding ballast is burnt out and must be renewed.

5. All defective holders should be returned to the repair bench. The shades and glassware should be cleaned as often as necessary—at least once a month.

TUBE LIGHTING

39. For two centuries or more it has been known that an electric discharge through a tube of rarefied gas, or vapor, causes the gas to become luminous. Within recent years, much experimenting has been done, with a view of developing a practical illuminant by using a tube of incandescent gas. It has been found that the luminous efficiency of a vacuum tube is 25 or 30 per cent.—many times better than the best arc or incandescent lamps. The prediction is freely made that further investigation will enable the production of a vacuum-tube light far more efficient than anything yet produced.

When light is radiated from a point, the intensity of the light striking an object at a distance from the source of light varies inversely as the square of the distance; hence, in order that objects at a considerable distance may be well illuminated, the source of light must be dazzlingly bright. When the source of light is extended over a considerable space, as in a tube of light, the law of inverse squares does not hold true; the light falling on an object at a distance from the source is greater than given by this law. Moreover, from such a distributed source, light is given off in all directions

perpendicular to a considerable length of tube, and sharply defined lights and shadows are avoided. This quality adapts tube lighting to rooms where there are many obstructions to the distribution of light from concentrated sources, as in rooms where much machinery is installed.

Two principal types of tube lights have thus far come into practical use: the *mercury-vapor lamp* in which a column of mercury vapor is heated to incandescence by the passage of a current of electricity through it, and the *Moore electric light* in which the incandescent body is a tube of rarefied gas consisting almost wholly of air. Far less heat is required to raise to incandescence the temperature of a column of rarefied vapor or air than a solid, such as used in incandescent and arc lamps; this accounts for the higher efficiency of the vacuum-tube lamp.

MERCURY-VAPOR LAMPS

40. The **mercury-vapor tube lamp** as used in the United States was invented and developed by Peter Cooper Hewitt; hence, it is commonly known as the **Cooper Hewitt lamp**. The standard types of this lamp consist essentially of a clear glass tube 1 inch in diameter, with a light-giving portion from $17\frac{1}{2}$ to 45 inches long. In each end of the tube is sealed a platinum wire that terminates in an iron or mercury electrode, very similar to the electrodes of the Cooper Hewitt mercury-vapor converter; in fact, the idea of using the mercury arc to convert alternating current to direct current was conceived while experimenting with mercury-vapor lamps.

DESCRIPTION

41. Type H Lamp.—Mercury-vapor lamps are made in three standard sizes, each designated by a type letter; namely, *types H* and *K* for direct current, and *type C* for alternating current.

Fig. 18 shows a **type H lamp** complete with the canopy containing the adjusting and regulating devices; *a* is the holder without the reflector, which is normally supported

between the holder and the lamp tube *b*. The holder is hinged at its middle point *c*, and is provided with a suitable stop, so that when in operation the lamp remains in an inclined position. The anode *d* is a piece of iron, and the cathode is mercury contained in the blackened bulb *e*. The chain *f* serves to pull down, or tilt, the lamp when starting it.

Two type H lamps in series, with tubes $17\frac{1}{2}$ inches long, are used on circuits where the voltage is from 98 to 106, and

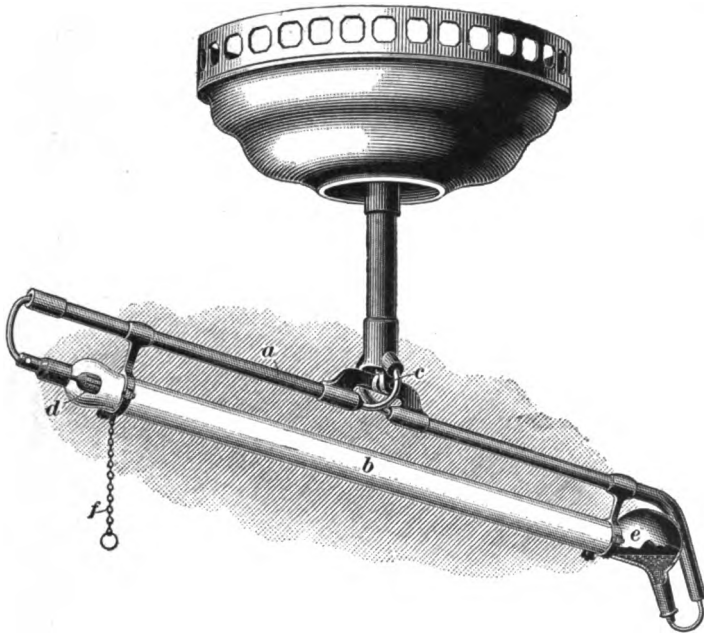

FIG. 18

two $20\frac{1}{2}$ -inch tubes are used on from 106- to 122-volt circuits. At 110 volts, the two lamps consume 3.5 amperes, or 385 watts, and give off 300 spherical candlepower each, or a total of 600 candlepower, thus making the specific consumption .64 watt per candlepower. A lamp of this kind, with a special resistance in series, can be used on from 98- to 122-volt circuits, and four lamps can be used in series on from 196- to 244-volt circuits.

42. Type K Lamp.—The type K lamp has the same general appearance as the type H, but the light-giving portion of the tube is 45 inches long. Type K lamp can be used singly on from 98- to 122-volt circuits, or two in series where the voltage is from 196 to 244. With one of the two lamps shunted by a special resistance, the other can be used on from 196- to 244-volt circuits. Each lamp consumes 385 watts ($3\frac{1}{2}$ amperes at 110 volts) and gives off 700 candlepower, making the specific consumption .55 watt per candlepower.

43. Type C Lamp.—Fig. 19 shows a type C lamp for use with single-phase alternating current only. The general appearance is very similar to that of the type H or type K

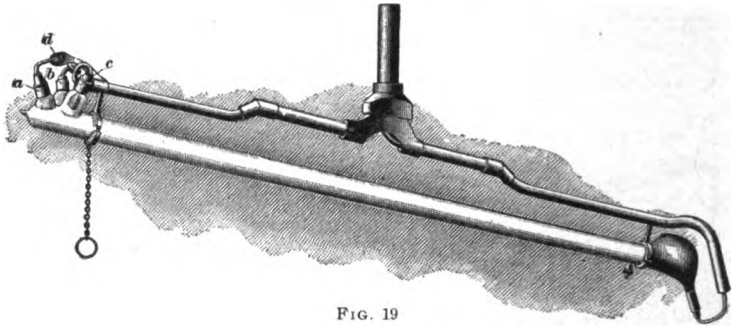

FIG. 19

lamp, except that the type C lamp combines the features of the direct-current lamps and the mercury-vapor converter, and hence has three anodes, one *a* for starting and two *b* and *c* for operating the lamp. The complete lamp has a canopy not shown in the figure. A resistance *d* in series with the anode *a* prevents the flow of an excessive starting current. The length of the light-giving portion of the tube is 28 inches. With each lamp is supplied an autotransformer, making the lamp suitable for use singly on from 98- to 244-volt circuits. The lamp consumes $3\frac{1}{2}$ amperes on 110 volts and has a power factor of $71\frac{1}{2}$ per cent., making the actual consumption $3\frac{1}{2} \times 110 \times .715 = 275$ watts. The output is 425 spherical candlepower; hence, the specific consumption is .64 watt per candlepower.

44. **Cooper Hewitt Lamp Reflectors.**—Fig. 20 shows the different forms of reflectors used with mercury-vapor lamps. The flat type is supplied where a medium distribution of light is desired; the curved type is used for concen-

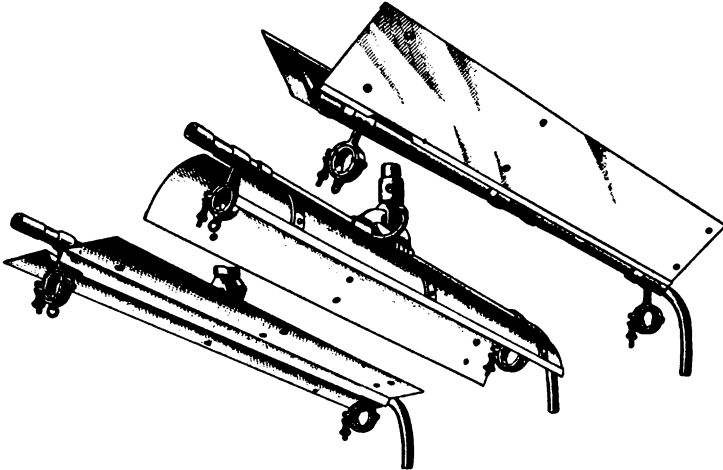

FIG. 20

trating most of the light immediately under the lamp; and the adjustable type permits almost any desired distribution to be obtained. With light-colored walls and ceiling, best results are obtained without the use of reflectors.

—→

CONNECTIONS

45. Fig. 21 shows a diagram of the connections of two type H lamps in series, on a 110-volt circuit. A ballast *a*, very much like that used in the Nernst lamps, tends to keep the current nearly constant through considerable variations of the voltage. A resistance *b* in series with both lamps helps to steady the current and prevents it from being excessive at starting. Inductance, or reactance, coils *c*, *c'*, also in series with the lamps, prevent sudden fluctuations of current and act as magnets to hold the automatic switches *d d'* open while both lamps are in operation. If one lamp is out of

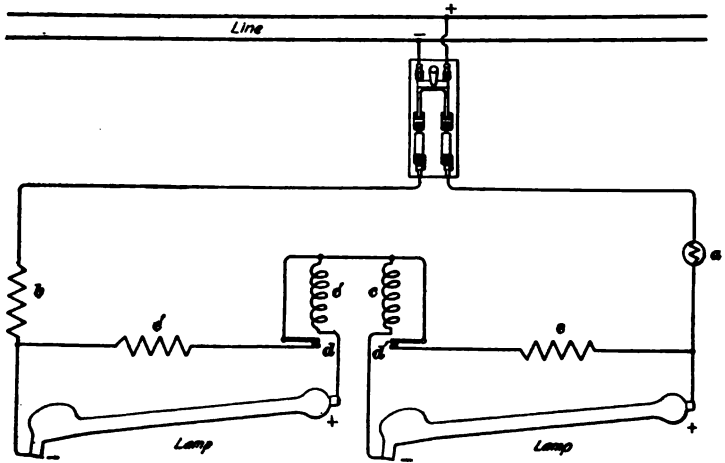

FIG. 21

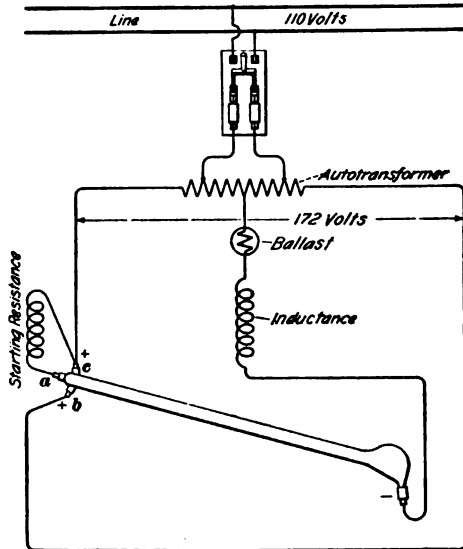

FIG. 22

service for any reason, its inductance coil carries no current and its automatic switch remains closed, thus allowing the current from the other lamp to pass around the idle one through a special shunt resistance e or e' . It is thus possible to burn either lamp singly if desired. Two pair of type H lamps in series, each pair connected as shown in Fig. 21, can be used across from 196 to 244 volts. The connections for two type K lamps in series are very nearly the same as for two type H lamps. When one lamp of either type is connected for use alone, the automatic switch is omitted, but a resistance and an inductance are used in series with the lamp.

46. Fig. 22 shows a diagram of the connections of a type C lamp. The connections are the same as those of the single-phase mercury-vapor converter, except that in the lamp connections a ballast is used in the line from the cathode to the autotransformer. The autotransformer shown is suitable for use on 110 volts; a different one is used for 220 volts, the transformation ratio being such that the pressure across the lamp terminals is 172 volts in each case.

47. The adjusting and regulating devices for each lamp are arranged in a compact group called the **auxiliary**, which is usually placed in the large canopy above the lamp. Fig. 23 shows the inner parts of the type C lamp, the arrangement of which is typical of all. A plate a is fastened to the ceiling, a shield b of sheet iron and asbestos comes next, and the plate c to which the resistances, inductances, etc. of the auxiliary are attached is then fastened to the ceiling plate. The asbestos shield protects the ceiling from heat that might be generated in the auxiliary. The plate c carries a cross-foot d , into which the suspension bar e is screwed. The parts are shown suspended in the order in which they go together. When assembled, the canopy covers all the parts, as shown in Fig. 18. The position of the lamp is indicated in Fig. 23 by dotted lines, and the holder, reflector, clamps, etc. are shown.

When the ceiling is fireproof, the plate is attached to it by means of expansion bolts or other suitable devices; when the ceiling plate is attached to an outlet box, an insulating joint is used. The auxiliary can be screwed direct to wooden

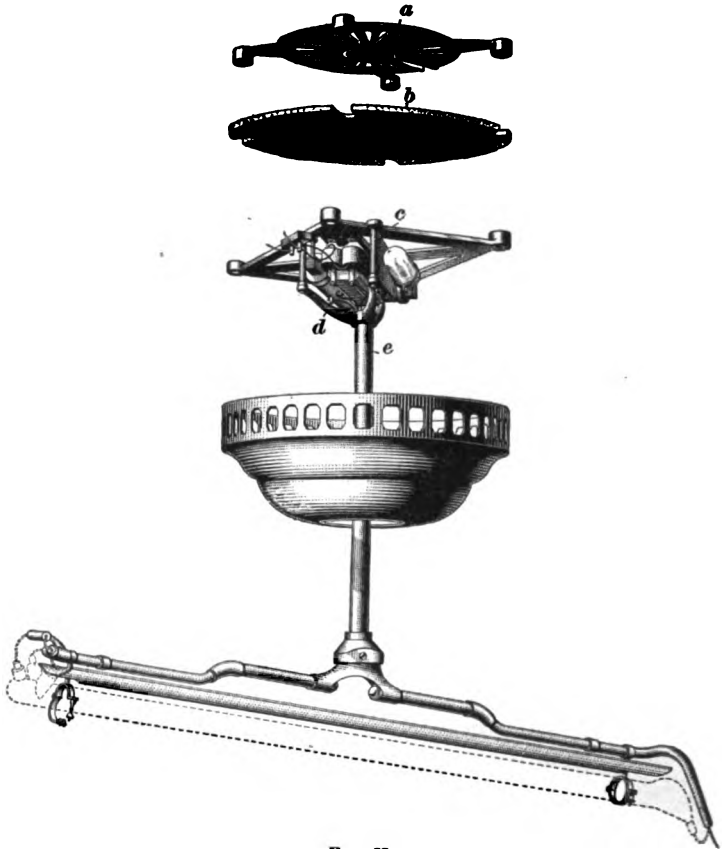

FIG. 23

ceilings without the use of a plate, but it must be spaced $\frac{1}{4}$ inch from the ceiling by porcelain insulators, and the asbestos shield must not be omitted.

48. In Fig. 24 is shown a diagram illustrating the relative location of the various parts of two type H lamps. The

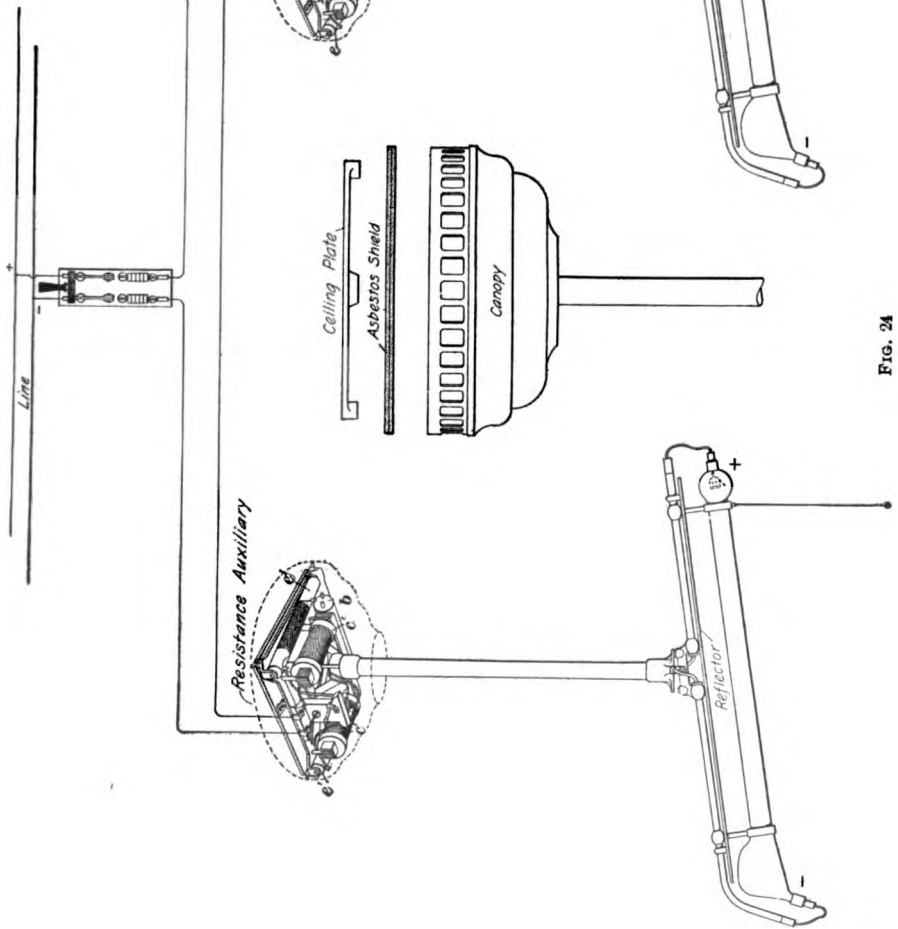

FIG. 24

auxiliary of one lamp contains the ballast a , and that of the other lamp contains the series-resistance b (see also Fig. 21); hence the names, ballast auxiliary and resistance auxiliary. Each auxiliary is provided with inductances c, c' and shunt resistances e, e' , each in two parts; also a canopy, shield, and plate like the ones shown.

In assembling a pair of lamps, the canopy is first slid down over the suspension bar, which is then screwed tightly into its auxiliary. The two wires protruding from the top of the suspension bar are provided with terminal plugs, which fit into holes in the binding posts to which they should be connected, the posts being marked $+$ and $-$. In all cases, the wire from the positive end of the lamp should be connected to the positive post, and the wire from the negative end to the negative post. A wire connection is made between the posts marked B on the ballast auxiliary and the post marked R on the resistance auxiliary, and the wires from the supply circuit are connected to the remaining posts, the positive to the ballast auxiliary and the negative to the resistance auxiliary.

The clamps holding the tubes should be left loose enough so that the tubes can be turned easily; also, the tubes should remain tilted, as shown in Figs. 18 to 24, so that the mercury will remain in the cathodes. It may be necessary in some cases to add a small weight to the cathode end to keep it in the lower position.

OPERATION

49. Before starting mercury-vapor lamps, it should be ascertained that all connections have been properly made. The polarity of the direct-current lamps should be verified with considerable care, as an attempt to start with the current flowing in the wrong direction will melt the end of the negative leading-in wire, break the glass, and thus ruin the lamp. In starting, close the main switch, pull down on the chain until all the mercury has run from the cathode to the anode end of the tube; and then allow the tube to fall back slowly to its normal position. When the mercury forms

a continuous stream between the electrodes, about double the normal running current flows through the lamp, and when the stream is broken, the tube at once becomes filled with a glow of light.

In some types of lamps, a magnet is so arranged that when the main switch is closed the lamp is automatically tilted. In all cases, the lamp, after being tilted, should promptly return to the normal position with the cathode end down; it should not be permitted to burn long in any other position. The overload at starting will injure the lamp if maintained long; that is, if the tube is held for some time in a horizontal position.

COMPARISON WITH OTHER LIGHT SOURCES

50. The principal advantages claimed for the Cooper Hewitt mercury-vapor lamp are its high operating economy, uniform distribution of light, and the ease of the light to work by. The chief disadvantage is the absence of red rays, which gives the light a ghastly greenish appearance and renders it useless where colors must be distinguished. In such light, red appears as dark purple, and any color of which red is an element is distorted.

In economy, the mercury-vapor lamps are much superior to any of the older forms of electric lights, as may be seen by comparing the energy consumption per candlepower of the mercury lamp with that of the incandescent and arc lamps, as already given. Less than 1 per cent. of the energy supplied to carbon-filament incandescent lamps is converted into light, all the remainder being converted into heat. Of the energy supplied to mercury-vapor lamps, about 20 per cent. becomes light and 80 per cent. heat. The mercury-vapor lamps are therefore comparatively cool and heat up the surrounding air much less than either incandescent or arc lamps giving the same light output.

51. The superior distribution obtainable with tube lighting is illustrated, in the case of the mercury-vapor lamps, by the lighting of presses in some of the large printing

establishments. To light such machinery with ordinary incandescent lamps requires the installation of many lamps inside the presses. For example, it was estimated that forty incandescent lamps would be required to illuminate each of four large presses in one office, and that it would be necessary to drill 450 holes in the framework of each press to install the necessary conduits. In addition to these lamps, ten enclosed-arc lamps would have been needed to give the room sufficient general illumination. Instead of adopting this scheme of lighting, twenty-six type H mercury-vapor lamps were installed; the presses are thoroughly well lighted and no holes in the frames were necessary. The incandescent and arc lamps would have required about 15 kilowatts of energy; the mercury lamps require about 5.5 kilowatts.

52. The light from the mercury-vapor lamp is easy on the eyes for several reasons: it is very steady, there being no flicker or perceptible variation whatever; the source is not so dazzling as to cause the pupils of the eyes to contract and thus shut out the reflected light from the objects it is desired to see, such as printed pages, drawings, machinery, boxes or bales of goods, or whatever it may be; the prevailing color of the light is green, which is best suited to the eyes, while the trying red rays are entirely absent; and as the source is distributed, there are few sharp contrasts between lights and shadows to tire the eyes in making continuous adjustments.

For factories, warehouses, depots, offices, drafting rooms, press rooms, reading rooms, and all places where color distortion is not objectionable, this form of light is very desirable. Many attempts have been made to use a substance for the cathode that will give off all the colors in about the proportion that they exist in sunlight, but nothing so desirable as mercury has yet been found.

MOORE LIGHTING TUBES

53. The Moore electric light is a system of artificial lighting in which the source of light is the rarefied, non-metallic, gaseous contents of long glass tubes, made luminous by the passage of an electric current. The Moore tube can be made in many sizes and shapes, but usually it consists of a clear glass tube $1\frac{1}{4}$ inches in diameter and whatever length is desired up to 200 feet. The tube is usually placed near the ceiling, the two ends entering a small steel terminal box placed in any convenient location.

54. Theory of the Moore Light.—To explain the theory of the Moore lamp, reference is made to Fig. 25, which shows the appearance of a series of discharges of electricity in air at atmospheric pressure. If the difference of potential between two points or terminals in open air is gradually raised, sparks will finally jump from the positive terminal across the intervening air space to the negative terminal, as shown. The path of the discharge will not be

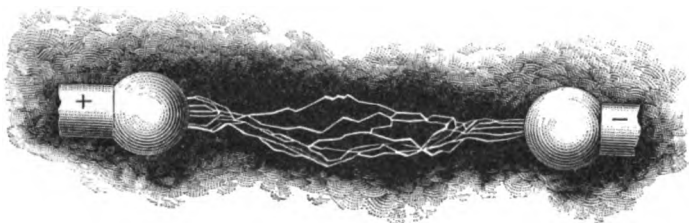

FIG. 25

a straight line, for the electricity will seek the path of least resistance, which includes particles of dust that may be floating in the air. The same tendency is seen when a lightning discharge passes in a zigzag path from cloud to cloud or from a cloud to the earth.

If the two terminals are sealed in a glass tube and the air is gradually exhausted from the tube, a condition will soon be reached where the discharges, instead of following zigzag paths, as in open air, will become straight and continuous and will fill the tube with a glow of light. The electromotive

force required to cause the discharge changes as the degree of exhaustion, or the pressure, of the air in the tube changes. At first the necessary electromotive force decreases rapidly as the pressure decreases, but a condition is soon reached where the electromotive force is a minimum, and the tube is completely filled with a bright glow. If the air pressure is further reduced, the electromotive force will have to be increased and the light will be less brilliant. For best results as a light source, therefore, the vacuum in the tube must be maintained at a definite pressure.

The color of the light emitted when the tube contains

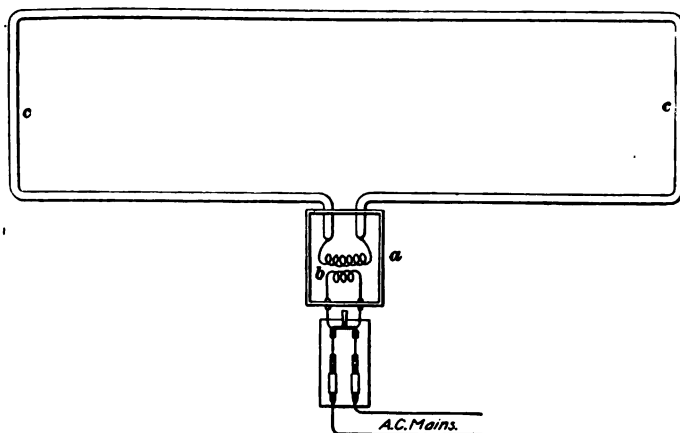

FIG. 26

only rarefied air is a rosy pink, but by introducing a small quantity of a suitable gas, the color can be made any shade desired; the light, in fact, can be made pure white. The coloring gas soon becomes exhausted and must be frequently renewed.

55. Moore Tube Connections.—Fig. 26 shows the very simple connections of a Moore tube. The pressures required are usually higher than are practicable with direct current. Low-potential alternating current, such as is permitted by the Fire Underwriters' rules to be brought inside buildings for incandescent lighting, is led through fuses

and a switch into a fireproof and danger-proof box *a* and through the primary coil of a potential-raising transformer *b*. The secondary coil of the transformer terminates in carbon electrodes in the ends of the tube *cc*, inside the box. No wiring is necessary, except to bring the low-potential mains to the box, thus making the system very safe. Fig. 27 illustrates an interior view of one of these terminal boxes, which has been in successful commercial use for several years.

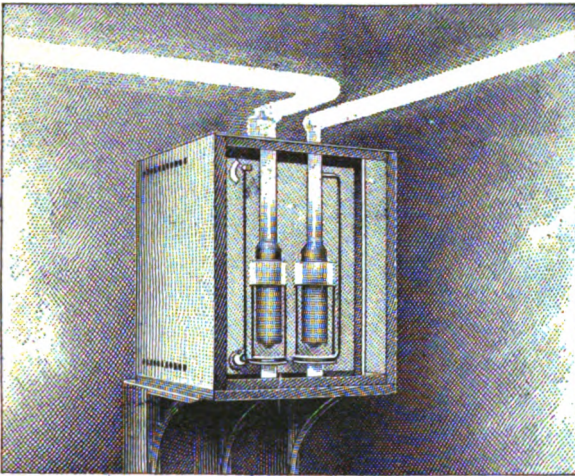

FIG. 27

When the main low-potential switch is closed, the tube lights up immediately with a glow that can easily be regulated, so that it will give any desired intensity from 2 to 25 or 30 candlepower per linear foot of tubing. The actual current passing through the tube, assuming that it is radiating 15 candlepower per foot, is about $\frac{1}{4}$ ampere, varying somewhat with the color of the light desired.

56. Vacuum Regulator.—The passage of electric current through the tube in a Moore light soon burns out the small quantity of air or other gas needed to maintain the conductivity, and it is necessary to admit a minute quantity to the tube at intervals, or the current will soon cease to flow.

The **vacuum regulator**, shown in section in Fig. 28, is a device for automatically feeding air to the tube. The vacuum is maintained at a little above the point of least resistance; therefore, as the degree of exhaustion increases, the resistance decreases and the current increases.

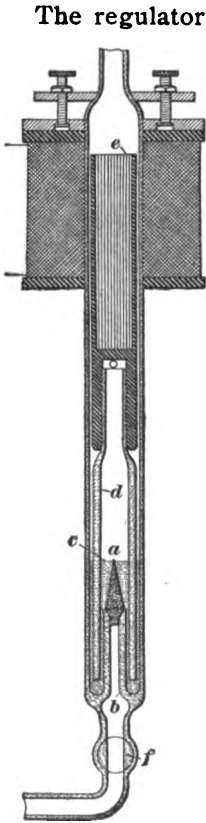

FIG. 28

The regulator consists of a valve operated by an electromagnet connected in series with the primary or the secondary of the transformer feeding the tube. A porous carbon plug *a* is sealed into the top of a glass tube *b*, around which is an annular space filled with mercury *c*. Into the annular space extends a movable tube *d*, the other end of which is attached to the core *e* of the magnet. As the excitation of the magnet changes, the core moves up or down, thus moving tube *d* up or down in the mercury. The surface of the mercury is thus lowered or raised.

Above the surface of the mercury is a space filled with air or other gas, and when the tip of the carbon plug is exposed an extremely small quantity of the gas filters through the plug and passes into the lighting tube. By means of a stop-cock *f*, the regulator can be shut off from the lighting tube. If the tube is fed with pure air, the light will be a rosy pink; if the air supply is first passed through phosphorus, the oxygen is withdrawn, leaving only nitrogen to enter the tube, and the light will then be yellow, which is the most economical color; or, the tube can be fed with carbon-dioxide gas, generated by the contact of a piece of marble with a little hydrochloric acid, in which case the light will be pure white.

In operation, the valve acts about once a minute; the current gradually rises until the valve acts, then gradually falls, as the newly admitted gas diffuses through the tube, until

the degree of exhaustion begins to increase again, thus working between fixed limits. No variation in the brilliancy of the tube can be detected, and in spite of the continual



FIG. 29

admission of new material, no change can be noticed except a deposit near the electrodes, and this is very slight, even after long-continued use.

57. Applications of the Moore Tubes.—Fig. 29 shows the Moore tube light in the main-corridor entrance to Madison Square Garden, New York City. This tube is 100 feet long and is arranged in the form of a rectangle hung near the ceiling.

In Fig. 30 is shown an artificial skylight for photographic purposes, made by bending a Moore tube back and forth over the surface of a window-like box. This skylight is located in one of the large New York City photograph galleries, and after 2,500 hours' service, extending over

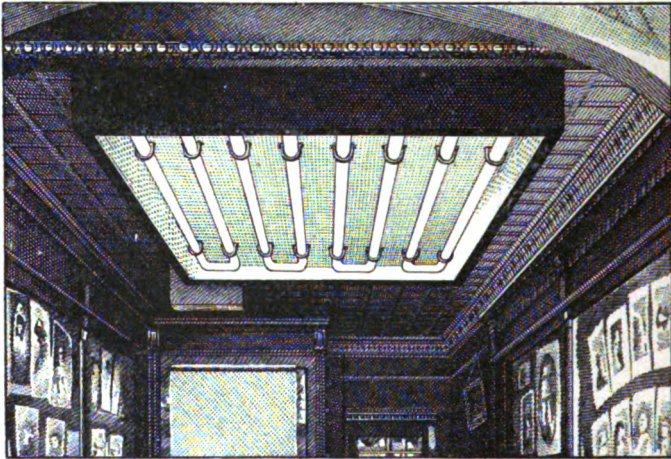

FIG. 30

1½ years, it showed no change in its conditions or its light output, and indicates indefinite life. A modified form of this device, in which the box carrying the tube is mounted in a frame so that it can be adjusted to any angle, is used by many photographers as an artificial photographic window.

Fig. 31 illustrates an adaptation of a Moore tube to electric advertising, to which it readily lends itself, as it can be bent into any form desired. This form of light is also applicable to large areas where uniform light is desired, such as stores, offices, restaurants, public halls, churches, theaters, libraries, art galleries, subways, and even to street lighting.

The longer tubes, such as shown in Fig. 29, are sent out from the factory in sections 8 feet 6 inches long, and are united into one continuous air-tight tube, being exhausted when mounted in their permanent location. This makes the system somewhat troublesome to install, but the expense is less than that of a first-class system of incandescent lighting, including wiring, fixtures, and shades.



FIG. 31

58. Characteristics of Moore Tubes.—Moore lighting tubes require alternating current at any of the frequencies ordinarily used for incandescent lighting. If the supply current is direct, a motor-generator, dynamotor, or rotary converter must be used to transform it into alternating current. Direct current, however, could be used in the tube, provided sufficient voltage could be obtained. The voltage required depends on the length of the tube and on the brilliancy at which it is operating. Curve *a*, Fig. 32, shows the volts at the tube terminals when operating at 12 hefners per foot. A tube 100 feet long requires about 7,150 volts, or 71.5 volts per foot; a tube 150 feet long, about 9,750 volts, or 65 volts per foot; and a tube 200 feet long, 12,250 volts, or 61.3 volts per foot.

Curve *b*, Fig. 32, shows the low tension, or primary, amperes at 220 volts for different lengths of tube operating at 12 hefners per foot, and curve *c* shows the total energy in kilowatts. Since the supply voltage remains constant and the energy supply increases with the length of tube, the primary amperes must increase.

59. The brilliancy of the tube in the Moore light increases slightly during the first 100 hours of service, and after that remains fairly constant with constant voltage. The

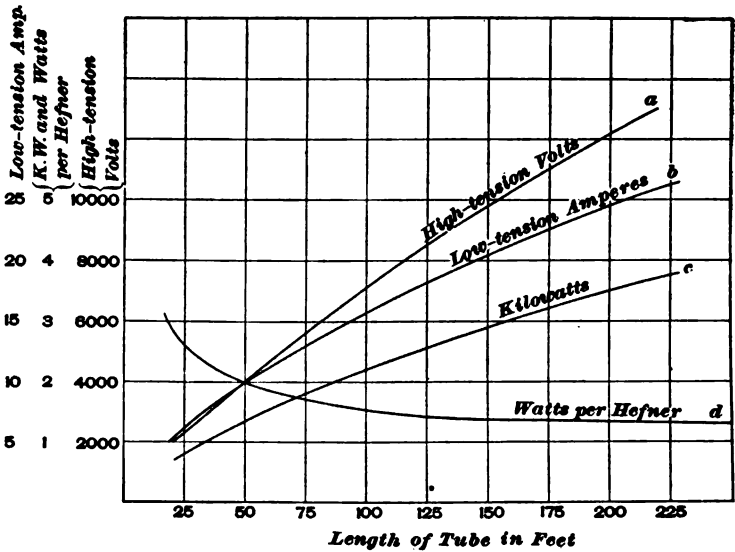

FIG. 32

light output increases about in direct proportion to the increase in voltage, and the tube is not injured by a considerable variation of voltage. The greatest brilliancy at which the tube can be made to burn (about 30 candlepower per linear foot) is not great enough to strain the eyes when looking directly at it.

The efficiency of the tube also increases during the first 100 hours of service, but afterwards there is no apparent change during the life of the lamp, provided the voltage remains constant. Increased voltage causes not only increased

brilliancy, but also increased efficiency. The efficiency of long tubes is greater than that of short ones. Curve *d*, Fig. 32, shows the relation existing between the length of a tube and its consumption of power at 12 hefners per foot. A tube 50 feet long consumes about 2 watts per hefner unit; a tube 100 feet long, 1.6 watts per unit; a tube 150 feet long, 1.35 watts per unit; etc. Recent tests made on a 179-foot tube that had been in use 1,000 hours showed a power consumption of 1.35 watts per hefner, at a brilliancy of 13 hefners per foot of tube. This tube was giving an orange-tinted light; when producing white light, the efficiency is lower. The power consumptions here given include that of the transforming device.

Among the objections to the Moore tube are the fact that it can be used efficiently only in large units and its low power factor—60 to 75 per cent. In many installations, the first objection is not serious, since the demand for large units, especially those having a distributed light source, is greater than that for small ones; the second may, perhaps, be largely removed with further developments.

FLAMING-ARC LAMPS

60. Up to 1894, the only arc lamps used in the United States were of the open-arc type. During the succeeding 10 years enclosed-arc lamps came into general use and gradually, with the exception of a few isolated cases, displaced open-arc lamps. Many varieties of enclosed-arc lamps are in use, most of them differing from one another only in mechanical details. There are differences in the methods of making up magnet coils and resistances, of insulating the electric circuits, adjusting and regulating the arc, enclosing the arc, etc., but the general principles on which nearly all enclosed-arc lamps operate are practically the same.

The chief reason for displacing the old-style open-arc lamps was the superior steadiness and quality of the light furnished by the enclosed-arc lamps, though the decreased cost of repairs and maintenance of the newer lamps was an

important consideration, especially in countries where labor costs are high.

61. Theory of Flaming-Arc Lamps.—All attempts to operate the old-style open-arc lamps with an arc longer than about $\frac{1}{8}$ inch resulted in a waste of energy. The additional power required to force the current through the longer arc was expended in a stream of hot gases, with but little increased light and greatly increased flaring and unsteadiness. The idea of inserting in the stream of hot gas a substance that would be heated to incandescence, and that would at the same time so increase the conductivity of the gas that the arc would remain steady, is an old one, but only within recent years has it been made practicable.

It has been found that if the carbons are impregnated with suitable mineral salts, the heat of the arc will vaporize the salts and heat the vapor to incandescence. The electrodes can then be drawn farther apart, producing a luminous arc from $\frac{3}{8}$ to $2\frac{1}{2}$ inches long. The color of the light from such an arc can be controlled to a considerable extent by the selection of the salts with which the carbons are impregnated. The salts most commonly used are those of calcium and magnesium. Lamps using such carbons and producing such arcs are usually called **flaming-arc lamps**; a more nearly correct designation, also sometimes used, is **luminous-arc lamps**.

When the carbons burn, the salts are converted into vapor which not only becomes incandescent, thus making the arc a brilliant flame of light, but also affords a path of comparatively low resistance between the electrodes, so that the arc is much more steady than with pure carbons. The burning is accompanied by the production of noxious fumes, a considerable quantity of ashes, and particles of slag, or scoria. The fumes render such arcs somewhat objectionable for indoor use, except in the small sizes, and also prevent enclosing the arc. The ashes are deposited largely on parts of the lamp immediately above the arc, and being white, assist in reflecting the light downwards.

62. Description of Flaming-Arc Lamp.—If both carbons are impregnated and are arranged coaxially, that is, with the positive carbon above the negative, as in ordinary arc lamps, the scoria forms on the end of the lower carbon as a hard bead, which hinders the flow of current. To prevent this, one inventor has placed almost all the impregnating salts in the positive carbon, which is made the lower electrode in the lamp; the scoria then drops harmlessly away from the electrodes. The arc in such lamps is drawn to about $\frac{1}{8}$ inch and has the appearance shown in Fig. 33.

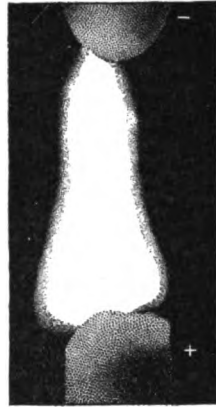

FIG. 33

63. In most flaming-arc lamps, the carbons are arranged side by side and are slightly inclined so that the lower ends approach each other at an acute angle, as in Fig. 34. All scoria then drops away from the carbons as soon as formed. In direct-current lamps, the

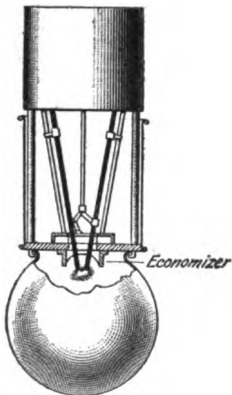

FIG. 34

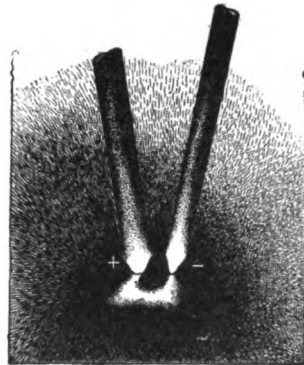

FIG. 35

positive carbon is slightly larger than the negative, so that both burn away at nearly the same rate; in alternating-current lamps, both carbons are the same size.

The arc assumes the form shown in Fig. 35; its natural tendency is to pass across the shortest space between the electrodes, but it is prevented from doing so and is made to bow downwards from the carbon tips by magnets, which cause lines of force to pass across the path of the arc. The arc is thus forced in the same direction as would be a conductor carrying a current through the same field in the direction the current is flowing through the arc. By varying the strength of the magnetic field, the arc can be made to assume the form desired.

64. In the ordinary arc lamp, a large part of the light comes from the incandescent carbon tips, especially from the crater in the positive carbon. If the carbons are arranged coaxially, much of the light from the carbon tips is cut off by the lower carbon; if both carbons feed downwards, as in Fig. 35, there is nothing to interfere with the downward passage of all the light from both carbon tips, as well as that from the flame. About three-fourths of the light from a flaming-arc lamp comes from the flame itself; the remainder, coming from the incandescent carbon tips, contains an excess of violet rays, which improve the general quality of the light.

65. If permitted to enter the top of the lamp freely, the fumes and ashes from the impregnated carbons would be injurious to the mechanism. Moreover, in order to prevent too rapid consumption of the carbons, it is necessary to shield the arc as much as possible from air-currents. An economizer, that is, a chamber made of a material not easily affected by heat (see Fig. 34), surrounds as much of the arc as is necessary to shield it from air-currents, and affords a surface on which most of the mineral vapor is condensed.

EXCELLO FLAMING-ARC LAMP

66. Excello Direct-Current Lamp.—All flaming-arc lamps have many points of resemblance. Most of those first developed are made in Europe and have somewhat complicated regulating mechanism. Fig. 36 shows the principal electrical connections and mechanical details of the

Mathieson direct-current lamp sold in the United States under the trade name *Excello*. A shunt magnet *a* and a series magnet *b* are arranged at right angles to each other, and between them is an armature *c* pivoted at *d* and having arms *e* and *f*. When current is switched on to the lamp, the shunt magnet *a* is excited

and armature *c* moves toward it, lifting arm *f* against the retarding influence of the dash-pot *g*. Attached to arm *f* is a rod *h*, the lower end of which is fastened to a slider *i*. When the rod is raised, the slider, through which the negative carbon passes, is drawn horizontally toward the positive carbon and the carbon tips are brought together, closing a circuit between the two lamp terminals through magnet *b* and the carbons. A momentary starting current 40 per cent. in excess of normal value causes the series magnet *b* to overpower magnet *a*,

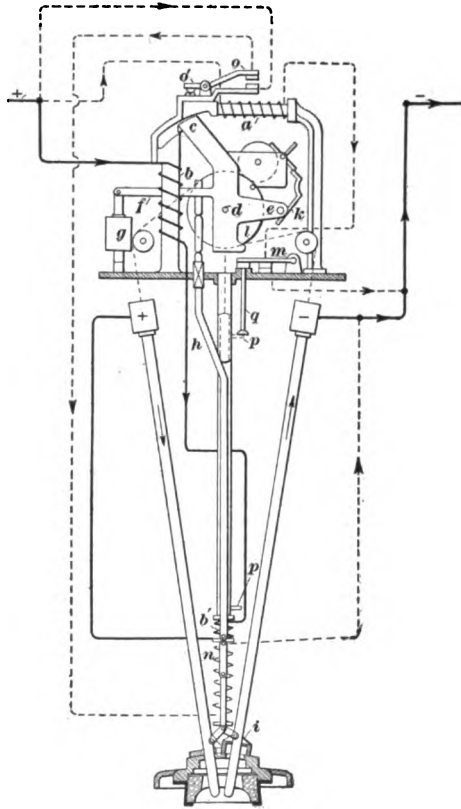

FIG. 36

and armature *c* is drawn back, the rod *h* lowered, and the slider *i* shifted outwards in a horizontal plane, thus separating the carbons and starting the arc. The current immediately drops to normal value. Armature *c* then remains floating between the series and shunt magnets.

As the ends of the carbons burn away and increase the length of the arc, the shunt magnet *a* becomes stronger until armature *c* is drawn over so far toward *a* that the arm *c* causes the detent *k* to release the feeding gear. This gear consists of wheels and pinions controlling the movements of drum *l*, around which is coiled the chains that support the carbons. When the carbons have fallen until the arc is again shortened to the proper length, armature *c* is drawn back automatically until the detent *k* arrests the movement of the gear. As the carbons fall, a detent, or tripping pin, attached to a third chain passing over the drum *l* gradually rises in the center tube, and when the carbons are consumed the pin has reached the position *p*, where it raises the stud *q* and opens the switch *m* in series with the shunt magnet *a*. Armature *c* is instantly drawn to its extreme position toward magnet *b*, forcing the slider *i* over so that the carbons are separated as far as possible, and the arc is broken. Coil *b'*, in series with the arc, supplies the magnetism required to keep the arc blown down to the ends of the carbons. The higher voltage lamps have an additional blow-out coil *n* in series with a switch *o* across the circuit. While the lamp is operating, the shunt magnet *a* attracts the rear end *o'* of the switch, which is thereby held open; as soon as magnet *a* is cut out, switch *o* closes and coil *n* assists in blowing out the arc.

67. Excello Alternating-Current Lamp.—In Fig. 37 is shown the arrangement of the wiring and mechanism in an alternating-current lamp. A shunt magnet *a* is connected directly across the lamp terminals through the switch *m*, while a magnet *b* is connected in series with the blow-out coil *b'* and the arc, these connections being similar to those of the direct-current lamp. A copper disk *c* is arranged to rotate near the poles of magnets *a* and *b*. Alternating magnetism in the poles sets up eddy currents in the disk, and the reaction between these currents and the magnetism causes the disk to rotate, the direction of rotation depending on the relative strength of the magnets. When the

lamp is ready for operation, the carbon ends are in contact, and when the lamp is switched on to the circuit—the resistance through coils *b*, *b'* and the carbons being low—a considerable current flows, and series magnet *b* is strongly excited. This causes wheel *c* to rotate in a direction to wind the chains on the drum *l* and draw the carbons apart, thus striking the arc. The voltage across the arc soon causes the shunt magnet *a* to become excited enough to balance the effect of the series magnet *b* on the rotating disk, which therefore comes to rest with the proper length of arc. The two magnets act differentially on the disk while the lamp is operating and automatically keep the arc adjusted. When the carbons are burned out, the pin on piston *p* lifts the stud *q* and

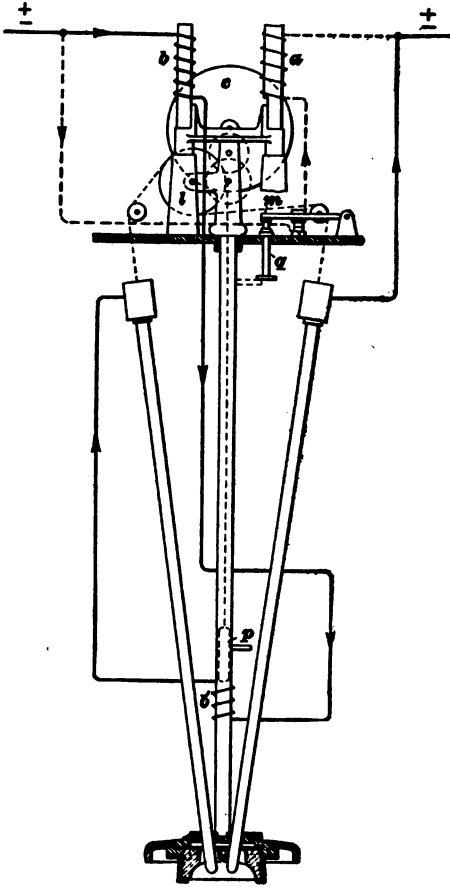

FIG. 37

opens the switch *m* in the shunt circuit; the series magnet at once causes the carbons to be separated so far that the arc is broken.

68. Excello Lamp Economizer.—Fig. 38 (*a*) shows a view of the economizer *a* and the carbon tips while the arc

is burning; *b* is a blow-out coil, consisting of a few series-turns to hold the arc down on the carbon tips and a number of auxiliary shunt turns that are used only to help blow out the arc when the carbons are consumed. Rods *c, c* are a part of the framework of the lamp, and *d, d* are the carbons. Fig. 38 (*b*) shows the position of the carbon ends when they have been automatically separated and the arc disrupted.

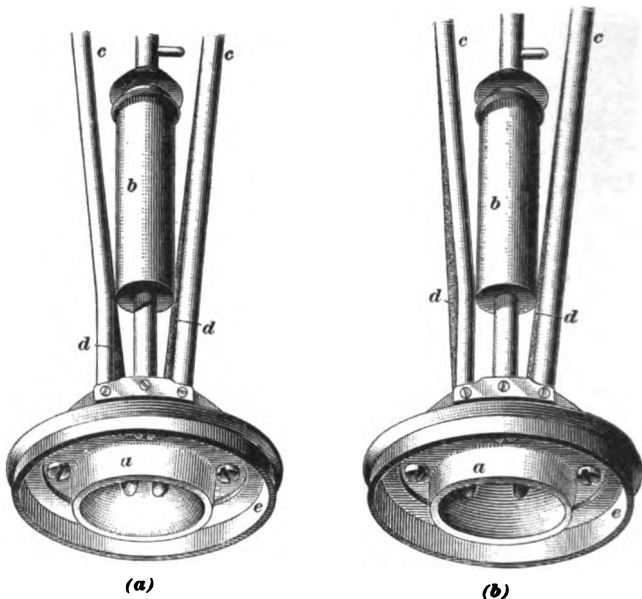

FIG. 38

Suitable ventilating holes are provided around the economizer for the escape of gases, and the pan underneath the globe (not shown) contains holes to admit the air needed by the arc. The globe surrounds the arc and fits tightly inside the rim *e*. All the lamp mechanism is housed as completely as possible, to protect it not only from the weather, in case of outdoor lamps, but also from the fumes of the lamp.

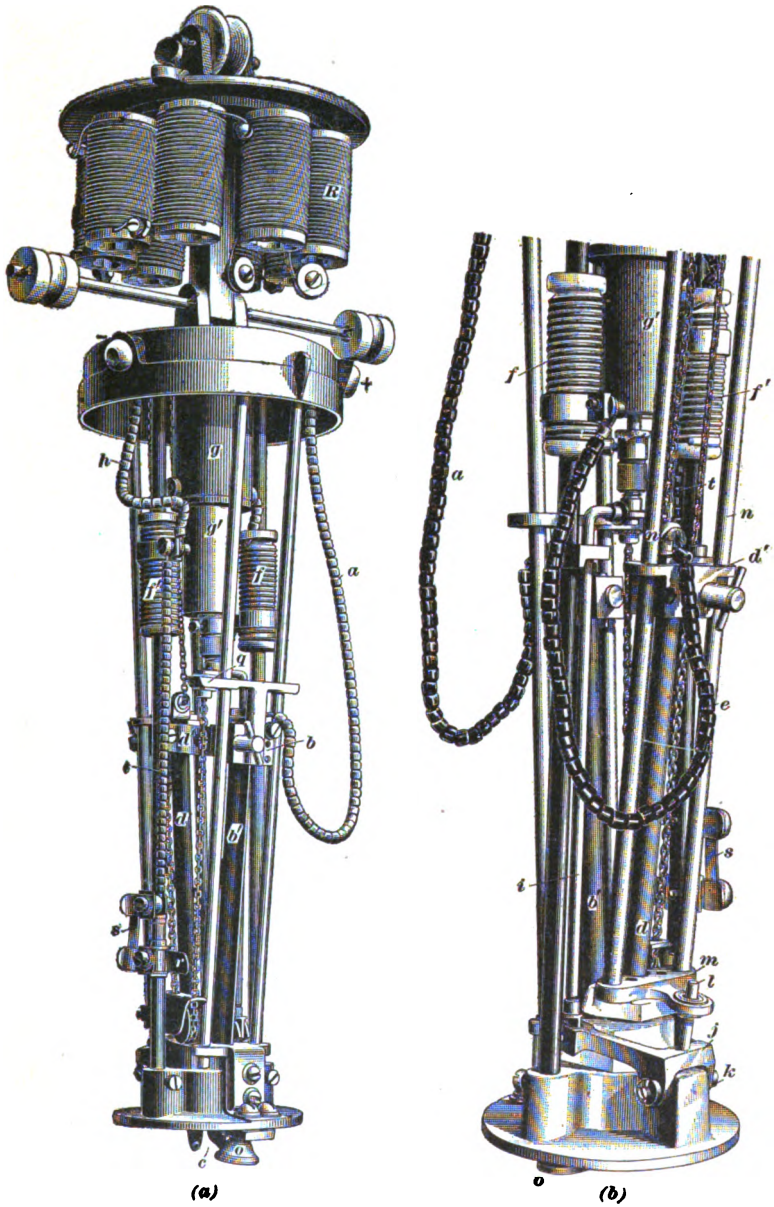

FIG. 39

THE BECK LAMP

69. Fig. 39 (*a*) and (*b*) are front and rear views of the interior of a **Beck direct-current flaming-arc lamp**, with resistance on spools *R* such that the lamp can be operated singly on a 110-volt circuit. Without the resistance, this lamp is suitable for use on from 55 to 65 volts, two in series on from 110 to 120 volts, or four in series on from 220 to 240 volts. The resistance may be connected in either the positive or the negative line. Assuming that it is in the positive line, the current passes through the resistance and enters the

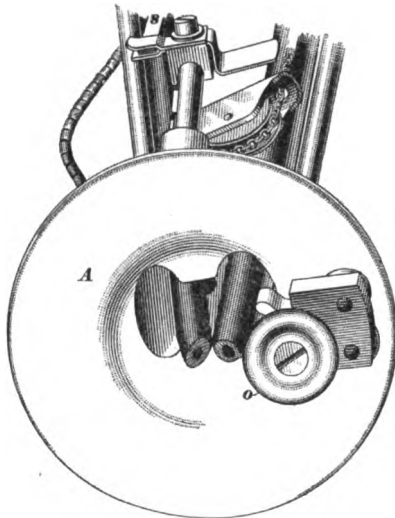

FIG. 40

positive terminal of the lamp, through which it takes the following path: positive cable *a*, carbon holder *b*, and carbon *b*-arc *c*-negative carbon *d*, holder *d'*, and cable *e* [shown only in (*b*)]-arc blow-out coil *f*-lifting magnet *g*-arc blow-out coil *f'*-cable *h*, to the negative terminal.

Fig. 40 is a view of the bottom of the lamp, showing the economizer *A* and the carbon tips as they rest together when the lamp is ready for operation. When the current is switched on, the magnet *g*, Fig. 39 (*a*), lifts the rod *i*, Fig. 39 (*b*), which turns the casting *j* on the pivot *k*, causing the pin *l* to move the casting *m* and its attached porcelain piece, through which the negative carbon passes, away from the positive carbon, thus striking the arc. A dashpot *g'* steadies the movements. The rods *n, n* are so fastened in the top of the lamp as to allow them to swing outwards at the bottom. While the lamp is operating, some of the magnetism produced by the

blow-out coils f, f follows down the side rods to the bottom of the lamp, and enough of it crosses the space between the carbon tips to force the arc down, so that it forms a bow, or inverted arch, between the tips.

70. Running the whole length of one side of the positive carbon is a rib that rests on a cone-shaped metal wheel o , Figs. 39 and 40. This rib burns to a fine point where it rests on the wheel, gradually crumbles off, and allows the carbon to drop slowly. The two carbon holders are connected by a chain, as shown diagrammatically in Fig. 41. The chain is insulated from each holder and passes around two pulleys p, p' —one in the top of the lamp and one in the bottom. When the ribbed carbon drops, the chain moves over the pulleys and permits the other carbon to drop an equal amount, so that the two feed down together.

When the carbons are burned as short as they can be without injuring the lamp, a projection on the positive holder pushes the negative holder to its extreme outward position, making the arc as long as possible, after which the projection q , Fig. 39 (*a*), on the positive holder touches the contact piece r , which is connected through the fuse s and cables t and h to the negative terminal of the lamp. This short-circuits the lamp, puts out the arc, and at the same time blows the fuse. As the carbons are held apart, the arc cannot start again.

A sheet-metal casing encloses the lamp mechanism, and a large translucent globe surrounds the arc and protects it from air-currents. The size and appearance of the completed lamp do not differ materially from those of ordinary arc lamps. The alternating-current lamps operate on the same general principles as the direct-current lamps, very few minor changes being necessary.

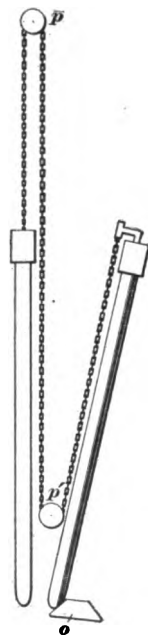

FIG. 41

CHARACTERISTICS OF FLAMING-ARC LAMPS

71. Impregnated Carbons.—The impregnated carbons used in nearly all flaming-arc lamps consist of three zones, or layers: (1) An inner soft core made of a mixture of carbon and salts of calcium, magnesium, or whatever metal is required to give the desired color; (2) a layer of the same materials more firmly compressed; (3) an outer layer of firmly compressed pure carbon, giving mechanical strength to the whole. In some cases, in order to reduce the resistance, the carbons have a metallic core. Fig. 42

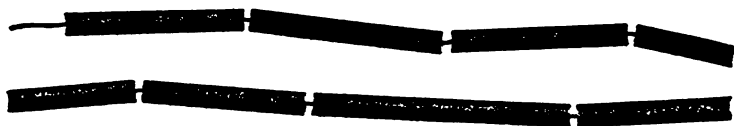

FIG. 42

shows a pair of carbons, such as used in the Excello lamps, broken in pieces to show the metallic core.

The impregnated carbons used in flaming-arc lamps are expensive and they last only from about 8 to 20 hours, according to their length and the quantity of current in the arc. If used for street lighting, it is necessary to trim most flaming-arc lamps about every day, as was done with the

TABLE III
COMPARATIVE LAMP TESTS

Comparisons	Flaming Arc	Enclosed Arc
Mean amperes	8	5.1
Mean volts at the arc	45	81
Mean watts at the arc	360	413
Mean spherical candlepower	1,020	232
Mean lower hemispherical candlepower	1,560	260
Watts per mean spherical candlepower353	1.78
Watts per mean hemispherical candlepower231	1.59

old-style open-arc lamps. The cost for maintenance is therefore high. Some lamps have been arranged with a magazine holding a number of carbons in such a way that as soon as one pair is exhausted another pair is automatically substituted.

72. Candlepower and Distribution.—The data given in Table III are from tests made by the Electrical Testing Laboratories, New York City, on a flaming-arc lamp (the Excello) and on a direct-current enclosed-arc lamp.

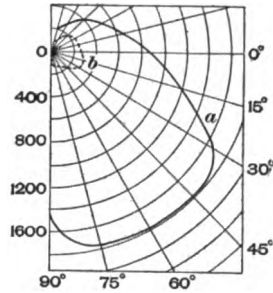

FIG. 43

The distribution of light as determined by the tests just mentioned is illustrated graphically in Fig. 43. The arcs of circles represent the intensity of the light in candlepower,

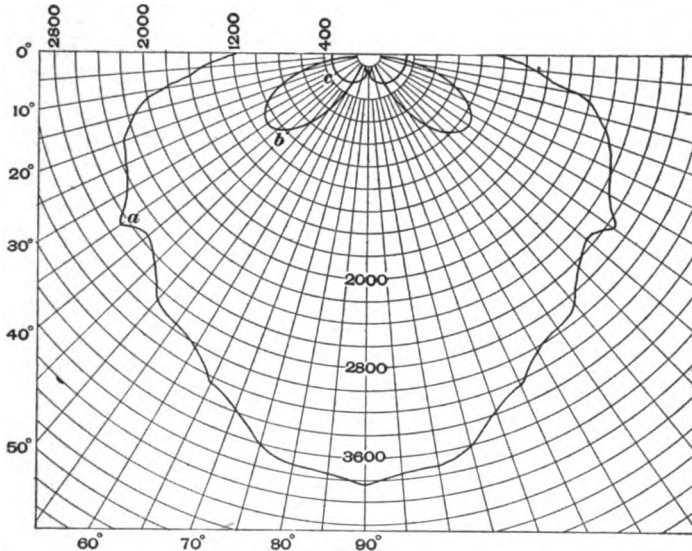

FIG. 44

as shown by the figures along the left-hand margin. The center *O* shows the position of the lamps, while the full-line curve *a* represents the light given off by the flaming arc,

and the dotted curve *b*, that given off by the enclosed arc. The two curves have the same general shape, showing that the light is distributed from both lamps in very much the same way; but the flaming arc gives off nearly six times as much light as the enclosed arc. The maximum light from the flaming arc is given off in the angular space between 30° and 75° below the horizontal, and decreases slightly directly under the lamp. The flaming-arc lamp had an opalescent globe, and the enclosed-arc lamp had an opalescent inner globe but no outer globe.

The distribution of light from a flaming-arc lamp with downward-feeding carbons and no globe is shown by curve *a*, Fig. 44. Curve *b* shows the distribution and the relative intensity of light from an old-style open-arc lamp, and curve *c* the corresponding quantities for an enclosed-arc lamp.

73. The effect of impregnating the carbons with different light-producing minerals is shown in Fig. 45. The

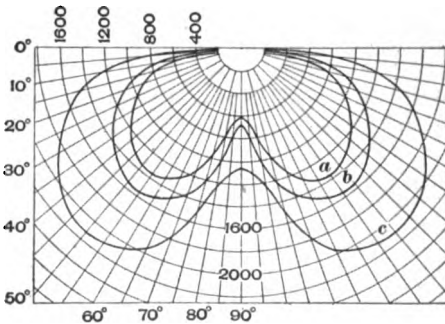

FIG. 45

same lamp with different sets of carbons was used for each curve, and the lamp consumed the same power in each case. The white light, curve *a*, was produced at an expenditure of 1.202 watts per spherical candlepower; the red light, curve *b*, at 1.03 watts; and the yellow light, curve *c*, at .716 watt. These curves were taken with an alternating-current lamp consuming 578 watts.

CARBONE ARC LAMPS

74. The **Carbone arc lamp** is the result of an attempt to secure with pure carbons the advantages of downward-feeding inclined carbons and also freedom from interference with light reflection from the carbon tips. From 80 to 90 volts are used across the arc, which is forced down to the carbon tips by suitably arranged magnets. Fig. 46 shows the position of the electrodes *a* and the magnets *b, b* for steadying the arc. Most of the magnetism traverses the iron ring *c*, but holes *d, d* increase the *reluctance* of the ring, that is, its opposition to the passage of magnetism, and enough lines of force leak across from one side of the ring to the other to cause the arc to spread out and bow downwards in the form of a spherical segment. An economizer fits inside the iron ring *c* around the carbon tips.

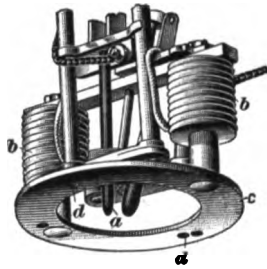

FIG. 46

Considerable advantage is obtained over the ordinary arc lamp, and although the efficiency is not so high as with impregnated carbons in the flaming-arc lamp, the Carbone lamp has the advantage of using very much cheaper carbons. Table IV gives comparative results in hemispherical candlepower.

TABLE IV
COMPARISON OF VARIOUS ARC LAMPS

Type of Lamp	Candlepower per Ampere	Candlepower per Watt	Watts per Candlepower
Ordinary open arc . . .	82	1.54	.65
Enclosed arc	55	0.77	1.3
Carbone arc	200	2.24	.445
Impregnated-carbon arc	259	5.78	.173

MAGNETITE LUMINOUS-ARC LAMP

75. In any electric arc, the material that supports the arc issues from the negative electrode as a high-velocity arc blast, which strikes the positive electrode and heats it. Unless the positive electrode is large enough to conduct this heat away, it may get hotter than the negative electrode, as is the case with ordinary arc lamps, in which the positive carbon is burned away nearly twice as fast as the negative carbon. The size of the positive electrode may be made such that it will wear away but very little; if too large, the material from the negative electrode will be deposited on it.

The magnetite luminous-arc lamp developed by the General Electric Company has a copper positive electrode large enough to be practically unaffected by the arc; also a negative electrode, made up by packing in thin iron tubes, 8 inches long by $\frac{5}{8}$ inch diameter, very finely divided *magnetite*, or black oxide of iron, in which are mixed small quantities of salts of chromium, titanium, etc. Pure magnetite does not give such high efficiency nor produce so steady an arc as that containing the other salts mentioned.

76. In Fig. 47 (*a*) is shown a luminous-arc lamp complete, and in (*b*), the interior with the globe and casings removed. At *a* is shown the series magnet; *b*, the shunt magnet; *c*, the starting magnets (one directly back of the other); *d*, the dashpot; *e*, the adjusting armature disk, for regulating the frequency of the automatic arc adjustments; *f*, an adjustable stop, for regulating the length of the arc; *g*, the starting resistance, of which there are several spools; *h*, an iron box, through a slot in which extends the positive electrode *i*—a copper bar; *j*, the negative electrode; *k*, the tripping rod; and *l*, a central tube, or chimney, for discharging the gases from the arc out of the top of the lamp. These lamps are used only with direct current, either in series on constant-current circuits or in multiple on constant-potential, 110- or 220-volt circuits.

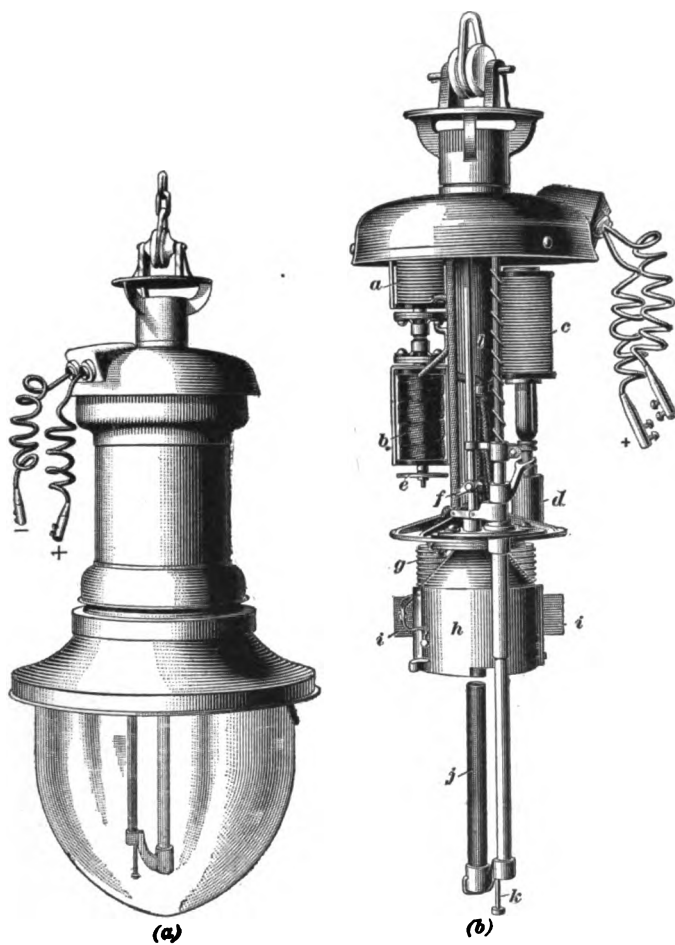

FIG. 47

78. The voltage across the lamp terminals at the start is about 75. As the arc lengthens, owing to the burning away of the negative electrode, the voltage gradually rises until it reaches a fixed limit, when the shunt magnet acts to close the carbon contacts, thus short-circuiting the shunt magnet and permitting the starting magnet to again adjust the arc. This feeding occurs about once every hour.

Each negative electrode lasts from 150 to 200 hours; a positive electrode lasts about 4,000 hours. There is some residue from the burning, most of which falls into a tray in the bottom of the globe. This tray should be cleaned and the globe brushed out at each trimming; also, the center tube should be cleaned by running a small brush through it.

The constant-current luminous-arc lamps consume about 320 watts and give off about 400 spherical candlepower, the specific consumption being about .8 watt per candlepower. The output of light is slightly greater than that of a 340-watt open-arc lamp or a 460-watt enclosed-arc lamp, and the distribution is better.

In a later type of magnetite luminous-arc lamp, the positive electrode, consisting of convoluted strips of laminated copper and iron, forms the stationary lower element of the lamp, and the magnetite tube, which is connected to the negative lamp terminal, forms the upper element. The feed is downwards, which somewhat

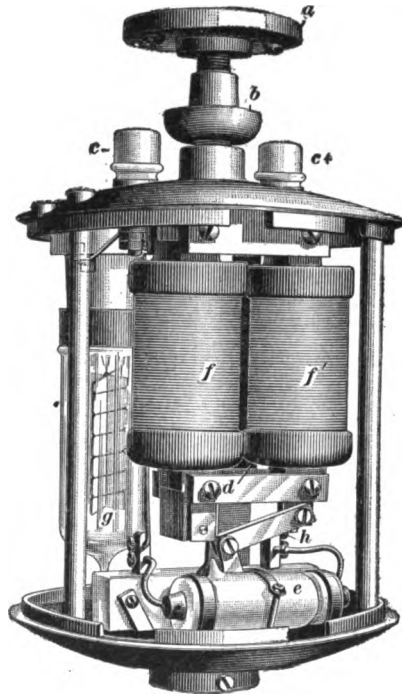

FIG. 50

simplifies the lamp mechanism. Better light distribution is also obtained.

79. Automatic Mercury-Vapor Lamp.—The Cooper Hewitt type P lamp is so constructed that on closing the switch it will operate without the necessity of tilting the tube. In Fig. 50 is shown the lamp mechanism, and in Fig. 51 the connections of the operating devices. Corresponding parts in the two figures are lettered the same. In Fig. 50, *a* is the ceiling plate; *b*, the insulating joint; *c* + and *c* −, Figs. 50 and 51, are the lamp binding posts; *d*, a resistance coil; *e*, the shifter, or circuit interrupter; *f* and *f*′, the inductance coils; *g*, the ballast; and *h*, an armature, which is drawn toward *f*, *f*′ when these coils are energized.

The positive lamp terminal *c* +, Fig. 51, is connected to

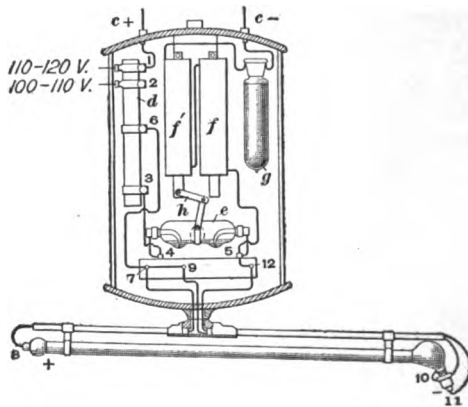

FIG. 51

terminal 1 or terminal 2 on the resistance coil, depending on the voltage of the circuit. The shifter consists of a glass vessel containing two electrodes, which are connected by mercury when the lamp is not operating. This vessel is mechanically connected to armature *h* and is rotated on its axis when *h* is drawn up; an indentation in the glass vessel then divides the mercury stream into two separate bodies and the rotation also causes the mercury to fall away from the contacts, thus opening the circuit through the shifter.

The lamp is started as follows: Close the switch; current now flows from $c+$ through 1 or $2-3-4-e-5-f-f'-g-c-$. The inductance coils are energized and armature h is drawn up, thus rotating shifter e , breaking the circuit through the shifter, and impressing a high electromotive force, due to the kick of the inductance coils f, f' , on the lamp tube terminals. The positive side of the lamp mechanism is connected to the positive tube terminal by path $6-7-8$, and to a starting band, consisting of a metallic coating painted on the outside of the enlarged chamber on the tube, by path $6-7-9-10$. The negative side of the lamp mechanism is connected to negative tube terminal 11 . The high electromotive force set up between 8 and 11 , and 10 and 11 overcomes the resistance between the tube terminals and starts the arc. The starting band assists by concentrating the stress, due to the kick of the inductance coils, at the surface of the mercury in the negative electrode, thus causing minute sparks at the mercury surface. As soon as the arc starts, the path of the current that maintains the arc is $c+ -1-6-7-8-tube-11-12-f-f'-g-c-$.

ELECTRIC SIGNS

FIXED ELECTRIC SIGNS

1. Electric signs are of almost endless sizes and varieties and some very striking effects are produced with them. There are many patented devices in use for producing electric-sign effects. While only a few of these are described in this Section, yet there is abundant chance for the electrician or wireman to exercise his ingenuity in devising new arrangements and devices to catch the public eye. The descriptions that follow are suggestive of innumerable schemes. There are two general classes of electric signs: those that have a fixed display and those that change either automatically or at the will of an operator.

2. **Fixed electric signs** may be classified as those in which the lights are arranged to illuminate a printed or a painted sign; those in which the lamps are concealed behind letter-shaped openings covered with translucent material through which the light shines; and those in which the lamps themselves are arranged in the form of letters, the bulbs being displayed. Combinations of any two or more of these methods may be used.

The user of an electric sign is addressing the public, and he naturally desires to address the greatest possible number of people for the longest possible time and in the most impressive way. The sign should be designed with these points in view. A sign that is legible only for short distances or only during the night while the lamps are burning is, generally speaking, of less value than one that can be read distinctly from a long distance and that is visible either by day or night.

Copyrighted by International Textbook Company. Entered at Stationers' Hall, London

ILLUMINATED SIGNS

3. Fig. 1 shows a sign that is distinct and legible either by day or night and that can be arranged single-faced or double-faced; that is, so that it can be read from one direction or from both. This sign consists of white letters on a blue enameled background surrounded by a border in which is placed a number of incandescent lamps, which are so arranged that the letters are brilliantly illuminated while the



FIG. 1

lamps are burning. The lamp sockets and wiring are concealed behind the border, and the wiring is very simple.

The making of such an enameled sign is an expensive operation, requiring special tools and facilities, but any electrician assisted by a sign painter should be able to make up a sign similar to that shown in Fig. 1. A modification that might in some cases be an improvement would be to arrange shades over the lamp bulbs, so as to conceal them from view and at the same time throw the light on the letters.

TRANSPARENT SIGNS

4. One sign manufacturer has had patented a method of

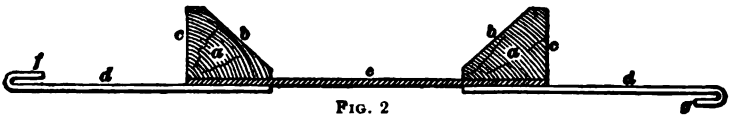
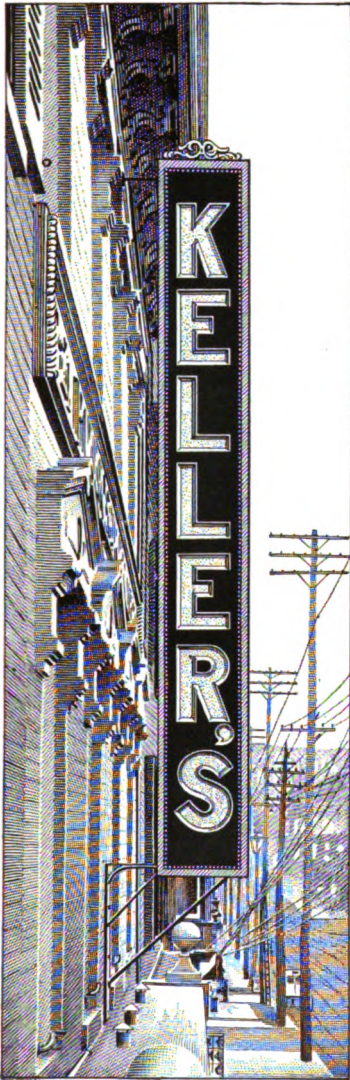
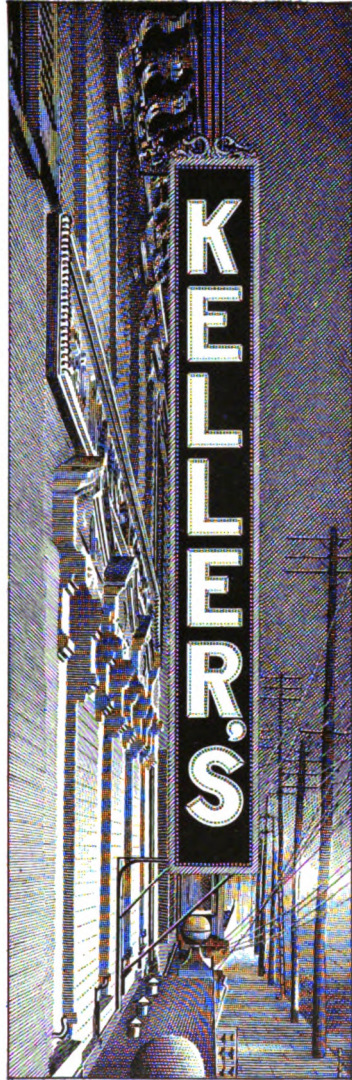

FIG. 2

making electric signs in which the letters or characters are



(a)



(b)

FIG. 3

outlined by a raised molding, leaving a hollow central portion that is covered with a light-tinted, wire-woven, translucent substance, behind which electric lamps are arranged. Fig. 2 shows a sectional view of a letter; *a* is the molding, of which the face *b* is covered with gold leaf and the side *c* tinted to harmonize with the dark background *d*. The letter-shaped opening outlined by the molding is covered with the translucent material *e*, back of which the lamps are placed. The hooks *f* and *g* enable any number of letters to be interlocked. Fig. 3 (*a*) shows the appearance by daylight of a sign made of such letters, and (*b*) shows the same sign at night.

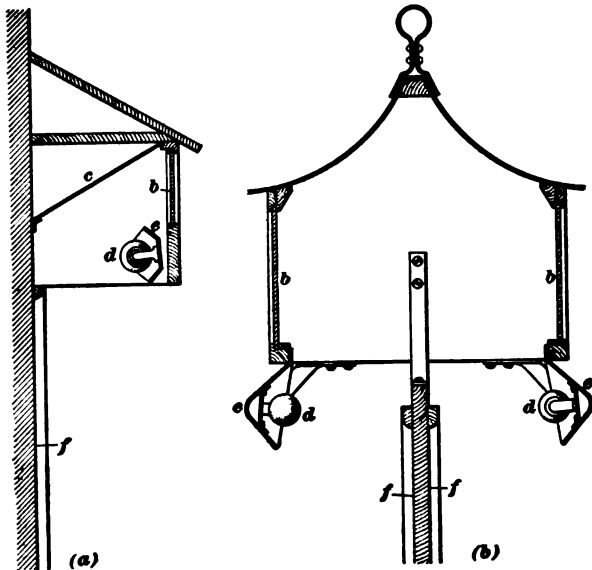

FIG. 4

5. Combination Sign.—Fig. 4 shows sectional views of a patented device in which electric lamps are used, both to illuminate a painted sign and to light a transparency; (*a*) shows a single-faced sign, and (*b*) a double-faced sign. In (*a*) the transparent sign *b* forms the front wall of a casing, across the opposite upper corner of which is a reflector surface *c* that throws the light of the row of lamps *d* out through

the transparency. Behind the lamps is a curved or V-shaped reflector e , which may be turned at any desired angle to direct a proper portion of the light on the painted sign f below the casing. The lamps are invisible, while the signs are well illuminated. The double-faced sign b is practically a duplicate of the single-faced sign. Transparent signs b are placed in each side of the hood, or casing, and there are two painted signs f and two rows of lamps d , each row having its curved reflector e .

EXPOSED-BULB SIGNS

6. One lamp may be used to illuminate a considerable portion of a painted sign or a transparency; but in order to form a letter of exposed lamp bulbs so that it will be intelligible at night, several lamps must be used. It is an object to keep the number of lamps as small as possible, not only to reduce the cost of the sign, but also to keep the cost of operation down. In Fig. 5 (a) is shown the result of an attempt to make the letter E with only six exposed lamp

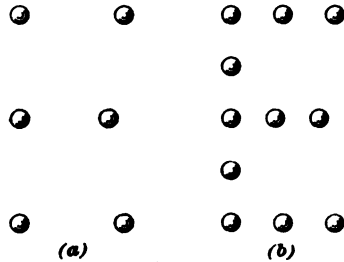
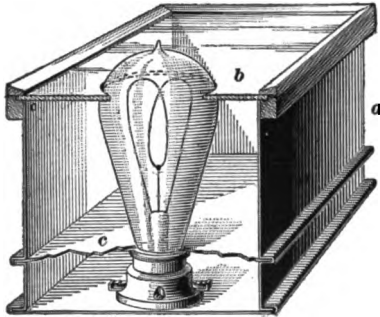

FIG. 5

bulbs and no reflecting surfaces, while in (b) is shown the number and arrangement of lamps necessary to make the letter legible.

7. By enclosing the lamps in boxes having the shape of the letter to be produced, and by using reflecting and distributing surfaces so that the light can be thrown only in the outline of the letter, fewer lamps may be used. Fig. 6 (a) shows a section of a patented letter that in reality is a combination of a transparency and an exposed-bulb sign. The letter, as patented, consists of a galvanized-iron body a with a translucent face b through which the ends of the lamp bulbs protrude. A white reflecting surface c and the white inner surfaces of the box throw nearly all the light out through the

translucent surface. Fig. 6 (b) shows a 24-inch letter *H* made in this way and lighted with only seven lamps. The translucent faces are white, so that the letters are equally legible by day or night.



(a)

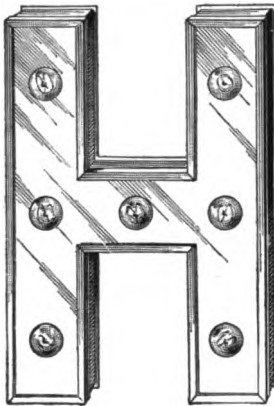

(b)

FIG. 6

8. Doubled-Faced Signs.—Individual letters are sometimes cut from wood, painted with white-enamel paint so that they will be distinct in daylight, and covered with incandescent lamps, which bring out the outlines of the letters at night. In making up double-faced signs, of letters made in this way, it is well to bear in mind that the letters *A, H, I, M, O, T, U, V, W, X,* and *Y* appear the same whether viewed from the back or the front. It is often possible to use both faces of these letters. The other letters of the alphabet must be cut from material thin enough, so that when two letters are placed back

to back they will have the same thickness as the double-faced letters.

Fig. 7 shows a large sign on a prominent corner in New York City. The letters are cut from 2-inch seasoned lumber, painted white, and fastened to a wide strip of bar iron, which serves to hold the sign in position. On the faces of the letters are rows of incandescent lamps, which make the sign very conspicuous at night. The dentist sign a short



FIG. 7

distance from the corner is one of the type described in Art. 3.

9. Examples of Large Signs.—The immense Butterick sign, Fig. 8, on the side of the Butterick Building, in New York City, can be seen from the New Jersey shore within a radius of several miles. The first letter is 68 feet high, while

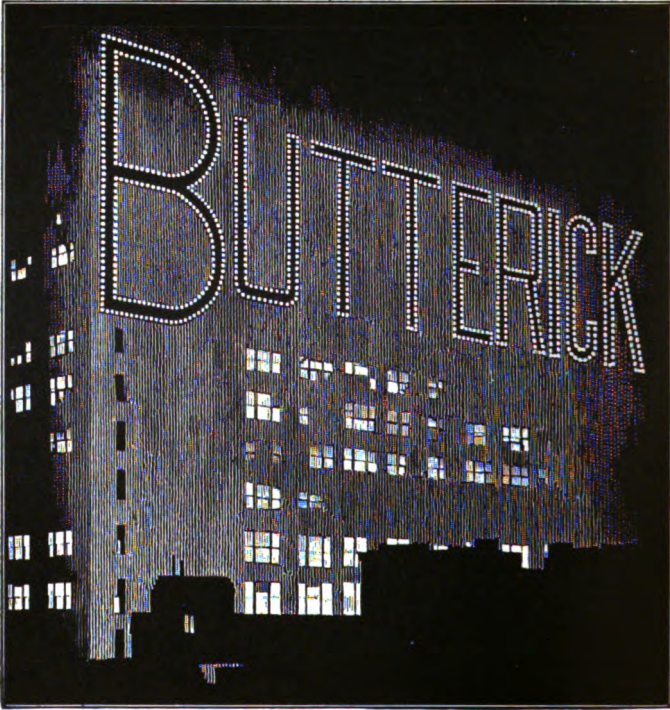

FIG. 8

the others are 50 feet. The two lines of lamps inscribing the outlines of the letters are 5 feet apart. The letters are painted in fast black on the brick wall. A light steel box construction about 6 inches high is spaced about 6 inches from the wall, to which it is fastened by means of expansion bolts. The box construction is made in sections about 10 feet long, with lamp sockets every 18 inches, and is placed around the

outlines of the letters. There are twelve hundred 4-candle-power lamps controlled by three switches, each switch having a separate panel box. From one panel runs twenty-four circuits and from each of the other two, sixteen circuits. The wiring is carried through the interior of the sign boxes.

10. The New York Edison Company has erected a sign, shown in Fig. 9, at its coal-storage plant at Shadyside, New Jersey, which can be seen plainly for several miles up and

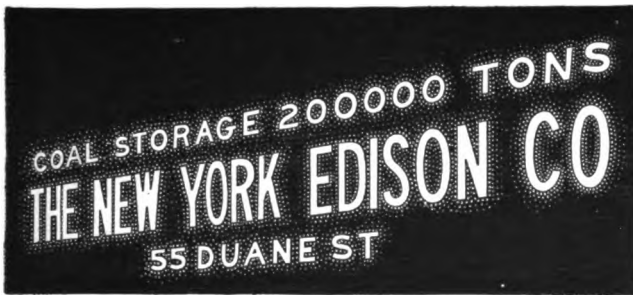

FIG. 9

down the New York side of the Hudson River. To support this sign, a framework requiring over 70,000 pounds of steel was put up. The sign contains eighteen hundred 8-candle-power lamps. A special 75-kilowatt generator and engine is used to supply the electricity.

The lamps used for electric signs are usually of smaller candlepower than those used for ordinary illumination; 4-, 6-, and 8-candlepower sizes are common. Sign lamps also have shorter and thicker bulbs, with the filament so coiled that the larger part of the light will be thrown out at the end.

CHANGEABLE SIGNS

CHANGES IN INTENSITY OF LIGHT

THERMOSTATS

11. The fixed, or permanent, signs thus far described may be made very attractive and of considerable value to the advertisers; but no sign arrests the attention of passers-by as does one in which there is apparent animation, especially if the changes or motions are surrounded with an air of mystery. In electric signs, changes so slight as the lighting and putting out of the lamps or changes in the intensity of the light will arrest the attention long enough for the passer-by to read what the advertiser has to say. Automatic devices may be arranged to switch off all the lamps of a sign together or part of them at a time. This is frequently done by means of a **thermostat**, an instrument in which an electric current heats a metal and causes it to expand until a circuit-opening device is made to operate so as to close or open a circuit, after which the heating current is cut off or so reduced that the metal cools and contracts and the device is operated in the reverse direction; this throws the heating coil into circuit again, and the series of operations are repeated indefinitely.

12. **The Thermoblнк.**—Fig. 10 (*a*) shows a form of thermostat having the trade name **thermoblнк**, and (*b*) shows the connections with a circuit of lamps. This device consists of metal strips arranged in the form of a triangle, around one leg of which is wound a coil *a* of fine wire that forms a part of a circuit through the lamps. When the current is first switched on, the end *b* of the triangle does not quite make contact with the end of a screw *b'* with which one

end of the lamp circuit connects; but a small current, not enough to light the lamps, flows through the coil *a* and heats it. The heat causes the metal around which the coil is wound to expand until the end of the triangle swings over and touches the contact screw *b'*; current enough to light the lamps then flows through the side *c* and the contact screw. The coil *a*, being shunted by the side *c*, soon cools and the triangle springs back to its normal position, thus

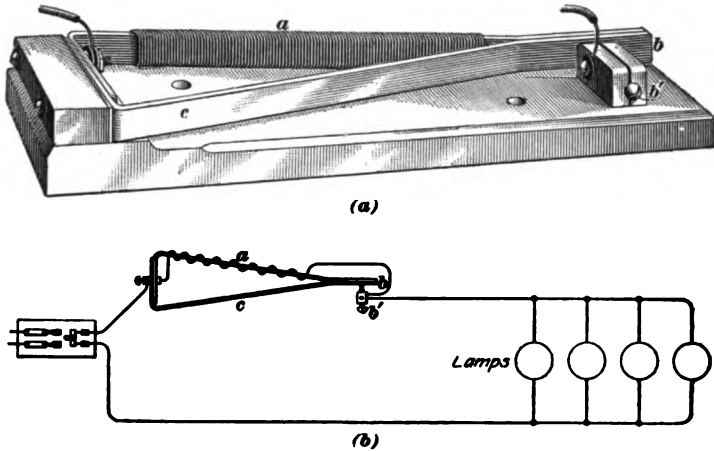

FIG. 10

breaking the contact between *b* and *b'* and putting out the lights. This process is repeated indefinitely or until the whole circuit is switched off.

In another form of the same device, a central tongue is made to swing both ways by the influence of a heating coil, one of two circuits being closed immediately after the other is opened. A retarding device holds the contact closed in either position until the pull becomes strong enough to open it with a snap.

13. Lamps With Thermostats.—It is now possible to obtain incandescent lamps that have U-shaped bimetallic thermostats in the bases, made as shown in Fig. 11. The two metals of which the U-shaped piece is formed have different rates of expansion under the influence of heat.

The **U** is wound with a coil of wire *a* connected in series with the lamp filament. When the lamp is connected to the circuit, it lights for an interval, until the coil heats and causes the **U** to spread and open the circuit, as shown

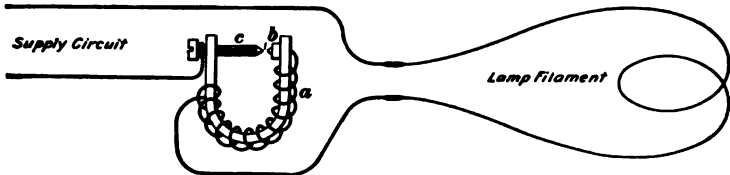

FIG. 11

at *b*. This stops the flow of current through the filament and puts out the lamp; the heating coil *a* soon cools and the contact *b* closes, thus again lighting the lamp. By means of an adjusting screw *c* the rapidity of the flashing may be regulated. The contact points at *b* are tipped with platinum.

14. Double-Filament Lamps.—Fig. 12 shows a sign lamp having a large and a small filament. The base contains a thermostat that causes the two filaments to light alternately. While on the circuit, such lamps are never entirely dark, but the intensity of the light changes enough to draw attention.

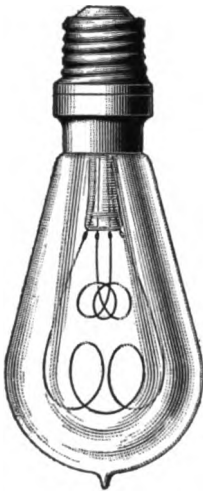
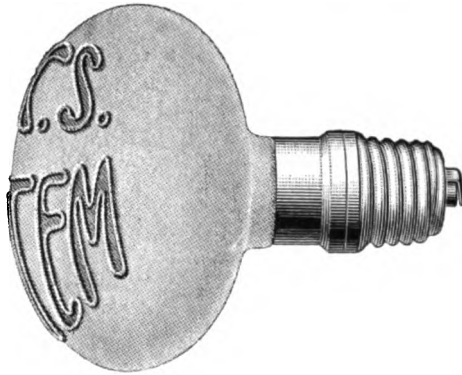

FIG. 12

15. Turnip Sign Lamps.—Fig. 13 (*a*) and (*b*) shows side and end views of a turnip sign lamp, so called because of its shape. The base contains a thermostat, and on the end opposite the base is a letter, word, or sentence to be displayed. The continual flashing calls attention to the advertisement.

16. Thermal Flashers.—Not over 2 amperes current can be broken by the thermostats thus far described, as the sparking, if a larger current were broken, would soon destroy the contacts. In Fig. 14 (*a*) is shown a thermal flasher made by the Solar Electric Company that will break

10 amperes, and in (b) is shown connections to a circuit of lamps. The carbon contacts *a* are normally separated, the upper one being fixed in position and the lower one attached to one end of a spring lever *b*, the other end of which is fixed at *c*. Near the fixed end of the lever *b* is attached the end of an expansion wire *d* that passes down through a tube and pulls the lever *b* downwards against the opposing action of a spring *e*, which may be either coiled, as shown, or flat. Around the expansion wire inside the tube is a coil of fine wire, called the heating, or resistance, coil, one end of which is in connection with the fixed end of the spring lever *b* and the other in connection with the upper, or fixed, carbon block *a*. These connections make the resistance coil a part of the circuit through the lamps.



(a)



(b)

FIG. 13

When current is turned on, it flows through the heating coil, which does not permit the passage of enough current to light the lamps of the circuit; but as the coil heats, the expansion wire inside stretches until the carbon blocks are drawn together by the spring *e* and the lamps light. The heating coil, now being shunted by the lever *b* and the carbon

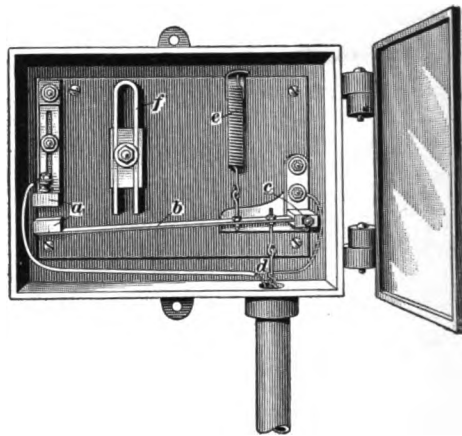

(a)

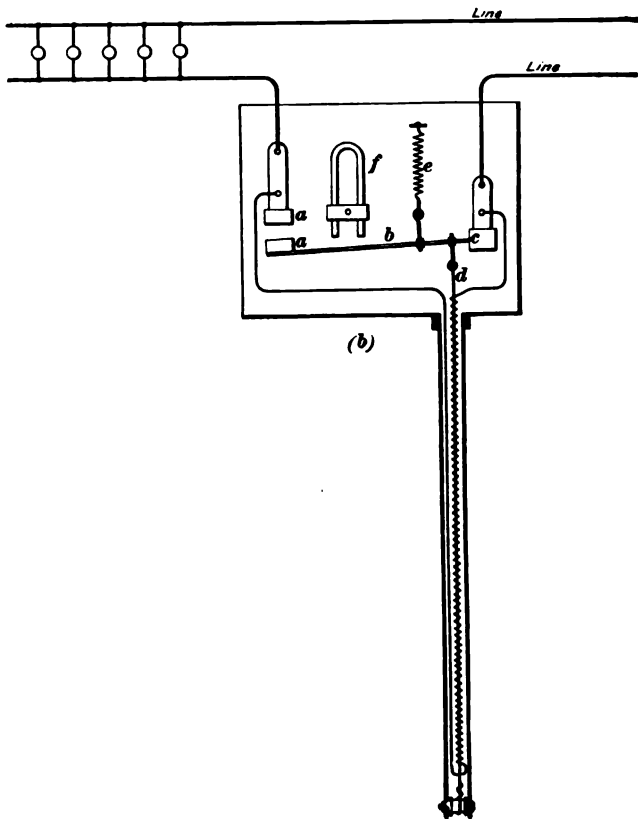

FIG. 14

blocks, soon cools, and the expansion wire contracts and pulls down on the lever against the combined holding power of the permanent horseshoe magnet *f* and the spring *e*. The pull of the expansion wire finally becomes so strong that the carbon blocks separate with a quick break. The resistance coil immediately begins to heat again and the process is repeated. Adjustments can be made on the regular flashers so that the lamps will light from eight to fourteen times per minute and so that they will remain lighted any desired portion of the time, from 50 to 90 per cent. Special thermostats of this type have been made to work once a minute and others to work fifty-six times a minute.

MECHANICAL FLASHERS

17. Double-Pole Flasher.—Various mechanical devices are in use for flashing lamps automatically. Figs. 15 and 17 show devices made by the Electric Motor and Equipment Company. In Fig. 15 (*a*) is shown a three-circuit, double-pole, commutating switch, or flasher, and in (*b*), a similar switch with the motor and one end casting removed. The rotation of the motor is transmitted through the belt and worm-gear to the shaft *a*, on which are as many disks *b* as there are circuits to be controlled. In Fig. 15 (*b*) only two disks are shown in place, the third being removed in order to show the mechanism. Near the rim of each disk is a series of holes, in any of which may be placed the pinions of steel rollers *c*. The rollers may be placed on either side of the disk, and the pinions are secured in place by screws through the rim of the disk, as shown at *c'*.

When the roller on one side of the disk presses against the jointed links *d* and forces them down until they are in line with each other, the switch arm *e* is forced over until the blades *e'* enter the spring clips *f*. The spring *g* is then under tension, tending to open the switch. A smaller shaft *h* below the main shaft *a* carries castings, each of which has two cams *i, j*. There are one set of links and one pair of cams for each disk. The links and cams shown in Fig. 15 (*b*)

are operated by the third disk, removed from shaft *a*. After the roller on one side of the disk has closed the switch and passed on away from the links, a roller on the other side strikes against the cam *i* and causes cam *j* to force the links

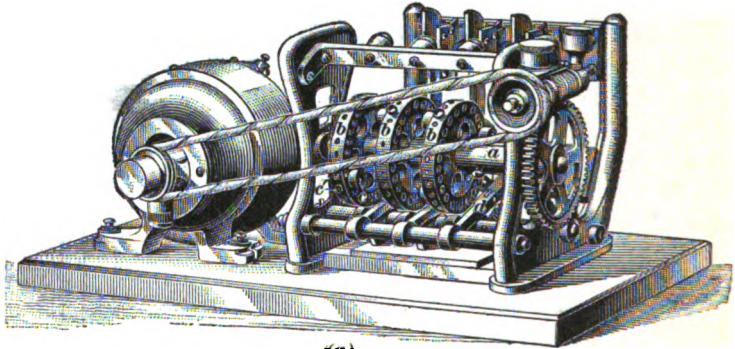

(a)

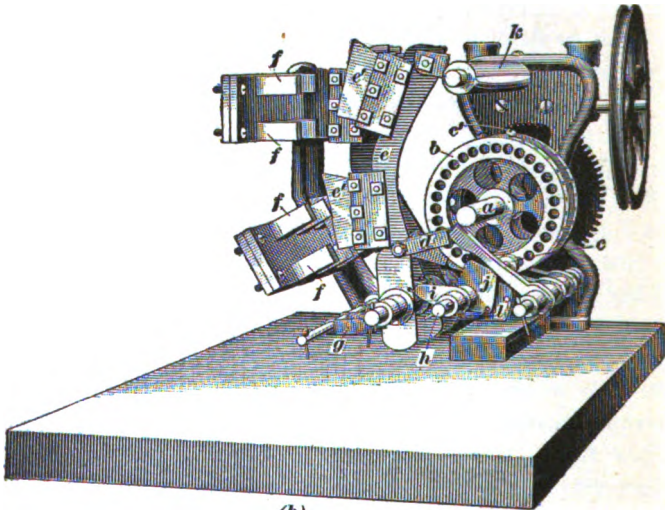

(b)

FIG. 15

out of line, when the spring *g* quickly pulls the switch open, a rubber bumper *k* taking up the jar. As soon as the roller has left cam *i*, the spring *l* pulls the cams back, so that the links are free to be forced down into line when the roller

next strikes them. The condition shown is that just after the switch has been opened and before the cams have snapped back into place.

18. The two blades e' , Fig. 15 (b), of each switch are insulated from the arm e that carries them. When the switch is closed, each blade makes contact with two clips f , as shown diagrammatically in Fig. 16. The upper clip of each pair is connected to the supply line, and the lower one to the lamp circuit. Each switch is therefore double pole.

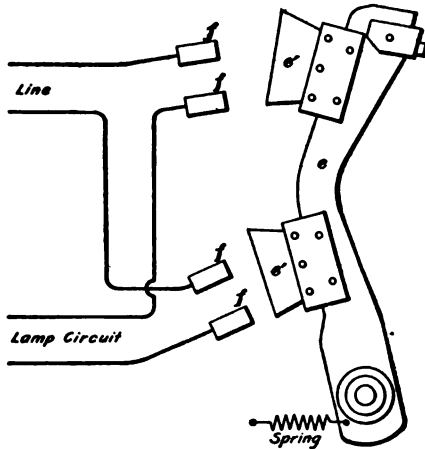

FIG. 16

19. **Single-Pole Flasher.**—Fig. 17 shows a portion of a smaller flasher that is single pole. The shaft a rotates and carries with it arms b, b' , etc. Arm b strikes against and raises a projecting switch arm c , and closes a switch against the

action of a heavy coiled spring d tending to open it. The switch is locked in the closed position by a hook on one end of a casting e , on the other end of which is an arm against which the arm b' strikes at the proper time, and thus tips the casting enough to release the switch and allow it to fly open. After the arm b' has passed, the hooked end of the casting is held up in position by a lighter coiled spring f , and is ready to catch the switch for the next operation.

20. **Time Switches.**—Fig. 18 shows the principal parts of an **automatic time switch**, consisting of an ordinary double-pole knife switch, with the handle at right angles to its ordinary position, and a device that opens the switch automatically at a set time. In the position ordinarily occupied

by the switch handle is a special casting having a lip *a* that hooks behind the end of a lever *b* and holds the switch closed against the action of a spring *c* that tends to open it. Above the switch is a shelf bearing two pedestals *d*; the shaft supported by the pedestals carries on one end a slotted rectangular block *e* and on the other end a cam *f*. An ordinary alarm clock is placed on the shelf between the springs *g*,

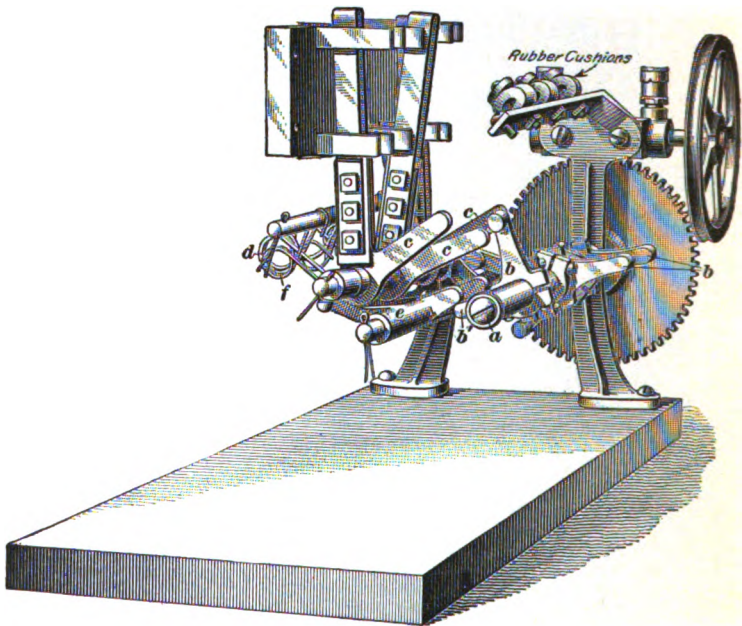

FIG. 17

so that the thumb piece for winding the alarm fits into the slot in the block *e*. When the alarm goes off, the thumb piece turns and causes the cam *f* to move the lever *b* enough to release the switch, which immediately flies open. A coiled spring *h* causes the lever *b* to return to its original position as soon as the pressure of the cam *f* is removed.

By the use of time switches, lamps may be left burning at night, to be automatically thrown off at any desired time. Similarly arranged switches are made both for closing and

for opening circuits, so that lamps can be made to light automatically at one hour and go out at another. These switches are useful for lighting the lamps of a sign or those

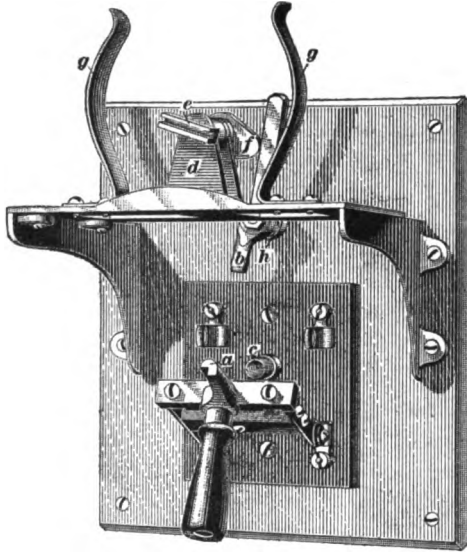

FIG. 18

in show windows on Sundays and holidays, and then extinguishing them after the travel by the store has nearly ceased for the night.

CHANGES IN DISPLAY

ELBLIGHT SYSTEM

21. There are in use many systems and devices by means of which the wording of a sign may be changed. The **Elblight system** consists of lighting boards, cables, and lamps with two-pin terminals.

The lighting boards are made by laying conductors *a, a*, Fig. 19, side by side parallel with each other, and so connecting them by suitable terminals to a source of electro-motive force that adjacent conductors will be of opposite

polarity. Between the conductors is insulation *b, b*. The conductors are stranded, and when the board is compressed they flatten out until they are separated by about $\frac{1}{8}$ inch of insulation.

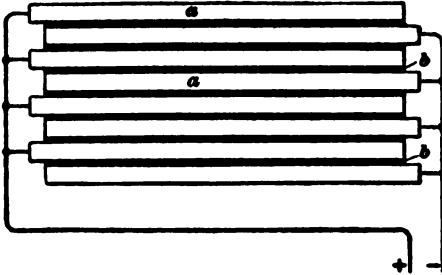

FIG. 19

22. The Elblight cables are made in a similar manner. Many strands of bare, fine copper wire are braided together as

a cable and insulated, two insulated cables being fastened side by side when in use, as shown in Fig. 20. Fig. 21 (a) shows a lamp for use with a lighting board, and (b) shows a method of fastening the lamps to the cables. The lamp bases are porcelain and the prongs phosphor-bronze. The braiding of the cable strands is such that under ordinary conditions the prongs are firmly held without the clamp. The insulation on the cable is of a high-grade rubber, so that holes formed by the lamp prongs close immediately when the prongs are withdrawn.

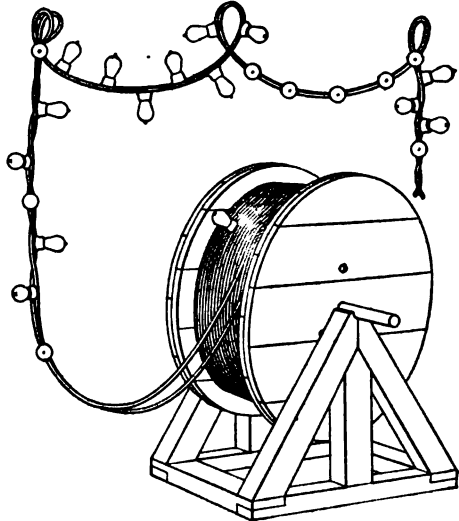

FIG. 20

All that is required to light lamps with either the board or the cable is to thrust the prongs through the insulation until they come in contact with the copper. In the board, the insulation between the

conductors usually consists of hard fiber or some other material that the prongs will not easily penetrate, so that short circuits are rare.

Lamps may be arranged on the board in the form of any letter, figure, or character desired and may be changed, without great expense, to any other design. The cable is more useful for electric ornamentation than for electric-sign work, as it may be draped or looped along the walls of a room or a building, wound around pillars and covered with evergreen, with lamps stuck in at intervals, etc.



FIG. 21

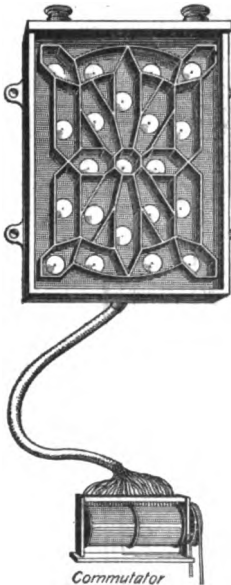

Commutator

FIG. 22

TALKING SIGNS

23. Monogram Letters.—Various other devices are in use by which the positions of the lamps in a sign may be changed so as to display different letters; but to make such changes requires considerable time and trouble. Fig. 22 shows a group of twenty-one lamps arranged in metal troughs, or boxes, whose inside surfaces are whitened with a vitreous substance like enamel, so that they reflect the light outwards. This device, including the lamps and boxes, is called a **monogram letter**, or simply a **monogram**; with it, by lighting different groups of lamps, may be displayed any letter of the alphabet. In

order to show any desired letter, it must be possible to control the lighting of each lamp independently of the others

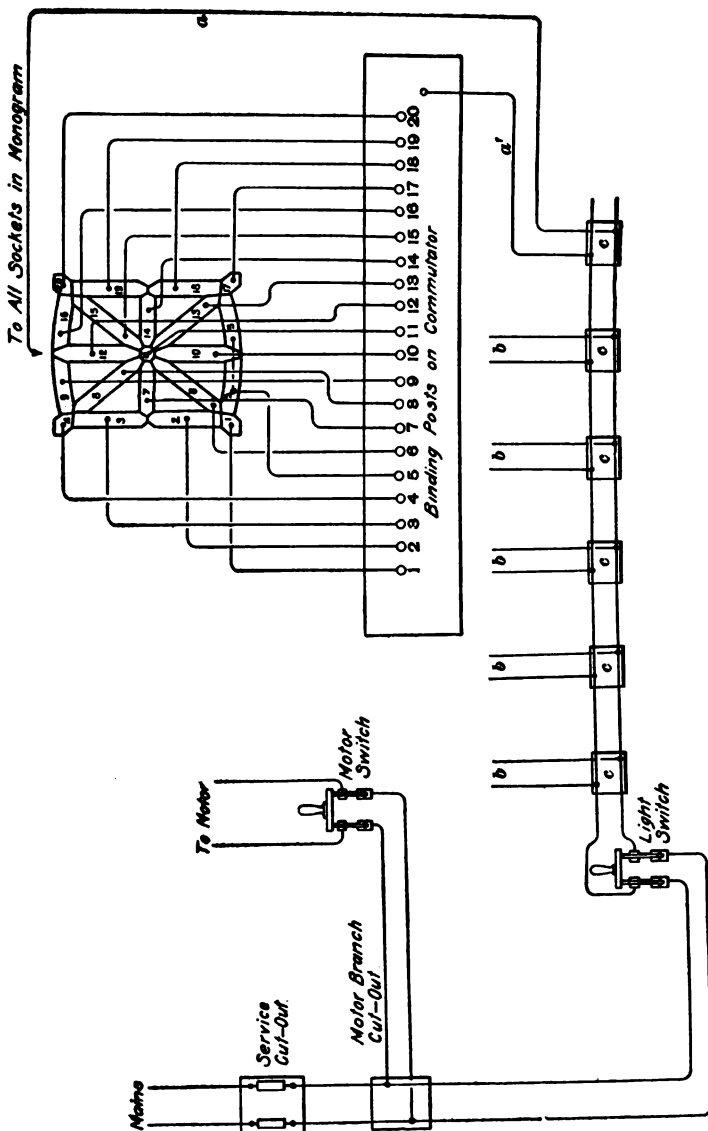

FIG. 28

(with one exception). This necessitates a separate wire from one side of each lamp socket to a suitable controlling device, but the other side of each socket is connected to a common wire that leads directly to the supply circuit. The controlling device, or *commutator*, automatically changes connections so as to display letters in any desired order.

24. Fig. 23 shows the complete wiring of one monogram, with the exception of the lamp connections of the wire *a* common to all lamp sockets; these connections are omitted for the sake of clearness. The individual wires from the lamps lead to a series of binding posts 1 to 20 on the commutator. The two lamps numbered 5 in the monogram

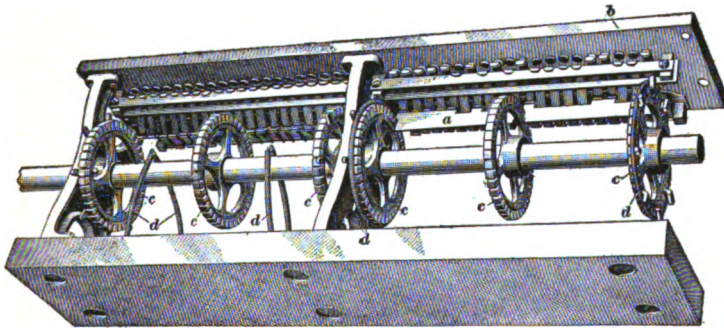

FIG. 24

are never lighted separately; hence, a common wire connects them with finger number 5 on the commutator. This is the exception previously referred to. Including the wire *a* common to all lamp sockets, there are twenty-one wire leading to each monogram. A wire *a'* connects the commutator with the side of the supply circuit opposite that with which the common wire *a* is connected. Circuits *b* lead to other monograms in the same sign; one wire of each circuit connects with one terminal of each lamp in a monogram and the other with the commutator belonging to that monogram. Each monogram circuit is connected to the supply circuit through double-pole cut-outs *c*. Another branch circuit leads to the motor that operates the commutator.

25. The commutator consists of a series of contact fingers, or springs, and a device for forcing them into a position where they close the circuits through the lamps. Fig. 24 is a view of two commutators, one having a letter bar *a* in position.

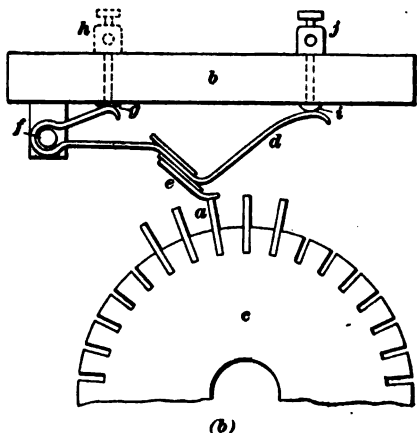
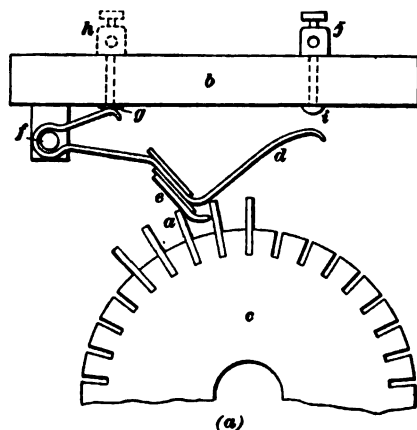

FIG. 25

The shaft is rotated by means of a motor, not shown, so that successive letter bars are brought under the fingers. On the left-hand commutator these springs are shown off the slotted wheels and hanging on the shaft. The shaft is rotated by means of a motor, not shown, so that successive letter bars are brought under the fingers.

26. Fig. 25 is a diagram showing a cross-section of the commutator; (a) shows a projection on a letter bar *a* just as it begins to raise a finger *d*, and (b) shows the finger raised to its full height. The letter bars do not make electrical contact with the fingers, but strike against metal shoulders *e* that are insulated from the fingers.

26. Fig. 25 is a diagram showing a cross-section of the commutator; (a) shows a projection on a letter bar *a* just as it begins to raise a finger *d*, and (b) shows the finger raised to its full height. The letter bars do not make electrical contact with the fingers, but strike against metal shoulders *e* that are insulated from the fingers.

The fingers are phosphor-bronze springs clasped loosely about a bar *f* running lengthwise of the commutator. When a finger is raised, one end makes firm contact with a brass strip *g* on the under side of the slate cover. A single binding post *h* in connection with this brass strip serves for the copper wire *a'*, Fig. 23, connecting the commutator to the supply circuit. The other end of the spring *d*, Fig. 25 (*b*), makes contact with the round head *i* of a binding post *j*, one

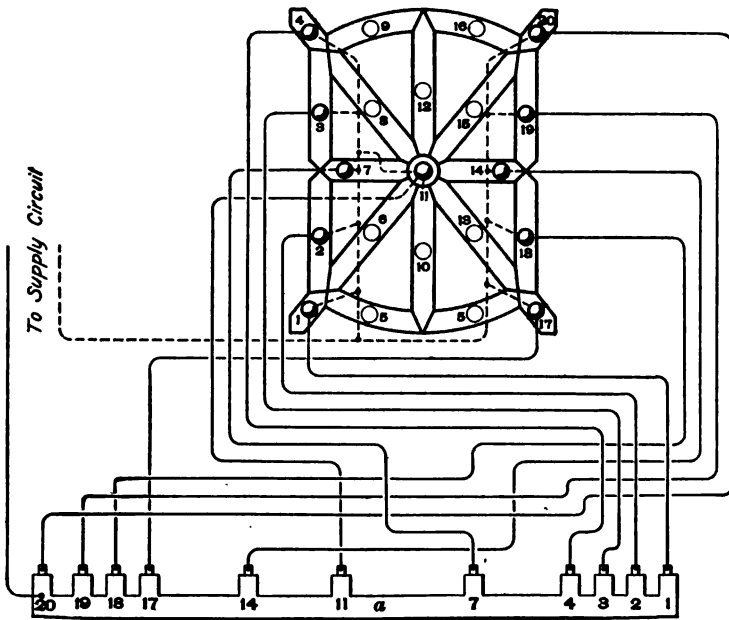

FIG. 26

of the twenty posts with which the lamps of the monogram are connected.

27. In Fig. 26 is shown a diagram of the connections that are active when the letter *H* is displayed. The letter bar *a* has projections that lift the fingers corresponding to the lamps needed. The lamps are numbered, and corresponding numbers are shown on the bar projections. This diagram represents conditions at one instant while the commutator is

turning; as this bar passes out from under the springs, all the lamps go out, but immediately another bar with other projections moves under and another letter is displayed.

28. Each commutator holds forty bars; hence, each monogram can be made to display forty separate characters. A number of monograms arranged side by side with all their commutators operated by a single motor constitutes a

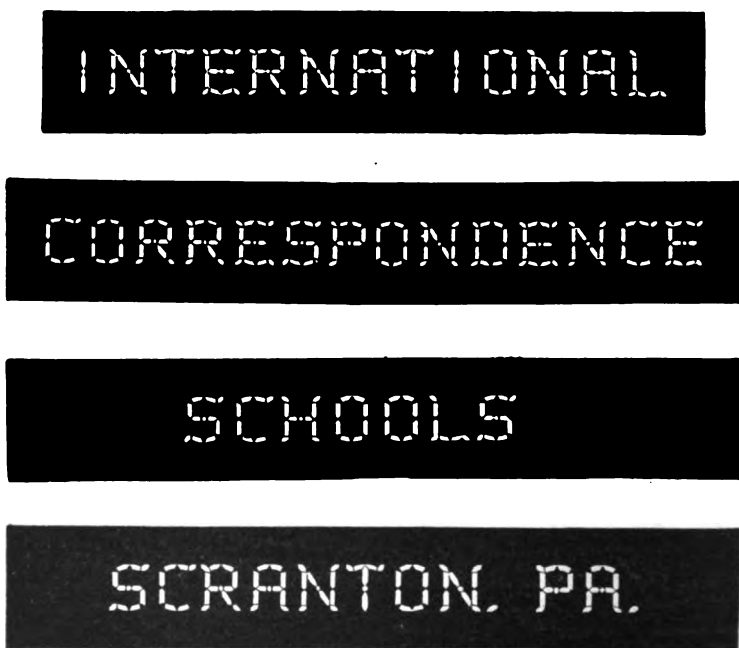
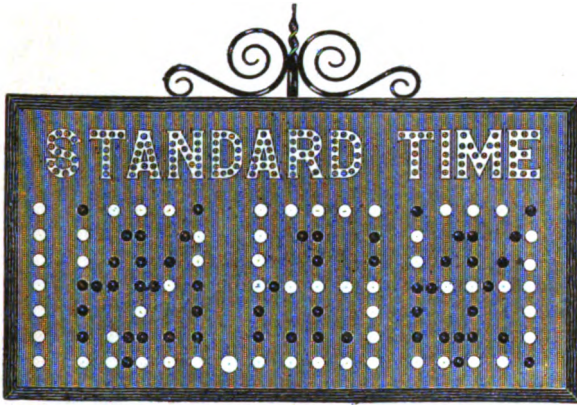

FIG. 27

talking sign, and may be made to flash forty words or sentences in succession. The same series of expressions may be flashed a whole evening without any supervision whatever from an attendant, or the attendant may substitute other bars as often as desired so that new expressions will be displayed. Fig. 27 shows four of the forty expressions one sign may be made to flash every night.

29. Talking Clock.—Fig. 28 shows an arrangement of electric lamps for displaying time; (a) and (b), respectively, show two successive displays. The lamps are differently arranged than in the letter monograms previously described,



(a)

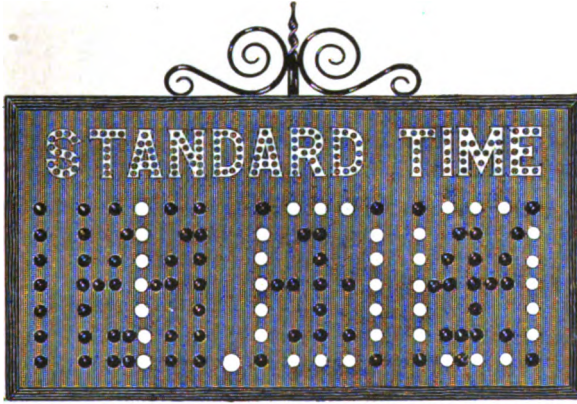

(b)

FIG. 28

and each group contains only the number of lamps needed for the figures it must display. For example, the first group displays only the figure 1, and hence contains but a single row of lamps; the second and fourth groups must

be capable of displaying any numeral from 0 to 9, inclusive, and the third group any numeral from 0 to 5, inclusive. A commutator operated in synchronism with the movements of a clock changes the contacts so that the time display is changed once every minute.

30. Carriage Calls.—Fig. 29 shows a carriage call that is very useful where a number of carriages are waiting

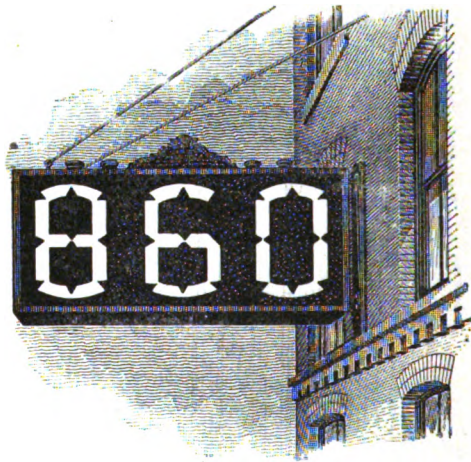

FIG. 29

for persons emerging from large assemblies, as at theaters. This call consists of three groups of lamps arranged in boxes with reflecting interiors and frosted-glass covers. The lighting of the lamps is controlled by a device somewhat similar to the commutator used with the talking sign, except that the carriage-call controlling device is operated by an attendant. Any number from 0 to 999, inclusive, may be displayed on the call shown. On arrival, each carriage occupant and driver is given a number, and when the carriage is wanted this number is displayed on the carriage call, which is in plain view of all the drivers.

ELECTRIC HEATING

HEATING EFFECTS OF ELECTRIC CURRENTS

1. When a current of electricity flows through a conductor, work is done proportional to the square of the current I , the resistance R of the conductor, and the time t ; that is, the work in joules is equal to $I^2 R t$, where I is in amperes, R in ohms, and t in seconds. All this work is converted into heat, which raises the temperature of the conductor and its surroundings.

In the generation and transmission of electricity, this production of heat is very undesirable and is avoided as much as possible by using conductors of low resistance or by transmitting the energy at high pressure and correspondingly low current. Ordinarily, in transmission work, the size of the conductors to be used is determined by the allowable pressure drop rather than by the heating effect, but it is sometimes necessary to consider the heating effect of electric currents. This is especially the case when wires are to be used in underground ducts, in molding, or other confined locations.

2. When the temperature of a wire is higher than that of its surroundings, heat escapes from the wire. A wire with a rough and blackened surface loses its heat more rapidly than one with a bright, shiny surface. Table I gives the heating effect of currents in bright and black wires, respectively, in still air. The figures in the body of the table are the diameters of the wires in mils. For example, to carry 1,000 amperes with a rise of 80°C . in still air requires a

Copyrighted by International Textbook Company. Entered at Stationers' Hall, London

TABLE I
HEATING EFFECTS OF CURRENTS
(Bare Copper in Still Air)

Amperes	Rise in Temperature. Degrees Centigrade							
	10		20		40		80	
	Bright	Black	Bright	Black	Bright	Black	Bright	Black
	Diameters of Wires. Mils							
1,000						968	911	750
950						930	878	723
900						893	844	695
850						858	809	666
800					1,000	823	771	638
750					950	785	734	610
700				960	900	748	696	580
650				910	850	708	660	550
600				858	800	668	621	518
575				833	775	648	603	503
550		995	980	808	750	628	583	488
525		978	948	780	725	607	563	461
500		960	913	751	700	584	543	455
475		925	880	723	675	563	523	439
450		895	843	696	648	541	501	421
425		860	808	669	620	520	479	406
400	1,000	820	770	641	592	498	457	387
375	950	783	731	612	564	475	435	369
350	900	745	690	581	536	452	413	350
325	850	708	654	550	506	428	390	331
300	800	668	615	519	475	403	366	312
275	750	628	575	487	444	377	341	292
250	696	586	534	453	412	351	317	272
225	642	545	494	419	379	323	291	252
200	586	500	453	384	345	296	265	229
175	530	454	406	349	310	266	239	208
150	470	404	360	311	274	226	210	194
125	408	352	308	270	235	206	182	161
100	343	300	258	226	195	170	150	135
90	315	272	237	208	178	158	137	123
80	286	246	214	196	161	143	124	112
70	259	220	190	170	143	127	110	100
60	226	194	167	150	125	112	97	87
50	191	167	142	130	106	95	82	74
40	156	140	117	108	86	78	68	61
30	120	111	90	85	66	60	54	48
20	82	76	63	60	45	44	40	36
10	40	38	37	35	30	28	26	24

TABLE II
HEATING EFFECTS OF CURRENTS
(Carrying Capacity of Insulated Wire in Moldings)

Amperes	Rise in Temperature. Degrees Centigrade								
	5	10	15	20	30	40	50	60	70
	Diameters of Wires. Mils								
300					446	411	386	367	354
280					427	393	369	350	338
260				450	409	375	352	333	321
240				430	390	356	333	315	304
220			436	408	370	337	315	298	285
200		448	414	386	350	317	295	280	268
190		437	403	375	339	308	286	270	258
180		425	391	364	328	298	277	260	249
170		411	378	352	317	287	266	250	239
160		398	364	340	305	276	256	241	229
150	445	383	351	326	293	265	244	230	218
140	431	370	338	312	281	253	232	220	206
130	417	354	322	300	269	240	220	208	195
120	400	339	308	285	255	228	208	195	182
110	383	322	292	270	240	214	195	182	170
100	362	302	276	253	223	200	182	168	158
90	343	284	259	237	208	185	168	154	143
80	322	264	240	218	192	169	153	139	130
70	300	242	220	198	174	152	139	123	116
60	275	220	195	175	155	135	122	108	101
50	250	195	175	152	132	118	104	91	86
40	217	169	144	128	110	95	85	75	70
30	178	136	115	100	85	73	66	58	54
20	132	100	71	69	59	50	45	40	37
10	78	58	42	35	30				

TABLE III
DIAMETERS OF WIRES OF VARIOUS MATERIALS
THAT WILL BE FUSED BY A CURRENT OF
GIVEN STRENGTH

(W. H. Preece, F. R. S.)

Current. Amperes	Diameters. Inch								
	Copper	Aluminum	Platinum	German Silver	Platinoid	Iron	Tin	Tin-Lead Alloy	Lead
1	.0021	.0026	.0033	.0033	.0035	.0047	.0072	.0083	.0081
2	.0034	.0041	.0053	.0053	.0056	.0074	.0113	.0132	.0128
3	.0044	.0054	.007	.0069	.0074	.0097	.0149	.0173	.0168
4	.0053	.0065	.0084	.0084	.0089	.0117	.0181	.021	.0203
5	.0062	.0076	.0098	.0097	.0104	.0136	.021	.0243	.0236
10	.0098	.012	.0155	.0154	.0164	.0216	.0334	.0386	.0375
15	.0129	.0158	.0203	.0202	.0215	.0283	.0437	.0506	.0491
20	.0156	.0191	.0246	.0245	.0261	.0343	.0529	.0613	.0595
25	.0181	.0222	.0286	.0284	.0303	.0398	.0614	.0711	.069
30	.0205	.025	.0323	.032	.0342	.045	.0694	.0803	.0779
35	.0227	.0277	.0358	.0356	.0379	.0498	.0769	.089	.0864
40	.0248	.0303	.0391	.0388	.0414	.0545	.084	.0973	.0944
45	.0268	.0328	.0423	.042	.0448	.0589	.0909	.1052	.1021
50	.0288	.0352	.0454	.045	.048	.0632	.0975	.1129	.1095
60	.0325	.0397	.0513	.0509	.0542	.0714	.1101	.1275	.1237
70	.036	.044	.0568	.0564	.0601	.0791	.122	.1413	.1371
80	.0394	.0481	.0621	.0616	.0657	.0864	.1334	.1544	.1499
90	.0426	.052	.0672	.0667	.0711	.0935	.1443	.1671	.1621
100	.0457	.0558	.072	.0715	.0762	.1003	.1548	.1792	.1739
120	.0516	.063	.0814	.0808	.0861	.1133	.1748	.2024	.1964
140	.0572	.0698	.0902	.0895	.0954	.1255	.1937	.2243	.2176
160	.0625	.0763	.0986	.0978	.1043	.1372	.2118	.2452	.2379
180	.0676	.0826	.1066	.1058	.1128	.1484	.2291	.2652	.2573
200	.0725	.0886	.1144	.1135	.121	.1592	.2457	.2845	.276
225	.0784	.0958	.1237	.1228	.1309	.1722	.2658	.3077	.2986
250	.0841	.1028	.1327	.1317	.1404	.1848	.2851	.3301	.3203
275	.0897	.1095	.1414	.1404	.1497	.1969	.3038	.3518	.3417
300	.095	.1161	.1498	.1487	.1586	.2086	.322	.3728	.3617

bright wire 911 mils in diameter, but a black wire of only 750 mils diameter will carry the same current with the same temperature rise. Table II gives the heating effects of electric currents in insulated wires used in moldings. Heat escapes more readily from a wire to its insulation and the moldings than from a bright, bare wire to still air; for

TABLE IV
CARRYING CAPACITY OF GERMAN-SILVER WIRE

Number B. & S.	Circular Mils	Maximum Current Amperes	Feet per Ohm
10	10,381	6.8	60.90
11	8,234	5.7	47.60
12	6,529	4.8	37.80
13	5,178	4.0	29.90
14	4,106	3.4	23.70
15	3,257	2.8	18.80
16	2,583	2.4	14.90
17	2,048	2.0	11.80
18	1,624	1.7	9.40
19	1,288	1.4	7.25
20	1,021	1.2	5.91
21	810	1.0	4.69
22	643	.83	3.72
23	509	.70	2.95
24	404	.59	2.33
25	320	.49	1.85
26	254	.42	1.47
27	201	.35	1.16

example, according to Table I, to carry 300 amperes with 40° C. temperature rise in still air requires a bright wire 475 mils in diameter, while according to Table II an insulated wire in molding to do the same thing need be only 411 mils in diameter.

3. Table III gives the currents that will just fuse, or melt, wires of different materials. The fusing effect of a

current depends on the readiness with which heat can escape from the wire. If a very short wire is clamped between terminals, heat will escape to the terminals; if a fuse is installed where air circulates freely, the air-currents will carry away heat, etc. For these reasons, fuses must be of sufficient length so that the heat imparted to the terminals cannot appreciably change the melting point; they must also

TABLE V
CARRYING CAPACITY OF GALVANIZED-IRON WIRE

Number Washburn & Moen Gauge	Circular Mils	Maximum Current Amperes	Feet per Ohm
3	59,536	51.5	645.0
4	50,625	45.5	549.0
5	42,849	40.0	463.0
6	36,864	35.5	398.0
7	31,329	31.3	337.0
8	26,244	27.5	283.0
9	21,904	23.8	236.0
10	18,225	20.6	196.0
11	14,400	16.9	155.0
12	11,025	13.5	119.0
13	8,464	10.7	91.4
14	6,400	8.4	69.1
15	5,184	7.1	56.0
16	3,969	5.7	42.8
17	2,916	4.3	31.4

be installed where air-currents cannot affect them. Fuses, therefore, are usually 1 inch or more long and are enclosed.

In the absence of air, a conductor will carry a much larger current without fusing than if air is present. For this reason, in rheostats and electric-heating apparatus, where a high current density in the conductors or an intense heat is desirable, the wire is embedded in cement, enamel, or other substance, which not only insulates the conductors, but also

excludes the air from around them. The incandescent lamp affords an example of the advantage of excluding air from a highly heated conductor. If even a very small quantity of air remains in a lamp globe, the life of the lamp will be

TABLE VI
CARRYING CAPACITY OF TINNED-IRON WIRE

No. B. & S.	Area Circular Mils	Maximum Safe Current With Wooden Frame Amperes	Maximum Safe Current With Iron Frame Amperes	Safe Current for 1 Minute	Feet per Ohm	Pound per Foot	Ohms per Inch of a Spiral Wound on $\frac{1}{4}$ -Inch Mandrel
8	16,509	17.40	20.30	43.6	250.00	.04000	.0050
9	13,094	14.60	17.10	36.6	173.00	.03300	.0066
10	10,381	12.30	14.30	30.8	137.00	.02751	.0095
11	8,234	10.30	12.00	25.8	108.00	.02182	.0131
12	6,529	8.70	10.10	21.7	86.40	.01730	.0182
13	5,178	7.30	8.50	18.3	68.50	.01372	.0245
14	4,106	6.10	7.10	15.3	54.30	.01089	.0353
15	3,257	5.10	6.00	12.9	43.10	.00863	.0492
16	2,583	4.30	5.00	10.8	34.10	.00685	.0690
17	2,048	3.60	4.20	9.1	27.10	.00543	.0960
18	1,624	3.00	3.50	7.6	21.40	.00430	.1345
19	1,288	2.50	2.90	6.3	16.50	.00341	.1963
20	1,021	2.20	2.50	5.4	13.50	.00271	.2636
21	810	1.80	2.10	4.5	10.70	.00231	.3725
22	643	1.50	1.77	3.8	8.49	.00184	.5220
23	509	1.30	1.49	3.2	6.73	.00146	.7350
24	404	1.08	1.20	2.3	5.34	.00116	1.035

much shortened; and if the filament were in open air, it would immediately be consumed.

4. The resistance wire in rheostats and in electric-heating apparatus, if properly protected from the air, may be

operated at red heat without material injury; but this is seldom done, because it is difficult to maintain good insulation at such high temperatures, and, moreover, such intense heat in these appliances is seldom necessary. Tables IV, V, and VI give the safe carrying capacities of various materials used for rheostats and electric-heating appliances. These figures are for continuous service in open air; for intermittent service, as in motor-starting rheostats, or for service in the absence of air, considerably more current can be carried safely, as indicated by the fifth column in Table VI.

APPLICATIONS OF ELECTRIC HEAT

GENERAL CONSIDERATIONS

5. Advantages.—In the electrical devices thus far considered, the development of heat has been an undesirable incident rather than an object. Under some conditions, however, it becomes highly desirable and possibly economical to convert electricity into heat. Some of the advantages of electric heat are as follows: (1) Its instant availability on closing a switch; (2) its perfect control, as heat may be obtained by its use in almost any intensity desired; (3) its perfect adaptability, as it may be applied to the exact location desired and in such a way that only very little heat escapes to the surrounding air or other objects; (4) the absence of smoke, flame, dust, poisonous gases, etc.; (5) the absence of fuel, ashes, etc. to be handled, or fires to be maintained; (6) the decreased danger from fire or explosions.

6. Effect on Central Station.—The applications of electric heat are very numerous, and fortunately for the interests of central-station owners and managers, most of these applications call for electric power during those hours when the station and the transmission system are not otherwise loaded to their full capacity. The addition of a *day load* to an ordinary lighting station is a source of considerable

profit to the station, inasmuch as such a load calls for no additional investment in generating equipment or in transmission lines, but permits the use of apparatus already installed at more nearly a constant load. With a good day load of motors or heating apparatus, engines and generators that would otherwise be idle and useless all day may be kept running at a considerable profit.

It is evident, then, that a station can afford to sell power during its periods of light load cheaper than during its maximum load, or, as commonly called, its *peak of load*; and many stations, in order to encourage a day load, offer special rates or other inducements for the use of motors, heating appliances, etc. that are ordinarily in use only during the day. Central-station managers should therefore be familiar with all electrical devices that may add to day loads, and should lose no opportunity to impress the public with the advantages to be obtained by the use of electricity. Electric heating presents a very promising field for such work.

7. Relative Costs.—The greatest arguments in favor of electric heating are its convenience and cleanliness; these in many cases are sufficient to overbalance the objection of increased cost. The relative cost of heating by electricity and by burning coal or gas depends on the continuity of the service required, as well as on the relative prices of electric power and of fuel. If a small amount of heat is required intermittently for short periods only, as for heating flat irons, it may prove more economical to use an iron that is heated electrically rather than to maintain a fire in a range, with its great waste of heat. In any case, it has been found that electric power at $2\frac{1}{2}$ cents per kilowatt-hour is about equal to gas at \$1 per thousand feet, and that for cooking and miscellaneous heating, electric power at 4 to 5 cents per kilowatt-hour can compete successfully with coal at from \$6 to \$7.50 per ton.

THAWING FROZEN WATER PIPES

8. General Method.—The process of thawing frozen water pipes by electricity consists simply in sending through the pipe a current of electricity large enough to heat it. Alternating current is generally used, because almost any current strength desired can be easily obtained. In cities and towns where the winters are severe, many of the central stations provide special transformers, each having a secondary winding of a few turns of very heavy copper capable of carrying large currents. A transformer, together with the necessary cables, terminal clamps, measuring instruments, rheostats, etc., is mounted on a wagon or sled, and one or more such outfits are kept in almost continuous use through the freezing weather.

When a request is made for the services of the pipe-thawing outfit, it is hauled to the desired place, the terminals of the primary coil connected to the high-voltage lighting circuit, the terminals of the secondary coil to the frozen section of the pipe, one at each end, and an electric current of the proper strength turned on. The current strength should be suitable for the work to be performed; a large pipe of low resistance will require a larger current than a small pipe. Too large a current may injure the pipe; hence, it is better to use a more moderate current for a longer period of time. The length of time required to produce running water in pipes that are frozen solid varies inversely as the square of the current used.

9. Pipe-Thawing Data.—Table VII gives figures obtained in practice, showing the diameters and lengths of frozen pipes, and the amperes, volts, and time required to produce running water in each size. These results are probably a fair sample of what will always be obtained in practice, but are too inconsistent to permit the making of definite rules to be followed in all cases. For example, a 1-inch pipe 700 feet long embedded in solidly frozen ground required 175 amperes for 5 hours, while another pipe of the

TABLE VII
PIPE-THAWING DATA

Diameter Inches	Length Feet	Material	Amperes	Volts	Time Minutes
$\frac{1}{2}$	50	Lead	250	15	5
$\frac{1}{2}$	50	Iron	250	20	5
$\frac{1}{2}$	70	Iron	300	16	15
$\frac{1}{2}$	100	Iron	150	20	45
$\frac{5}{8}$	180	Lead	185	35	15
$\frac{3}{4}$	40	Iron	300	50	8
$\frac{3}{4}$	60	Iron	320	110	25
$\frac{3}{4}$	75	Iron	100	50	5
$\frac{3}{4}$	80	Iron	300	110	23
$\frac{3}{4}$	100	Iron	135	55	10
$\frac{3}{4}$	100	Iron	300	110	11
$\frac{3}{4}$	150	Lead	250	50	12
$\frac{3}{4}$	200	Iron	110	50	6
$\frac{3}{4}$	200	Iron	120	50	1
$\frac{3}{4}$	240	Iron	250	52	30
$\frac{3}{4}$	250	Iron	120	50	10
$\frac{3}{4}$	250	Iron	400	50	20
$\frac{3}{4}$	380	Iron	300	30	10
1	45	Iron	140	220	17
1	90	Iron	280	110	10
1	100	Iron	175	220	15
1	150	Iron	200	40	20
1	150	Iron	280	110	120
1	220	Iron	60	105	75
1	250	Iron	400	50	20
1	250	Iron	500	50	20
1	600	Iron	60	50	60
1	700	Iron	175	55	300
$1\frac{3}{4}$	130	Iron	340	110	90
2	20	Iron	2,000	6	180
2	50	Iron	500	50	120
2	60	Iron	160	50	4
2	300	Iron	250	52	150
4	800	Iron	300	50	180
6	400	Iron	800	110	70
8	700	Iron	1,000		2,400

same diameter and 600 feet long, but much less solidly frozen, required only 60 amperes for 1 hour. It is very seldom that an ordinary house pipe requires more than from 30 to 50 volts and 300 amperes.

10. Thawing Transformers.—The **thawing transformer** should be compact and easily portable. If specially designed, the transformer usually has a large magnetic leakage, so that with heavy secondary currents there will be a considerable drop of voltage; in fact, such a transformer may be short-circuited for several minutes without injury. This design makes the transformer so bulky that it is used only for work requiring fairly low secondary voltages; for higher voltages, an ordinary lighting transformer with a choke coil in series is used. The choke coil accomplishes the same object as the magnetic leakage in the special transformers.

11. Connections.—There should be very little resistance in the secondary circuit; that is, the secondary mains

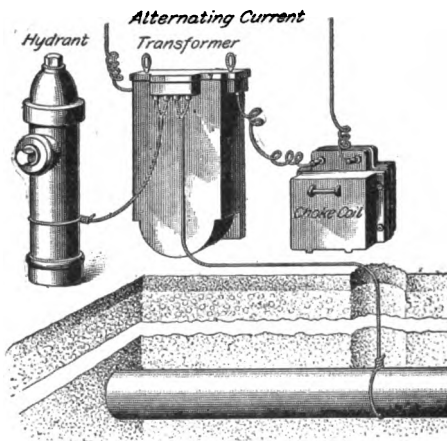

FIG. 1

should be short, and all contacts should be made secure. In thawing house piping, one secondary lead is usually connected to a faucet and the other to the pipe where it enters the house, to a hydrant, or to a faucet in a neighboring house, the object being to send the current through all the frozen section. In thawing street mains, connections may be made to two hydrants or to one hydrant and the pipe beyond the frozen section, as shown in Fig. 1.

WELDING

12. Thomson Welding Process.—By the ordinary process of welding, two pieces of metal are heated to the proper welding temperature and then, while still hot, are hammered together as one piece. Many welding operations that would be very difficult by this process may be easily performed by aid of electric current; that is, by the process of electric welding.

The Thomson welding process, which is more widely used than any other, is illustrated in Fig. 2. Alternating current is used for the same reason as given for its use in thawing frozen water pipes; namely, because a large current at a low voltage is thereby easily obtained. The current from an alternator *a* flows through the primary coil *d* of a transformer *b* by way of a switch *o*. A regulator *r*—preferably an adjustable reactance coil, though an adjustable resistance could be used—enables the primary current to be adjusted as desired. The laminated core *c* passes through both the primary coil *d* and the secondary coil *e*. The secondary coil consists of a very few turns, sometimes only one, of heavy copper, and has its terminals connected to the water-cooled clamps *f, g* holding the pieces *l, m* to be welded. Handles *h, k* operate the cams, by which pieces *l, m* are clamped. One clamp is movable, so that the pieces may be forced together when hot enough; this is sometimes done by hand and sometimes automatically by air pressure, weights, or springs.

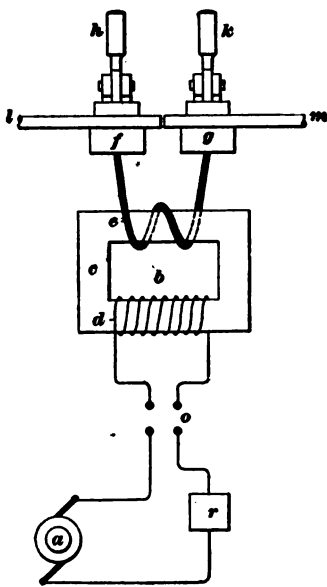

FIG. 2

13. Only a very low voltage is needed in the secondary circuit, but a current as high as 60,000 amperes per square inch may be necessary in welding some metals, as for example, copper. A low frequency, 50 cycles or less is preferred, especially for heavy work where the current density is very great, because high frequency together with high-current density causes high-inductive effect with a corresponding reduction of the power factor of the system.

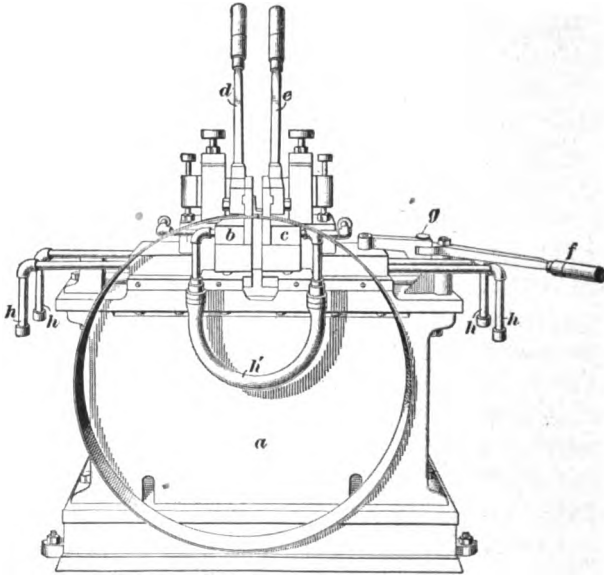

FIG. 3

14. Fig. 3 shows a Thomson welder for miscellaneous work up to 6-square-inch cross-section. A flat iron hoop is shown in position for welding, but different forms of clamps permit the handling of a variety of work. The transformer is contained in the base *a* of the welder, and the work is held by clamps *b, c*, operated by handles *d, e*. A lever *f* and a toggle *g* serve to force the clamp *c* toward *b* when the proper heat is attained. Water is circulated through the clamps by means of pipes *h, h', h*. The pipe *h'* is a piece of rubber hose, which affords the necessary flexibility and also

prevents the passage of current between the clamps by way of the pipe. The current can pass from one clamp to the other either by crossing the joint to be welded or by going around the unjointed portion of the hoop; much the larger portion takes the shorter path across the joint between the clamps and heats the abutting ends of the hoop. The welder just described is a simple type; for some special work, welders are used in which hydraulic pressure is applied and regulated automatically.

15. Welding Transformer.—In Fig. 4 is shown one style of welding transformer that will illustrate the principles of all. This transformer has two laminated cores, one of

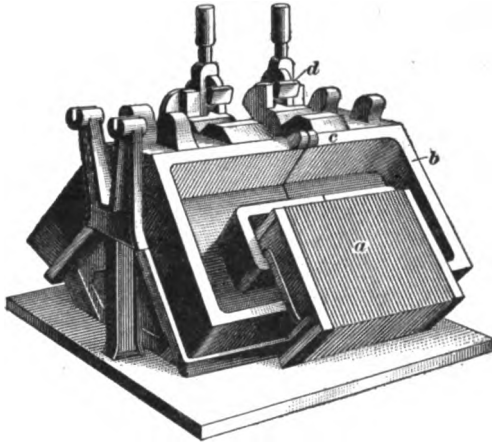

FIG. 4

which is shown at *a*. Linked with each core is a heavy copper casting *b* that forms the secondary winding of only one turn. A slit *c* between the clamps *d* compels the secondary current to pass through the work held between the clamps. The primary coil is not shown in the figure, but its place is in the recess shown in the secondary casting. In such a transformer there can be only very little magnetic leakage, and the secondary current may be very large. The secondary circuit of a welding transformer may take any form most convenient for clamping and holding the work.

TABLE VIII
POWER REQUIRED FOR ELECTRIC WELDING

Iron and Steel			Brass				Copper							
Distance Between Clamps = 2 X Diam.			Distance Between Clamps = 3 X Diam.				Distance Between Clamps = 4 X Diam.							
Area Square Inches	Watts in Primary of Welders	Time in Seconds	Horsepower Applied to Dynamos	Foot-Pounds	Area Square Inches	Watts in Primary of Welders	Time in Seconds	Horsepower Applied to Dynamos	Foot-Pounds	Area Square Inches	Watts in Primary of Welders	Time in Seconds	Horsepower Applied to Dynamos	Foot-Pounds
.5	8,550	33	14.4	260,000	.25	7,500	17	12.6	117,000	.125	6,000	8	10.0	44,000
1.0	16,700	45	28.0	692,000	.50	13,500	22	23.2	281,000	.250	14,000	11	23.4	142,000
1.5	23,500	55	39.4	1,191,000	.75	19,000	29	31.8	508,000	.375	19,000	13	31.8	227,000
2.0	29,000	65	48.6	1,738,000	1.00	25,000	33	42.0	760,000	.500	25,000	16	42.0	369,000
2.5	34,000	70	57.0	2,194,000	1.25	31,000	38	52.0	1,087,000	.625	31,000	18	51.9	513,000
3.0	39,000	78	65.4	2,804,000	1.50	36,000	42	60.3	1,390,000	.750	36,500	21	60.6	700,000
3.5	44,000	85	73.7	3,447,000	1.75	40,000	45	67.0	1,659,000	.875	43,000	22	72.1	872,000
4.0	50,000	90	83.8	4,148,000	2.00	44,000	48	73.7	1,947,000	1.000	49,000	23	82.1	1,039,000

16. Power Required for Electric Welding.—The time required for making a weld varies inversely with the amount of power supplied; that is, the greater the power the shorter the time, and the less the power the longer the time. Metals that are deteriorated by being heated, such as copper, brass, and tool steel, must be welded rapidly. The pressure must be great enough to crowd out from the weld all metal harmed by the heat.

Table VIII, given by the Thomson Electric Welding Company, shows the power required for welding iron, copper, and brass of varying cross-sections. Tests have shown that from 70 to 75 per cent. of the power supplied is actually used in making the weld, so that there is comparatively little heat wasted. Although there is a great loss of heat in the steam engine, and also some loss in the dynamo, it has been found that the fuel cost for electric welding is but little more than for welding by the ordinary process, because in the electric process, nearly all the heat is applied just where it is wanted.

17. Advantages.—Electric welding is especially adapted to intermittent work and to making welds where it would be very difficult to apply the heat by any other method. When metals are heated by electric current, the central part gets hot first; hence, electric welds are solid throughout. Welds made by the external application of heat are often imperfect in the center, leaving the joint weak.

18. Rail Welding.—A special application of the Thomson welding process is the joining of steel rails, thus making the track one continuous piece. When rails are surrounded by paving, it has been found that they can be joined in this way without being thrown out of line by the expansion and contraction due to heat and cold. Before the weld is made, the surfaces to be welded are thoroughly cleaned either by grinding or by means of a sand blast.

A special form of welder is suspended from a boom carried by a car designed for the purpose; the contacts of the welder are brought against opposite sides of the rail, and, by

means of the current, two pieces of iron are welded on at the joint, one piece on each side. When the pieces have been heated to a welding heat, pressure is applied by means of a hydraulic jack. A joint made in this manner on a 70-pound rail will stand a strain of 279,000 pounds, whereas the maximum strain placed on the rail on account of variations in temperature is 150,000 pounds.

The current for welding is obtained from a transformer, the primary of which is supplied from a rotary converter that takes direct current at 500 volts from the trolley line and converts it to about 300 volts alternating. The average current supplied to the primary of the transformer during a welding operation is about 650 amperes. The electrical conductivity of the joint is as great as that of the rail itself, and under proper conditions four joints per hour can be made.

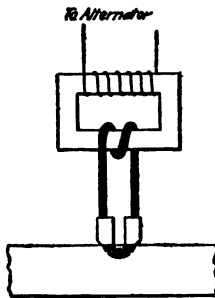

FIG. 5

ANNEALING

19. **Electric annealing**, another application of electric heating, is a process by which parts of steel plates or castings on which it is desired to perform machine work are softened. The heavy secondary terminals of a special transformer are placed on the part to be softened, as shown in Fig. 5, and a large current sent through it. The part is thereby heated and softened, but other parts of the casting are not affected.

ELECTROLYTIC FORGE

20. An **electrolytic forge**, or **tempering bath**, consists of a metallic-lined vessel containing water or a suitable solution. The solution is made the positive electrode of a direct-current dynamo, while a piece of metal to be heated is made the negative electrode. Fig. 6 illustrates the device; the piece of metal *a* rests on a contact bar *c*, to which the negative side of the circuit is connected, and extends into

the liquid *b*. The vessel *c* has a metal lining *d*, to which the positive side of the circuit is connected.

When the metal is plunged into the liquid and touched to the rod *e*, a current begins to flow through the liquid to the rod and a layer of hydrogen gas immediately forms around the submerged portion. The gas introduces so much resistance between the metal and the liquid that intense heat is

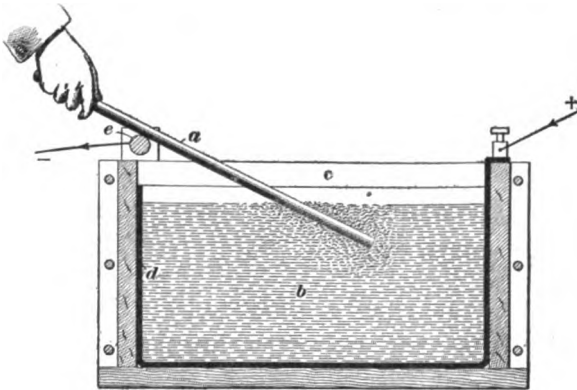

FIG. 6

developed at the surface of the metal. By adjusting the strength of the current and the time it is allowed to flow, any required degree of heat can be obtained, even to melting the metal. This is called the **Hoho process**, after its discoverer, Paul Hoho. In a modification of the process, the metal is brought in contact with only the surface of the liquid, and the liberated hydrogen is burned, thus helping to raise the temperature of the metal.

21. By the Hoho process, metals may be tempered with a great degree of accuracy. The current may be adjusted until the submerged portion of the metal is at the proper temperature and then shut off, leaving the metal in contact with cold water or tempering solution and thus tempering it. Any composition it is desired to use in tempering may be dissolved in the liquid. The heating is under such perfect control that the tempering may be carried to any desired depth from the surface of the metal. Suitable insulating

shields placed over portions of the metal prevent the development of heat on surfaces that are not to be tempered. Large surfaces, such as the wearing surfaces of steel rails, steel axles, shafting, cannon, etc., may be tempered by exposing small portions at a time to the action of the current and the tempering bath, the remaining portions being covered with shields.

By the Hoho process, metals are heated in an envelope of hydrogen gas, which prevents oxidation and thus makes this process very desirable for all operations where oxidation is objectionable. Soldering is one such operation, and metals that are very difficult to solder by any other process can be easily soldered by using an electrolytic forge.

FURNACES

22. When current is made to flow across an air gap between two electrodes, an *electric arc*, a bow-shaped flame of great brilliancy and intense heat, is produced. The temperature of the electric arc is the highest attainable, being in the neighborhood of $3,500^{\circ}$ C.; and in an electric furnace, in which the arc is confined in an enclosed space, any known

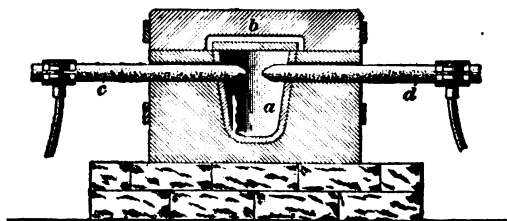

FIG. 7

substance can be melted or vaporized. Carbon is nearly always used for electrodes, as it will best withstand the heat.

Fig. 7 shows a simple form of electric furnace, consisting of a crucible *a* of refractory material surrounded by firebrick and covered by a fireclay slab *b*. Carbon rods *c*, *d* enter from each side and form the electrodes. The arc is started either by sliding one carbon in until it touches the other and then

withdrawing it, or by placing a very small carbon rod, say about $\frac{1}{16}$ inch in diameter, between the carbon points before turning on the current; when the current is turned on, the small rod will very soon burn out and the arc will start.

In some furnaces, the crucible, or containing vessel, is made of carbon and forms one electrode. Many styles of electric furnaces are in use in electrometallurgical and electro-smelting work. They enable the production of high temperatures in very confined spaces and without the admission of air.

AIR AND WATER HEATING

AIR HEATING

23. It requires an expenditure of 18 watts (18 joules per second) to raise the temperature of 1 cubic foot of air 1° F. per second. From this may be calculated the exact power required to raise the temperature of a room a definite amount, provided the room is tightly closed and has non-conducting walls so that no heat can escape. If the room is ventilated, or if the walls conduct heat readily and the rate at which heat escapes cannot be determined, it is impossible to calculate the amount of heat required to raise the temperature to a given point or to maintain it after being raised. Less heat is required to maintain the temperature of a room at a given value than to raise it to that value from a lower one; also, the quantity required for such maintenance is inversely proportional to the amount of ventilation and to the temperature of the outside air.

EXAMPLE.—It is desired to raise the temperature of an electric oven 6 ft. \times 10 ft. \times 8 ft., inside dimensions, from 60° to 175° F. in $\frac{1}{2}$ hour, the heaters being supplied with current at 500 volts. (a) Assuming that no heat is lost, what will be the total current required to heat the oven? (b) If two heaters are used in parallel, what will be the resistance of each?

SOLUTION.—(a) The cubical contents of the oven is $6 \times 10 \times 8 = 480$ cu. ft. The total rise of temperature is $175 - 60 = 115^{\circ}$ F., and at 18 joules per cu. ft. for each degree, there would be required for 1 sec.

$18 \times 480 \times 115 = 993,600$ joules. Since this energy is to be expended in $\frac{1}{2}$ hr., or 1,800 sec., the joules per sec., or the watts, must be $993,600 \div 1,800 = 552$; and the current at 500 volts is $552 \div 500 = 1.104$ amperes. Ans.

(b) The current taken by each heater is $1.104 \div 2 = .552$ ampere, and the resistance of each heater by Ohm's law, $R = \frac{E}{I}$, is $\frac{500}{.552} = 906$ ohms, nearly. Ans.

In the foregoing example and solution no account is taken of the heat absorbed by the walls of the oven or of that which escapes to the outside air. The quantity of heat actually required would be considerably greater than indicated by the estimates just stated; in practice, it is best, in case the exact quantity has not been experimentally determined, to install with each heater a regulator by means of which the current can be adjusted to suit the requirements.

24. Luminous Radiator.—Every electrical device in which there is any considerable expenditure of energy gives off heat to the surrounding air, even though the device is not intended for this purpose. About 97 per cent. of the energy



FIG. 8

expended in electric lamps is converted into heat. This fact has been made use of in the manufacture of **luminous radiators**, such as shown in Fig. 8. Three or more large incandescent lamps, especially designed for the production of heat rather than light, are assembled in an ornamental cast-iron casing. Back of the lamps is a polished copper reflector, which throws most of the heat out in front of the heater.

These devices are made in two sizes, consuming, respectively, 750 and 1500 watts on either 110- or 220-volt circuits.

25. Car Heater.—A type of car heater, for use with direct current only, is shown in Fig. 9. The resistance wire

is wound in a long helix with a central flexible insulated cord *a*. The helix is looped over porcelain insulators attached to opposite sides of steel strips *b*, and the whole is protected from

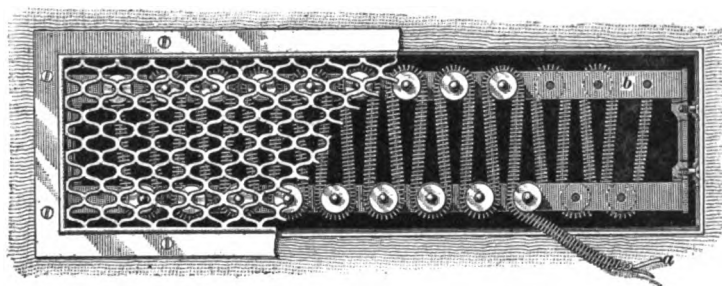

FIG. 9

accidental contact with persons or clothing by suitable gratings. This style of heater is unsuitable for alternating current on account of the high self-induction of such a winding. Many other types of air heaters are in use for electric-car heating.

26. Economy.—At the prices usually charged for energy, the cost of heating by means of electric air heaters is too high to make them economical for continuous use in heating dwelling houses and living rooms; but for removing the dampness from living rooms during the summer and for use for short periods only during the cool days of late spring or early fall, they are practicable.

WATER HEATING

27. It has been found by careful measurement that the conversion of 778 foot-pounds of work into heat will produce exactly the quantity of heat required to raise the temperature of 1 pound of water 1° F.; hence, 778 foot-pounds is called the *mechanical equivalent of heat*. There is .737 foot-pound in 1 joule; hence, the mechanical equivalent of heat expressed in electrical units is $778 \div .737 = 1,055$ joules. As 1 gallon of water weighs 8.34 pounds, it requires the conversion of $8.34 \times 1,055 = 8,798.7$ joules into heat to raise the temperature of 1 gallon of water 1° F. Since 1 joule is equal to

1 watt-second, and there are 3,600 watt-seconds in 1 watt-hour, $8,798.7 \div 3,600 = 2.444$ watt-hours will be required for 1° F. rise in the temperature of 1 gallon of water, provided there are no heat losses.

As a matter of fact, in practical heating operations, considerable heat is always lost; the containing vessel absorbs some heat, while some escapes to the surrounding air. The actual efficiencies of commercial electric water heaters varies between wide limits. Assuming 80 per cent. as a fair average, the energy required to raise the temperature of 1 gallon of water from 50° F. to the boiling point, 212° F., or a total rise of 162° F., is $162 \times 2.444 \times \frac{100}{80} = 495$ watt-hours.

The power required depends inversely on the time in which the work must be done; for example, in the preceding problem, if the gallon of water is to be boiled in $\frac{1}{2}$ hour, $2 \times 495 = 990$ watts will be required, and if in $\frac{1}{4}$ hour, $4 \times 495 = 1,980$ watts will be required.

EXAMPLE.—(a) Assuming that an electric water heater has an efficiency of 85 per cent., how much power in watts will be required to raise the temperature of 2 quarts of water from 50° F. to boiling point in 20 minutes? (b) What will be the current at 220 volts?

SOLUTION.—(a) Since 2 qt. = $\frac{1}{2}$ gal., $\frac{1}{2} \times 2.444$, or 1.222 watt-hours, is required for each degree rise without any losses. For 212 - 50, or 162° rise, there will be required $162 \times 1.222 = 198$ watt-hours at 100-per-cent. efficiency. At 85-per-cent. efficiency, the energy must be $198 \times \frac{100}{85} = 233$ watt-hours. If the work must be done in 20 min., or $\frac{1}{3}$ hr., the power must be $3 \times 233 = 699$ watts. Ans.

(b) The current at 220 volts will be $699 \div 220 = 3.2$ amperes, nearly. Ans.

HEATING APPLIANCES FOR DOMESTIC USE

28. All electric-heating devices for domestic use may be classified as lighting-circuit devices and heating-circuit devices. The lighting-circuit devices are those which take about 500 watts or less, and which may be connected to the ordinary branch circuits without any special wiring. The heating-circuit devices require special circuits, as the ordinary branch-lighting circuits are not of sufficient capacity.

In view of the fact that the use of domestic electric-heating devices is constantly increasing, new dwelling houses should be provided with special heating circuits having outlets wherever large heating appliances are to be used. Architects and electrical contractors should urge this matter, as the installation of such circuits may save considerable future annoyance and expense.

29. Among the many electrical devices for domestic heating may be mentioned flat irons, coffee pots, teapots, water heaters, chafing dishes, stoves, plate-warming closets, griddles, warming pads, curling-iron heaters, etc. In such devices, the heating circuits are arranged as closely as possible to the surfaces to be heated, so as to make the efficiency of conversion from electricity into useful heat as high as possible. Generally, each manufacturing company has adopted a distinctive method of making and insulating the resistances.

30. **Heating Units.**—The General Electric Company makes a **cylindrical unit** by winding flat resistance ribbon edgewise in the form of a helix on an arbor, and holding the turns rigidly in place, and at the same time insulating them, with a cement; the whole forms a solid tube, which is wrapped in a thin sheet of mica and enclosed in a shell, or cartridge, as shown in Fig. 10. These units are inserted into close-fitting chambers in flat irons, stoves, or other devices, and are readily replaced if they burn out.



FIG. 10

The same company makes a **flat heating disk** by insulating the surface to be heated with an application of quartz enamel—made by mixing finely divided quartz grains with an insulating enamel—and then winding resistance wire spirally on the enamel. The wire is held in place by applying another coat of enamel over it. The Simplex Electric Heating Company employ the same method, except for differences in the quality of the insulating enamel in which the resistance wire is embedded and sealed.

31. The Prometheus heating unit, shown in Fig. 11, consists of a strip of mica carrying a thin layer of non-oxidizable metal firmly secured to the mica by a process of firing. This conducting strip is protected by another piece of mica placed over it, and the whole is bent into any desired form and enclosed in a metallic casing.

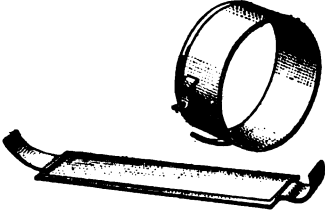

FIG. 11

The resistance used by the Hadaway Electric Heating Company is composed of iron strip, or ribbon, with deep, narrow notches punched in the edges, as shown in Fig. 12. This ribbon is first insulated by a

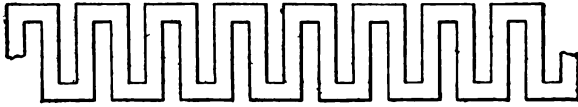

FIG. 12

wrapping of mica, and is then laid in molds, where the metal of the heating device is cast around it, thus making the resistance unit an integral part of the heater.

32. All heating resistances for use with alternating current should be non-inductive, as the production of heat depends only on the square of the current and the ohmic resistance; inductances would cause voltage



FIG. 13

losses that would result in no additional heat. Non-inductive effects are produced by making the current follow a zigzag

path, as suggested in Fig. 12; or, if the resistance is in the form of a helix, by making the winding such that the current must travel an equal number of times each way around the helix.

33. Fig. 13 shows the method of applying the General Electric cylindrical units to the bottom of a glue pot. In

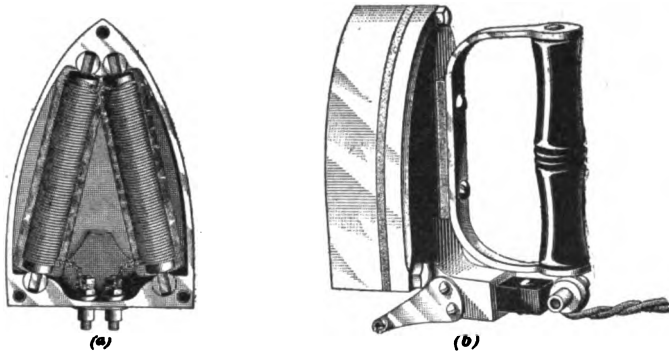

FIG. 14

some utensils the units are so applied as to be almost entirely surrounded by the liquid to be heated. Fig. 14 (a) shows the interior of a Pacific Heating Company flat iron, showing the positions of the two heating units, and (b) shows the complete iron with its end so shaped that the iron will stand vertically when not in use. This method of locating the heating units in the iron causes most of the heat to be developed near the point and along the edges of the iron, where it is most needed. The stand, by holding the iron in a vertical position, enables the heat to escape more easily when the iron is not in use, thus avoiding the danger of a burn-out if the current is left on.

34. Flat-Iron Stand and Heater.

When a flat iron is in

use, heat escapes from it much more rapidly than when it is idle; hence, more rapid development of heat is required

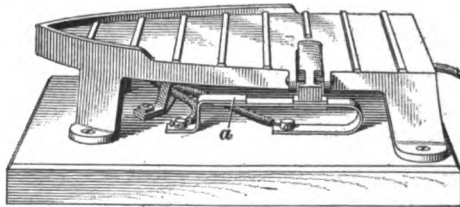

FIG. 15

in order to keep up a given temperature. If an electric flat iron is allowed to stand idle in a horizontal position with the same current flowing through it as is required while it is in

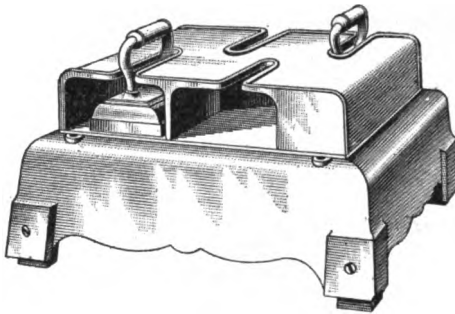

FIG. 16

use, the iron will overheat. Fig. 15 shows a **simplex stand** for an electric flat iron; a switch *a* is so arranged that the act of setting the iron on the stand cuts an additional resistance in series with the heating circuit of the iron,

so as to prevent overheating and at the same time save current.

Fig. 16 shows a **Hadaway heater** for four ordinary irons. Similar heaters are made for any number of irons. An objection to this plan is that the heater remains in operation while the irons are in use, and some heat is thereby uselessly dissipated to the surrounding air.

35. Heating Pad.

Fig. 17 shows a **heating pad** to be used as a substitute for a hot-water bottle. This appliance is very useful in hospitals and in private homes. Flexible resistance wire is embedded in non-com-

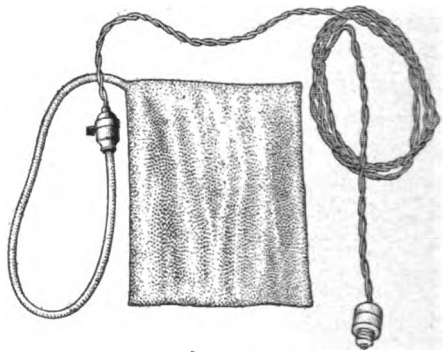

FIG. 17

burstible insulating material, and the same material covers the leads far enough from the pad to avoid all danger of burning the bed clothing.

MISCELLANEOUS HEATING DEVICES

36. Printing and Binding Machinery.—Other appliances that will assist in building up a day load, provided they can be introduced in sufficient number, are heating devices for use in printing and bookbinding establishments; also irons, hot rolls, etc. for laundries, hatters' tools, tailors' irons, glue pots, soldering irons, cigar lighters, etc.

In a printing and bookbinding establishment there are a great many calls for heat, most of them of an intermittent nature. Electric heaters have been found very desirable for such work, on account of the perfect control and ready adaptability of the heat. The Government Printing Office at Washington, D. C., probably has the most extensive equipment of electrical devices for use in printing and bookbinding; these devices range in energy density from .75 to 4 watts per square inch of superficial area of the heaters.

37. Laundry Machinery.—Electric laundry machinery has proved to be economical and satisfactory in service, as well as a source of income to the central station. Many laundries are equipped not only with electrically heated flat irons, but also with electrically heated ironing rolls. It is evidently a simple matter to arrange an electric-heating circuit inside an iron cylinder, so that the surface of the cylinder can be kept as hot as desired. Suitably arranged slip rings and brushes conduct the current from the stationary part of the circuit to the revolving part.

38. Power Consumption.—The power consumption of electric-heating appliances varies so much with the size of the heater and the rate at which it is designed to furnish heat that it is impossible to give any figures that are generally applicable. The following, however, may be useful: Flat iron, family size (6 pounds), 500 watts; chafing dish, 3-pint size, 500 watts; water heater to raise the temperature of 1 quart from 60° F. to 212° F. (boiling point) in 10 minutes, 650 watts; glue pot, 1-quart size, 440 watts; soldering iron (Vulcan), equivalent of 3-pound soldering copper, 150 watts.

INDEX

NOTE.—All items in this index refer first to the section (see the Preface), and then to the page of the section. Thus, "Air heating, §57, p21," means that air heating will be found on page 21 of section 57.

A

- Accumulator, Nature of, §27, p1.
Phillips-Entz, §27, p26.
The chloride, §27, p15.
- Accumulators, Bimetallic, §27, p25.
Classes of, §27, p2.
General data on chloride, §27, p84.
Lead, §27, p2.
Rating of, §27, p6.
Use of, in central stations, §27, p54.
- Advantages of electric heat, §57, p8.
of electric welding, §57, p17.
- Aging of transformer iron, §33, p53.
- Air heating, §57, p21.
- Alarms, Burglar, §45, p40.
- Alternating-current arc-light dynamos, §35, p25.
-current arc switchboards, Western Electric, §35, p49.
-current constant-current system, §33, p34.
-current constant-potential system, §33, p15.
-current enclosed-arc lamps, §34, p20.
-current enclosed-arc series lamps, §34, p49.
-current lines, Calculations for, §33, p49.
-current open-arc lamps, §34, p17.
- Alternators, Constant-current, §35, p25.
- Ammeter jack, §35, p41.
- Ampere-hour efficiency, §27, p11.
- Amyl-acetate unit, §32, p13.
- Anchored filament, §32, p5.
- Annealing, §57, p18.
- Annunciator circuits, Bell and, §45, p29.
Needle, §45, p27.
Self-restoring, §45, p27.
Wiring for elevator, §45, p38.
Wiring for return-call, §45, p32.
- Annunciators, §45, p26.
- Apparatus for series lighting system, §45, p49.
- Appliances for domestic use, Heating, §57, p24.
- Applications of electric heat, §57, p8.
of Moore tubes, §55, p44.
- Approved conduit systems, §44, p49.
- Arc Advantages of enclosed, §34, p10.
Advantages of open, §34, p10.
Character of enclosed, §34, p9.
circuits, Laying out, §35, p2.
circuits, Lightning protection for, §35, p16.
Crater of, §34, p2.
dynamo, Brush, §35, p19.
dynamo, Wood, §35, p22.
Electric, §34, p1.
lamp, Beck, §55, p56.
lamp, Brush, §34, p41.
lamp, Economizer of Excello, §55, p53.
lamp, Excello alternating-current, §55, p52.
lamp, Excello direct-current, §55, p50.
lamp, Excello flaming, §55, p50.
lamp, Magnetite, §34, p58.
lamp, Photometry of the, §34, p15.
-lamp pulleys, §35, p6.
lamp, Shunt type of series, §34, p41.
lamps, Adjusting, §34, p65.
lamps, Alternating-current open-, §34, p17.
lamps, Burned-out coils in, §34, p66.
lamps, Candlepower of, §34, p20.
lamps, Carbone, §55, p61.
lamps, Care of, §34, p64.
lamps, Comparative tests of, §55, p58.
lamps, Comparison of various types of, §55, p61.
lamps, Cut-outs on, §35, p9.
lamps, Direct-current enclosed-, §34, p18.
lamps, Direct-current open-, §34, p16.
lamps, Examples of, §34, p41.
lamps, Flaming, §34, p58.
lamps for street lighting, Height of, §35, p4.
lamps, Impregnated carbons for flaming, §55, p58.

- Arc—(Continued)
- lamps, Lightning arrester for, §35, p16.
 - lamps, Magnetite luminous-, §55, p62.
 - lamps, Methods of distribution of, §34, p26.
 - lamps, Open-, §34, p41.
 - lamps, Parallel distribution of, §34, p31.
 - lamps, Power consumption of, §34, p24.
 - lamps, Series, §34, p38.
 - lamps, Series distribution of, §34, p26.
 - lamps, Special applications of, §34, p60.
 - lamps, Trimming, §34, p64.
 - lamps, Types of, §34, p35.
 - lamps, Wiring for, §45, p13.
 - lamps, Wiring for constant-current, §45, p14.
 - light carbons, Arrangement of, §34, p11.
 - light dynamos, §35, p17.
 - light dynamos, Alternating-current, §35, p25.
 - light lines, Testing, §35, p10.
 - light switchboards, §35, p32.
 - light wiring, Drop in, §43, p51.
 - lighting, §34, p1; §35, p1.
 - lighting, Line construction for, §35, p3.
 - lighting, Line work for, §35, p1.
 - lighting, Watts per square foot for interior, §34, p26.
 - lights on low-potential circuits, Rules for, §45, p13.
 - lights, Size of wire for, §43, p52.
 - machines, Constant direct-current, §35, p17.
 - machines in series, Running, §35, p24.
 - machines, Reversal of polarity in, §35, p23.
 - switchboards, Construction and operation of, §35, p33.
 - Temperature of, §34, p3.
 - Voltage of the, §34, p4.
- Arcs, Enclosed, §34, p5.
- Open, §34, p1.
- Armored conduit, Flexible, §44, p59
- twin cable, §44, p23.
- Arrangement of lighting apparatus, §45, p46.
- Automatic burner, §45, p45.
- cut-outs, §43, p23.
 - cut-outs, Rules for, §43, p24.
 - drop, §45, p38.
 - mercury-vapor lamp type, §55, p66.
- Automobile batteries, §27, p23.
- battery, Gould, §27, p24.
 - battery, Porter, §27, p24.
 - battery, Willard, §27, p24.
- Autotransformers, §35, p30.
- B**
- Balancer, §33, p9.
- Balancing coils, §35, p31.
- Ballast, §32, p41.
- for Nernst lamp, §55, p20.
- Bar, Photometer, §32, p18.
- Bare copper wire, B. & S. gauge, Dimensions of, §43, p16.
- Base, Edison, §32, p10.
- of lamp, §32, p9.
 - Thomson-Houston, §32, p10.
 - Westinghouse, or Sawyer-Man, §32, p11.
- Bases, Lamp, §43, p41.
- Batteries, §45, p23.
- Automobile, §27, p23.
 - in lighting stations, Storage, §33, p62.
 - Storage, §27, p1.
- Battery charged from dynamo, §27, p50.
- Charging the, §27, p37.
 - Closed-circuit type of, §45, p24.
 - Discharging the, §27, p39.
 - discontinued, §27, p43.
 - Exide, §27, p23.
 - Gould automobile, §27, p24.
 - Gould storage, §27, p18.
 - Gravity-cell, §45, p24.
 - Inspection of cells of, §27, p40.
 - into commission, Putting, §27, p43.
 - Nature of secondary, §27, p1.
 - Occasionally used, §27, p43.
 - Open-circuit type of, §45, p23.
 - out of commission, Putting, §27, p43.
 - out on line, §27, p60.
 - Porter automobile, §27, p24.
 - Regulating appliances for storage, §27, p64.
 - Selection of, for given service, §27, p62.
 - storage, Nature of, §27, p1.
 - taking peak of load, §27, p55.
 - used to carry whole load, §27, p57.
 - used to take up fluctuations in load, §27, p57.
 - Willard storage, §27, p22.
 - with double end-cell switch, §27, p67.
 - with single end-cell switch, §27, p66.
- Beck lamp, §55, p56.
- Bell and annunciator circuits, §45, p29.
- Electric, §45, p20.
 - wire, Running, §45, p28.
 - wiring, §45, p20.
 - wiring for flats, §45, p36.
- Bells, Operating, from lighting circuits, §45, p24.
- Bimetallic accumulators, §27, p25.
- cells, §27, p25.
- Binding, Heaters for, §57, p29.
- Block, Three-wire branch, §43, p45.
- Three-wire main, §43, p45.
- Booster, §33, p14.
- Compound, §27, p73.
 - Constant-current, §27, p78.

- Booster—(Continued)**
 Differential, §27, p74.
 field, Reversing rheostat for, §27, p71.
 Shunt, §27, p69.
 Storage-battery, §27, p68.
Boosters, Capacity of, §27, p81.
Box negative, §27, p16.
Branch block, Three-wire, §43, p45.
 block, Two-wire double, §43, p45.
Breakdowns, §33, p28.
Breaks in circuits, §35, p10.
 Locating, §35, p11.
Bremer lamp, §34, p68.
British thermal unit, §32, p33.
Brush arc dynamo, §35, p19.
 arc lamp, §34, p41
 machines, Regulator for, §35, p20.
 plug and spring jack, §35, p36.
Buckling, §27, p6.
Bulb, Style of, §32, p8.
 Tubulation of, §32, p8.
Bunsen photometer, §32, p16.
Burglar-alarm system, Open- and closed-circuit, §45, p43.
 -alarm system, Open-circuit, §45, p41.
 alarms, §45, p40.
Burned-out coils in arc lamps, §34, p66.
Burner, Automatic, §45, p45.
 Pendant, §45, p44.
 Ratchet, §45, p45.
Burners for parallel system of electric gas lighting, §45, p44.
Burning battery lugs, §27, p15.
Button, Ceiling, §43, p39.
Buzzer, §45, p21.
- C**
- C R regulator, §33, p38.**
Cabinet, Example of, §44, p27
Cabinets and panel boards, Use of, §44, p24.
Cable, Armored twin, §44, p23.
Cadmium test, §27, p43.
Calculating sizes of wire required, §44, p1.
Calculation of line losses due to resistance, §43, p50.
 of the proper size of wire for a given loss, §43, p53.
 of wire size in terms of resistance per 1,000 feet, §44, p3.
 of wires for alternating current, §44, p8.
 of wires in parallel, §44, p16.
 of wires in terms of circular mils, §44, p5.
Calls, Carriage, §56, p28.
Candlepower and distribution of the light from arc lamps, §55, p59.
 Mean horizontal, §32, p21.
 Mean spherical, §32, p23.
- Candlepower—(Continued)**
 obtained in vertical plane, §32, p22.
 of arc lamps, §34, p20.
 of incandescent lamps, §32, p12.
 of lamps, §32, p28.
 Power consumption per, §34, p21.
Capacity of boosters, §27, p81.
 of galvanized-iron wire, Carrying, §57, p6.
 of German-silver wire, Carrying, §57, p5.
 of tinned-iron wire, Carrying, §57, p7.
 of wires for marine work, §44, p67.
Car heater, §57, p22.
Carbone arc lamps, §55, p61.
Carbons, Arrangement of arc-light, §34, p11.
 Composition of, §34, p13.
 Consumption of, in lamps, §34, p8.
 for flaming-arc lamp, Impregnated, §55, p58.
Care of Nernst lamp, §55, p26.
Carriage calls, §56, p28.
Carrier-bus switchboard, §35, p39.
Carrying capacities of wires, §43, p13.
 capacity of galvanized-iron wire, §57, p6.
 capacity of German-silver wire, §57, p5.
 capacity of insulated wires, §43, p14.
 capacity of tinned-iron wire, §57, p7.
Cartridge type of fuses, §43, p46.
Ceiling button, §43, p39.
Cell, Edison nickel-iron, §27, p28.
 Faure, §27, p3.
 Planté, §27, p2.
 Type of lead-sulphuric acid, §27, p15.
 Zinc-lead, §27, p25.
Cells, Bimetallic, §27, p25.
Charging, from constant-current arc circuit, §27, p49.
Construction of lead-sulphuric acid, §27, p13.
Copper-zinc, §27, p26.
General data on electric-vehicle, §27, p86.
General data on Gould storage, §27, p85.
General data on storage, §27, p83.
Getting low, into normal condition, §27, p42.
Installation and care of storage, §27, p30.
Location of, §27, p30.
Method of supporting, §27, p30.
of battery, Inspection of, §27, p40.
Rating of, §27, p7.
Resistance of, §27, p13.
Sediment in, §27, p42.
Setting up, §27, p30.
Simple connections for charging, §27, p46.
Treatment of end, §27, p45.
Center of distribution, §43, pp22, 55.
Central station, Effect of electric heating on, §57, p8.

- Changeable signs, §56, p10.
 Changers, Frequency, §33, p26.
 Changes in display of signs, §56, p19.
 in intensity of light of signs, §56, p10.
 Characteristics of flaming-arc lamp, §55, p58.
 of Moore tubes, §55, p45.
 of tantalum filaments, §55, p7.
 of the Nernst lamp, §55, p23
 Charge of battery, Indications of a complete, §27, p37.
 Voltage at end of, §27, p38.
 Charging battery from dynamo, §27, p50.
 cells from constant-current arc circuit, §27, p49.
 electromotive force, §27, p13.
 the battery, §27, p37.
 Chloride accumulators, General data on, §27, p84.
 Choke or reactance coil, §34, p34.
 Circuit-breakers, §43, p23.
 -breakers, cut-outs, etc., Construction of, §43, p30
 Circuits, Arrangement of series, §34, p28.
 Bell and annunciator, §45, p29.
 Breaks in, §35, p10.
 Distribution, §43, p22.
 in series, Operating, §35, p32.
 Lamps used in series, §33, p36.
 Laying out, §44, p32.
 Laying out arc, §35, p2.
 Lightning protection for arc, §35, p16.
 Protection of secondary, §33, p27.
 Cleat, Knob, §43, p38.
 Single-wire, §43, p37.
 Clock, Talking, §56, p27.
 Closed-circuit burglar system §45, p42.
 -circuit type of battery, §45, p24.
 -coil machines, §35, p22.
 -coil machines, Western Electric, §35, p22.
 Code, National Electrical, §43, p2.
 Coil, Reactance, or choke, §34, p34.
 Coils, Balancing, §35, p31.
 Economy, §35, p30.
 Color of light of incandescent lamps, §55, p4.
 Combination sign, §56, p4.
 Combining several wiring systems, §45, p1.
 Comparative lamp tests for arc lamps, §55, p58.
 Comparison of mercury-vapor lamps with other light sources, §55, p37.
 of various types of arc lamps, §55, p61.
 Composition of carbons, §34, p13.
 Compound booster, §27, p73.
 Concealed electric-light wiring, Specifications for §44, p36.
 knob-and-tube work, §44, p20.
 wiring, §44, p19.
 Conductor, §32, p4.
 Conductors for marine work, Portable, §44, p67.
 in parallel, Fuse protection for, §44, p13.
 Underground, §43, p13.
 Conduit, Flexible armored, §44, p59.
 systems, Approved, §44, p49.
 systems, Early, §44, p48.
 wiring, §44, p48.
 Conduits, Rules for interior, §44, p56.
 Wire used in, §44, p56.
 Connecting lamps, Methods of, §32, p2.
 Connections for Nernst lamp, §55, p21.
 for testing lamps, §32, p25.
 for thawing transformer, §57, p12.
 of Cooper Hewitt lamps, §55, p31.
 of glower lamp, §32, p43.
 of mercury-vapor lamps, §55, p31.
 of Moore tubes, §55, p40.
 Constant-current alternators, §35, p25.
 -current arc lamps, Wiring for, §45 p14.
 -current booster, §27, p78.
 -current distribution, Machines for, §35, p17.
 -current enclosed-arc series lamps, §34, p48.
 -current open-arc series lamps, §34, p41.
 -current transformer, §33, p40.
 direct-current arc machines, §35, p17.
 -potential alternating-current lamps, §34, p56.
 -potential arc lamps, Wiring for, §45, p13.
 -potential direct-current lamp, General Electric, §34, p53.
 -potential direct-current lamps, §34, p53.
 -potential enclosed-arc lamp, §34, p53.
 -potential lamp, Western Electric, §34, p57.
 -potential lamps, §34, p36.
 Consumer's switch, §27, p49.
 Consumption of carbons in lamps, §34, p8.
 of power per candlepower, §34, p21.
 Control of lamps from two points, §44, p38.
 of lights from three or more points, §44, p40.
 Cooper Hewitt lamp, §55, p28.
 Hewitt lamp reflectors, §55, p31.
 Hewitt lamps, Connections of, §55, p31.
 Hewitt type of lamp, §55, p66.
 Copper losses of transformer, Measurement of, §33, p58.
 wire, B. & S. gauge, Dimensions of bare, §43, p16.
 wire, Resistance of pure, §43, p49.
 -zinc cells, §27, p26.
 Cord, Rules for flexible, §43, p40.
 Core losses of transformer, Measurement of, §33, p55.
 Cored carbon, §34, p14.
 Costs of heating, Relative, §57, p9
 Crater of arc, §34, p2.

- Crawford-Voelker lamp, §32, p45.
 Cross-section of wires, Equivalent, §44, p15.
 Crosses, §35, p11.
 Current allowance per lamp, §33, p51.
 and voltage of lamp, §34, p9.
 Direction of, §27, p50; §34, p2.
 estimation, §33, p45.
 Heating effect of electric, §57, p1.
 of enclosed-arc series lamps, §34, p49.
 of lamp, §32, p27.
 of lamps, §34, p5.
 regulators, §33, p38.
 required by lamps, Estimation of, §44, p7.
 required by motors, §45, p18.
 required for lamps, §43, p43.
 required per lamp, §32, p33.
 Currents, Tables of heating effects of, §57, p2, 3.
 Cut-out, §32, 42; §34, p38.
 -out for Nernst lamp, §55, p21.
 -out, Location of, §44, p34.
 -out switches, §35, p8.
 Cut-outs, Automatic, §43, p23.
 -outs, circuit-breakers, etc., Construction of, §43, p30.
 -outs for marine work, §44, p68.
 -outs, Location of, §43, p35.
 -outs on arc lamps, §35, p9.
 -outs, Rules for automatic, §43, p24.
 -outs, Switches and, §43, p23.
 Cutter switch, §27, p52.
- D**
- Data, Pipe-thawing, §57, pp10, 11.
 Deshler-McAllister photometer, §32, p18.
 Determination of sizes of wire according to current capacity, §43, p35.
 Devices, Miscellaneous heating, §57, p29.
 Diameter of wires that will be fused by a current of given strength, Table of, §57, p4.
 Differential booster, §27, p74.
 lamp, §34, p40.
 method of locating grounds, §35, p14.
 Dimensions of bare copper wire, B. & S. gauge, §43, p16.
 Dimmers, Stage, §45, p4.
 Direct-current arc machines, Constant-current, §35, p17.
 -current constant-current system, §33, p15.
 -current constant-potential system, §33, p6.
 -current enclosed-arc lamps, §34, p18.
 -current machines, §35, p17.
 -current open-arc lamps, §34, p16.
 -current systems, Two-wire and three-wire, §33, p44.
 Directions of current, §27, p50; §34, p2.
- Discharging the battery, §27, p39.
 Distribution and candlepower of light from arc lamps, §55, p59.
 Center of, §43, p55.
 circuits, §43, p22.
 of arc lamps, Methods of, §34, p26.
 of arc lamps, Series, §34, p26.
 of lamps, Location and, §44, p47.
 of light, §32, p21.
 of light of Nernst lamp, §55, p26.
 Door openers, §45, p40.
 Double-branch blocks, Two-wire, §43, p45.
 -end cell switch, Battery with, §27, p67.
 -faced signs, §56, p6.
 -filament lamps for signs, §56, p12.
 -pole flashers, §56, p15.
 Drawing wires in conduits, §44, p60.
 Drip loop, §43, p37.
 Drop, Automatic, §45, p38.
 in arc-light wiring, §43, p51.
 in feeder lines, Uniform, §44, p1.
 Dynamo, Brush arc, §35, p19.
 Wood arc, §35, p22.
 Dynamos, Arc-light, §35, p17.
- E**
- Economizer of Excello lamp, §55, p53.
 Economy coils, §35, p30.
 of electric heating, §57, p23.
 Edison base, §32, p10.
 nickel-iron cell, §27, p28.
 plug, §43, p44.
 three-wire system, §43, p20.
 Effect of electric heating on central station, §57, p8.
 Efficiency, Ampere-hour, §27, p11.
 Luminous, §55, p1.
 of lamp, §32, p24.
 of light-giving sources, §32, p36.
 of Nernst lamp, §32, p44.
 of storage cells, §27, p11.
 of transformers, §33, p50.
 Watt-hour, §27, p12.
 Elblight system of signs, §56, p19.
 Electric annealing, §57, p18.
 arc, §34, p1.
 bell, §45, p20.
 -car heater, §57, p22.
 current, Heating effect of, §57, p1.
 furnaces, §57, p20.
 gas lighting, §45, p44.
 gas lighting, Burners for parallel system of, §45, p44.
 heat, Advantages of, §57, p8.
 heat, Applications of, §57, p8.
 heater, Luminous, §57, p22.
 heaters, Power consumption of, §57, p20.

- Electric—(Continued)
- heating, §57, p1.
 - heating, Economy of, §57, p23.
 - heating, Effect of, on central station, §57, p8.
 - heating of air, §57, p21.
 - heating of water, §57, p23.
 - heating pad, §57, p28.
 - heating unit, Hadaway, §57, p26.
 - heating units, §57, p25.
 - heating units, Prometheus, §57, p26.
 - installation, Matters to be considered in, §43, p1.
 - light wiring, Specifications for concealed, §44, p36.
 - motors, Wiring for, §45, p17.
 - vehicle cells, General data on, §27, p86.
 - welding, Advantages of, §57, p17.
 - welding, Hoho process of, §57, p19.
 - welding, Power required for, §57, pp16, 17.
 - wiring, Fires caused by, §43, p2.
- Electrical code, National, §43, p2.
- fires, Examples of, §43, p3.
- work, Fittings that may be used in, §43, p3.
- Electrolier switches, §44, p41.
- Electrolyte, Mixing the, §27, p34.
- Electrolytic forge, §57, p18.
- Electromotive force, Change of, with discharge, §27, p7.
- force, Charging, §27, p13.
- Elements in jar, Placing the storage cell, §27, p31.
- Enclosed arc, Advantages of, §34, p10.
- arc, Character of, §34, p9.
 - arc lamp construction, §34, p49.
 - arc lamp, Multiple-series, §34, p57.
 - arc lamps, Alternating-current, §34, p20.
 - arc lamps, Data on, §34, p25.
 - arc lamps, Direct-current, §34, p18.
 - arc lamps on 550-volt circuits, §34, p35.
 - arc lamps, Trimming, §34, p67.
 - arc lamps, 220-volt, §34, p35.
 - arc series lamps, Current of, §34, p49.
 - arc series lamps, Voltage required by, §34, p48.
 - arcs, §34, p5.
 - fuses, §43, p44.
 - fuses, Advantages of, §43, p47.
- End-cell indicators, §27, p66.
- cell switch, Battery with single, §27, p66.
 - cell switches, §27, p64.
 - cells, Treatment of, §27, p45.
- Equivalent cross-section of wires, §44, p15.
- Excello alternating-current lamp, §55, p52.
- direct-current lamp, §55, p50.
 - flaming-arc lamp, §55, p50.
 - lamp economizer, §55, p53.
- Exhaustion of lamp, §32, p6.
- Exposed-bulb signs, §56, p5.
- wiring, Fittings used for, §43, p36.
- F
- Factory wiring, Simple example of, §43, p32.
- Faure cell, §27, p3.
- Feeder-and-main system, §33, p7.
- lines, Uniform drop in, §44, p1.
- Feeders and mains, §33, p6.
- Filament, Anchored, §32, p5.
- Metallic, §55, p5.
 - Metalized, §55, p2.
 - Size of, §32, p7.
- Filaments, §32, p4.
- Characteristics of tantalum, §55, p7.
 - Flashing of, §55, p3.
 - Methods of supporting tantalum, §55, p6.
 - Preparation of metalized, §55, p2.
 - Preparation of Osmium, §55, p11.
- Fire-alarm gongs, Wiring for, §45, p36.
- Fires caused by electrical wiring, §43, p2.
- Examples of electrical, §43, p3.
- Fittings for supporting wire, §43, p37.
- for 220-volt wiring, Selection of, §43, p57.
 - used for exposed wiring, §43, p36.
 - used in electrical work, §43, p3.
- Five-wire systems, §33, p14.
- Fixed electric signs, §56, p1.
- Fixtures, §44, p43.
- for marine work, §44, p68.
 - Rules for, §44, p43.
- Flaming-arc lamp, Characteristics of, §55, p58.
- arc lamp, Impregnated carbons for, §55, p58.
 - arc lamp theory, §55, p48.
 - arc lamps, §34, p58; §55, p47.
- Flasher, Single-pole for sign, §56, p17.
- Flashers, Double-pole, §56, p15.
- for signs, Mechanical, §56, p15.
 - Thermal sign, §56, p12.
- Flashing of filaments, §55, p8.
- process, §32, p6.
- Flat-iron heater, §57, p27.
- Flexible armored conduit, §44, p69.
- cord, Rules for, §43, p40.
 - lamp cord, §43, p39.
- Fluctuations in load, Battery used to take up, §27, p57.
- Focusing lamp, §34, p13.
- Forge, Electrolytic, §57, p18.
- Formulas for resistance of wire, §44, p6.
- Frequency changes, §33, p26.
- Frictional machines, §45, p50.
- Frozen water pipes, Thawing of, §57, p10.
- Furnaces, Electric, §57, p20.

- Fuse protection for conductors in parallel, §44, p13.
- Fuses, §43, pp23, 44.
- Advantages of enclosed, §43, p47.
- Cartridge type of, §43, p46.
- Enclosed, §43, p44.
- Link, §43, p44.
- Rating of, §43, p47.
- G**
- Gas lighting, Electric, §45, p44.
- Gauges, Wire, §43, p15.
- General Electric constant-potential direct-current lamp, §34, p53.
- Electric heating unit, §57, p25.
- Electric lamp for constant alternating current, §34, p52.
- Electric switchboard, §35, p46.
- rules for wiring, §43, p10.
- Globe, Waterproof, §44, p18.
- Glow lamp, Connections of, §32, p43.
- Glowers of lamp, §32, p40.
- Gould automobile battery, §27, p24.
- storage battery, §27, p18.
- storage cells, General data on, §27, p85.
- Graphic method of calculation of wires, §44, p10.
- Gravity-cell battery, §45, p24.
- Grounding of neutral on three-wire system, §33, p32.
- of secondary system of wiring, Permanent, §33, p31.
- Grounds, §35, p10.
- Differential method of locating, §35, p14.
- Locating, §35, p12.
- H**
- Hadaway heating unit, §57, p26.
- Hanging lamps, Methods of, §35, p4.
- Heat, Advantages of electric, §57, p8.
- Applications of electric, §57, p8.
- of incandescent lamp, §32, p33.
- Heater, Car, §57, p22.
- coils and holder of lamp, §32, p40.
- Flat-iron, §57, p27.
- Luminous, §57, p22.
- Heaters for bookbinding machinery, §57, p29.
- for laundry machinery, §57, p29.
- for printing machinery, §57, p29.
- Nernst lamp, §55, p19.
- Power consumption of, §57, p29.
- Heating, Air, §57, p21.
- appliances for domestic use, §57, p24.
- devices, Miscellaneous, §57, p29.
- Effect of central station on electric, §57, p8.
- effects of currents, Tables of, §57, pp2, 3.
- effects of electric current, §57, p1.
- Heating—(Continued)
- Electric, §57, p1.
- of water, §57, p23.
- pad, §57, p28.
- Relative costs of, §57, p9.
- unit, General Electric, §57, p25.
- unit, Hadaway, §57, p26.
- units, §57, p25.
- units, Prometheus, §57, p26.
- Hefner unit, §32, p13.
- High-potential systems, §45, p11.
- Hoho process of welding, §57, p19.
- Hydrometers, §27, p30.
- I**
- Illuminated signs, §56, p2.
- Illumination, §34, p23.
- by incandescent lamps, §32, p33.
- Impedance of transformer, Measurement of, §33, p58.
- volts of transformer, §33, p59.
- Impregnated carbons for flaming-arc lamp, §55, p58.
- Incandescent lamp, §32, p3.
- lamp, Heat of, §32, p33.
- lamp, Life of, §32, p29.
- lamp, Voltage of, §32, p32.
- lamps, §55, p2.
- lamps, Candlepower of, §32, p12.
- lamps, Illumination by, §32, p33.
- lamps, on series circuit, Wiring for, §45, p16.
- lamps, Power consumption of, §43, p43.
- lamps, Recent types of, §32, p35.
- lighting, §32, pp1, 3; §33, p1.
- Indicators, End-cell, §27, p66.
- Inspection of cells of battery, §27, p40.
- Installation and care of storage cells, §27, p30.
- Insulated wires, Carrying capacity of, §43, p14.
- Insulating joints, §44, p44.
- Insulation resistance, Test of, §44, p64.
- test, §33, p53.
- Interior arc lighting, Watts per square foot for, §34, p26.
- conduits, Rules for, §44, p56.
- wiring, §43, p1; §44, p1; §45, p1.
- wiring, Systems of distribution for, §43, p19.
- J**
- Jar, Placing elements of storage cells in, §27, p31.
- Joints, Insulating, §44, p44.
- of wires, §43, p11.
- of wires, Soldering fluid for, §43, p11.
- Junction boxes, Use of outlet and, §44, p51.

K

- Knob, §43, p37.
 -and-tube work, Concealed, §44, p20.
 cleat, §43, p38.

L

- Lamp, Application of the Moore, §55, p44.
 Ballast for Nernst, §55, p20.
 Base of, §32, p9.
 bases, §43, p41.
 Beck, §55, p56.
 -board regulator, §33, p38.
 Bremer, §34, p58.
 calculations, Measurements and, §32, p12.
 Care of Nernst, §55, p26.
 Characteristics of flaming-arc, §55, p58.
 Characteristics of Nernst, §55, p23.
 Comparison of mercury-vapor, with other
 light sources, §55, p37.
 Connections for Nernst, §55, p21.
 Connections for Moore, §55, p40.
 Constant-potential enclosed-arc, §34, p53.
 construction, Enclosed-arc, §34, p49.
 Cooper Hewitt, §55, p28.
 cord, Flexible, §43, p39.
 Crawford-Voelker, §32, p45.
 Current of, §32, p27.
 Current required per, §32, p33.
 Cut-out for Nernst, §55, p21.
 Description of Nernst, §32, p38.
 Differential, §34, p40.
 Economizer of Excello arc, §55, p53.
 Efficiency of, §32, p24.
 Efficiency of Nernst, §32, p44.
 estimates, §32, p26.
 Excello alternating-current, §55, p52.
 Excello direct-current, §55, p50.
 Excello flaming-arc, §55, p50.
 Exhaustion of, §32, p8.
 -feet, §33, p45.
 Focusing, §34, p13.
 Glowers of, §32, p40.
 Glowers of Nernst, §55, p17.
 Heat of incandescent, §32, p33.
 Heaters of Nernst, §55, p19.
 Incandescent, §32, p3.
 Life of incandescent, §32, p29.
 Light distribution of Nernst, §55, p26.
 Magnetite arc, §34, p58.
 Multiple-series enclosed-arc, §34, p57.
 Negative temperature coefficient of, §55,
 p3.
 Nernst, §32, p36; §55, p16.
 Operation of Nernst, §32, p37.
 Osmium, §32, p46.
 Parts of Nernst, §55, p16.
 Photometry of the arc, §34, p15.

Lamp—(Continued)

- Reflectors of Cooper Hewitt, §55, p31.
 Searchlight, §34, p62.
 sockets and receptacles, §43, p42.
 Temperature of a, §32, p24.
 tests, Tungsten, §55, p13.
 Thomson-Houston, §34, p45.
 Type C, mercury-vapor, §55, p30.
 Type H, mercury-vapor, §55, p28.
 Type K, mercury-vapor, §55, p30.
 Type P, mercury-vapor, §55, p66.
 Vacuum regulator for Moore, §55, p41.
 Voltage of incandescent, §32, p32.
 Western Electric, §34, p52.
 Western Electric, constant-potential, §34,
 p55.
 Lamps, Applications of the Moore, §55, p45.
 Candlepower of, §32, p28.
 Candlepower of incandescent, §32, p12.
 Center of distribution of, §33, p44.
 Characteristics of Moore, §55, p45.
 Color of light of incandescent, §55, p4.
 Comparative tests of arc, §55, p58.
 Comparison of various types of arc, §55,
 p61.
 Connection of Cooper Hewitt, §55, p31.
 Connection of mercury-vapor, §55, p31.
 Connections for testing, §32, p25.
 Constant-potential, §34, p36.
 Constant-potential alternating-current, §34,
 p66.
 Constant-potential direct-current, §34, p53.
 Construction of, §32, p4.
 Control of, from two points, §44, p38.
 Current of, §34, p5.
 Current required for, §43, p43.
 Data on enclosed-arc, §34, p25.
 Estimation of current required by, §44, p7.
 Flaming-arc, §34, p58; §55, p47.
 for street lighting, Height of arc, §35, p4.
 Illumination by incandescent, §32, p33.
 in multiple series, §33, p4.
 in parallel, §33, p2.
 in series, §33, p2.
 in series circuits, Looping in, §35, p9.
 Incandescent, §55, p2.
 Location and distribution of, §44, p47.
 Luminous-arc, §55, p48.
 Magnetite-luminous arc, §55, p62.
 Mast-arm suspension of, §35, p5.
 Mercury-vapor, §55, p28.
 Metallic-filament, §55, p5.
 Metallized-filament, §55, p2.
 Methods of connecting, §33, p2.
 Methods of distribution of arc, §34, p26.
 Methods of hanging, §35, p4.
 Moore, §55, p39.

Lamps—(Continued)

- mounted on pole tops, §35, p4.
- Open-arc, §34, p16.
- Operation of mercury-vapor, §55, p36.
- Operation of metallized-filament, §55, p4.
- Operation of osmium, §55, p11.
- Operation of tungsten, §55, p13.
- Osmium, §55, p10.
- Parallel distribution of arc, §34, p31.
- Power consumption of arc, §34, p24.
- Power consumption of incandescent, §43, p43.
- Recent types of incandescent, §32, p35.
- Rope for arc, §35, p7.
- Series arc, §34, p38.
- Series distribution of arc, §34, p26.
- Span-wire suspension for arc, §35, p6.
- Tantalum, §55, p6.
- Temperature of incandescent, §55, p15.
- Theory of flaming-arc, §55, p48.
- Trimming enclosed-arc, §34, p67.
- Tube, §55, p27.
- Tungsten, §55, p13.
- Turnip sign, §56, p12.
- Types of arc, §34, p35.
- used for series circuits, §33, p36.
- Wiring for arc, §45, p13.
- Wolfram, §55, p13.
- Laundry machinery, Heaters for, §57, p29.
- Laying out circuits, §44, p32.
- Lead accumulators, §27, p2.
 - sulphuric-acid cells, Construction of, §27, p13.
 - sulphuric-acid cells, Types of, §27, p15.
- Leading-in wires, §32, p7.
- Leak in circuit, §35, p11.
- Letters for signs, Monogram, §56, p21.
- Life of incandescent lamp, §32, p29.
- Light distribution, §32, p21; §34, p15.
 - distribution of Nernst lamp, §55, p26.
 - measurements, §32, p12.
 - giving sources, Efficiency of, §32, p36.
 - Theory of Moore, §55, p39.
- Lighting apparatus, Arrangement of, §45, p46.
 - Arc, §34, p1; §35, p1.
 - Incandescent, §32, pp1, 3; §33, p1.
 - Store, §45, p1.
 - Tube, §55, p27.
 - tubes, Moore, §55, p39.
 - Watts per square foot for interior arc, §34, p26.
 - work, Size of wire for, §35, p1.
- Lightning arrester for arc lamps, §35, p16.
 - protection for arc circuits, §35, p16.
- Lights, Control of, from three or more points, §44, p40.

Lights—(Continued)

- illuminating value of, §32, p34.
- Line calculations, §33, p44.
 - construction for arc lighting, §35, p3.
 - losses due to resistance, Calculation of, §43, p50.
 - work for arc lighting, §35, p1.
- Link fuses, §43, p44.
- Load, Battery taking peak of, §27, p55.
 - Battery used to carry whole, §27, p57.
 - test of transformers, §33, p59.
- Location and distribution of lamps §44, p47.
 - of cells, §27, p30.
 - of cut-outs, §43, p35.
- Loop, Drip, §43, p37.
- Looping in lamps on series circuits, §35, p9
- Low-potential circuits, Rules for arc lights on, §45, p13.
 - potential system, Definition of, §43, p16.
 - potential systems, Wiring for, §43, p16.
- Luminous-arc lamps, §55, p48.
 - efficiency, §55, p1.
 - radiator, §57, p22.

M

- Machines for constant-current distribution, §35, p17.
- Magnetite arc lamp, §34, p58.
 - luminous-arc lamps, §55, p62.
- Main block. Three-wire, §43, p45.
 - switch, cut-out, and meter, Location of, §44, p34.
- Mains, §43, p22; §44, p32.
 - and feeders, §33, p6.
- Mangin mirror, §34, p12.
- Marine work, §44, p65.
 - work, Capacity of wires for, §44, p67.
 - work, Cut-outs for, §44, p68.
 - work, Fixtures for, §44, p68.
 - work, Portable conductors for, §44, p67.
- Mast-arm suspension of lamps, §35, p5.
- Mean spherical candlepower, §32, p23.
- Measurement of copper losses of transformer, §33, p58.
 - of drop in volts, §44, p65.
 - of impedance of transformer, §33, p58.
 - of primary and secondary resistance, §33, p56.
- Measurements and lamp calculations, §32, p12.
 - Light, §32, p12.
- Mechanical flashers for signs, §56, p11.
- Mercury-vapor lamp reflectors, §55, p31.
 - vapor lamp type, §55, p66.
 - vapor lamps, §55, p28.
 - vapor lamps, Comparison of, with other light sources, §55, p37.

Mercury—(Continued)

- vapor lamps, Connections of, §55, p81.
- vapor lamps, Operation of, §55, p36.
- Metallic-filament lamps §55, p5.
- Metallized-filament lamps, §55, p2.
 - filament lamps, Operation of, §55, p4.
 - filament Preparation of, §55, p2.
- Meter, Location of §44, p34.
- Methods of thawing frozen water pipes, §57, p10.
- Methven screen, §32 p12.
- Mils, §43, p15.
- Mirror, Mangin, §34, p12.
- Miscellaneous heating devices, §57, p29.
- Mixed systems, §33, p22.
- Molding work, Rules for wires for, §44, p61.
- Moldings, Wooden, §44, p60
- Monogram letters for signs, §56, p21.
- Moore lamp vacuum regulator, §55, p41.
 - light, Theory of, §55, p39.
 - lighting tubes, §55, p39.
 - tube connections, §55, p40.
 - tubes, Applications of, §55, p44.
 - tubes, Characteristics of, §55, p45.
- Motor-generator method of load test, §33, p59.
- Motors, Current required by, §45, p18.
- Multicircuit series machines, §34, p28.
- Multiple-series enclosed-arc lamp, §34, p57.
 - series, Lamps in, §33, p4.

N

- National Electrical Code, §43, p2.
- Needle annunciator, §45, p27.
- Negative, Box, §27, p16.
- Nernst glowers, §55, p17.
 - heaters, §55, p19.
 - lamp, §32, p36; §55, p16.
 - lamp, Ballast for, §55, p20.
 - lamp, Care of, §55, p26.
 - lamp, Characteristics of, §55, p23.
 - lamp, Connections for, §55, p21.
 - lamp cut-out, §55, p21.
 - lamp, Description of, §32, p38.
 - lamp, Efficiency of, §32, p44.
 - lamp, Light distribution of, §55, p26.
 - lamp, Operation of, §32, p37.
 - lamp, Parts of, §55, p16.
- Nickel-iron cell, Edison, §27, p28.

O

- Open- and closed-circuit burglar-alarm system, §45, p43.
 - arc, Advantages of, §34, p10.
 - arc, Disadvantages of, §34, p10.
 - arc lamps, §34, pp16, 41.
 - arc lamps, Alternating-current, §34 p17.

Open—(Continued)

- arc lamps, Direct-current, §34, p16.
- arcs, §34, p1.
 - circuit burglar-alarm system, §45, p41.
 - circuit type of battery, §45, p23.
 - work in dry places, §43, p32.
- Operating bells from lighting circuits, §45, p24.
 - circuits in series, §35, p32.
- Operation of mercury-vapor lamps, §55, p36.
 - of metallized-filament lamps, §55, p4.
 - of Osmium lamps, §55, p11.
 - of series arc lamps by adjustable transformer, §35, p26.
 - of series arc lamps directly from machine, §35, p25.
 - of series arc lamps from constant-current transformers, §35, p27.
 - of series arc lamps from constant-potential alternators, §35, p25.
 - of talking signs, §56, p21.
 - of Tungsten lamps, §55, p13.
- Osmium filaments, Preparation of, §55, p11.
 - lamps, §32, p46; §55, p10.
 - lamps, Operation of, §55, p11.
- Outlet and junction boxes, Use of, §44, p61.

P

- Pad, Electric-heating, §57, p28.
- Panel board, Essential parts of a, §44 p25.
 - board, Example of, §44, p26.
 - board, Form of two-wire, §44, p29.
 - board with special fuse holder, §44, p28.
 - boards, Use of cabinets and, §44, p24.
- Parallel distribution of arc lamps, §34, p31.
 - Lamps in, §33, p2.
 - system of electric gas lighting. Burners for, §45, p44.
- Pendant burner, §45, p44.
- Permanent grounding of secondary system of wiring, §33, p31.
- Photometer, §32, p13.
 - bar, §32, p18.
 - Bunsen, §32, p16.
 - Conditions of, §32, p20.
 - Deshler-McAllister, §32, p18.
 - Elementary, §32, p15.
 - Law of, §32, p14.
- Photometry of the arc lamp, §34, p15.
- Pipe-thawing data, §57, pp10, 11.
- Pipes, Thawing frozen water, §57, p10.
- Planté cell, §27, p2.
- Plate, Positive, §27, p1.
- Plug and jack, Western Electric, §35, p37.
 - Edison, §43, p44.
- Polarity, Reversal of, in arc machines, §35, p23.

Polyphase systems, §33, p18.
 Porcelain tube, §43, p37.
 Portable conductors for marine work, §44, p67.
 Positive plate, §27, p1.
 Power consumption of arc lamps, §34, p24.
 consumption of heaters, §57, p29.
 consumption of incandescent lamps, §43, p43.
 consumption per candlepower, §34, p21.
 required for electric welding, §57, pp16, 17.
 Preparation of metallized filaments, §55, p2
 of osmium filaments, §55, p11.
 Primary and secondary resistance, Measurement of, §33, p56.
 Printing machinery, Heaters for, §57, p29.
 Prometheus heating units, §57, p26.
 Protection of secondary circuits, §33, p27.
 Protective devices, Thomson, §33, p29.
 Pure copper wire, Resistance of, §43, p49.
 Push button, §45, p22.

R

Radiator, Luminous, §57, p22.
 Rail welding, §57, p17.
 Ratchet burner, §45, p45.
 feed, §34, p62.
 Rating of accumulators, §27, p6.
 of cells, §27, p7.
 of fuses, §43, p47.
 Reactance-coil regulator, §33, p39.
 or choke, coil, §34, p34.
 Reflectors for Cooper Hewitt lamps, §55, p31.
 Regulation of series arc lamps by variable reactance, §35, p29.
 of transformers, §33, p61.
 Regulator, C R, §33, p38.
 for brush machines, §35, p20.
 Lamp-board, §33, p38.
 Reactance-coil, §33, p39.
 Regulators, Current, §33, p38.
 Relative costs of heating, §57, p9.
 Resistance of cells, §27, p13.
 of pure copper wire, §43, p49.
 Test of insulation, §44, p64.
 Return-call annunciator, Wiring for, §45, p32.
 Rheostat for booster field, Reversing, §27, p71.
 Rope for arc lamps, §35, p7.
 Trimmers', §35, p7.
 Rosette, §43, p38.
 Rubber-covered wire, §43, p34.
 Rules for arc lights on low-potential circuits, §45, p13.
 for automatic cut-outs, §43, p24.
 for flexible cord, §43, p40.
 for interior conduits, §44, p56.

Rules—(Continued)
 for snap switches, §43, p31.
 for sockets, §44, p18.
 for switches, cut-outs, circuit-breakers, etc., §43, p24.
 for wires for concealed knob-and-tube work, §44, p22.
 for wires, General, §43, p17.
 for wiring of high-potential systems, §45, p11.
 for wiring in damp places, §44, p17.
 for wooden moldings, §44, p60.
 relating to switches, §43, p29.
 relating to transformer installation, §45, p12.
 relating to wires, §43, p12.
 relating to wires for open work, §43, p33.
 Running bell wire, §45, p28.

S

Sash-cord rope, §35, p7.
 Screen, Methven, §32, p12.
 Searchlight lamp, §34, p62.
 Searchlights, §34, p61.
 Secondary battery, Nature of, §27, p1.
 circuits, Protection of, §33, p27.
 resistance, Measurement of primary and, §33, p56.
 Sediment in cells, §27, p42.
 Self-restoring annunciator, §45, p27.
 Series arc lamp, Shunt type of, §34, p41.
 arc lamps, §34, p38.
 arc lamps, Operation of, §35, p25.
 arc lamps, Regulation of, by variable reactance, §35, p29.
 circuits, Arrangement of, §34, p28.
 distribution of arc lamps, §34, p26.
 lamps, Alternating-current enclosed-arc, §34, p49.
 Lamps in, §33, p2.
 lighting system, Apparatus for, §45, p49.
 machines, Multicircuit, §34, p28.
 systems, §35, p1.
 Setting up cells, §27, p30.
 Seven-wire systems, §33, p14.
 Shunt booster, §27, p69.
 type of series arc lamp, §34 p41.
 Sign, Carriage-call, §56, p28.
 Combination, §56, p4.
 lamps with thermostats, §56, p11.
 Operation of talking, §56, p21.
 Talking-clock, §56, p27.
 Thermal flashers for, §56, p12.
 Turnip lamp for, §56, p12.
 Signs, Changeable, §56, p10.
 Changes in display of, §56, p19.
 Changes in intensity of light of, §56, p10.

Signs—(Continued)

- Double-faced, §56, p6.
- Double-filament lamps for, §56, p12.
- Double-pole flashers for, §56, p15.
- Elblight system of, §56, p19.
- Examples of large, §56, p8.
- Exposed-bulb, §56, p5.
- Fixed electric, §56, p1.
- Illuminated, §56, p2.
- Mechanical flashers for, §56, p15.
- Monogram letters for, §56, p21.
- Single-pole flasher for, §56, p17.
- Talking, §56, p21.
- Thermoblink for, §56, p10.
- Thermostats for, §56, p10.
- Time switches for, §56, p17.
- Transparent, §56, p2.
- Simple switchboard with cable, §35, p33.
 - two-wire system, §33, p6.
- Single-phase system, §33, p15.
 - pole flasher, §56, p17.
 - wire cleat, §43, p37.
- Size of wire for arc lights, §43, p52.
 - of wire for three-wire system, §43, p58.
- Sizes of wire according to current capacity, §43, p35.
- Slow-burning, weather-proof wire, §43, p34.
- Snap switches, §44, p41.
 - switches, Rules for, §43, p31.
- Sockets, Rules for, §44, p18.
- Soldering fluid for joints of wires, §43, p11.
- Span-wire suspension lamps, §35, p6.
- Speaking-tube system, Wiring for, §45, p35.
- Specifications for concealed electric-light wiring, §44, p36.
- Squirting process, §32, p5.
- Stage dimmers, §45, p4.
- Station, Effect of electric heating on central, §57, p8.
- Storage batteries, §27, p1.
 - batteries, General description of, §27, p1.
 - batteries in lighting stations, §33, p62.
 - battery boosters, §27, p68.
 - battery, Gould, §27, p18.
 - battery, Nature of, §27, p1.
 - battery regulating appliances, §27, p64.
 - battery, Willard, §27, p22.
 - cells, Efficiency of, §27, p11.
 - cells, General data on, §27, p83.
 - cells, General data on Gould, §27, p85.
 - cells, Installation and care of, §27, p30.
- Store lighting, §45, p1.
- Street-lighting devices, §33, p42.
 - lighting, Height of arc lamps for, §35, p4.
- Sulphating, §27, p44.
- Supporting cells, Method of, §27, p30.
 - tantalum filaments, Methods of, §55, p6.

Supporting—(Continued)

- wire, Fittings for, §43, p37.
- Switch, Consumer's, §27, p49.
 - Cutter, §27, p52.
 - Location of main, §44, p34.
 - Two-point, §45, p40.
- Switchboard, Carrier-bus, §35, p39.
 - General Electric, §35, p46.
 - with cable, Simple, §35, p33.
 - without cables, §35, p37.
- Switchboards, Arc-light, §35, p32.
 - Construction and operation of arc, §35, p33.
 - for alternating-current series systems, §35, p46.
 - Western Electric alternating-current arc, §35, p49.
- Switches, §44, p38.
 - and cut-outs, §43, p23.
 - Cut-out, §35, p8.
 - cut-outs, circuit-breakers, etc., Rules for §43, p24.
 - Electrolier, §44, p41.
 - End-cell, §27, p64.
 - Rules relating to, §43, p29.
 - Snap, §44, p41.
 - Time, §56, p17.
- Systems of distribution, §33, p1.

T

- Table of capacity of wires for marine work, §44, p67.
 - of carrying capacity of insulated wires, §43, p14.
 - of current allowance per lamp, §33, p51.
 - of current required by motors, §45, p18.
 - of data on enclosed-arc lamps, §34, p25.
 - of diameters of wires of various materials that will be fused by a current of given strength, §57, p4.
 - of dimensions of bare copper wire, B. & S. gauge, §43, p16.
 - of efficiency of transformers, §33, p50.
 - of equivalent cross-section of wires, §44, p15.
 - of general data on chloride accumulators, §27, p84.
 - of pipe-thawing data, §57, p11.
 - of power consumption of arc lamps, §34, p24.
 - of power consumption of incandescent lamps, §43, p43.
 - of power required for electric welding, §57, p16.
 - of resistance of pure copper wire, §43, p49.
 - of watts per square foot for interior arc lighting, §34, p26.

- Tables of heating effects of currents, §57, pp2, 3.
- Talking clock, §56, p27
signs, §56, p21.
signs, Operation of, §56, p21.
- Tantalum filaments, Characteristics of, §55, p7.
filaments, Methods of supporting, §55, p6.
lamps, §55, p6.
- Temperature coefficient of a lamp, Negative, §55, p3.
of a lamp, §32, p24.
of incandescent lamps, §55, p15.
- Test, Cadmium, §27, p43.
for transformers, Load, §33, p59.
Insulation, §33, p53.
of insulation resistance, §44, p64.
- Testing arc-light lines, §35, p10.
lamps, Connections for, §32, p25.
Transformer, §33, p52.
- Tests of arc lamps, Comparative, §55, p58.
of Tungsten lamps, §55, p13.
of wiring, §44, p62.
- Thawing data for pipes, §57, p10.
frozen water pipes, §57, p10.
transformers, §57, p12.
transformers, Connections of, §57, p12
- Theater wiring, §45, p4.
- Theory of flaming-arc lamps, §55, p48.
of Moore light, §55, p39.
- Thermal sign flashers, §56, p12.
- Thermoblink, §56, p10.
- Thermostats for sign lamps, §56, p11.
for signs, §56, p10.
- Thomson-Houston base, §32, p10.
-Houston lamp, §34, p45.
protective devices, §33, p29
welding process, §57, p13.
- Three-wire branch block, §43, p45.
-wire main block, §43, p45.
-wire system, §33, p8.
-wire system, Edison, §43, p20.
-wire system, Size of wire for, §43, p58.
-wire system, Unbalancing of, §43, p58.
-wire systems, Special, §33, p8.
- Time switches, §56, p17.
- Transfer board, §35, p45.
- Transformer, Constant-current, §33, p40.
Impedance volts of, §33, p59.
installation, Rules relating to, §45, p12.
Insulation test of, §33, p53.
Measurement of copper losses of, §33, p58.
Measurement of core losses of, §33, p55.
Measurement of impedance of, §33, p58.
testing, §33, p52.
Welding, §57, p15.
- Transformers, §45, p12.
- Transformers—(Continued)
Load test of, §33, p59.
Regulation of, §33, p61.
Thawing, §57, p12.
- Transparent signs, §56, p2.
- Tree system of wiring, §43, p32.
- Trimmer's rope, §35, p7.
- Trimming enclosed-arc lamps, §34, p67.
of arc lamps, §34, p64.
- Tube lighting, §55, p27.
Porcelain, §43, p37.
- Tubulation of bulb, §32, p8.
- Tungsten lamp tests, §55, p15.
lamps, §55, p13.
lamps, Operation of, §55, p13.
- Turnip sign lamps, §56, p12.
- Two-point switch, §45, p40.
- Two-wire and three-wire direct-current systems, §33, p44.
-wire double branch block, §43, p45.
-wire panel board, Form of §44, p29.
-wire system, §43, p19.
-wire system, Simple, §33, p6.
- U
- Unbalancing of three-wire systems, §43, p58.
- Underground conductors, §43, p13.
- Underwriters' test for wiring, §44, p63.
- Uniform drop in feeder lines, §44, p1.
- Unit, Amyl-acetate, §32, p13.
British thermal, §32, p33.
Hefner, §32, p13.
- V
- Vacuum regulator for Moore lamp, §55, p41.
- Voltage and current of lamp, §34, p9.
at end of charge, §27, p38.
of incandescent lamp, §32, p32.
of the arc, §34, p4.
regulation, §33, p12.
required by enclosed-arc series lamps, §34, p48.
- W
- Water heating, §57, p23.
- Waterproof globe, §44, p18.
- Watt-hour efficiency, §27, p12.
- Watts per square foot for interior arc lighting, §34, p26.
- Weather-proof wire, Slow-burning, §43, p34.
- Welding, §55, p13.
Advantages of electric, §57, p17.
Hoho process of, §57, p19.
of rails, §57, p17.
Power required for electric, §57, pp16, 17.
process, Thomson, §57 p13.
transformer, §57, p15.

- Western Electric closed-coil machines, §35, p22.
 Electric constant-potential lamp, §34, pp55, 57.
 Electric lamp, §34, p52.
 Electric plug and jack, §35, p37.
- Westinghouse, or Sawyer-Man, base, §32, p11.
- Willard automobile battery, §27, p24.
 storage battery, §27, p22.
- Wire, Carrying capacity of galvanized-iron, §57, p6.
 Carrying capacity of German-silver, §57, p5.
 Carrying capacity of tinned-iron, §57, p7.
- Wire, Determining sizes of, according to current capacity, §43, p45.
 for a given loss, Calculating proper size of, §43, p53.
 for arc lights, Size of, §43, p52.
 for lighting work, Size of, §35, p1.
 for three-wire system, Size of, §43, p58.
 Formulas for resistance of §44, p6.
 gauges, §43, p15.
 required, Calculating sizes of, §44, p1.
 Resistance of pure copper, §43, p49.
 Rubber-covered, §43, p34.
 Running bell, §45, p28.
 sizes in terms of resistance per 1,000 feet, §44, p3.
 Slow-burning weather-proof, §43, p34.
 used in conduits, §44, p56.
- Wires, Carrying capacities of, §43, p13.
 Carrying capacity of insulated, §43, p14.
 Diameters of, that will be fused by a current of given strength, §57, p4.
 Equivalent cross-section of, §44, p15.
 for alternating current, §44, p8.
 for concealed knob-and-tube work, §44, p22.
 for conduit in marine work, §44, p66.
 for high-potential systems, §45, p11.
 for marine work, Capacity of, §44, p67.
 for molding in marine work, §44, p66.
 for molding work, §44, p61.
 for open work, Rules relating to, §43, p33.
 General rules for, §43, p17.
 Graphic method of calculation of, §44, p10.
 in marine work, Rules for, §44, p65.
 in parallel, Calculations of, §44, p16.
 in terms of circular mils, §44, p5.
 Joints of, §43, p11.
- Wires—(Continued)
 Leading-in, §32, p7.
 Rules for §44, p17.
 Rules relating to, §43, p12.
 Soldering fluid for joints of, §43, p11.
- Wiring a dwelling house, §44, p29.
 Bell, §45, p20.
 Bell, for flats, §45, p36.
 Concealed, §44, p19.
 Conduit, §44, p48.
 Drop in arc-light, §43, p51.
 estimates, §44, p69.
 Fires caused by electric, §43, p2.
 Fittings used for exposed, §43, p36.
 for a uniform drop, §43, p47.
 for arc lamps, §45, p13.
 for constant-current arc lamps, §45 p14.
 for constant-potential arc lamps, §45, p13.
 for electric motors, §45, p17.
 for elevator annunciator, §45, p38.
 for fire-alarm gongs, §45, p36.
 for incandescent lamps on series circuit, §45, p16.
 for low-potential systems, §43, p16.
 for return-call annunciator, §45, p32
 for simple annunciator, §45, p31.
 for speaking-tube system, §45, p35.
 for special purposes, §45, p5.
 for 110 volts, 2-per-cent. drop, §43, p53.
 for 220 volts, 3-per-cent. drop, §43, p54.
 General rules for, §43, p10.
 in damp places, §44, p17.
 in marine work, §44, p65.
 Interior, §43, p1; §44, p1; §45 p1.
 Selection of fittings for 220-volt, §43, p57.
 Simple example of, §43, p32.
 Special appliances for, §45, p38.
 Specifications for concealed electric-light, §44, p36.
 systems, Combining several, §45, p1.
 Systems of distribution for interior, §43, p19.
 table giving distances for drop of 1 volt, §44, p4.
 tables, §44, p8.
 Tests of, §44, p62.
 Theater, §45, p4.
 Tree system of, §43, p32.
 Wolfram lamps, §55, p13.
 Wood arc dynamo, §35, p22.
 Wooden moldings, §44, p60.

168 08/08 63
7002



89068786110



B89068786110A

89071917314



B89071917314A

DEMCO

K.F. WENDT LIBRARY
UW COLLEGE OF ENGINEERING
215 N. RANDALL AVENUE
MADISON, WI 53706

89071917314



b89071917314a